

Electric subsea library verification Visjonsdokument

Versjon 1.1

Prosjekt gruppe:

Raymond Holthe, Marius Bakka, Aleksandr Svetlanov

Revisjonshistorie

Dato	Ver sjon	Endring	Forfatter
20/12.13	1.0	Original utkast	Raymond Holthe, Marius Bakka, Aleksandr Svetlanov
03/01.14	1.1	Lagt til innholdsfortegnelse i dokument.	Marius Bakka

Innholdsfortegnelse

Kapitel	Side nr.
1. Innledning	1
2. Sammendrag problem og produkt	1
2.1 Problemsammendrag	1
2.2 Produktsammendrag	1
3. Overordnet beskrivelse av interessenter og brukere	2
3.1 Oppsummering interessenter og brukere	2
3.2 Sammendrag av brukernes behov	2
4. Produktets funksjonelle egenskaper	3
5. Ikke-funksjonelle egenskaper og andre krav	3

1. Innledning

Vi skal lage et verifikasjonsdokument som bekrefter funksjonaliteten til et elektrisk simulasjonsbibliotek for simuleringsprogrammet Simulation X. Dette dokumentet skal kunne presenteres for kunder av Agito AS som et bevis av nøyaktigheten til beregningene som utføres av biblioteket. Ved siden av dette verifikasjonsdokumentet, skal det også føres en verifikasjonsrapport som skal være mer utdypende. Denne skal dokumentere alle formeler og utregninger som ble brukt i verifikasjonsprosessen.

2. Sammendrag problem og produkt

2.1 Problemsammendrag

Problemstilling	Et produkt som skal brukes til å simulere påvirkningen av forskjellige arbeidsmiljøer for elektriske komponenter, må verifiseres for å sikre at beregningene som gjøres er tilfredsstillende nøyaktige.
Berører	Agito AS og deres kunder.
Problem	Et uverifisert produkt kan ha ukjente feil og mangler, noe som kan føre til økonomiske tap både for selger og bruker av produktet.
En vellykket verifikasjon vil	En verifisering vil sikre mot at produktet selges og brukes med ukjente feil, og kan derfor sikre mot uforutsette problemer som følge av bruk av biblioteket.

2.2 Produktsammendrag

For	Agito AS.
Som	Har behov for en verifikasjon av deres simuleringsbibliotek.
Produktet navngitt er	SimulationX Electrical Subsea Library verification.
som	Vil fungere som et bevis for funksjonaliteten og nøyaktigheten til simuleringsbiblioteket.

3. Overordnet beskrivelse av interessenter og brukere

3.1 Oppsummering interessenter og brukere

Navn	Utdypende beskrivelse	Rolle under utviklingen
Prosjekt gruppa	Gruppa representeres av gruppeleder Raymond Holthe og gruppe medlemmer Marius Bakka og Aleksandr Svetlanov. Vi ønsker å lage et produkt som med høy nøyaktighet sammenligner simuleringsverdier med verdier beregnet med manuelle utregninger.	Står for beregninger, analyser og verifikasjonsdokument.
Intern Veileder	Intern veileder fra Hibu er Sigmund Gudvangen.	Gir råd for korrekt utførelse av dokumentasjon og prosjektering.
Agito AS	Agito AS representeres i dette prosjektet av Thomas Langer, de ønsker dette produktet for å verifisere funksjonaliteten av et eksisterende produkt de skal bruke for, og selge til kunder.	De kan gi viktig informasjon om simulasjons programmet og biblioteket vi skal verifiisere.

3.2 Sammendrag av brukernes behov

Behov	Prioritet	Påvirker	Dagens løsning	Foreslått løsning
Funksjonelt verifisering (Oppdragsgiver ønsker en tredjeparts verifisering av deres produkt).	Fullstendig dokumentering av simuleringsverdier mot beregnet verdi.	Simulering-bibliotekets garanti for korrekt funksjonalitet.	Ingen verifisering.	Matematisk verifisering for simuleringsverdier.

4. Produktets funksjonelle egenskaper

1. Beregne korrekte verdier for alle enheter og parametere.
2. Sammenligning av simulert og beregnet verdi.
3. Analysering av eventuelle avvik.
4. Verifiseringdokumentet skal føres på engelsk.

5. Ikke-funksjonelle egenskaper og andre krav

- Alle beregninger skal bruke akademisk aksepterte normer for matematisk beregning av de elektroniske komponentene.
- Alle beregninger skal dobbelt verifiseres ved at to personer uavhengig utfører beregningene.
- Alle avvik mellom simulert og beregnet verdi skal utdypende forklares.

Electric subsea library verification Forstudierapport

Versjon 1.1

Prosjekt gruppe:

Raymond Holthe, Marius Bakka, Aleksandr Svetlanov

Revisjonshistorie

Dato	Versjon	Endring	Forfatter
22/11.13	1.0	Original utkast	Marius Bakka, Raymond Holthe, Aleksandr Svetlanov
03/01.14	1.1	Lagt til innholdsfortegnelse og introduksjon i dokumentet.	Marius Bakka

Innholdsfortegnelse

Kapitel	Side nr.
1. Introduksjon	1
2. Bakgrunn for prosjektet	2
2.1 SimulationX og Electrical SubSea library	2
2.2 Beskrivelse av problemer og behov	2
3. Prosjektmål	3
3.1 Effektmål	3
3.2 Resultatmål	3
3.3 Prosessmål	3
4. Interessenter og rammebetingelser	4
4.1 Interessentanalyse	4
4.2 Rammebetingelser	4
5. Kritiske suksessfaktorer	4
5.1 Suksessfaktorer	4
5.2 Informasjonsbehov	4
6. Risikoanalyse	5
7. Retningslinjer og standarder	6
7.1 Krav til dokumentasjon	6
7.2 Krav til kvalitetsgjennomganger	6
7.3 Krav til standarder og metoder	6
7.4 Endringshåndtering	6
8. Prosjektorganisering	7
9 Anbefaling om videre arbeid	7

1. Introduksjon

I dette dokumentet vil du finne en kort forklaring på oppgaven vår gruppe har blitt gitt av Agito AS, og hvordan vi planlegger å løse denne. Vi har beskrevet systemet vi skal verifisere og behovene denne verifikasjonen må tilfredsstill, og satt opp mål for prosjektet.

Videre har vi klargjort interessenter for det endelige resultatet og de kritiske suksessfaktorer for prosjektet, risikoanalyse og retningslinjer for videre utføring av prosjektet.

2. Bakgrunn for prosjektet

Oppdragsgiver har laget et elektrisk subsea bibliotek for simulerings softwaren SimulationX. Dette biblioteket skal selges videre til kunder og også brukes selv av oppdragsgiver for å gjøre simuleringer. De har nå et ønske om å få gjort en tredjeparts verifisering av biblioteket.

2.1 SimulationX og Electrical SubSea library

SimulationX er en simuleringssoftware som brukes til å evaluere hvordan tekniske systemer fungerer. Dette gjøres ved å modellere, simulere og analysere fysiske effekter innenfor biblioteker som 1D-mekanisk, 3D multibody, kraftoverføring, hydraulisk, pneumatisk, termodynamisk, elektrisk, magnetisk og kontroll systemer.

Electrical SubSea library er et nytt library utviklet av Agito som inneholder elementer som vanligvis brukes i elektriske subsea systemer. Dette er utviklet med tanke på at det skal være lettere for brukeren av SimulationX å modellere, simulere og analysere subsea systemer.

2.2 Beskrivelse av problemer og behov

For å få et kvalitetssikret produkt som brukes i simuleringer må dette produktet tredjeparts verifiseres.

Dette innebærer grundig testing av hvert eneste element i biblioteket og skrive en rapport for resultatene.

3. Prosjektmål

I prosjektet skal følgende utføres:

- Utføre simulasjoner av elektroniske elementer under forskjellige forhold.
- Registrere og analysere resultatene
- Presentere resultater, vurdering av nøyaktighet i en hovedrapport og presentasjon

3.1 Effektmål

Oppdragsgiver ønsker en tredjeparts verifisering av deres produkt, for å få et bevis av funksjonalitet som kan presenteres for kunder under salg. Ved en velykket verifikasjon vil derfor dokumentets effekt kunne være lettere salg av produktet.

3.2 Resultatmål

Prosjektets mål er å simulere elektriske komponenter som vi vil teste, kontrollere og vurdere opp mot manuelle beregninger og lage rapporten som dokumenterer nøyaktigheten av resultatene og konkluderer grunnen til eventuelle avvik.

3.3 Prosessmål

Gjennom prosjektet erverver man gode erfaringer innen prosjektledelse, godt samarbeid vår gruppe med veiledere, effektive løsninger og metoder for videre utvikling av prosjektet. Og få erfaring rundt arbeidsmetoder og få kontakt med arbeidsmarkedet.

4. Interessenter og rammebetingelser

4.1 Interessentanalyse

Verifiseringen skjer på vegne av Agito AS, denne verifiseringen kan gi dem en bekreftelse på at alt er korrekt, og vil også kunne gi kunder en mulighet til å kontrollere at biblioteket gjør en tilfredsstillende jobb. Ettersom vi kun verifiserer biblioteket er ikke resultatene i seg selv et suksesskriterium for denne oppgaven, men at nok målinger er tatt fra forskjellige omgivelser og situasjoner til at man kan være sikker på at resultatene gir korrekt bilde av forholdet mellom beregnet og simulert verdi. Og at eventuelle avvik kan forklares.

Interessent	Suksesskriterier	Bidrag til prosjekt
Intern <ul style="list-style-type: none">• Prosjekt gruppa• Veileder	Vellykket prosjekt vellykket prosjekt	Ansvar og arbeid Kunnskap om prosjektering
Ekstern (kunde) <ul style="list-style-type: none">• Oppdragsgiver• Sluttforbruker	Et fullstendig kvalitets bevis å vise ovenfor kunden En verifikasjon som kan vise bibliotekets evner til å gi et korrekt resultat	Kunnskap om biblioteket og simulasjonen. Virkelige data fra anlegg.

4.2 Rammebetingelser

Verifiseringen må ta hensyn til forskjellige miljøer og ta de nødvendige målingene for å få en fullverdig oversikt over utviklingen av avviket over alle verdier. Prosjektet har en endelig tidsfrist og må være ferdig til innen utgangen av Mai.

5. Kritiske suksessfaktorer

5.1 Suksessfaktorer

For dette prosjektet må vi som gruppe klare å lage de matematiske beregningene nødvendig for å verifisere de simulerte verdiene i de simulerte forholdene, vi må også klare å analysere verdiene så vi kan avklare grunnen bak eventuelle avvik som skulle oppstå.

5.2 Informasjonsbehov

Informasjon om prosjektets fremgang og situasjon skal gis til en representant av Agito AS og til veileder og sensor i form av innlevering og 3 presentasjoner. Første presentasjon er planlagt til januar, og den andre ved mars – april. Den siste presentasjonen vil ta sted en gang i Juni. Det vil leveres inn skriftlig dokumentasjon til de nevnte personene et par arbeidsdager før disse presentasjonene.

6. Risikoanalyse

	Problemer som kan oppstå	Konsekvens	Sannsynlighet (1-10)	Alvorlighetsgrad (1-10)	Forebyggende tiltak
1	Mangelfull kunnskap i gruppen til å utføre kalkulasjoner	Enkelte simulasjoner kan ikke verifiseres	2	9	Være i kontakt med personer med kunnskap innen relevante felt
2	Mangelfull kunnskap i gruppen til å analysere avvik og forklare avvikes opprinnelse	Kan ikke avklare alvorlighet av avvik	4	9	Være i kontakt med personer med kunnskap innen relevante felt
3	Frafall eller langtidssykdom innad i gruppen	Økt arbeidsbyrde truer tidsfrist	2	6	Margin på tidsfrister, konstant dialog innad i gruppen og sørge for å fokusere på de nødvendige oppgavene.
4	Forsinkelser fra uforutsette problemer og hindringer ved enkelte oppgaver	Forsinkelser kan true tidsfrist	9	2	Margin på tidsfrister og planlegge så man har muligheten til å øke time antallet om nødvendig
5	*Ingen mulighet til testing i felt eller med verdier fra felt opp mot simulering og beregninger	Ingen verifikasjon mot virkeligheten	4	3	Holde dialog med relevante firmaer og sende forespørsler og nødvendig målingdata.

* Lav konsekvens grunnet ikke nødvendighet for prosjektet

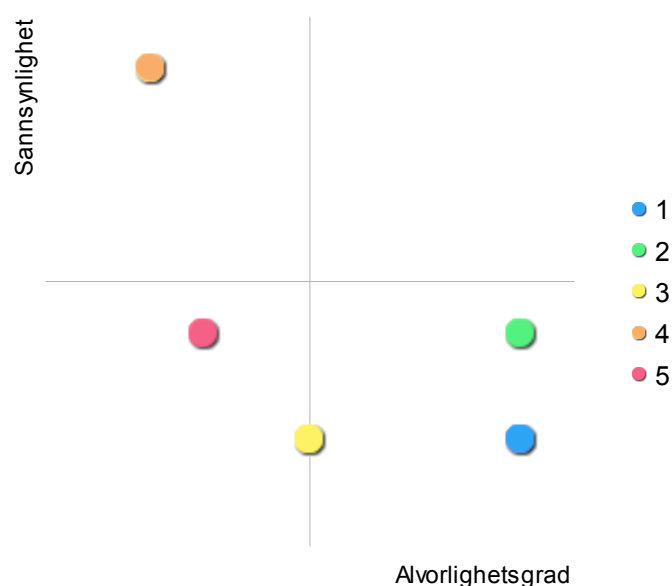

Vi mener at med de tiltakene som settes i bruk for å forebygge problemene risikoanalysen avdekker, skal det være veldig lav sannsynlighet for at noen problemer som kan sette prosjektet i fare skal dukke opp under prosjektets gang.

7. Retningslinjer og standarder

7.1 Krav til dokumentasjon

Hoveddokumentet som skal lages under dette prosjektet er en fullstendig rapport som inneholder alt av beregninger og resultater. Det skal også lages et litt mindre dokument som er ment som et sammendrag av hovedrapporten og som kan brukes til å sende videre til kunder.

7.2 Krav til kvalitetsgjennomganger

Ved betydelige avvik mellom simulasjon og beregninger vil resultatene gjennomgå en ekstra kontroll for å verifisere at håndberegningene er rette. Alle beregninger vil gjøres av 2 personer, hver for seg for å sikre korrekt resultat.

7.3 Krav til standarder og metoder

For å få gjort tredjeparts verifiseringen så må alle simuleringer gjøres med SimulationX 3.6 og det eksterne biblioteket «SubSea Electrical». Ved avanserte beregninger brukes mathlabs. Alle dokumentene skal følge maler laget av gruppa selv.

7.4 Endringshåndtering

Ved endringer på dokumentene skal det lages et kapittel i dokumentet hvor endringene er beskrevet. Gamle versjoner av dokumentet skal arkiveres.

8. Prosjektorganisering

- Prosjektgruppe
- Internveileder:
Sigmund Gudvangen, Førsteamanuensis
- Internsensor:
Karoline Moholth, Høgskolelektor
- Eksternveileder og sensor:
Thomas Langer, Agito
- arbeidsgiver:
Agito

Kommunikasjon med veiledere vil i utgangspunktet skje via møte. Vi vil også ha jevnlig kontakt med oppdragsgiver for å underrette om progresjonen i prosjektet og bruke egen erfaring og egne kunnskaper for å framføre hovedprosjektet.

9 Anbefaling om videre arbeid

Vi anbefaler å gjøre hovedprosjektarbeid på den måten som vi har nå i planene våre som er lagt frem i forstudierapporten og bruke den erfaring og kunnskap gruppen får i løpet av arbeid med hovedprosjektet gir oss mulighet og tanker om videre arbeid med dette temaet.

Electric subsea library verification

Krav- og test-spesifikasjon

versjon 1.0

Prosjekt gruppe:

Raymond Holthe, Marius Bakka, Aleksandr Svetlanov

Revisjonshistorie

Dato	Versjon	Endring	Forfatter
09/01-04	1.0	Original utkast	Marius Bakka Raymond Holte Aleksandr Svetlanov

1. Krav

Det er lagt opp til at A – kravene i dette dokumentet er absolutte krav, disse må være i orden for at prosjektet skal klassifiseres som ferdig. B – kravene er av mindre viktighet, og vil utføres mot slutten av prosjektet om tiden tillater det.

1.1 A – Krav:

1.1.A1 Dokumentkrav.

Krav	Beskrivelse	Godkjenningkriterium
A1.1	Språk	Verifikasjonsdokumentene skal føres i engelsk.
A1.2	Dokumentasjon	Verifiseringsrapporten skal inneholde alle formeler, utregninger, analyser og konklusjoner i sin helhet.
A1.3	Klassifisering	Verifiseringsdokumentet skal kun inneholde resultater, sammenligninger og konklusjoner.
A1.4	Leselighet	Verifiseringsdokumentet skal være oversiktlig og tydelig, det skal raskt og enkelt kunne demonstrere systemets nøyaktighet ovenfor leser.

1.1.A2 Utrekningskrav

Krav	Beskrivelse	Godkjenningkriterium
A2.1	Kontroll punkter lineær	Kontroll av simuleringer med lineært utfall, skal kontrolleres med minst 2 punkter
A2.2	Kontroll punkter ulineær	Kontroll av simuleringer med ulineært utfall, skal kontrolleres med minst 3 punkter.
A2.3	Utregning	Utregningene skal følge godkjente matematiske formeler og ikke inneholde noen feil.
A2.4	Avvik	Alle avvik mellom utregninger og simuleringer skal analyseres og begrunnes.

1.2 B – krav:

1.2.B1 Ekstra data

Krav	Beskrivelse	Godkjenningkriterium
B1.1	Testing mot reel data	Et utvalg av resultatene skal testes mot reel data
B1.2	Ekstrem punkter	Et utvalg av simulasjonene skal testes med ekstrem verdier utenfor normal område

2. Tester

2.1 A – Krav tester:

Test	Beskrivelse	Godkjenningkriterium
TA1.4	Visuell inspeksjon	Dokumentet skal gi rask oversikt over resultater og nøyaktighet.
TA2.3	Testing av resultat	Samtlige utregninger skal utføres av 2 personer, resultatene skal sammenlignes uten avvik.

2.2 B – Krav tester:

Test	Beskrivelse	Godkjenningkriterium
TB1.1	Sammenligne beregnet verdi med reel data	Små avvik som følger av nøyaktighetsbegrensninger og desimal opprunning godkjennes.

Electric subsea library verification Prosjektplan

Versjon 1.0

Prosjekt gruppe:

Raymond Holthe, Marius Bakka, Aleksandr Svetlanov

Revisjonshistorie

Dato	Ver sjo n	Endring	Forfatter
26/11-13	1.0	Original utkast	Marius Bakka, Raymond Holthe, Aleksandr Svetlanov
17/12-13	1.1	Lagt til Gantt diagram	Marius Bakka
22/12.13	1.2	Oppdaterte plan, og førte mer detaljert beskrivelse for del 2 av prosjektet.	Marius Bakka

Innholdsfortegnelse

Kapitel	Side nr.
1. Prosjektmodell	1
2.0 Prosjektfordeling	2
2.1 Planlegging(steg 1)	2
2.2 Beregninger og analyse (steg 2)	3
2.3 Dokumentering (steg 3)	4
3.0 Gantt diagram	5

1. Prosjektmodell

Vi planlegger å utføre prosjektet med en Inkremental-prosjektmodell, som vist i figur 1, dette medfører at vi vil steg for steg jobbe gjennom hver enkelt deloppgave i prosjektet inntill vi har det fullstendinge produktet.

Dette er metoden vi som gruppa har blitt enig om er den best egnet metoden for et prosjekt, hvor selve oppgaven er å danne et dokument. I denne settingen et verifikasjonsdokument.

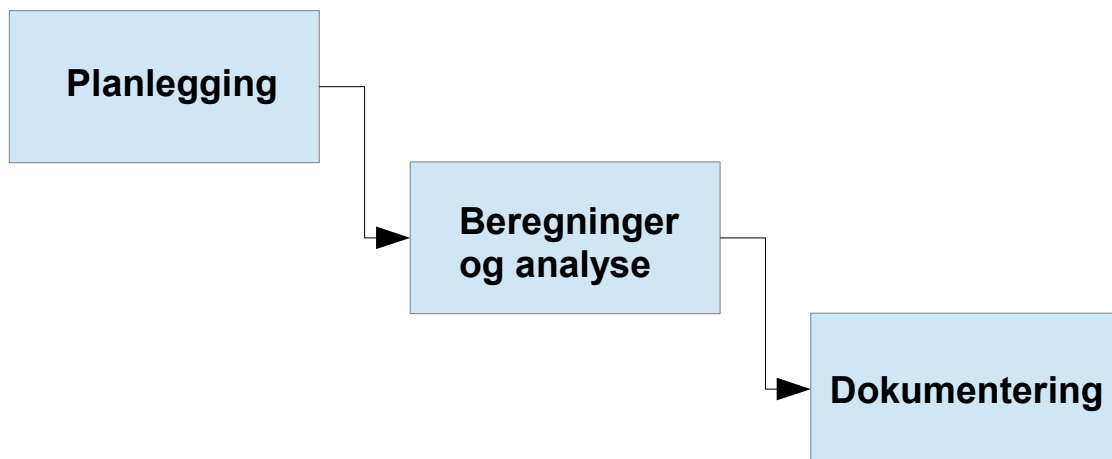

Figur 1

2.0 Prosjektfordeling

Som vist i den Inkrementale-modellen har vi delt av prosjektet i 3 deler, dette vil også representeres slik over de 3 fremføringene som vil utføres utover.

2.1 Planlegging (Steg 1)

Dette er steget hvor vi danner prosjektplan, visjonsdokument, krav- og test-spesifikasjon og forstudierapport. Vi har estimert tidsbruken av denne delen til 15% av prosjektet. Tidsfordelingen i denne segmenten vises i tabell 1.

Tidsplan for planlegging

	tid	Raymond Holthe	Marius Bakka	Aleksandr Svetlanov
Total tid	292,5 t	87,5 t	91,8 t	88,4 t
Møter	43,9 t	14,6 t	14,6 t	14,6 t
Klargjøring av maler	14,6 t	2,6 t	6,0 t	6,0 t
Visjons dokument	29,3 t	9,8 t	9,8 t	9,8 t
Prosjekt Plan	29,3 t	7,3 t	13,0 t	9,0 t
Visjons dokument	29,3 t	8,0 t	9,3 t	12,0 t
Krav spesifikasjon	29,3 t	9,8 t	3,3 t	1,1 t
Test spesifikasjon	14,6 t	4,9 t	4,9 t	4,9 t
Innføring i SimulationX	43,9 t	14,6 t	14,6 t	14,6 t
Nettside	29,3 t	16,0 t	6,7 t	6,7 t
Forbereding til presentasjon	29,3 t	9,8 t	9,8 t	9,8 t

Tabell 1

2.2 Beregninger og analyse (Steg 2)

For dette steget har vi satt av 45% av den totale tiden til prosjektet. Det skal da kjøres gjennom alle simulasjoner med forskjellige verdier og kontrolleres mot flere punkter i målingene. Fordelingen vises her i tabell 2.

	Tid	Raymond Holthe	Marius Bakka	Aleksandr Svetlanov
Total tid	877,5 t	292,5 t	292,5 t	292,5
Power unit PWR calc	58,5 t	19,5 t	19,5 t	19,5 t
Simuleringer	11,7 t	3,9 t	3,9 t	3,9 t
Beregninger	23,4 t	7,8 t	7,8 t	7,8 t
Analysering	23,4 t	7,8 t	7,8 t	7,8 t
Power unit Sig. Calc	58,5 t	19,5 t	19,5 t	19,5 t
Simuleringer	11,7 t	3,9 t	3,9 t	3,9 t
Beregninger	23,4 t	7,8 t	7,8 t	7,8 t
Analysering	23,4 t	7,8 t	7,8 t	7,8 t
Transformer PWR Calc	58,5 t	19,5 t	19,5 t	19,5 t
Simuleringer	11,7 t	3,9 t	3,9 t	3,9 t
Beregninger	23,4 t	7,8 t	7,8 t	7,8 t
Analysering	23,4 t	7,8 t	7,8 t	7,8 t
Transformer Sig. Calc	58,5 t	19,5 t	19,5 t	19,5 t
Simuleringer	23,4 t	7,8 t	7,8 t	7,8 t
Beregninger	23,4 t	7,8 t	7,8 t	7,8 t
Analysering	23,4 t	7,8 t	7,8 t	7,8 t
Modem PWR calc	58,5 t	19,5 t	19,5 t	19,5 t
Simuleringer	11,7 t	3,9 t	3,9 t	3,9 t
Beregninger	23,4 t	7,8 t	7,8 t	7,8 t
Analysering	23,4 t	7,8 t	7,8 t	7,8 t
Modem Sig. Calc	58,5 t	19,5 t	19,5 t	19,5 t
Simuleringer	11,7 t	3,9 t	3,9 t	3,9 t
Beregninger	23,4 t	7,8 t	7,8 t	7,8 t
Analysering	23,4 t	7,8 t	7,8 t	7,8 t
Filter PWR calc	58,5 t	19,5 t	19,5 t	19,5 t
Simuleringer	11,7 t	3,9 t	3,9 t	3,9 t
Beregninger	23,4 t	7,8 t	7,8 t	7,8 t
Analysering	23,4 t	7,8 t	7,8 t	7,8 t
Filter Sig. Calc	58,5 t	19,5 t	19,5 t	19,5 t
Simuleringer	11,7 t	3,9 t	3,9 t	3,9 t
Beregninger	23,4 t	7,8 t	7,8 t	7,8 t
Analysering	23,4 t	7,8 t	7,8 t	7,8 t
Termination/junction PWR calc	58,5 t	19,5 t	19,5 t	19,5 t
Simuleringer	11,7 t	3,9 t	3,9 t	3,9 t
Beregninger	23,4 t	7,8 t	7,8 t	7,8 t
Analysering	23,4 t	7,8 t	7,8 t	7,8 t
Termination/junction Sig. Calc	58,5 t	19,5 t	19,5 t	19,5 t
Simuleringer	11,7 t	3,9 t	3,9 t	3,9 t
Beregninger	23,4 t	7,8 t	7,8 t	7,8 t
Analysering	23,4 t	7,8 t	7,8 t	7,8 t
Umbilical/junction PWR calc	58,5 t	19,5 t	19,5 t	19,5 t
Simuleringer	11,7 t	3,9 t	3,9 t	3,9 t
Beregninger	23,4 t	7,8 t	7,8 t	7,8 t
Analysering	23,4 t	7,8 t	7,8 t	7,8 t
Umbilical/junction Sig. calc	58,5 t	19,5 t	19,5 t	19,5 t
Simuleringer	11,7 t	3,9 t	3,9 t	3,9 t
Beregninger	23,4 t	7,8 t	7,8 t	7,8 t
Analysering	23,4 t	7,8 t	7,8 t	7,8 t
SCM/MPFM PWR calc	117,0 t	39,0 t	39,0 t	39,0 t
Simuleringer	23,4 t	7,8 t	7,8 t	7,8 t
Beregninger	46,8 t	15,6 t	15,6 t	15,6 t
Analysering	46,8 t	15,6 t	15,6 t	15,6 t
SCM/MPFM Sig. Calc	117,0 t	39,0 t	39,0 t	39,0 t
Simuleringer	23,4 t	7,8 t	7,8 t	7,8 t
Beregninger	46,8 t	15,6 t	15,6 t	15,6 t
Analysering	46,8 t	15,6 t	15,6 t	15,6 t
RSM calc PWR calc	58,5 t	19,5 t	19,5 t	19,5 t
Simuleringer	11,7 t	3,9 t	3,9 t	3,9 t
Beregninger	23,4 t	7,8 t	7,8 t	7,8 t
	23,4 t	7,8 t	7,8 t	7,8 t

Tabell 2

Hver enkel enhet som skal beregnes på vil også utføres etter en Inkremental-modell.

Som følger av krav A2.3 og som en del av test TA2.3 vil alle utregninger føres av 2 medlemmer av gruppa som arbeider uavhengi av hverandre. Ved like resultater blir resultatene og avvikene regnet som godkjent og man kan starte å analysere eventuelle avvik.

Ettersom det er 3 medlemmer vil dette føre til at person 3 jobber alene, det vil veksle hvem som jobber alene og da vil ikke resultatene være «godkjent» før person 1 eller 2 har testet person 3 sine resultater.

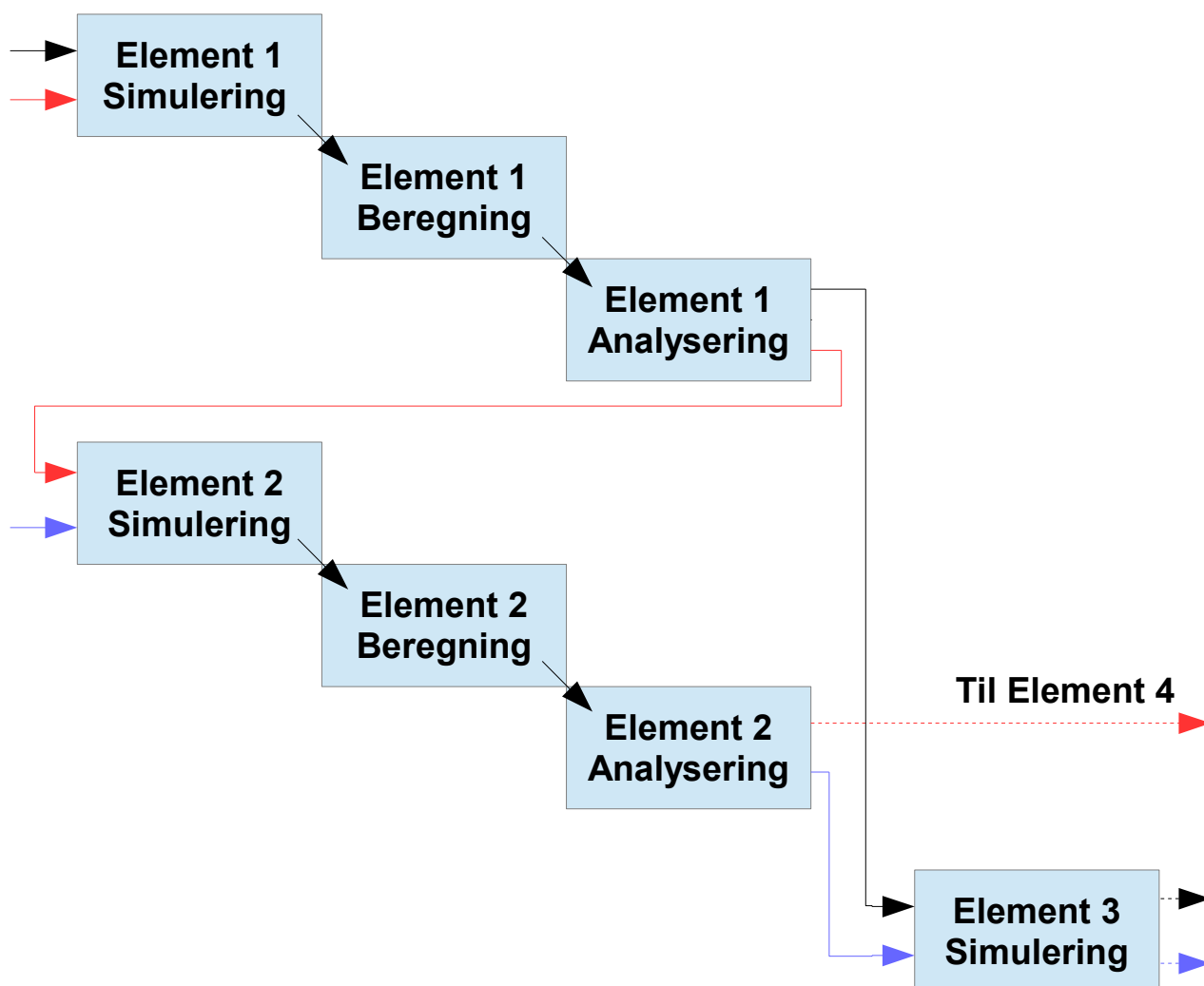

Figur 2

2.3 Dokumentering (Steg 3)

I det tredje og siste steget lager vi de 2 endelig dokumentene; verifikasjons dokumentet og verifikasjons rapporten. Vi har satt av 40% av prosjektets tid på dette og det vil også innebære ekstra med tid for den endelige og siste presentasjonen. Tidsfordelingen vises i tabell 3.

	tid	Raymond Holthe	Marius Bakka	Aleksandr Svetlanov
Total tid	780 t	260,0 t	260,0 t	260,0 t
Møter	39 t	13,0 t	13,0 t	13,0 t
Skriving av verifikasjons dok.	312 t	104,0 t	104,0 t	104,0 t
Ferdigstilling av rapport	273 t	91,0 t	91,0 t	91,0 t
Forberedelse til siste fremføring	156 t	52,0 t	52,0 t	52,0 t

Tabell 3

Vi kommer først til å skrive den fullstendige verifikasjons rapporten, før vi ut ifra den tilpasser en mindre detaljert versjon som vil være verifikasjonsdokumentet. I skrivingen av dokumentet vil vi samarbeide ved å bli enig om et format og en standard og følge, så vil vi vær for oss være ansvarlige for forskjellige elementer. Vi vil etter hvert andre element jobbe sammen og tilpasse dokumentet så det ender som et komplett sammenhengene dokument.

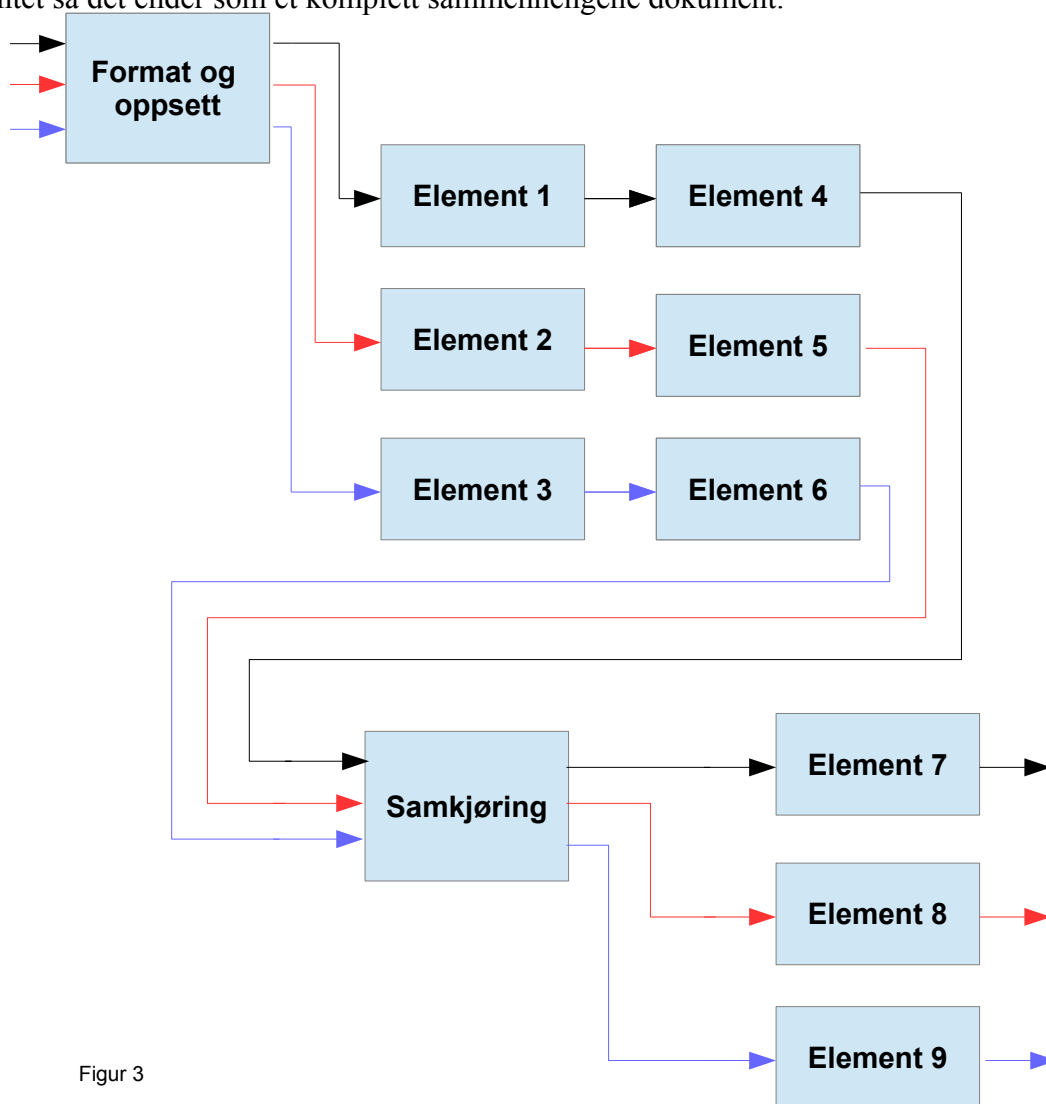

Figur 3

3.0 Gantt diagram

Vi har dannet et gantt diagram for å vise planlagt fremgang ved prosjektet. Diagrammet er her delt i 3 deler. Figur 4 er for Planleggingingen, Figur 5 for Beregning og analyse delen av prosjektet og figur 6 er for dokumentasjons delen.

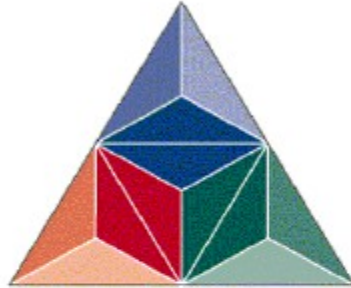

HØGSKOLEN
i Buskerud

Avdeling for Teknologi

Prosjektrapport

Subsea Electrical Simulation Library

Innholdsfortegnelse

Side:

1. Innledning	1
1.1. SimulationX og Subsea Electrical Simulation Library	1
1.2. Agito AS	1
1.3. Prosjekt Gruppen	1
1.4. Verifikasjonsprosessen	2
2. Prosjekt Gjennomføring	2
2.1. Prosjektkrav	2
2.2. Produkt	2
3. utfordringer	3
3.1. SimulationX	3
3.2. Matematiske Beregninger	3
4. Konklusjon	3

1. Innledning

Dette prosjektet har til hensikt å kontrollere og verifisere funksjonalitet og nøyaktighet av et matematisk simulasjonsbibliotek laget for SimulationX. Et slikt verifikasjons dokument er kritisk for å kunne garantere for resultatene som gis under en simulasjon, og av den grunn også et viktig salgsargument for salg av tjenester vedrørende simuleringen, eller direkte salg av biblioteket.

1.1 SimulationX og Subsea Electrical Simulation Library.

SimulationX er et programvare utviklet av ITI, og er et simuleringssoftware som kan brukes til og simulere og beregne alt fra Elektronikk, akustikk, thermodynamikk, hydraulikk og i stor grad alt som kan matematisk beregnes. Programmet baserer seg på «åpne» teknologier, slik som Modelica og FMI, og tillater mellomaktører og produsere egne bibliotek som kan integreres inn i systemet og så selges eller brukes for spesifikke simulasjonsoppgaver.

Subsea Electrical Simulation Library er et bibliotek for SimulationX produsert av **Agito AS**, dette biblioteket er laget for å simulere virkningen av elektriske innstallasjoner, ofte under sjøen, under forskjellige forhold og belastninger.

1.2 Agito AS

Dette prosjektet skjer på ønske av Agito AS for å verifisere deres produkt, det er normalt ønskelig at en slik verifikasjonsprosess skjer av personer uavhengi til bedriften. Dette sikrer nøytralitet og «nye øyne» og gjør dermed dokumentet mer verdt, både som en sikkerhet for bedriften selv, og deres kunder.

1.3 Prosjekt Gruppen

Gruppe leder

Raymond B. Holthe

Gruppe medlem

Marius T. Bakka

Raymond B. Holthe

Alexandr Svetlanov

Veildere

Sigmund Gudvangen (HBV – Høgskolen I Buskerud og Vestfold)

Thomas Langer (Agito AS)

1.4 Verifikasjons prosess

Vår oppgave er hovedsaklig å kjøre simulasjoner av alle de forskjellige enhetene i biblioteket, under alle mulige forhold. Vi vil så kontrollere resultatene mot manuelle beregninger, og rapportere eventuelle avvik. Det endelige dokumentet skal komme i to formater, en rapport til Agito AS som vil inneholde alle data, beregninger og konklusjoner, og et redusert verifikasjonsdokument som skal kunne brukes til å bevise funksjonalitet ovenfor kunder av Agito AS.

2. Prosjekt gjennomføring

Vi har valgt å gjennomføre prosjektet etter en inkremental prosjektmodell, nærmere beskrivelse finnes I vedlegget «Prosjekt plan.pdf». Vi har ut i fra denne prosjektmodellen valgt å legge opp til en dobbeltverifisering av all manuell kalkulering, ved at 2 personer individuelt utfører alle beregninger. Når disse kontrolleres og anses som riktig, kontrolleres simulasjonsresultatene mot de beregnede verdier. Alle eventuelle avvik blir så rappoortert, og der det er mulig beskrives også årsaken til avvikene.

2.1 Prosjektkrav

Det endelige resultatet skal etterkomme prosjekt kravene, som er nærmere beskrevet i dokumentet «Krav og Test spesifikasjon.pdf». Disse omhandler blandt annet visuelle krav, som oversiktighet og språk, og krav rettet til utføringen av simulasjoner og manuelle beregninger. Resultatet av krav testene kan finnes i «Test dokument.pdf» dokumentet.

2.2 Produkt

Det endelige produktet fra dette prosjektet vil være 2 dokumenter. **Verifikasjonsdokumentet**, som vil vise til konklusjoner basert på resultatene vi har dannet gjennom prosjektet og dokumentere produktets nøyaktighet og funksjonalitet, og en **Verifikasjonsrapport** som i tillegg vil vise alle formeler og råverdier fra simuleringene.

3. utfordringer

Prosjektet vil medføre en rekke utfordringer som må løses, vi må forstå og kunne bruke SimulationX, finne korrekte formeler for alle de relevante elektriske enheten og finne årsak til eventuelle avvik underveis i arbeidet.

3.1 SimulationX

SimulationX er et avansert simuleringsprogram, vi har ikke behov for å bruke alle funksjonene, men er avhengig av å ha full kontroll over de delene som skal benyttes av biblioteket. En del tid i prosjektet ble derfor satt av til nettopp å lære seg bruken av programvaren.

3.2 Matematiske beregninger

Gruppen må også sikre at formelene vi bruker er gode nok for å oppnå den grad av nøyaktighet som er ønskelig fra simulasjonsprogrammet. Det er viktig og kunne gjenkjenne forskjellen mellom avvik grunnet avlesing og forskjellige metoder for utregning, mot avvik som kommer av en direkte feil.

4. Konklusjon

Vi har gjennom prosjektet sett mye av hvordan et godt laget simulasjonsprogram kan forenkle jobben ved å beregne store systemer, eller utstyr med krav til veldig høy grad nøyaktighet. Det har også vist seg hvor viktig det er med en verifiseringsprosess rundt et slikt prosess, etter at vi har funnet enkelte avvik fra simulert verdi og korrekt verdi i enkelte enheter.

Vi føler at vi har fått god kontroll over det arbeidet vi har utført, og føler oss sikre på de konklusjonene vi har kunne tatt ut av sammenligningene vi har utført.

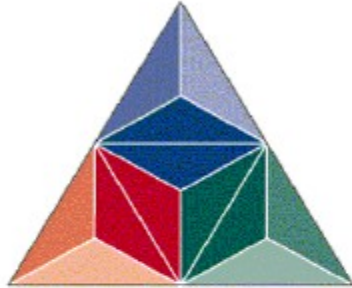

HØGSKOLEN
i Buskerud

Avdeling for Teknologi

Test document

Subsea Electrical Simulation Library

1. Test av A-Krav.

Det har til prosjektet blitt satt noen krav, enkelte av disse må kontrolleres og testes mot en testspesifikasjon formulert i dokumentet "Krav og Test -spesifikasjon".

1.1 TA1.4

Krav	Beskrivelse	Godkjenningskriterium
A1.4	Leselighet	Verifiseringsdokumentet skal være oversiktlig og tydelig, det skal raskt og enkelt kunne demonstrere systemets nøyaktighet ovenfor leser.

Verifikasjonsdokumentet og Verifikasjonsrapporten har blitt gjennomgått, og vi har kommet frem til at vi mener de er utformet på en best mulig måte for å samle all relevant informasjon uten å gå på bekostning av leselighet. Vi har blandt annet forsøkt å ha godt utformet innholdsfortegnelse og kapitell fordeling, for å kunne lett finne frem i dokumentet.

1.2 TA2.3

Krav	Beskrivelse	Godkjenningskriterium
A2.3	Testing av resultat	Samtlige utregninger skal utføres av 2 personer, resultatene skal sammenlignes uten avvik,

Power

EPU

	Unit	Calculated Results 1			Calculated Results 2		
Frequency	Hz	30	60	120	30	60	120
vOut	V	296,60	298,90	305,50	296,60	298,90	305,50
vDrop	V	29,14	27,97	24,39	29,14	27,97	24,39
iOut	A	2,91	2,80	2,44	2,91	2,80	2,44
POut	W	432,20	418,10	372,50	432,20	418,10	372,50
PI	W	42,47	39,10	29,70	42,47	39,10	29,70

Modem

	Unit	Calculated Results 1			Calculated Results 2		
Frequency	Hz	30	60	120	30	60	120
vIn	V	325,27	325,27	325,27	325,27	325,27	325,27
iIn	mA	0,00	0,00	0,00	0,00	0,00	0,00
PIn	mW	0,00	0,00	0,00	0,00	0,00	0,00

Loads

	Unit	Calculated Results 1			Calculated Results 2		
Frequency	Hz	30	60	120	30	60	120
Rload	Ω	204,21	204,21	204,21	204,21	204,21	204,21
Cload	mF	25,46	12,73	6,36	25,46	12,73	6,36
PsetX2	W	285,70	285,70	285,64	285,70	285,70	285,64
Pset	W	142,85	142,85	142,82	142,85	142,85	142,82
PCalc	VA	100,00	100,00	100,00	100,00	100,00	100,00
vIn	V	288,71	288,71	288,74	288,71	288,71	288,74
iIn	A	0,99	0,99	0,99	0,99	0,99	0,99
PI	W	285,70	285,70	285,73	285,70	285,70	285,73
vLoad	V	288,71	288,71	288,74	288,71	288,71	288,74
iLoad	A	0,99	0,99	0,99	0,99	0,99	0,99
PIload	W	285,70	285,70	285,73	285,70	285,70	285,73

Lines

	Unit	Calculated Results 1			Calculated Results 2		
Frequency	Hz	30	60	120	30	60	120
rTemp	Ω/km	0,94	0,94	0,94	0,94	0,94	0,94
rInternal	Ω/km	0,94	0,94	0,94	0,94	0,94	0,94
vIn	V	325,27	325,27	325,27	325,27	325,27	325,27
vOut	V	69,65	76,42	75,68	69,65	76,42	75,68
v	V	274,74	321,24	400,18	274,74	321,24	400,18
iIn	A	1,41	1,84	2,77	1,41	1,84	2,77
iOut	A	1,39	1,53	1,51	1,39	1,53	1,51
Pin	W	459,71	599,54	900,87	459,71	599,54	900,87
Pout	W	97,83	116,81	114,56	97,83	116,81	114,56
PI	W	465,65	716,32	786,32	465,65	716,32	786,32

Sinusoid		162,63	162,63	162,63	162,63	162,63	162,63
Square		230,00	230,00	230,00	230,00	230,00	230,00
Triangel		132,80	132,80	132,80	132,80	132,80	132,80
Sawtooth		132,80	132,80	132,80	132,80	132,80	132,80
Pulse train (20%)		102,90	102,90	102,90	102,90	102,90	102,90

Transformer

Lossless

	Unit	Calculated Results 1			Calculated Results 2		
Frequency	Hz	30	60	120	30	60	120
n		0,71	0,71	0,71	0,71	0,71	0,71
k		0,75	0,75	0,75	0,75	0,75	0,75
vIn	V	294,21	313,87	322,02	294,21	313,87	322,02
iIn	A	7,44	4,45	2,37	7,44	4,45	2,37
Pin	W	2188,92	1396,72	763,19	2188,92	1396,72	763,19
vOut	V	185,24	115,42	62,58	185,24	115,42	62,58
iOut	A	3,7	2,3	1,24	3,7	2,3	1,24
POut	W	685,4	265,47	77,6	685,4	265,47	77,6
PI	W	0.00	0.00	0.00	0.00	0.00	0.00
Pmag	W	1658,57	1269,12	735,74	1658,57	1269,12	735,74

Lossy

	Unit	Calculated Results 1			Calculated Results 2		
Frequency	Hz	30	60	120	30	60	120
n		0,71	0,71	0,71	0,71	0,71	0,71
k		0,75	0,75	0,75	0,75	0,75	0,75
vIn	V	289,90	310,96	321,00	289,90	310,96	321,00
iIn	A	6,82	4,30	2,35	6,82	4,30	2,35
Pin	W	1978,28	1336,57	753,08	1978,29	1336,57	753,09
vOut	V	168,21	111,06	61,87	168,21	111,06	61,87
iOut	A	3,36	2,22	1,22	3,36	2,22	1,22
POut	W	565,21	245,65	75,27	565,50	246,01	75,69
PI	W	284,23	116,39	34,99	278,60	115,42	34,55
Pmag	W	1380,00	1175,14	716,16	1380,00	1175,16	719,16

Signal

EPU

	Unit	Calculated Results 1			Calculated Results 2		
Frequency	Hz	30	60	120	30	60	120
VrmsOut	V	209,7	211,4	216	209,7	211,4	216
vReOut	V	206,1	211,3	215,8	206,1	211,3	215,8
vImOut	V	3,48	6,41	9,75	3,48	6,41	9,75
IrmsOut	A	2,03	1,98	1,7	2,03	1,98	1,7
iReOut	A	2,03	1,87	1,423	2,03	1,87	1,423
iImOut	A	-0,35	-0,64	-0,98	-0,35	-0,64	-0,98
phiVOut		0,95	1,74	2,59	0,95	1,74	2,59
phiIOut		-9,72	-18,92	-34,43	-9,72	-18,92	-34,43
phiIVOut		10,7	20,7	37,0	10,7	20,7	37,0
PReOut	W	424,8	391,25	297,6	424,8	391,25	297,6
PImOut	W	80,01	147,5	224,4	80,01	147,5	224,4
SOut	V	432,20	418,10	372,50	432,20	418,10	372,50

Modem

Sending Voltage

	Unit	Calculated Results 1			Calculated Results 2		
Frequency	kHz	4	20	100	4	20	100
VrmsIn	V	4,96	4,97	4,99	4,96	4,97	4,99
vReIn	V	4,95	4,58	2,15	4,95	4,58	2,15
vImIn	V	0,41	1,92	4,51	0,41	1,92	4,51
IrmsIn	mA	3,30	3,10	1,43	3,30	3,10	1,43
iReIn	mA	3,28	-2,82	-0,62	3,28	-2,82	-0,62
iImIn	mA	0,27	1,17	1,29	0,27	1,17	1,29
phiVIn		0,03	0,15	0,16	0,03	0,15	0,16
phiIIn		175,3	57,4	115,7	175,3	57,4	115,7
phiIVIn		-175,2	-157,26	-116,5	-175,2	-157,26	-116,5
PReIn	mW	-16,30	-14,00	-3,08	-16,30	-14,00	-3,08
PImIn	mW	-1,35	-5,90	-6,46	-1,35	-5,90	-6,46
Sin	mVA	16,37	15,18	7,16	16,37	15,18	7,16

Sending Power

	Unit	Calculated Results 1			Calculated Results 2		
Frequency	kHz	4	20	100	4	20	100
VrmsIn	V	12,22	12,71	18,65	12,22	12,71	18,65
vReIn	V	12,22	12,71	18,65	12,22	12,71	18,65
vImIn	V	0,01	0,03	0,05	0,01	0,03	0,05
IrmsIn	mA	8,12	7,82	5,36	8,12	7,82	5,36
iReIn	mA	8,09	7,22	2,32	8,09	7,22	2,32
iImIn	mA	-0,67	-3	-4,83	-0,67	-3	-4,83
phiVIn		0,03	0,15	0,16	0,03	0,15	0,16
phiIIn		175,3	57,4	115,7	175,3	57,4	115,7
phiIVIn		-175,2	-157,26	-116,5	-175,2	-157,26	-116,5
PReIn	mW	98,93	91,66	43,03	98,93	91,66	43,03
PImIn	mW	8,29	38,4	90,12	8,29	38,4	90,12
Sin	mV A	99,28	99,38	99,86	99,28	99,38	99,86

Receiving

	Unit	Calculated Results 1			Calculated Results 2		
Frequency	kHz	4	20	100	4	20	100
VrmsIn	V	7,9	7,66	4,8	7,9	7,66	4,8
vReIn	V	7,90	7,41	2,92	7,90	7,41	2,92
vImIn	V	-0,41	-1,94	-3,82	-0,41	-1,94	-3,82
IrmssIn	mA	4,16	4,03	2,53	4,16	4,03	2,53
iReIn	mA	4,16	3,9	1,54	4,16	3,9	1,54
iImIn	mA	-0,22	-1,02	-2,01	-0,22	-1,02	-2,01
phiVIn		-3	-14,67	-52,62	-3	-14,67	-52,62
phiIIn		-3	-14,67	-52,62	-3	-14,67	-52,62
phiIVIn		0	0	0	0	0	0
PReIn	W	32,91	30,87	12,17	32,91	30,87	12,17
PImIn	W	0	0	0	0	0	0
Sin	VA	32,91	30,87	12,17	32,91	30,87	12,17

Loads

EPU sending

	Unit	Calculated Results 1			Calculated Results 2		
Frequency (Hz)		60	120	240	60	120	240
Rload	Ω	204,21	204,21	204,21	204,21	204,21	204,21
Cload	μF	12,73	6,37	3,18	12,73	6,37	3,18
PsetX2	W	285,70	285,77	285,64	285,70	285,77	285,64
Pset	W	142,85	142,88	142,82	142,85	142,88	142,82
PCalc	VA	100,00	100,00	100,00	100,00	100,00	100,00
VrmsIn	V	204,15	204,13	204,17	204,15	204,13	204,17
vReIn	V	202,94	202,93	202,96	202,94	202,93	202,96
vImIn	V	-22,18	-22,18	-22,18	-22,18	-22,18	-22,18
IrmsIn	A	0,70	0,70	0,70	0,70	0,70	0,70
iReIn	A	0,54	0,54	0,54	0,54	0,54	0,54
iImIn	A	0,44	0,44	0,44	0,44	0,44	0,44
phiVIn							
phiIIn							
phiIVIn							
PReIn	W	99,99	100,00	99,92	99,99	100,00	99,92
PImIn	W	-102,02	-102,00	-102,04	-102,02	-102,00	-102,04
SIn	VA	142,85	142,88	142,82	142,85	142,88	142,82
VrmsLoad	V	204,15	204,13	204,17	204,15	204,13	204,17
vReLoad	V	202,94	202,93	202,96	202,94	202,93	202,96
vImLoad	V	-22,18	-22,18	-22,18	-22,18	-22,18	-22,18
IrmsLoad	A	0,70	0,70	0,70	0,70	0,70	0,70
iReLoad	A	0,54	0,54	0,54	0,54	0,54	0,54
iImLoad	A	0,44	0,44	0,44	0,44	0,44	0,44
phiVLoad							
phiILoad							
phiIVLoad							
PReLoad	W	99,99	100,00	99,92	99,99	100,00	99,92
PImLoad	W	-102,02	-102,00	-102,04	-102,02	-102,00	-102,04
Sload	VA	142,85	142,88	142,82	142,85	142,88	142,82

Lines

	Unit	Calculated Results 1			Calculated Results 2		
Frequency	Hz	60	4K	100K	60	4K	100K
rTemp	Ω/K m	0,94	0,94	0,94	0,94	0,94	0,94
SkinDept	mm	4,88	0,60	0,12	4,88	0,60	0,12
diameter	mm	2,76	2,76	2,76	2,76	2,76	2,76
resistivity	$m\Omega$ m	$5.65 \cdot 10^{-6}$	$5.65 \cdot 10^{-6}$	$5.65 \cdot 10^{-6}$	$5.65 \cdot 10^{-6}$	$5.65 \cdot 10^{-6}$	$5.65 \cdot 10^{-6}$
rInternal	Ω	0,94	1,39	5,68	0,94	1,39	5,68
VrmsIn	V	230,00	230,00	230,00	230,00	230,00	230,00
vReIn	V	230,00	230,00	230,00	230,00	230,00	230,00
vImIn	V	0,00	0,00	0,00	0,00	0,00	0,00
VrmsOut	V	0,94	0,94	0,94	0,94	0,94	0,94
vReOut	V	4,88	0,60	0,12	4,88	0,60	0,12
vImOut	V	2,76	2,76	2,76	2,76	2,76	2,76
Vrms	V						
vRe	V						
vIm	V						
IrmsIn	A						
iReIn	A						
iImIn	mA						
IrmsOut	A						
iReOut	A						
iImOut	A						
phiVIn							
phiIIn							
phiVIn							
phiVOut							
phiIOut							
phiIVOut							
PhiVL1							
phiIL1							
phiIVL1							

PreIn	W						
PImIn	W						
SIn	VA						
PreOut	W						
PImOut	mW						
SOut	VA						
Pre	mW						
PIm							
S							
dB	dB						

Junctions and Terminations

True connection

	Unit	Calculated Results 1			Calculated Results 2		
Frequency	Hz	60	4K	20K	60	4K	20K
VrmsIn	V	115,02	156,38	221,92	115,02	156,38	221,92
vReIn	V	115,01	147,55	219,42	115,01	147,55	219,42
vImIn	V	1,08	51,81	33,24	1,08	51,81	33,24
VrmsOut	V	115,02	156,38	221,92	115,02	156,38	221,92
vReOut	V	115,01	147,55	219,42	115,01	147,55	219,42
VImOut	V	1,08	51,81	33,24	1,08	51,81	33,24
Vrms	V	0,00	0,00	0,00	0,00	0,00	0,00
vRe	V	0,00	0,00	0,00	0,00	0,00	0,00
VIm	V	0,00	0,00	0,00	0,00	0,00	0,00
IrmsIn	A	1,15	0,97	0,35	1,15	0,97	0,35
iReIn	A	1,15	0,82	0,11	1,15	0,82	0,11
iImIn	A	0,01	-0,52	-0,33	0,01	-0,52	-0,33
IrmsOut	A	1,15	0,97	0,35	1,15	0,97	0,35
iReOut	A	1,15	0,82	0,11	1,15	0,82	0,11
iImOut	A	0,01	-0,52	-0,33	0,01	-0,52	-0,33
phiVin							
phiIn							
phiIVin		1,08	51,49	80,96	1,08	51,49	80,96
phiVOut							
phiIOut							
phiIVOut		1,08	51,49	80,96	1,08	51,49	80,96
PReIn	W	132,24	94,82	12,17	132,24	94,82	12,17
PImin	W	2,49	119,15	76,45	2,49	119,15	76,45
Sin	VA	132,26	152,27	77,41	132,26	152,27	77,41
PReOut	W	132,24	94,82	12,17	132,24	94,82	12,17
PImOut	W	2,49	119,15	76,45	2,49	119,15	76,45
SOut	VA	132,26	152,27	77,41	132,26	152,27	77,41

Filter

3.5.1.2.1 EPU Sending

	Unit	Calculated Results 1			Calculated Results 2		
Frequency	Hz	60	4k	100k	60	4K	100K
VrmsIn	V	4,95	4,95	4,95	4,95	4,95	4,95
vReIn	V	4,95	4,95	4,95	4,95	4,95	4,95
vImIn	V	0	0	0	0	0	0
irmsIn	mA	4,95	4,95	4,95	4,95	4,95	4,95
iReIn	mA	4,95	4,95	4,95	4,95	4,95	4,95
iImIn	mA	0	0	0	0	0	0
phiVin		0	0	0	0	0	0
phiIn		0	0	0	0	0	0
phiIVIn		0	0	0	0	0	0
PReIn	mW	24,502	24,502	24,502	24,502	24,502	24,502
PImIn	mW	0	0	0	0	0	0
Sin	mVA	24,502	24,502	24,502	24,502	24,502	24,502
VrmsOut	mV	0	0	0	0	0	0
vReOut	mV	0	0	0	0	0	0
vImOut	mV	0	0	0	0	0	0
IrmsOut	mA	0	0	0	0	0	0
iReOut	mA	0	0	0	0	0	0
iImOut	mA	0	0	0	0	0	0
phiVOut		0	0	0	0	0	0
phiIOut		0	0	0	0	0	0
phiIVOut		0	0	0	0	0	0
PReOut	mW	0	0	0	0	0	0
PImOut	mW	0	0	0	0	0	0
SOut	mVA	0	0	0	0	0	0

3.5.1.2.2 Modem sending

	Unit	Calculated Results 1			Calculated Results 2		
Frequency	Hz	60	4K	100K	60	4K	100K
VrmsIn	V	4,95	4,95	4,51	4,95	4,95	4,51
vReIn	V	4,95	4,95	4,51	4,95	4,95	4,51

vImIn	mV	15,60	15,58	7,70	15,60	15,58	7,70
irmsIn	mA	5,24	5,24	49,54	5,24	5,24	49,54
iReIn	mA	5,01	5,01	49,54	5,01	5,01	49,54
iImIn	mA	-1,56	-1,56	-0,77	-1,56	-1,56	-0,77
phiVin			0,18			0,18	
phiIIn			-17,29			-17,29	
phiIVIn		17,47	17,47	0,98	17,47	17,47	0,98
PReIn	mW	24,75	24,75	223,14	24,75	24,75	223,14
PImIn	mW	7,79	7,79	3,82	7,79	7,79	3,82
Sin	mV A	25,95	25,95	223,17	25,95	25,95	223,17
VrmsOut	V	4,95	4,95	4,51	4,95	4,95	4,51
vReOut	V	4,95	4,95	4,51	4,95	4,95	4,51
vImOut	mV		15,58			15,58	
IrmsOut	mA		1,57			1,57	
iReOut	mA		0,06			0,06	
iImOut	mA		-1,57			-1,57	
phiVOut			0,18			0,18	
phiIOut			-88,00			-88,00	
phiIVOut		88,18	88,18	1,08	88,18	88,18	1,08
PReOut	mW		0,25			0,25	
PImOut	mW		7,79			7,79	
SOut	mV A		7,80			7,80	

Transformer

3.5.2.2.1 Lossless

	Unit	Calculated Results 1			Calculated Results 2		
Frequency	Hz	60	4K	100K	60	4K	100K
n		0,71	0,71	0,71	0,71	0,71	0,71
k		0,75	0,75	0,75	0,75	0,75	0,75
VrmsIn	V	163,41	229,82	230,00	163,41	229,82	230,00
vReIn	V	140,04	229,77	230,00	140,04	229,77	230,00
vImIn	V	84,21	4,85	0,19	84,21	4,85	0,19
IrmsIn	mA	12.32*10 ³	485,32	19,45	12.32*10 ³	485,32	19,45
iReIn	mA	9.00*10 ³	22,99	0,04	9.00*10 ³	22,99	0,04
iImIn	mA	-8.42*10 ³	-484,78	-19,45	-8.42*10 ³	-484,78	-19,45
phiVIn							
phiIIn							
phiIVIn							
PReIn	W						
PImIn	W						
SIn	VA	2013,57	111,54	4,47	2013,57	111,54	4,47
pfln							
VrmsOut	V	166,05	32,75	30,50	166,05	32,75	30,50
vReOut	V	159,30	31,21	30,50	159,30	31,21	30,50
vImOut	V	46,87	-9,93	-0,40	46,87	-9,93	-0,40
IrmsOut	mA	3.32*10 ³	242,18	9,71	3.32*10 ³	242,18	9,71
iReOut	mA	3.22*10 ³	17,13	0,03	3.22*10 ³	17,13	0,03
iImOut	mA	0.82*10 ³	-241,57	-9,71	0.82*10 ³	-241,57	-9,71
phiVOut							
phiIOut							
phiIVOut							
PReOut	W						
PImOut	W						
SOut	VA	551,09	7,93	0,30	551,09	7,93	0,30
pfOut							

3.5.2.2.2 Lossy

	Unit	Calculated Results 1			Calculated Results 2		
Frequency	Hz	60	4K	100K	60	4K	100K
n		0,71	0,71	0,71	0,71	0,71	0,71
k		0,75	0,75	0,75	0,75	0,75	0,75
VrmsIn	V	158,25	229,45	229,99	158,25	229,45	229,99
vReIn	V	146,97	229,7	229,99	146,97	229,7	229,99
vImIn	V	58,68	4,84	0,2	58,68	4,84	0,2
IrmsIn	mA	10.17*10 ³	484,98	19,53	10.17*10 ³	484,98	19,53
iReIn	mA	8.30*10 ³	30,35	1,05	8.30*10 ³	30,35	1,05
iImIn	mA	-5.87*10 ³	-484,03	-19,51	-5.87*10 ³	-484,03	-19,51
phiVIn							
phiIIn							
phiIVIn							
PReIn	W						
PImIn	W						
SIn	VA	1608,96	111,42	4,49	1608,96	111,42	4,49
pfln							
VrmsOut	V	127,82	32,72	30,44	127,82	32,72	30,44
vReOut	V	114,22	31,31	30,36	114,22	31,31	30,36
vImOut	V	57,38	-9,51	-2,17	57,38	-9,51	-2,17
IrmsOut	mA	2.55*10 ³	241,92	9,69	2.55*10 ³	241,92	9,69
iReOut	mA	2.32*10 ³	20,28	-0,54	2.32*10 ³	20,28	-0,54
iImOut	mA	1.06*10 ³	-241,07	-9,67	1.06*10 ³	-241,07	-9,67
phiVOut							
phiIOut							
phiIVOut							
PReOut	W						
PImOut	W						
SOut	VA	326,53	7,92	0,3	326,53	7,92	0,3
pfOut							

2. Test av B-Krav.

Med hensyn til tids-perspektivet av prosjektet, samt lavt verdiutbytte har vi valgt å ikke etterfølge kravene B1.1 og B1.2.



HØGSKOLEN
i Buskerud

Avdeling for Teknologi

Verification Document

Subsea Electrical Simulation Library

SimulationX Subsea Electrical Simulation library verification report

Index

Page:

1. Introduction	1
1.1 Scope	1
1.2 General Description	1
1.3 Study methodology	1
1.4 Result summary	1
2. Power Calculations	2
2.1 Sources	3
2.1.1 Electrical Power Unit	3
2.1.1.1 Parameters	3
2.1.1.2 Results	4
2.1.1.3 UPS Noise, offset- Voltage and phase	4
2.1.1.4 Legend: Electrical Power Unit	5
2.1.2 Modem	6
2.1.2.1 Parameters	6
2.1.2.2 Results	7
2.1.2.3 Legend: Modem	7
2.2 Loads	8
2.2.1 Multiphase Flow Meter	8
2.2.1.1 Parameters	8
2.2.1.2 Results	9
2.2.1.2.1 Constant Power	9
2.2.1.2.2 Turn on/Turn off	10
2.2.1.2.3 Variable Power	11
2.2.2 Subsea Control Module	12
2.2.2.1 Parameters	12
2.2.2.2 Results	13
2.2.2.2.1 Constant Power	13
2.2.2.2.2 Turn on/Turn off	14
2.2.2.2.3 Variable Power	15
2.2.3 Legend: Loads	16

SimulationX Subsea Electrical Simulation library verification report

2.3 Lines	17
2.3.1 Jumper	17
2.3.1.1 Parameteres	17
2.3.1.2 Results	18
2.3.2 Umbilical	19
2.3.2.1 Parameteres	19
2.3.2.2 Results	20
2.3.3 Legend: Lines	20
2.4 Junctions and Terminations	21
2.4.1 Electrical Junction Box	21
2.4.1.1 Parameteres	21
2.4.1.2 Results	22
2.4.1.2.1 True Connection	22
2.4.1.2.2 Faulty Connection	22
2.4.2 Pin Connector Female	23
2.4.2.1 Parameteres	23
2.4.2.2 Results	24
2.4.2.2.1 True Connection	24
2.4.2.2.2 Faulty Connection	24
2.4.3 Pin Connector Male	25
2.4.3.1 Parameteres	25
2.4.3.2 Results	26
2.4.3.2.1 True Connection	26
2.4.3.2.2 Faulty Connection	26
2.4.4 Topside Umbilical Termination Unit	27
2.4.4.1 Parameteres	27
2.4.4.2 Results	28
2.4.4.2.1 True Connection	28
2.4.4.2.2 Faulty Connection	28
2.4.4 Umbilical Termination Head	29
2.4.4.1 Parameteres	29
2.4.4.2 Results	30
2.4.4.2.1 True Connection	30
2.4.4.2.2 Faulty Connection	30
2.4.5 Legend: Junctions and Terminations	30

SimulationX Subsea Electrical Simulation library verification report

2.5 Miscellaneous	31
2.5.1 Filter	31
2.5.1.1 Parameters	31
2.5.1.2 Results	32
2.5.1.3 Legend: Filter	32
2.5.2 RMS calculator	33
2.5.2.1 Parameters	33
2.5.2.2 Results	33
2.5.3 Transformer	34
2.5.3.1 Parameters	34
2.5.3.2 Results	35
2.5.3.2.1 Lossless	35
2.5.3.2.2 Lossy	35
2.5.3.3 Legend: Transformer	36
3. Signal Calculations	37
3.1 Sources	38
3.1.1 Electrical Power Unit	38
3.1.1.1 Parameters	38
3.1.1.2 Results	39
3.1.1.3 Legend: Electrical Power Unit	39
3.1.2 Modem	40
3.1.2.1 Parameters	41
3.1.2.2 Results	42
3.1.2.2.1 Sending Voltage	42
3.1.2.2.2 Sending Power	42
3.1.2.2.3 Receiving	43
3.1.2.3 Legend: Modem	43

SimulationX Subsea Electrical Simulation library verification report

3.2 Loads	44
3.2.1 Multiphase Flow Meter	44
3.2.1.1 Parameters	44
3.2.1.2 Results	45
3.2.1.2.1 EPU sending	45
3.2.1.2.2 Modem Sending	46
3.2.1.2.3 Variable Power	47
3.2.2 Subsea Control Module	48
3.2.2.1 Parameters	48
3.2.2.2 Results	49
3.2.2.2.1 EPU sending	49
3.2.2.2.2 Modem Sending	50
3.2.2.2.3 Variable Power	51
3.2.3 Legend: Loads	52
3.3 Lines	53
3.3.1 Jumper	53
3.3.1.1 Parameters	53
3.3.1.2 Results	54-55
3.3.2 Umbilical	56
3.3.2.1 Parameters	56
3.3.2.2 Results	57-58
3.3.3 Legend: Lines	58-59
3.4 Junctions and Terminations	60
3.4.1 Electrical Junction Box	60
3.4.1.1 Parameters	60
3.4.1.2 Results	61
3.4.1.2.1 True Connection	61
3.4.1.2.2 Faulty Connection	62
3.4.2 Pin Connector Female	63
3.4.2.1 Parameters	63
3.4.2.2 Results	64
3.4.2.2.1 True Connection	64
3.4.2.2.2 Faulty Connection	65

SimulationX Subsea Electrical Simulation library verification report

3.4.3 Pin Connector Male	66
3.4.3.1 Parameters	66
3.4.3.2 Results	67
3.4.3.2.1 True Connection	67
3.4.3.2.2 Faulty Connection	68
3.4.4 Topside Umbilical Termination Unit	69
3.4.4.1 Parameters	69
3.4.4.2 Results	70
3.4.4.2.1 True Connection	70
3.4.4.2.2 Faulty Connection	71
3.4.5 Umbilical Termination Head	72
3.4.5.1 Parameters	72
3.4.5.2 Results	73
3.4.5.2.1 True Connection	73
3.4.5.2.2 Faulty Connection	74
3.4.6 Legend: Junctions and Terminations	75
3.5 Miscellaneous	76
3.5.1 Filter	76
3.5.1.1 Parameters	76
3.5.1.2 Results	77
3.5.1.2.1 EPU Sending	77
3.5.1.2.2 Modem Sending	78
3.5.1.3 Legend: Filter	79
3.5.2 Transformer	80
2.5.2.1 Parameters	80
2.5.2.2 Results	81
2.5.2.2.1 Lossless	81
2.5.2.2.2 Lossy	82
3.5.1.3 Legend: Transformer	83

1 Introduction

1.1 Scope

The scope of this document is to create a third-party verification of functionality and accuracy the SimulationX Subsea Electrical Simulation Library on behalf of Agito AS.

1.2 General Description

The SimulationX Subsea Electrical Library is developed by ITI GmbH and Agtio AS, the library is designed for efficient simulation of electrical subsea installations, and to function together with the Electrical Power and Communication Analysis library. The library consists of several elements representing electrical equipment, every element have been tested in combination with the Electrical Power and Communication Analysis library.

1.3 Study methodology

Each element have been tested by running several simulations under various conditions and frequencies, where all the results have been compared to hand calculations.

1.4 Result summary

All elements have been successfully tested and verified with the exception of:

- Jumper POWER Powerloss (PI)
- Umbilical POWER Powerloss (PI)

Phase angles of Voltages, Currents and Currents with reference to Voltages of the Signal Library has yet to be successfully tested and can not have its function guaranteed. This also results in some of the Power results remaining unverified.

2 Power Calculation

The simulations of the Subsea Electrical Simulation Library, will when set to Power, handle its calculations in the form of peak values. For that reason, all results have been manually read from their respected charts and may have small deviations from their actual values, there may also be cases where the charging and discharging of capacitors and inductors cause variations in the sinusoid, in this case the result will be based on a median value. These factors will be taken into account when comparing the results, and does not reflect inaccuracies of the library, simulation software or manual calculations.

All values should for the same reason be regarded as peak values, unless otherwise stated.

Actual simulation results can be found in the attachment “Simulation results POWER.pdf”.

2.1 Sources

2.1.1 Electrical Power Unit

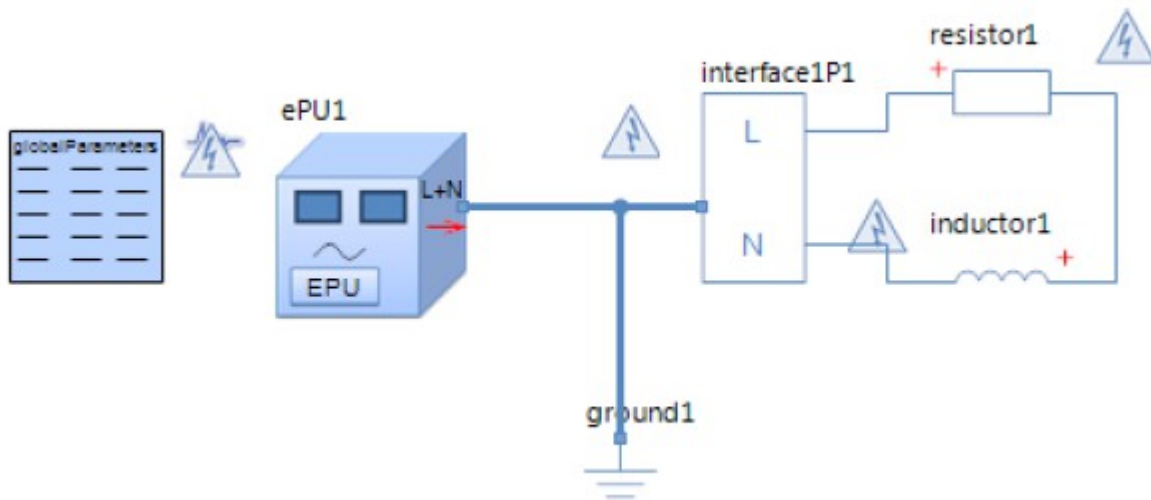

2.1.1.1 Parameters

Internal Parameters			
	Comment:	Name:	Value:
	Internal Resistance L1	RL	5 Ω
	Internal Resistance N	RN	5 Ω
	Sine Wave RMS Voltage	VrmsSrcSig	230 Vrms
	Voltage Offset	offsetSig	0
	Voltage Phase Angle	phiV	0

External Parameters			
	Comment:	Name:	Value:
	Resistor1	resistor1.R	100 Ω
	Inductor1	inductor1.L	100 mH

SimulationX Subsea Electrical Simulation library verification report

2.1.1.2 Results

	Unit	Simulation Results			Calculated Results		
Frequency	Hz	30	60	120	30	60	120
vOut	V	296,60	298,90	305,50	296,60	298,90	305,50
vDrop	V	29,14	27,97	24,39	29,14	27,97	24,39
iOut	A	2,91	2,80	2,44	2,91	2,80	2,44
POut	W	432,20	418,10	372,50	432,20	418,10	372,50
PI	W	42,47	39,10	29,70	42,47	39,10	29,70

2.1.1.3 UPS Noise, offset- Voltage and phase

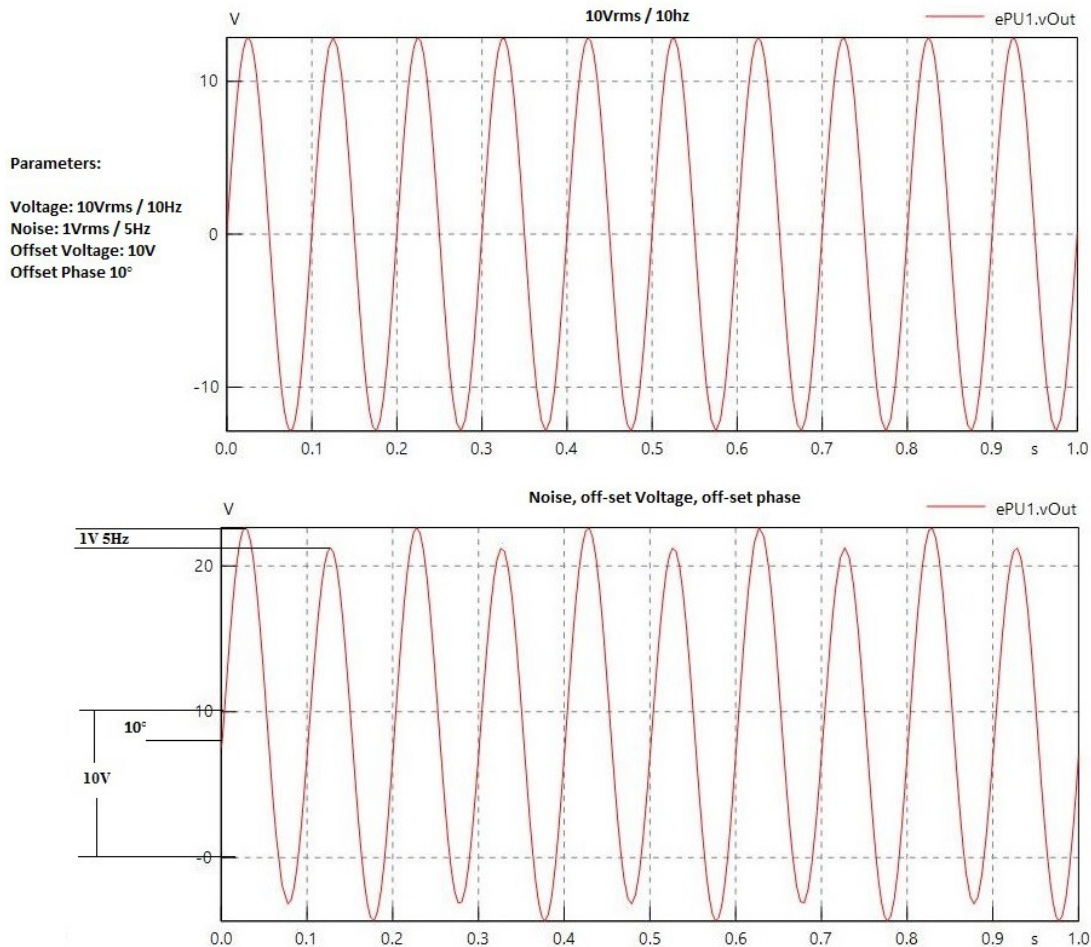

The sinusoid clearly shows a 10° shift of phase, and a 10V offset compared to the normal curve. The noise creates the 1V increase in every other peak due to it being at half the frequency of the actual voltage.

2.1.1.4 Legend: Electrical Power Unit

- Vout Output voltage from EPU (L1 to N)

SimulationX Subsea Electrical Simulation library verification report

- vDrop Voltage drop over internal resistance of the EPU
- iOut Output current from EPU
- Pout Output power from EPU
- PI Powerloss from internal resistance of the EPU

2.1.2 Modem

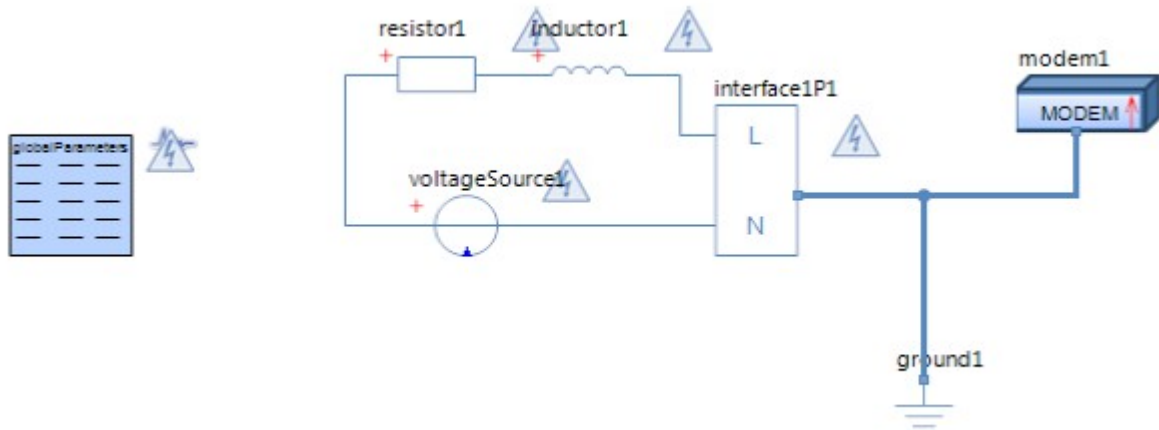

2.1.2.1 Parameters

Internal Parameters			
	Comment:	Name:	Value:
	-	-	-

External Parameters			
	Comment:	Name:	Value:
	VoltageSource1	v_src	230 Vrms
	Resistor1	resistor.R	1500 Ω
	Inductor1	inductor.L	5mH

SimulationX Subsea Electrical Simulation library verification report

2.1.2.2 Results

	Unit	Simulation Results			Calculated Results		
Frequency	Hz	30	60	120	30	60	120
vIn	V	325,27	325,27	325,27	325,27	325,27	325,27
iIn	mA	0,00	0,00	0,00	0,00	0,00	0,00
PIn	mW	0,00	0,00	0,00	0,00	0,00	0,00

2.1.2.3 Legend: Modem

- Vin Input Voltage
- iIn Input Current
- Pin Input Power

2.2 Loads

2.2.1 MultiPhase Flow Meter

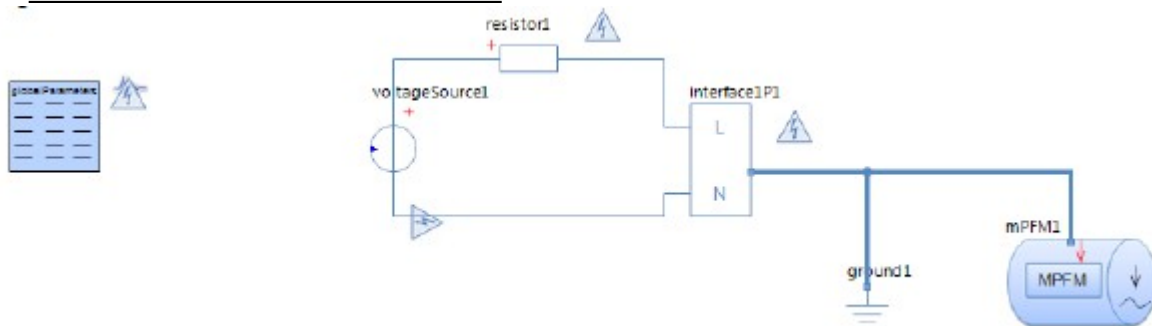

2.2.1.1 Parameters

Internal Parameters			
	Comment:	Name:	Value:
	Simulate with internal Transformer	trafoOn	USANN
	SCM input Frequency	fIn	30;60;120 Hz
	Constant or Variable Power	pType	Constant Power
	Output Power from PSU in MPFM	P	100 VA
	PSU Power Factor	pf	0,7
	PSU turn-off RMS Voltage	vMin	130 Vrms
	PSU turn-on RMS Voltage	vMax	180 Vrms

External Parameters			
	Comment:	Name:	Value:
	VoltageSource1	v_src	230 Vrms
	Resistor1:	resistor1.R	50 Ω

SimulationX Subsea Electrical Simulation library verification report

2.2.1.2 Results

2.2.1.2.1 Constant Power

	Unit	Simulation Results			Calculated Results		
Frequency	Hz	30	60	120	30	60	120
Rload	Ω	204,21	204,21	204,21	204,21	204,21	204,21
Cload	mF	25,46	12,73	6,36	25,46	12,73	6,36
PsetX2	W	285,71	285,71	285,71	285,70	285,70	285,64
Pset	W	142,86	142,86	142,86	142,85	142,85	142,82
PCalc	VA	100,00	100,00	100,00	100,00	100,00	100,00
vIn	V	288,71	288,70	288,70	288,71	288,71	288,74
iIn	A	0,99	0,99	0,99	0,99	0,99	0,99
PI	W	285,70	285,70	285,73	285,70	285,70	285,73
vLoad	V	288,71	288,70	288,70	288,71	288,71	288,74
iLoad	A	0,99	0,99	0,99	0,99	0,99	0,99
PIload	W	285,70	285,70	285,73	285,70	285,70	285,73

2.2.1.2.2 Turn on/Turn off

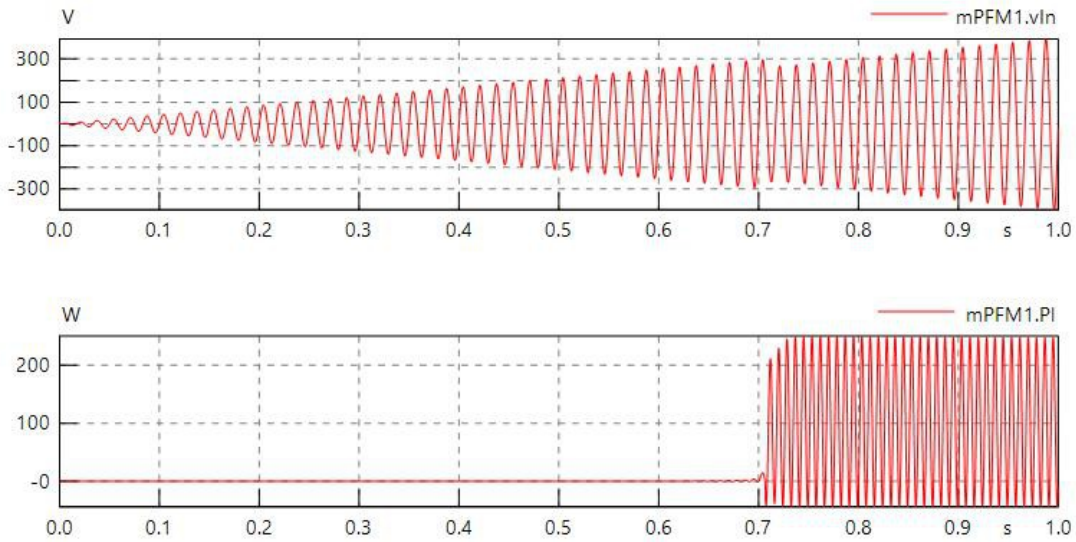

The graphics show the MPFM initiating its load at approximately 250V with a startup delay of about 0.1 seconds.

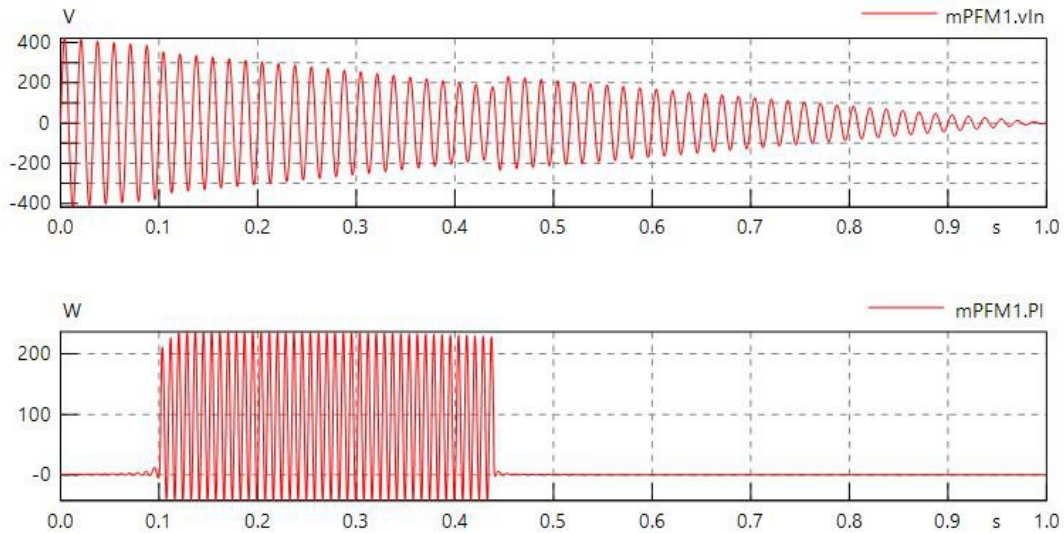

The graphics show the MPFM starting in the on position, after having had a 0.1 seconds startup delay, and turning itself off at approximately 180V.

2.2.1.2.3 Variable Power

40 VARsm → 150 VARsm → 40 Varsm

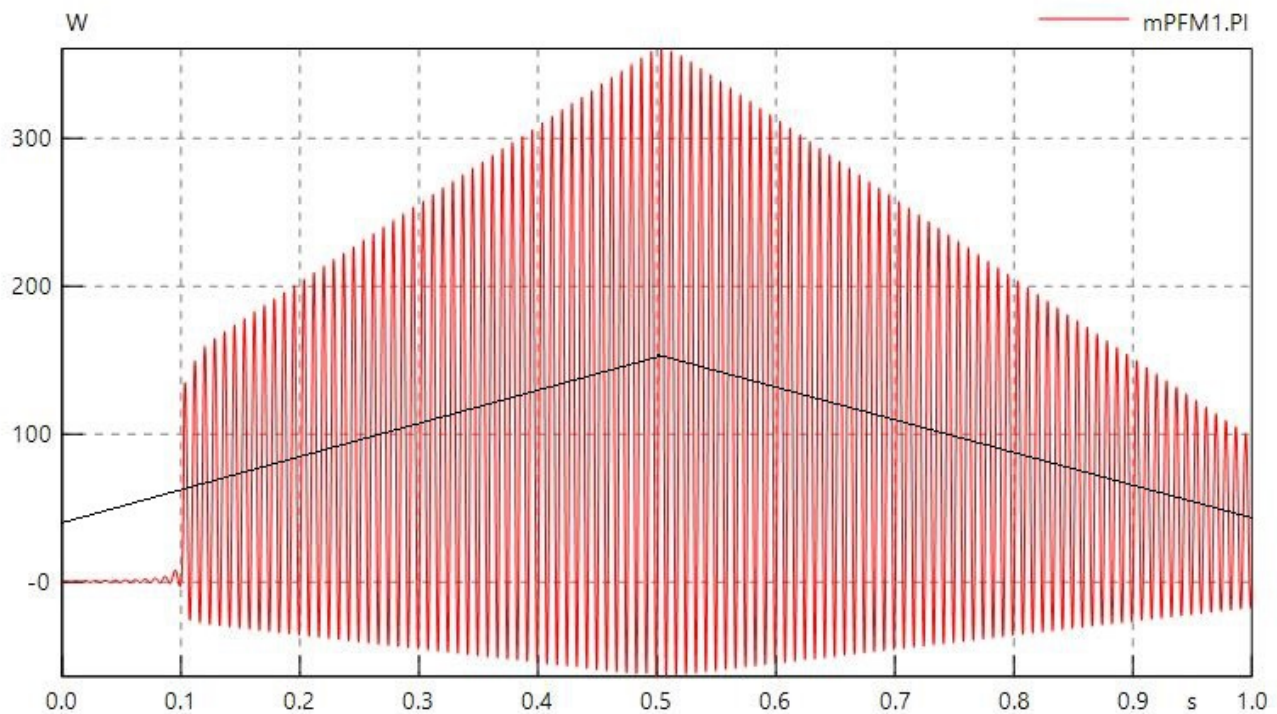

The MPFM unit gradually increases the power output, the center of the sinusoid will gradually shift with the increase of the signal, as represented by the black line. By disregarding the initial startup delay, we can see how it peaks at approximately 210W, and ends at 60W. The peak values of the desired power comes in at 212VA and 56VA.

2.2.2 Subsea Control Module

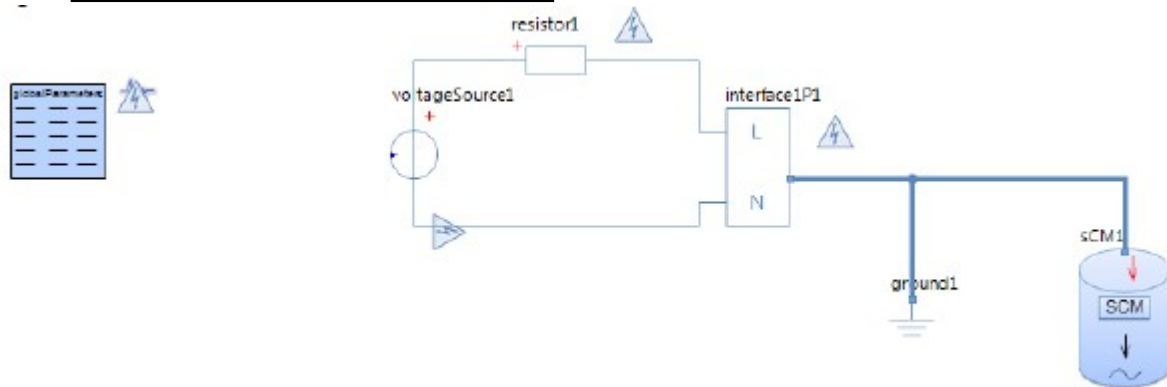

2.2.2.1 Parameters

Internal Parameters			
	Comment:	Name:	Value:
	Simulate with internal Transformer	trafoOn	USANN
	SCM input Frequency	fIn	30;60;120 Hz
	Constant or Variable Power	pType	Constant Power
	Output Power from PSU in SCM	P	100 VA
	PSU Power Factor	pf	0,7
	PSU turn-off RMS Voltage	vMin	130 Vrms
	PSU turn-on RMS Voltage	vMax	180 Vrms

External Parameters			
	Comment:	Name:	Value:
	VoltageSource1	v_src	230 Vrms
	Resistor1:	resistor1.R	50 Ω

SimulationX Subsea Electrical Simulation library verification report

2.2.2.2 Results

2.2.2.1.1 Constant Power

	Unit	Simulation Results			Calculated Results		
Frequency	Hz	30	60	120	30	60	120
Rload	Ω	204,21	204,21	204,21	204,21	204,21	204,21
Cload	mF	25,46	12,73	6,36	25,46	12,73	6,36
PsetX2	W	285,71	285,71	285,71	285,70	285,70	285,64
Pset	W	142,86	142,86	142,86	142,85	142,85	142,82
PCalc	VA	100,00	100,00	100,00	100,00	100,00	100,00
vIn	V	288,71	288,70	288,70	288,71	288,71	288,74
iIn	A	0,99	0,99	0,99	0,99	0,99	0,99
PI	W	285,70	285,70	285,73	285,70	285,70	285,73
vLoad	V	288,71	288,70	288,70	288,71	288,71	288,74
iLoad	A	0,99	0,99	0,99	0,99	0,99	0,99
PILoad	W	285,70	285,70	285,73	285,70	285,70	285,73

2.2.2.2.2 Turn on/Turn off

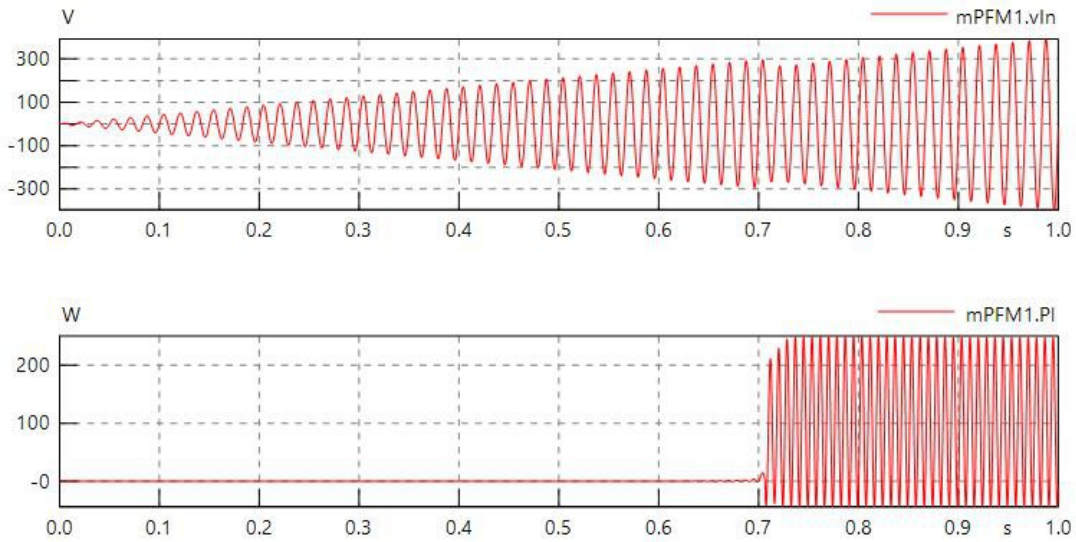

The graphics show the SCM initiating its load at approximately 250V with a startup delay of about 0.1 seconds.

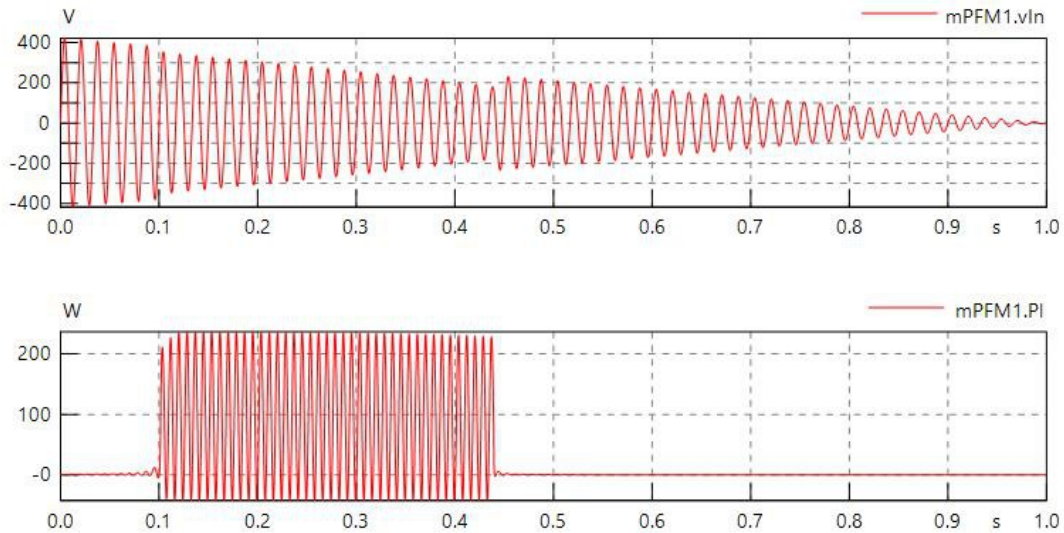

The graphics show the SCM starting in the on position, after having had a 0.1 seconds startup delay, and turning itself off at approximately 180V.

2.2.2.2.3 Variable Power

40 VARsm → 150 VARsm → 40 VARsm

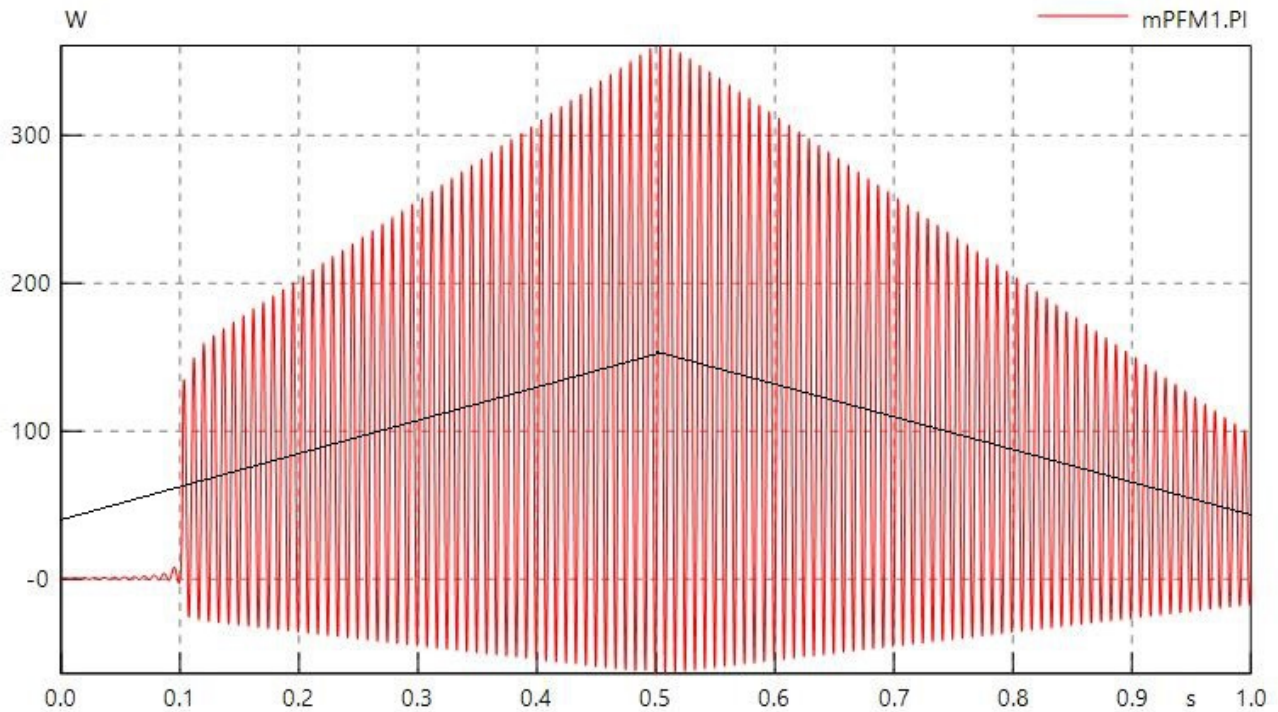

The SCM unit gradually increases the power output, the center of the sinusoid will gradually shift with the increase of the signal, as represented by the black line. By disregarding the initial startup delay, we can see how it peaks at approximately 210W, and ends at 60W. The peak values of the desired power comes in at 212VA and 56VA.

2.2.3 Legend: Loads

- Rload PSU Resistance
- Cload PSU Capacitance
- PsetX2 Set Power Signal Including Power Factor * 2
- Pset Set Power Signal Including Power Factor * 2
- PCalc Output Power from PSU in MPFM/SCM
- vIn Input Voltage from L1 to N
- iIn Input Current
- PI Power Loss
- vLoad PSU input voltage from L1 to N
- iLoad PSU input Current
- PLoad PSU input Power

○ **2.3 Lines**

2.3.1 Jumper

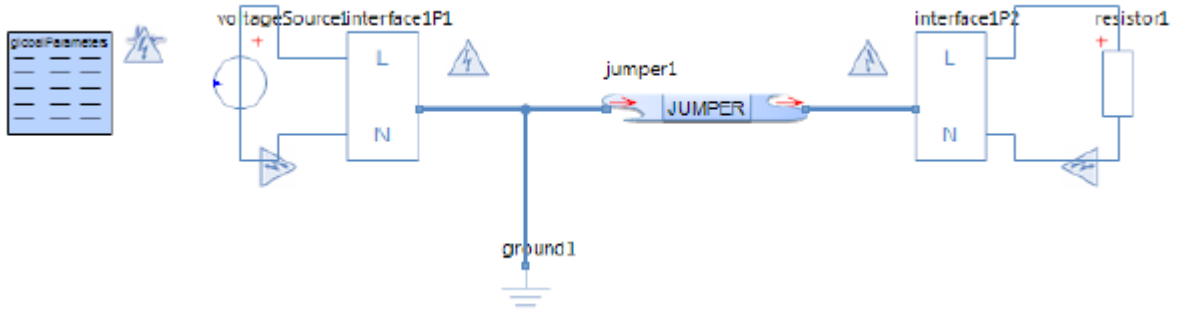

2.3.1.1 Parameters

Internal Parameters			
	Comment:	Name:	Value:
	Resistance per length for each Line at 20°C	r	1 Ω/km
	Inductance per length for each Line	l	2.5 mH/km
	Conductance per length between Lines	g	10 ⁻¹⁰ Ω/m
	Capacitance per length between Lines	c	0.3 μF/km
	Length of Jumper for each Line	length	100 km
	Number of Lumped Segments	N	3
	Temperature of the conductor	temp	5°C

External Parameters			
	Comment:	Name:	Value:
	VoltageSource1	v_src	230 Vrms
	Resistor1	resistor1.R	50 Ω

SimulationX Subsea Electrical Simulation library verification report

2.3.1.2 Results

	Unit	Simulation Results			Calculated Results		
Frequency	Hz	30	60	120	30	60	120
rTemp	Ω/km	0,94	0,94	0,94	0,94	0,94	0,94
rInternal	Ω/km	0,94	0,94	0,94	0,94	0,94	0,94
vIn	V	325,27	325,27	235,27	325,27	325,27	325,27
vOut	V	69,65	76,42	75,68	69,65	76,42	75,68
v	V	274,74	321,24	400,17	274,74	321,24	400,18
iIn	A	1,41	1,84	2,77	1,41	1,84	2,77
iOut	A	1,39	1,53	1,51	1,39	1,53	1,51
Pin	W	459,7	599,54	900,78	459,71	599,54	900,87
Pout	W	97,83	116,81	114,55	97,83	116,81	114,56
PI	W	285,87	104,54	456,51	465,65	716,32	786,32

2.3.2 Umbilical

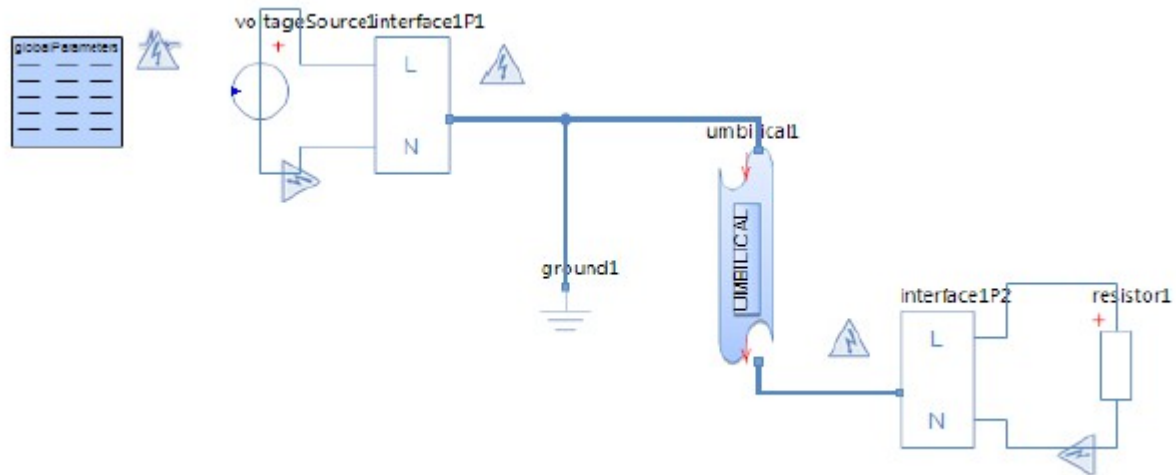

2.3.2.1 Parameters

Internal Parameters			
	Comment:	Name:	Value:
	Resistance per length for each Line at 20°C	r	1 Ω/km
	Inductance per length for each Line	l	2.5 mH/km
	Conductance per length between Lines	g	10 ⁻¹⁰ Ω/m
	Capacitance per length between Lines	c	0.3 μF/km
	Length of Jumper for each Line	length	100 km
	Number of Lumped Segments	N	3
	Temperature of the conductor	temp	5 °C

External Parameters			
	Comment:	Name:	Value:
	VoltageSource1	v_src	230 Vrms
	Resistor1	resistor1.R	50 Ω

SimulationX Subsea Electrical Simulation library verification report

2.3.2.2 Results

	Unit	Simulation Results			Calculated Results		
Frequency	Hz	30	60	120	30	60	120
rTemp	Ω/km	0,94	0,94	0,94	0,94	0,94	0,94
rInternal	Ω/km	0,94	0,94	0,94	0,94	0,94	0,94
vIn	V	325,27	325,27	235,27	325,27	325,27	325,27
vOut	V	69,65	76,42	75,68	69,65	76,42	75,68
v	V	274,74	321,24	400,17	274,74	321,24	400,18
iIn	A	1,41	1,84	2,77	1,41	1,84	2,77
iOut	A	1,31	1,53	1,51	1,39	1,53	1,51
Pin	W	459,7	599,54	900,78	459,71	599,54	900,87
Pout	W	97,83	116,81	114,55	97,83	116,81	114,56
PI	W	285,87	104,54	456,51	465,65	716,32	786,32

2.3.3 Legend: Lines

- rTemp Resistance per line with regards to temperature per distance
- rInternal Total resistance for one line per distance
- vIn Input Voltage from L1in to Vin
- vOut Output Voltage from L1out to Nout
- v Voltage Drop
- iIn Input Current
- iOut Output Current
- Pin Input Power
- Pout Output Power
- PI Power loss

2.4 Junctions and Terminations

2.4.1 Electrical Junction box

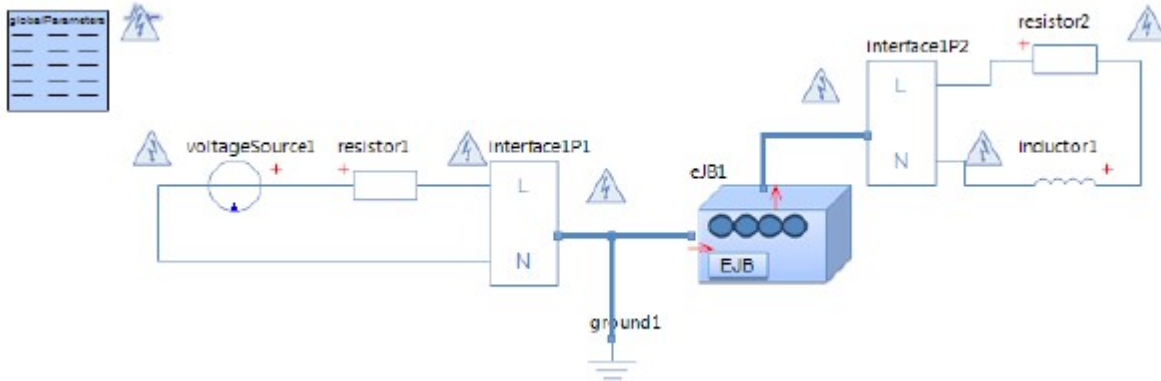

2.4.1.1 Parameters

Internal Parameters			
	Comment:	Name:	Value:
	Parameters for faulty state:	-	-
	<i>Poor or failing L1 connection</i>	bL1	SANN
	<i>Resistance in L1 connection</i>	rL1	1 kΩ
	<i>Conductance between L1 and N</i>	G	50 S

External Parameters			
	Comment:	Name:	Value:
	VoltageSource1	v_src	230 Vrms
	Resistor1	resistor1.R	10 Ω
	Resistor2	resistor2.R	100 Ω
	Inductor1	inductor1.L	100 mH

SimulationX Subsea Electrical Simulation library verification report

2.4.1.2 Results

2.4.1.2.1 True connection

	Unit	Simulation Results			Calculated Results		
Frequency	Hz	30	60	120	30	60	120
vIn	V	296,58	298,94	305,45	296,60	298,90	305,50
vOut	V	296,58	298,94	305,45	296,60	298,90	305,50
v	V	0,00	0,00	0,00	0,00	0,00	0,00
iIn	A	2,91	2,80	2,40	2,90	2,80	2,40
iOut	A	2,91	2,80	2,40	2,90	2,80	2,40
PI	mW	0,00	0,00	0,00	0,00	0,00	0,00

2.4.1.2.2 Faulty connection

	Unit	Simulation Results			Calculated Results		
Frequency	Hz	30	60	120	30	60	120
vIn	mV	649,23	649,23	649,22	649,20	649,20	649,20
vOut	mV	60,05	63,04	73,74	60,05	63,04	73,74
v	mV	590,12	590,86	588,82	590,10	590,90	588,80
iIn	A	32,46	32,46	32,46	32,50	32,50	32,50
iOut	mA	0,59	0,59	0,59	0,59	0,59	0,59
PI	W	21,08	21,08	21,07	21,10	21,10	21,10

2.4.2 Pin Connector Female

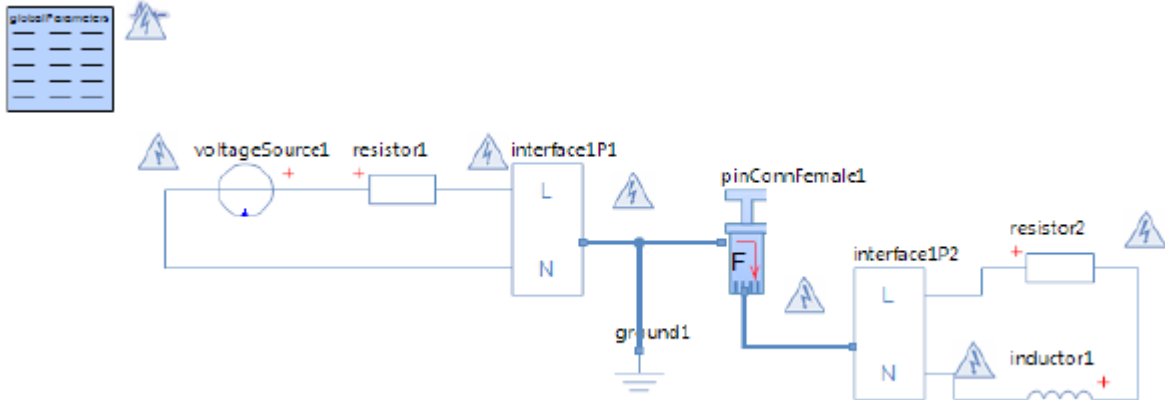

2.4.2.1 Parameters

Internal Parameters			
	Comment:	Name:	Value:
	Parameters for faulty state:	-	-
	<i>Poor or failing L1 connection</i>	bL1	SANN
	<i>Resistance in L1 connection</i>	rL1	1 k Ω
	<i>Conductance between L1 and N</i>	G	50 S

External Parameters			
	Comment:	Name:	Value:
	VoltageSource1	v_src	230 Vrms
	Resistor1	resistor1.R	10 Ω
	Resistor2	resistor2.R	100 Ω
	Inductor1	inductor1.L	100 mH

SimulationX Subsea Electrical Simulation library verification report

2.4.2.2 Results

2.4.2.2.1 True connection

	Unit	Simulation Results			Calculated Results		
Frequency	Hz	30	60	120	30	60	120
vIn	V	296,58	298,94	305,45	296,60	298,90	305,50
vOut	V	296,58	298,94	305,45	296,60	298,90	305,50
v	V	0,00	0,00	0,00	0,00	0,00	0,00
iIn	A	2,91	2,80	2,40	2,90	2,80	2,40
iOut	A	2,91	2,80	2,40	2,90	2,80	2,40
PI	mW	0,00	0,00	0,00	0,00	0,00	0,00

2.4.2.2.2 Faulty connection

	Unit	Simulation Results			Calculated Results		
Frequency	Hz	30	60	120	30	60	120
vIn	mV	649,23	649,23	649,22	649,2	649,2	649,2
vOut	mV	60,05	63,04	73,74	60,05	63,04	73,74
v	mV	590,12	590,86	588,82	590,1	590,9	588,8
iIn	A	32,46	32,46	32,46	32,5	32,5	32,5
iOut	mA	0,59	0,59	0,59	0,59	0,59	0,59
PI	W	21,08	21,08	21,07	21,1	21,1	21,1

2.4.3 Pin Connector Male

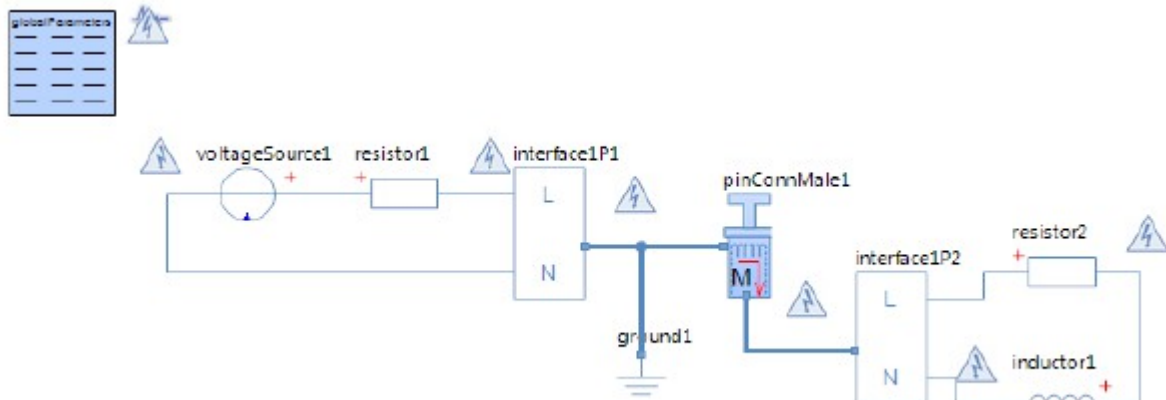

2.4.3.1 Parameters

Internal Parameters			
	Comment:	Name:	Value:
	Parameters for faulty state:	-	-
	<i>Poor or failing L1 connection</i>	bL1	SANN
	<i>Resistance in L1 connection</i>	rL1	1 k Ω
	<i>Conductance between L1 and N</i>	G	50 S

External Parameters			
	Comment:	Name:	Value:
	VoltageSource1	v_src	230 Vrms
	Resistor1	resistor1.R	10 Ω
	Resistor2	resistor2.R	100 Ω
	Inductor1	inductor1.L	100 mH

SimulationX Subsea Electrical Simulation library verification report

2.4.3.2 Results

2.4.3.2.1 True connection

	Unit	Simulation Results			Calculated Results		
Frequency	Hz	30	60	120	30	60	120
vIn	V	296,58	298,94	305,45	296,60	298,90	305,50
vOut	V	296,58	298,94	305,45	296,60	298,90	305,50
v	V	0,00	0,00	0,00	0,00	0,00	0,00
iIn	A	2,91	2,80	2,40	2,90	2,80	2,40
iOut	A	2,91	2,80	2,40	2,90	2,80	2,40
PI	mW	0,00	0,00	0,00	0,00	0,00	0,00

2.4.3.2.2 Faulty connection

	Unit	Simulation Results			Calculated Results		
Frequency	Hz	30	60	120	30	60	120
vIn	mV	649,23	649,23	649,22	649,2	649,2	649,2
vOut	mV	60,05	63,04	73,74	60,05	63,04	73,74
v	mV	590,12	590,86	588,82	590,1	590,9	588,8
iIn	A	32,46	32,46	32,46	32,5	32,5	32,5
iOut	mA	0,59	0,59	0,59	0,59	0,59	0,59
PI	W	21,08	21,08	21,07	21,1	21,1	21,1

2.4.4 Topside Umbilical Termination Unit

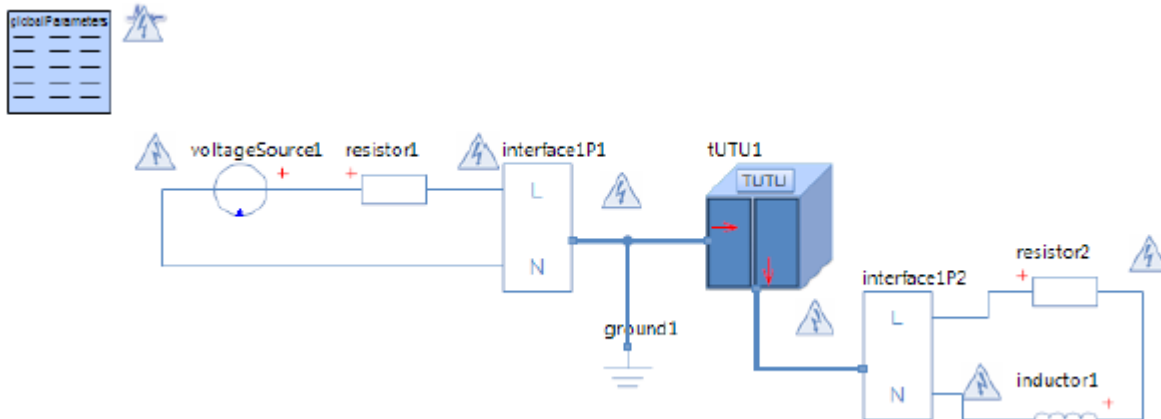

2.4.4.1 Parameters

Internal Parameters			
	Comment:	Name:	Value:
	Parameters for faulty state:	-	-
	Poor or failing L1 connection	bL1	SANN
	Resistance in L1 connection	rL1	1 k Ω
	Conductance between L1 and N	G	50 S

External Parameters			
	Comment:	Name:	Value:
	VoltageSource1	v_src	230 Vrms
	Resistor1	resistor1.R	10 Ω
	Resistor2	resistor2.R	100 Ω
	Inductor1	inductor1.L	100 mH

SimulationX Subsea Electrical Simulation library verification report

2.4.4.2 Results

2.4.4.2.1 True connection

	Unit	Simulation Results			Calculated Results		
Frequency	Hz	30	60	120	30	60	120
vIn	V	296,58	298,94	305,45	296,60	298,90	305,50
vOut	V	296,58	298,94	305,45	296,60	298,90	305,50
v	V	0,00	0,00	0,00	0,00	0,00	0,00
iIn	A	2,91	2,80	2,40	2,90	2,80	2,40
iOut	A	2,91	2,80	2,40	2,90	2,80	2,40
PI	mW	0,00	0,00	0,00	0,00	0,00	0,00

2.4.4.2.2 Faulty connection

	Unit	Simulation Results			Calculated Results		
Frequency	Hz	30	60	120	30	60	120
vIn	mV	649,23	649,23	649,22	649,20	649,20	649,20
vOut	mV	60,05	63,04	73,74	60,05	63,04	73,74
v	mV	590,12	590,86	588,82	590,10	590,90	588,80
iIn	A	32,46	32,46	32,46	32,50	32,50	32,50
iOut	mA	0,59	0,59	0,59	0,59	0,59	0,59
PI	W	21,08	21,08	21,07	21,10	21,10	21,10

2.4.5 Umbilical Termination Head

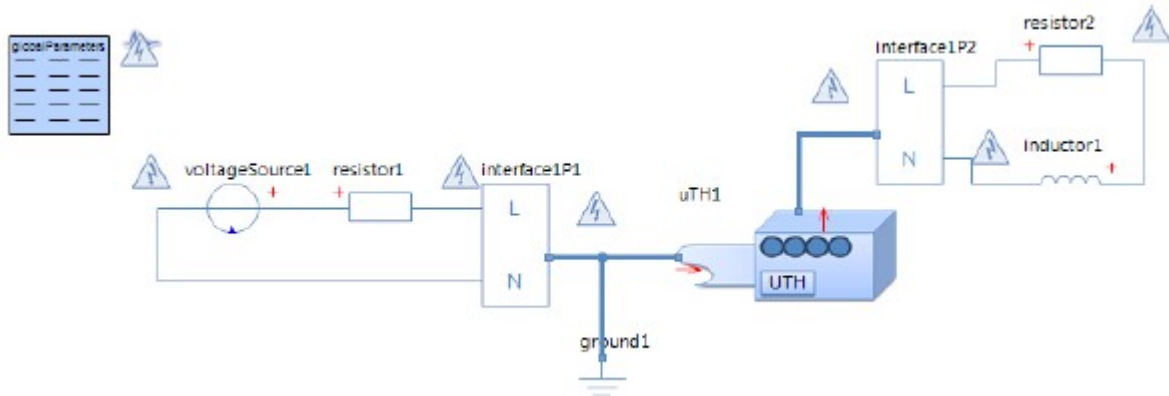

2.4.5.1 Parameters

Internal Parameters			
	Comment:	Name:	Value:
	Parameters for faulty state:	-	-
	<i>Poor or failing L1 connection</i>	bL1	SANN
	<i>Resistance in L1 connection</i>	rL1	1 k Ω
	<i>Conductance between L1 and N</i>	G	50 S

External Parameters			
	Comment:	Name:	Value:
	VoltageSource1	v_src	230 Vrms
	Resistor1	resistor1.R	10 Ω
	Resistor2	resistor2.R	100 Ω
	Inductor1	inductor1.L	100 mH

2.4.5.2 Results**2.4.5.2.1 True connection**

	Unit	Simulation Results			Calculated Results		
Frequency	Hz	30	60	120	30	60	120
vIn	V	296,58	298,94	305,45	296,60	298,90	305,50
vOut	V	296,58	298,94	305,45	296,60	298,90	305,50
v	V	0,00	0,00	0,00	0,00	0,00	0,00
iIn	A	2,91	2,80	2,40	2,90	2,80	2,40
iOut	A	2,91	2,80	2,40	2,90	2,80	2,40
PI	mW	0,00	0,00	0,00	0,00	0,00	0,00

2.4.1.5.2 Faulty connection

	Unit	Simulation Results			Calculated Results		
Frequency	Hz	30	60	120	30	60	120
vIn	mV	649,23	649,23	649,22	649,20	649,20	649,20
vOut	mV	60,05	63,04	73,74	60,05	63,04	73,74
v	mV	590,12	590,86	588,82	590,10	590,90	588,80
iIn	A	32,46	32,46	32,46	32,50	32,50	32,50
iOut	mA	0,59	0,59	0,59	0,59	0,59	0,59
PI	W	21,08	21,08	21,07	21,10	21,10	21,10

2.4.6 Legend: Junctions and Terminations

- vIn Input Voltage from L1 in to Nin
- vOut Output Voltage from L1 out to Nout
- v Voltage Drop
- iIn Input Current
- iOut Output Current
- PI Power Loss

2.5 Miscellaneous

2.5.1 Filter

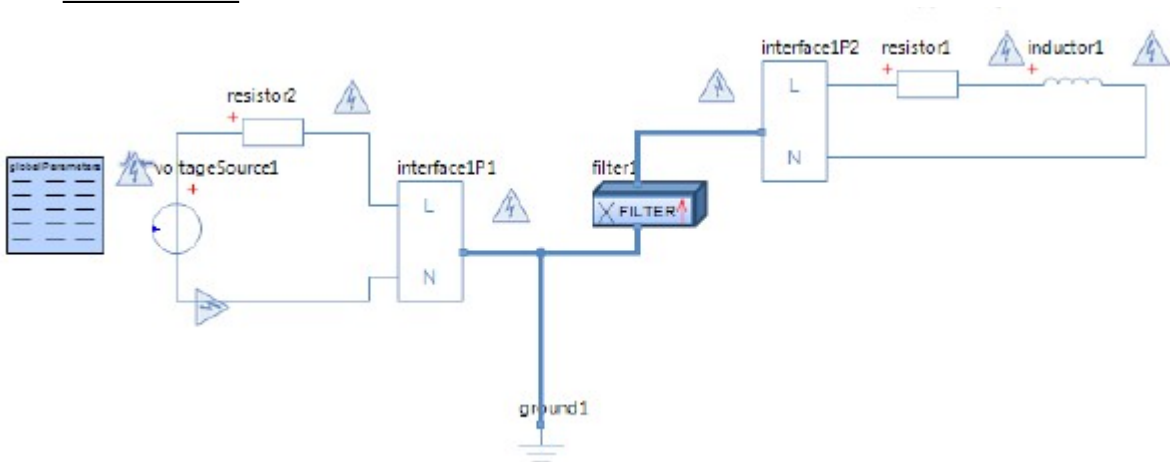

2.5.1.1 Parameters

Internal Parameters			
	Comment:	Name:	Value:
	Conductance	G	10^{-5} S

External Parameters			
	Comment:	Name:	Value:
	VoltageSource1	v_src	230 Vrms
	Resistor1	resistor1.R	100 Ω
	Resistor2	resistor2.R	10 Ω
	Inductor1	inductor1.L	5 mH

SimulationX Subsea Electrical Simulation library verification report

2.5.1.2 Results

	Unit	Simulation Results			Calculated Results		
Frequency	Hz	30	60	120	30	60	120
vIn	V	325,24	325,24	325,24	325,24	325,24	325,24
iIn	mA	3,25	3,25	3,25	3,25	3,25	3,25
PIn	W	1,06	1,06	1,06	1,06	1,06	1,06
PI	W	1,06	1,06	1,06	1,06	1,06	1,06

2.5.1.3 Legend

- Vin Input voltage from L1p to nP
- iIn Input current
- Pin Input power
- PI Powerloss

2.5.2 RMS Calculator

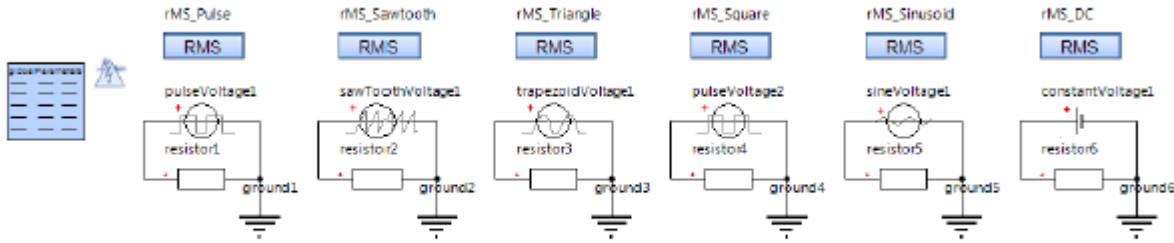

2.5.2.1 Parameters

Internal Parameters			
	Comment:	Name:	Value:
	Input Signal	s	resistor1.v
	Signal Frequency	sf	60;120;1200 Hz

External Parameters			
	Comment:	Name:	Value:
	VoltageSource1	v_src	230 Vrms
	Resistor1	resistor1.R	1 K Ω

2.5.2.2 Results

	Unit	Simulation Results			Calculated Results		
Frequency	Hz	60	120	1200	60	120	1200
DC		230,00	230,00	230,00	230,00	230,00	230,00
Sinusoid		162,80	162,80	162,80	162,63	162,63	162,63
Square		162,64	162,64	162,64	230,00	230,00	230,00
Triangel		132,80	132,80	132,80	132,80	132,80	132,80
Sawtooth		132,80	132,80	132,80	132,80	132,80	132,80
Pulse train (20%)		102,86	102,86	102,86	102,90	102,90	102,90

2.5.3 Transformer

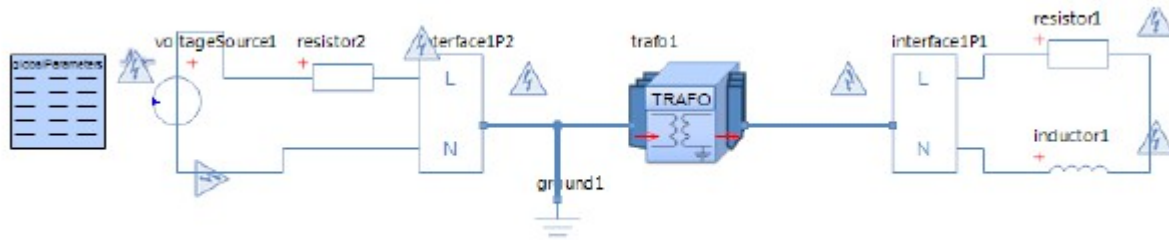

2.5.3.1 Parameters

Internal Parameters			
	Comment:	Name:	Value:
	Primary Inductance	L1	400 mH
	Initial Value	i10	0 A
	Secondary Inductance	L2	800 mH
	Initial Value	i20	0 A
	Mutual Coupling Inductance	M	$0.75 \cdot \sqrt{L1 \cdot L2}$
	Additional Parameters for lossy state:	-	-
	<i>Primary Winding Resistance</i>	R1	5 Ω
	<i>Secondary Winding Resistance</i>	R2	5 Ω
	<i>Ironloss Resistance</i>	Rfe	50 kΩ

External Parameters			
	Comment:	Name:	Value:
	VoltageSource1:	v_src	230 Vrms
	Resistor1:	resistor1.R	50 Ω
	Resistor2:	resistor2.R	10 Ω
	Inductor1:	inductor.L	10 mH

SimulationX Subsea Electrical Simulation library verification report

2.5.3.2 Results

2.5.3.2.1 Lossless

	Unit	Simulation Results			Calculated Results		
Frequency	Hz	30	60	120	30	60	120
n		0,71	0,71	0,71	0,71	0,71	0,71
k		0,75	0,75	0,75	0,75	0,75	0,75
vIn	V	294,21	313,87	322,02	294,21	313,87	322,02
iIn	A	7,44	4,45	2,37	7,44	4,45	2,37
Pin	W	2188,24	1397,64	763,42	2188,92	1396,72	763,19
vOut	V	185,24	115,42	62,58	185,24	115,42	62,58
iOut	A	3,70	2,30	1,24	3,7	2,3	1,24
POut	W	685,57	265,28	77,01	685,4	265,47	77,6
PI	W	0,00	0,00	0,00	0,00	0,00	0,00
Pmag	W	1658,56	1268,06	735,74	1658,57	1269,12	735,74

2.5.3.2.2 Lossy

	Unit	Simulation Results			Calculated Results		
Frequency	Hz	30	60	120	30	60	120
n		0,71	0,71	0,71	0,71	0,71	0,71
k		0,75	0,75	0,75	0,75	0,75	0,75
vIn	V	289,90	310,96	321,00	289,90	310,96	321,00
iIn	A	6,82	4,30	2,35	6,82	4,30	2,35
Pin	W	1978,28	1336,57	753,08	1978,29	1336,57	753,09
vOut	V	168,21	111,06	61,87	168,21	111,06	61,87
iOut	A	3,36	2,22	1,22	3,36	2,22	1,22
POut	W	565,21	245,65	75,27	565,50	246,01	75,69
PI	W	284,23	116,39	34,99	278,60	115,42	34,55
Pmag	W	1380,00	1175,14	716,16	1380,00	1175,16	719,16

2.5.3.3 Legend: Transformer

- n Turn Ratio
- k Coefficient of Coupling
- vIn Input Voltage from L1 in to Nin
- iIn Input Current
- Pin Input Power
- vOut Output Voltage from L1 out to Nout
- iOut Output Current
- POut Output power
- PI Power Loss
- Pmag Magnetic Power

3. Signal Calculation

The simulations of the Subsea Electrical Simulation Library, will when set to Signal, handle its calculations with RMS values.

All values should therefore be regarded as RMS values, unless otherwise stated.

Actual simulation results can be found in the attachment “Simulation results SIGNAL.pdf”.

3.1 Sources

3.1.1 Electrical Power Unit

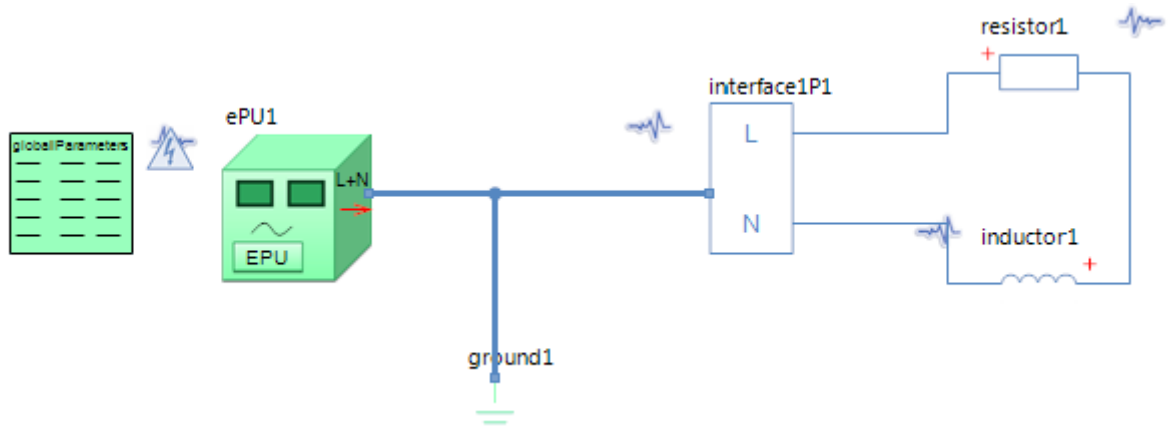

3.1.1.1 Parameters

Internal Parameters			
	Comment:	Name:	Value:
	Internal Resistance L1	RL	5 Ω
	Internal Resistance N	RN	5 Ω
	Sine Wave RMS Voltage	VrmsSrcSig	230 V
	Voltage Offset	offsetSig	0
	Voltage Phase Angle	phiV	0

External Parameters			
	Comment:	Name:	Value:
	Resistor1	resistor1.R	100 Ω
	Inductor1	inductor1.L	100 mH

SimulationX Subsea Electrical Simulation library verification report

3.1.1.2 Results

	Unit	Simulation Results			Calculated Results		
Frequency	Hz	30	60	120	30	60	120
VrmsOut	V	209,72	211,39	215,99	209,70	211,40	216,00
vReOut	V	209,69	211,29	215,77	206,10	197,80	172,50
vImOut	V	3,48	6,41	9,75	38,80	74,60	130,00
IrmsOut	A	2,06	1,98	1,72	2,10	2,00	1,70
iReOut	A	2,03	1,87	1,42	2,02	1,84	1,34
iImOut	A	-0,35	-0,64	-0,98	-0,38	-0,69	-1,01
phiVOut		0,95	1,74	2,59			
phiIOut		-9,72	-18,92	-34,43			
phiIVOut		10,67	20,66	37,02	10,70	20,70	37,00
PReOut	W	424,72	391,24	297,44	424,80	391,25	297,60
PImOut	W	80,06	147,49	224,27	80,01	147,50	224,40
SOut	V	432,20	418,12	372,52	432,20	418,10	372,50

3.1.1.3 Legend Electrical Power Unit

- VrmsOut Output Voltage RMS
- vReOut Output Voltage (Real Part) from L1 to N
- vImOut Output Voltage (Imaginary Part) From L1 to N
- IrmsOut Output Current RMS
- iReOut Output Current (Real Part)
- iImOut Output Current (Imaginary Part)
- phiVOut Output Voltage Phase Angle
- phiIOut Output Current Phase Angle
- phiIVOut Output Current Phase Angle with reference to Voltage
- PReOut Effective Output Current
- PImOut Reactive Output Current
- SOut Apparent Output Power

3.1.2 Modem

Sending:

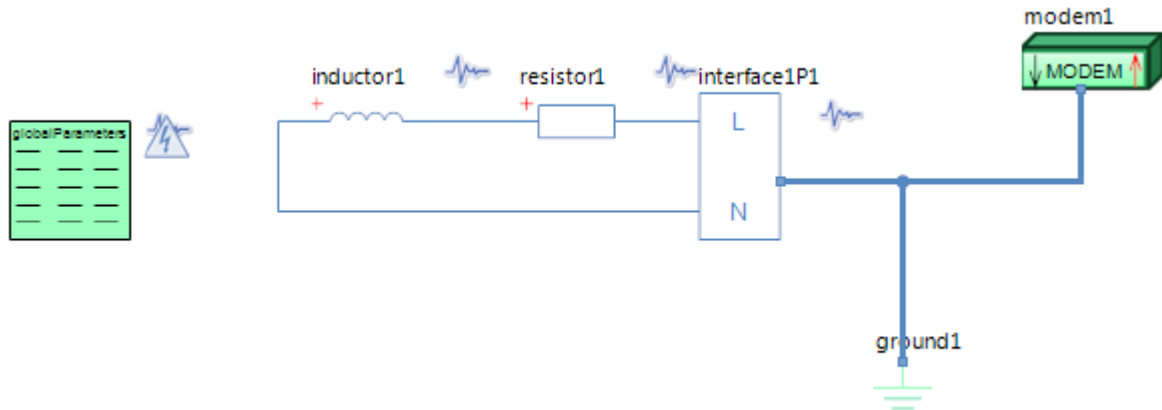

Receiving:

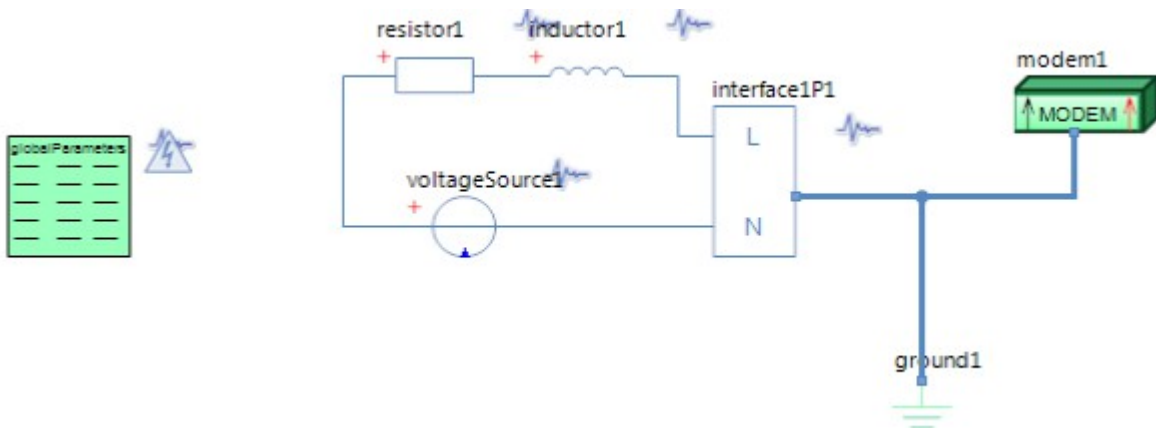

3.1.2.1 Parameters**Sending:**

Internal Parameters			
	Comment:	Name:	Value:
	Output Resistance	Rout	11 Ω
	Signal	VrmsSrcSig;P	5V; 0.1VA

External Parameters			
	Comment:	Name:	Value:
	Resistor1	resistor.R	1500 Ω
	Inductor1	inductor.L	5mH

Receiving:

Internal Parameters			
	Comment:	Name:	Value:
	Input Resistance	Rin	1900 Ω

External Parameters			
	Comment:	Name:	Value:
	VoltageSource1	v_src	10 V
	Resistor1	resistor.R	500 Ω
	Inductor1	inductor.L	5 mH

SimulationX Subsea Electrical Simulation library verification report

3.1.2.2 Results

3.1.2.2.1 Sending Voltage

	Unit	Simulation Results			Calculated Results		
Frequency	kHz	4	20	100	4	20	100
VrmsIn	V	4,96	4,97	4,99	4,96	4,97	4,99
vReIn	V	4,96	4,97	4,99	4,95	4,58	2,15
vImIn	V	0,00	0,01	0,01	0,41	1,92	4,51
IrmsIn	mA	3,30	3,06	1,43	3,30	3,10	1,43
iReIn	mA	-3,29	-2,82	-0,62	3,28	-2,82	-0,62
iImIn	mA	0,27	1,17	1,30	0,27	1,17	1,29
phiVIn		0,03	0,15	0,16	0,03	0,15	0,16
phiIIn		175,25	57,42	115,69	175,3	57,4	115,7
phiIVIn		-175,21	-157,27	-116,52	-175,2	-157,26	-116,5
PReIn	mW	-16,31	-14,00	-3,09	-16,30	-14,00	-3,08
PIImIn	mW	-1,37	-5,07	-6,46	-1,35	-5,90	-6,46
Sin	mVA	16,37	15,18	7,16	16,37	15,18	7,16

3.1.2.2.2 Sending Power

	Unit	Simulation Results			Calculated Results		
Frequency	kHz	4	20	100	4	20	100
VrmsIn	V	12,22	12,71	18,65	12,22	12,71	18,65
vReIn	V	12,22	12,71	18,65	12,22	12,71	18,65
vImIn	V	0,01	0,03	0,05	0,01	0,03	0,05
IrmsIn	mA	8,12	7,82	5,36	8,12	7,82	5,36
iReIn	mA	-8,09	-7,22	-2,32	8,09	7,22	2,32
iImIn	mA	0,67	3,00	4,83	-0,67	-3	-4,83
phiVIn		0,03	0,15	0,16	0,03	0,15	0,16
phiIIn		174,25	157,42	115,69	175,3	57,4	115,7
phiIVIn		-175,21	-157,27	-115,52	-175,2	-157,26	-116,5
PReIn	mW	-98,93	-91,66	-43,03	98,93	91,66	43,03
PIImIn	mW	-8,29	-38,40	-90,12	8,29	38,4	90,12
Sin	mVA	99,28	99,38	99,86	99,28	99,38	99,86

3.1.2.2.3 Receiving

	Unit	Simulation Results			Calculated Results		
Frequency	kHz	4	20	100	4	20	100
VrmsIn	V	7,91	7,66	4,81	7,9	7,66	4,8

SimulationX Subsea Electrical Simulation library verification report

vReIn	V	7,90	7,41	2,92	7,90	7,41	2,92
vImIn	V	-0,41	-1,94	-3,82	-0,41	-1,94	-3,82
IrmssIn	mA	4,16	4,03	2,53	4,16	4,03	2,53
iReIn	mA	4,16	3,90	1,54	4,16	3,9	1,54
iImIn	mA	-0,22	-1,02	-2,01	-0,22	-1,02	-2,01
phiVIn		-3,00	-14,67	-52,62	-3	-14,67	-52,62
phiIIn		-3,00	-14,67	-52,62	-3	-14,67	-52,62
phiIVIn		0,00	0,00	0,00	0	0	0
PReIn	W	32,90	30,87	12,16	32,91	30,87	12,17
PImIn	W	0,00	0,00	0,00	0	0	0
Sin	VA	32,90	30,87	12,16	32,91	30,87	12,17

3.1.2.3 Legend: Modem

- VrmsIn Voltage RMS
- vReIn Voltage (Real Part) From Ls to Ns
- vImIn Voltage (Imaginary Part) From Ls to Ns
- IrmssIn Input Current RMS
- iReIn Input Current (Real Part)
- iImIn Input Current (Imaginary Part)
- phiVIn Input Voltage Phase Angle
- phiIIn Input Current Phase Angle
- phiIVIn Input Current Phase Angle with reference to Voltage
- PReIn Effective Input Power
- PImIn Reactive Input Power
- Sin Apparent Input Power

3.2 Loads

3.2.1 Multiphase Flow Meter

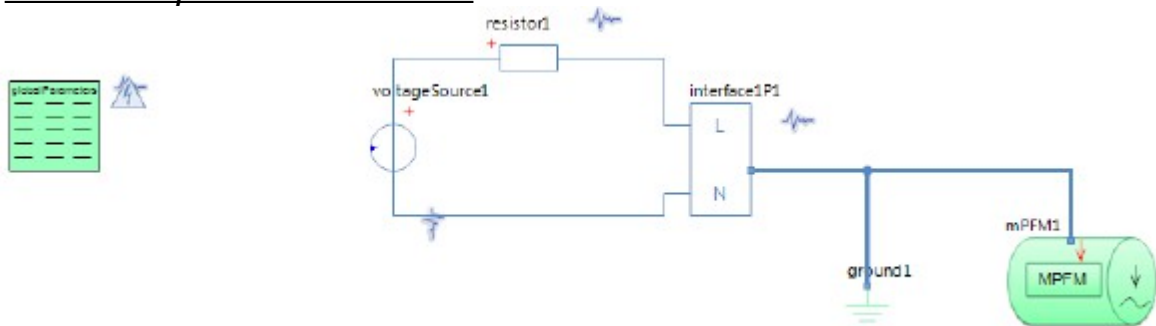

3.2.1.1 Parameters

Internal Parameters			
	Comment:	Name:	Value:
	Simulate with internal Transformer	trafoOn	USANN
	SCM input Frequency	fIn	60;120;240 Hz
	Constant or Variable Power	pType	Constant Power
	Output Power from PSU in MPFM	P	100 VA
	PSU Power Factor	pf	0,7
	PSU turn-off RMS Voltage	vMin	130 V
	PSU turn-on RMS Voltage	vMax	180 V

External Parameters			
	Comment:	Name:	Value:
	VoltageSource1	v_src	230 V
	Resistor1:	resistor1.R	50 Ω

SimulationX Subsea Electrical Simulation library verification report

3.2.1.2 Results

3.2.1.2.1 EPU sending

	Unit	Simulation Results			Calculated Results		
Frequency (Hz)		60	120	240	60	120	240
Rload	Ω	204,21	204,21	204,21	204,21	204,21	204,21
Cload	μF	12,73	6,37	3,18	12,73	6,37	3,18
PsetX2	W	285,71	285,71	285,71	285,70	285,77	285,64
Pset	W	142,86	142,86	142,86	142,85	142,88	142,82
PCalc	VA	100,00	100,00	100,00	100,00	100,00	100,00
VrmsIn	V	204,15	204,15	204,15	204,15	204,13	204,17
vReIn	V	202,94	202,94	202,95	202,94	202,93	202,96
vImIn	V	-22,18	-22,18	-22,18	-22,18	-22,18	-22,18
IrmsIn	A	0,70	0,70	0,70	0,70	0,70	0,70
iReIn	A	0,54	0,54	0,54	0,54	0,54	0,54
iImIn	A	0,44	0,44	0,44	0,44	0,44	0,44
phiVIn		-6,24	-6,24	-6,24			
phiIIn		39,34	39,34	39,34			
phiIVIn		-45,57	-45,27	-45,27			
PReIn	W	100,00	100,00	100,00	99,99	100,00	99,92
PIIn	W	-102,02	-102,02	-102,02	-102,02	-102,00	-102,04
SIn	VA	142,86	142,86	142,86	142,85	142,88	142,82
VrmsLoad	V	204,15	204,15	204,15	204,15	204,13	204,17
vReLoad	V	202,94	202,94	202,94	202,94	202,93	202,96
vImLoad	V	-22,18	-22,18	-22,18	-22,18	-22,18	-22,18
IrmsLoad	A	0,70	0,70	0,70	0,70	0,70	0,70
iReLoad	A	0,54	0,54	0,54	0,54	0,54	0,54
iImLoad	A	0,44	0,44	0,44	0,44	0,44	0,44
phiVLoad		-6,24	-6,24	-6,24			
phiILoad		39,34	39,34	39,34			
phiIVLoad		-45,57	-45,57	-45,57			
PReLoad	W	100,00	100,00	100,00	99,99	100,00	99,92
PILoad	W	-102,02	-102,02	-102,02	-102,02	-102,00	-102,04
Sload	VA	142,86	142,86	142,86	142,85	142,88	142,82

3.2.1.2.2 Modem sending

	Unit	Simulation Results			Calculated Results		
Frequency (Hz)		60	120	240	60	120	240

SimulationX Subsea Electrical Simulation library verification report

Rload	KΩ	10,00	10,00	10,00	10,00	10,00	10,00
Cload	μF	0,00	0,00	0,00	0,00	0,00	0,00
PsetX2	W	0,00	0,00	0,00	0,00	0,00	0,00
Pset	W	0,00	0,00	0,00	0,00	0,00	0,00
PCalc	VA	0,00	0,00	0,00	0,00	0,00	0,00
VrmsIn	V	230,00	230,00	230,00	230,00	230,00	230,00
vReIn	V	0,00	0,00	0,00	0,00	0,00	0,00
vImIn	V	0,00	0,00	0,00	0,00	0,00	0,00
IrmsIn	A	0,00	0,00	0,00	0,00	0,00	0,00
iReIn	A	0,00	0,00	0,00	0,00	0,00	0,00
iImIn	A	0,00	0,00	0,00	0,00	0,00	0,00
phiVIn		0,00	0,00	0,00	0,00	0,00	0,00
phiIIn		0,00	0,00	0,00	0,00	0,00	0,00
phiIVIn		0,00	0,00	0,00	0,00	0,00	0,00
PReIn	W	0,00	0,00	0,00	0,00	0,00	0,00
PImIn	W	0,00	0,00	0,00	0,00	0,00	0,00
SIn	VA	0,00	0,00	0,00	0,00	0,00	0,00
VrmsLoad	V	0,00	0,00	0,00	0,00	0,00	0,00
vReLoad	V	0,00	0,00	0,00	0,00	0,00	0,00
vImLoad	V	0,00	0,00	0,00	0,00	0,00	0,00
IrmsLoad	A	0,00	0,00	0,00	0,00	0,00	0,00
iReLoad	A	0,00	0,00	0,00	0,00	0,00	0,00
iImLoad	A	0,00	0,00	0,00	0,00	0,00	0,00
phiVLoad		0,00	0,00	0,00	0,00	0,00	0,00
phiILoad		0,00	0,00	0,00	0,00	0,00	0,00
phiIVLoad		0,00	0,00	0,00	0,00	0,00	0,00
PReLoad	W	0,00	0,00	0,00	0,00	0,00	0,00
PImLoad	W	0,00	0,00	0,00	0,00	0,00	0,00
Sload	VA	0,00	0,00	0,00	0,00	0,00	0,00

3.2.1.2.3 Variable power

40 VARsm → 150 VARsm → 40 VARsm

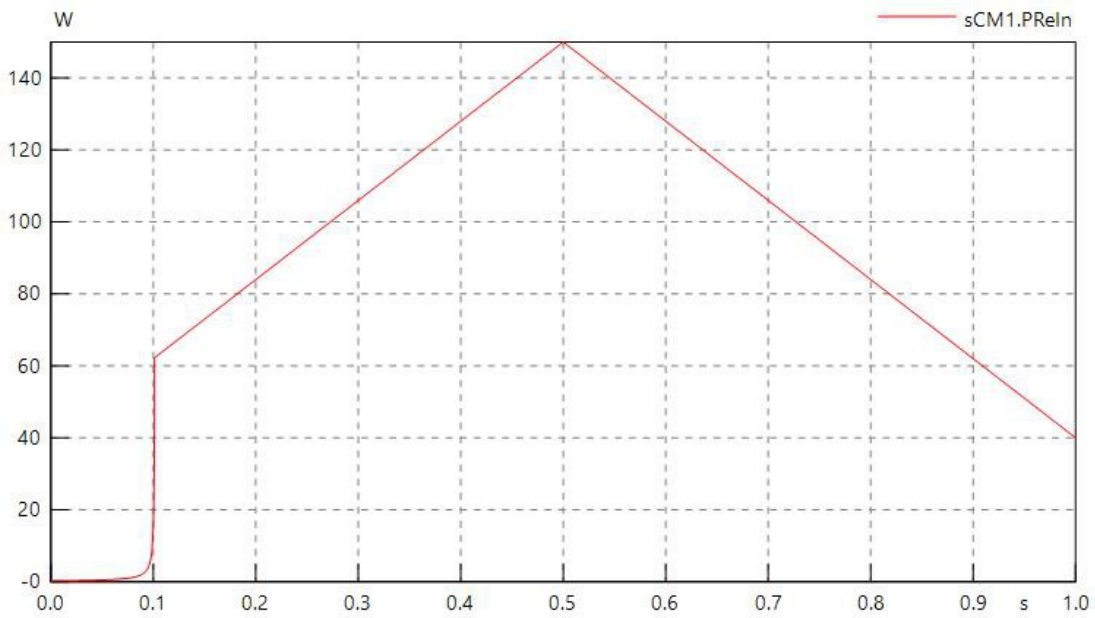

The chart clearly shows how the MPFM unit increases its powerload gradually, after the startup delay, from 40 to 150, until $t=0.5s$, where it begins dropping down to 40VA at $t=1.0s$.

3.2.2 Subsea Control Module

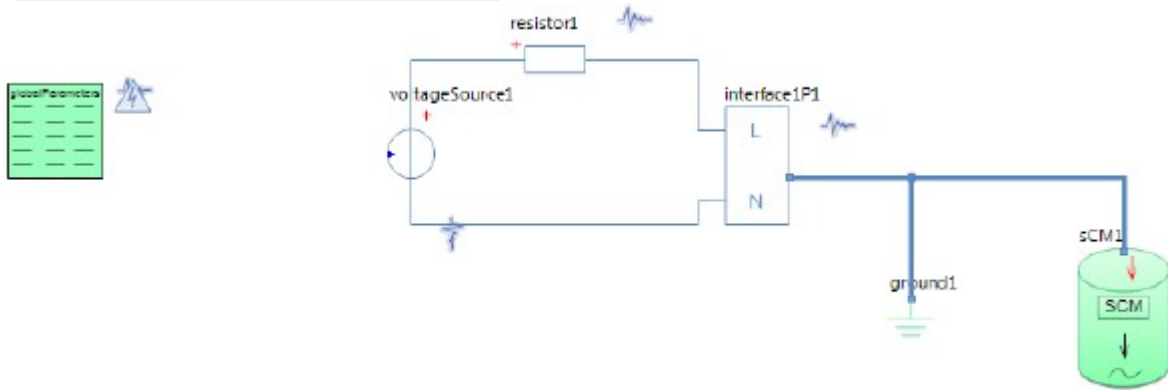

3.2.2.1 Parameters

Internal Parameters			
	Comment:	Name:	Value:
	Simulate with internal Transformer	trafoOn	USANN
	SCM input Frequency	fIn	60;120;240 Hz
	Constant or Variable Power	pType	Constant Power
	Output Power from PSU in SCM	P	100 VA
	PSU Power Factor	pf	0,7
	PSU turn-off RMS Voltage	vMin	130 V
	PSU turn-on RMS Voltage	vMax	180 V

External Parameters			
	Comment:	Name:	Value:
	VoltageSource1	v_src	230 V
	Resistor1:	resistor1.R	50 Ω

SimulationX Subsea Electrical Simulation library verification report

3.2.2.2 Results

3.2.2.2.1 EPU sending

	Unit	Simulation Results			Calculated Results		
Frequency (Hz)		60	120	240	60	120	240
Rload	Ω	204,21	204,21	204,21	204,21	204,21	204,21
Cload	μF	12,73	6,37	3,18	12,73	6,37	3,18
PsetX2	W	285,71	285,71	285,71	204,21	204,21	204,21
Pset	W	142,86	142,86	142,86	12,73	6,37	3,18
PCalc	VA	100,00	100,00	100,00	285,70	285,77	285,64
VrmsIn	V	204,15	204,15	204,15	142,85	142,88	142,82
vReIn	V	202,94	202,94	202,95	100,00	100,00	100,00
vImIn	V	-22,18	-22,18	-22,18	204,15	204,13	204,17
IrmsIn	A	0,70	0,70	0,70	202,94	202,93	202,96
iReIn	A	0,54	0,54	0,54	-22,18	-22,18	-22,18
iImIn	A	0,44	0,44	0,44	0,70	0,70	0,70
phiVIn		-6,24	-6,24	-6,24	0,54	0,54	0,54
phiIIn		39,34	39,34	39,34	0,44	0,44	0,44
phiIVIn		-45,57	-45,27	-45,27			
PReIn	W	100,00	100,00	100,00			
PImIn	W	-102,02	-102,02	-102,02			
SIn	VA	142,86	142,86	142,86	99,99	100,00	99,92
VrmsLoad	V	204,15	204,15	204,15	-102,02	-102,00	-102,04
vReLoad	V	202,94	202,94	202,94	142,85	142,88	142,82
vImLoad	V	-22,18	-22,18	-22,18	204,15	204,13	204,17
IrmsLoad	A	0,70	0,70	0,70	202,94	202,93	202,96
iReLoad	A	0,54	0,54	0,54	-22,18	-22,18	-22,18
iImLoad	A	0,44	0,44	0,44	0,70	0,70	0,70
phiVLoad		-6,24	-6,24	-6,24	0,54	0,54	0,54
phiILoad		39,34	39,34	39,34	0,44	0,44	0,44
phiIVLoad		-45,57	-45,57	-45,57			
PReLoad	W	100,00	100,00	100,00			
PImLoad	W	-102,02	-102,02	-102,02			
Sload	VA	142,86	142,86	142,86	99,99	100,00	99,92

3.2.2.2.2 Modem sending

	Unit	Simulation Results			Calculated Results		
Frequency (Hz)		60	120	240	60	120	240

SimulationX Subsea Electrical Simulation library verification report

Rload	K Ω	10,00	10,00	10,00	10,00	10,00	10,00
Cload	μ F	0,00	0,00	0,00	0,00	0,00	0,00
PsetX2	W	0,00	0,00	0,00	0,00	0,00	0,00
Pset	W	0,00	0,00	0,00	0,00	0,00	0,00
PCalc	VA	0,00	0,00	0,00	0,00	0,00	0,00
VrmsIn	V	230,00	230,00	230,00	230,00	230,00	230,00
vReIn	V	0,00	0,00	0,00	0,00	0,00	0,00
vImIn	V	0,00	0,00	0,00	0,00	0,00	0,00
IrmsIn	A	0,00	0,00	0,00	0,00	0,00	0,00
iReIn	A	0,00	0,00	0,00	0,00	0,00	0,00
iImIn	A	0,00	0,00	0,00	0,00	0,00	0,00
phiVIn		0,00	0,00	0,00	0,00	0,00	0,00
phiIIn		0,00	0,00	0,00	0,00	0,00	0,00
phiIVIn		0,00	0,00	0,00	0,00	0,00	0,00
PReIn	W	0,00	0,00	0,00	0,00	0,00	0,00
PImIn	W	0,00	0,00	0,00	0,00	0,00	0,00
SIn	VA	0,00	0,00	0,00	0,00	0,00	0,00
VrmsLoad	V	0,00	0,00	0,00	0,00	0,00	0,00
vReLoad	V	0,00	0,00	0,00	0,00	0,00	0,00
vImLoad	V	0,00	0,00	0,00	0,00	0,00	0,00
IrmsLoad	A	0,00	0,00	0,00	0,00	0,00	0,00
iReLoad	A	0,00	0,00	0,00	0,00	0,00	0,00
iImLoad	A	0,00	0,00	0,00	0,00	0,00	0,00
phiVLoad		0,00	0,00	0,00	0,00	0,00	0,00
phiILoad		0,00	0,00	0,00	0,00	0,00	0,00
phiIVLoad		0,00	0,00	0,00	0,00	0,00	0,00
PReload	W	0,00	0,00	0,00	0,00	0,00	0,00
PImLoad	W	0,00	0,00	0,00	0,00	0,00	0,00
Sload	VA	0,00	0,00	0,00	0,00	0,00	0,00

3.2.2.2.3 Variable power

40 VArsm → 150 VArsm → 40 VArsm

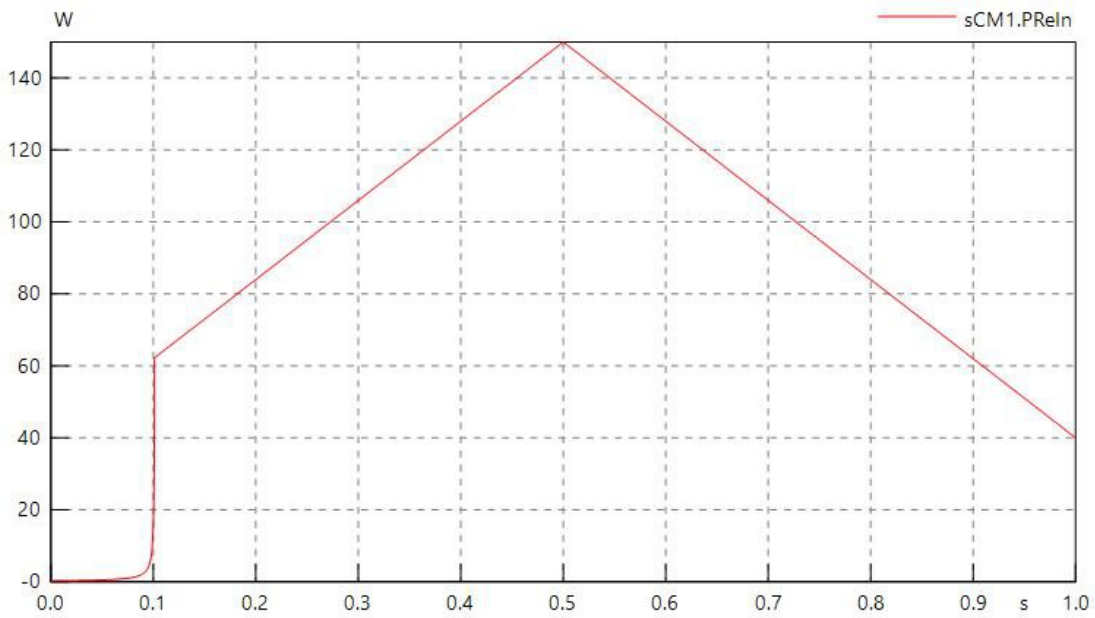

The chart clearly shows how the SCM unit increases its powerload gradually, after the startup delay, from 40 to 150, until t=0.5s, where it begins dropping down to 40VA at t=1.0s.

3.2.3 Legend: Loads

- Rload PSU Resistance
- Cload PSU Capacitance
- PsetX2 Set Power Signal Including Power Factor * 2
- Pset Set Power Signal Including Power Factor
- PCalc Output Power from PSU to MPFM
- VrmsIn Input Voltage RMS
- vReIn Input Voltage (Real Part) from L1 to N
- VimIn Input Voltage (Imaginary Part) From L1 to N
- IrmsIn Input Current RMS (IrmsIn)
- iReIn Input Current (Real Part)
- ilmIn Input Current (Imaginary Part)
- phiVIn Input Voltage Phase Angle
- phiIIn Input Current Phase Angle
- phiIVIn Input Current Phase Angle with reference to Voltage
- PReIn Effective Input Power
- PImIn Reactive Input Power
- SIn Apparent Input Power
- VrmsLoad PSU Input Voltage RMS
- vReLoad PSU Input Voltage (Real Part)
- vImLoad PSU Input Voltage (Imaginary Part)
- IrmsLoad PSU Input Current RMS
- iReLoad PSU Input Current (Real Part)
- ilmLoad PSU Input current (Imaginary Part)
- phiVLoad PSU Input Voltage Phase Angle
- phiILoad PSU Input Current Phase Angle
- phiIVLoad PSU Input Current Phase Angle with reference to Voltage
- PReLoad Effective PSU Input Power
- PImLoad Reactive PSU Input Power
- Sload Apparent PSU Input Power

3.3 Lines

3.3.1 Jumper

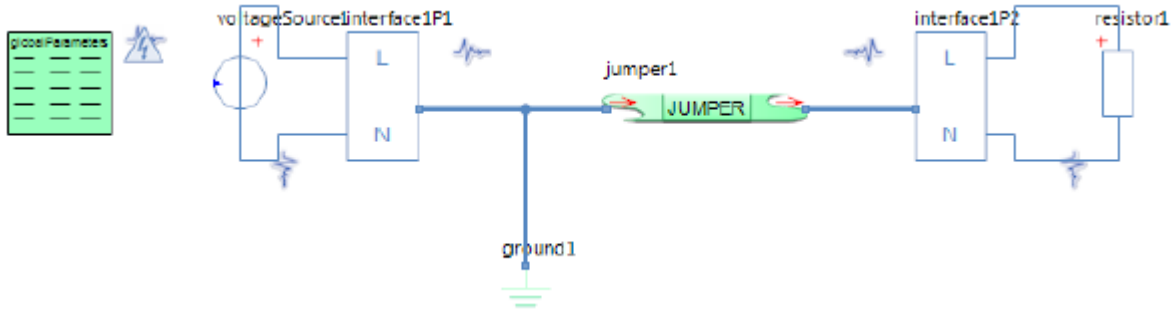

3.3.1.1 Parameters

Internal Parameters			
	Comment:	Name:	Value:
	Resistance per length for each Line at 20°C	r	1 Ω/km
	Inductance per length for each Line	l	0.5 mH/km
	Conductance per length between Lines	g	10 ⁻¹⁰ Ω/m
	Capacitance per length between Lines	c	0.1 μF/km
	Length of Jumper for each Line	length	10 km
	Temperature of the conductor	temp	5 °C
	Skin effect	skinEff	
	Conductor area	area	6 mm ²

External Parameters			
	Comment:	Name:	Value:
	VoltageSource1	v_src	230 V
	Resistor1	resistor1.R	100 Ω

SimulationX Subsea Electrical Simulation library verification report

3.3.1.2 Results

	Unit	Simulation Results			Calculated Results		
Frequency	Hz	60	4K	100K	60	4K	100K
rTemp	Ω/Km	0,94	0,94	0,94	0,94	0,94	0,94
SkinDept	mm	4,88	0,60	0,12	4,88	0,60	0,12
diameter	mm	2,76	2,76	2,76	2,76	2,76	2,76
resistivity	mΩm	5.65*10 ⁻⁶	5.65*10 ⁻⁶	5.65*10 ⁻⁶	5.65*10 ⁻⁶	5.65*10 ⁻⁶	5.65*10 ⁻⁶
rInternal	Ω	0,94	1,39	5,68	0,94	1,39	5,68
VrmsIn	V	230,00	230,00	230,00	230,00	230,00	230,00
vReIn	V	230,00	230,00	230,00	230,00	230,00	230,00
vImIn	V	0,00	0,00	0,00	0,00	0,00	0,00
VrmsOut	V	193,58	204,11	130,28			
vReOut	V	193,46	-162,93	130,28			
vImOut	V	-6,76	-122,94	0,07			
Vrms	V	37,16	411,71	99,72			
vRe	V	36,54	392,93	99,72			
vIm	V	6,76	122,94	-0,07			
IrmsIn	A	1,94	2,39	2,30			
iReIn	A	1,94	2,39	2,30			
iImIn	mA	12,27	141,93	14,12			
IrmsOut	A	1,94	2,04	1,30			
iReOut	A	-1,93	1,63	-1,30			
iImOut	A	67.55*10 ⁻³	1,23	0,00			
phiVIn		0,00	0,00	0,00			
phiIIn		0,36	2,52	0,35			
phiVIn		-0,36	-2,52	0,35			
phiVOut		-2,00	-142,96	0,03			
phiIOut		178,00	37,04	-179,97			
phiVOut		-180,00	-180,00	180,00			
PhiVL1		10,47	17,37	-0,04			
phiIL1		-0,82	-56,10	0,24			
phiIVL1		11,29	73,47	-0,27			
PReIn	W	445,31	548,54	528,95			
PImIn	W	-2,82	-24,13	-3,25			
SIn	VA	445,32	549,07	528,96			
PReOut	W	-374,73	-416,61	-169,73			

SimulationX Subsea Electrical Simulation library verification report

PImOut	mW	0,00	0,00	0,00			
SOut	VA	374,73	416,61	169,74			
Pre	mW	0,00	0,00	0,00			
PIm		0,00	0,00	0,00			
S		0,00	0,00	0,00			
dB	dB	-1,50	-1,04	-4,94			

3.3.2 Umbilical

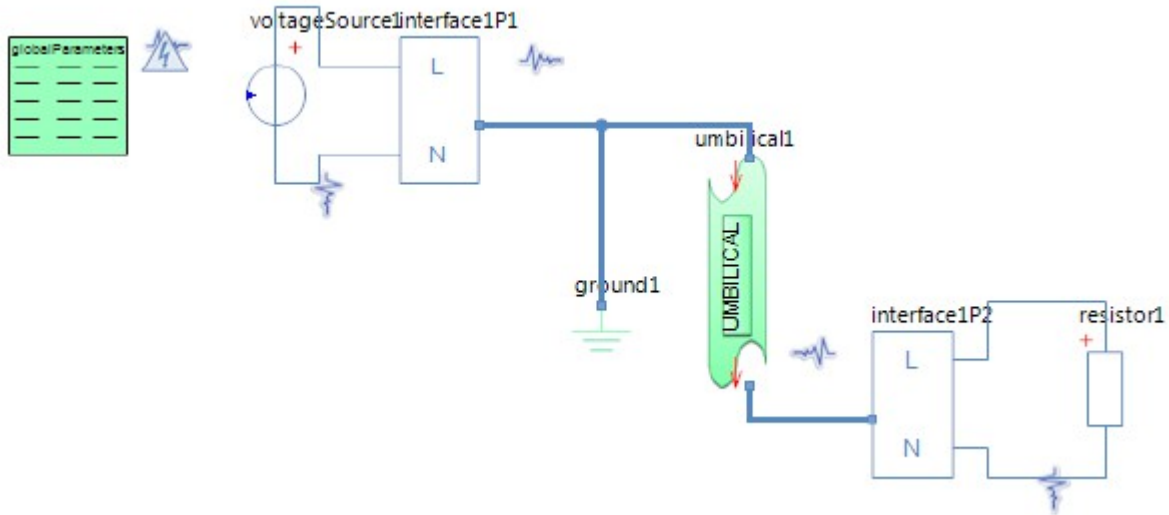

3.3.2.1 Parameters

Internal Parameters			
	Comment:	Name:	Value:
	Resistance per length for each Line at 20°C	r	1 Ω/km
	Inductance per length for each Line	l	0.5 mH/km
	Conductance per length between Lines	g	10 ⁻¹⁰ Ω/m
	Capacitance per length between Lines	c	0.1 μF/km
	Length of Jumper for each Line	length	10 km
	Temperature of the conductor	temp	5 °C
	Skin effect	skinEff	
	Conductor area	area	6 mm ²

External Parameters			
	Comment:	Name:	Value:
	VoltageSource1	v_src	230 V
	Resistor1	resistor1.R	100 Ω

SimulationX Subsea Electrical Simulation library verification report

3.3.2.2 Results

	Unit	Simulation Results			Calculated Results		
Frequency	Hz	60	4K	100K	60,00	0,00	0,00
rTemp	Ω/Km	0,94	0,94	0,94	0,94	0,94	0,94
SkinDept	mm	4,88	0,60	0,12	4,88	0,60	0,12
diameter	mm	2,76	2,76	2,76	2,76	2,76	2,76
resistivity	mΩm	5.65*10 ⁻⁶	5.65*10 ⁻⁶	5.65*10 ⁻⁶	5.65*10 ⁻⁶	5.65*10 ⁻⁶	5.65*10 ⁻⁶
rInternal	Ω	0,94	1,39	5,68	0,94	1,39	5,68
VrmsIn	V	230,00	230,00	230,00	230,00	230,00	230,00
vReIn	V	230,00	230,00	230,00	230,00	230,00	230,00
vImIn	V	0,00	0,00	0,00	0,00	0,00	0,00
VrmsOut	V	193,58	204,11	130,28			
vReOut	V	193,46	-162,93	130,28			
vImOut	V	-6,76	-122,94	0,07			
Vrms	V	37,16	411,71	99,72			
vRe	V	36,54	392,93	99,72			
vIm	V	6,76	122,94	-0,07			
IrmsIn	A	1,94	2,39	2,30			
iReIn	A	1,94	2,39	2,30			
iImIn	mA	12,27	141,93	14,12			
IrmsOut	A	1,94	2,04	1,30			
iReOut	A	-1,93	1,63	-1,30			
iImOut	A	67.55*10 ⁻³	1,23	0,00			
phiVIn		0,00	0,00	0,00			
phiIIn		0,36	2,52	0,35			
phiVIn		-0,36	-2,52	0,35			
phiVOut		-2,00	-142,96	0,03			
phiIOut		178,00	37,04	-179,97			
phiVOut		-180,00	-180,00	180,00			
PhiVL1		10,47	17,37	-0,04			
phiIL1		-0,82	-56,10	0,24			
phiIVL1		11,29	73,47	-0,27			
PReIn	W	445,31	548,54	528,95			
PImIn	W	-2,82	-24,13	-3,25			
SIn	VA	445,32	549,07	528,96			
PReOut	W	-374,73	-416,61	-169,73			

SimulationX Subsea Electrical Simulation library verification report

PImOut	mW	0,00	0,00	0,00			
SOut	VA	374,73	416,61	169,74			
PRe	mW	0,00	0,00	0,00			
PIm		0,00	0,00	0,00			
S		0,00	0,00	0,00			
dB	dB	-1,50	-1,04	-4,94			

3.3.3 Legend: Lines

- rTemp Resistance per line with regards to temperature per distance
- SkinDept Skin depth in conductor
- diameter Conductor diameter
- resistivity Calculated resistivity
- rInternal Total resistance for one line per distance
- VrmsIn Input Voltage RMS
- vReIn Input Voltage (Real Part) from L1in to Nin
- vImIn Input Voltage (Imaginary Part) From L1in to Nin
- VrmsOut Output Voltage RMS
- vReOut Output Voltage (Real Part) from L1in to Nin
- vImOut Output Voltage (Imaginary Part) From L1in to Nin
- Vrms Voltage Drop RMS
- vRe Voltage Drop (Real Part) from L1in to Nin
- vIm Voltage Drop (Imaginary Part) From L1in to Nin
- IrmsIn Input Current RMS
- iReIn Input Current (Real Part)
- iImIn Input Current (Imaginary Part)
- IrmsOut Output Current RMS
- iReOut Output Current (Real Part)
- iImOut Output Current (Imaginary Part)
- phiVIn Input Voltage Phase Angle
- phiIIn Input Current Phase Angle
- phiVIn Input Current Phase Angle with reference to Voltage
- phiVOut Output Voltage Phase Angle
- phiIOut Output Current Phase Angle
- phiIVOut Output Current Phase Angle with reference to Voltage

SimulationX Subsea Electrical Simulation library verification report

- PhiVL1 L1 Voltage Phase Angle
- phiIL1 L1 Current Phase Angle
- phiIVL1 L1 Current Phase Angle with reference to Voltage
- PReIn Effective Input Power
- PImIn Reactive Input Power
- SIn Apparent Input Power
- PReOut Effective Output Power
- PImOut Reactive Output Power
- SOut Apparent Output Power
- PRe Effective Power Loss
- PIm Reactive Power Loss
- S Apparent Power Loss
- dB Decibel Attenuation

3.4 Junctions and Terminations

3.4.1 Electrical Junction Box

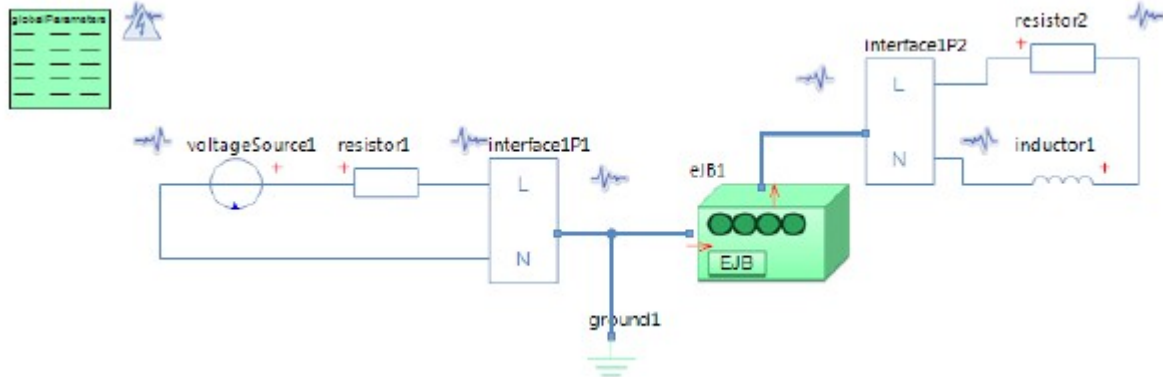

3.4.1.1 Parameters

Internal Parameters			
	Comment:	Name:	Value:
	Parameters for faulty state:	-	-
	Poor or failing L1 connection	bL1	SANN
	Resistance in L1 connection	rL1	1 kΩ
	Conductance between L1 and N	G	50 S

External Parameters			
	Comment:	Name:	Value:
	VoltageSource1	v_src	230 V
	Resistor1	resistor1.R	100 Ω
	Resistor2	resistor2.R	100 Ω
	Inductor1	inductor1.L	5 mH

SimulationX Subsea Electrical Simulation library verification report

3.4.1.2 Results

3.4.1.2.1 True connection

	Unit	Simulation Results			Calculated Results		
Frequency	Hz	60	4K	20K	60	4K	20K
VrmsIn	V	115,02	156,38	221,92	115,02	156,38	221,92
vReIn	V	115,01	147,55	219,42	115,01	147,55	219,42
vImIn	V	1,08	51,80	33,24	1,08	51,81	33,24
VrmsOut	V	115,02	156,38	221,92	115,02	156,38	221,92
vReOut	V	115,01	147,55	219,42	115,01	147,55	219,42
VImOut	V	1,08	51,80	33,24	1,08	51,81	33,24
Vrms	V	0,00	0,00	0,00	0,00	0,00	0,00
vRe	V	0,00	0,00	0,00	0,00	0,00	0,00
VIm	V	0,00	0,00	0,00	0,00	0,00	0,00
IrmsIn	A	1,15	0,97	0,35	1,15	0,97	0,35
iReIn	A	1,15	0,82	0,11	1,15	0,82	0,11
iImIn	A	-0,01	-0,52	-0,33	0,01	-0,52	-0,33
IrmsOut	A	1,15	0,97	0,35	1,15	0,97	0,35
iReOut	A	1,15	0,82	0,11	1,15	0,82	0,11
iImOut	A	-0,01	-0,52	-0,33	0,01	-0,52	-0,33
phiVin		0,54	19,35	8,61			
phiIn		-0,54	-32,14	-72,34			
phiVIn		1,08	51,49	80,96	1,08	51,49	80,96
phiVOut		0,54	19,35	8,61			
phiIOut		-0,54	-32,14	-72,34			
phiIVOut		1,08	51,49	80,96	1,08	51,49	80,96
PReIn	W	132,24	94,82	12,17	132,24	94,82	12,17
PImIn	W	2,49	119,15	76,45	2,49	119,15	76,45
Sin	VA	132,26	152,27	77,41	132,26	152,27	77,41
PReOut	W	132,24	94,82	12,17	132,24	94,82	12,17
PImOut	W	2,49	119,15	76,45	2,49	119,15	76,45
SOut	VA	132,26	152,27	77,41	132,26	152,27	77,41

SimulationX Subsea Electrical Simulation library verification report

3.4.1.2.2 Faulty connection

	Unit	Simulation Results			Calculated Results		
Frequency	Hz	60	4k	20k	60	4k	20k
VrmsIn	mV	45,99	45,99	45,99	45,99	45,99	45,99
vReIn	mV	45,99	45,99	45,99	45,99	45,99	45,99
vImIn	mV	0,00	0,00	0,00	0,00	0,00	0,00
VrmsOut	mV	4,18	6,67	23,10	4,18	6,67	23,10
vReOut	mV	4,18	4,72	14,47	4,18	4,72	14,47
VImOut	mV	0,07	4,71	18,01	0,08	4,72	18,01
Vrms	mV	41,81	41,54	36,30	41,81	41,54	36,30
vRe	mV	41,81	41,27	31,52	41,81	41,27	31,52
VIm	mV	-0,07	-4,71	-18,01	-0,08	-4,72	-18,01
IrmsIn	A	2,30	2,30	2,30	2,30	2,30	2,30
iReIn	A	2,30	2,30	2,30	2,30	2,30	2,30
iImIn	mA	0,00	0,00	0,00	0,00	0,00	0,00
IrmsOut	mA	0,04	0,04	0,04	0,04	0,04	0,04
iReOut	mA	0,04	0,04	0,03	0,04	0,04	0,03
iImOut	mA	0,00	0,00	-0,02	0,00	0,01	-0,02
phiVin		0,00	0,00	0,00	0,00	0,00	0,00
phiIn		0,00	0,00	0,00	0,00	0,00	0,00
phiIVin		0,00	0,00	0,00	0,00	0,00	0,00
phiVOut		0,98	44,97	51,22			
phiIOut		-0,10	-6,52	-29,73			
phiIVOut		1,08	51,49	80,96	1,08	51,49	80,96
PReIn	W	0,11	0,11	0,11			
PImin	mW	0,00	0,00	0,00			
Sin	VA	0,11	0,11	0,11	0,11	0,11	0,11
PReOut	mW	0,00	0,00	0,00	0,00	0,00	0,00
PImOut	mW	0,00	0,00	0,00	0,00	0,00	0,00
SOut	VA	0,00	0,00	0,00	0,00	0,00	0,00

3.4.2 Pin Connector Female

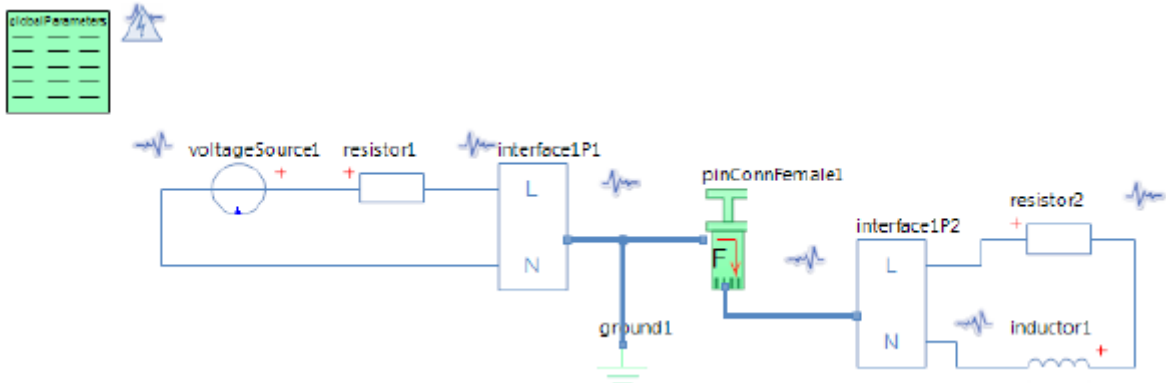

3.4.2.1 Parameters

Internal Parameters			
	Comment:	Name:	Value:
	Parameters for faulty state:	-	-
	<i>Poor or failing L1 connection</i>	bL1	SANN
	<i>Resistance in L1 connection</i>	rL1	1 k Ω
	<i>Conductance between L1 and N</i>	G	50 S

External Parameters			
	Comment:	Name:	Value:
	VoltageSource1	v_src	230 V
	Resistor1	resistor1.R	100 Ω
	Resistor2	resistor2.R	100 Ω
	Inductor1	inductor1.L	5 mH

SimulationX Subsea Electrical Simulation library verification report

3.4.2.2 Results

3.4.2.2.1 True connection

	Unit	Simulation Results			Calculated Results		
Frequency	Hz	60	4K	20K	60	4K	20K
VrmsIn	V	115,02	156,38	221,92	115,02	156,38	221,92
vReIn	V	115,01	147,55	219,42	115,01	147,55	219,42
vImIn	V	1,08	51,80	33,24	1,08	51,81	33,24
VrmsOut	V	115,02	156,38	221,92	115,02	156,38	221,92
vReOut	V	115,01	147,55	219,42	115,01	147,55	219,42
VImOut	V	1,08	51,80	33,24	1,08	51,81	33,24
Vrms	V	0,00	0,00	0,00	0,00	0,00	0,00
vRe	V	0,00	0,00	0,00	0,00	0,00	0,00
VIm	V	0,00	0,00	0,00	0,00	0,00	0,00
IrmsIn	A	1,15	0,97	0,35	1,15	0,97	0,35
iReIn	A	1,15	0,82	0,11	1,15	0,82	0,11
iImIn	A	-0,01	-0,52	-0,33	0,01	-0,52	-0,33
IrmsOut	A	1,15	0,97	0,35	1,15	0,97	0,35
iReOut	A	1,15	0,82	0,11	1,15	0,82	0,11
iImOut	A	-0,01	-0,52	-0,33	0,01	-0,52	-0,33
phiVin		0,54	19,35	8,61			
phiIn		-0,54	-32,14	-72,34			
phiVIn		1,08	51,49	80,96	1,08	51,49	80,96
phiVOut		0,54	19,35	8,61			
phiIOut		-0,54	-32,14	-72,34			
phiIVOut		1,08	51,49	80,96	1,08	51,49	80,96
PReIn	W	132,24	94,82	12,17	132,24	94,82	12,17
PImIn	W	2,49	119,15	76,45	2,49	119,15	76,45
Sin	VA	132,26	152,27	77,41	132,26	152,27	77,41
PReOut	W	132,24	94,82	12,17	132,24	94,82	12,17
PImOut	W	2,49	119,15	76,45	2,49	119,15	76,45
SOut	VA	132,26	152,27	77,41	132,26	152,27	77,41

SimulationX Subsea Electrical Simulation library verification report

3.4.2.2.2 Faulty connection

	Unit	Simulation Results			Calculated Results		
Frequency	Hz	60	4k	20k	60	4k	20k
VrmsIn	mV	45,99	45,99	45,99	45,99	45,99	45,99
vReIn	mV	45,99	45,99	45,99	45,99	45,99	45,99
vImIn	mV	0,00	0,00	0,00	0,00	0,00	0,00
VrmsOut	mV	4,18	6,67	23,10	4,18	6,67	23,10
vReOut	mV	4,18	4,72	14,47	4,18	4,72	14,47
VImOut	mV	0,07	4,71	18,01	0,08	4,72	18,01
Vrms	mV	41,81	41,54	36,30	41,81	41,54	36,30
vRe	mV	41,81	41,27	31,52	41,81	41,27	31,52
VIm	mV	-0,07	-4,71	-18,01	-0,08	-4,72	-18,01
IrmsIn	A	2,30	2,30	2,30	2,30	2,30	2,30
iReIn	A	2,30	2,30	2,30	2,30	2,30	2,30
iImIn	mA	0,00	0,00	0,00	0,00	0,00	0,00
IrmsOut	mA	0,04	0,04	0,04	0,04	0,04	0,04
iReOut	mA	0,04	0,04	0,03	0,04	0,04	0,03
iImOut	mA	0,00	0,00	-0,02	0,00	0,01	-0,02
phiVin		0,00	0,00	0,00	0,00	0,00	0,00
phiIn		0,00	0,00	0,00	0,00	0,00	0,00
phiIVin		0,00	0,00	0,00	0,00	0,00	0,00
phiVOut		0,98	44,97	51,22			
phiIOut		-0,10	-6,52	-29,73			
phiIVOut		1,08	51,49	80,96	1,08	51,49	80,96
PReIn	W	0,11	0,11	0,11			
PImin	mW	0,00	0,00	0,00			
Sin	VA	0,11	0,11	0,11	0,11	0,11	0,11
PReOut	mW	0,00	0,00	0,00	0,00	0,00	0,00
PImOut	mW	0,00	0,00	0,00	0,00	0,00	0,00
SOut	VA	0,00	0,00	0,00	0,00	0,00	0,00

3.4.3 Pin Connector Male

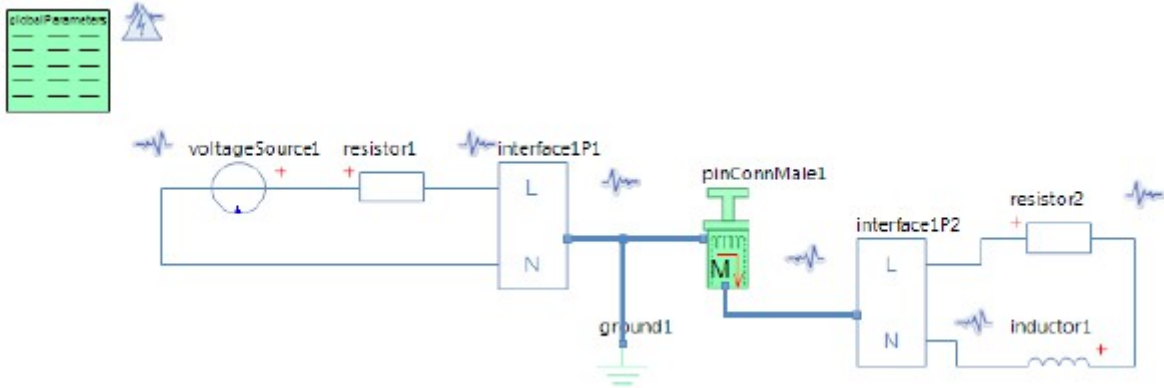

3.4.3.1 Parameters

Internal Parameters			
	Comment:	Name:	Value:
	Parameters for faulty state:	-	-
	<i>Poor or failing L1 connection</i>	bL1	SANN
	<i>Resistance in L1 connection</i>	rL1	1 k Ω
	<i>Conductance between L1 and N</i>	G	50 S

External Parameters			
	Comment:	Name:	Value:
	VoltageSource1	v_src	230 V
	Resistor1	resistor1.R	100 Ω
	Resistor2	resistor2.R	100 Ω
	Inductor1	inductor1.L	5 mH

SimulationX Subsea Electrical Simulation library verification report

3.4.3.2 Results

3.4.3.2.1 True connection

	Unit	Simulation Results			Calculated Results		
Frequency	Hz	60	4K	20K	60	4K	20K
VrmsIn	V	115,02	156,38	221,92	115,02	156,38	221,92
vReIn	V	115,01	147,55	219,42	115,01	147,55	219,42
vImIn	V	1,08	51,80	33,24	1,08	51,81	33,24
VrmsOut	V	115,02	156,38	221,92	115,02	156,38	221,92
vReOut	V	115,01	147,55	219,42	115,01	147,55	219,42
VImOut	V	1,08	51,80	33,24	1,08	51,81	33,24
Vrms	V	0,00	0,00	0,00	0,00	0,00	0,00
vRe	V	0,00	0,00	0,00	0,00	0,00	0,00
VIm	V	0,00	0,00	0,00	0,00	0,00	0,00
IrmsIn	A	1,15	0,97	0,35	1,15	0,97	0,35
iReIn	A	1,15	0,82	0,11	1,15	0,82	0,11
iImIn	A	-0,01	-0,52	-0,33	0,01	-0,52	-0,33
IrmsOut	A	1,15	0,97	0,35	1,15	0,97	0,35
iReOut	A	1,15	0,82	0,11	1,15	0,82	0,11
iImOut	A	-0,01	-0,52	-0,33	0,01	-0,52	-0,33
phiVin		0,54	19,35	8,61			
phiIn		-0,54	-32,14	-72,34			
phiVIn		1,08	51,49	80,96	1,08	51,49	80,96
phiVOut		0,54	19,35	8,61			
phiIOut		-0,54	-32,14	-72,34			
phiVOut		1,08	51,49	80,96	1,08	51,49	80,96
PReIn	W	132,24	94,82	12,17	132,24	94,82	12,17
PImIn	W	2,49	119,15	76,45	2,49	119,15	76,45
Sin	VA	132,26	152,27	77,41	132,26	152,27	77,41
PReOut	W	132,24	94,82	12,17	132,24	94,82	12,17
PImOut	W	2,49	119,15	76,45	2,49	119,15	76,45
SOut	VA	132,26	152,27	77,41	132,26	152,27	77,41

SimulationX Subsea Electrical Simulation library verification report

3.4.3.2.2 Faulty connection

	Unit	Simulation Results			Calculated Results		
Frequency	Hz	60	4k	20k	60	4k	20k
VrmsIn	mV	45,99	45,99	45,99	45,99	45,99	45,99
vReIn	mV	45,99	45,99	45,99	45,99	45,99	45,99
vImIn	mV	0,00	0,00	0,00	0,00	0,00	0,00
VrmsOut	mV	4,18	6,67	23,10	4,18	6,67	23,10
vReOut	mV	4,18	4,72	14,47	4,18	4,72	14,47
VImOut	mV	0,07	4,71	18,01	0,08	4,72	18,01
Vrms	mV	41,81	41,54	36,30	41,81	41,54	36,30
vRe	mV	41,81	41,27	31,52	41,81	41,27	31,52
VIm	mV	-0,07	-4,71	-18,01	-0,08	-4,72	-18,01
IrmsIn	A	2,30	2,30	2,30	2,30	2,30	2,30
iReIn	A	2,30	2,30	2,30	2,30	2,30	2,30
iImIn	mA	0,00	0,00	0,00	0,00	0,00	0,00
IrmsOut	mA	0,04	0,04	0,04	0,04	0,04	0,04
iReOut	mA	0,04	0,04	0,03	0,04	0,04	0,03
iImOut	mA	0,00	0,00	-0,02	0,00	0,01	-0,02
phiVin		0,00	0,00	0,00	0,00	0,00	0,00
phiIn		0,00	0,00	0,00	0,00	0,00	0,00
phiIVin		0,00	0,00	0,00	0,00	0,00	0,00
phiVOut		0,98	44,97	51,22			
phiIOut		-0,10	-6,52	-29,73			
phiIVOut		1,08	51,49	80,96	1,08	51,49	80,96
PReIn	W	0,11	0,11	0,11			
PImin	mW	0,00	0,00	0,00			
Sin	VA	0,11	0,11	0,11	0,11	0,11	0,11
PReOut	mW	0,00	0,00	0,00	0,00	0,00	0,00
PImOut	mW	0,00	0,00	0,00	0,00	0,00	0,00
SOut	VA	0,00	0,00	0,00	0,00	0,00	0,00

3.4.4 Topside Umbilical Termination Unit

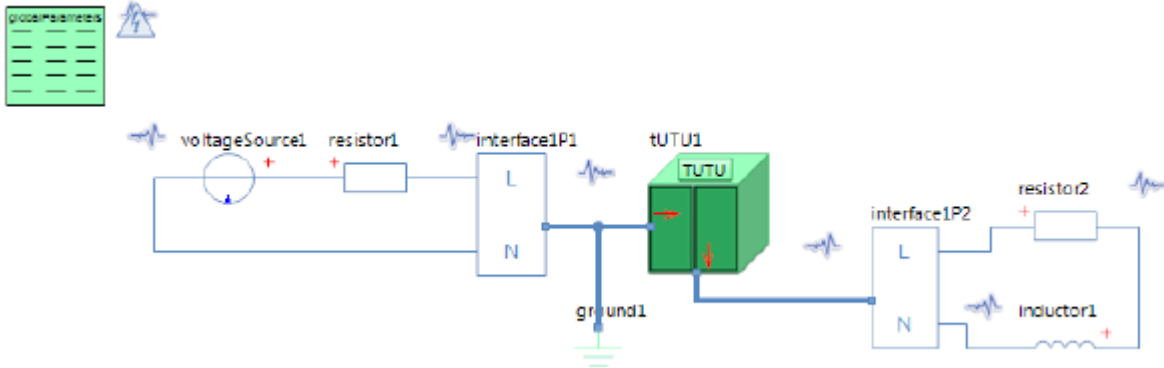

3.4.4.1 Parameters

Internal Parameters			
	Comment:	Name:	Value:
	Parameters for faulty state:	-	-
	Poor or failing L1 connection	bL1	SANN
	Resistance in L1 connection	rL1	1 k Ω
	Conductance between L1 and N	G	50 S

External Parameters			
	Comment:	Name:	Value:
	VoltageSource1	v_src	230 V
	Resistor1	resistor1.R	100 Ω
	Resistor2	resistor2.R	100 Ω
	Inductor1	inductor1.L	5 mH

SimulationX Subsea Electrical Simulation library verification report

3.4.4.2 Results

3.4.4.2.1 True connection

	Unit	Simulation Results			Calculated Results		
Frequency	Hz	60	4K	20K	60	4K	20K
VrmsIn	V	115,02	156,38	221,92	115,02	156,38	221,92
vReIn	V	115,01	147,55	219,42	115,01	147,55	219,42
vImIn	V	1,08	51,80	33,24	1,08	51,81	33,24
VrmsOut	V	115,02	156,38	221,92	115,02	156,38	221,92
vReOut	V	115,01	147,55	219,42	115,01	147,55	219,42
VImOut	V	1,08	51,80	33,24	1,08	51,81	33,24
Vrms	V	0,00	0,00	0,00	0,00	0,00	0,00
vRe	V	0,00	0,00	0,00	0,00	0,00	0,00
VIm	V	0,00	0,00	0,00	0,00	0,00	0,00
IrmsIn	A	1,15	0,97	0,35	1,15	0,97	0,35
iReIn	A	1,15	0,82	0,11	1,15	0,82	0,11
iImIn	A	-0,01	-0,52	-0,33	0,01	-0,52	-0,33
IrmsOut	A	1,15	0,97	0,35	1,15	0,97	0,35
iReOut	A	1,15	0,82	0,11	1,15	0,82	0,11
iImOut	A	-0,01	-0,52	-0,33	0,01	-0,52	-0,33
phiVin		0,54	19,35	8,61			
phiIn		-0,54	-32,14	-72,34			
phiVIn		1,08	51,49	80,96	1,08	51,49	80,96
phiVOut		0,54	19,35	8,61			
phiIOut		-0,54	-32,14	-72,34			
phiIVOut		1,08	51,49	80,96	1,08	51,49	80,96
PReIn	W	132,24	94,82	12,17	132,24	94,82	12,17
PImIn	W	2,49	119,15	76,45	2,49	119,15	76,45
Sin	VA	132,26	152,27	77,41	132,26	152,27	77,41
PReOut	W	132,24	94,82	12,17	132,24	94,82	12,17
PImOut	W	2,49	119,15	76,45	2,49	119,15	76,45
SOut	VA	132,26	152,27	77,41	132,26	152,27	77,41

SimulationX Subsea Electrical Simulation library verification report

3.4.4.2.2 Faulty connection

	Unit	Simulation Results			Calculated Results		
Frequency	Hz	60	4k	20k	60	4k	20k
VrmsIn	mV	45,99	45,99	45,99	45,99	45,99	45,99
vReIn	mV	45,99	45,99	45,99	45,99	45,99	45,99
vImIn	mV	0,00	0,00	0,00	0,00	0,00	0,00
VrmsOut	mV	4,18	6,67	23,10	4,18	6,67	23,10
vReOut	mV	4,18	4,72	14,47	4,18	4,72	14,47
VImOut	mV	0,07	4,71	18,01	0,08	4,72	18,01
Vrms	mV	41,81	41,54	36,30	41,81	41,54	36,30
vRe	mV	41,81	41,27	31,52	41,81	41,27	31,52
VIm	mV	-0,07	-4,71	-18,01	-0,08	-4,72	-18,01
IrmsIn	A	2,30	2,30	2,30	2,30	2,30	2,30
iReIn	A	2,30	2,30	2,30	2,30	2,30	2,30
iImIn	mA	0,00	0,00	0,00	0,00	0,00	0,00
IrmsOut	mA	0,04	0,04	0,04	0,04	0,04	0,04
iReOut	mA	0,04	0,04	0,03	0,04	0,04	0,03
iImOut	mA	0,00	0,00	-0,02	0,00	0,01	-0,02
phiVin		0,00	0,00	0,00	0,00	0,00	0,00
phiIn		0,00	0,00	0,00	0,00	0,00	0,00
phiIVin		0,00	0,00	0,00	0,00	0,00	0,00
phiVOut		0,98	44,97	51,22			
phiIOut		-0,10	-6,52	-29,73			
phiIVOut		1,08	51,49	80,96	1,08	51,49	80,96
PReIn	W	0,11	0,11	0,11			
PImin	mW	0,00	0,00	0,00			
Sin	VA	0,11	0,11	0,11	0,11	0,11	0,11
PReOut	mW	0,00	0,00	0,00	0,00	0,00	0,00
PImOut	mW	0,00	0,00	0,00	0,00	0,00	0,00
SOut	VA	0,00	0,00	0,00	0,00	0,00	0,00

3.4.5 Umbilical Termination Head

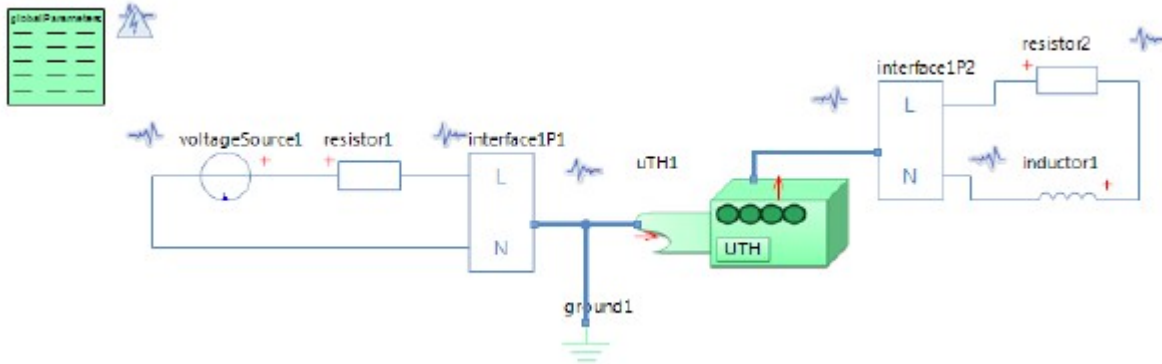

3.4.5.1 Parameters

Internal Parameters			
	Comment:	Name:	Value:
	Parameters for faulty state:	-	-
	Poor or failing L1 connection	bL1	SANN
	Resistance in L1 connection	rL1	1 k Ω
	Conductance between L1 and N	G	50 S

External Parameters			
	Comment:	Name:	Value:
	VoltageSource1	v_src	230 V
	Resistor1	resistor1.R	100 Ω
	Resistor2	resistor2.R	100 Ω
	Inductor1	inductor1.L	5 mH

SimulationX Subsea Electrical Simulation library verification report

3.4.5.2 Results

3.4.5.2.1 True connection

	Unit	Simulation Results			Calculated Results		
Frequency	Hz	60	4K	20K	60	4K	20K
VrmsIn	V	115,02	156,38	221,92	115,02	156,38	221,92
vReIn	V	115,01	147,55	219,42	115,01	147,55	219,42
vImIn	V	1,08	51,80	33,24	1,08	51,81	33,24
VrmsOut	V	115,02	156,38	221,92	115,02	156,38	221,92
vReOut	V	115,01	147,55	219,42	115,01	147,55	219,42
VImOut	V	1,08	51,80	33,24	1,08	51,81	33,24
Vrms	V	0,00	0,00	0,00	0,00	0,00	0,00
vRe	V	0,00	0,00	0,00	0,00	0,00	0,00
VIm	V	0,00	0,00	0,00	0,00	0,00	0,00
IrmsIn	A	1,15	0,97	0,35	1,15	0,97	0,35
iReIn	A	1,15	0,82	0,11	1,15	0,82	0,11
iImIn	A	-0,01	-0,52	-0,33	0,01	-0,52	-0,33
IrmsOut	A	1,15	0,97	0,35	1,15	0,97	0,35
iReOut	A	1,15	0,82	0,11	1,15	0,82	0,11
iImOut	A	-0,01	-0,52	-0,33	0,01	-0,52	-0,33
phiVin		0,54	19,35	8,61			
phiIn		-0,54	-32,14	-72,34			
phiVIn		1,08	51,49	80,96	1,08	51,49	80,96
phiVOut		0,54	19,35	8,61			
phiIOut		-0,54	-32,14	-72,34			
phiIVOut		1,08	51,49	80,96	1,08	51,49	80,96
PReIn	W	132,24	94,82	12,17	132,24	94,82	12,17
PImin	W	2,49	119,15	76,45	2,49	119,15	76,45
Sin	VA	132,26	152,27	77,41	132,26	152,27	77,41
PReOut	W	132,24	94,82	12,17	132,24	94,82	12,17
PImOut	W	2,49	119,15	76,45	2,49	119,15	76,45
SOut	VA	132,26	152,27	77,41	132,26	152,27	77,41

SimulationX Subsea Electrical Simulation library verification report

3.4.5.2.2 Faulty connection

	Unit	Simulation Results			Calculated Results		
Frequency	Hz	60	4k	20k	60	4k	20k
VrmsIn	mV	45,99	45,99	45,99	45,99	45,99	45,99
vReIn	mV	45,99	45,99	45,99	45,99	45,99	45,99
vImIn	mV	0,00	0,00	0,00	0,00	0,00	0,00
VrmsOut	mV	4,18	6,67	23,10	4,18	6,67	23,10
vReOut	mV	4,18	4,72	14,47	4,18	4,72	14,47
VImOut	mV	0,07	4,71	18,01	0,08	4,72	18,01
Vrms	mV	41,81	41,54	36,30	41,81	41,54	36,30
vRe	mV	41,81	41,27	31,52	41,81	41,27	31,52
VIm	mV	-0,07	-4,71	-18,01	-0,08	-4,72	-18,01
IrmsIn	A	2,30	2,30	2,30	2,30	2,30	2,30
iReIn	A	2,30	2,30	2,30	2,30	2,30	2,30
iImIn	mA	0,00	0,00	0,00	0,00	0,00	0,00
IrmsOut	mA	0,04	0,04	0,04	0,04	0,04	0,04
iReOut	mA	0,04	0,04	0,03	0,04	0,04	0,03
iImOut	mA	0,00	0,00	-0,02	0,00	0,01	-0,02
phiVin		0,00	0,00	0,00	0,00	0,00	0,00
phiIn		0,00	0,00	0,00	0,00	0,00	0,00
phiIVin		0,00	0,00	0,00	0,00	0,00	0,00
phiVOut		0,98	44,97	51,22			
phiIOut		-0,10	-6,52	-29,73			
phiIVOut		1,08	51,49	80,96	1,08	51,49	80,96
PReIn	W	0,11	0,11	0,11			
PImin	mW	0,00	0,00	0,00			
Sin	VA	0,11	0,11	0,11	0,11	0,11	0,11
PReOut	mW	0,00	0,00	0,00	0,00	0,00	0,00
PImOut	mW	0,00	0,00	0,00	0,00	0,00	0,00
SOut	VA	0,00	0,00	0,00	0,00	0,00	0,00

3.4.6 Legend: Junctions and Terminations

- VrmsIn Input Voltage RMS
- vReIn Input Voltage (Real Part) from L1in to Nin
- vImIn Input Voltage (Imaginary Part) from L1in to Nin
- VrmsOut Output Voltage RMS
- vReOut Output Voltage (Real Part) from L1out to Nout
- VImOut Output Voltage (Imaginary Part) from L1out to Nout
- Vrms Voltage Drop RMS
- vRe Voltage Drop (Real Part)
- VIm Voltage Drop (Imaginary Part)
- IrmsIn Input Current RMS
- iReIn Input Current (Real Part)
- iImIn Input Current (Imaginary Part)
- IrmsOut Output Current RMS
- iReOut Output Current (Real Part)
- iImOut Output Current (Imaginary Part)
- phiVin Input Voltage Phase Angle
- phiIIn Input Current Phase Angle
- phiIVin Input Current Phase Angle with reference to Voltage
- phiVOut Output Voltage Phase Angle
- phiIOut Output Current Phase Angle
- phiIVOut Output Current Phase Angle with reference to Voltage
- PReIn Effective Input Power
- PImIn Reactive Input Power
- Sin Apparent Input Power
- PReOut Effective Output Power
- PImOut Reactive Output Power
- SOut Apparent Output Power

3.5 Miscellaneous

3.5.1 Filter

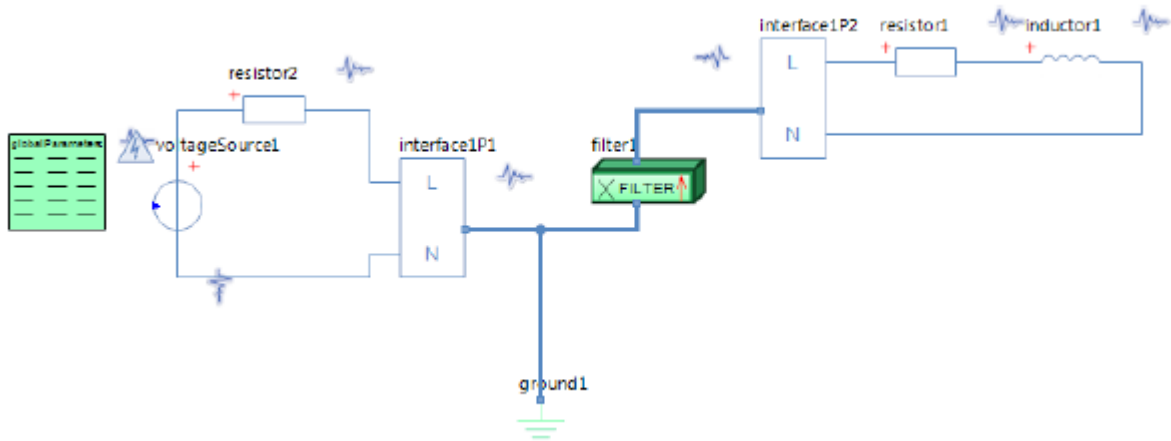

3.5.1.1 Parameters

Internal Parameters			
	Comment:	Name:	Value:
	Conductance	G	10^{-3} S

External Parameters			
	Comment:	Name:	Value:
	VoltageSource1	v_src	5 V
	Resistor1	resistor1.R	100 Ω
	Resistor2	resistor2.R	10 Ω
	Inductor1	inductor1.L	5 mH

SimulationX Subsea Electrical Simulation library verification report

3.5.1.2 Results

3.5.1.2.1 EPU Sending

	Unit	Simulation Results			Calculated Results		
Frequency	Hz	60	4k	100k	60	4k	100k
VrmsIn	V	4,95	4,95	4,95	4,95	4,95	4,95
vReIn	V	4,95	4,95	4,95	4,95	4,95	4,95
vImIn	V	0,00	0,00	0,00	0,00	0,00	0,00
irmsIn	mA	4,95	4,95	4,95	4,95	4,95	4,95
iReIn	mA	4,95	4,95	4,95	4,95	4,95	4,95
iImIn	mA	0,00	0,00	0,00	0,00	0,00	0,00
phiVin		0,00	0,00	0,00	0,00	0,00	0,00
phiIIn		0,00	0,00	0,00	0,00	0,00	0,00
phiIVIn		0,00	0,00	0,00	0,00	0,00	0,00
PReIn	mW	24,51	24,51	24,51	24,502	24,502	24,502
PImIn	mW	0,00	0,00	0,00	0,00	0,00	0,00
Sin	mVA	24,51	24,51	24,51	24,502	24,502	24,502
VrmsOut	mV	0,00	0,00	0,00	0,00	0,00	0,00
vReOut	mV	0,00	0,00	0,00	0,00	0,00	0,00
vImOut	mV	0,00	0,00	0,00	0,00	0,00	0,00
IrmsOut	mA	0,00	0,00	0,00	0,00	0,00	0,00
iReOut	mA	0,00	0,00	0,00	0,00	0,00	0,00
iImOut	mA	0,00	0,00	0,00	0,00	0,00	0,00
phiVOut		0,00	0,00	0,00	0,00	0,00	0,00
phiIOut		0,00	0,00	0,00	0,00	0,00	0,00
phiIVOut		0,00	0,00	0,00	0,00	0,00	0,00
PReOut	mW	0,00	0,00	0,00	0,00	0,00	0,00
PImOut	mW	0,00	0,00	0,00	0,00	0,00	0,00
SOut	mVA	0,00	0,00	0,00	0,00	0,00	0,00

SimulationX Subsea Electrical Simulation library verification report

3.5.1.2.2 Modem sending

	Unit	Simulation Results			Calculated Results		
Frequency	Hz	60	4K	100K	60	4k	100k
VrmsIn	V	4,50	4,76	4,95	4,51	4,76	4,95
vReIn	V	4,50	4,76	4,95	4,51	4,76	4,95
vImIn	mV	7,65	21,01	15,58	7,70	22,10	15,60
irmsIn	mA	49,54	32,83	5,24	49,54	32,83	5,24
iReIn	mA	49,54	24,28	5,01	49,54	24,28	5,01
iImIn	mA	-0,76	-22,10	-1,56	-0,77	-22,10	-1,56
phiVin		0,10	2,66	0,18			
phiIIn		-0,88	-42,31	-17,29			
phiIVIn		0,98	44,97	17,47	0,98	44,97	17,47
PReIn	mW	223,14	110,62	24,75	223,14	110,62	24,75
PImIn	mW	3,82	110,50	7,79	3,82	110,50	7,79
Sin	mVA	223,17	156,36	25,95	223,17	156,36	25,95
VrmsOut	V	4,50	4,76	4,95	4,51	4,76	4,95
vReOut	V	4,50	4,76	4,95	4,51	4,76	4,95
vImOut	mV	7,65	221,01	15,58			
IrmsOut	mA	45,04	29,65	1,57			
iReOut	mA	45,03	19,52	0,06			
iImOut	mA	-0,77	-22,32	-1,57			
phiVOut		0,10	2,66	0,18			
phiIOut		-0,98	-48,83	-88,00			
phiIVOut		1,08	51,49	88,18	1,08	51,49	88,18
PReOut	mW	222,85	87,94	0,25			
PImOut	mW	3,82	110,50	7,79			
SOut	mVA	202,88	141,22	7,80			

3.5.1.3 Legend: Filter

- VrmsIn Input Voltage RMS
- vReIn Input Voltage (Real Part) from L1p to Np
- vImIn Input Voltage (Imaginary Part) from L1p to Np
- irmsIn Input Current RMS
- iReIn Input Current (Real Part)
- iImIn Input Current (Imaginary Part)
- phiVin Input Voltage Phase Angle
- phiIIn Input Current Phase Angle
- phiIVIn Input Current Phase Angle with reference to Voltage
- PReIn Effective Input Power
- PImIn Reactive Input Power
- Sin Apparent Input Power
- VrmsOut Output Voltage RMS
- vReOut Output Voltage (Real Part) from L1p to Np
- vImOut Output Voltage (Imaginary Part) from L1p to Np
- IrmsOut Output Current RMS
- iReOut Output Current (Real Part)
- iImOut Output Current (Imaginary Part)
- phiVOut Output Voltage Phase Angle
- phiIOut Output Current Phase Angle
- phiIVOut Output Current Phase Angle with reference to Voltage
- PReOut Effective Output Power
- PImOut Reactive Output Power
- SOut Apparent Output Power

3.5.2 Transformer

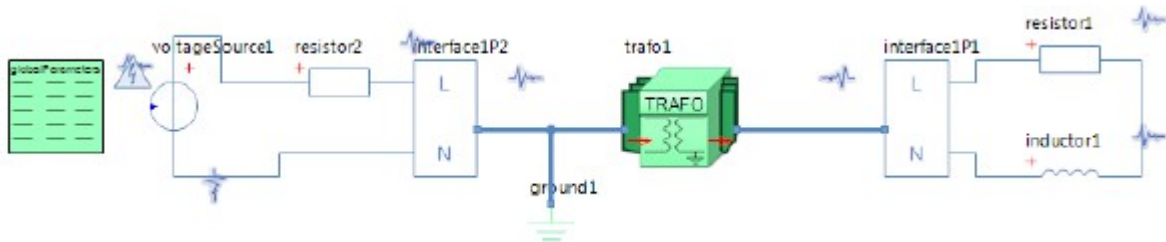

3.5.2.1 Parameters

Internal Parameters			
	Comment:	Name:	Value:
	Primary Inductance	L1	40 mH
	Initial Value	i10	0 A
	Secondary Inductance	L2	80 mH
	Initial Value	i20	0 A
	Mutual Coupling Inductance	M	$0.75 \cdot \sqrt{L1 \cdot L2}$
	<i>Additional Parameters for lossy state:</i>	-	-
	<i>Primary Winding Resistance</i>	R1	5 Ω
	<i>Secondary Winding Resistance</i>	R2	5 Ω
	<i>Ironloss Resistance</i>	Rfe	50 k Ω

External Parameters			
	Comment:	Name:	Value:
	VoltageSource1:	v_src	230V
	Resistor1:	resistor1.R	50 Ω
	Resistor2:	resistor2.R	10 Ω
	Inductor1:	inductor.L	5mH

SimulationX Subsea Electrical Simulation library verification report

3.5.2.2 Results

3.5.2.2.1 Lossless

	Unit	Simulation Results			Calculated Results		
Frequency	Hz	60	4K	100K	60	4K	100K
n		0,71	0,71	0,71	0,71	0,71	0,71
k		0,75	0,75	0,75	0,75	0,75	0,75
VrmsIn	V	163,41	229,82	230,00	163,41	229,82	230,00
vReIn	V	140,04	229,77	230,00	140,04	229,77	230,00
vImIn	V	84,21	4,85	0,19	84,21	4,85	0,19
IrmsIn	mA	12.32*10 ³	485,32	19,45	12.32*10 ³	485,32	19,45
iReIn	mA	9.00*10 ³	22,99	0,04	9.00*10 ³	22,99	0,04
iImIn	mA	-8.42*10 ³	-484,78	-19,45	-8.42*10 ³	-484,78	-19,45
phiVIn		31,02	1,21	0,04			
phiIIn		-43,11	-87,28	-89,89			
phiIVIn		74,13	88,49	89,94			
PReIn	W	55,70	2,93	0,00			
PIImIn	W	1936,80	111,50	4,47			
SIn	VA	2013,57	111,54	4,47	2013,57	111,54	4,47
pfln		0,77	0,03	0,00			
VrmsOut	V	166,05	32,75	30,50	166,05	32,75	30,50
vReOut	V	159,30	31,21	30,50	159,30	31,21	30,50
vImOut	V	46,87	-9,93	-0,40	46,87	-9,93	-0,40
IrmsOut	mA	3.32*10 ³	242,17	9,71	3.32*10 ³	242,18	9,71
iReOut	mA	3.22*10 ³	17,13	0,03	3.22*10 ³	17,13	0,03
iImOut	mA	0.82*10 ³	-241,57	-9,71	0.82*10 ³	-241,57	-9,71
phiVOut		16,40	-17,65	-0,75			
phiIOut		14,24	-85,94	-89,84			
phiIVOut		2,16	68,30	89,09			
PReOut	W	550,70	2,93	0,00			
PIImOut	W	20,76	7,37	0,30			
SOut	VA	551,09	7,93	0,30	551,09	7,93	0,30
pfOut		1,00	0,37	0,02			

3.5.2.2.2 Lossy

	Unit	Simulation Results			Calculated Results		
Frequency	Hz	60	4K	100K	60	4K	100K
n		0,71	0,71	0,71	0,71	0,71	0,71

SimulationX Subsea Electrical Simulation library verification report

k		0,75	0,75	0,75	0,75	0,75	0,75
VrmsIn	V	158,25	229,75	229,99	158,25	229,45	229,99
vReIn	V	146,97	229,70	229,99	146,97	229,7	229,99
vImIn	V	58,68	4,84	0,20	58,68	4,84	0,2
IrmsIn	mA	10.17*10 ³	484,98	19,53	10.17*10 ³	484,98	19,53
iReIn	mA	8.30*10 ³	30,35	1,05	8.30*10 ³	30,35	1,05
iImIn	mA	-5.87*10 ³	-484,03	-19,51	-5.87*10 ³	-484,03	-19,51
phiVIn		21,76	1,21	0,05			
phiIIn		-35,25	-86,41	-86,91			
phiIVIn		57,01	87,62	86,95			
PReIn	W	876,00	4,63	0,24			
PImIn	W	1349,59	111,33	4,49			
SIn	VA	1608,96	111,42	4,49	1608,96	111,42	4,49
pIn		0,54	0,04	0,05			
VrmsOut	V	127,82	32,72	30,44	127,82	32,72	30,44
vReOut	V	114,22	31,31	30,36	114,22	31,31	30,36
vImOut	V	57,38	-9,51	-2,17	57,38	-9,51	-2,17
IrmsOut	mA	2.55*10 ³	241,92	9,69	2.55*10 ³	241,92	9,69
iReOut	mA	2.32*10 ³	20,28	-0,54	2.32*10 ³	20,28	-0,54
iImOut	mA	1.06*10 ³	-241,07	-9,67	1.06*10 ³	-241,07	-9,67
phiVOut		26,67	-16,89	-4,08			
phiIOut		24,52	-85,19	-93,17			
phiIVOut		2,16	68,30	89,09			
PReOut	W	326,29	2,93	0,00			
PImOut	W	12,30	7,35	0,29			
SOut	VA	326,53	7,92	0,29	326,53	7,92	0,3
pfOut		1,00	0,37	0,02			

3.5.2.3 Legend: Transformer

- n Turn Ratio
- k Coefficient of Coupling
- VrmsIn Input Voltage RMS
- vReIn Input Voltage (Real Part) from L1in to Nin
- vImIn Input Voltage (Imaginary Part) from L1in to Nin
- IrmsIn Input Current RMS
- iReIn Input Current (Real Part)
- iImIn Input Current (Imaginary Part)
- phiVIn Input Voltage Phase Angle
- phiIIn Input Current Phase Angle
- phiIVIn Input Current Phase Angle with reference to Voltage
- PReIn Effective Input Power
- PImIn Reactive Input Power
- SIn Apparent Input Power
- pfln Input Power Factor
- VrmsOut Output Voltage RMS
- vReOut Output Voltage (Real Part) from L1in to Nin
- vImOut Output Voltage (Imaginary Part) from L1in to Nin
- IrmsOut Output Current RMS
- iReOut Output Current (Real Part)
- iImOut Output Current (Imaginary Part)
- phiVOut Output Voltage Phase Angle
- phiIOut Output Current Phase Angle
- phiIVOut Output Current Phase Angle with reference to Voltage
- PReOut Effective Output Power
- PImOut Reactive Output Power
- SOut Apparent Output Power
- pfOut Output Power Factor

Diagram View

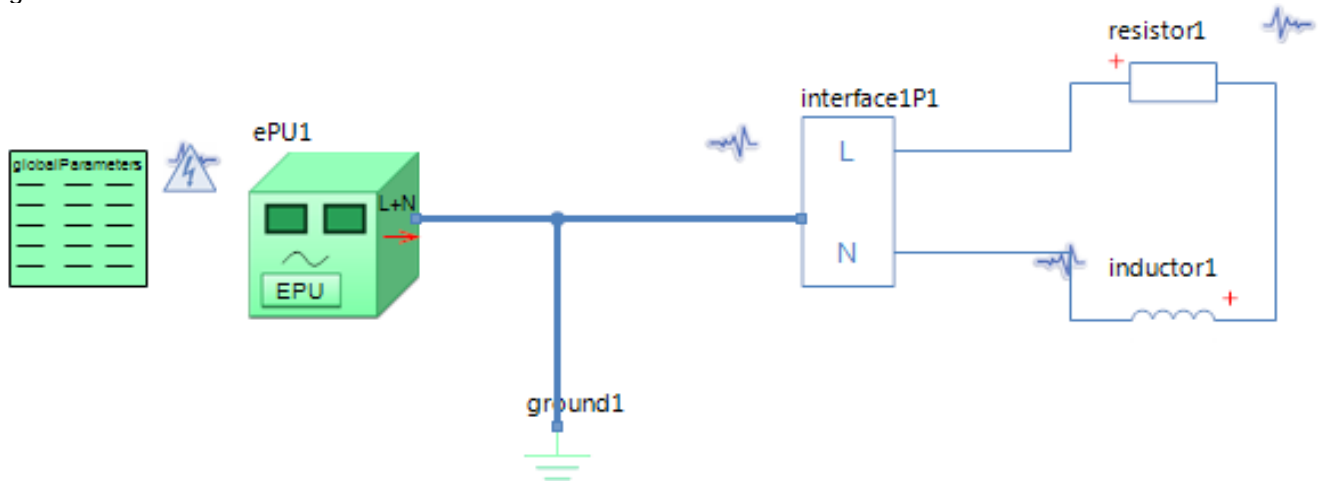

GlobalParameters globalParameters
Parameters

Comment	Name	Current Value	Unit
Type of Calculation	eCalculationKind	Signal Calculation	
Description of Frequency	eFrequencyKind	Linear	
Minimum Frequency	fMin	30	[Hz]
Maximum Frequency	fMax	30	[Hz]

Resistor resistor1
Parameters

Comment	Name	Current Value	Unit
Resistance	R	100	[Ohm]

Inductor inductor1
Parameters

Comment	Name	Current Value	Unit
Inductance	L	100	[mH]

Electrical Power Unit ePU1
Parameters

Comment	Name	Current Value	Unit
EPU or Modem sending on system	sType	EPU sending	
Internal Resistance L1	RL	5	[Ohm]
Internal Resistance N	RN	5	[Ohm]
Sine Wave RMS Voltage (Signal)	VrmsSrcSig	230	[V]
Voltage Offset (Signal)	offsetSig	0	[V]
Voltage Phase Angle	phiV	0	[deg]

ePU1.VrmsOut

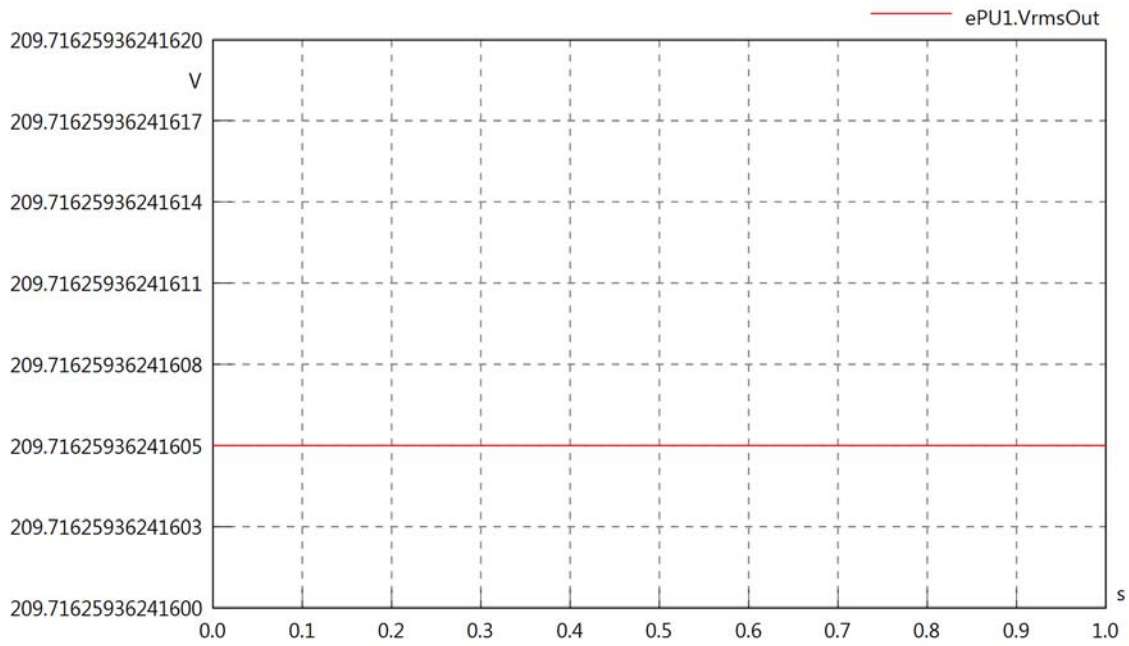

ePU1.vReOut

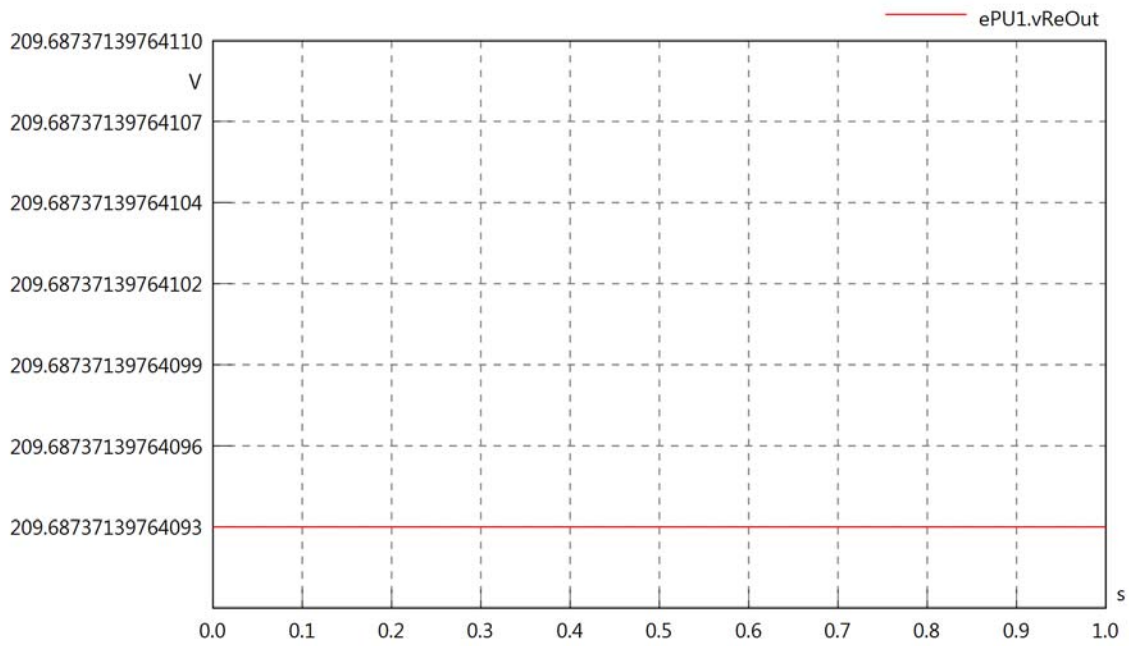

ePU1.vImOut

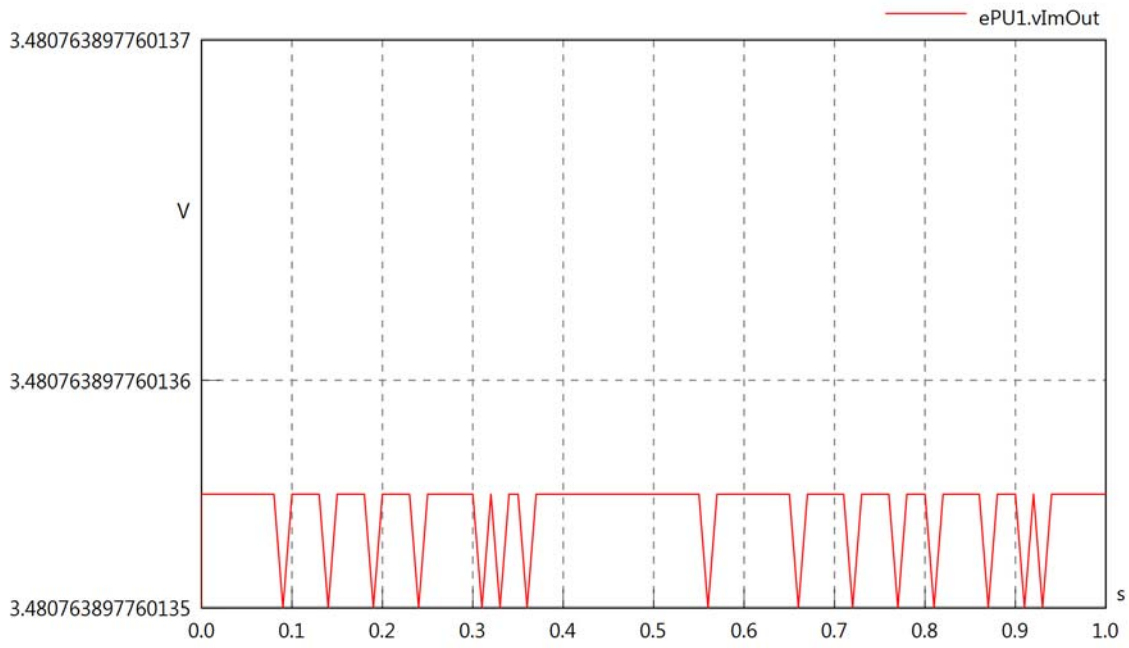

ePU1.IrmsOut

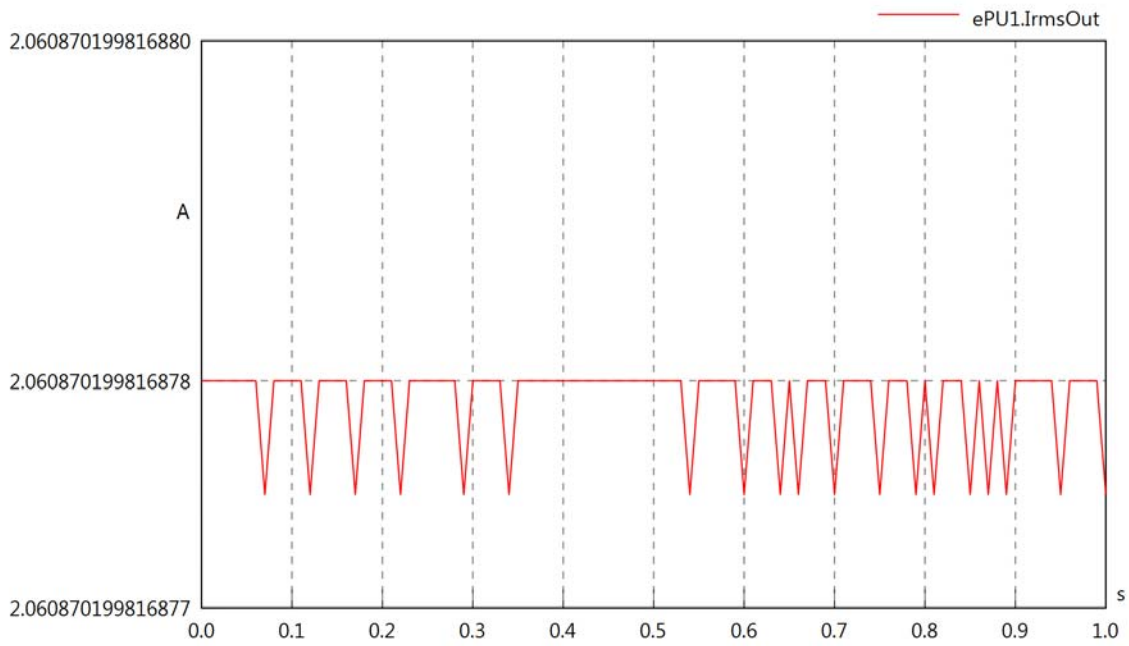

ePU1.iReOut

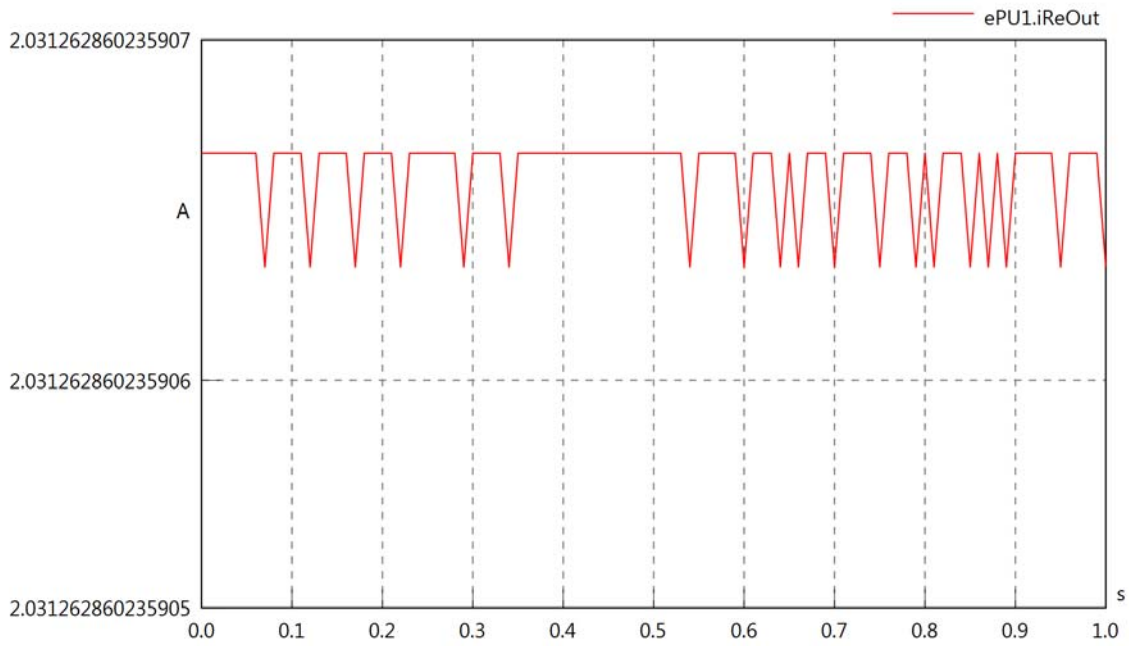

ePU1.iImOut

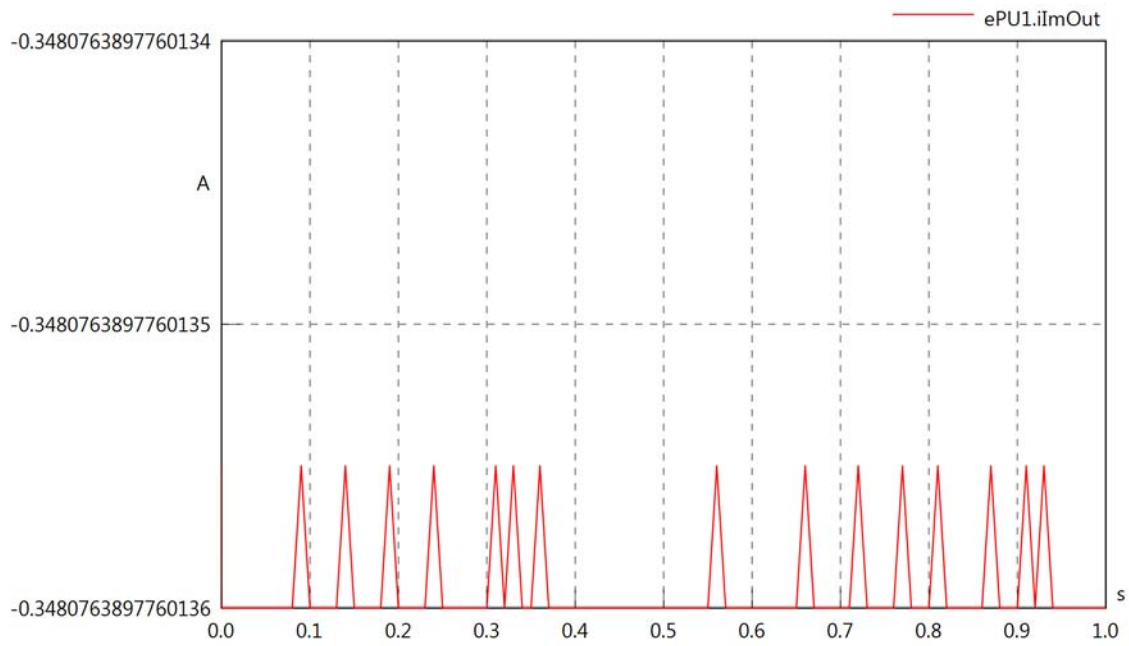

ePU1.phiVOut

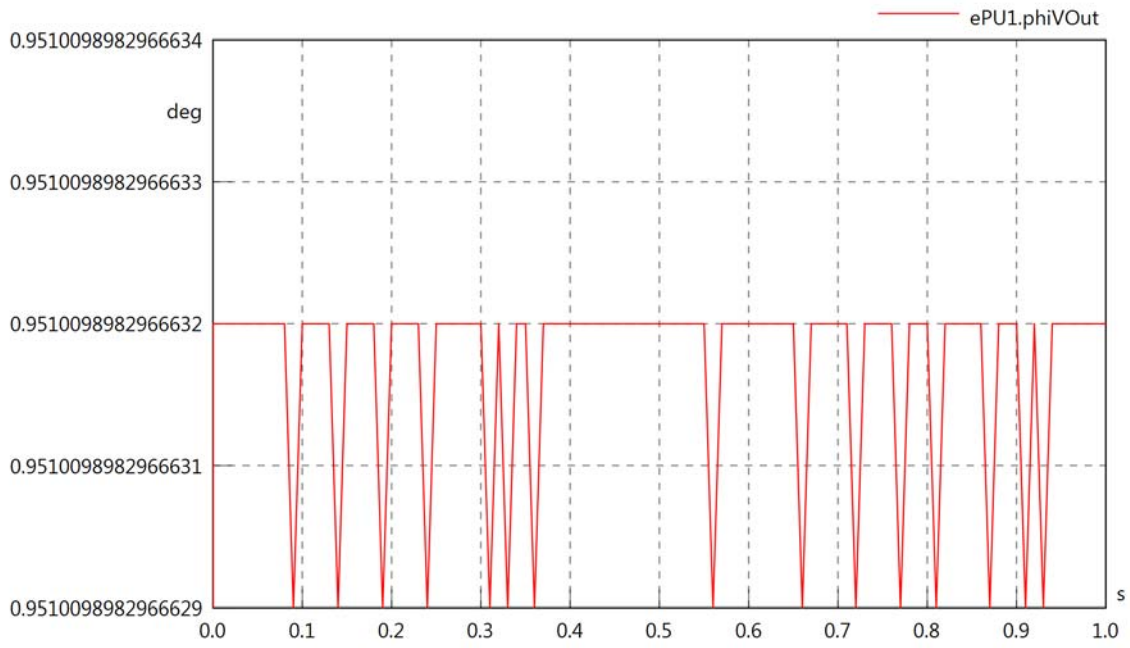

ePU1.philOut

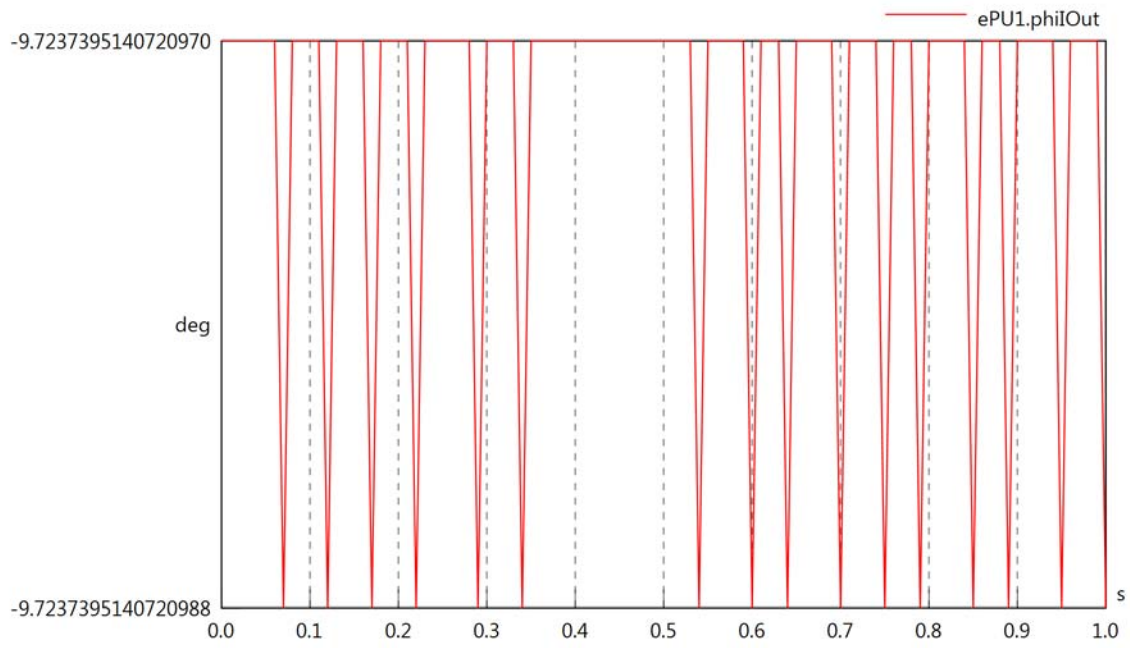

ePU1.phiIVOut

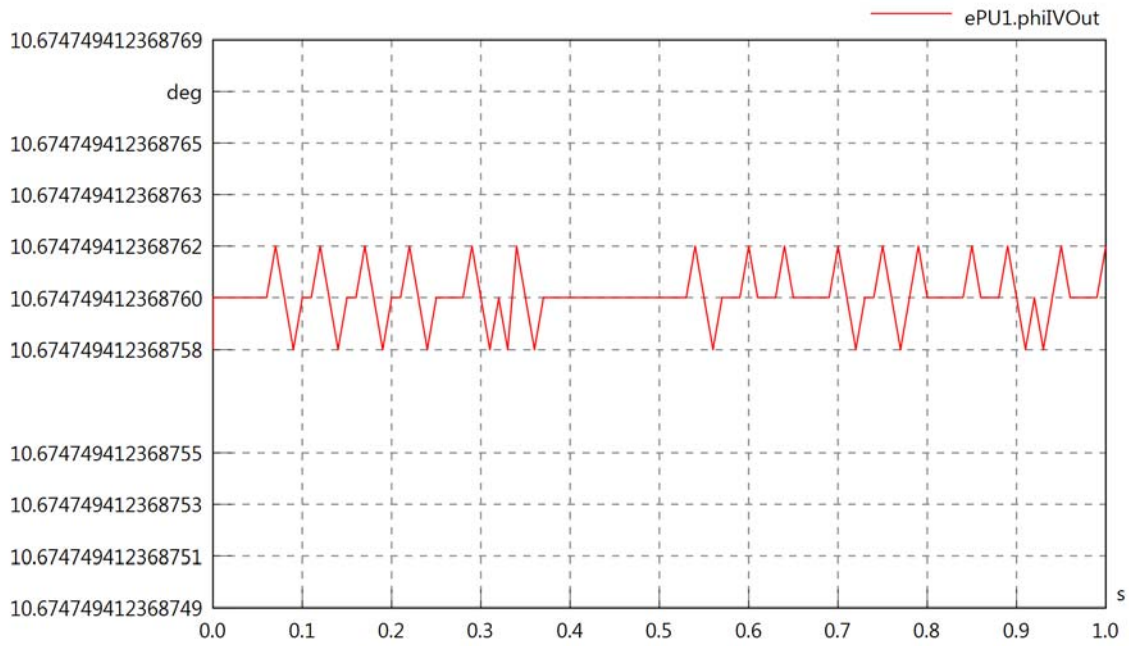

ePU1.PReOut

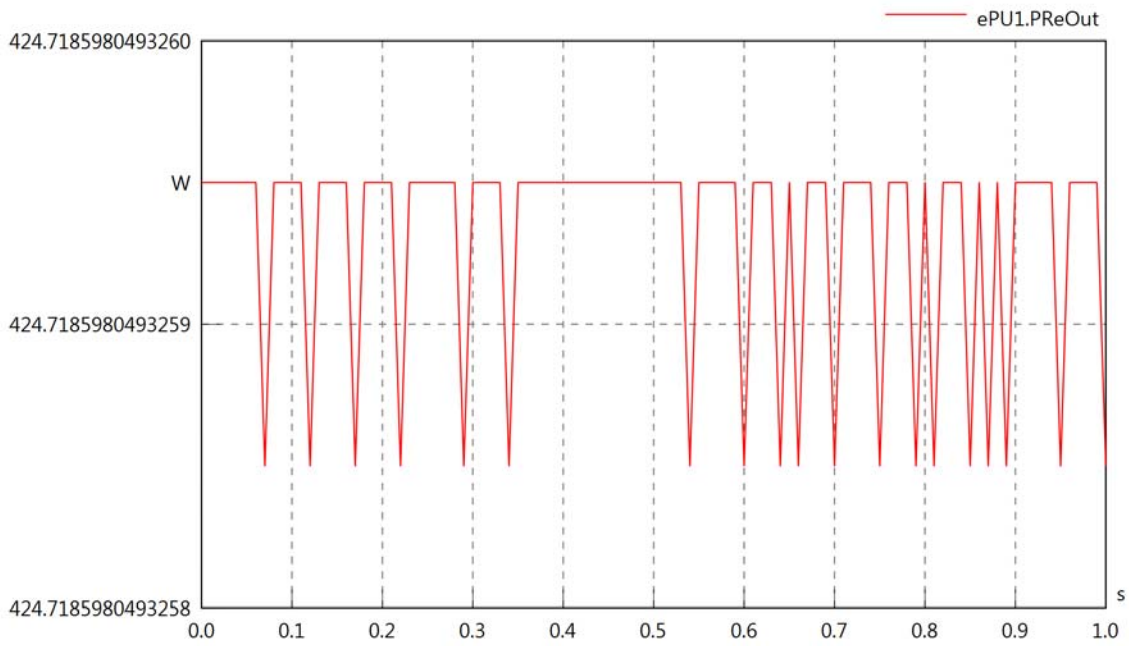

ePU1.PImOut

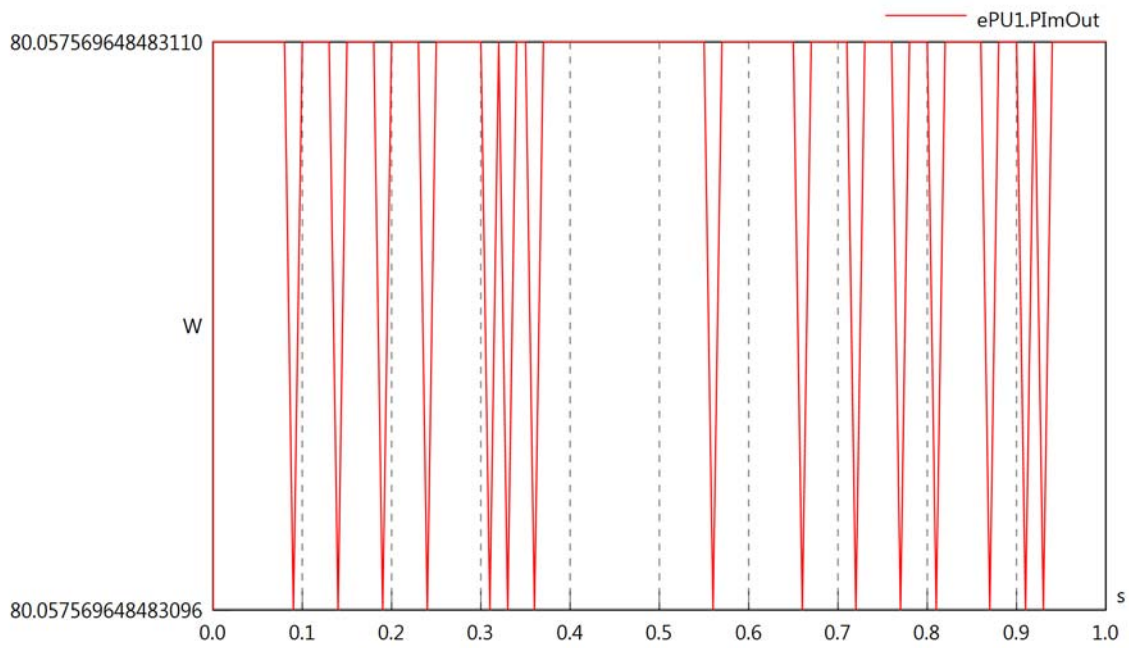

ePU1.SOut

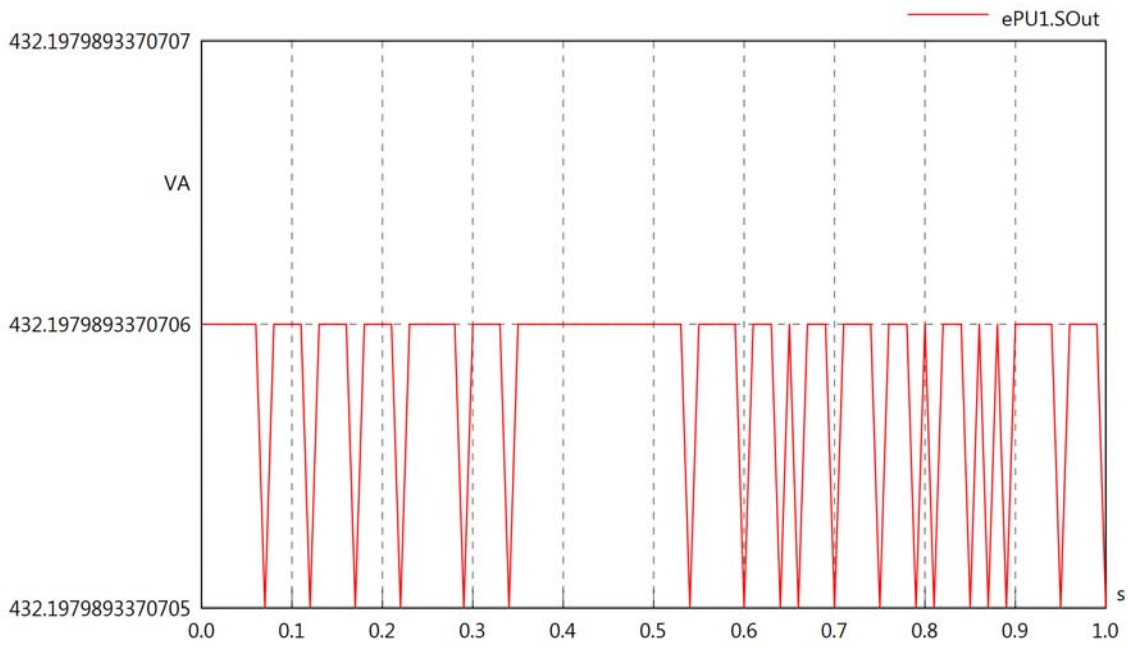
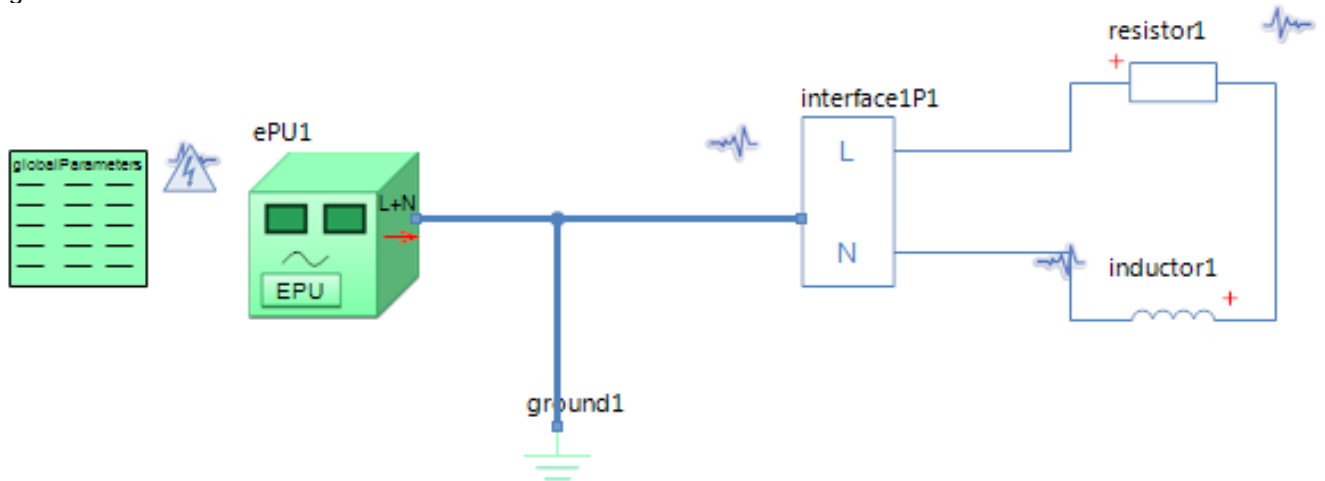

Diagram View



GlobalParameters globalParameters
Parameters

Comment	Name	Current Value	Unit
Type of Calculation	eCalculationKind	Signal Calculation	
Description of Frequency	eFrequencyKind	Linear	
Minimum Frequency	fMin	60	[Hz]
Maximum Frequency	fMax	60	[Hz]

Resistor resistor1
Parameters

Comment	Name	Current Value	Unit
Resistance	R	100	[Ohm]

Inductor inductor1
Parameters

Comment	Name	Current Value	Unit
Inductance	L	100	[mH]

Electrical Power Unit ePU1
Parameters

Comment	Name	Current Value	Unit
EPU or Modem sending on system	sType	EPU sending	
Internal Resistance L1	RL	5	[Ohm]
Internal Resistance N	RN	5	[Ohm]
Sine Wave RMS Voltage (Signal)	VrmsSrcSig	230	[V]
Voltage Offset (Signal)	offsetSig	0	[V]
Voltage Phase Angle	phiV	0	[deg]

ePU1.VrmsOut

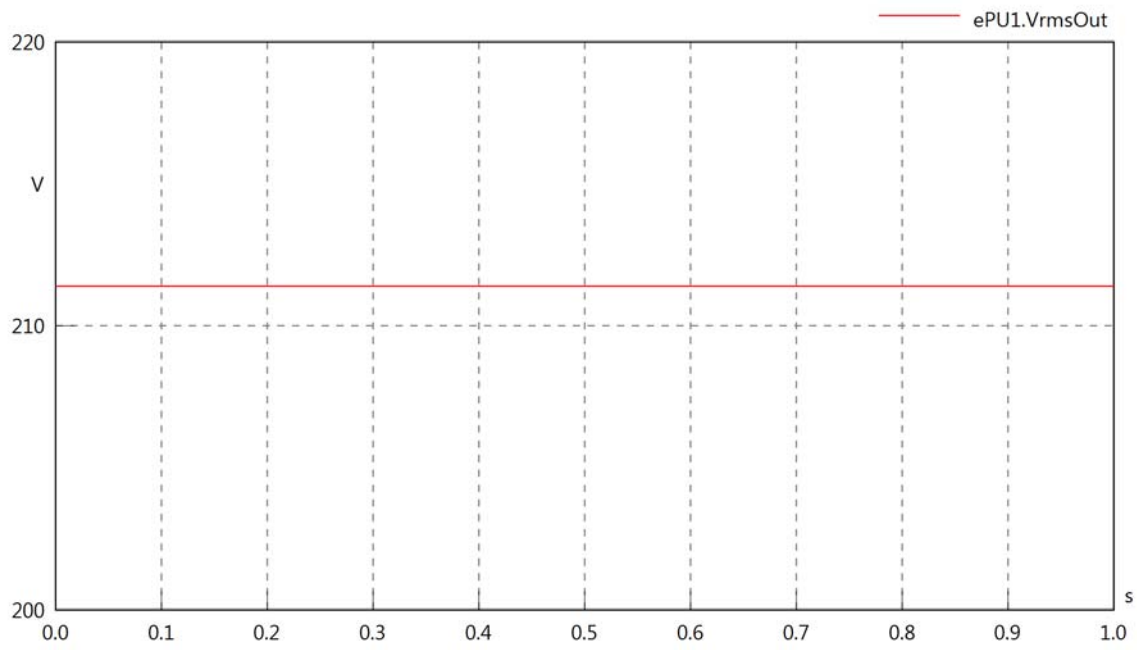

ePU1.vReOut

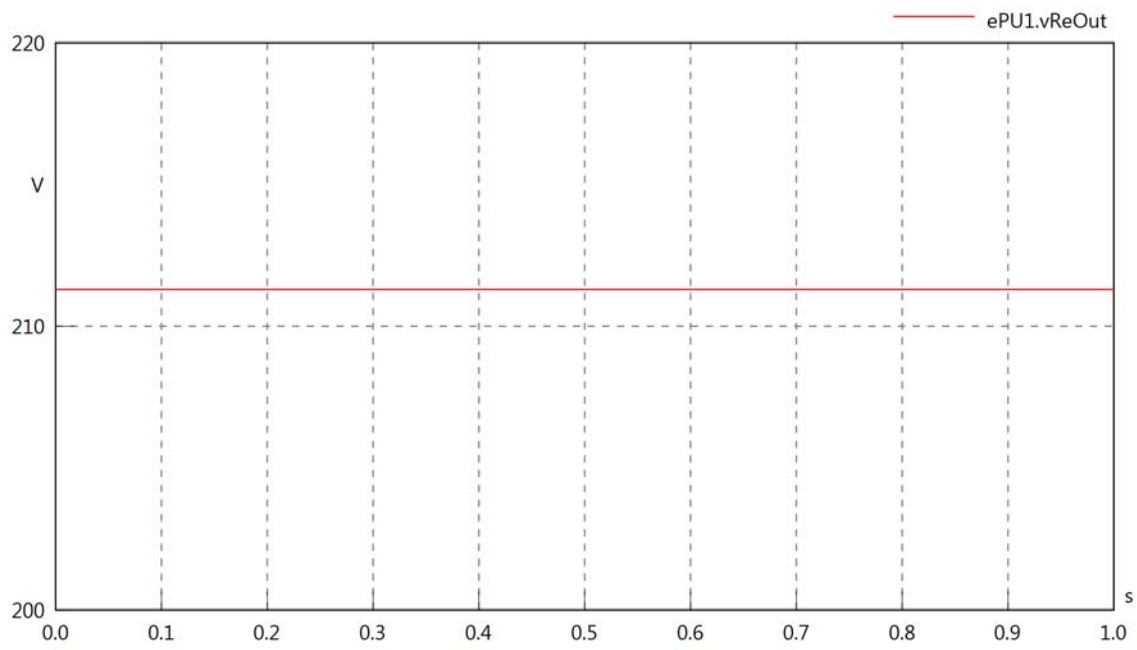

ePU1.vImOut

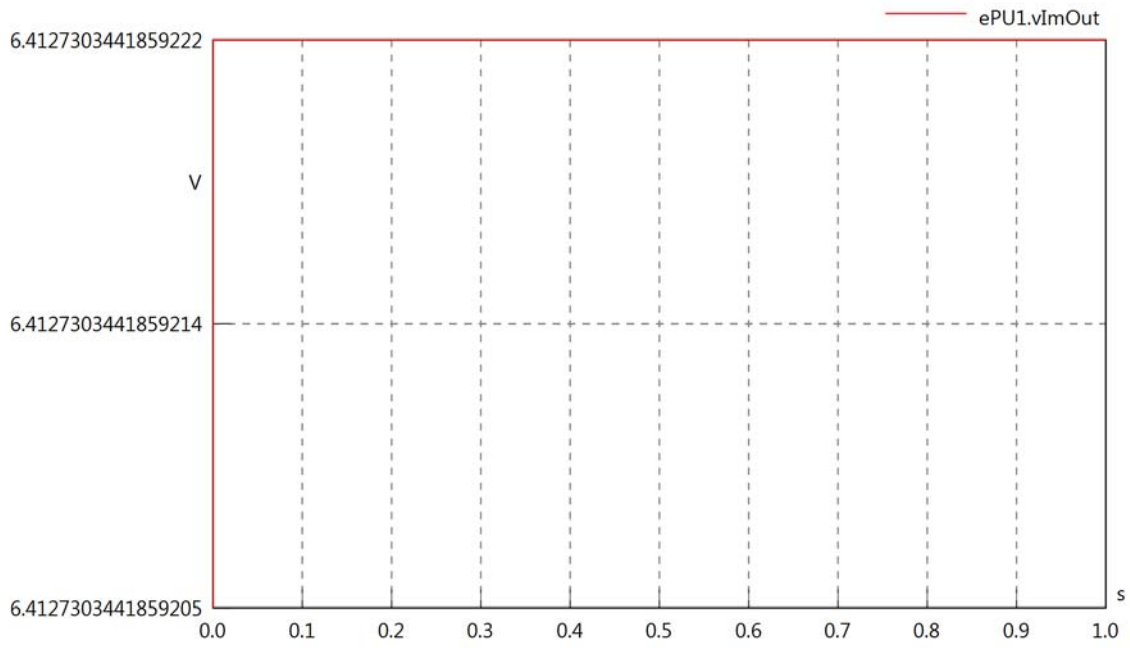

ePU1.IrmsOut

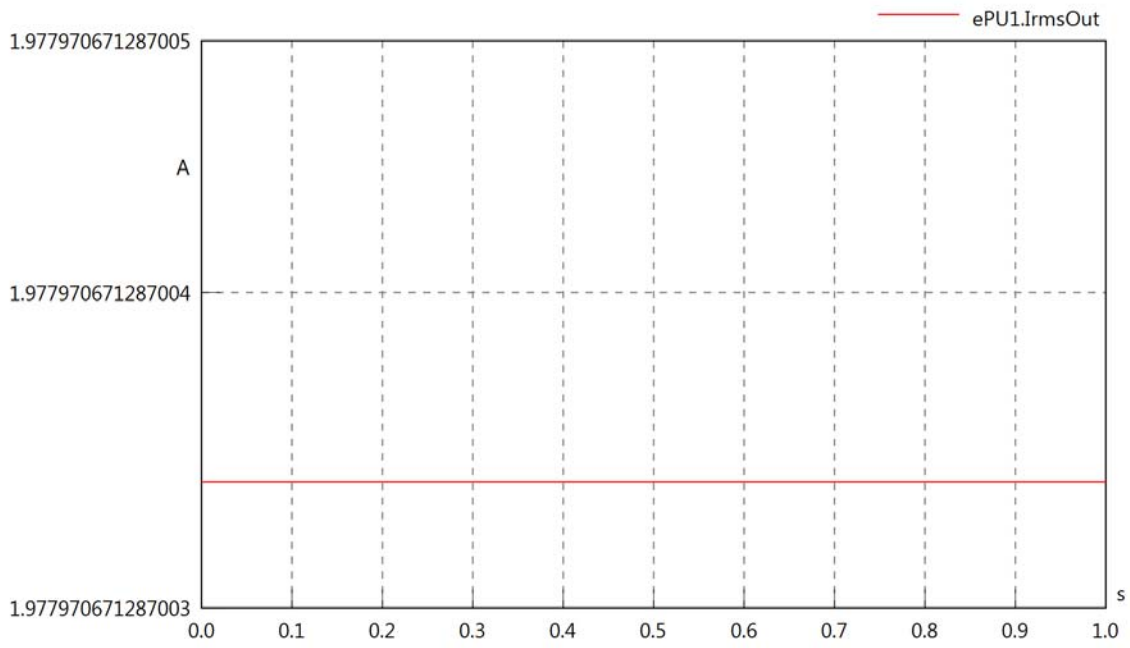

ePU1.iReOut

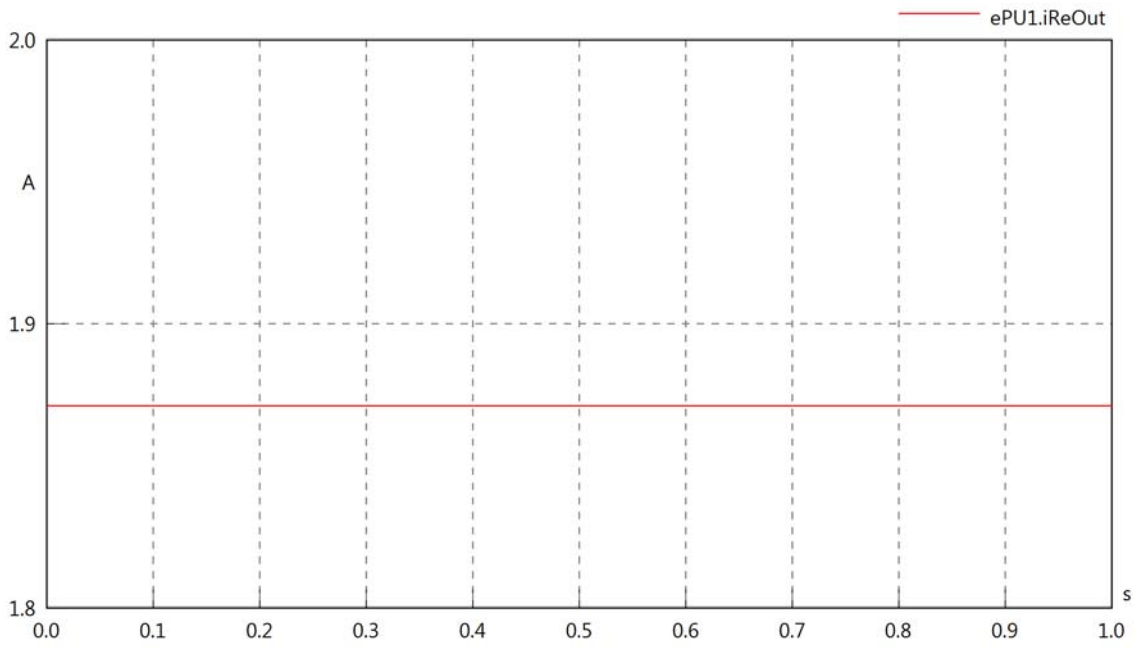

ePU1.iImOut

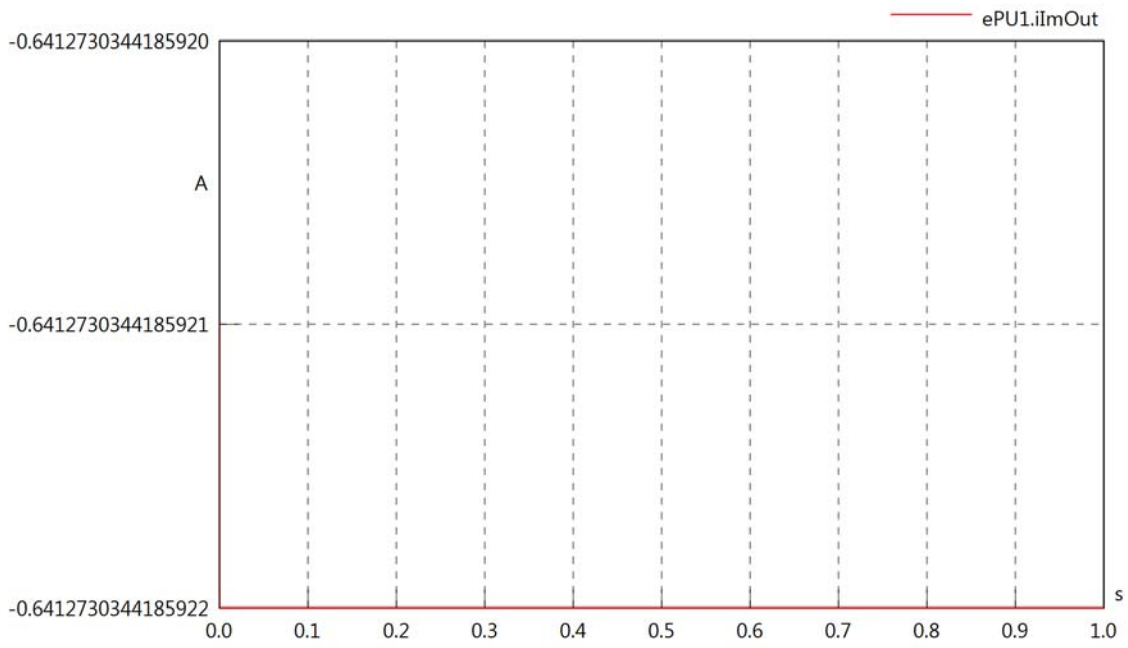

ePU1.phiVOut

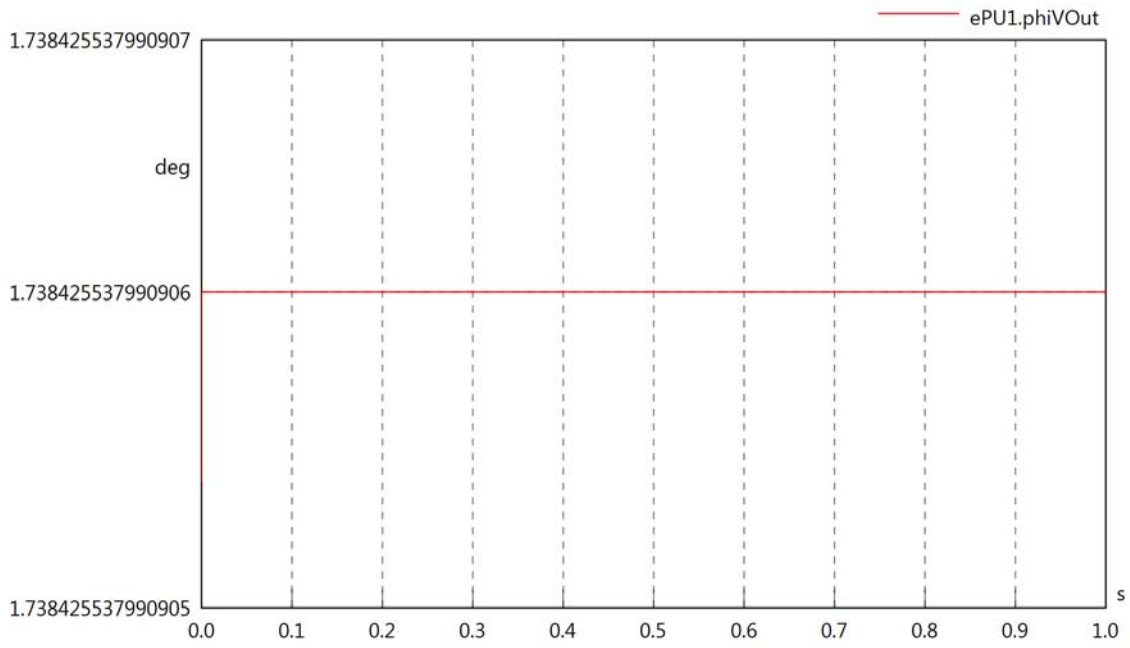

ePU1.phiIOut

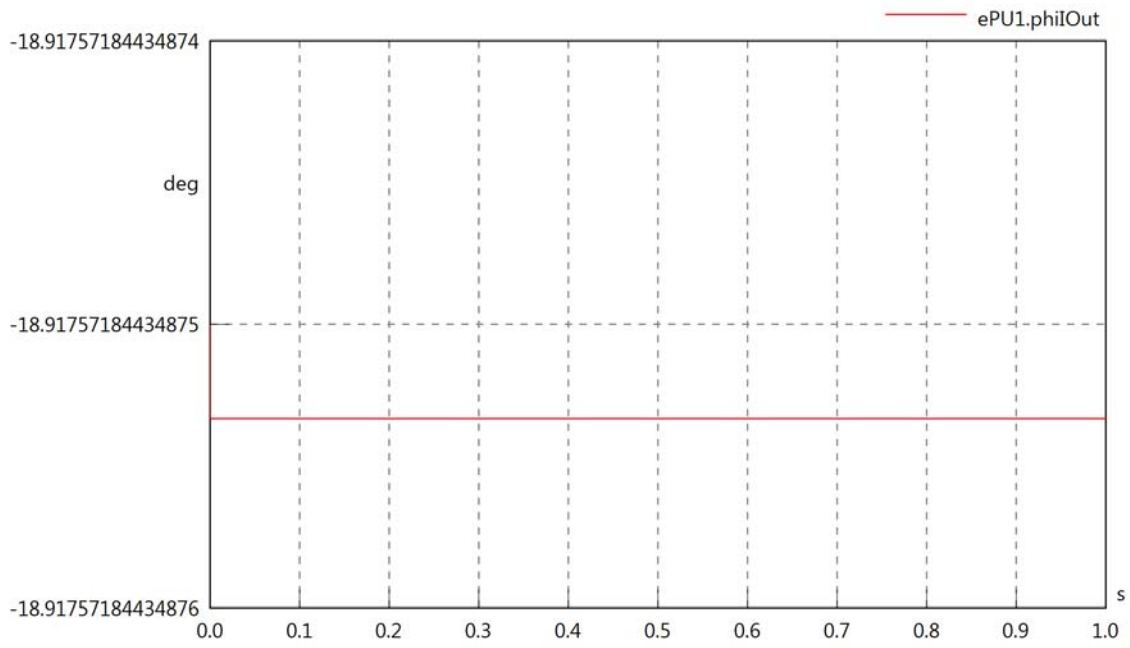

ePU1.phiIVOut

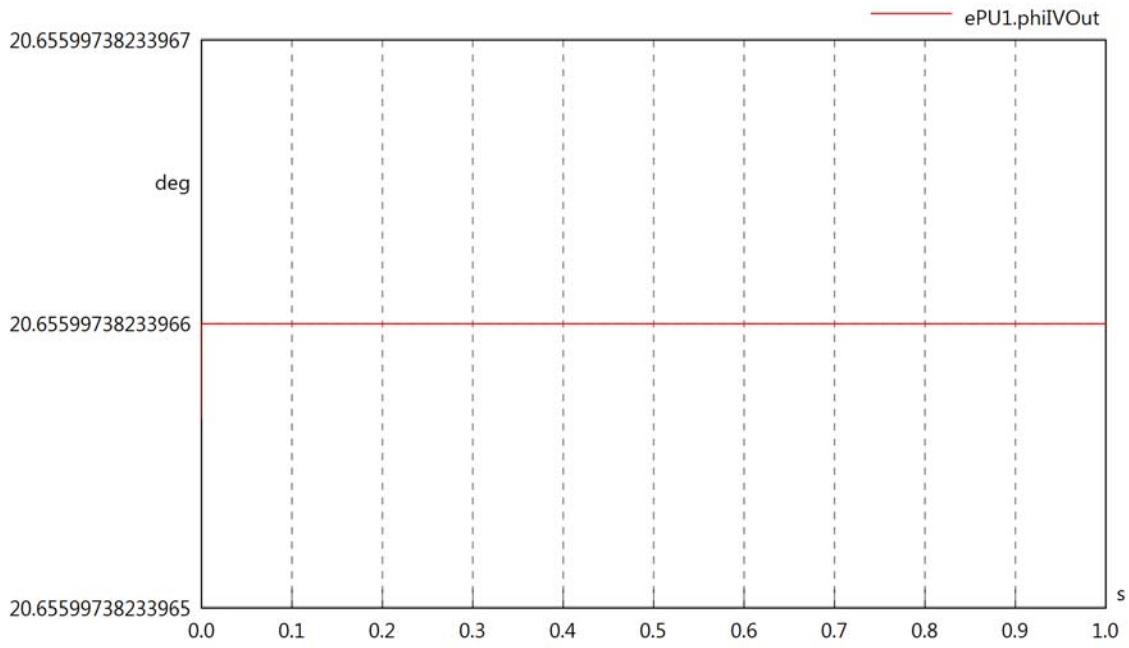

ePU1.PReOut

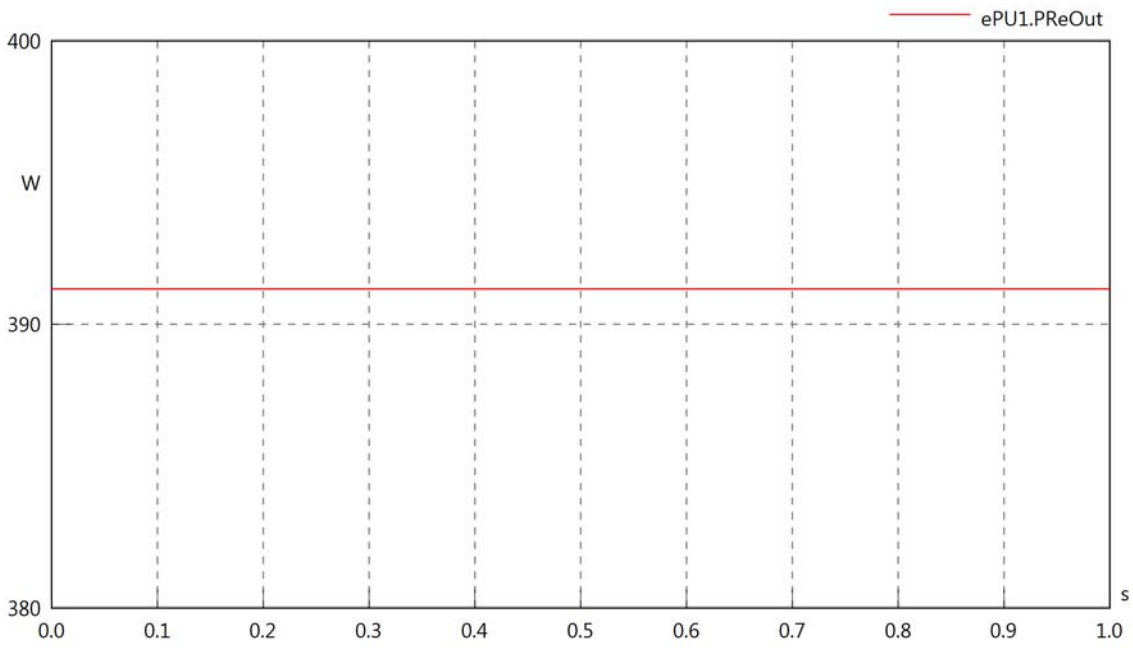

ePU1.PImOut

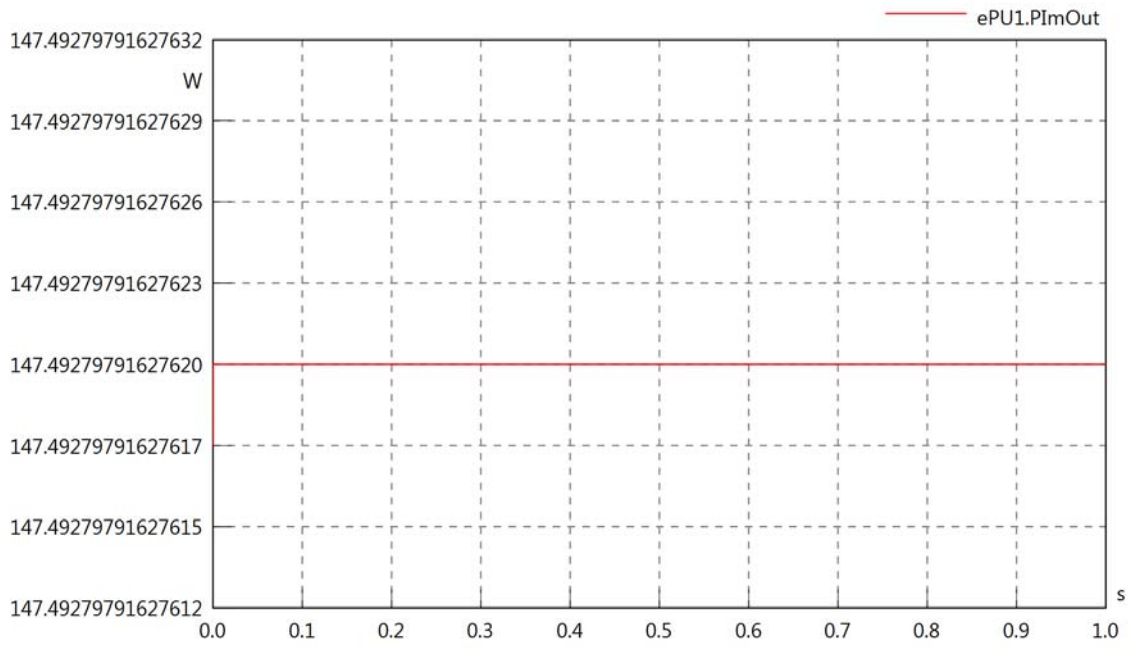

ePU1.SOut

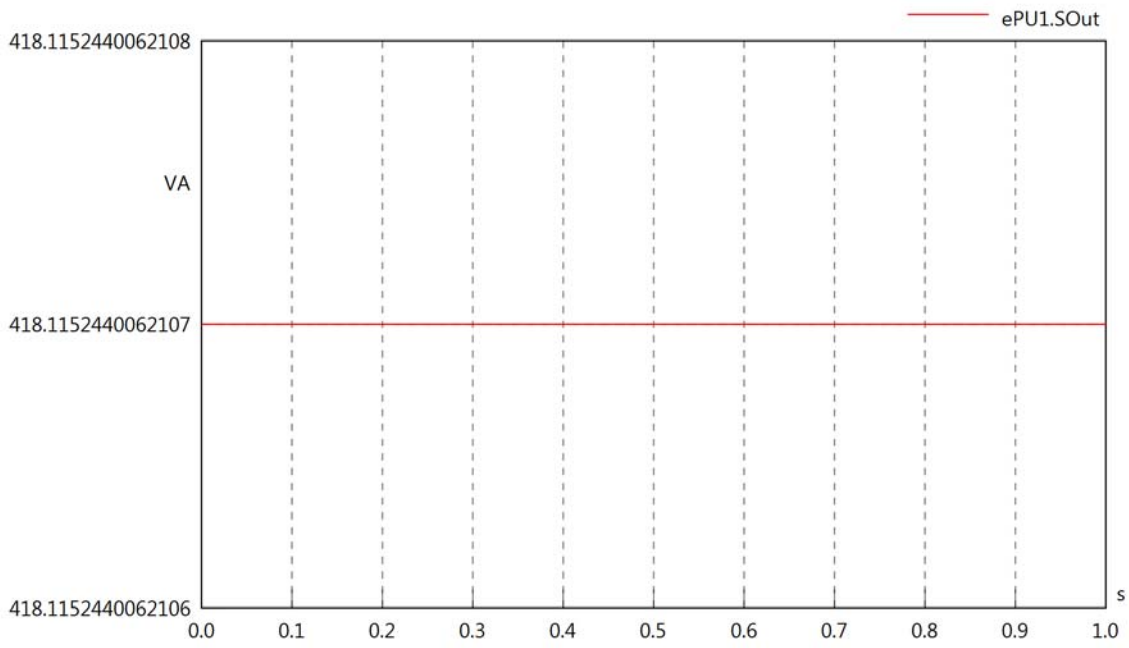
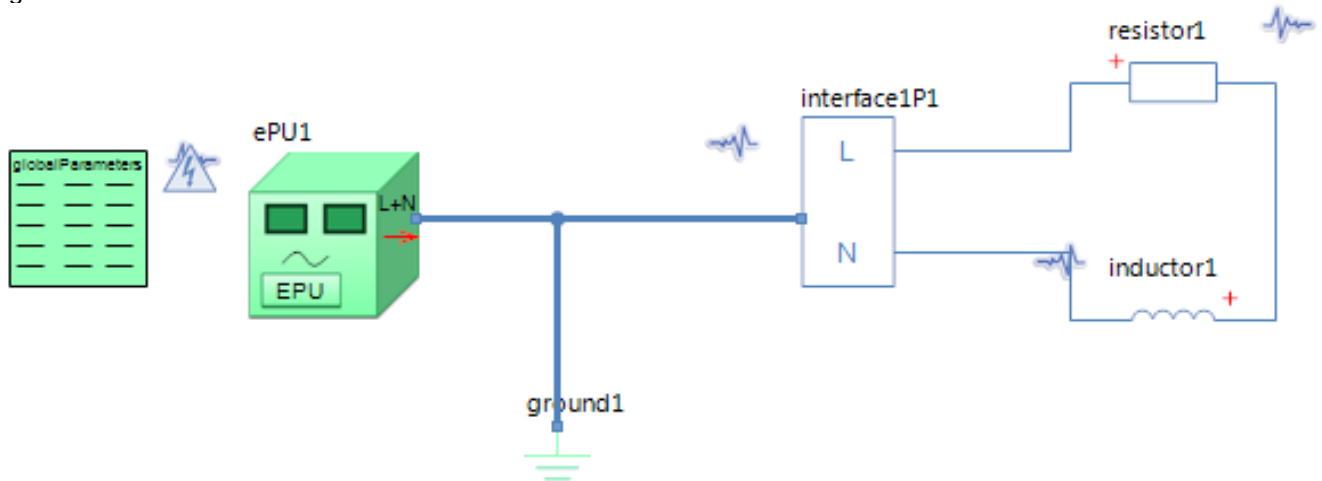

Diagram View



GlobalParameters globalParameters
Parameters

Comment	Name	Current Value	Unit
Type of Calculation	eCalculationKind	Signal Calculation	
Description of Frequency	eFrequencyKind	Linear	
Minimum Frequency	fMin	120	[Hz]
Maximum Frequency	fMax	120	[Hz]

Resistor resistor1
Parameters

Comment	Name	Current Value	Unit
Resistance	R	100	[Ohm]

Inductor inductor1
Parameters

Comment	Name	Current Value	Unit
Inductance	L	100	[mH]

Electrical Power Unit ePU1
Parameters

Comment	Name	Current Value	Unit
EPU or Modem sending on system	sType	EPU sending	
Internal Resistance L1	RL	5	[Ohm]
Internal Resistance N	RN	5	[Ohm]
Sine Wave RMS Voltage (Signal)	VrmsSrcSig	230	[V]
Voltage Offset (Signal)	offsetSig	0	[V]
Voltage Phase Angle	phiV	0	[deg]

ePU1.VrmsOut

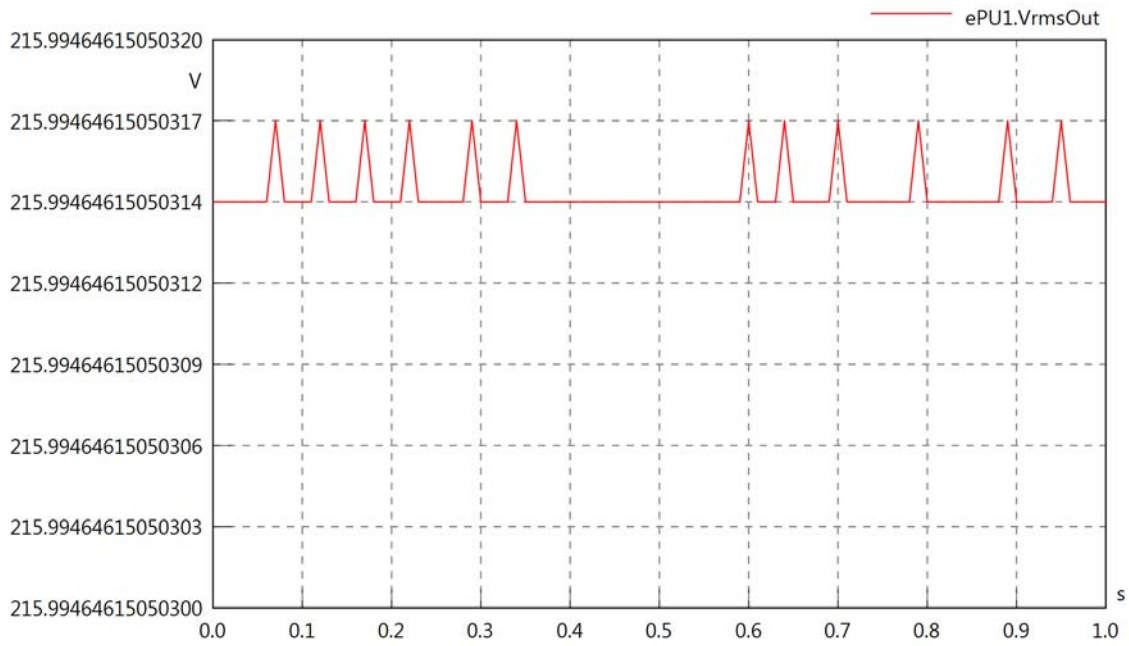

ePU1.vReOut

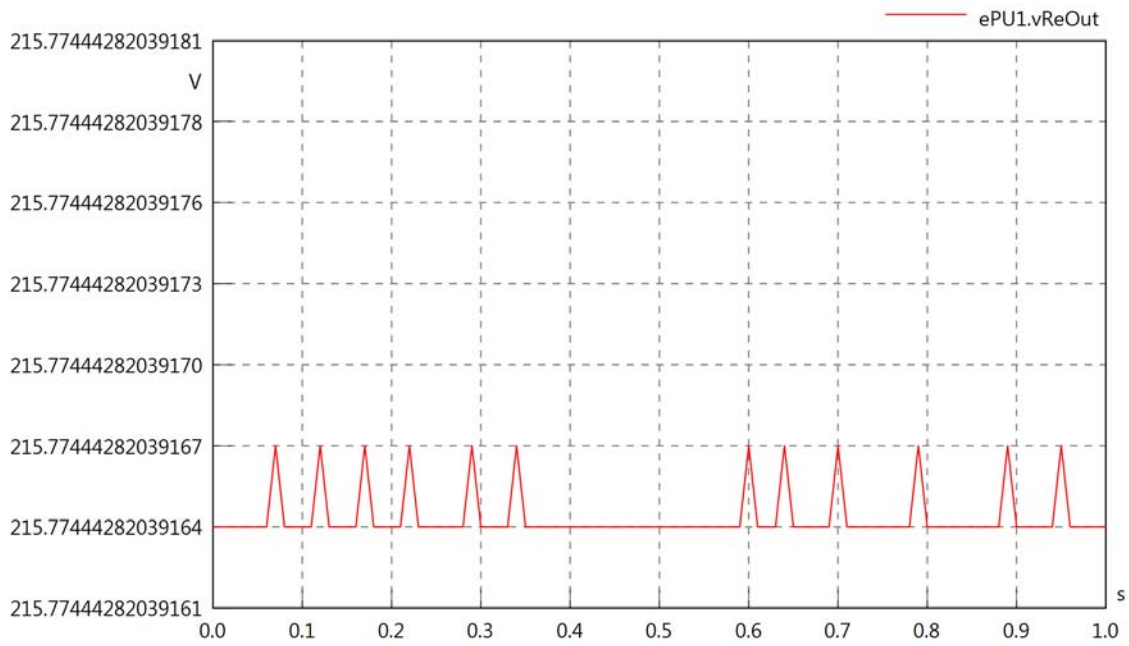

ePU1.vImOut

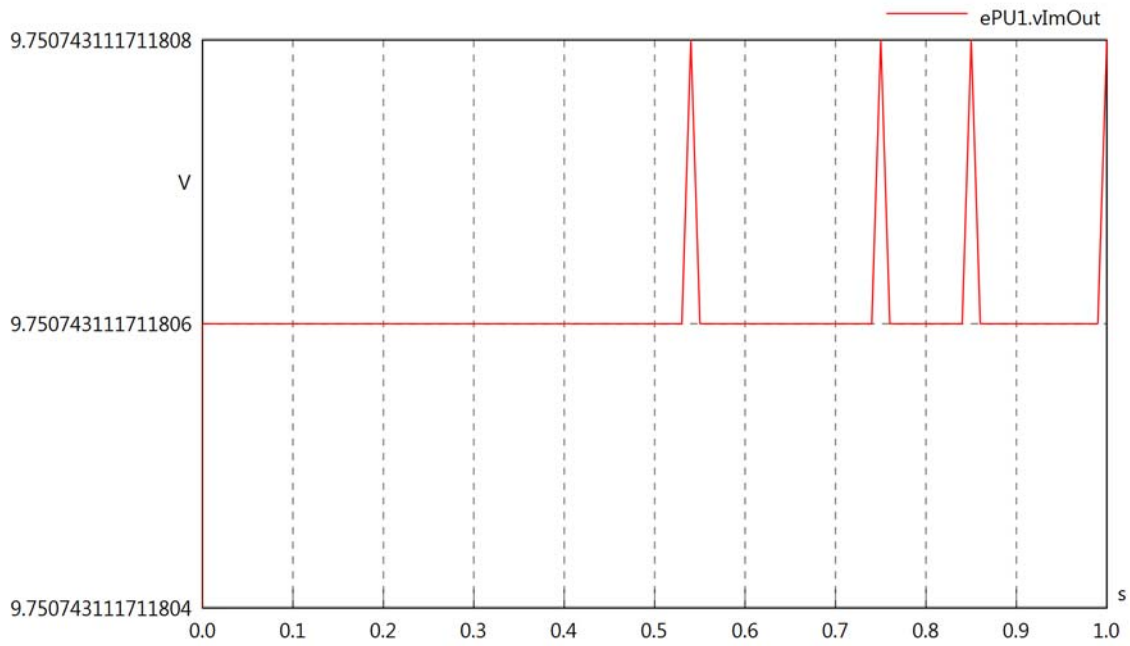

ePU1.IrmsOut

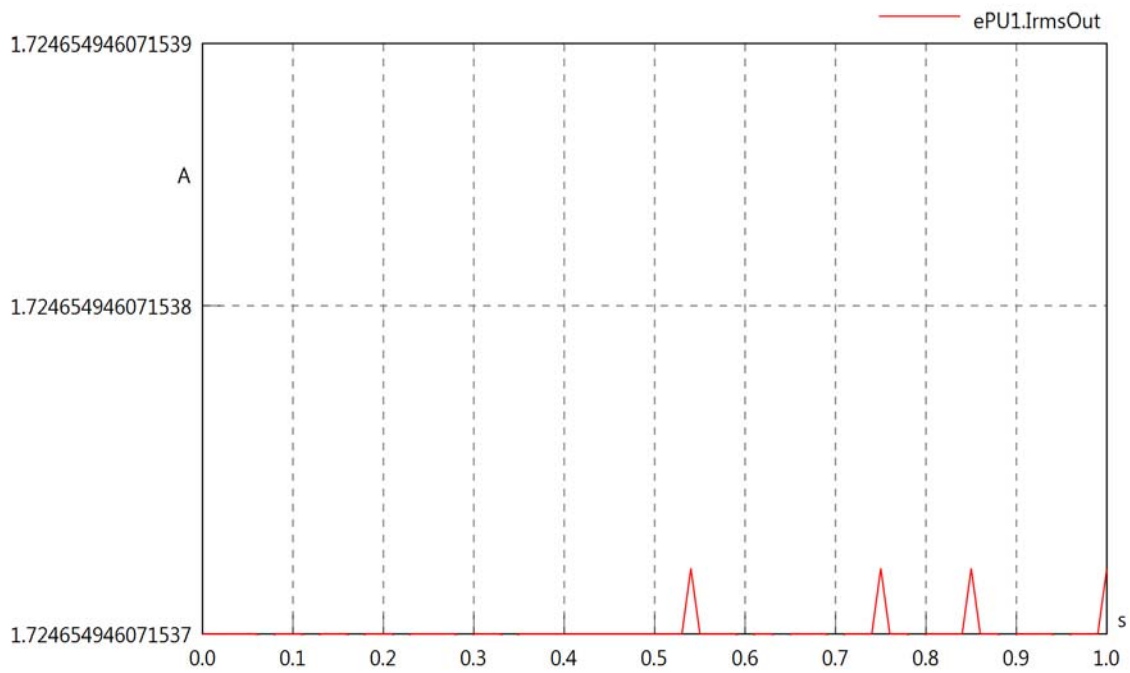

ePU1.iReOut

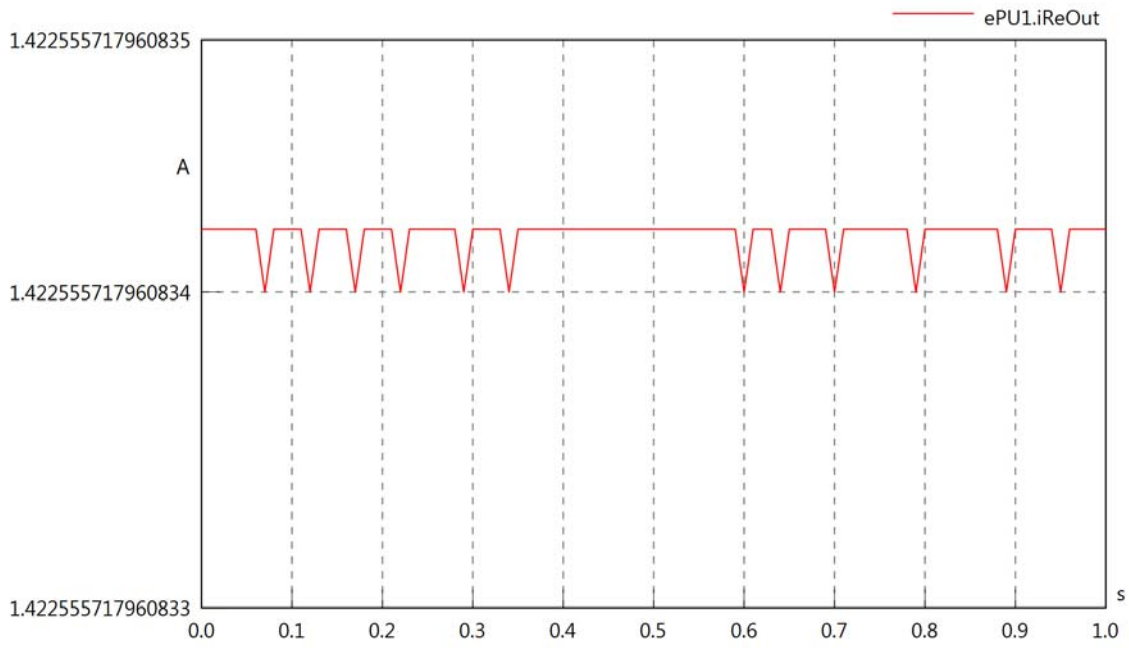

ePU1.iImOut

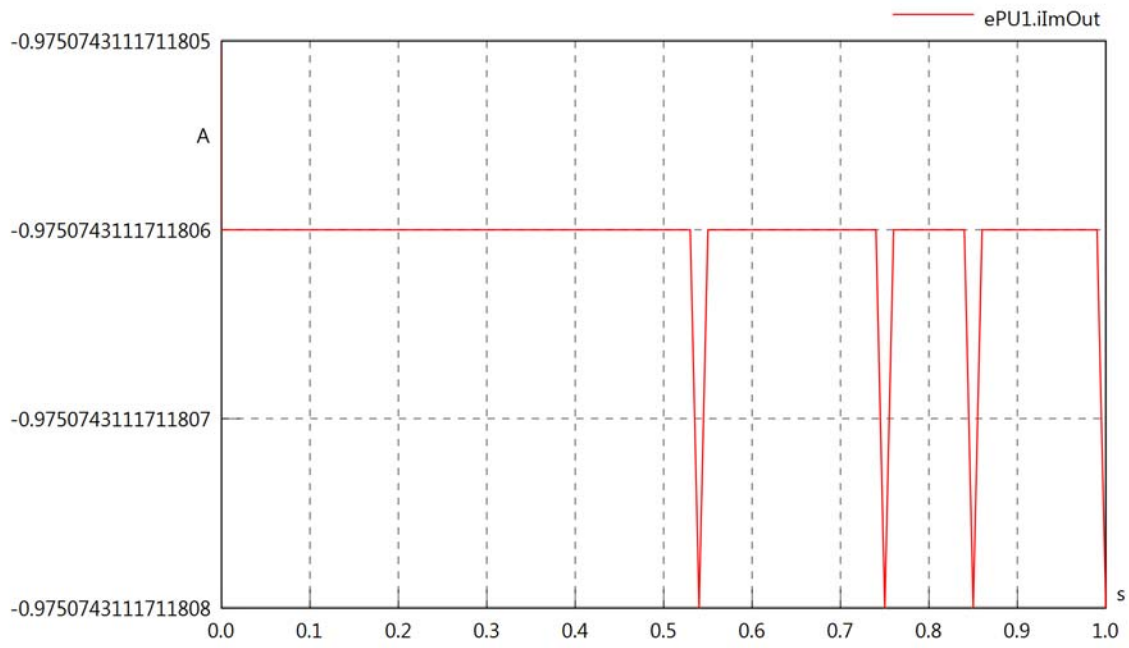

ePU1.phiVOut

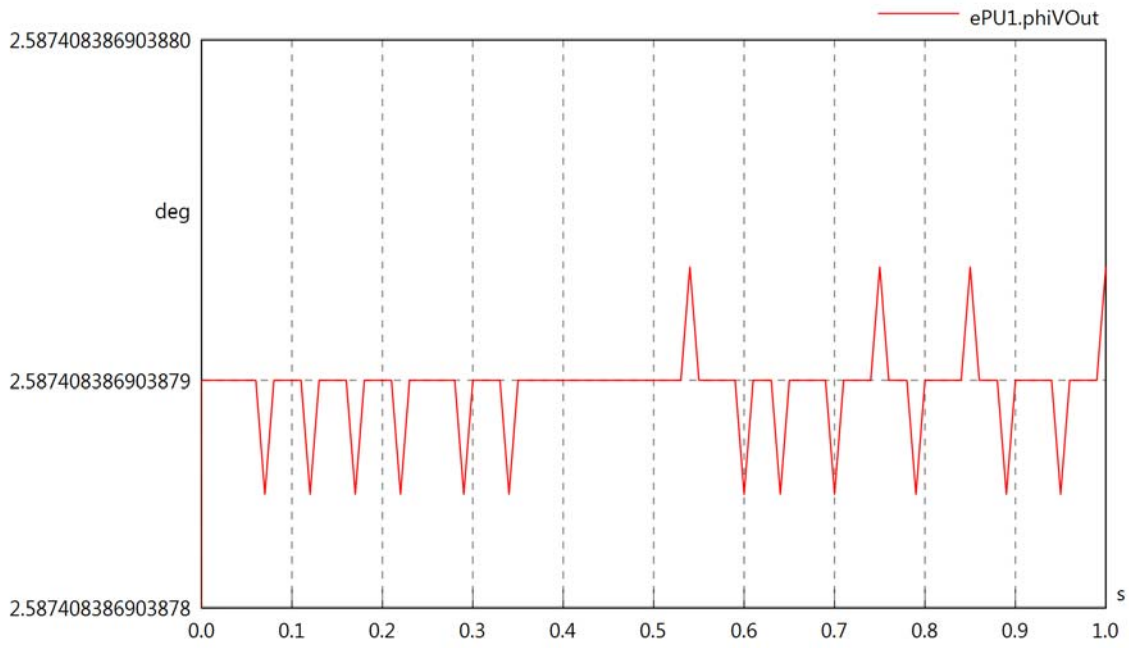

ePU1.phiIOut

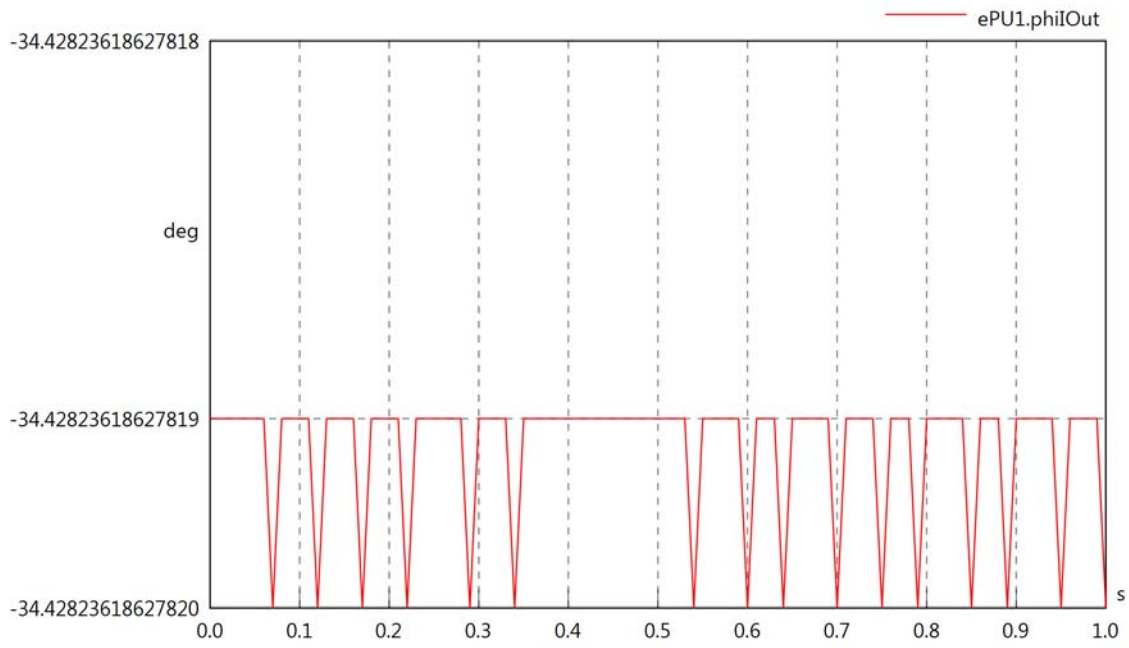

ePU1.phiIVOut

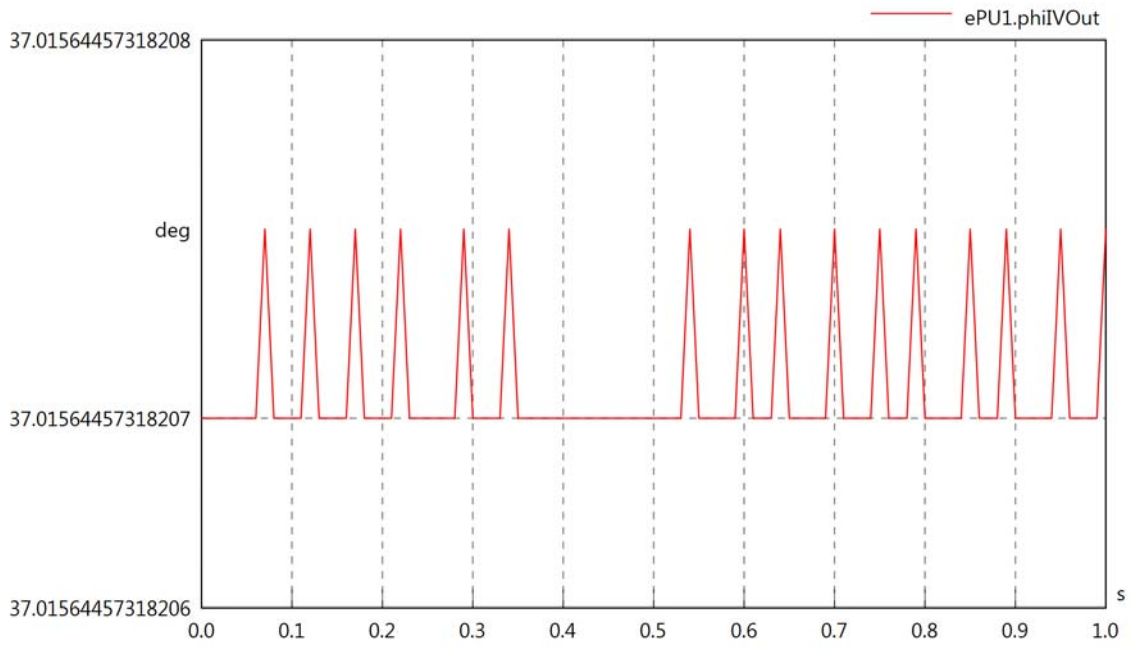

ePU1.PReOut

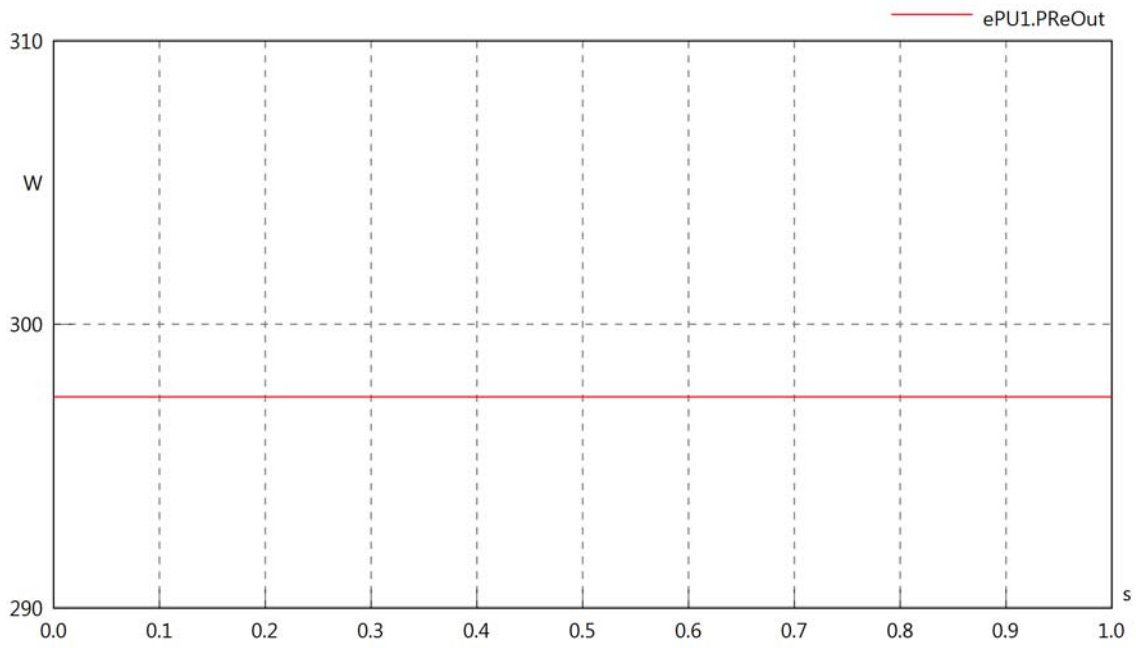

ePU1.PImOut

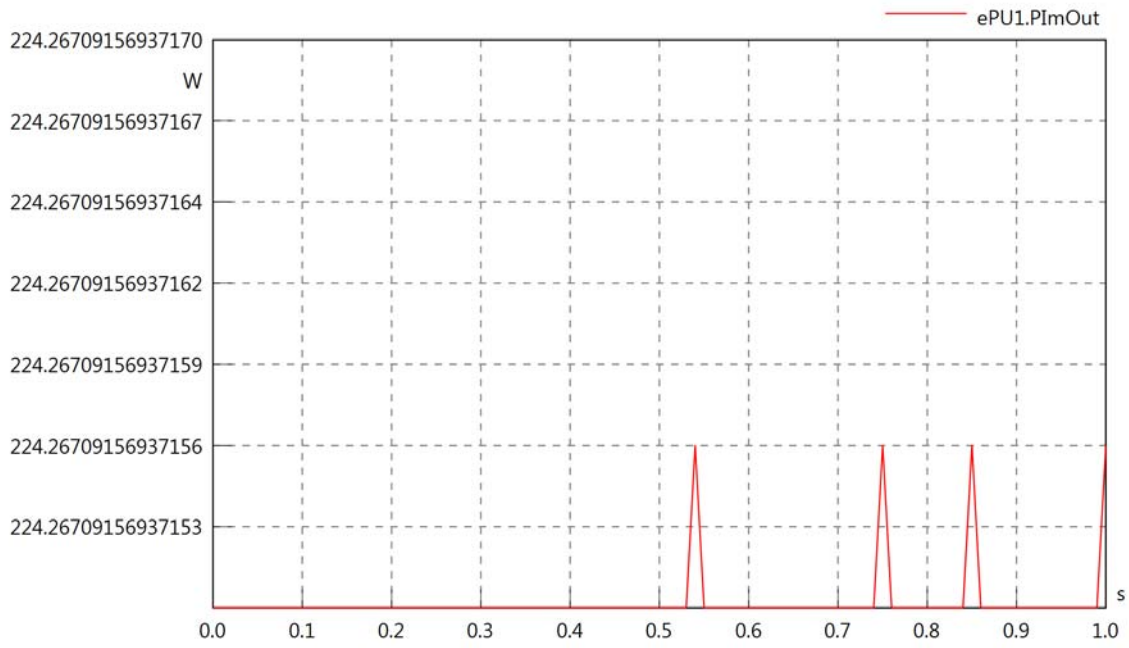

ePU1.SOut

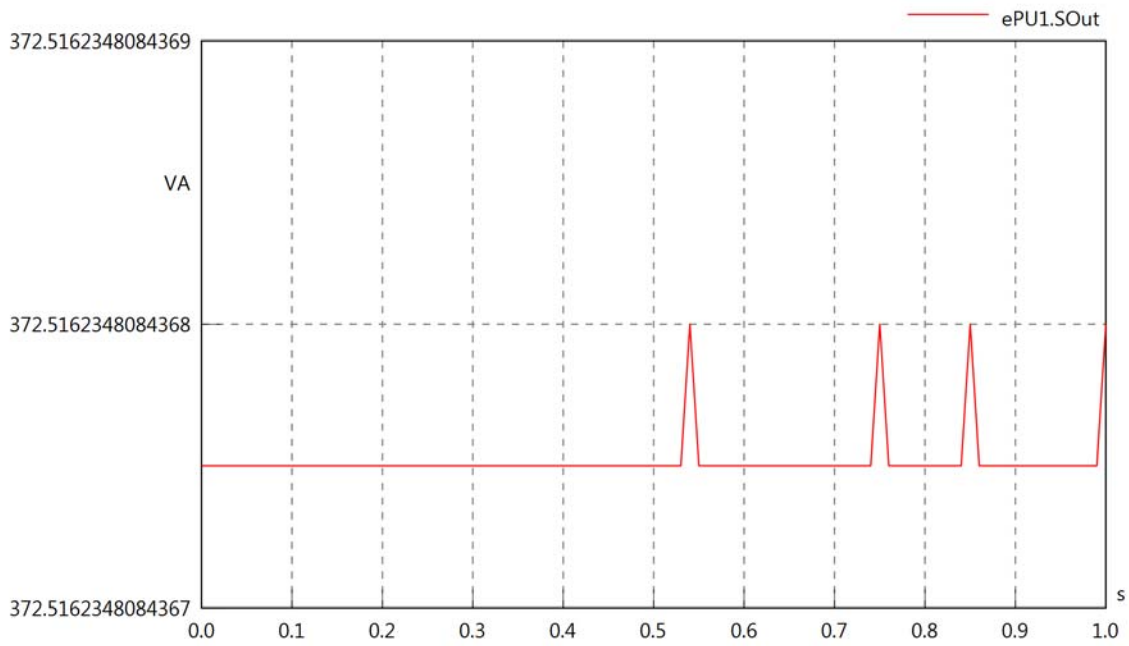
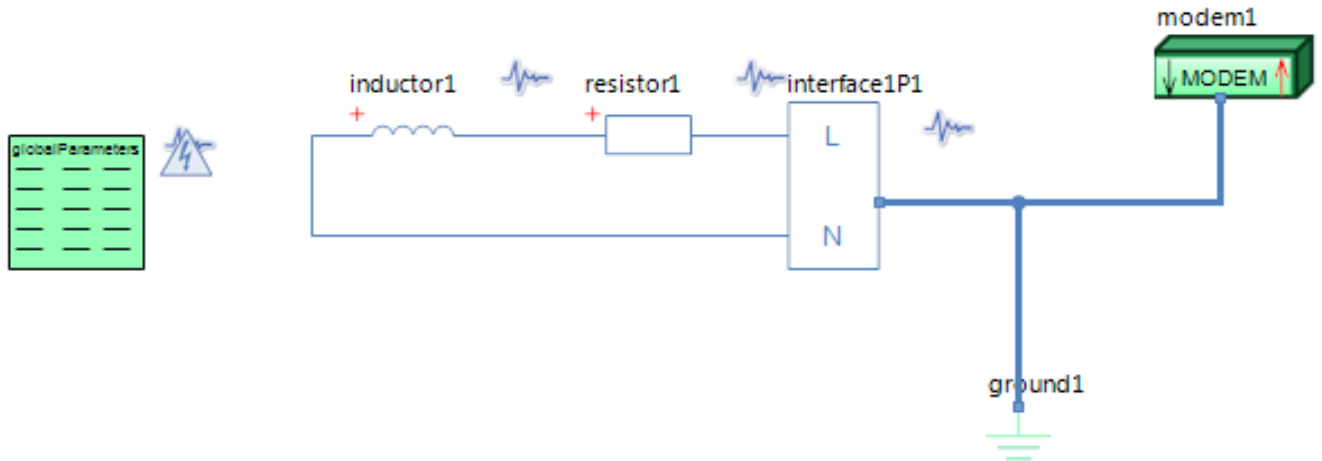

Diagram View



GlobalParameters globalParameters
Parameters

Comment	Name	Current Value	Unit
Type of Calculation	eCalculationKind	Signal Calculation	
Description of Frequency	eFrequencyKind	Linear	
Minimum Frequency	fMin	4	[kHz]
Maximum Frequency	fMax	4	[kHz]

Modem modem1
Parameters

Comment	Name	Current Value	Unit
Modem is sending or receiving	kind	Modem is sending	
Output Resistance	Rout	11	[Ohm]
Voltage or Power input parameter	inKind	Voltage	
Sine Wave RMS Voltage	VrmsSrcSig	5	[V]
Voltage Phase Angle	phiVsig		[deg]

Resistor resistor1
Parameters

Comment	Name	Current Value	Unit
Resistance	R	1500	[Ohm]

Inductor inductor1
Parameters

Comment	Name	Current Value	Unit
Inductance	L	5	[mH]

modem1.VrmsIn

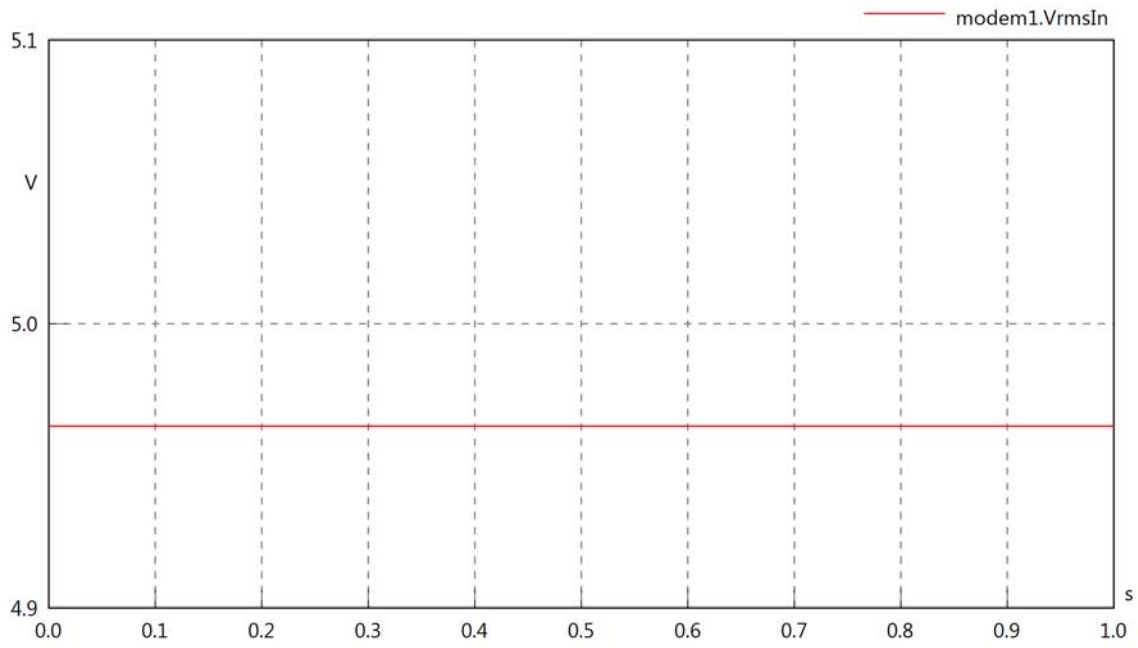

modem1.vReIn

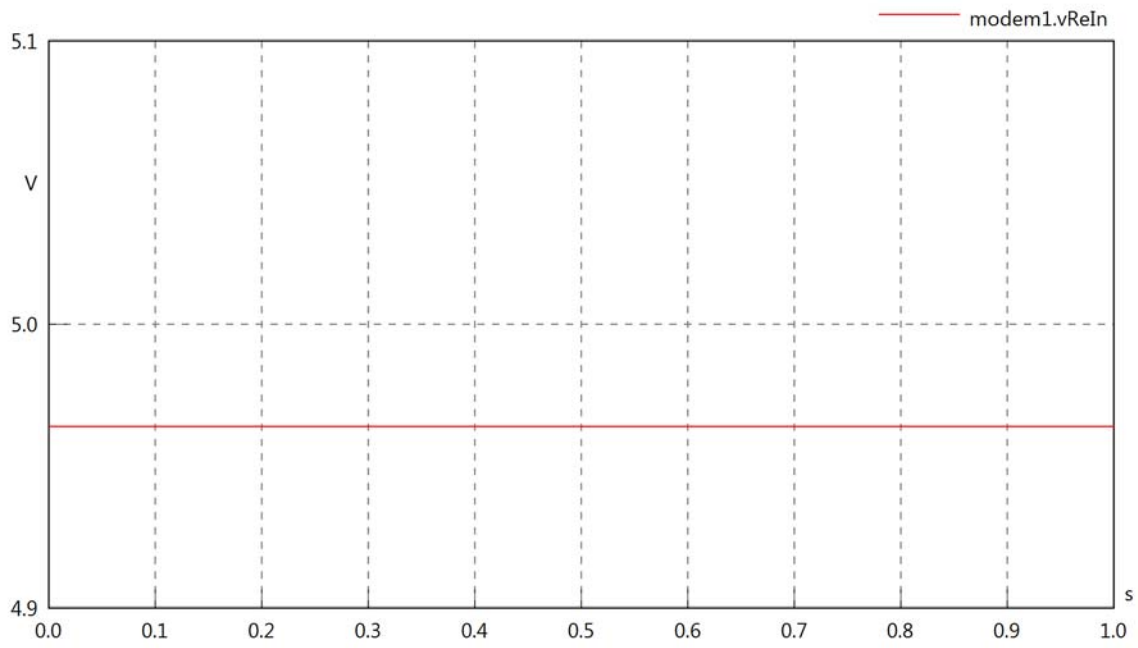

modem1.vImIn

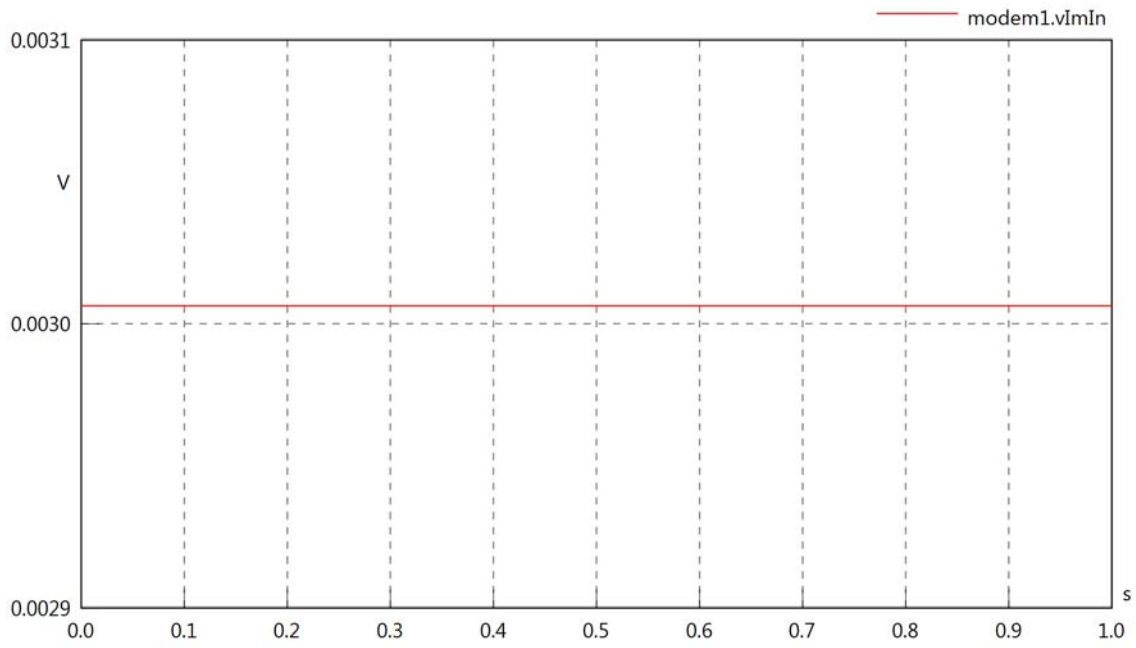

modem1.IrmsIn

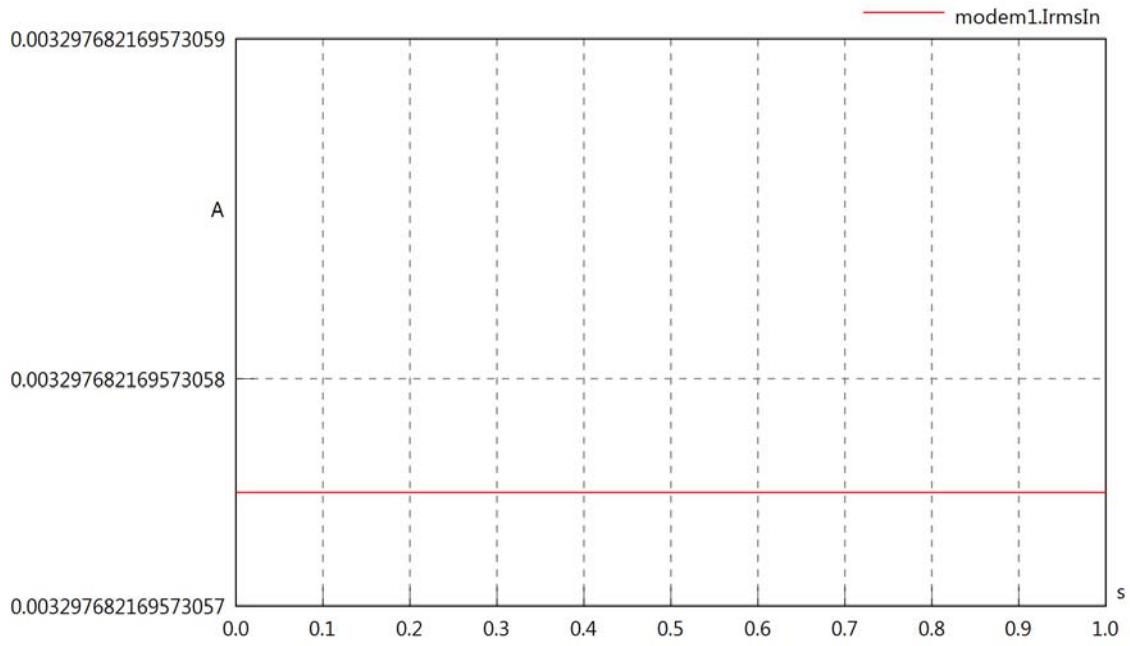

modem1.iReIn

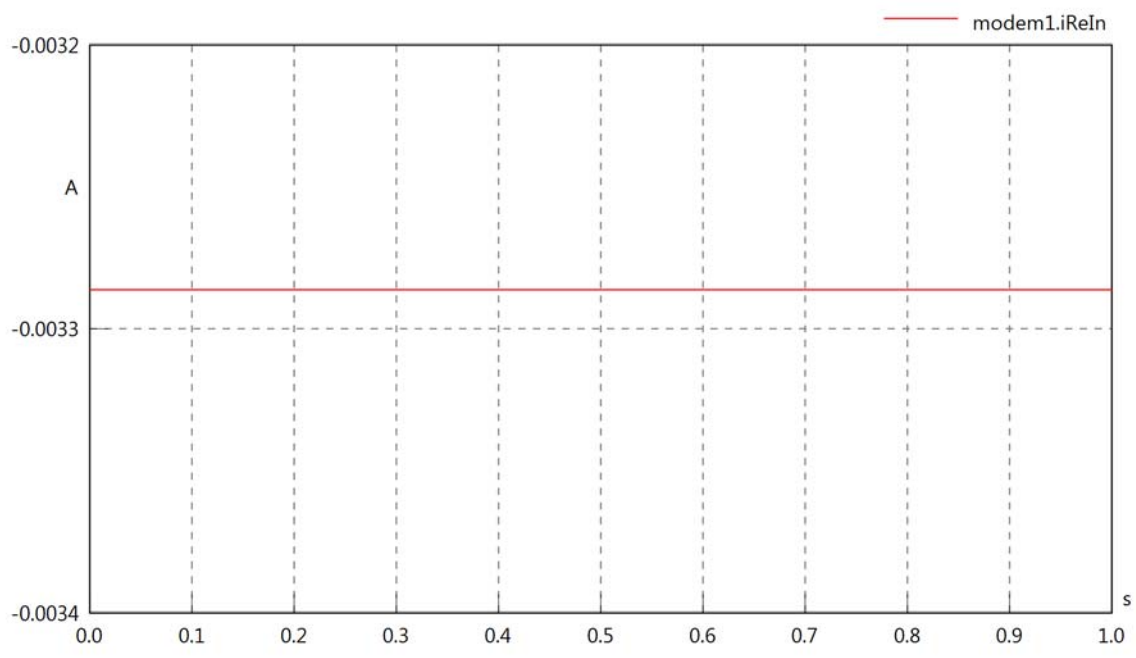

modem1.iImIn

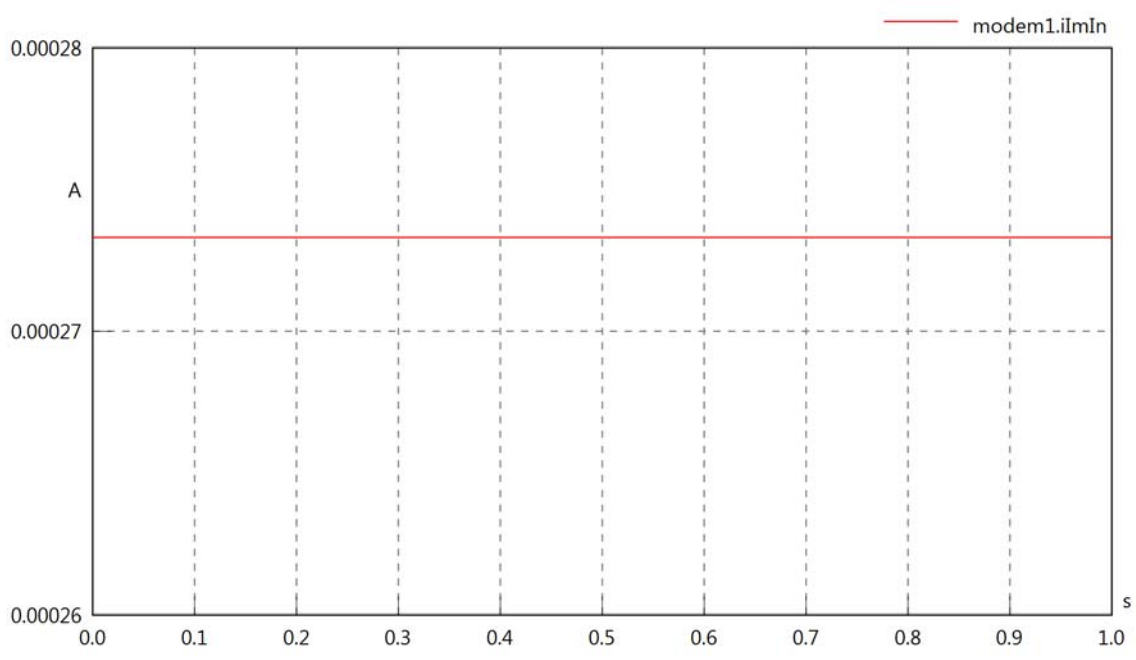

modem1.phiVIn

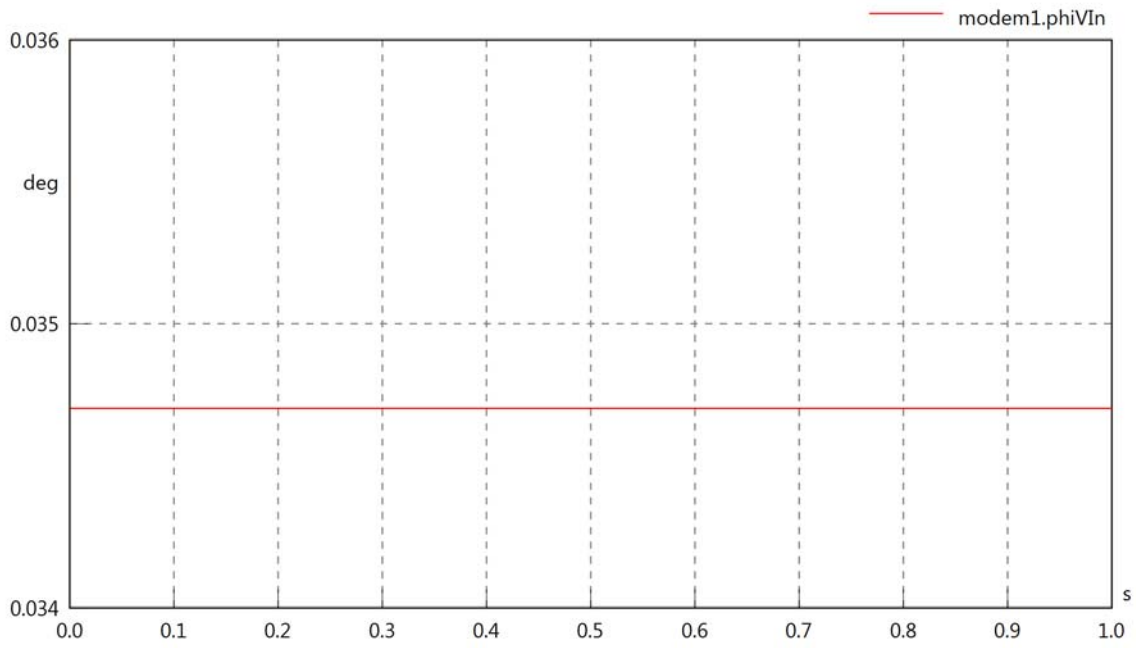

modem1.phiIn

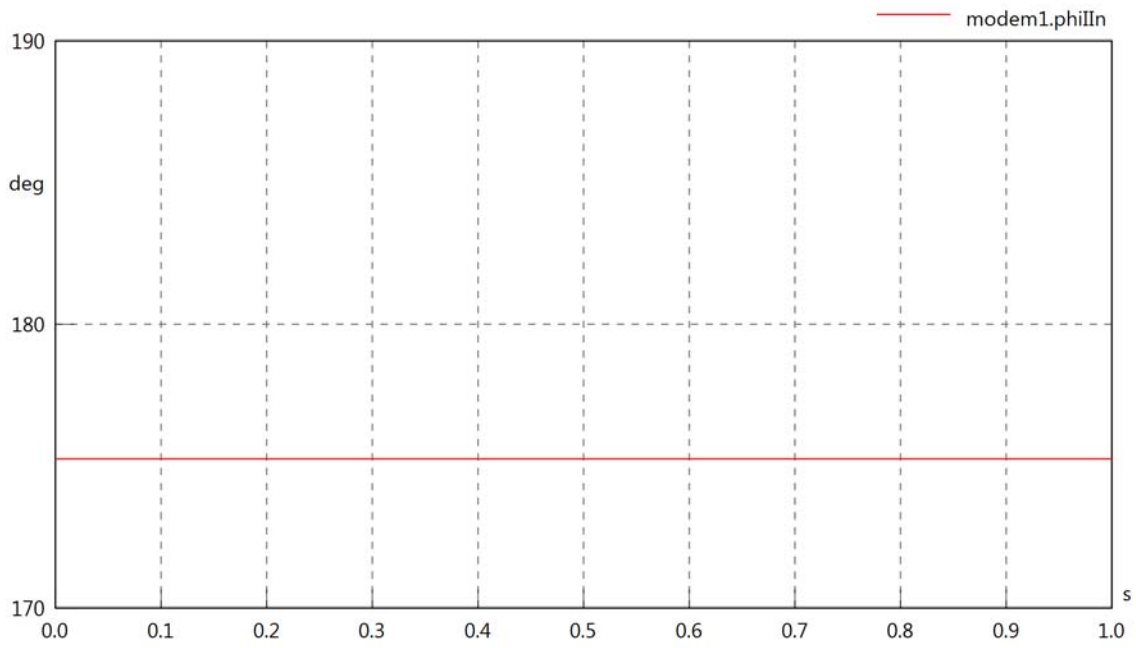

modem1.phiIVIn

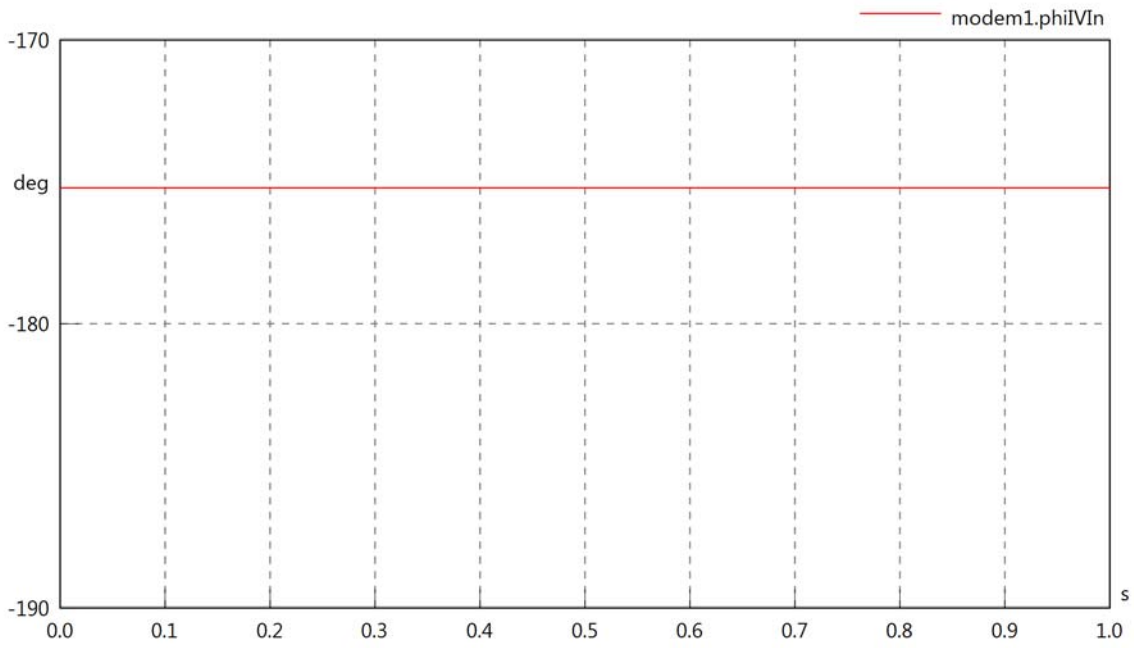

modem1.PReIn

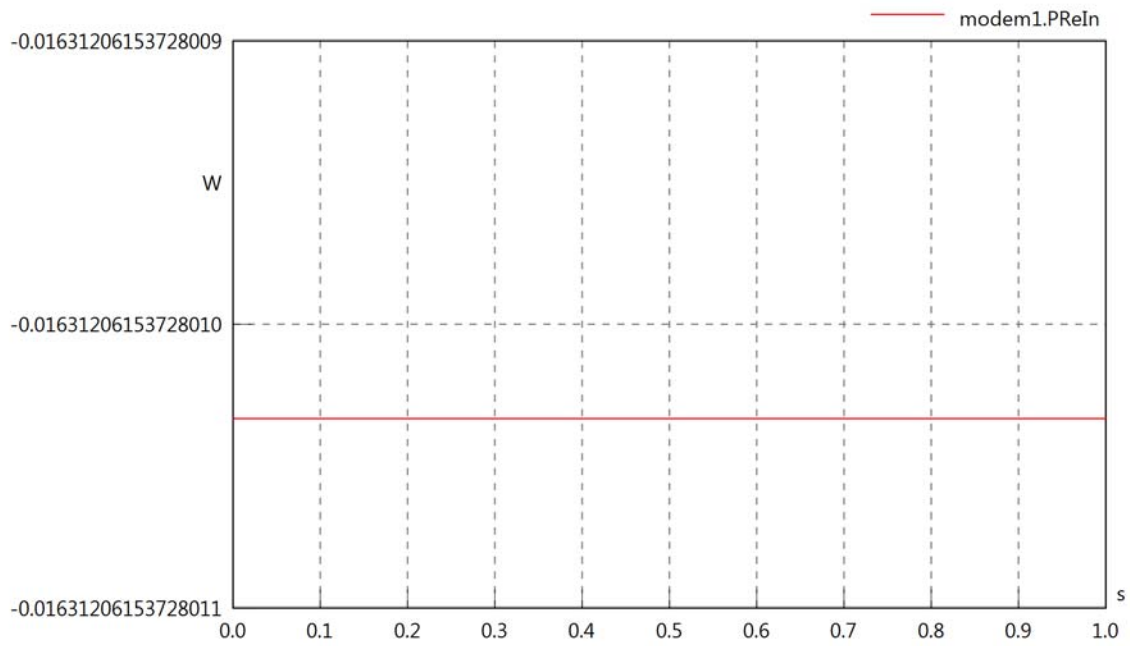

modem1.PImIn

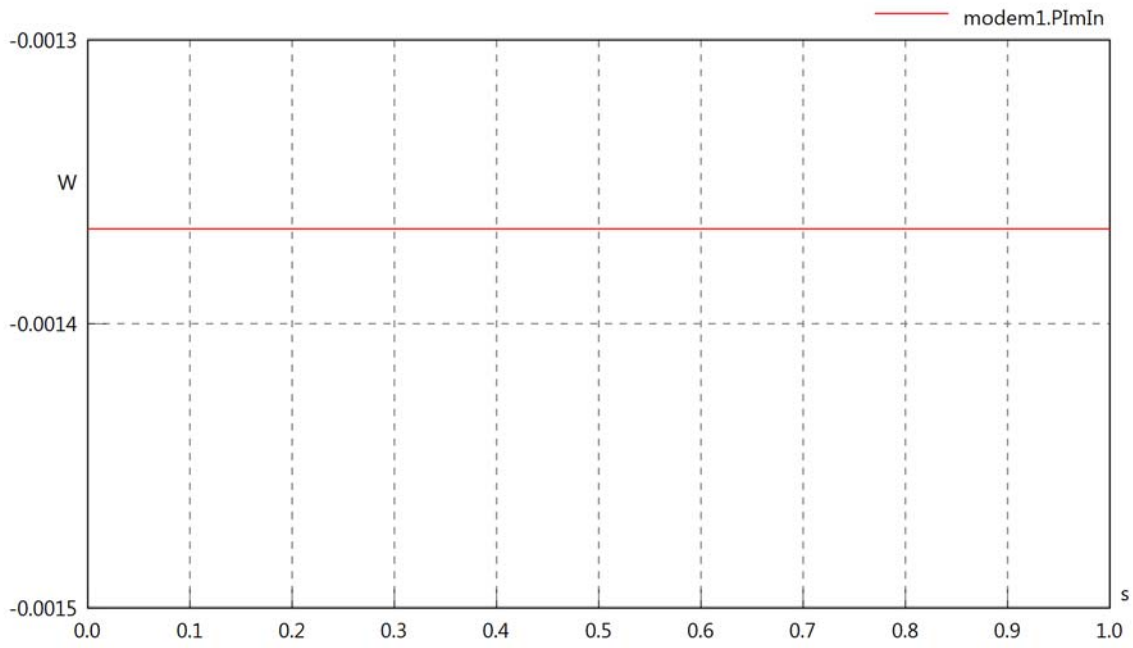

modem1.SIn

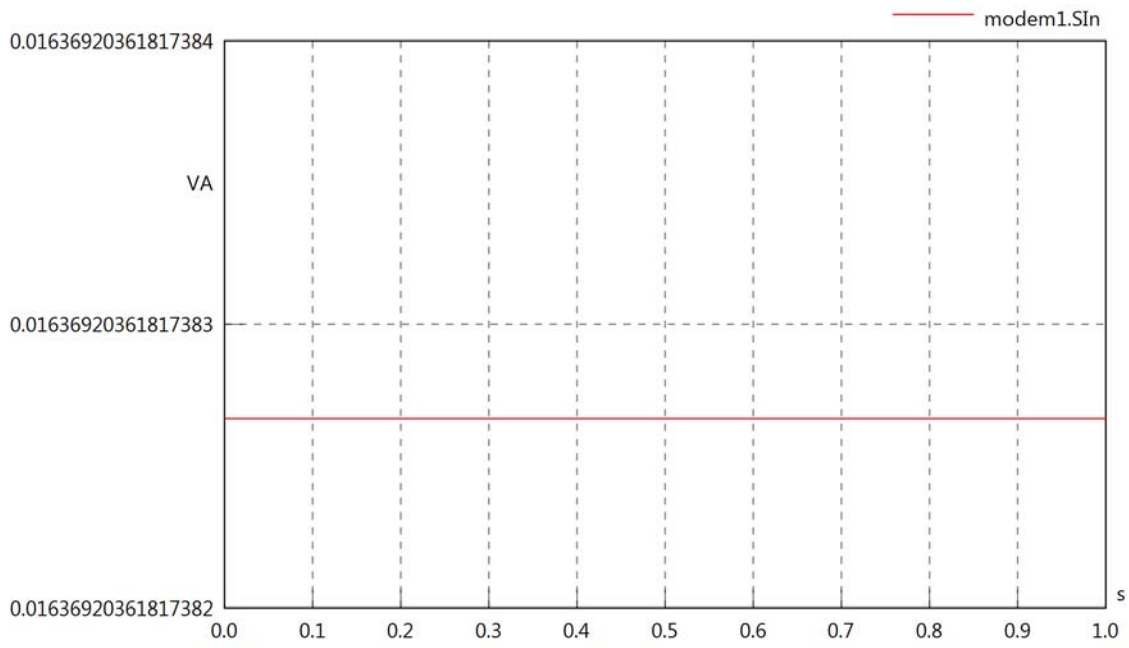
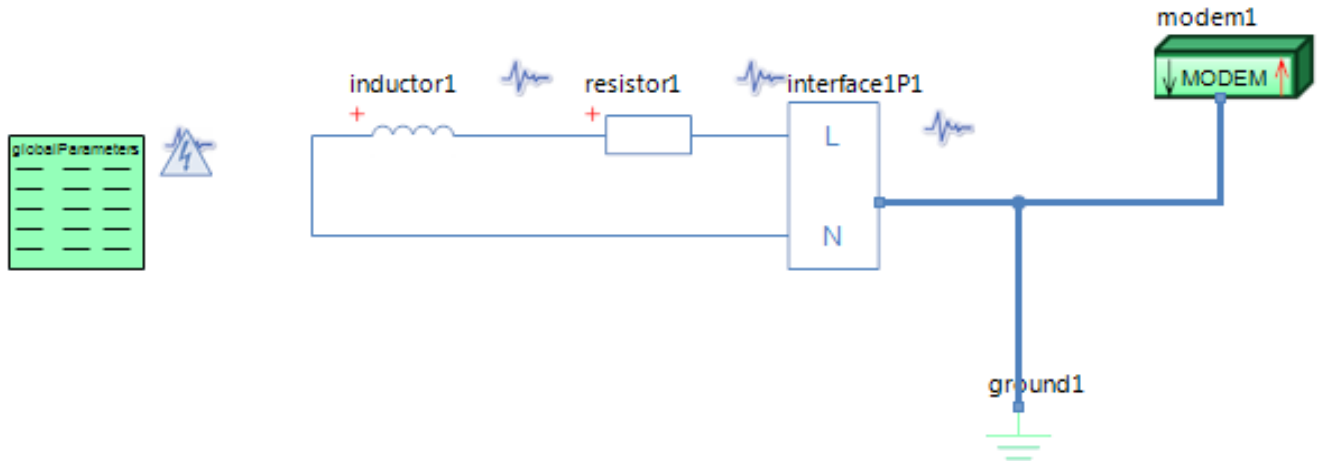

Diagram View



GlobalParameters globalParameters
Parameters

Comment	Name	Current Value	Unit
Type of Calculation	eCalculationKind	Signal Calculation	
Description of Frequency	eFrequencyKind	Linear	
Minimum Frequency	fMin	20	[kHz]
Maximum Frequency	fMax	20	[kHz]

Modem modem1
Parameters

Comment	Name	Current Value	Unit
Modem is sending or receiving	kind	Modem is sending	
Output Resistance	Rout	11	[Ohm]
Voltage or Power input parameter	inKind	Voltage	
Sine Wave RMS Voltage	VrmsSrcSig	5	[V]
Voltage Phase Angle	phiVsig		[deg]

Resistor resistor1
Parameters

Comment	Name	Current Value	Unit
Resistance	R	1500	[Ohm]

Inductor inductor1
Parameters

Comment	Name	Current Value	Unit
Inductance	L	5	[mH]

modem1.VrmsIn

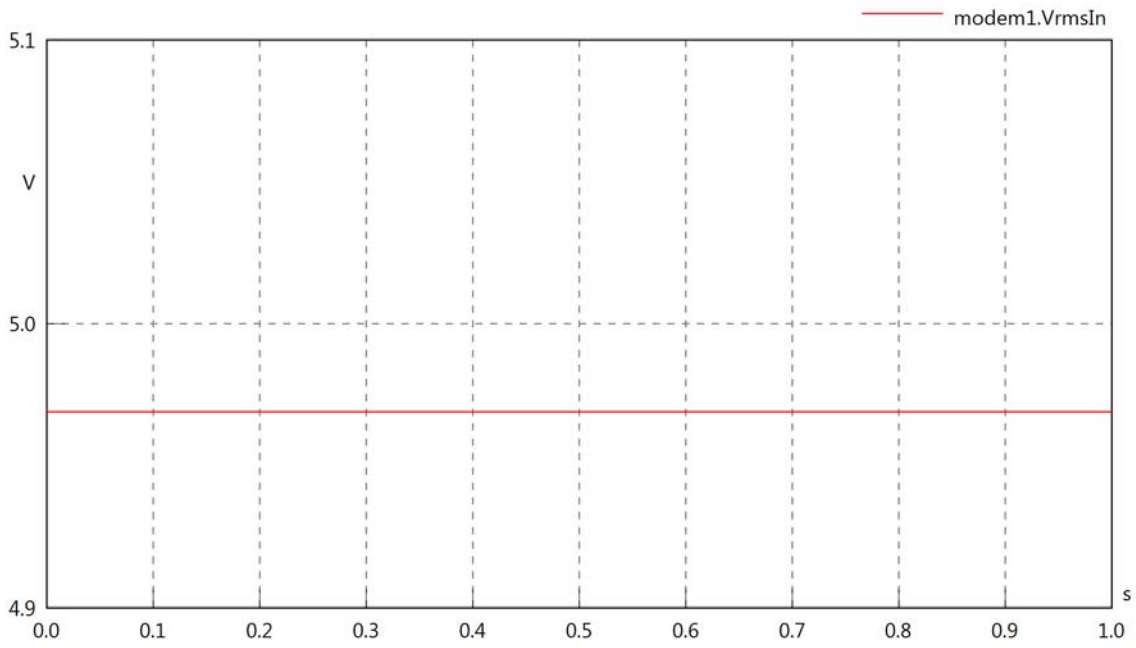

modem1.vReIn

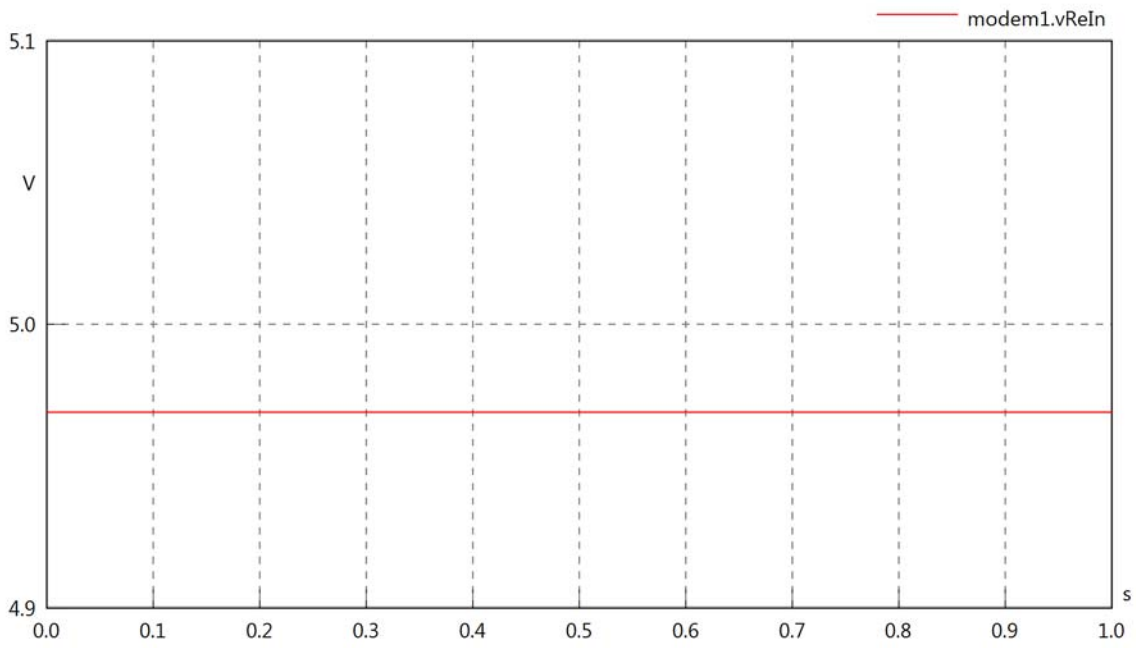

modem1.vImIn

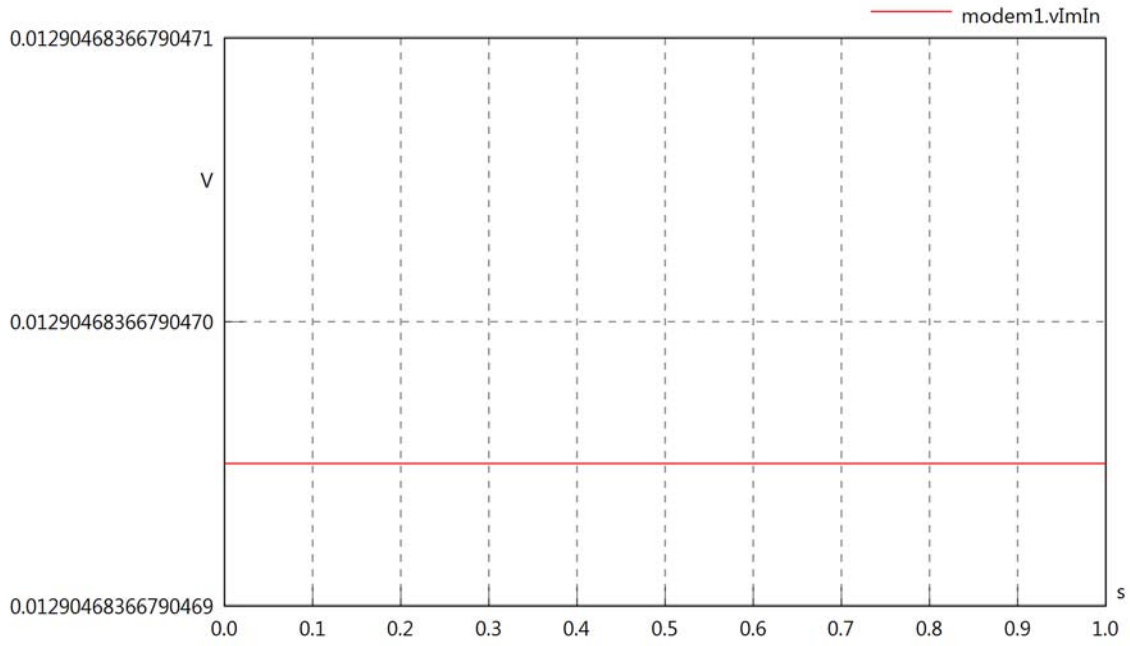

modem1.IrmsIn

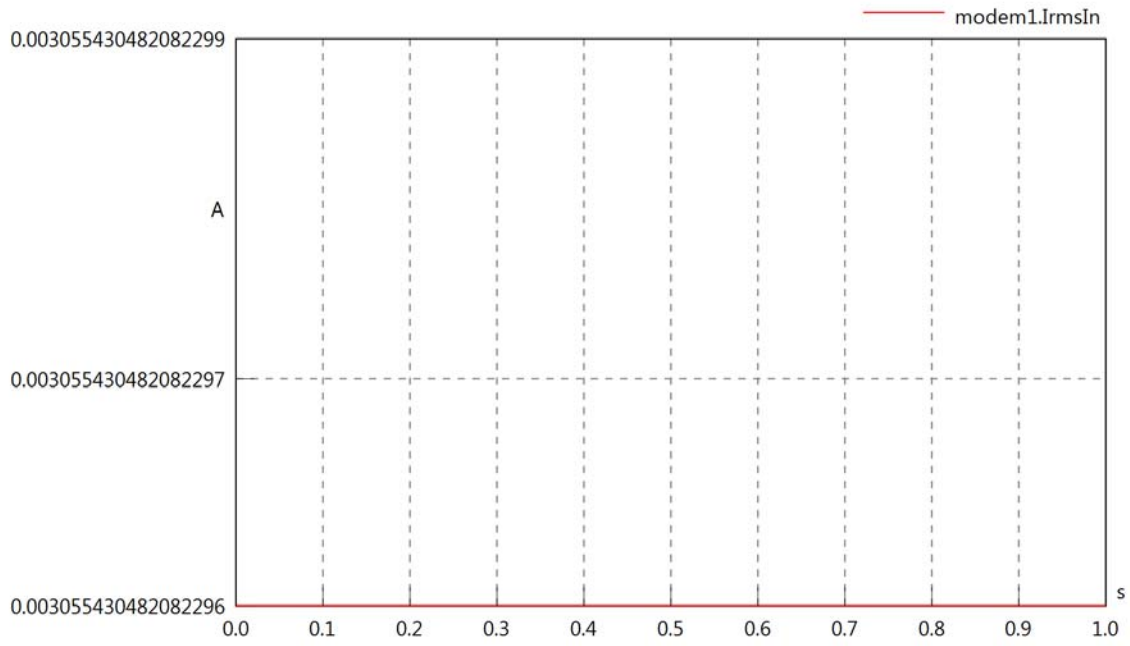

modem1.iReIn

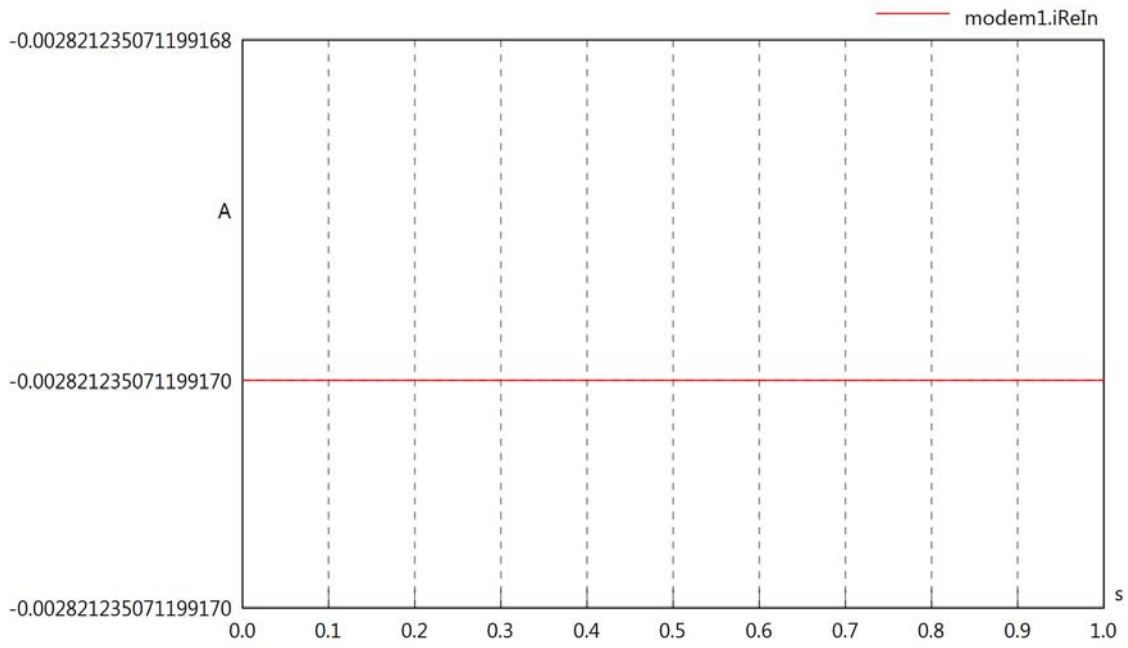

modem1.iImIn

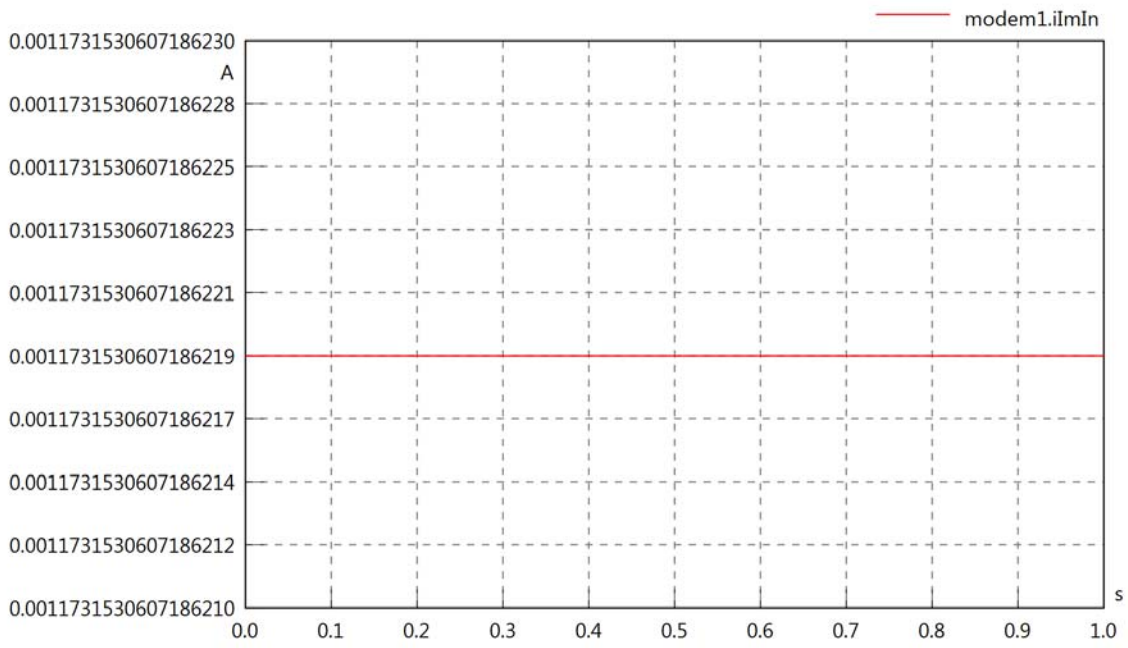

modem1.phiVIn

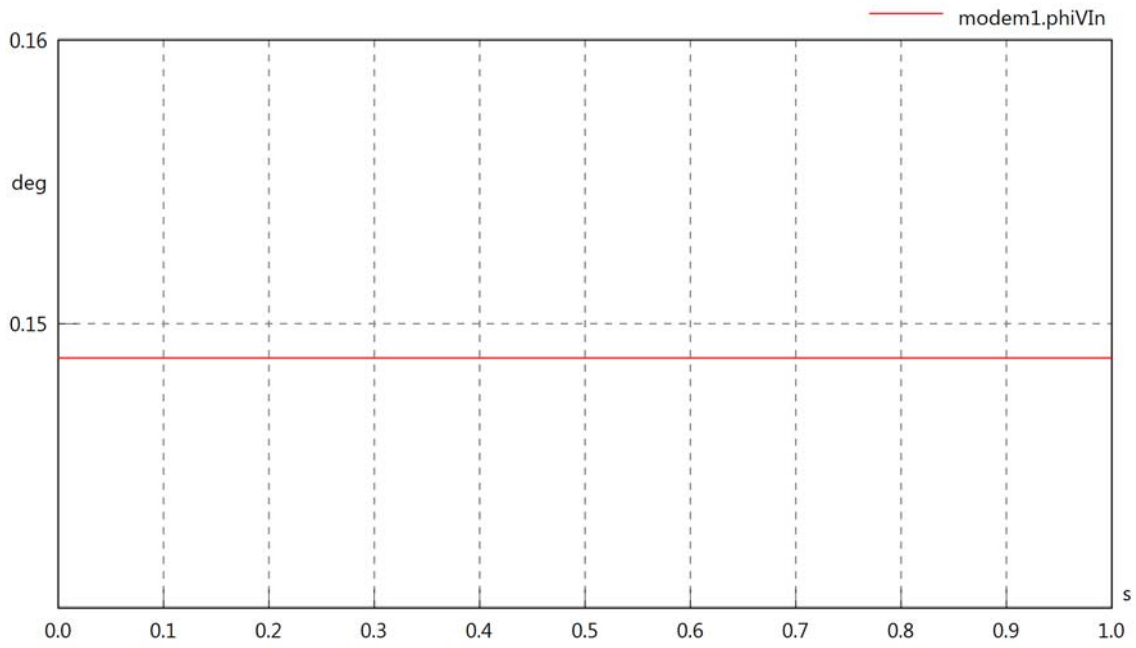

modem1.phiIn

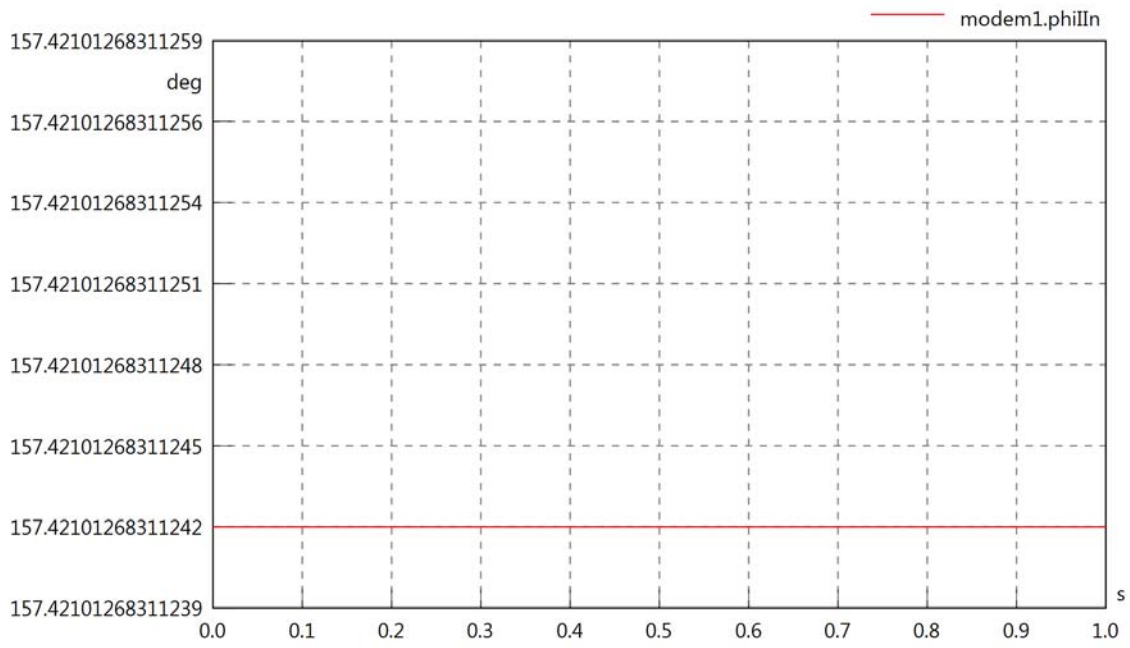

modem1.phiIVIn

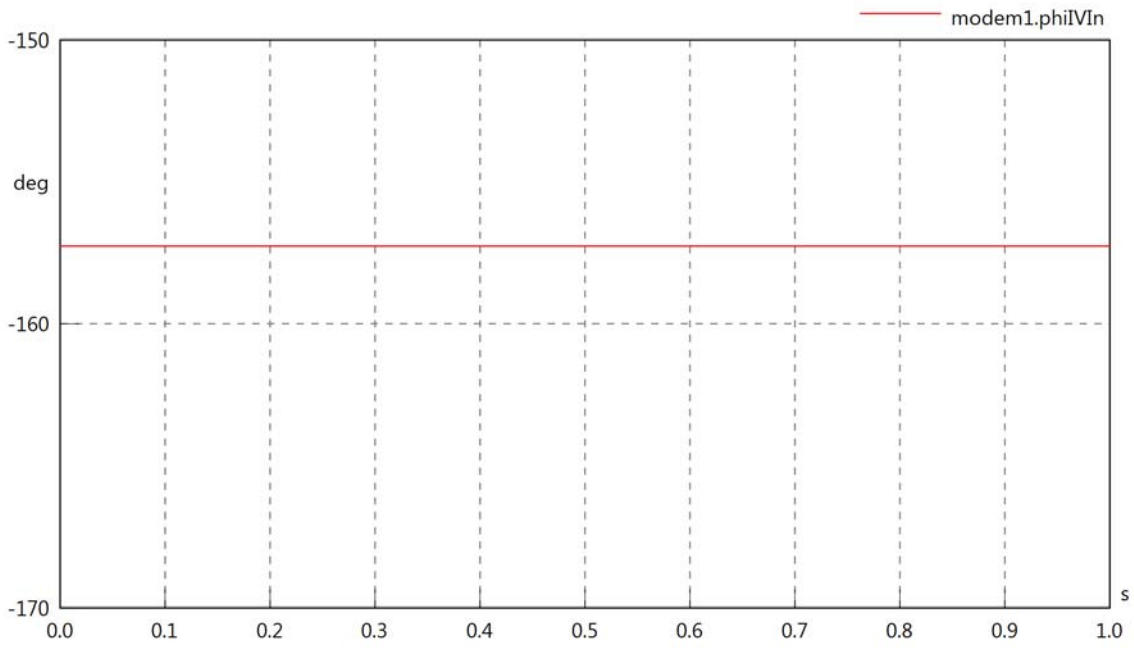

modem1.PReIn

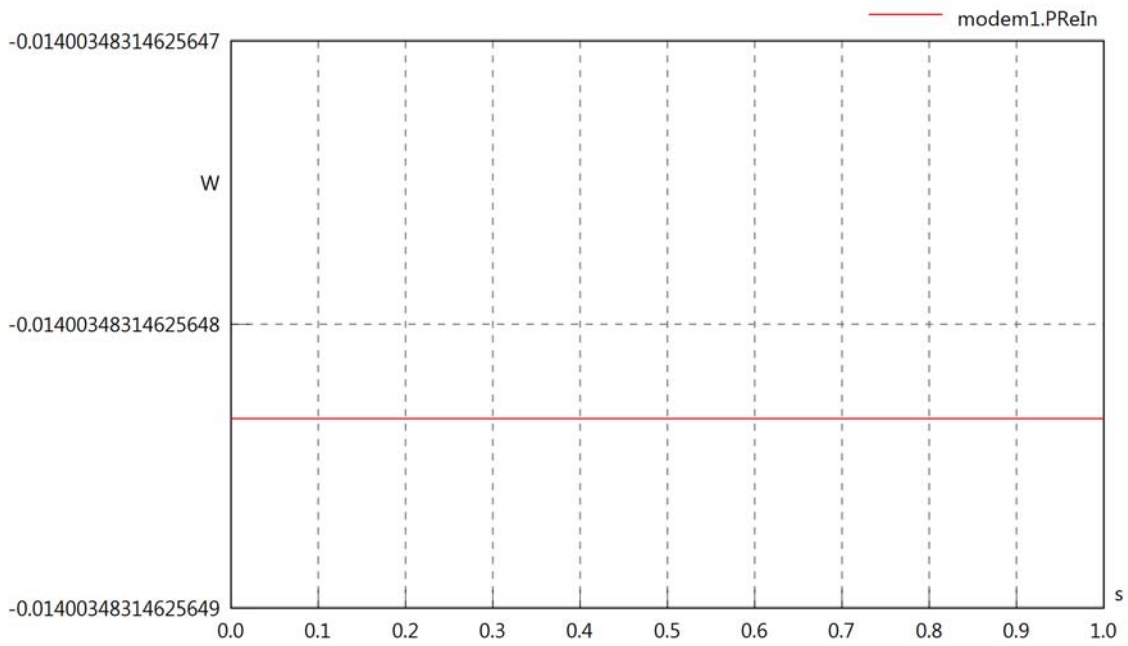

modem1.PImIn

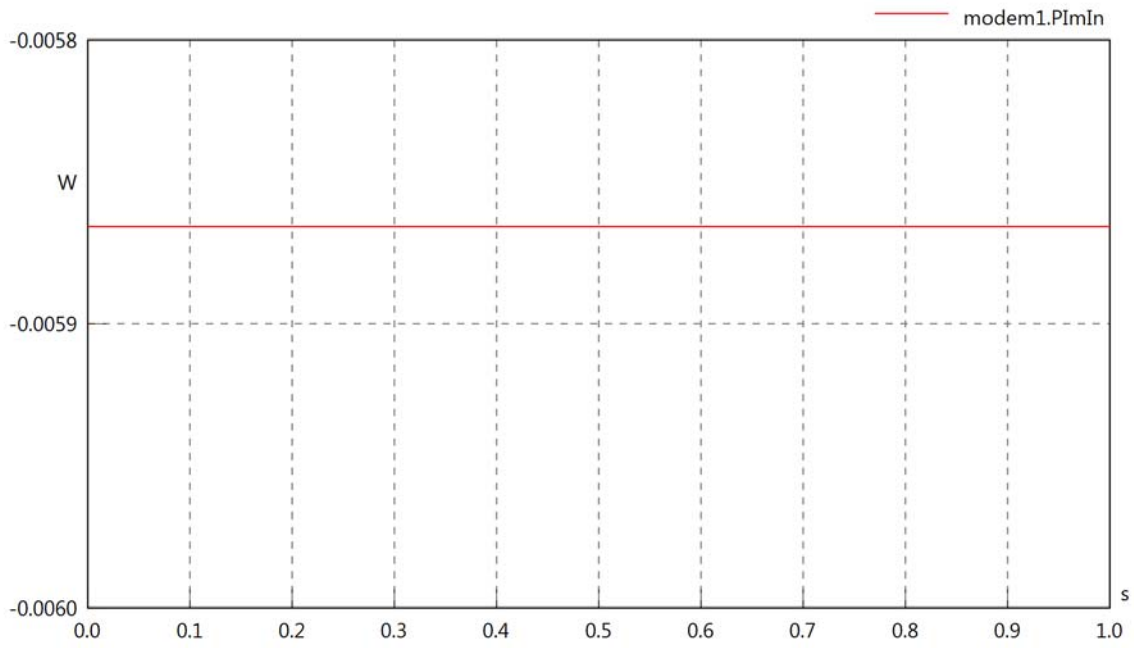

modem1.SIn

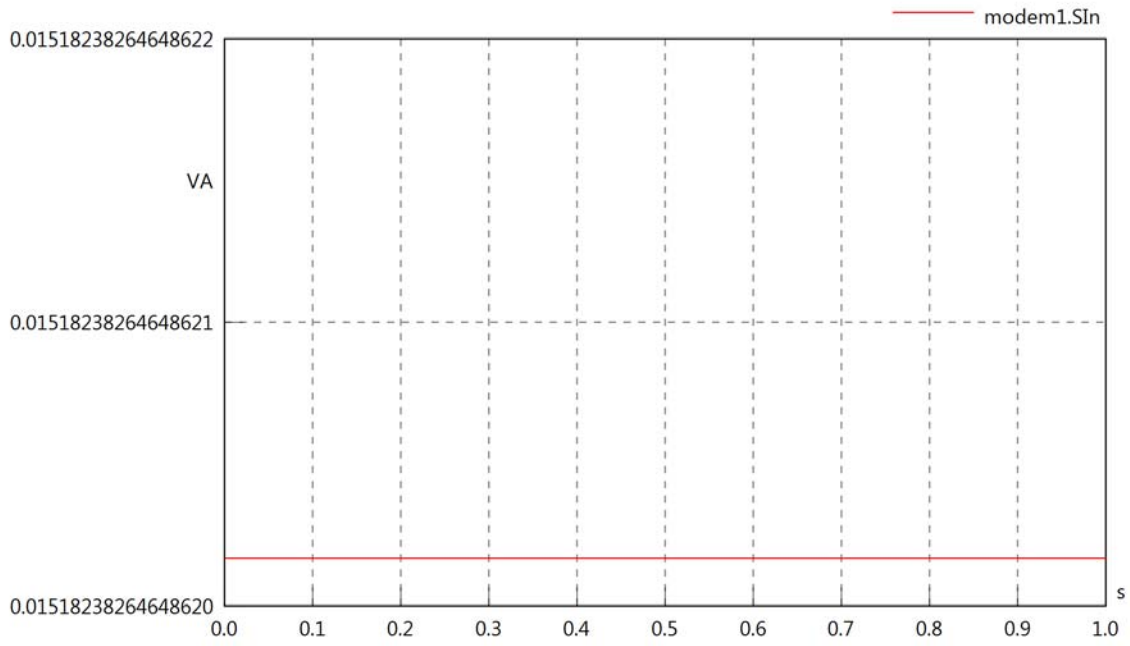
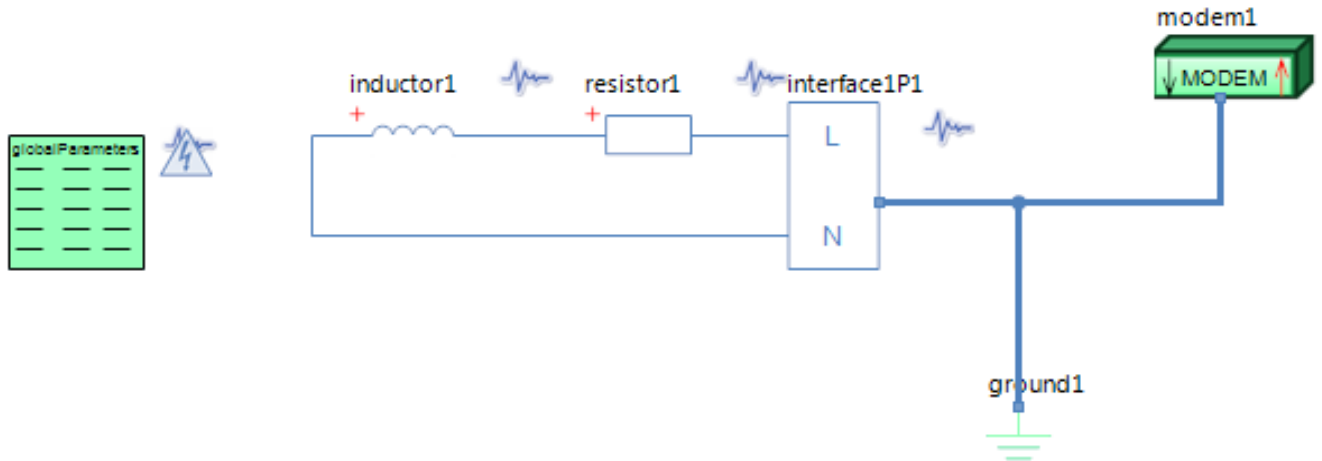

Diagram View



GlobalParameters globalParameters
Parameters

Comment	Name	Current Value	Unit
Type of Calculation	eCalculationKind	Signal Calculation	
Description of Frequency	eFrequencyKind	Linear	
Minimum Frequency	fMin	100	[kHz]
Maximum Frequency	fMax	100	[kHz]

Modem modem1
Parameters

Comment	Name	Current Value	Unit
Modem is sending or receiving	kind	Modem is sending	
Output Resistance	Rout	11	[Ohm]
Voltage or Power input parameter	inKind	Voltage	
Sine Wave RMS Voltage	VrmsSrcSig	5	[V]
Voltage Phase Angle	phiVsig		[deg]

Resistor resistor1
Parameters

Comment	Name	Current Value	Unit
Resistance	R	1500	[Ohm]

Inductor inductor1
Parameters

Comment	Name	Current Value	Unit
Inductance	L	5	[mH]

modem1.VrmsIn

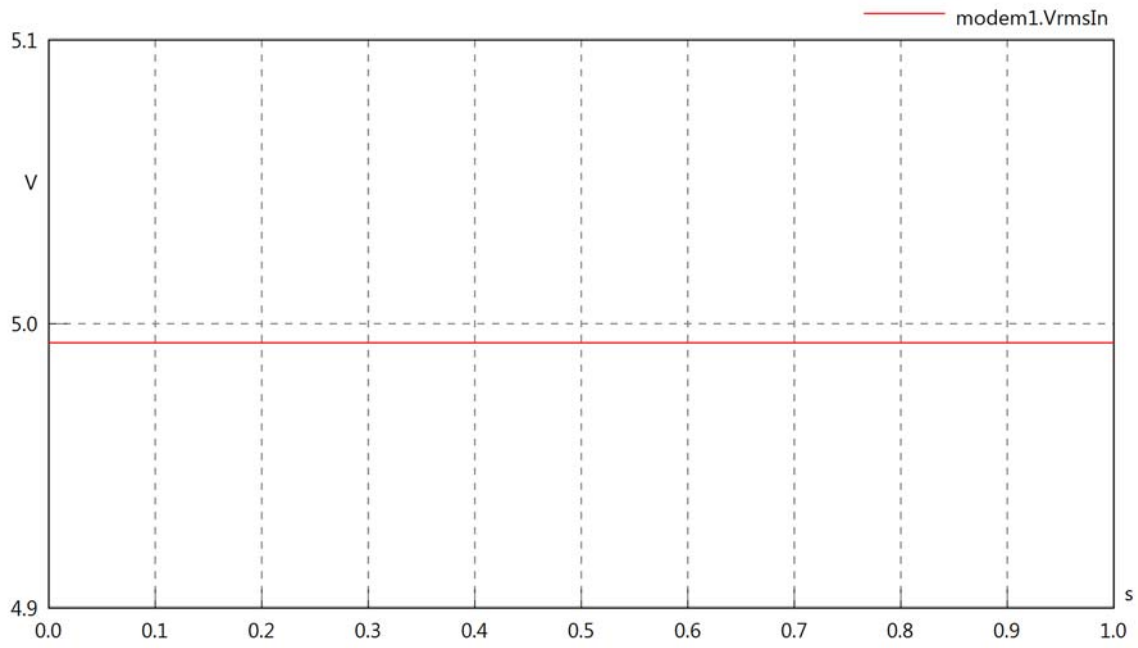

modem1.vReIn

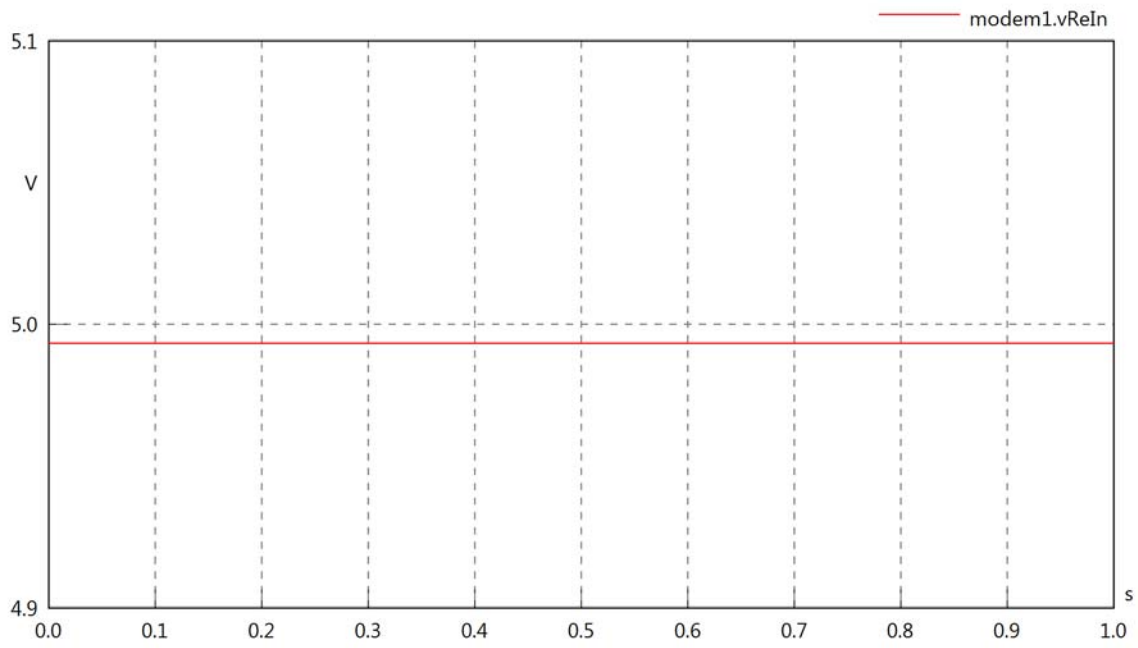

modem1.vImIn

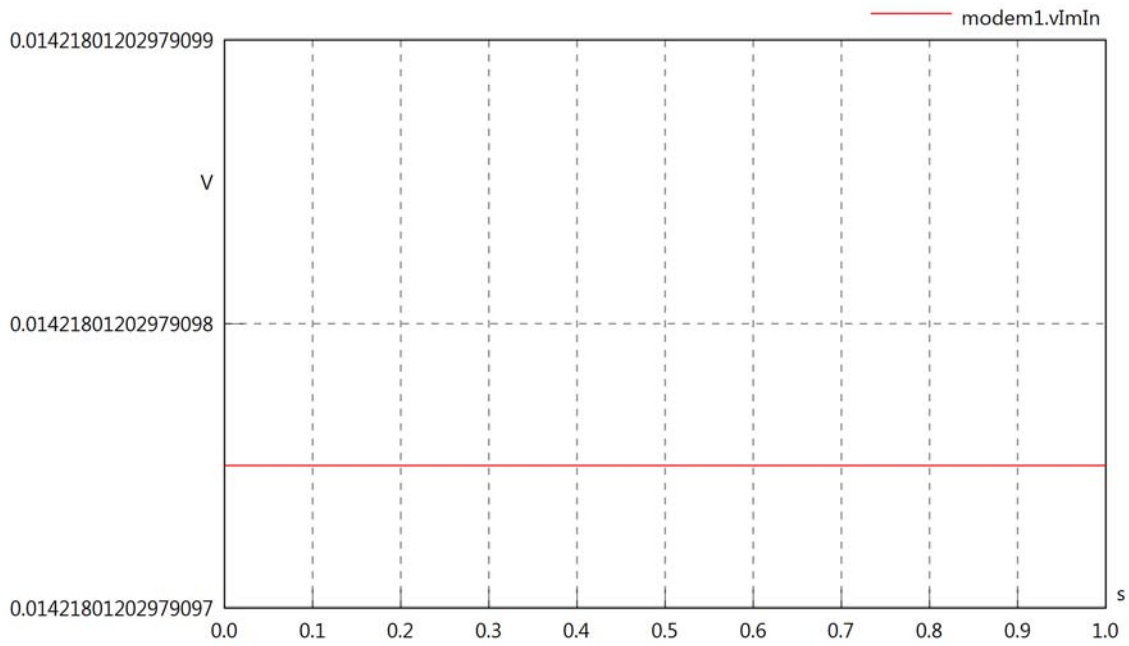

modem1.IrmsIn

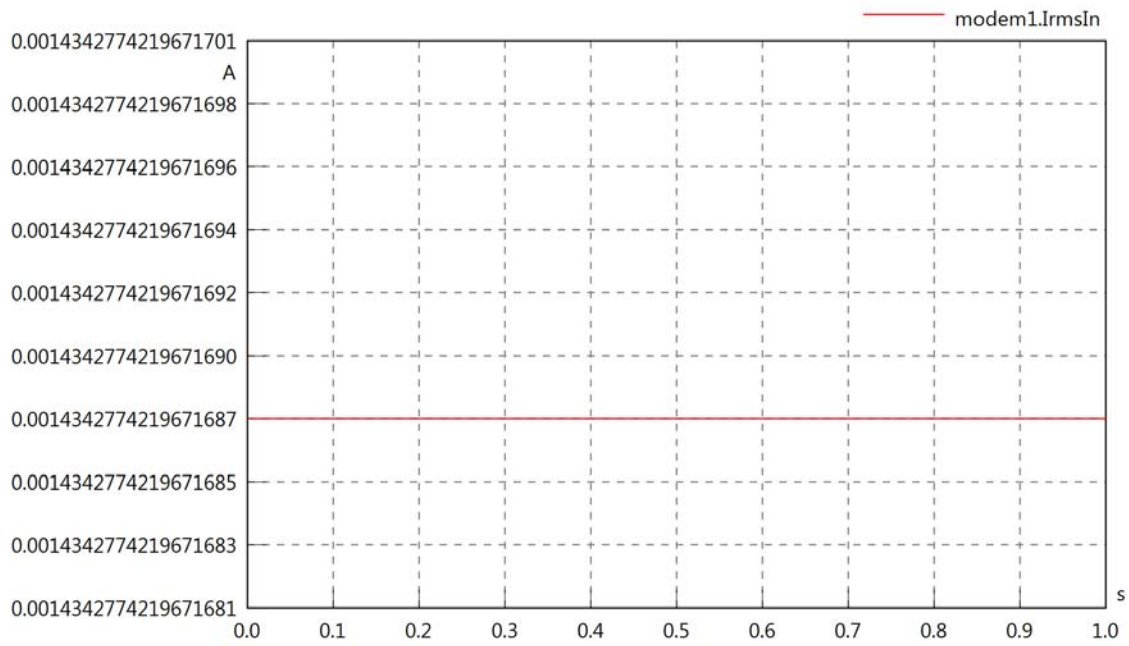

modem1.iReIn

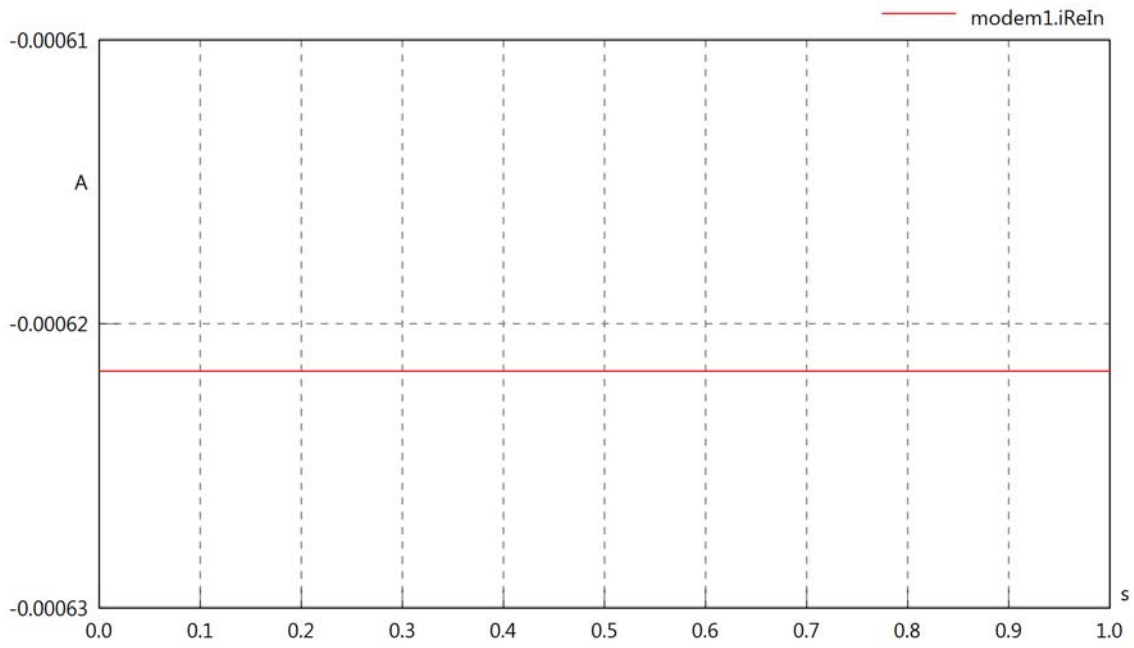

modem1.iImIn

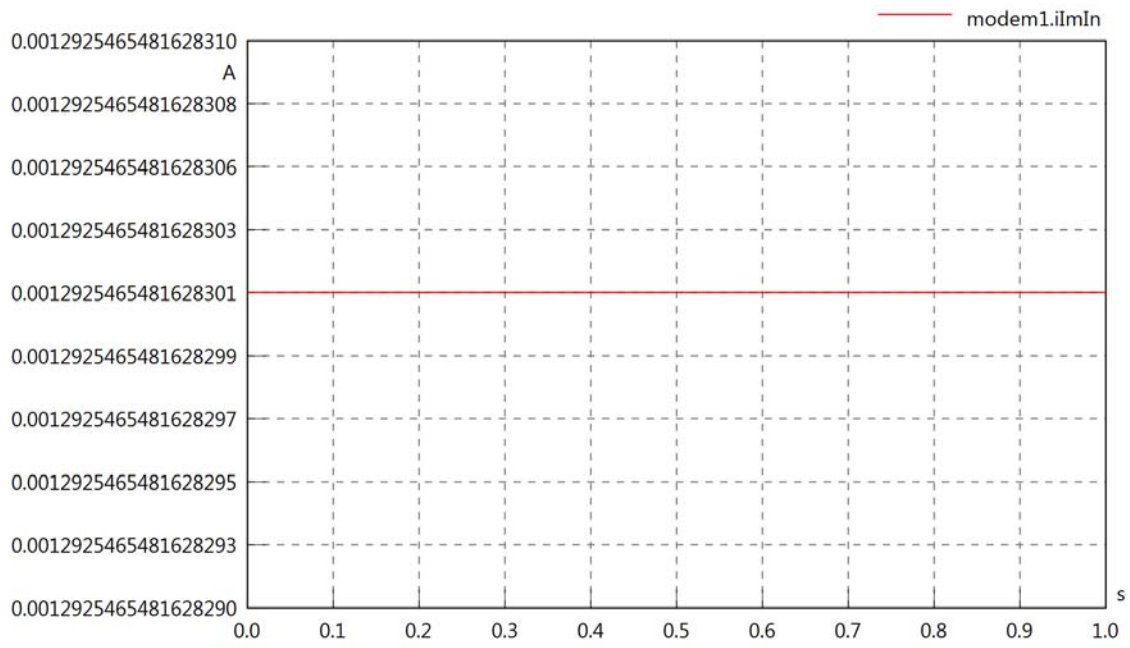

modem1.phiVIn

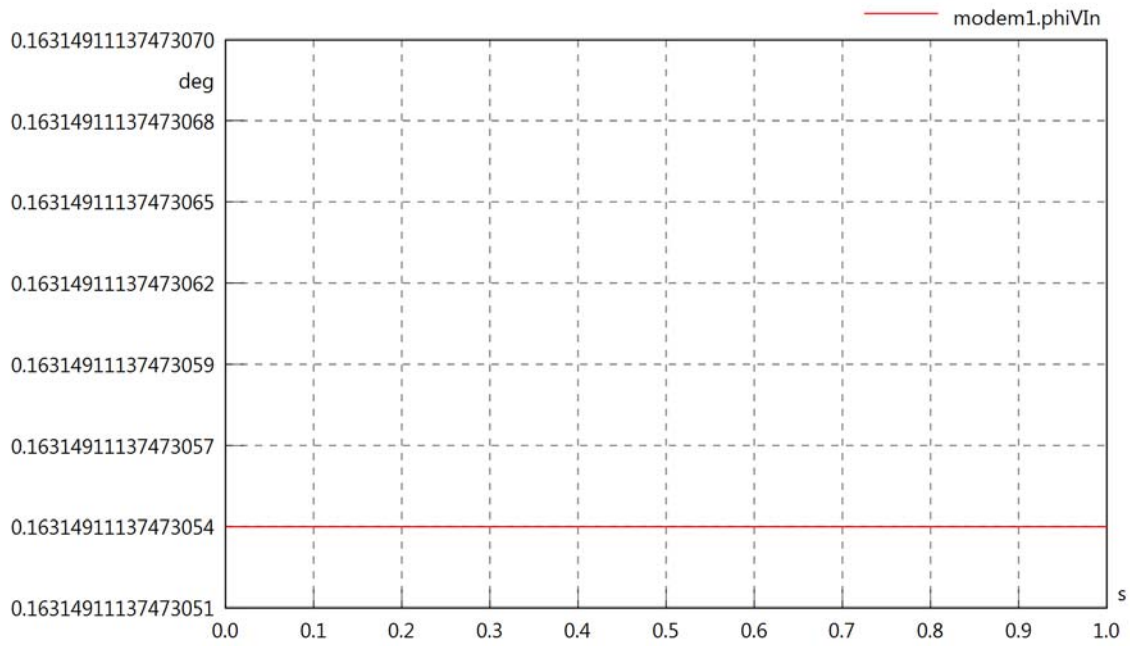

modem1.phiIn

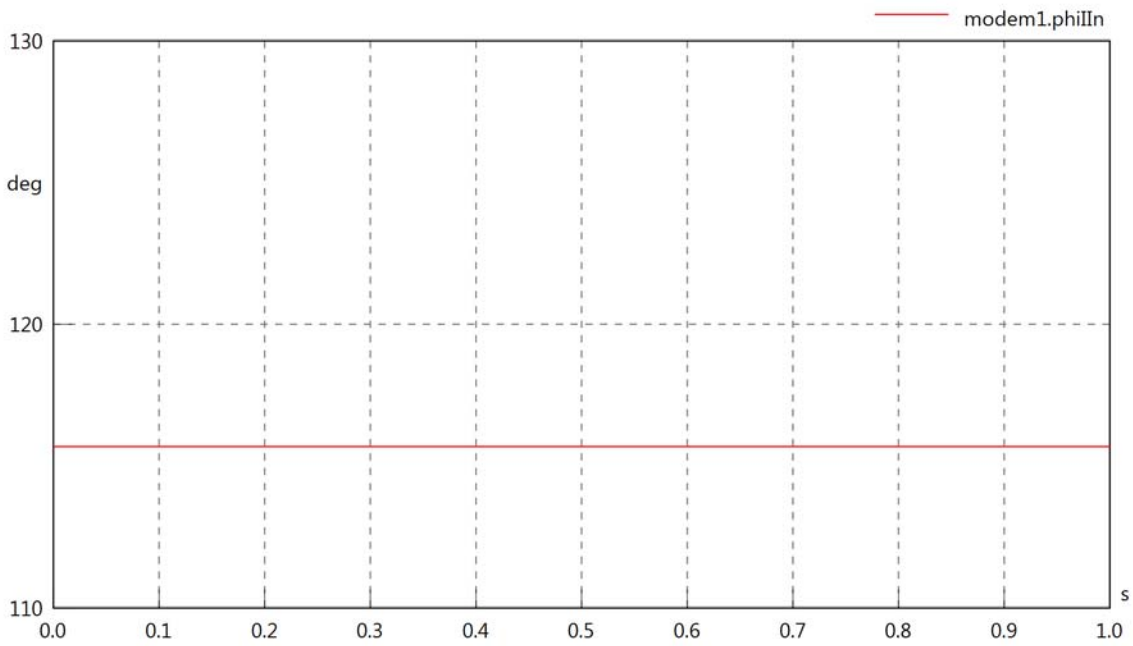

modem1.phiIVIn

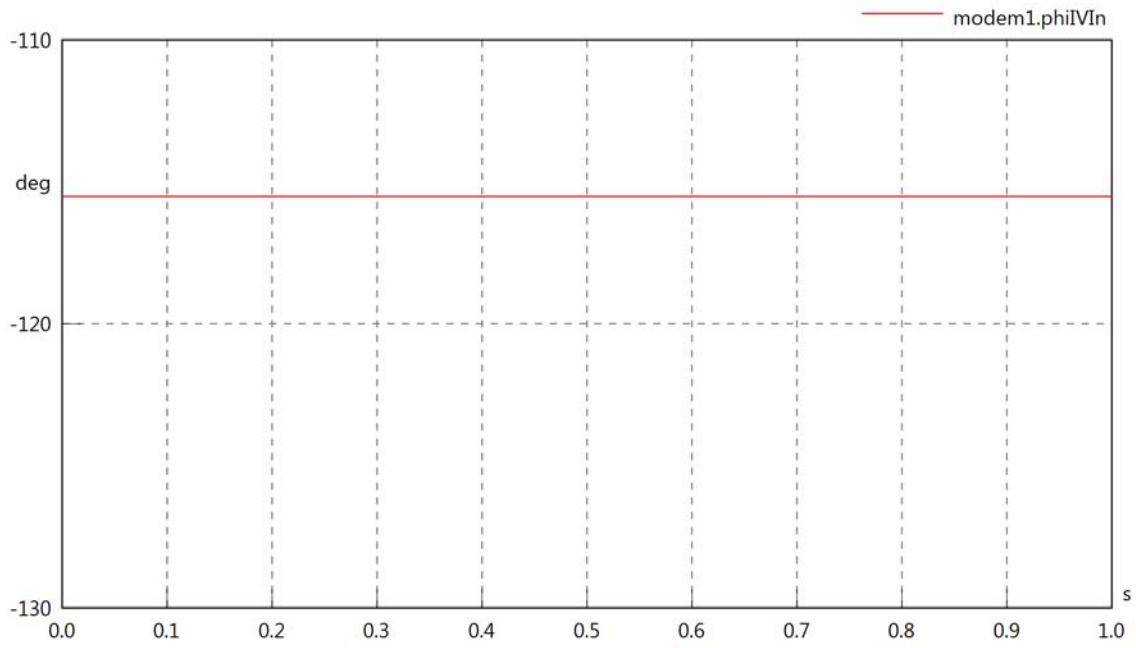

modem1.PReIn

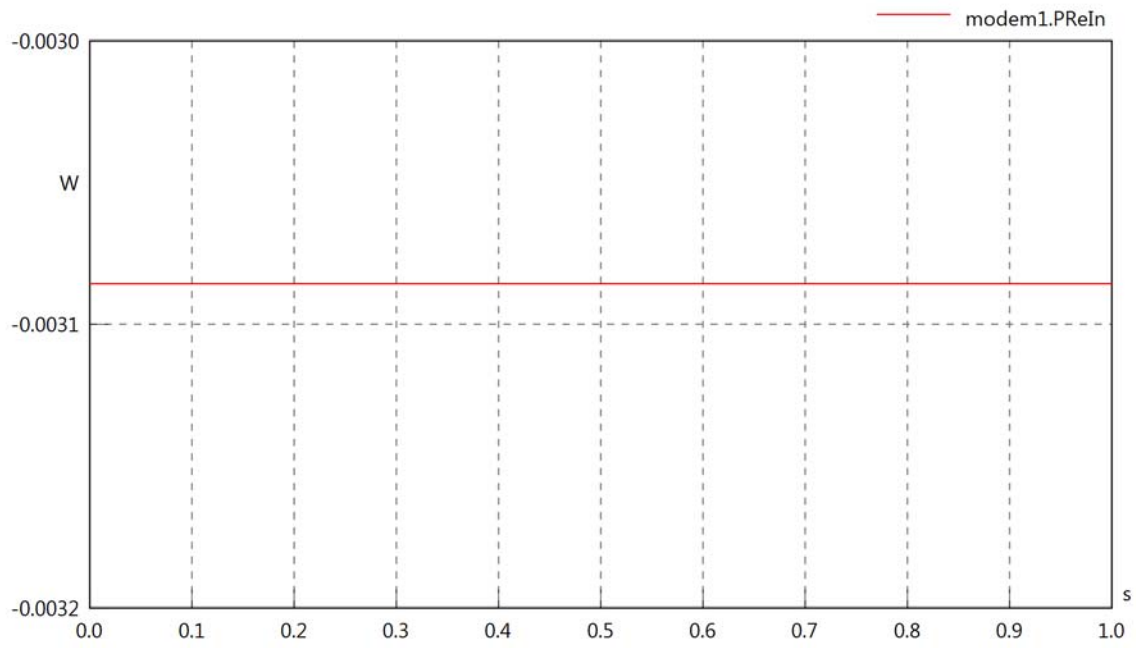

modem1.PImIn

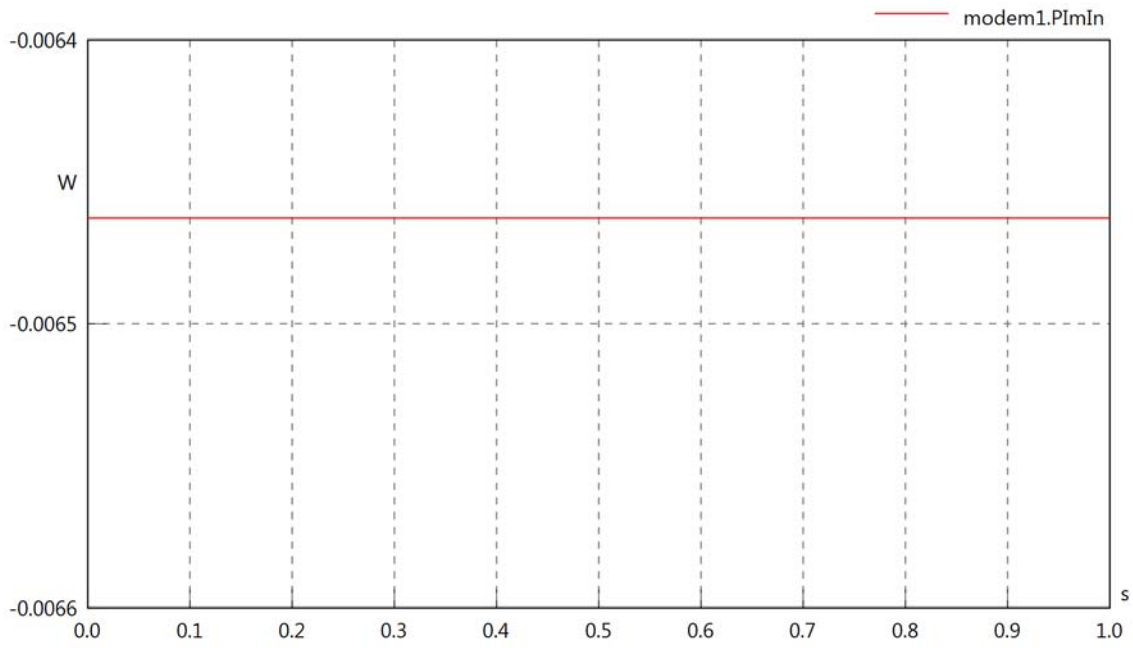

modem1.SIn

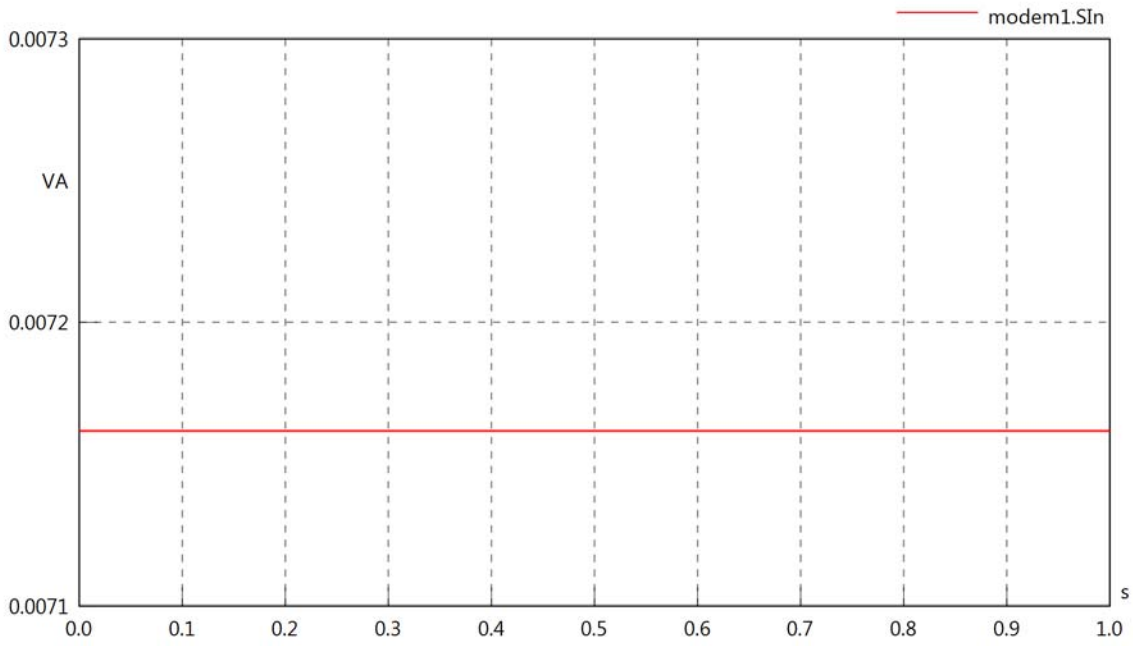
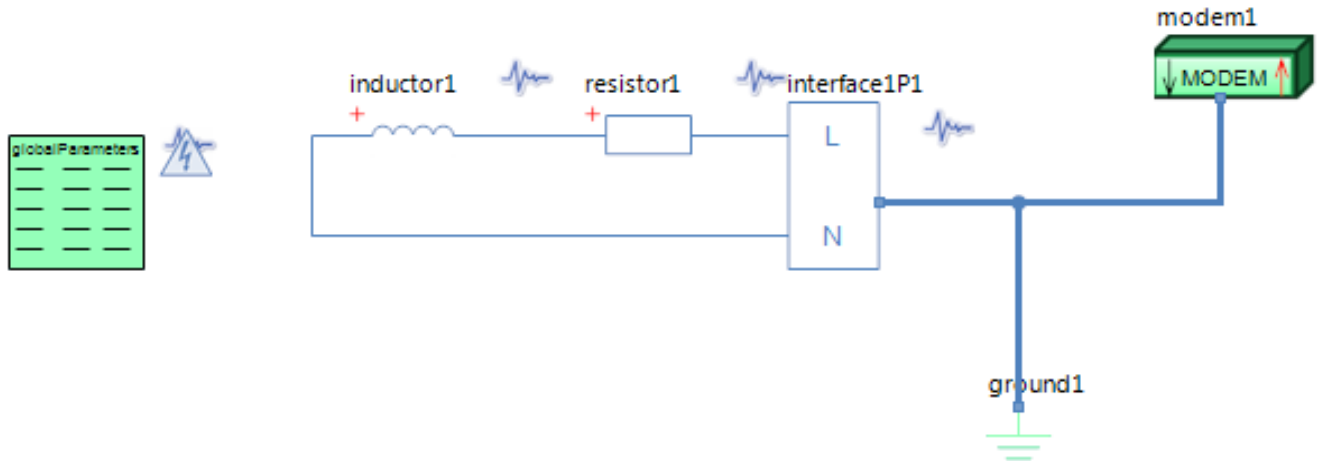

Diagram View



GlobalParameters globalParameters
Parameters

Comment	Name	Current Value	Unit
Type of Calculation	eCalculationKind	Signal Calculation	
Description of Frequency	eFrequencyKind	Linear	
Minimum Frequency	fMin	4	[kHz]
Maximum Frequency	fMax	4	[kHz]

Modem modem1
Parameters

Comment	Name	Current Value	Unit
Modem is sending or receiving	kind	Modem is sending	
Output Resistance	Rout	11	[Ohm]
Voltage or Power input parameter	inKind	Power	
Apparent Power not including Output Resistance	P	0.1	[VA]
Voltage Phase Angle	phiVSig		[deg]

Resistor resistor1
Parameters

Comment	Name	Current Value	Unit
Resistance	R	1500	[Ohm]

Inductor inductor1
Parameters

Comment	Name	Current Value	Unit
Inductance	L	5	[mH]

modem1.VrmsIn

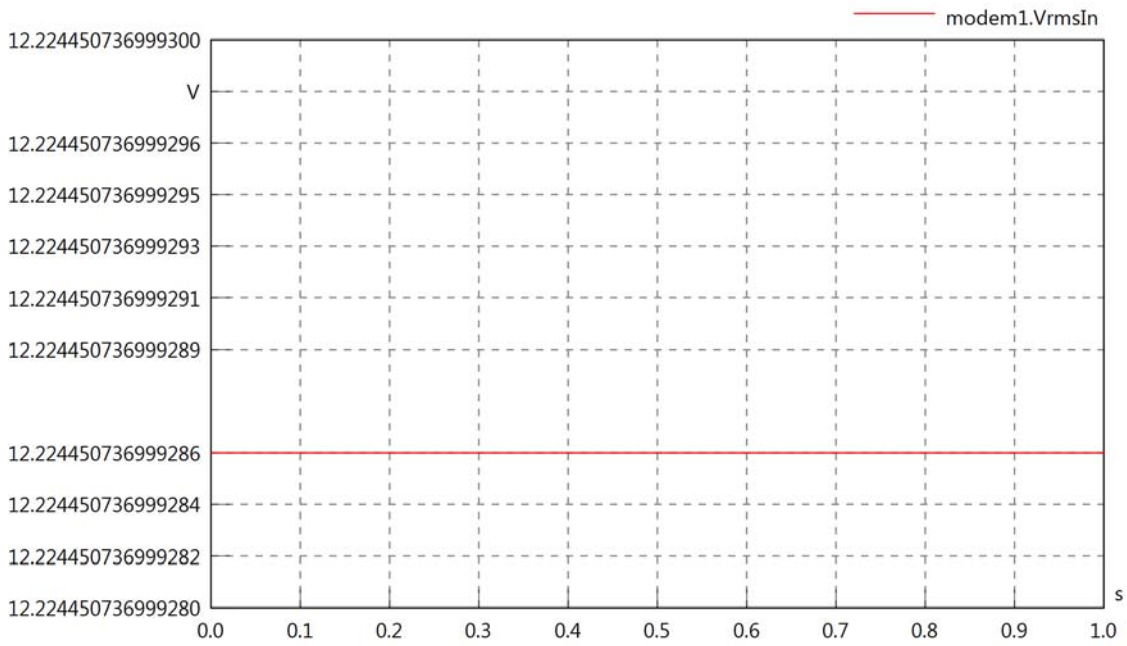

modem1.vReIn

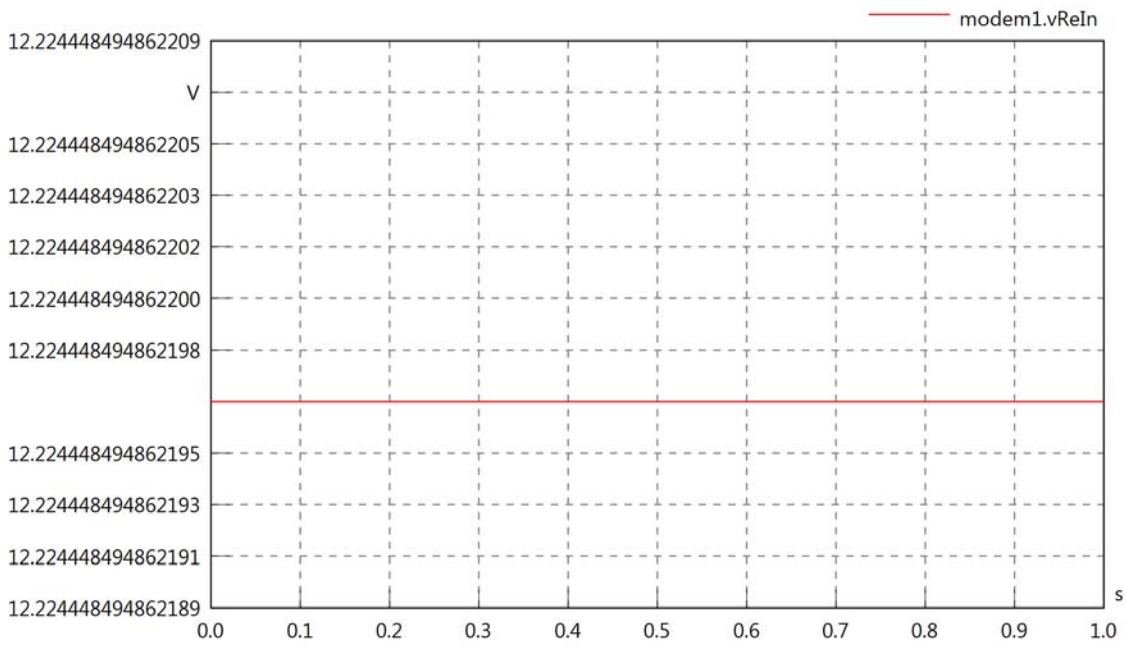

modem1.vImIn

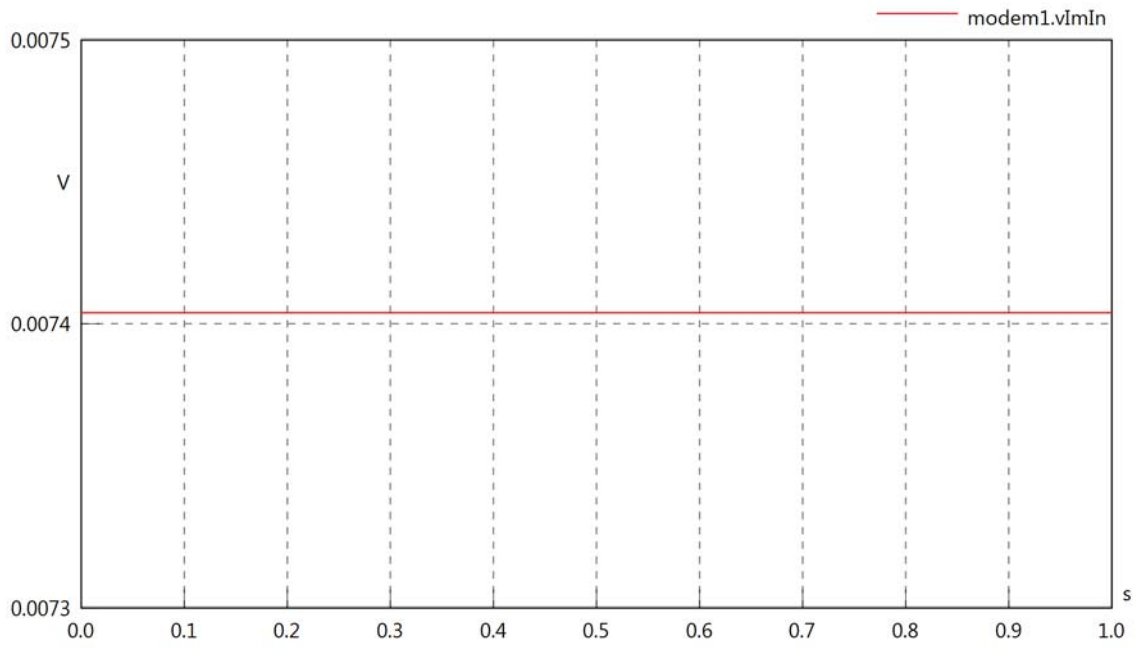

modem1.IrmsIn

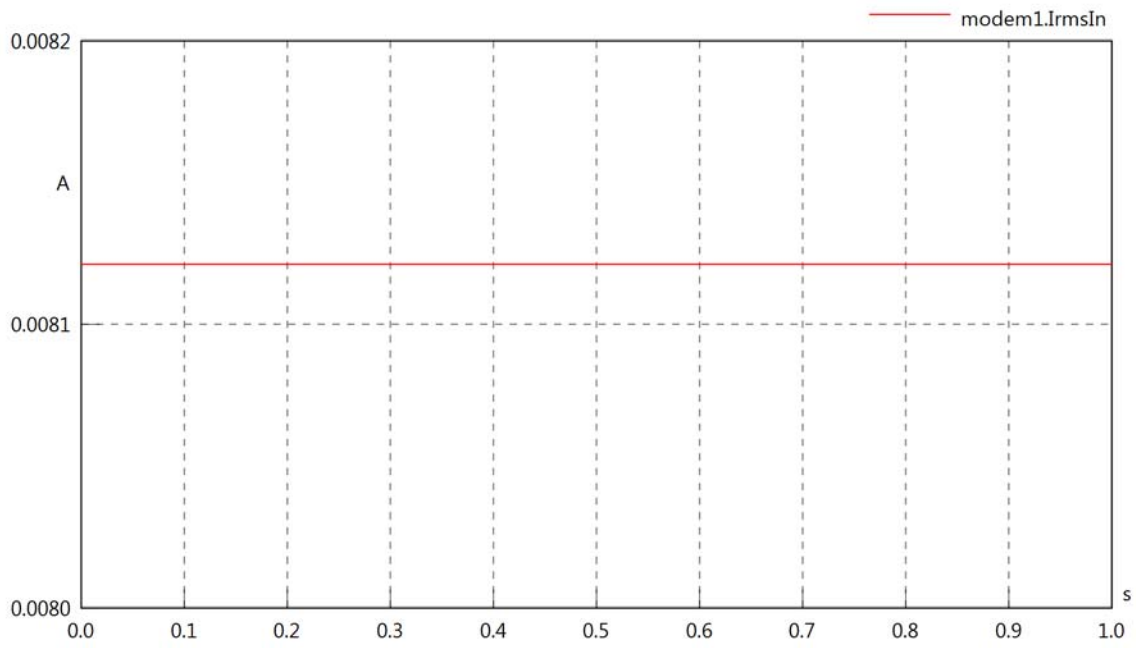

modem1.iReIn

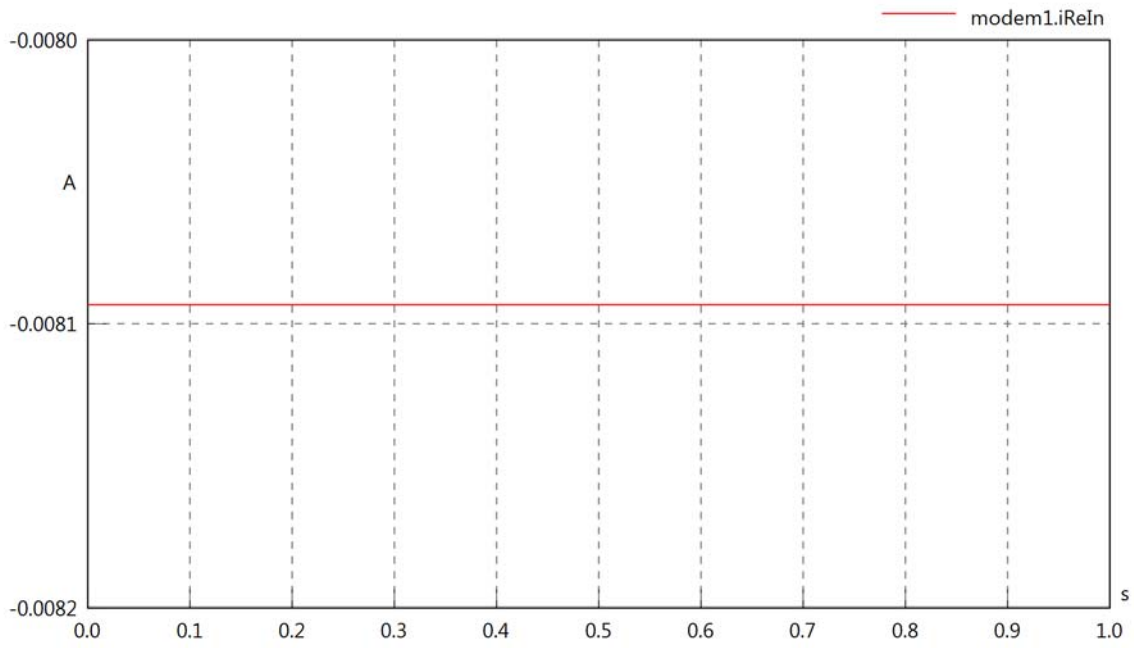

modem1.iImIn

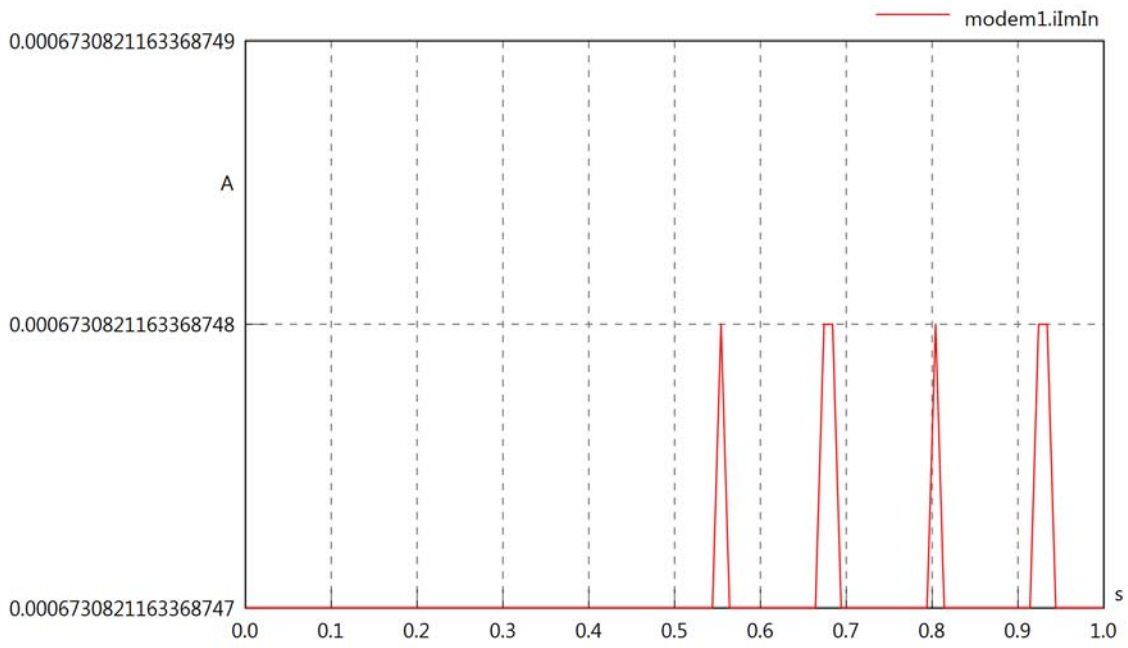

modem1.phiVIn

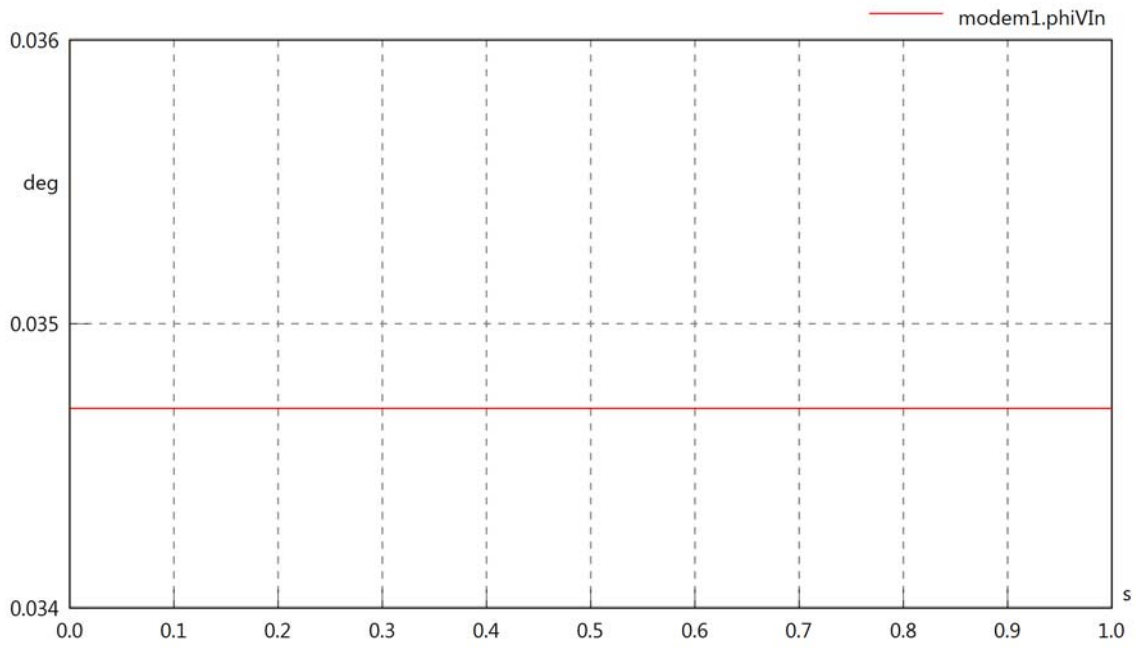

modem1.phiIn

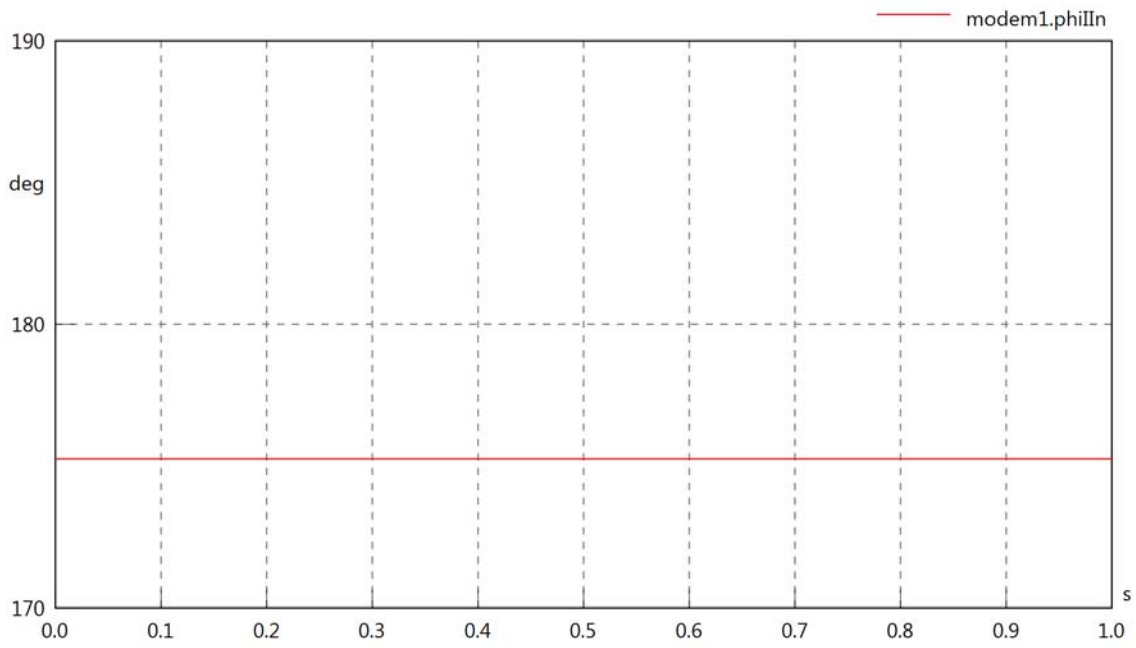

modem1.phiIVIn

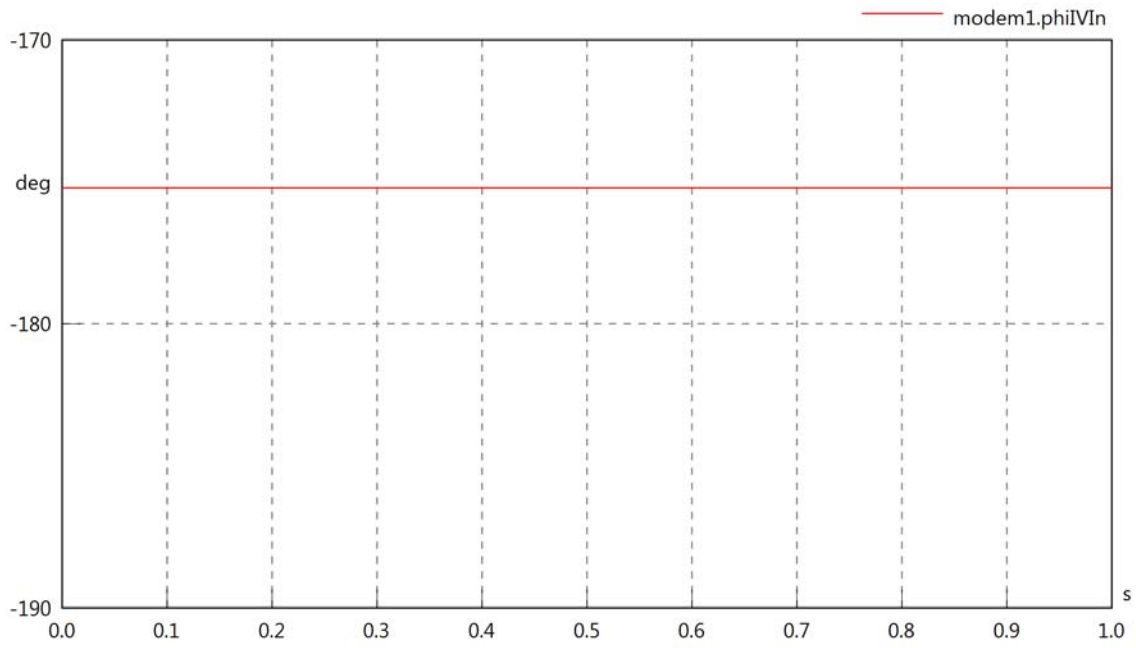

modem1.PReIn

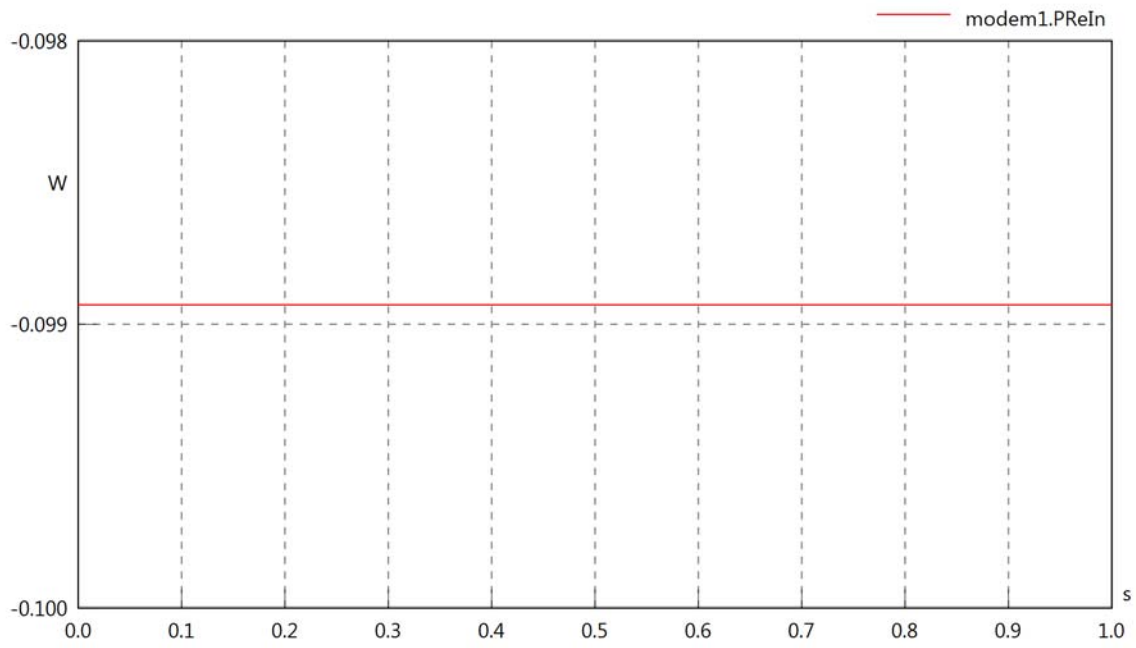

modem1.PImIn

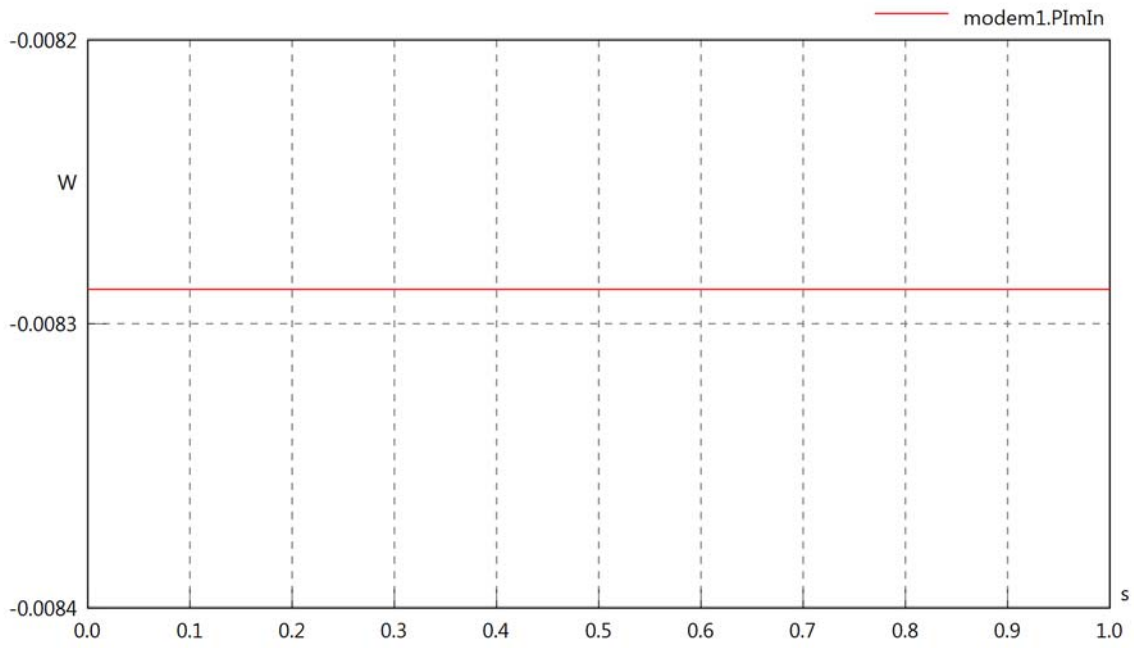

modem1.SIn

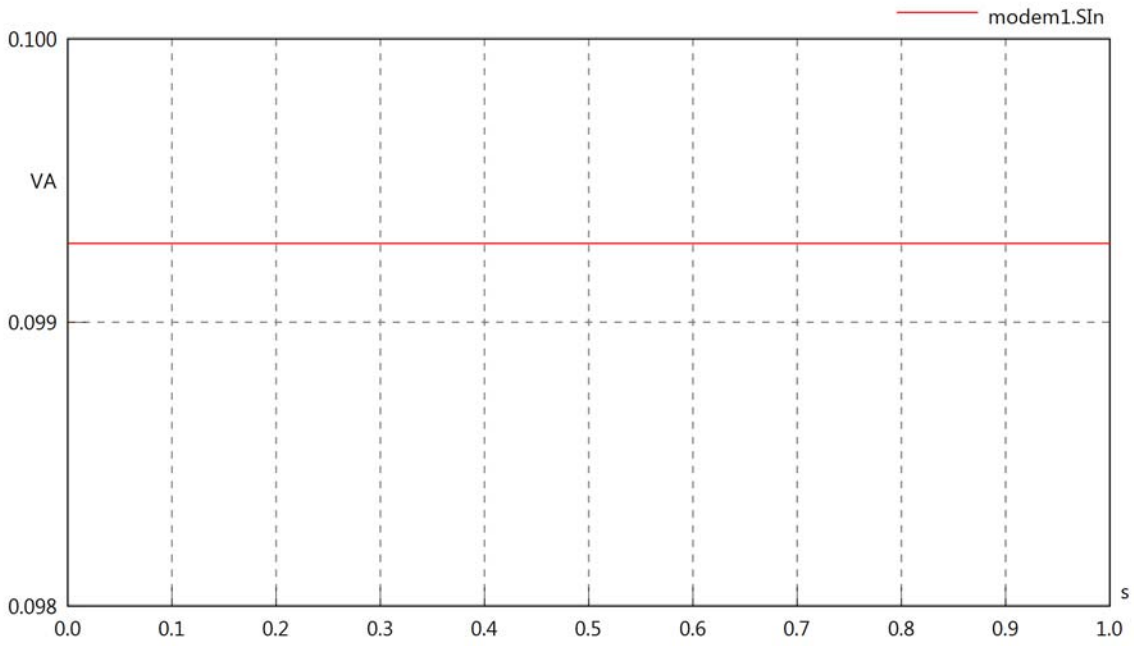
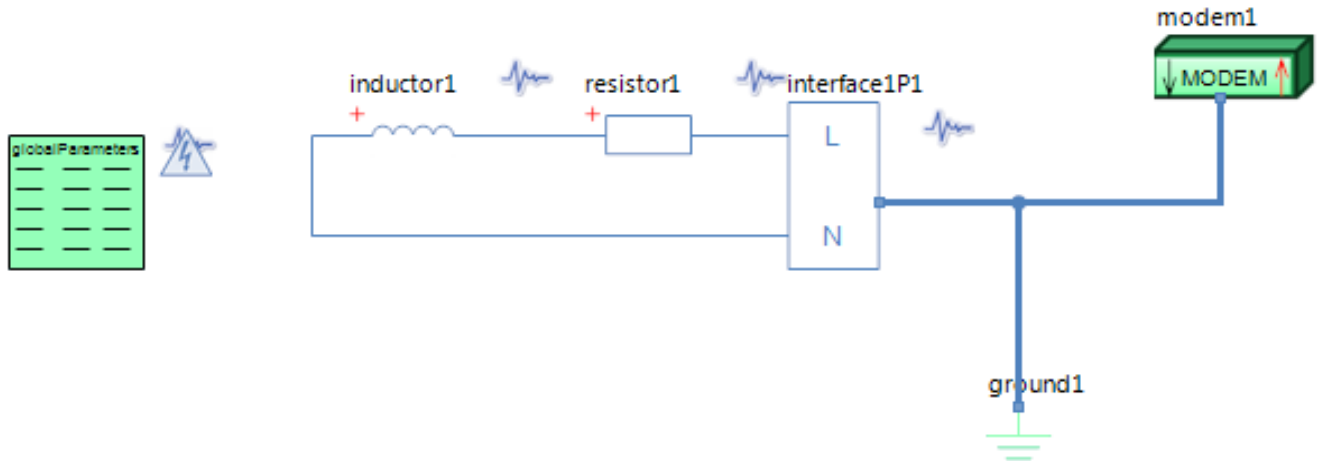

Diagram View



GlobalParameters globalParameters
Parameters

Comment	Name	Current Value	Unit
Type of Calculation	eCalculationKind	Signal Calculation	
Description of Frequency	eFrequencyKind	Linear	
Minimum Frequency	fMin	20	[kHz]
Maximum Frequency	fMax	20	[kHz]

Modem modem1
Parameters

Comment	Name	Current Value	Unit
Modem is sending or receiving	kind	Modem is sending	
Output Resistance	Rout	11	[Ohm]
Voltage or Power input parameter	inKind	Power	
Apparent Power not including Output Resistance	P	0.1	[VA]
Voltage Phase Angle	phiVSig		[deg]

Resistor resistor1
Parameters

Comment	Name	Current Value	Unit
Resistance	R	1500	[Ohm]

Inductor inductor1
Parameters

Comment	Name	Current Value	Unit
Inductance	L	5	[mH]

modem1.VrmsIn

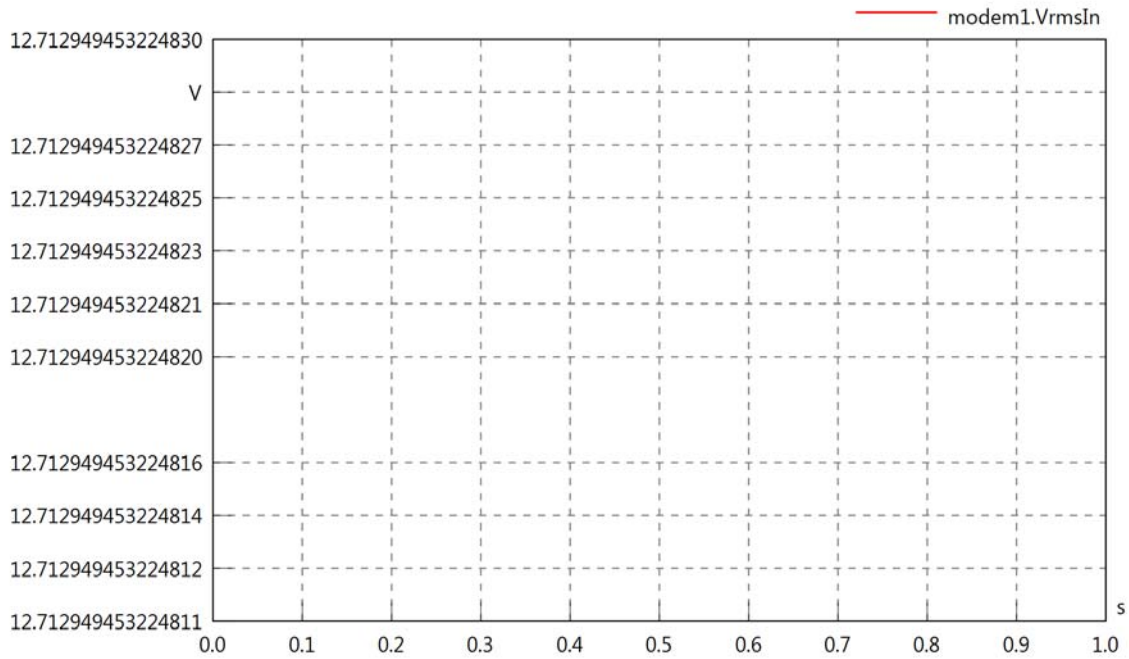

modem1.vReIn

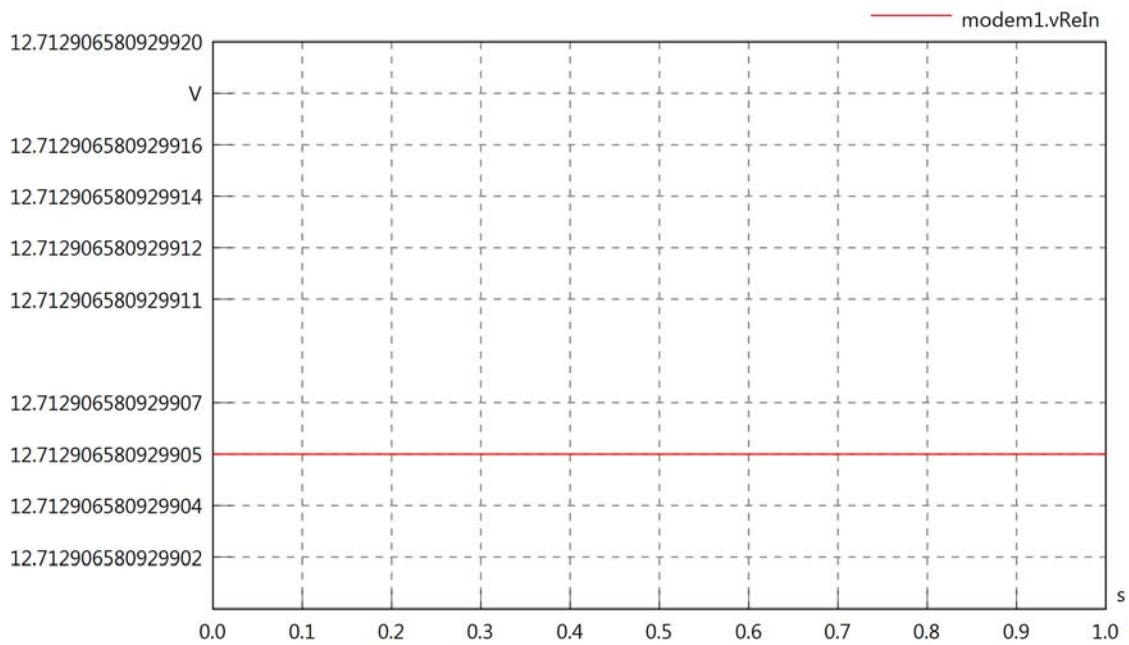

modem1.vImIn

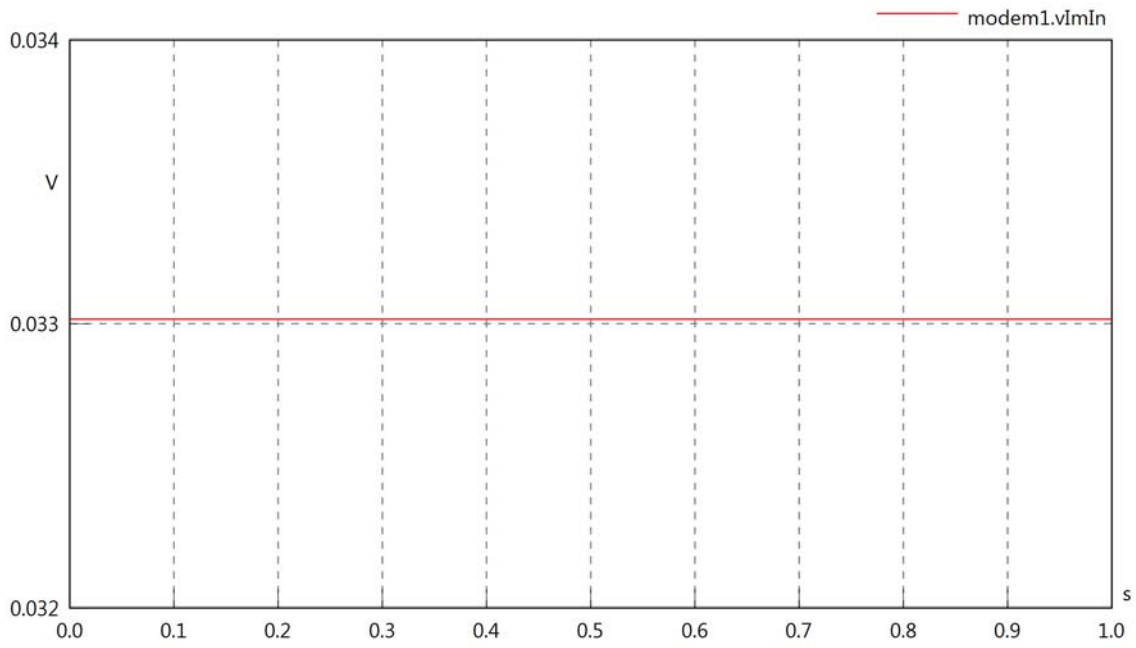

modem1.IrmsIn

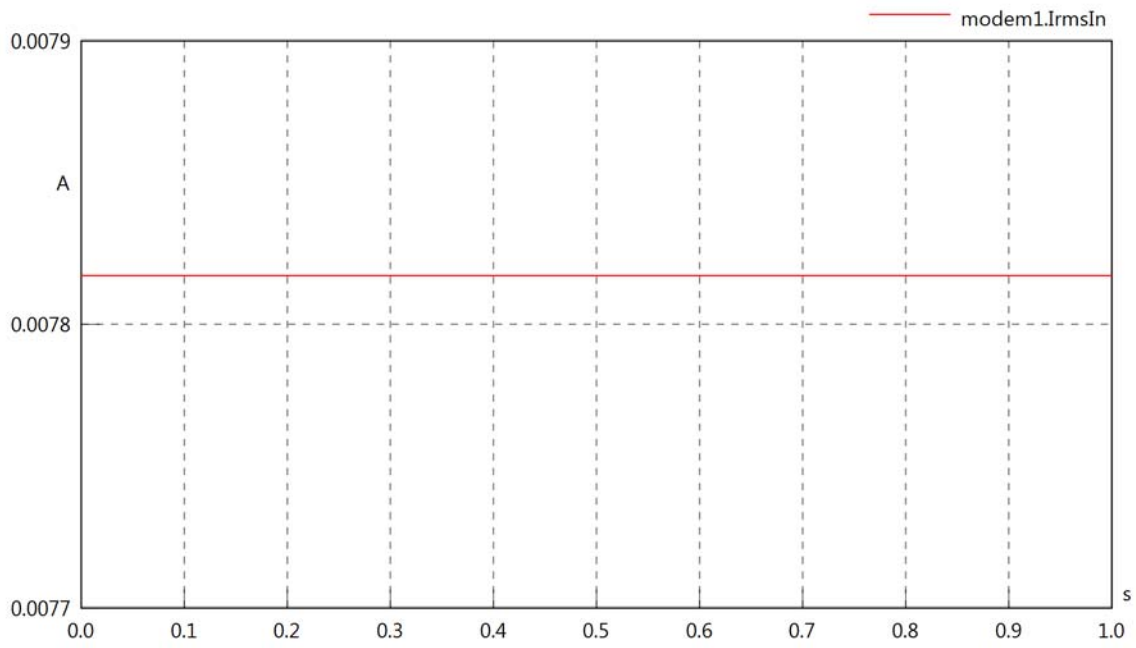

modem1.iReIn

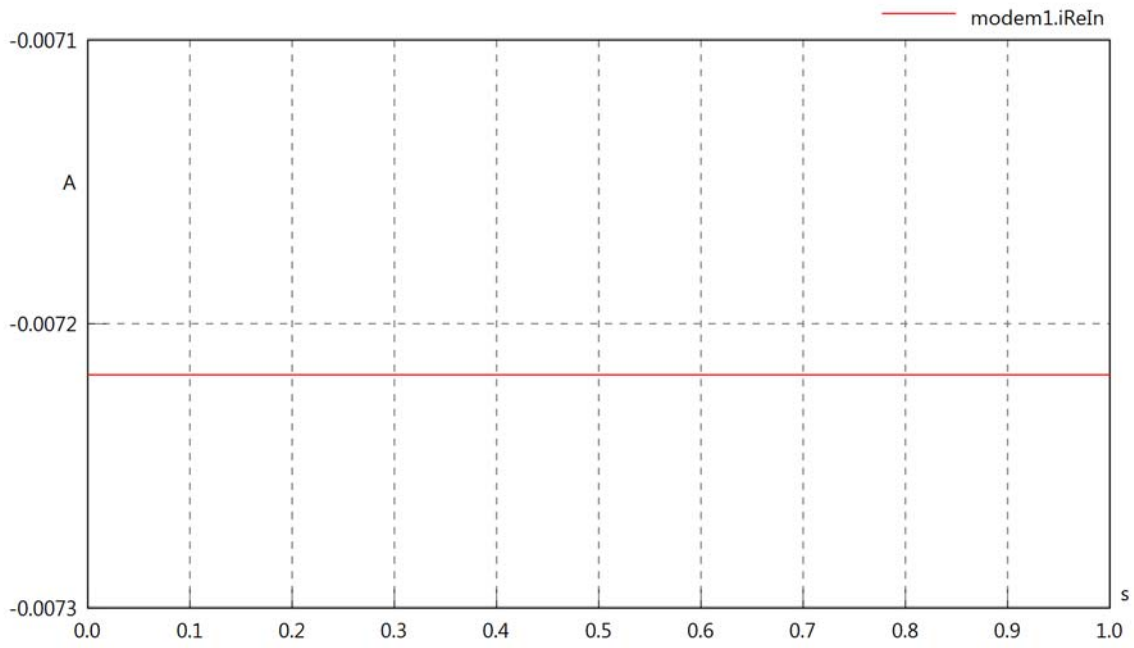

modem1.iImIn

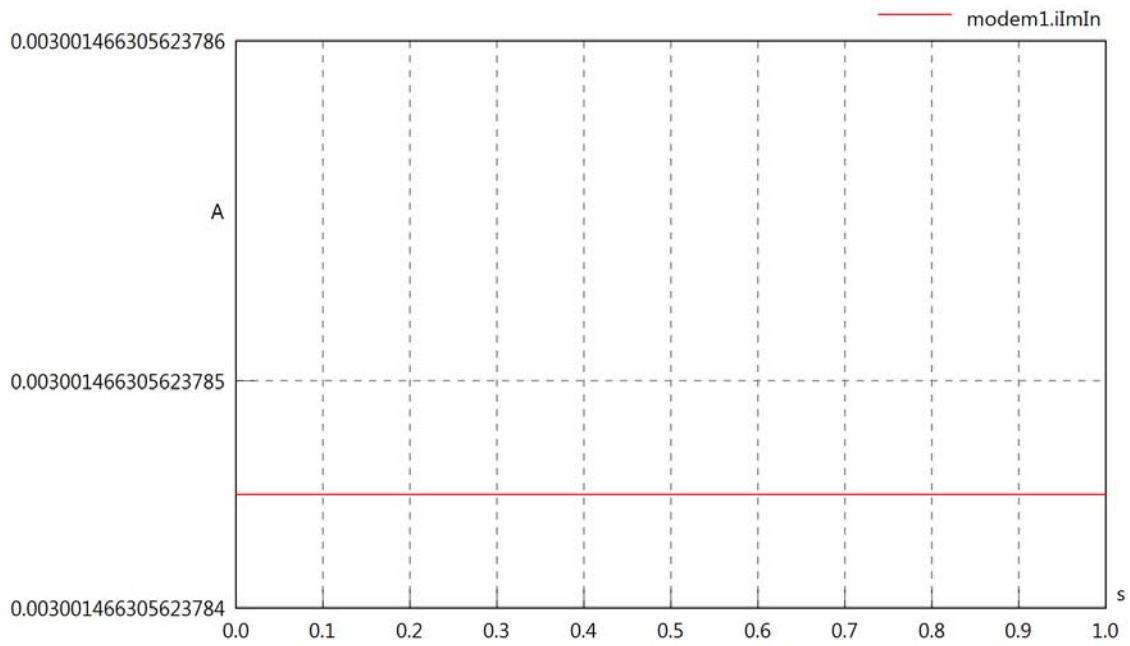

modem1.phiVIn

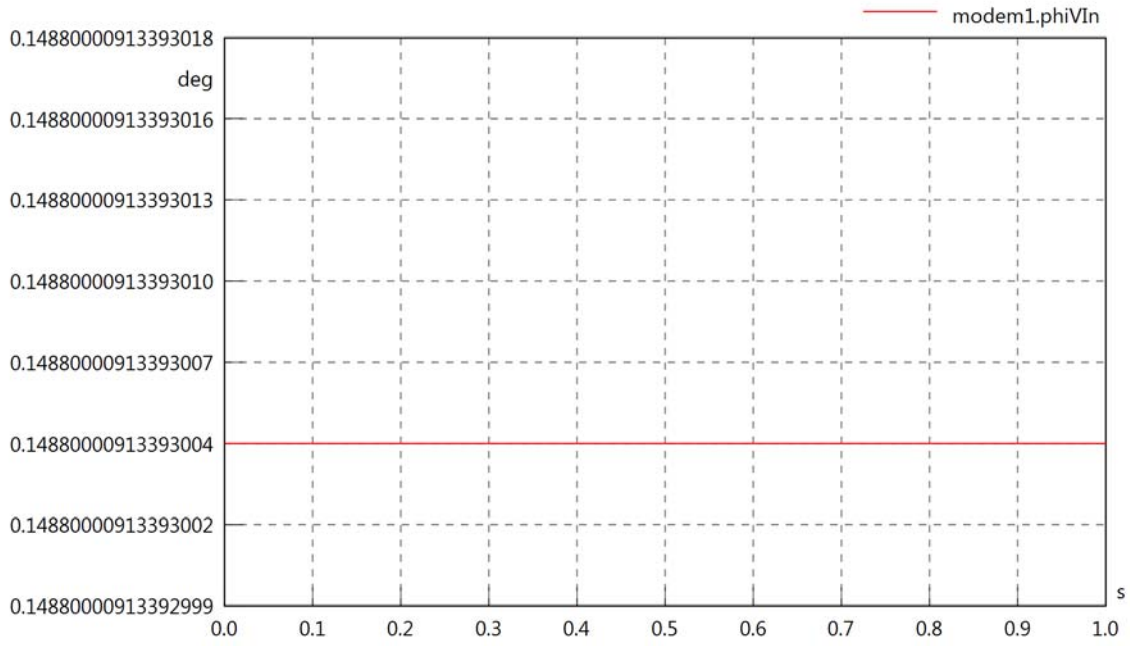

modem1.phiIn

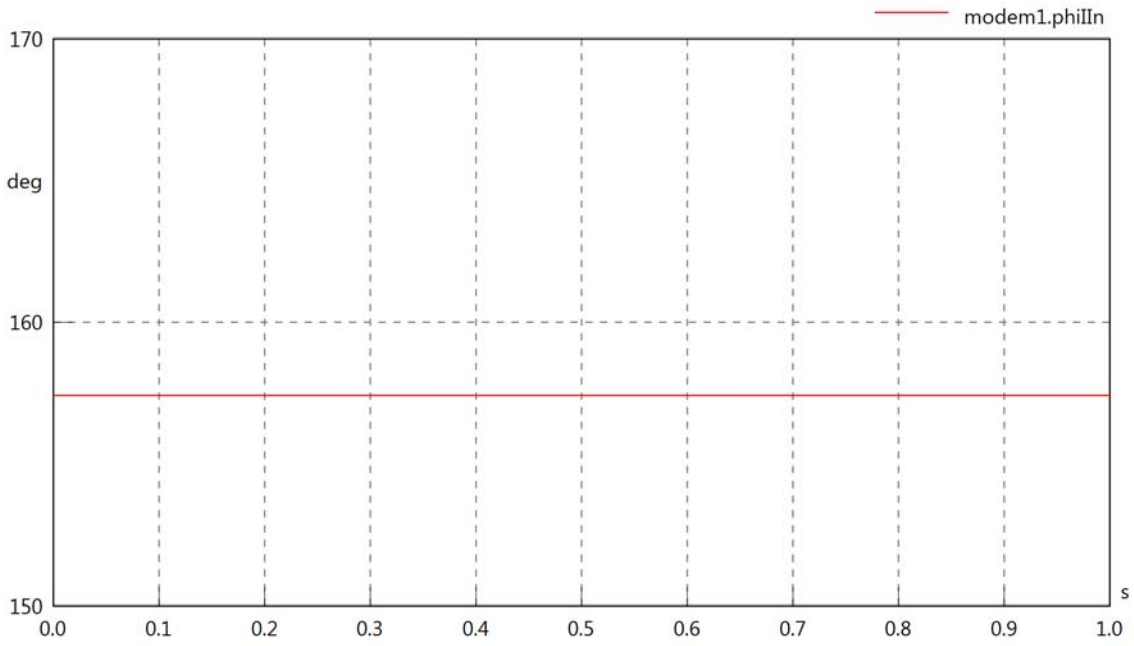

modem1.phiIVIn

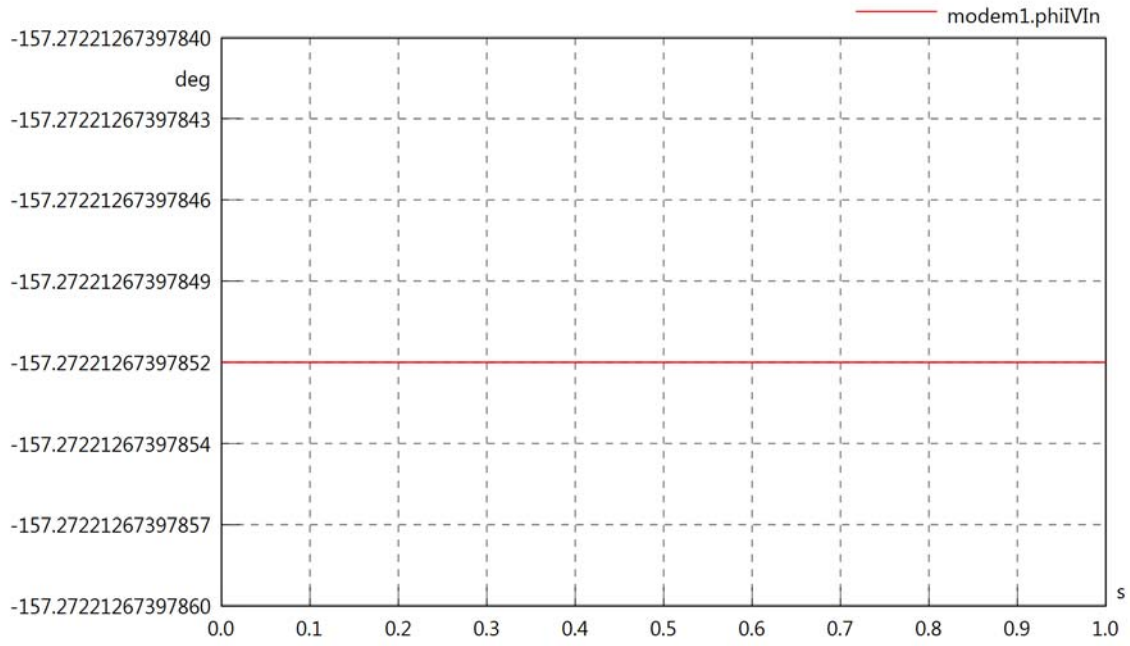

modem1.PReIn

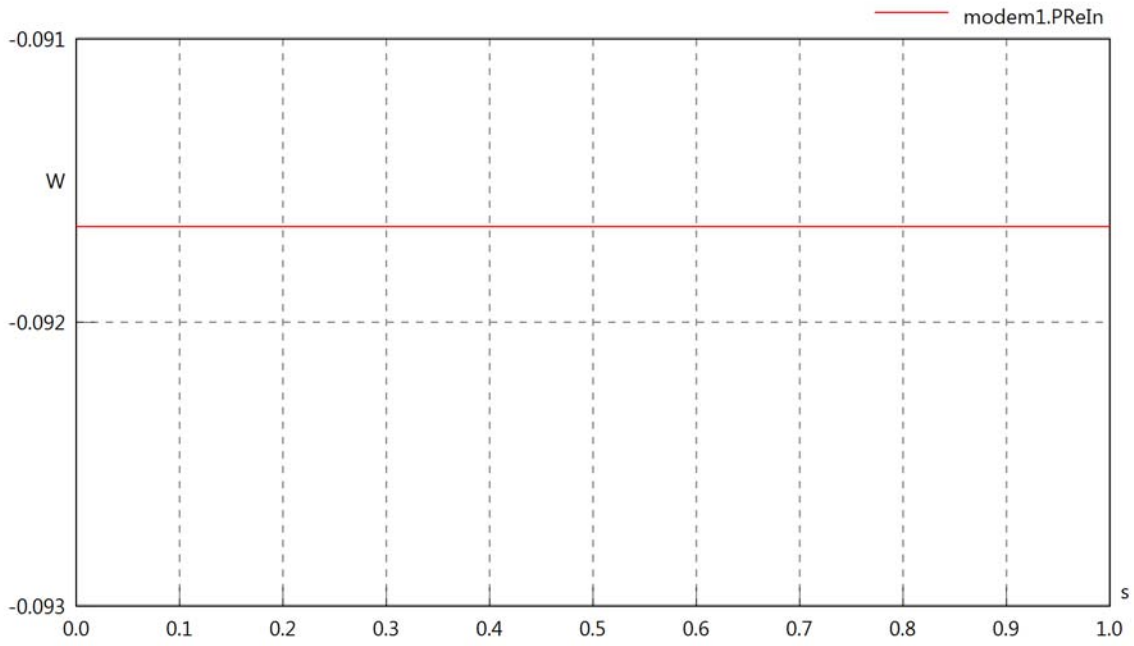

modem1.PImIn

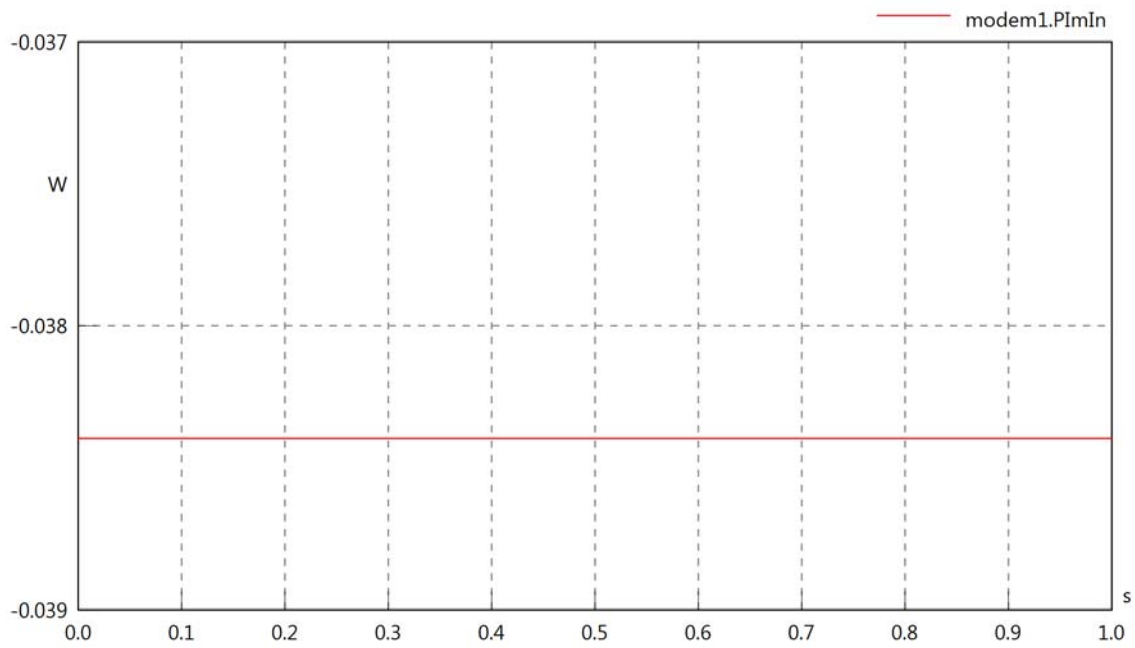

modem1.SIn

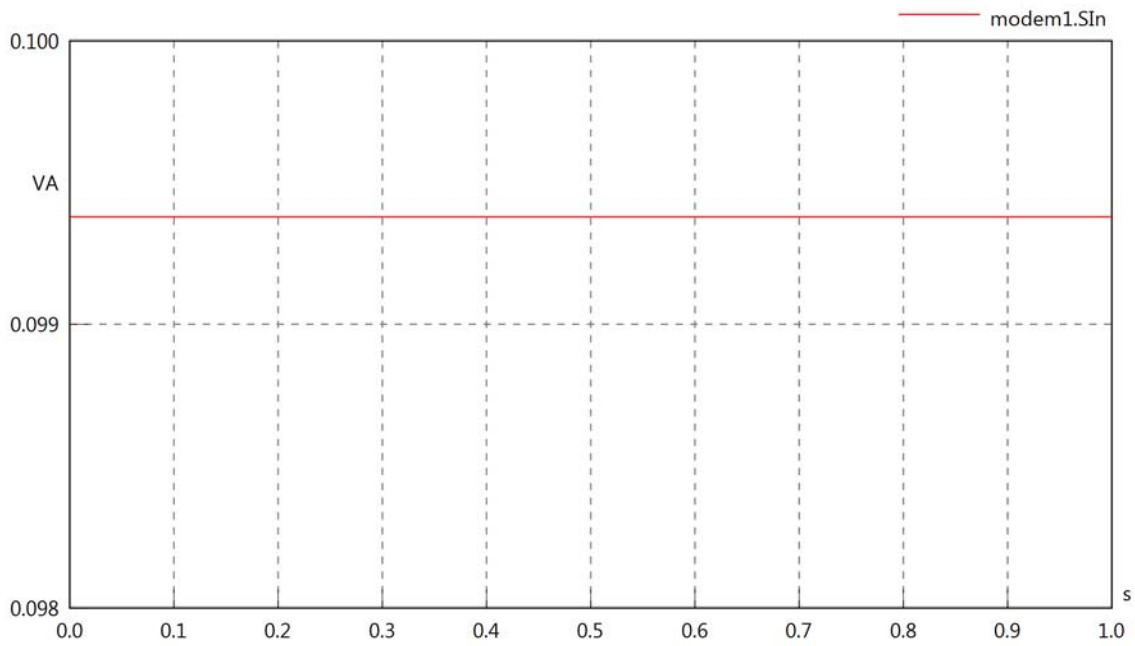
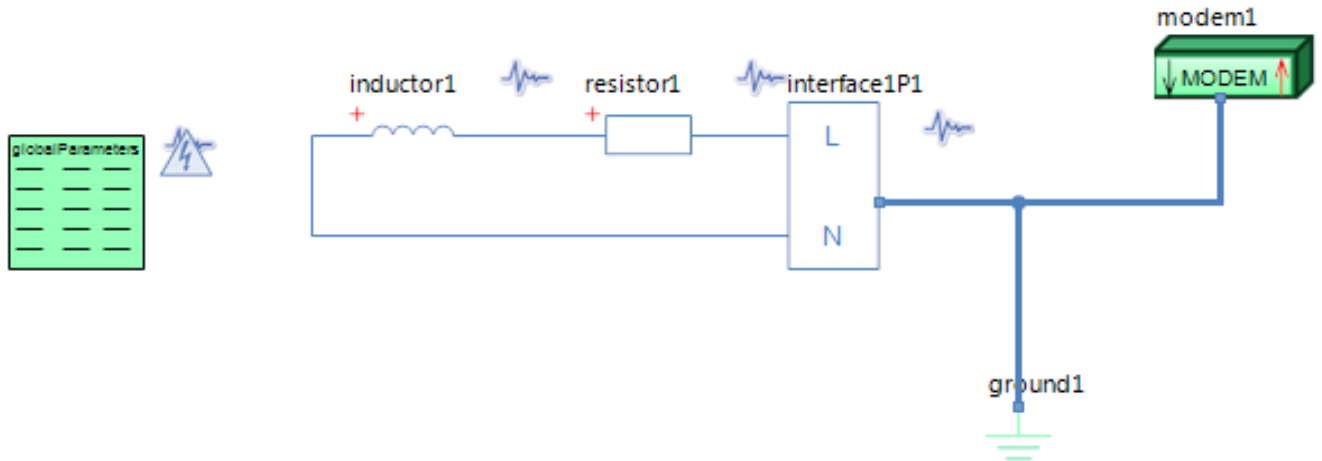

Diagram View



GlobalParameters globalParameters
Parameters

Comment	Name	Current Value	Unit
Type of Calculation	eCalculationKind	Signal Calculation	
Description of Frequency	eFrequencyKind	Linear	
Minimum Frequency	fMin	100	[kHz]
Maximum Frequency	fMax	100	[kHz]

Modem modem1
Parameters

Comment	Name	Current Value	Unit
Modem is sending or receiving	kind	Modem is sending	
Output Resistance	Rout	11	[Ohm]
Voltage or Power input parameter	inKind	Power	
Apparent Power not including Output Resistance	P	0.1	[VA]
Voltage Phase Angle	phiVSig		[deg]

Resistor resistor1
Parameters

Comment	Name	Current Value	Unit
Resistance	R	1500	[Ohm]

Inductor inductor1
Parameters

Comment	Name	Current Value	Unit
Inductance	L	5	[mH]

modem1.VrmsIn

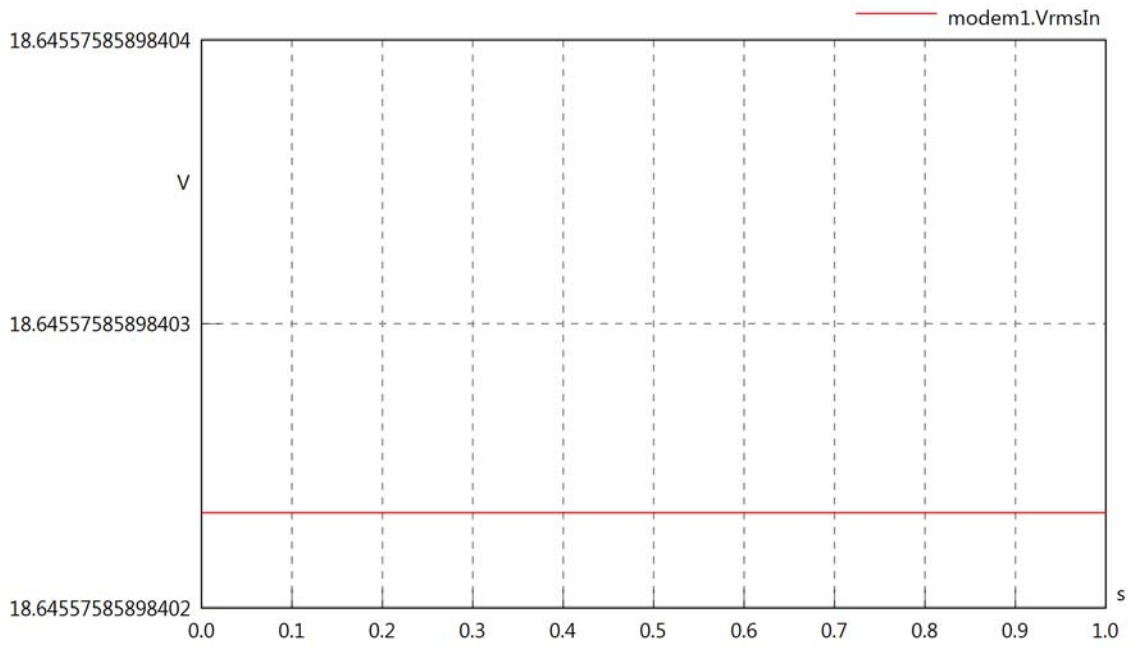

modem1.vReIn

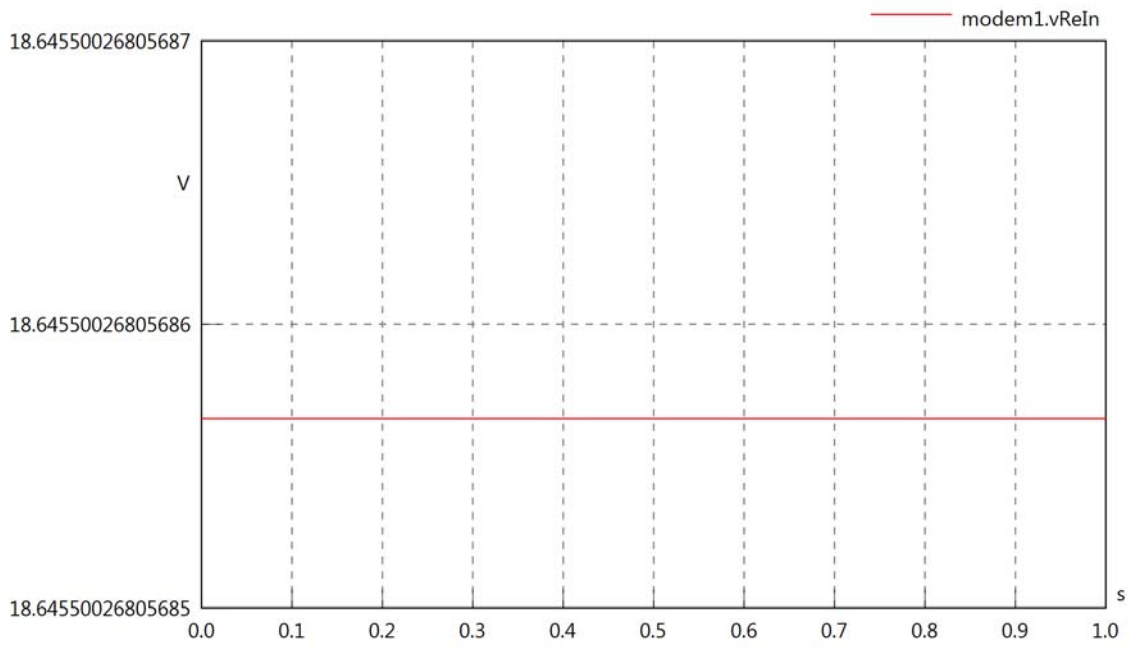

modem1.vImIn

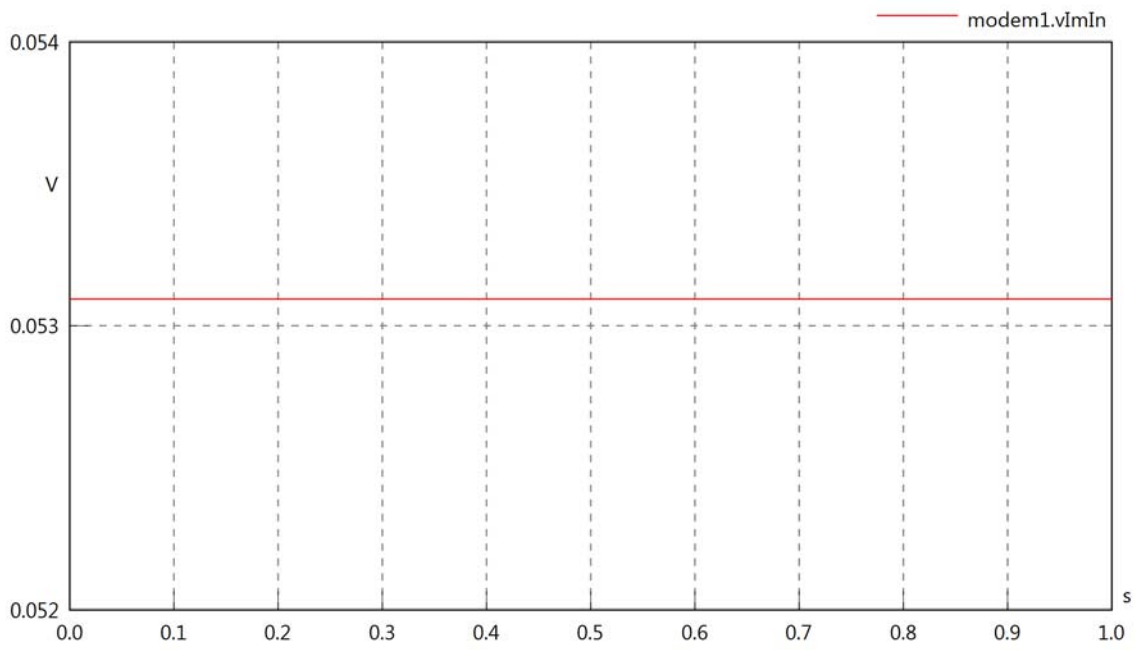

modem1.IrmsIn

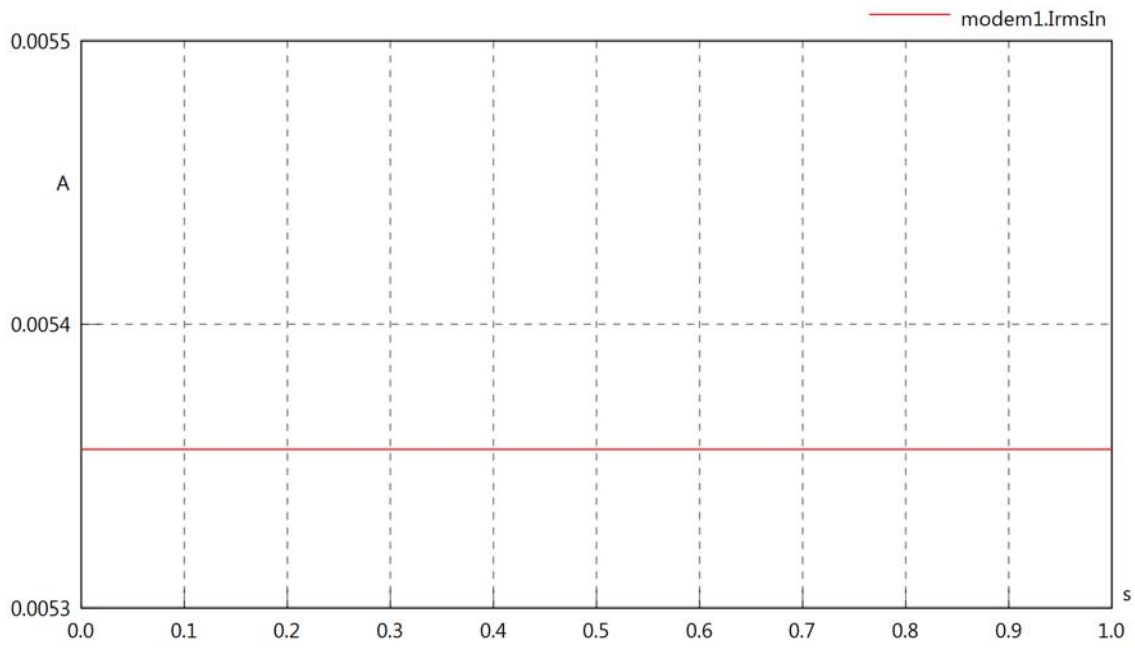

modem1.iReIn

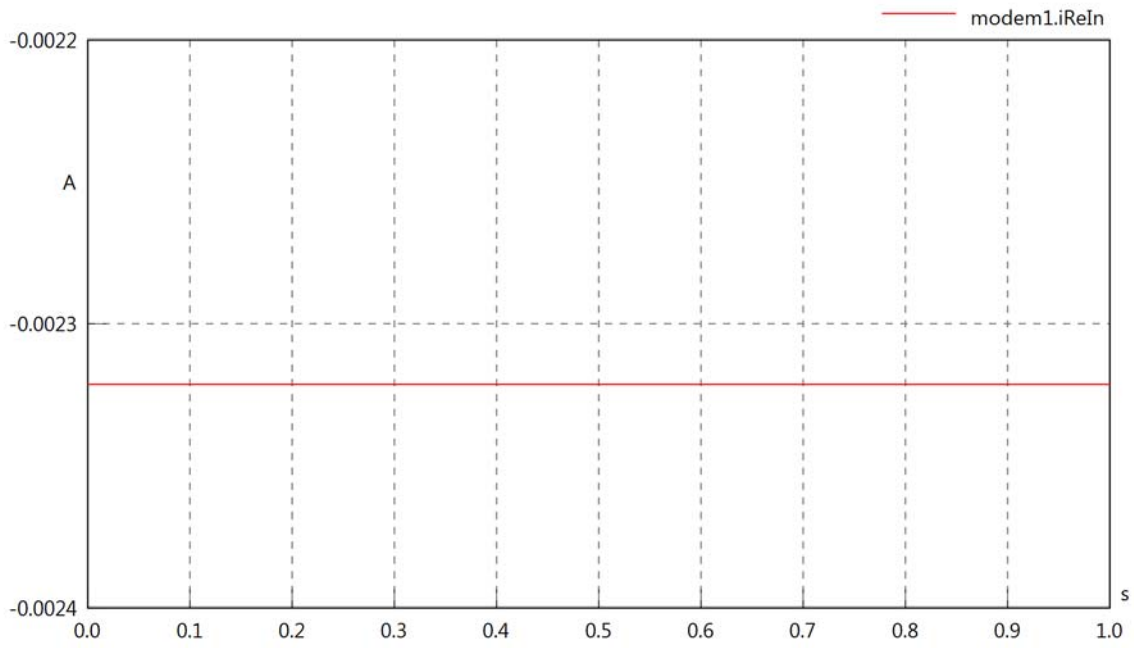

modem1.iImIn

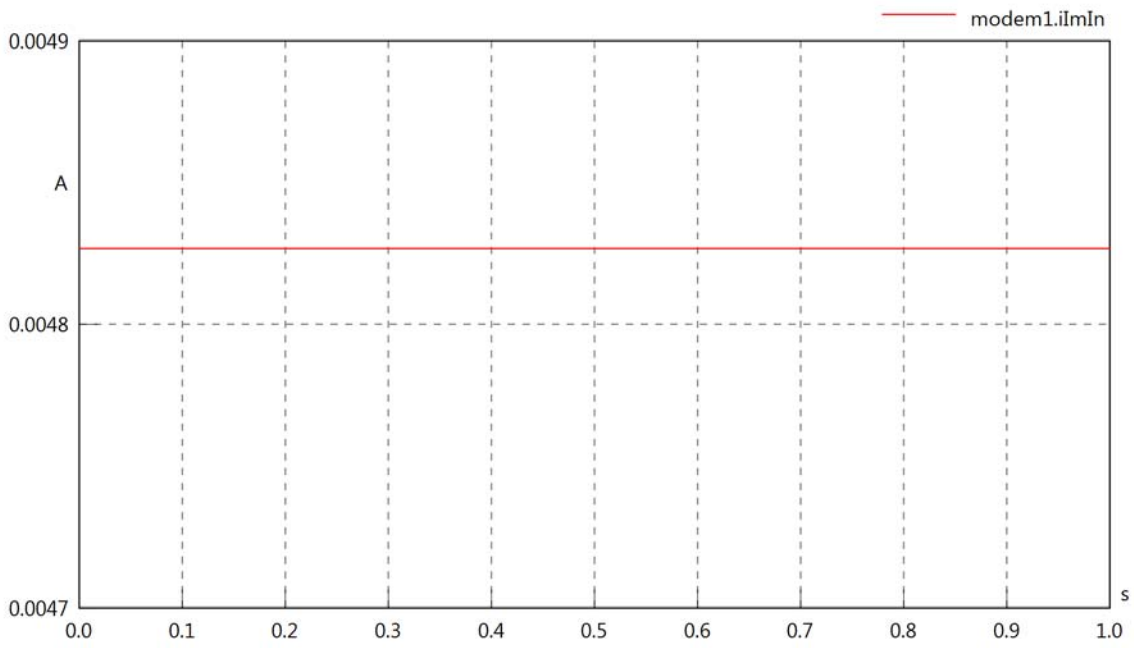

modem1.phiVIn

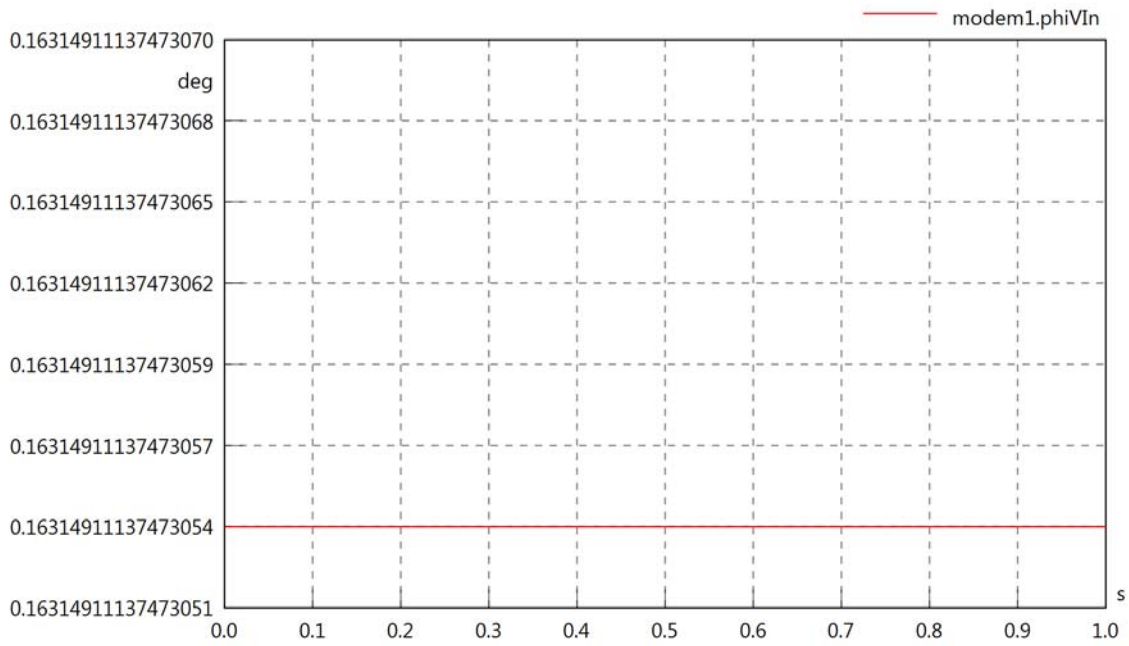

modem1.phiIn

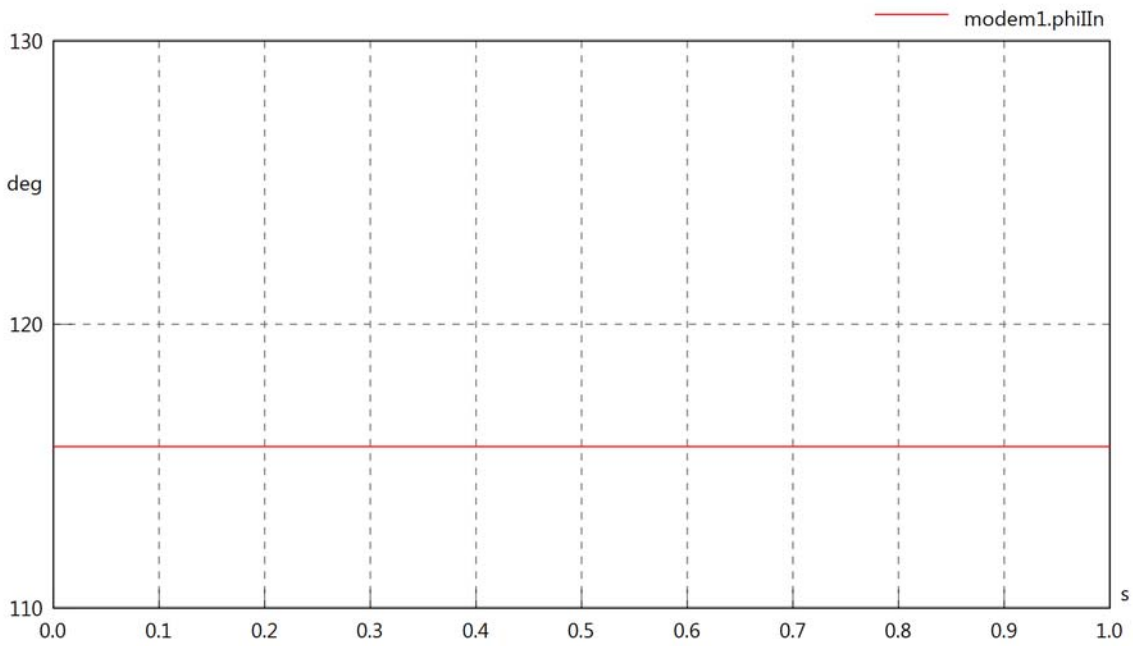

modem1.phiIVIn

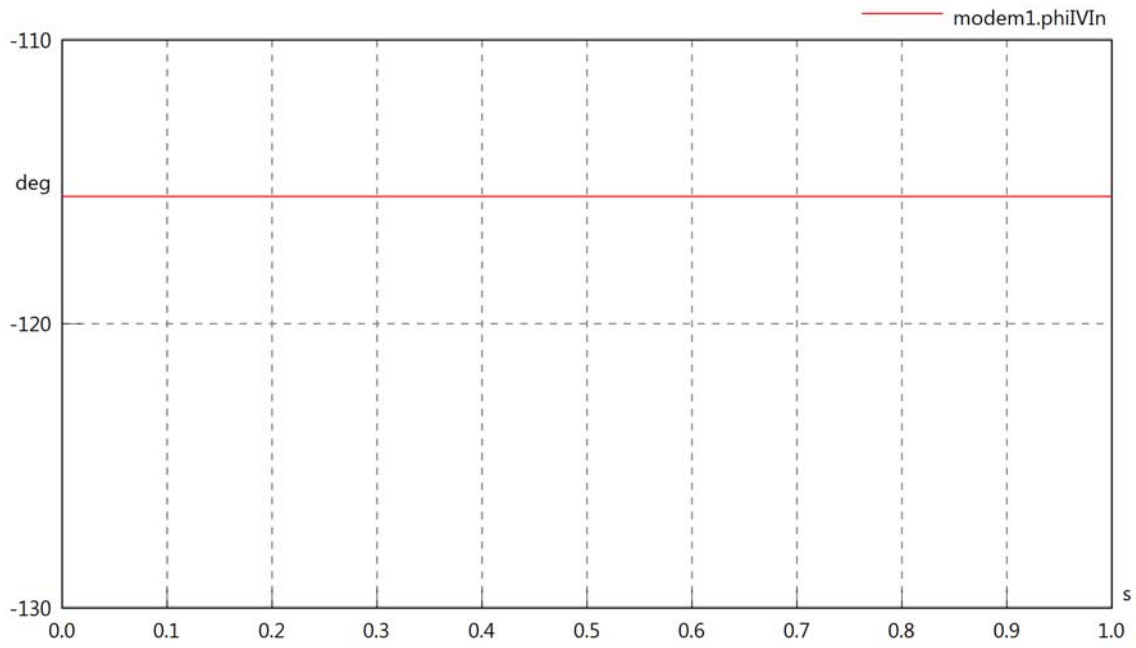

modem1.PReIn

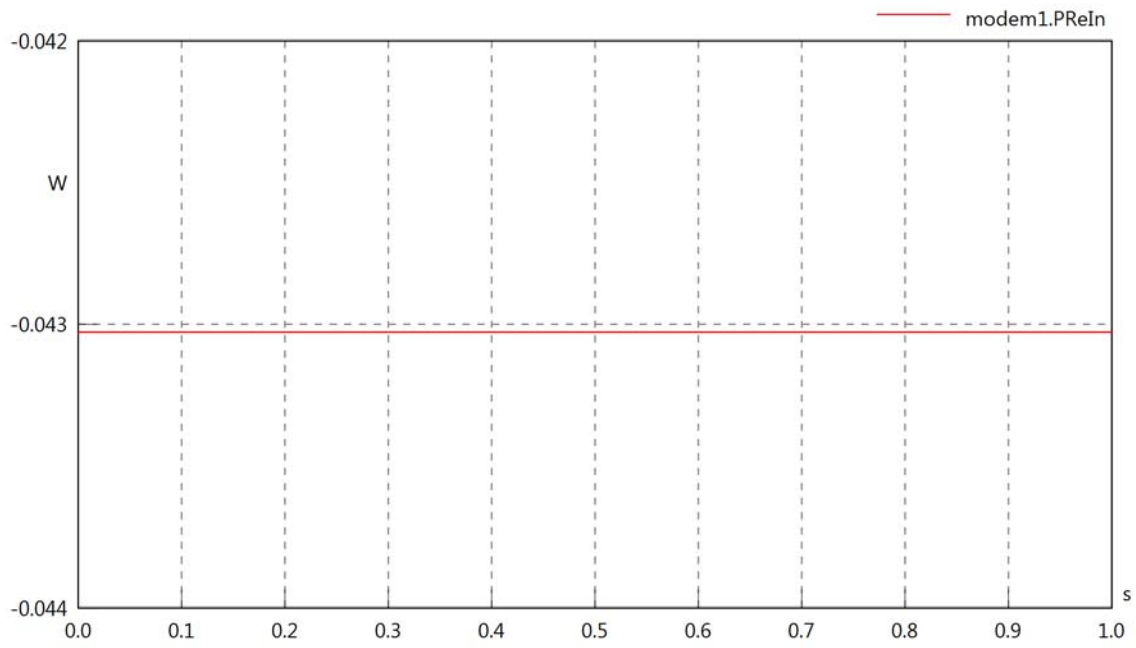

modem1.PImIn

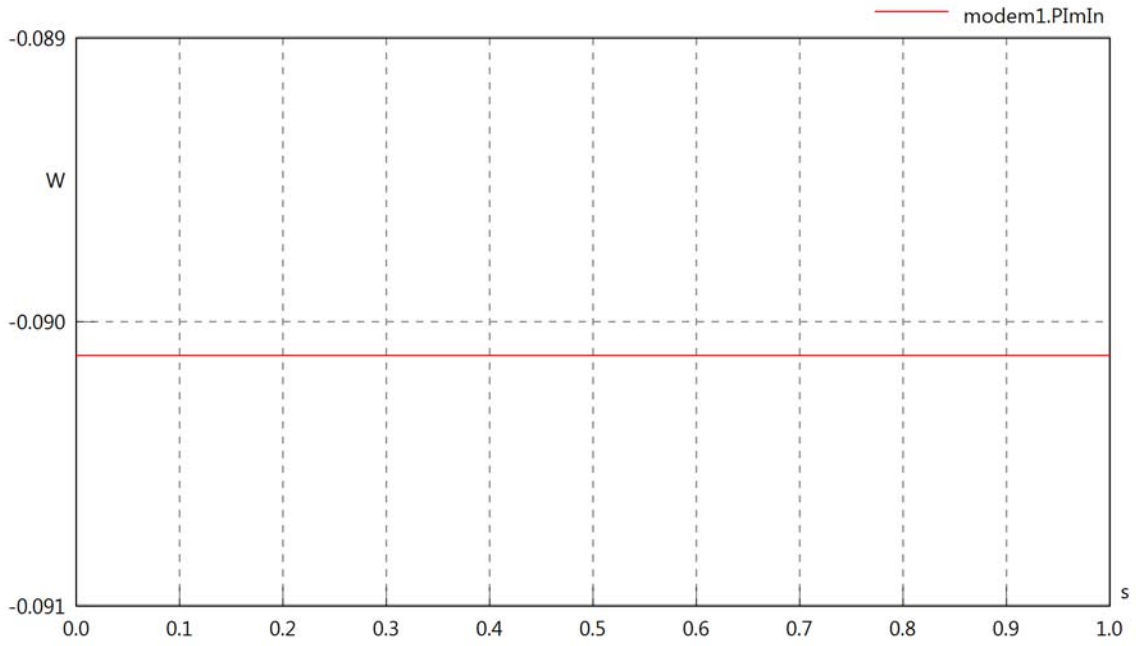

modem1.SIn

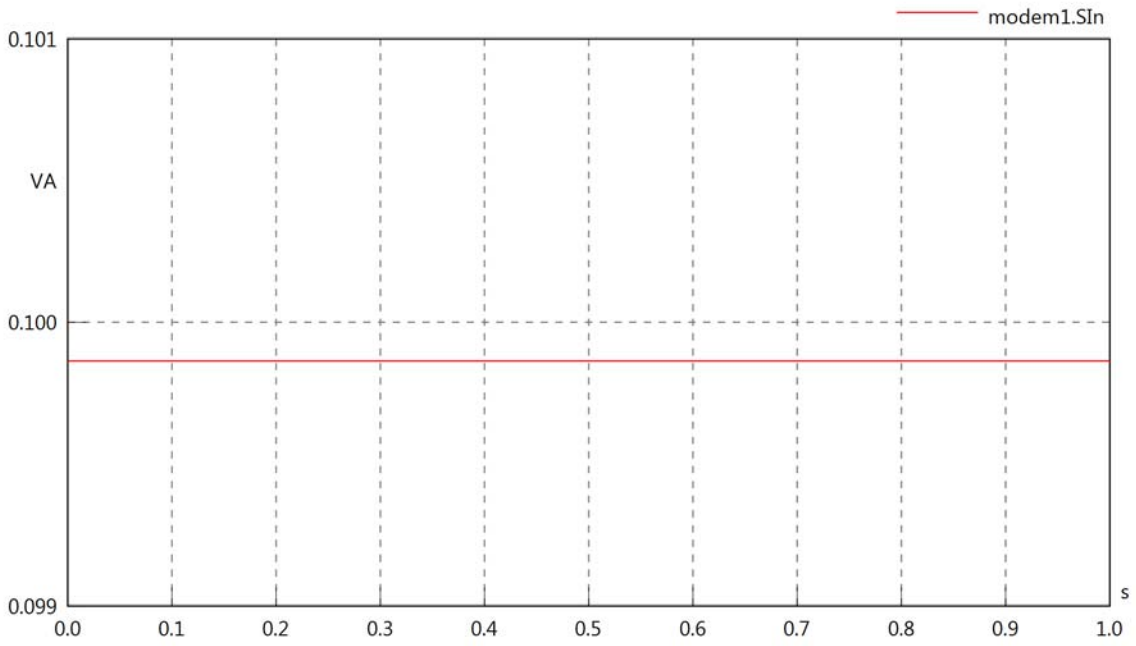
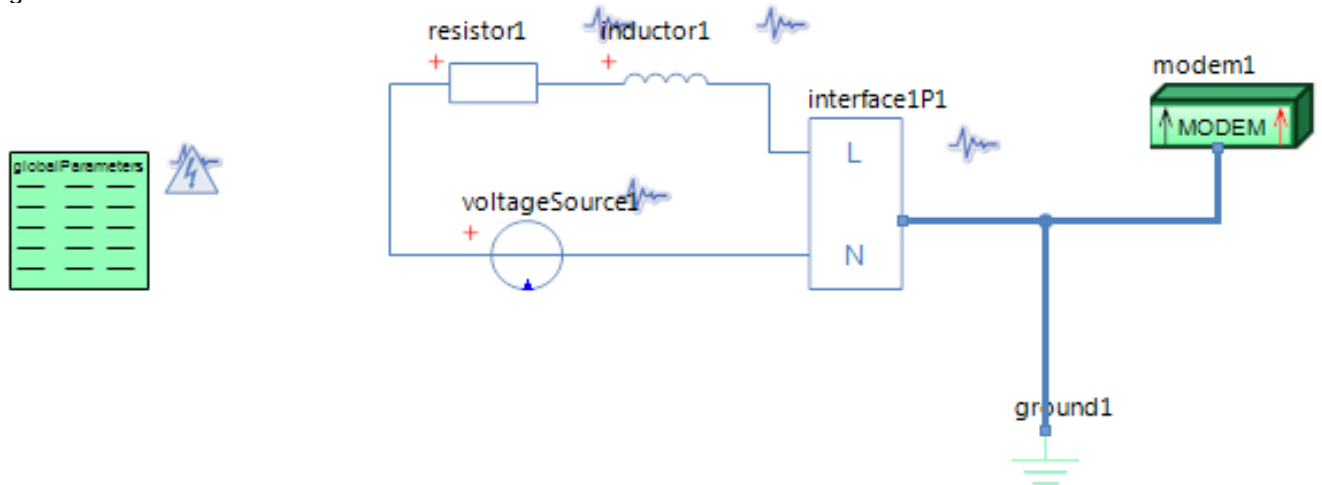

Diagram View



GlobalParameters globalParameters
Parameters

Comment	Name	Current Value	Unit
Type of Calculation	eCalculationKind	Signal Calculation	
Description of Frequency	eFrequencyKind	Linear	
Minimum Frequency	fMin	4	[kHz]
Maximum Frequency	fMax	4	[kHz]

Modem modem1
Parameters

Comment	Name	Current Value	Unit
Modem is sending or receiving	kind	Modem is receiving	
Input Resistance	Rin	1900	[Ohm]

Resistor resistor1
Parameters

Comment	Name	Current Value	Unit
Resistance	R	500	[Ohm]

Inductor inductor1
Parameters

Comment	Name	Current Value	Unit
Inductance	L	5	[mH]

Voltage Source voltageSource1
Parameters

Comment	Name	Current Value	Unit
Voltage RMS	VrmsSrc	10	[V]
Phase	phi	0	[deg]

modem1.VrmsIn

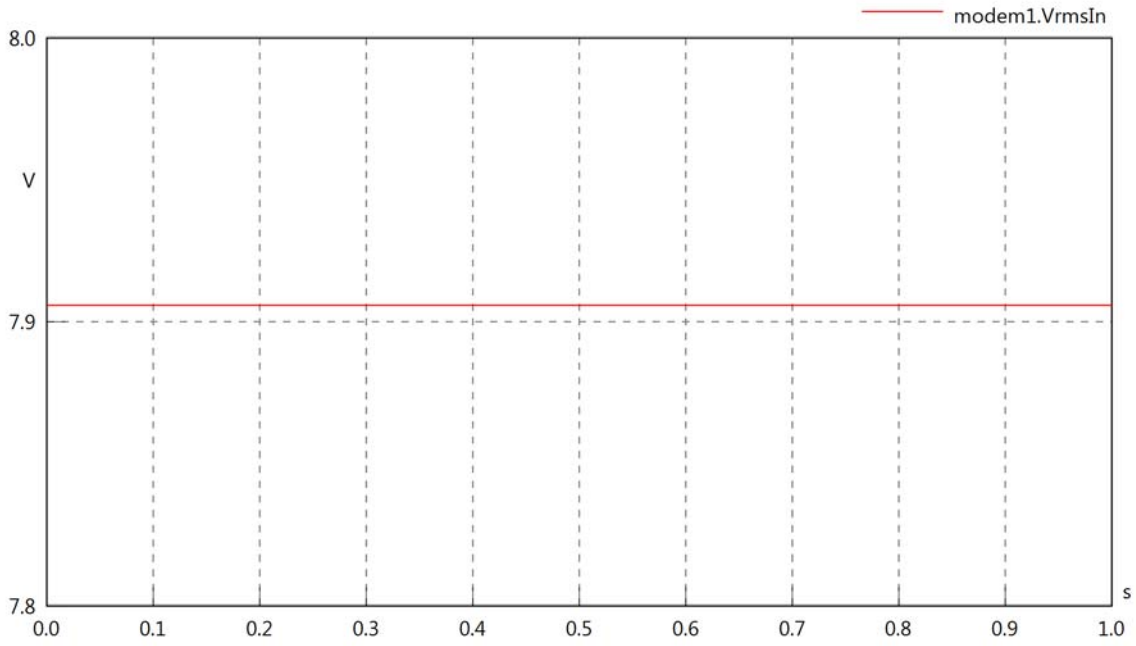

modem1.vReIn

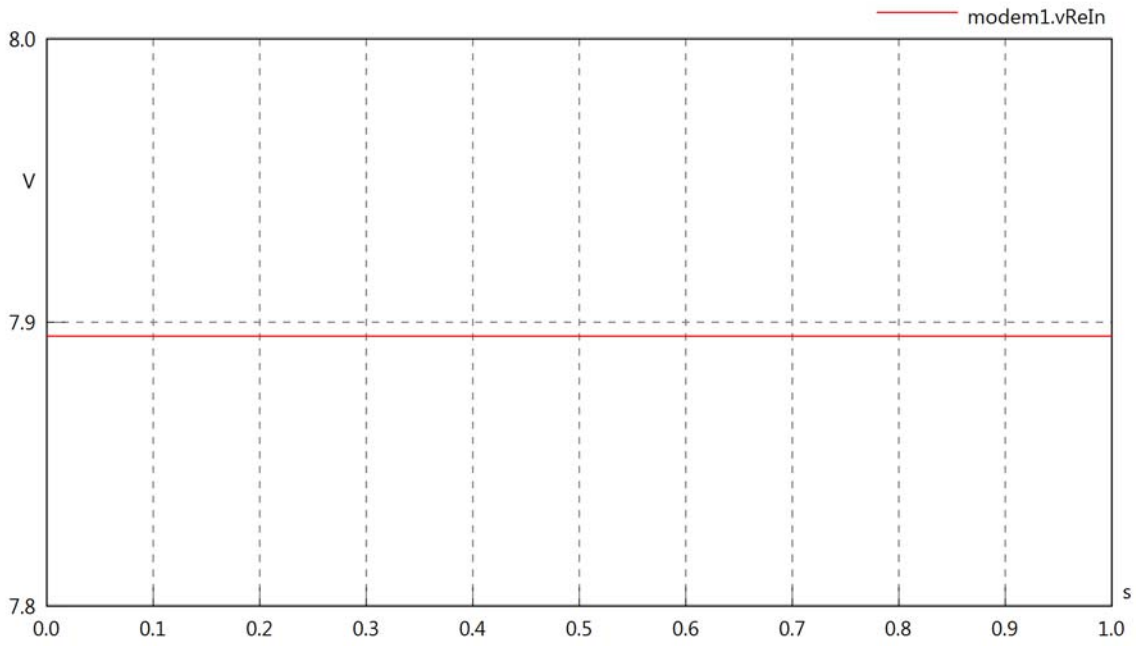

modem1.vImIn

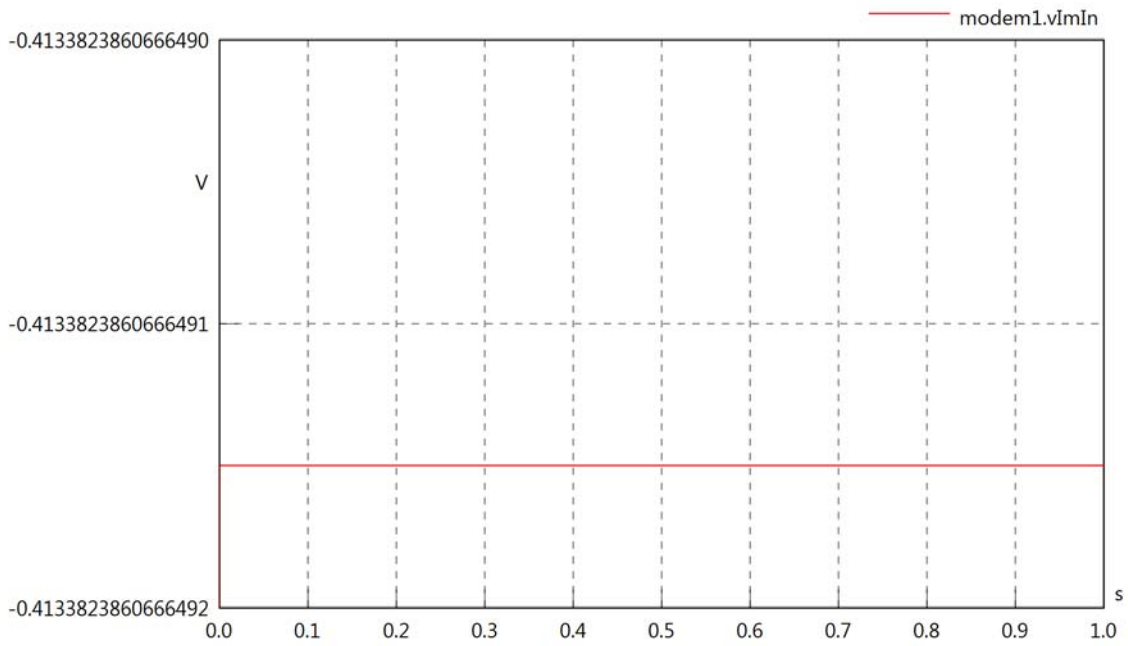

modem1.IrmsIn

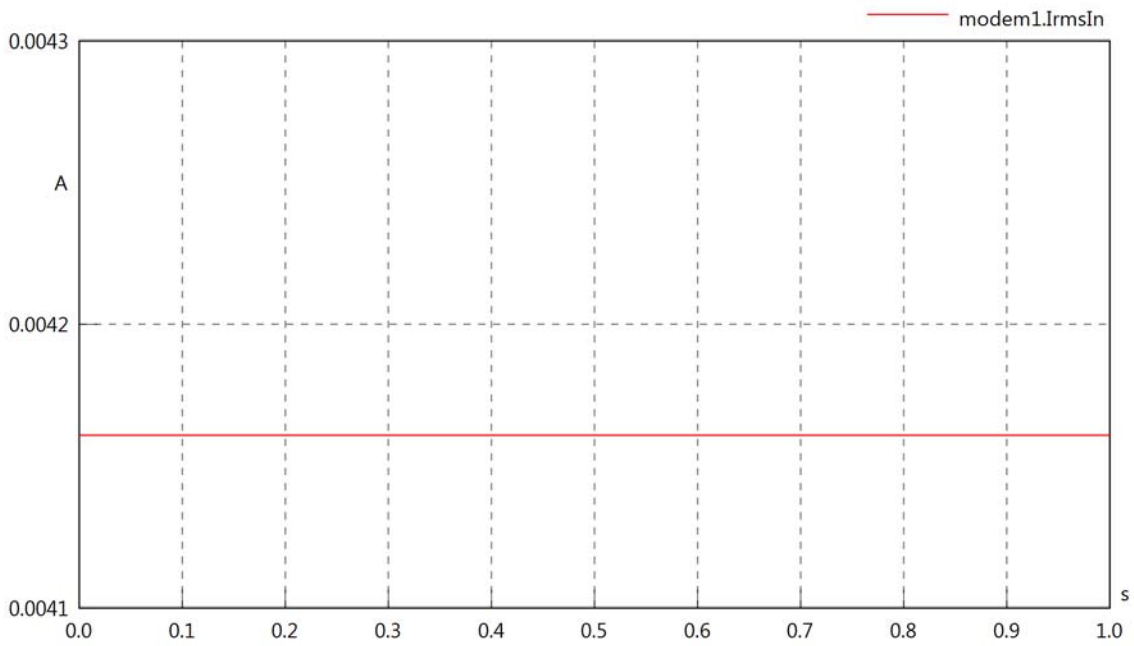

modem1.iReIn

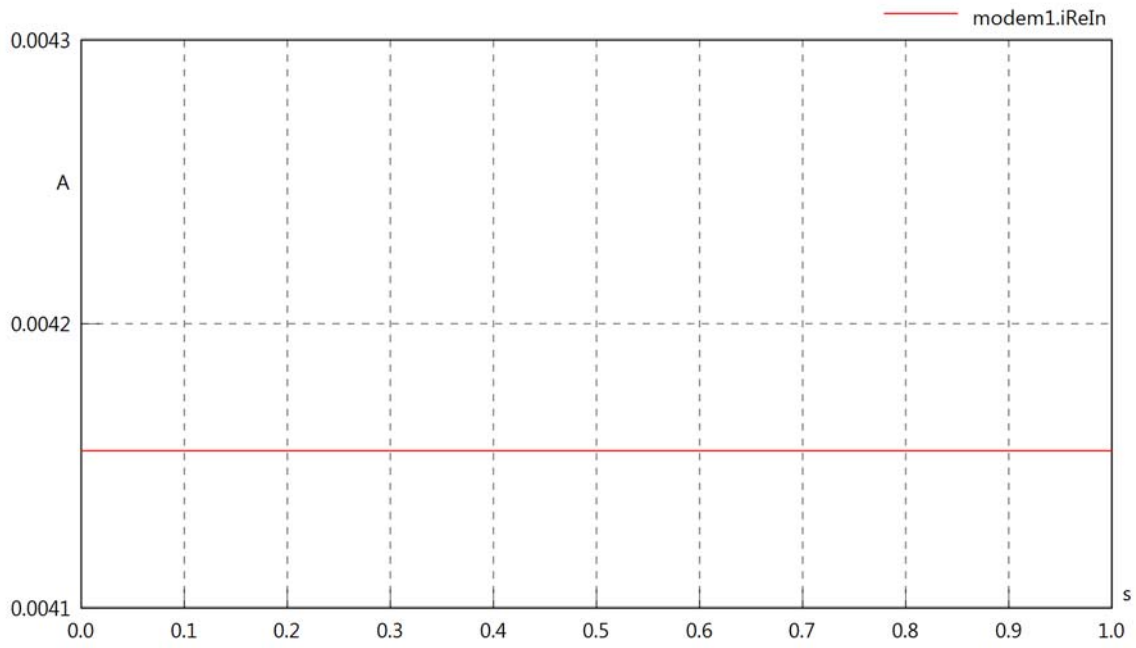

modem1.iImIn

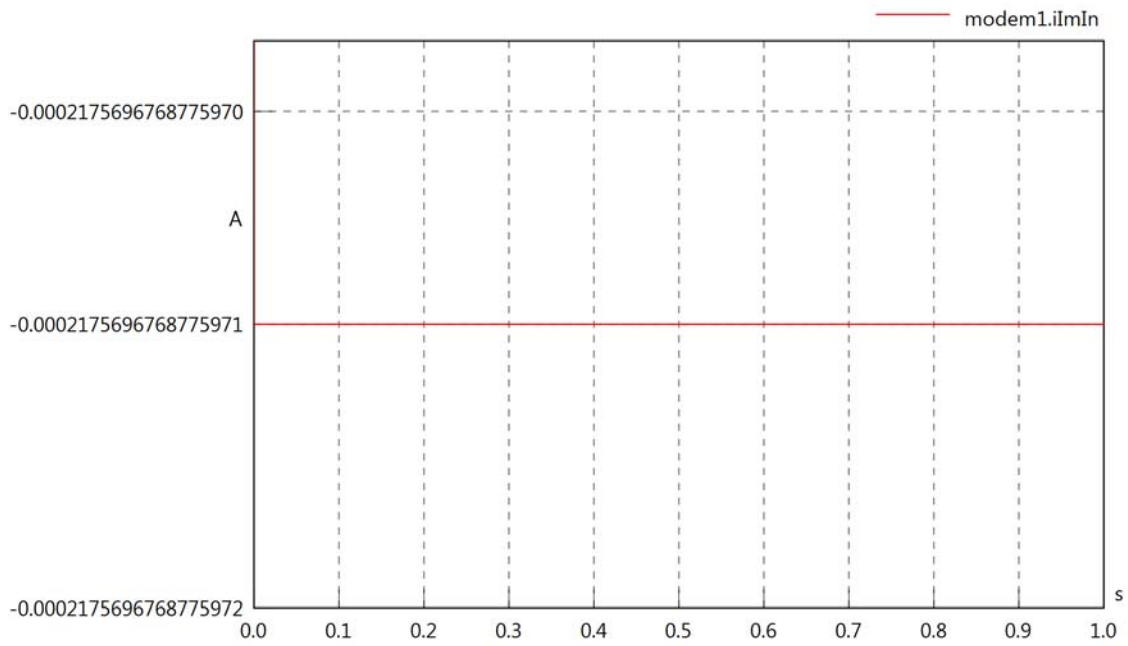

modem1.phiVIn

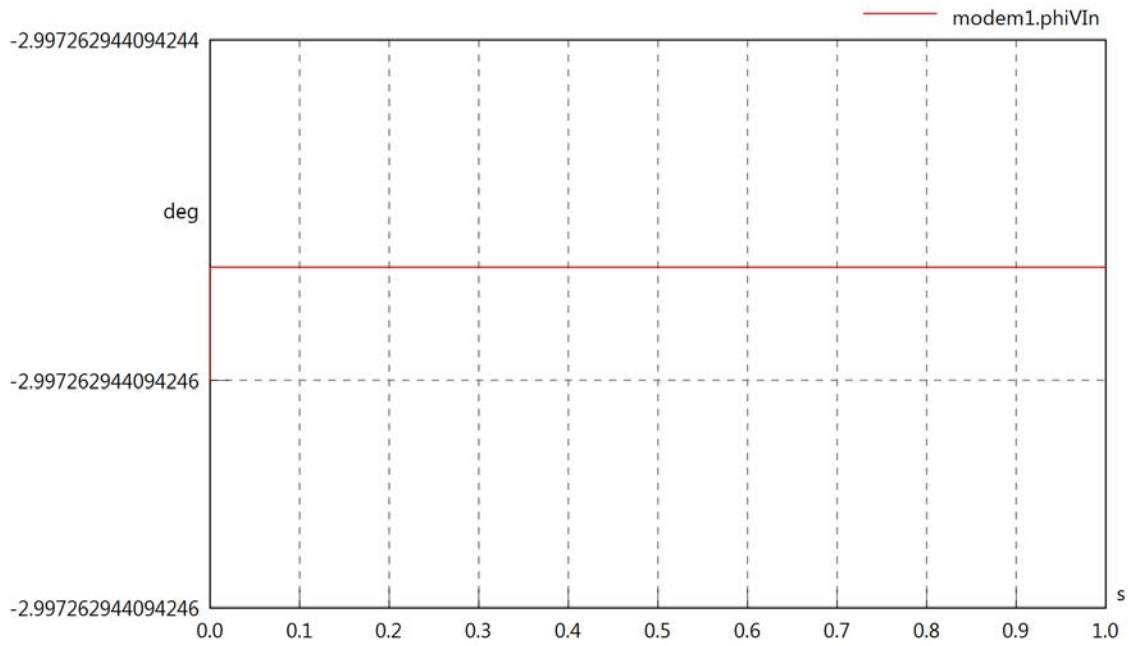

modem1.phiIIn

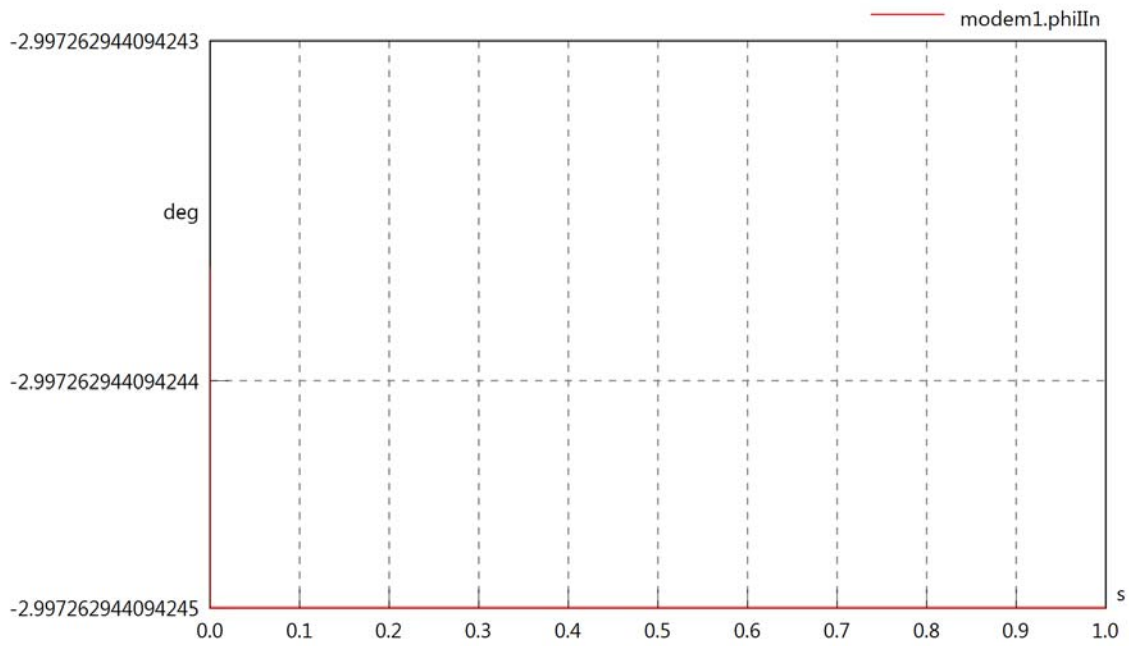

modem1.phiIVIn

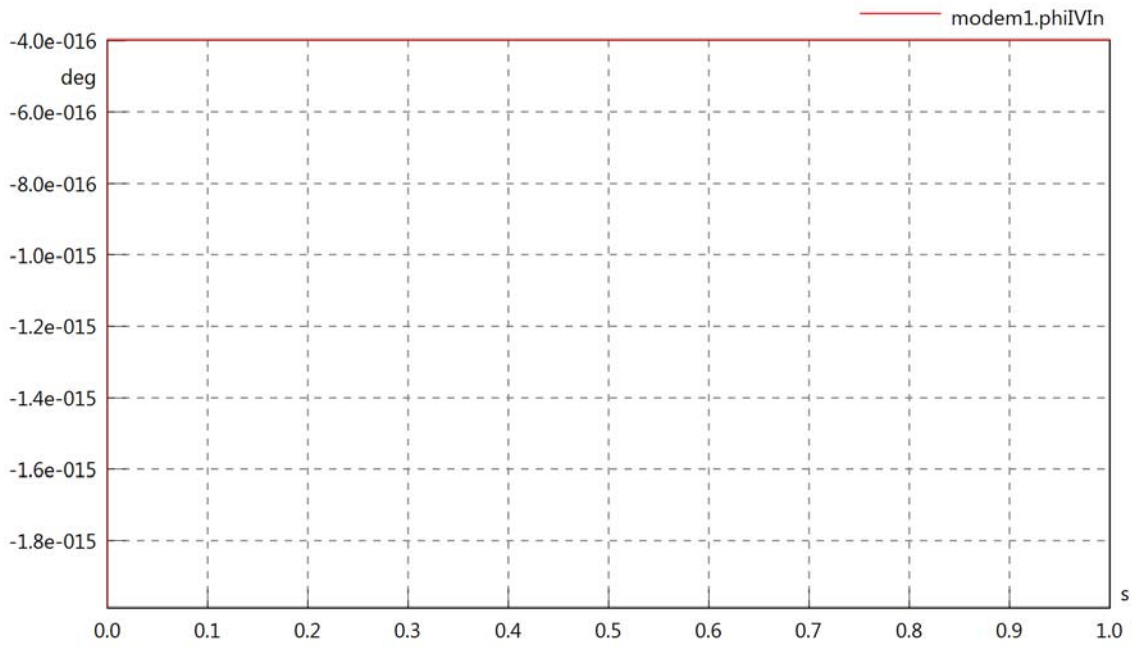

modem1.PReIn

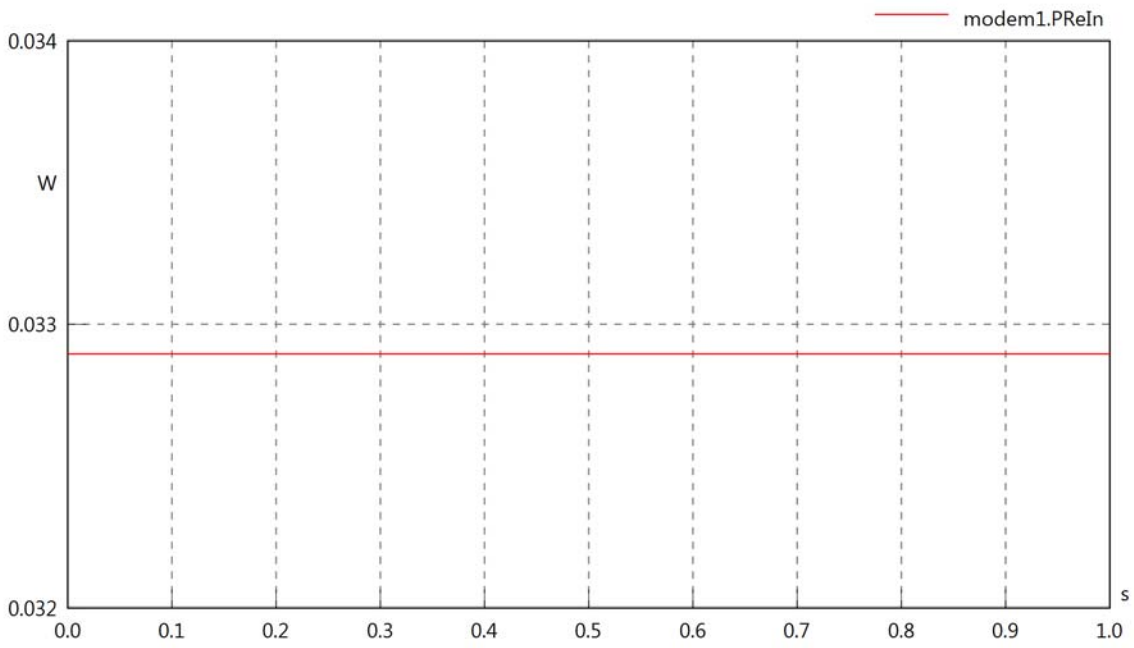

modem1.PImIn

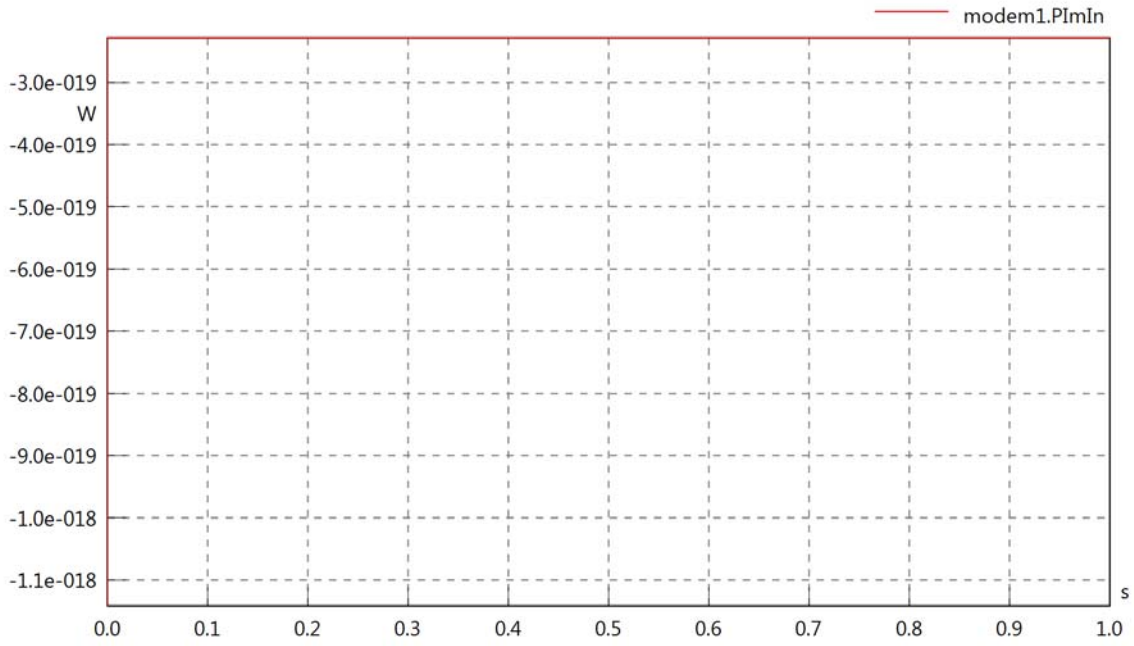

modem1.SIn

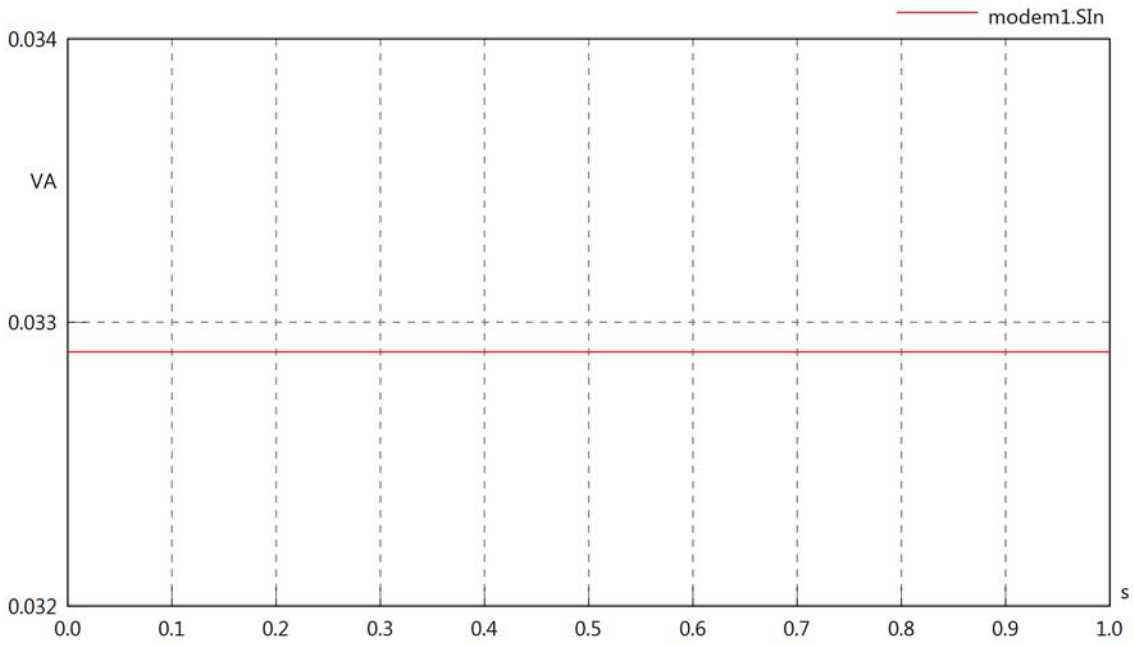
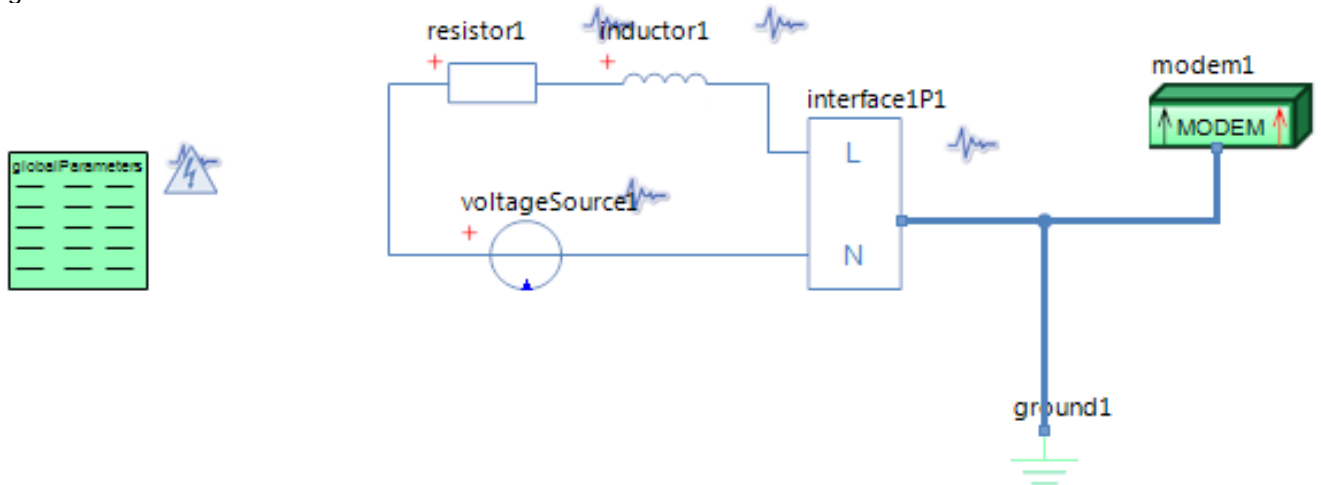

Diagram View



GlobalParameters globalParameters
Parameters

Comment	Name	Current Value	Unit
Type of Calculation	eCalculationKind	Signal Calculation	
Description of Frequency	eFrequencyKind	Linear	
Minimum Frequency	fMin	20	[kHz]
Maximum Frequency	fMax	20	[kHz]

Modem modem1
Parameters

Comment	Name	Current Value	Unit
Modem is sending or receiving	kind	Modem is receiving	
Input Resistance	Rin	1900	[Ohm]

Resistor resistor1
Parameters

Comment	Name	Current Value	Unit
Resistance	R	500	[Ohm]

Inductor inductor1
Parameters

Comment	Name	Current Value	Unit
Inductance	L	5	[mH]

Voltage Source voltageSource1
Parameters

Comment	Name	Current Value	Unit
Voltage RMS	VrmsSrc	10	[V]
Phase	phi	0	[deg]

modem1.VrmsIn

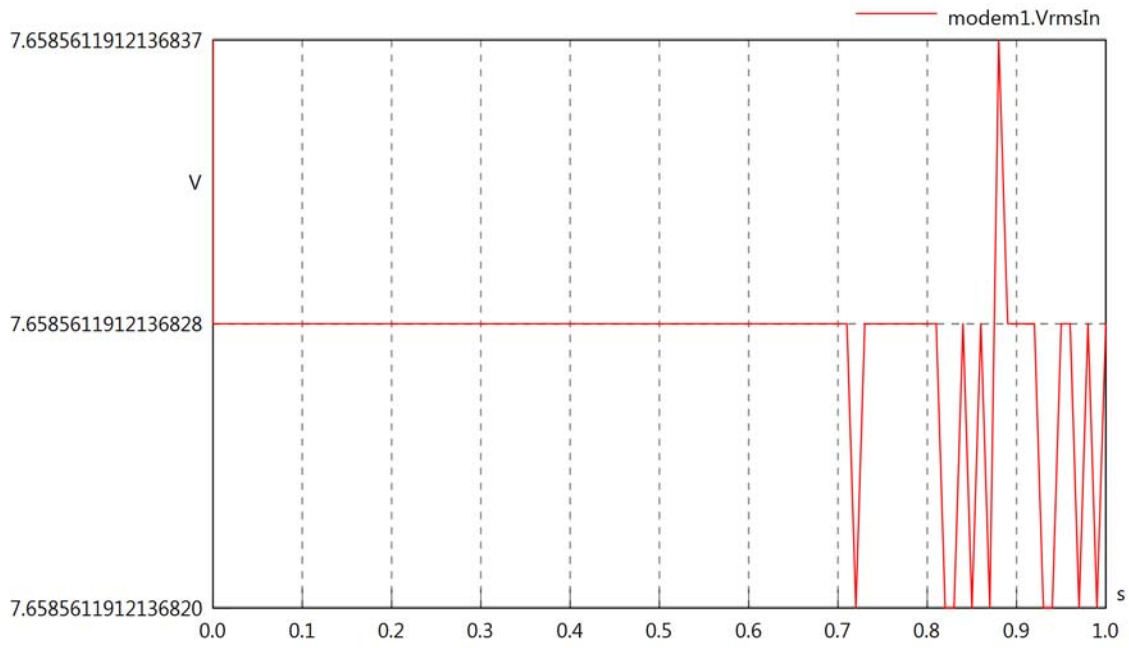

modem1.vReIn

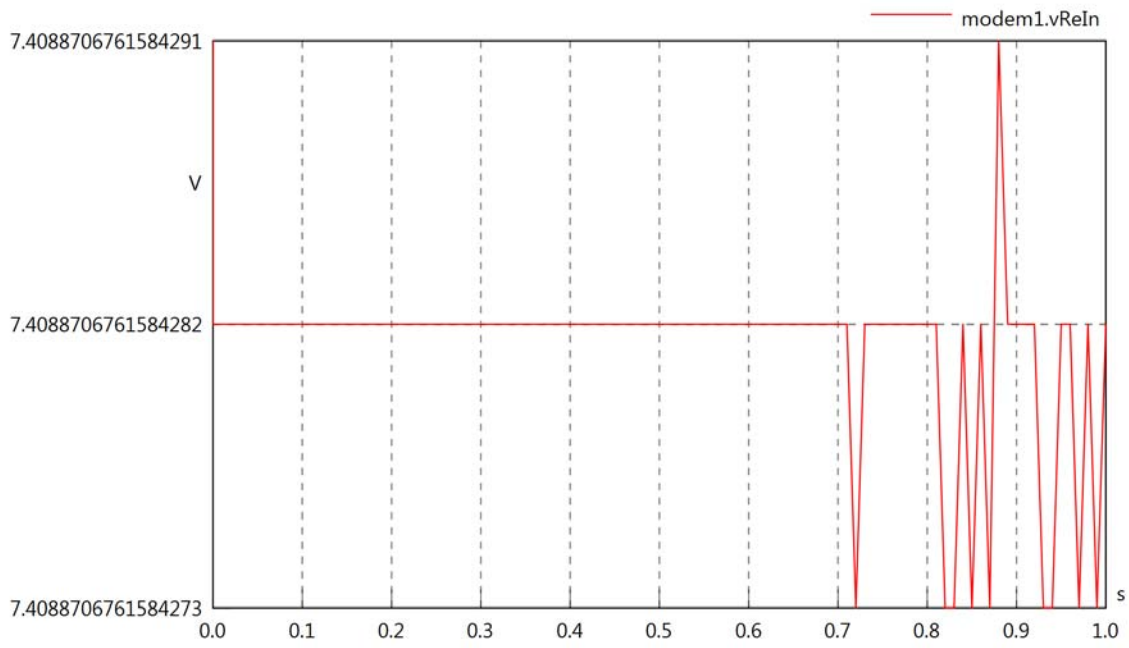

modem1.vImIn

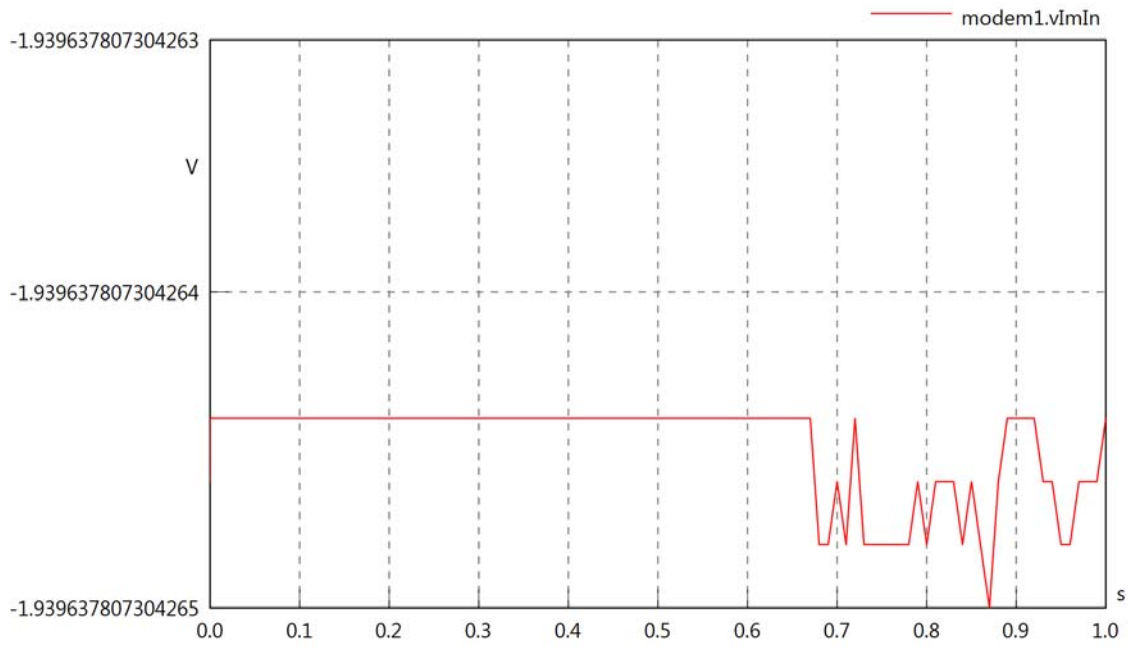

modem1.IrmsIn

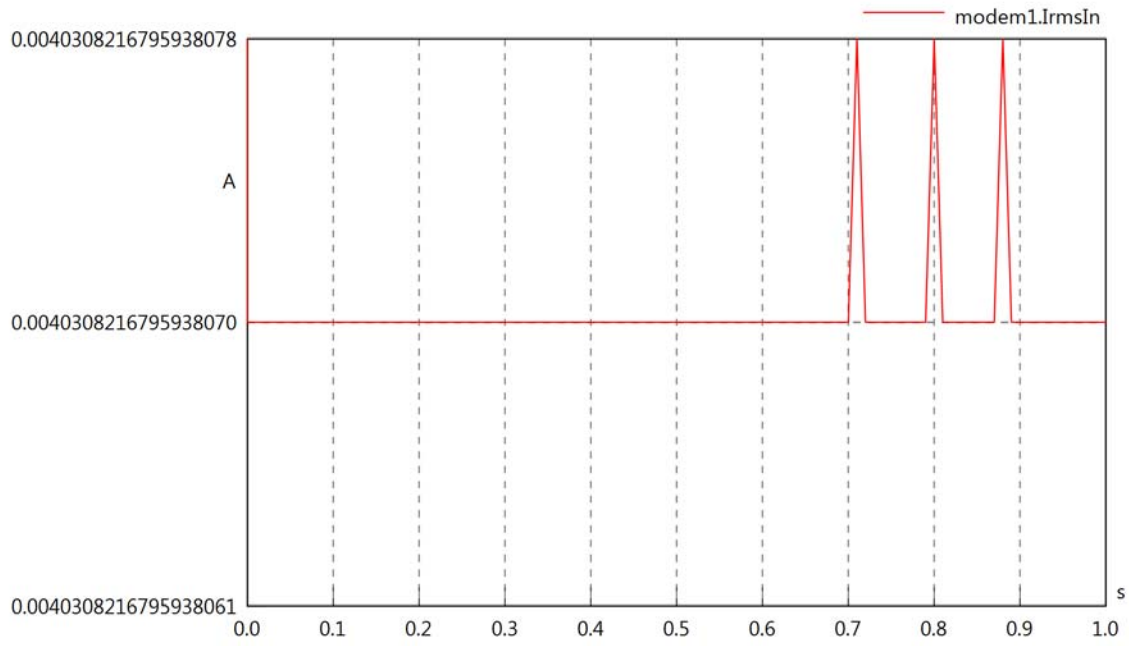

modem1.iReIn

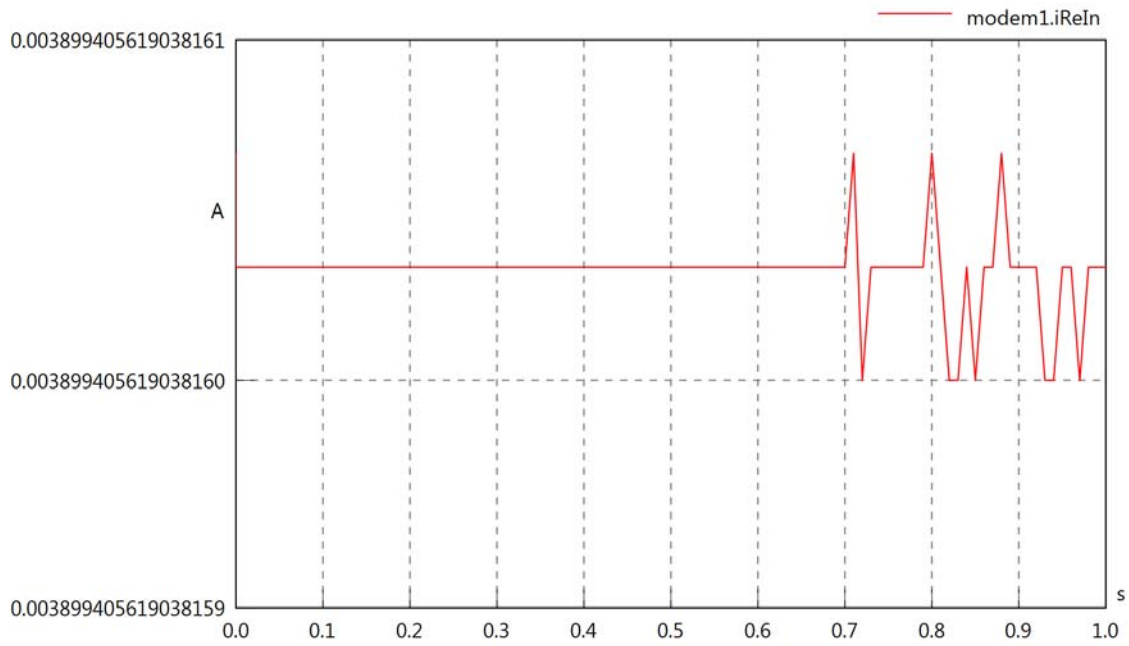

modem1.iImIn

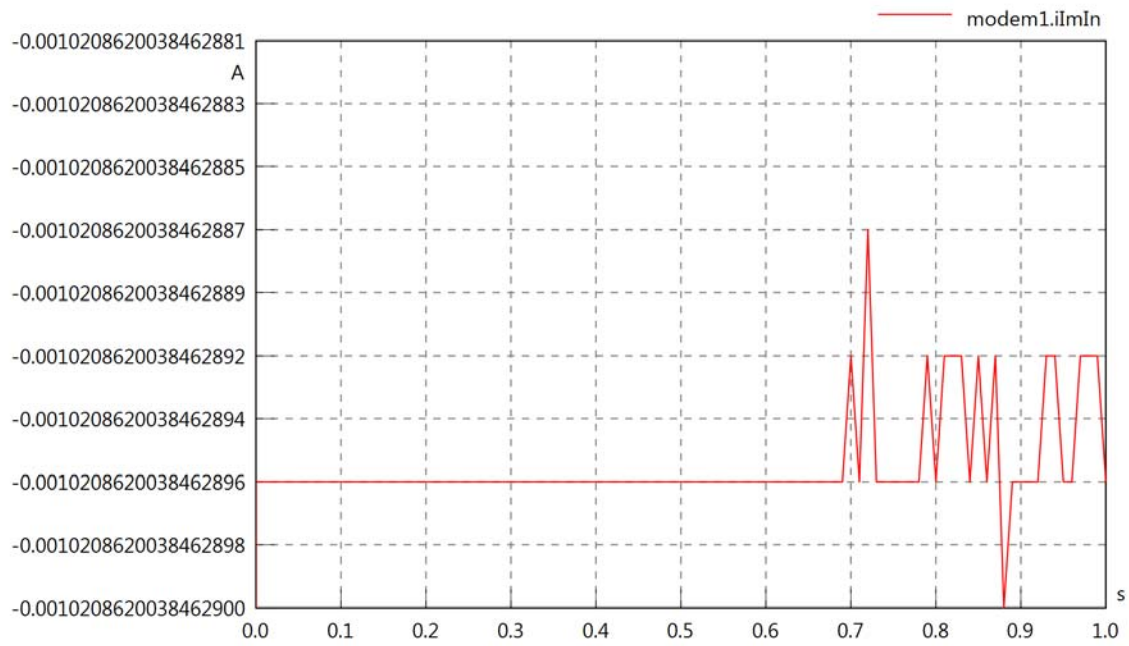

modem1.phiVIn

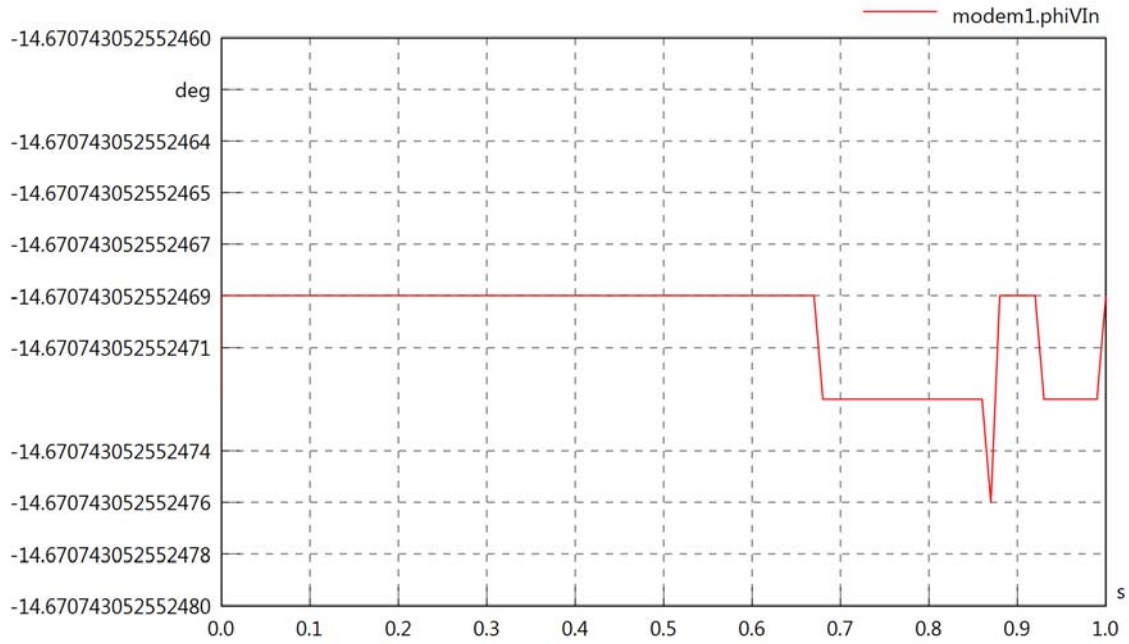

modem1.phiIn

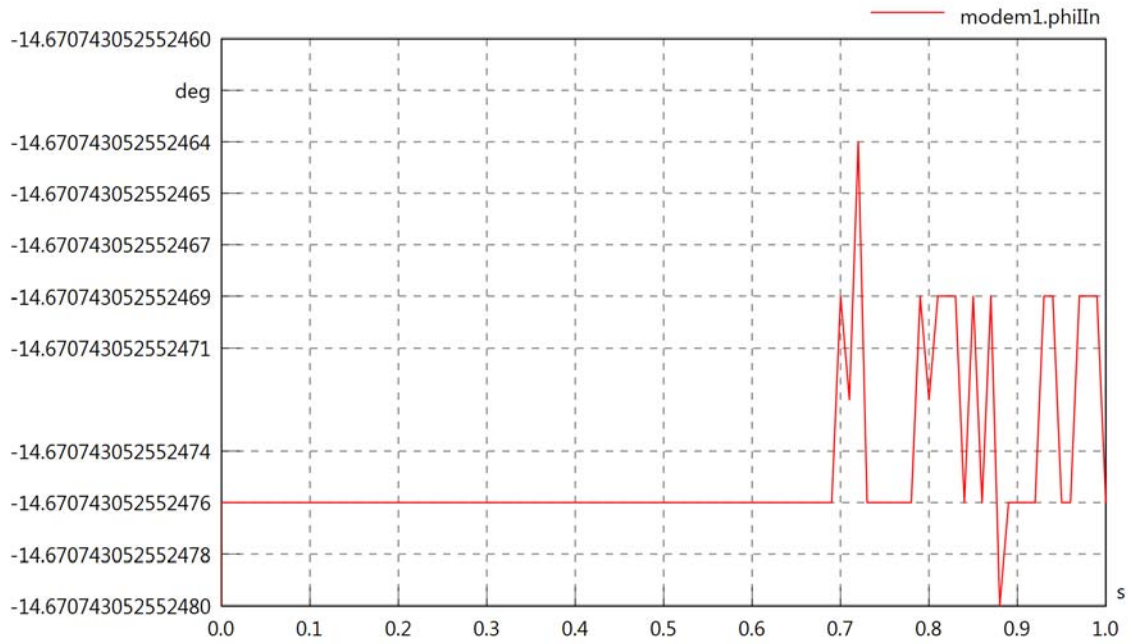

modem1.phiIVIn

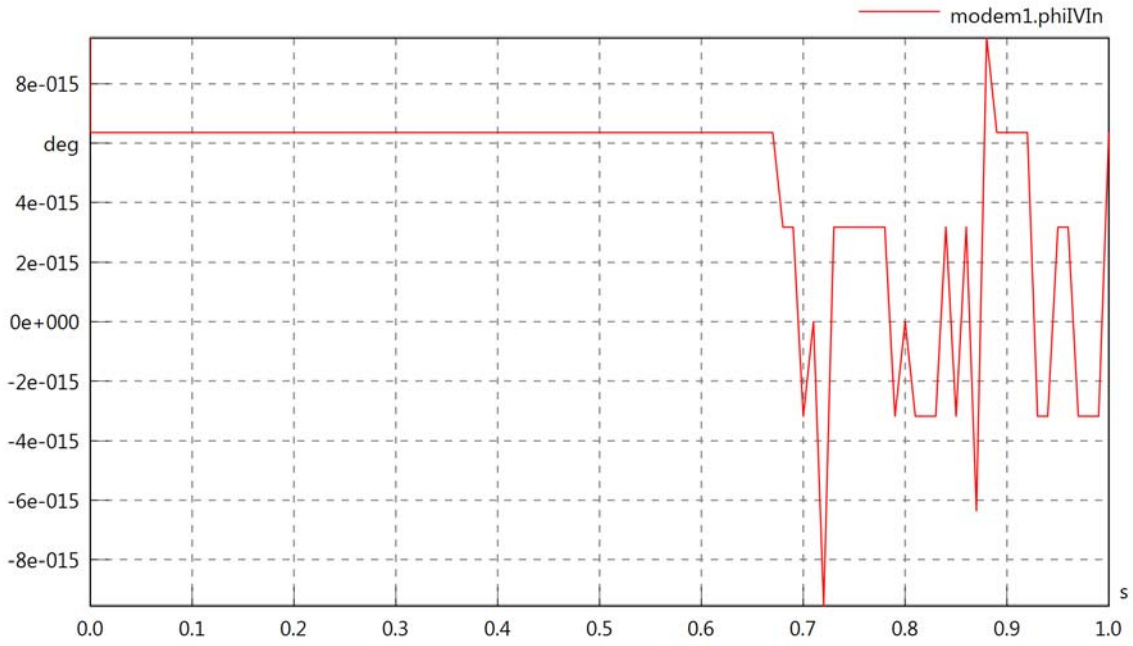

modem1.PReIn

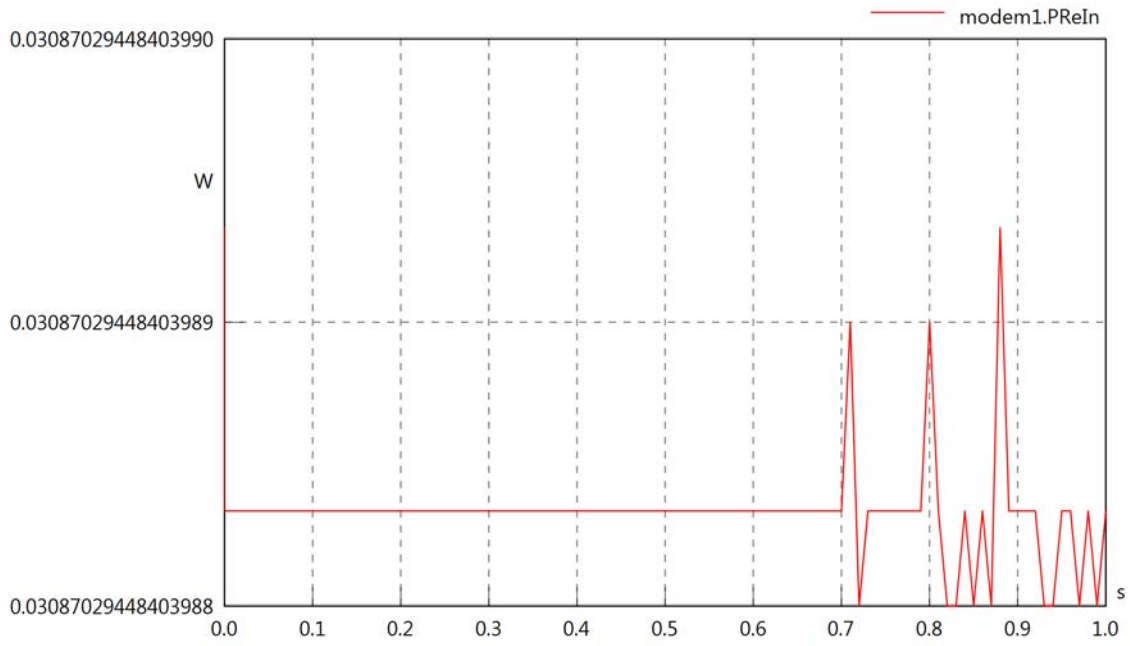

modem1.PImIn

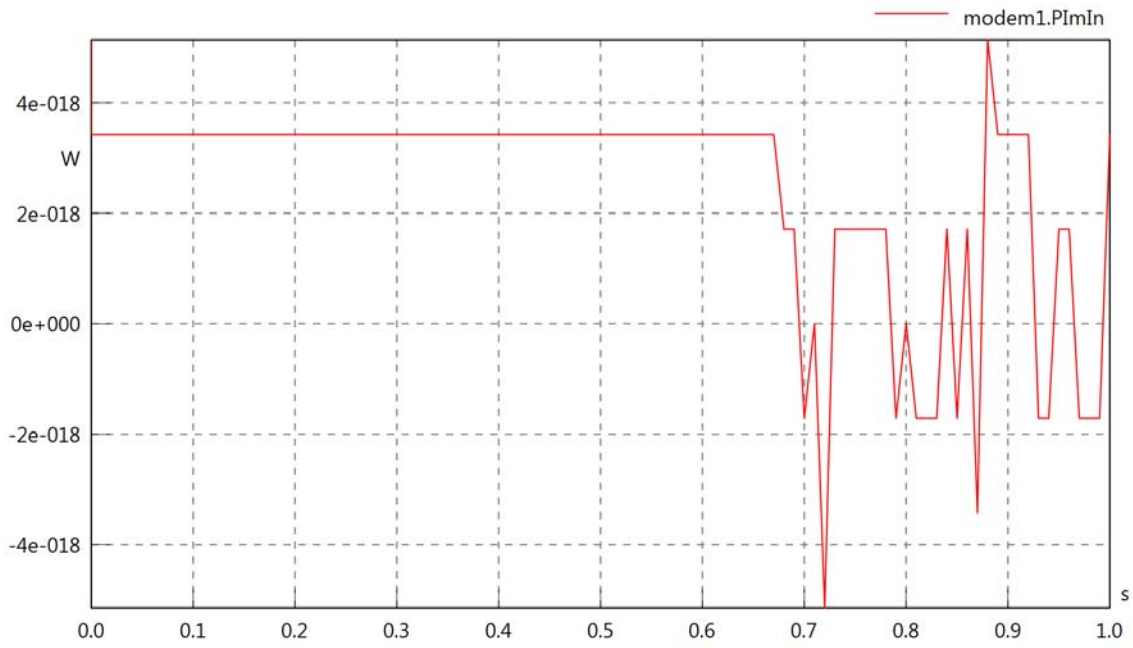

modem1.SIn

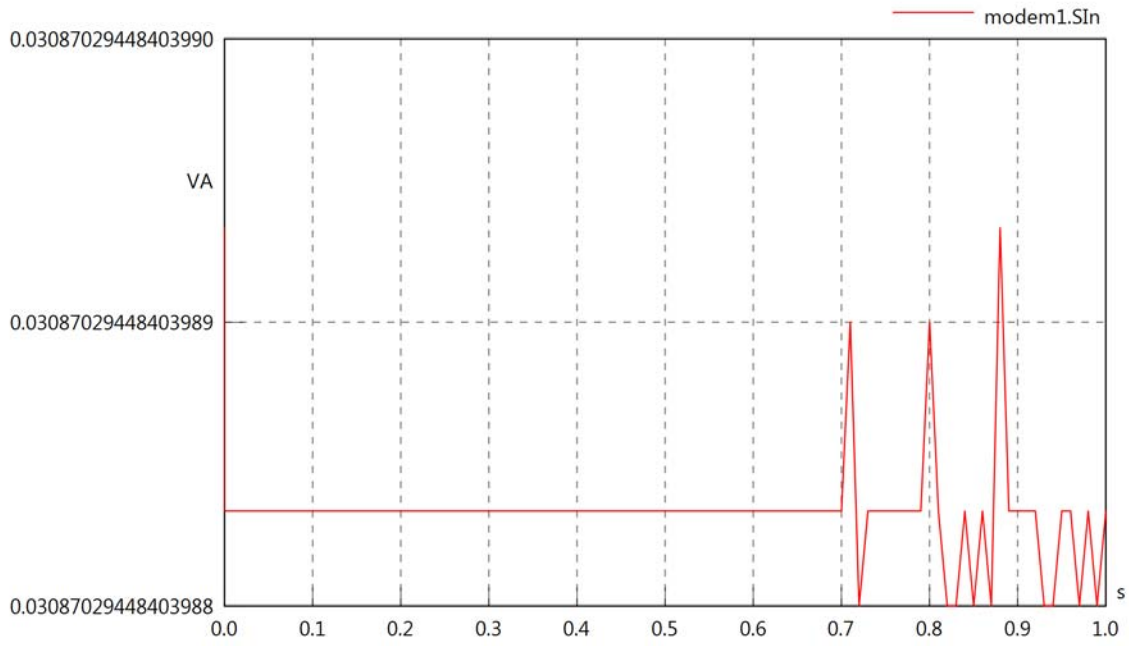
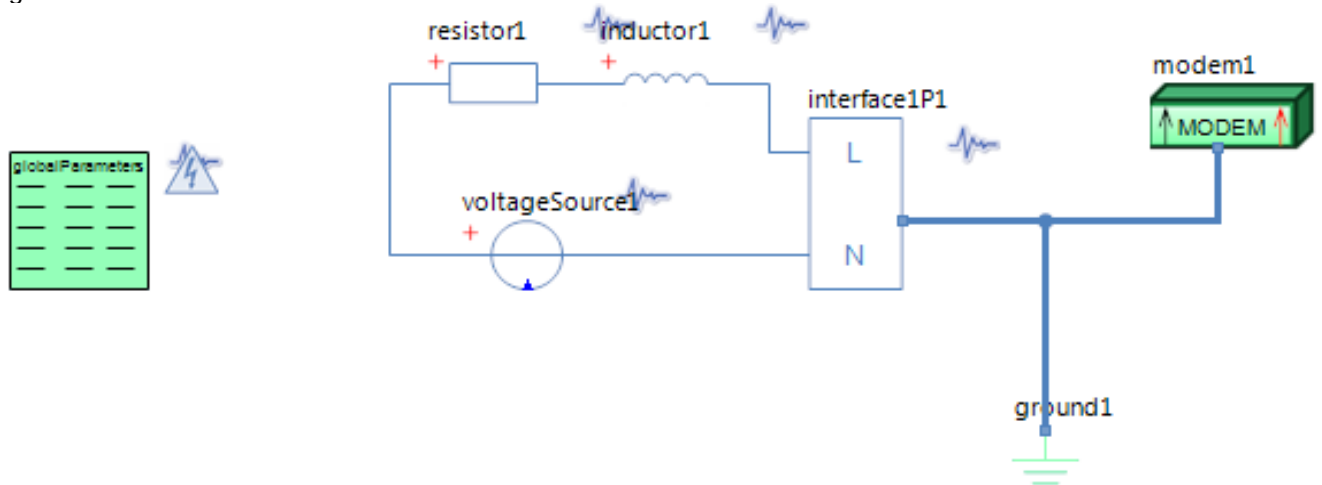

Diagram View



GlobalParameters globalParameters
Parameters

Comment	Name	Current Value	Unit
Type of Calculation	eCalculationKind	Signal Calculation	
Description of Frequency	eFrequencyKind	Linear	
Minimum Frequency	fMin	100	[kHz]
Maximum Frequency	fMax	100	[kHz]

Modem modem1
Parameters

Comment	Name	Current Value	Unit
Modem is sending or receiving	kind	Modem is receiving	
Input Resistance	Rin	1900	[Ohm]

Resistor resistor1
Parameters

Comment	Name	Current Value	Unit
Resistance	R	500	[Ohm]

Inductor inductor1
Parameters

Comment	Name	Current Value	Unit
Inductance	L	5	[mH]

Voltage Source voltageSource1
Parameters

Comment	Name	Current Value	Unit
Voltage RMS	VrmsSrc	10	[V]
Phase	phi	0	[deg]

modem1.VrmsIn

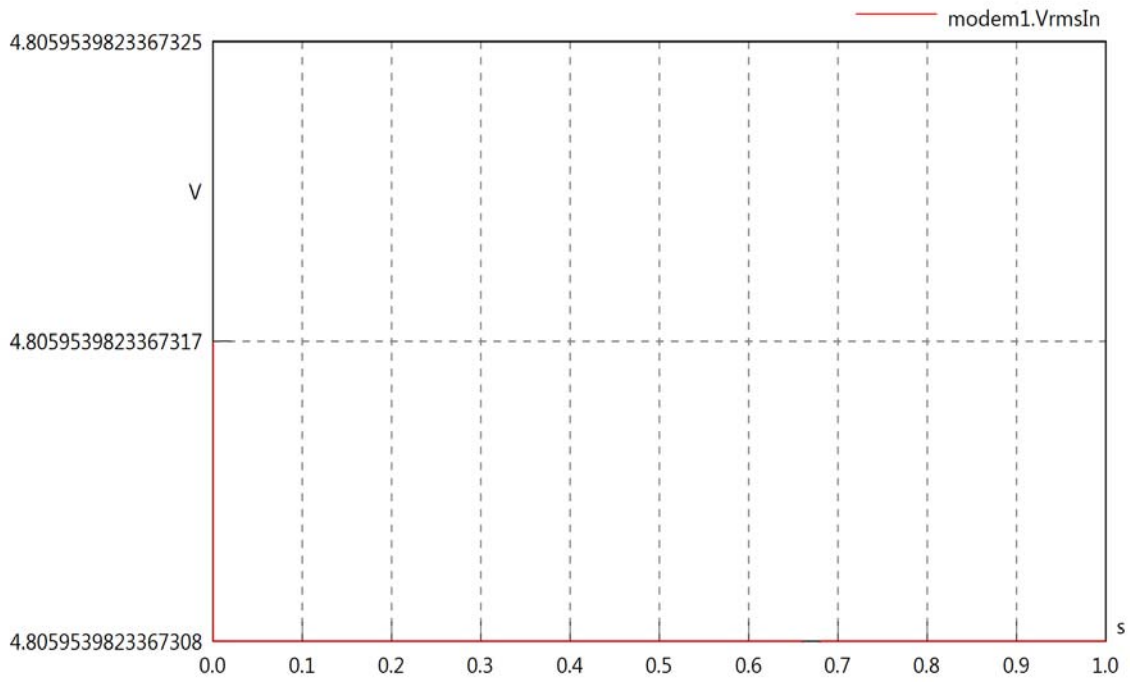

modem1.vReIn

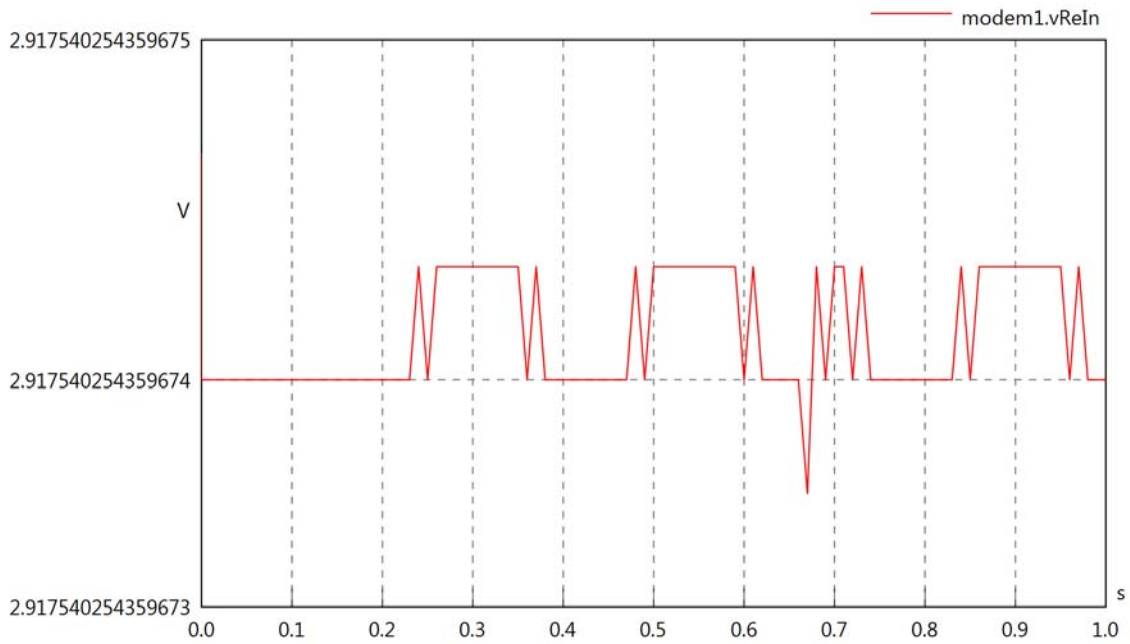

modem1.vImIn

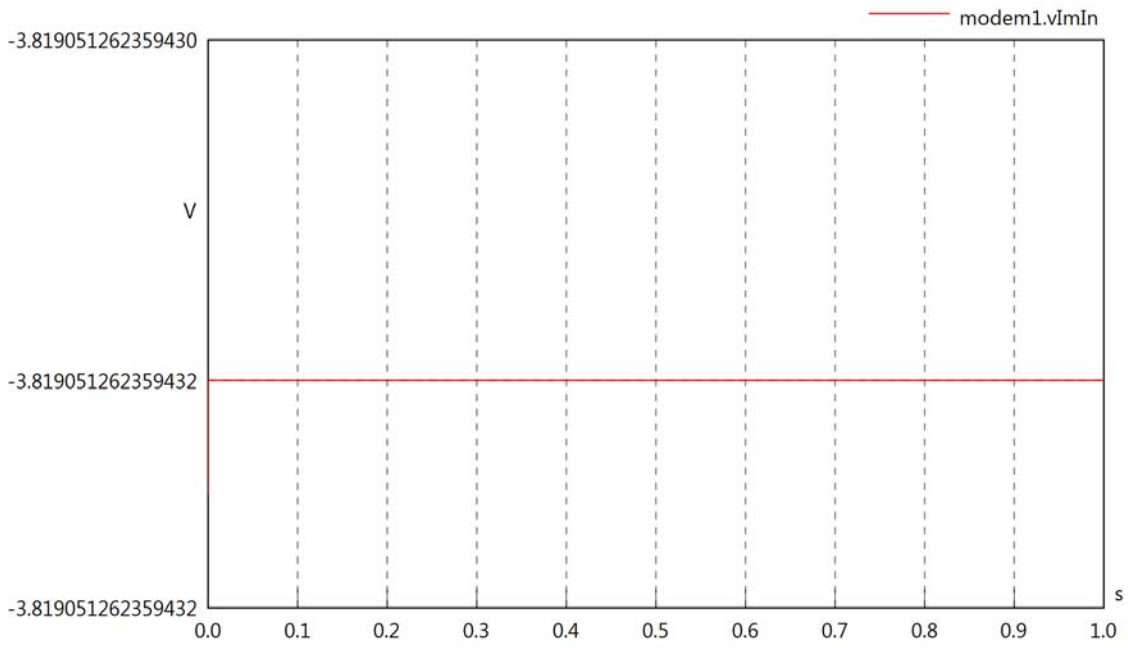

modem1.IrmsIn

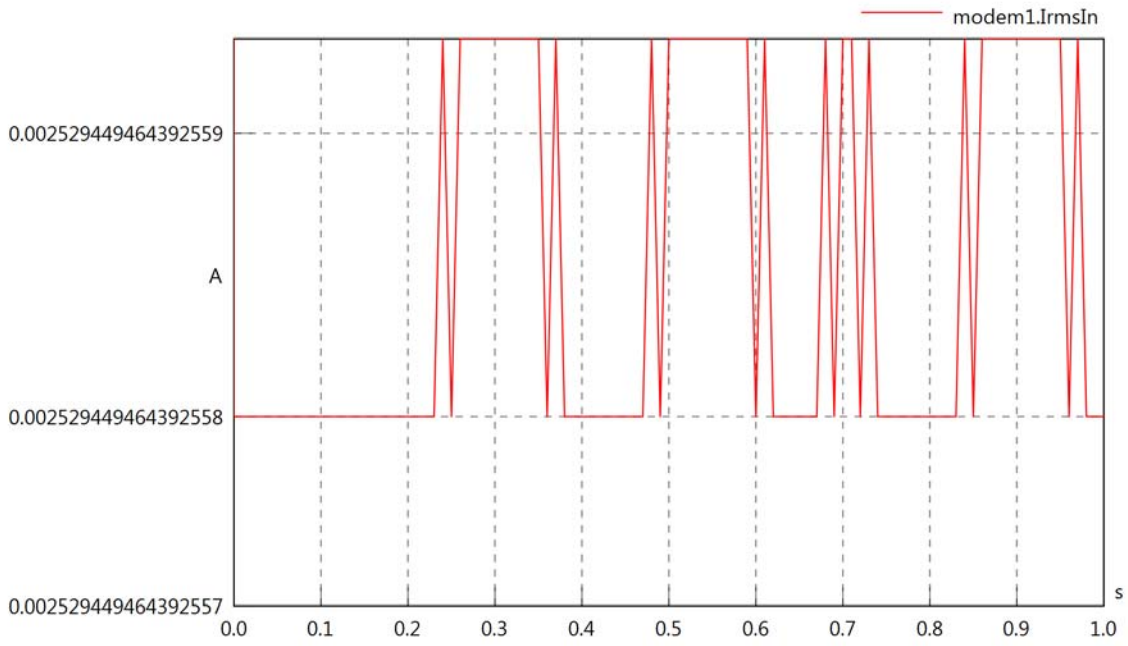

modem1.iReIn

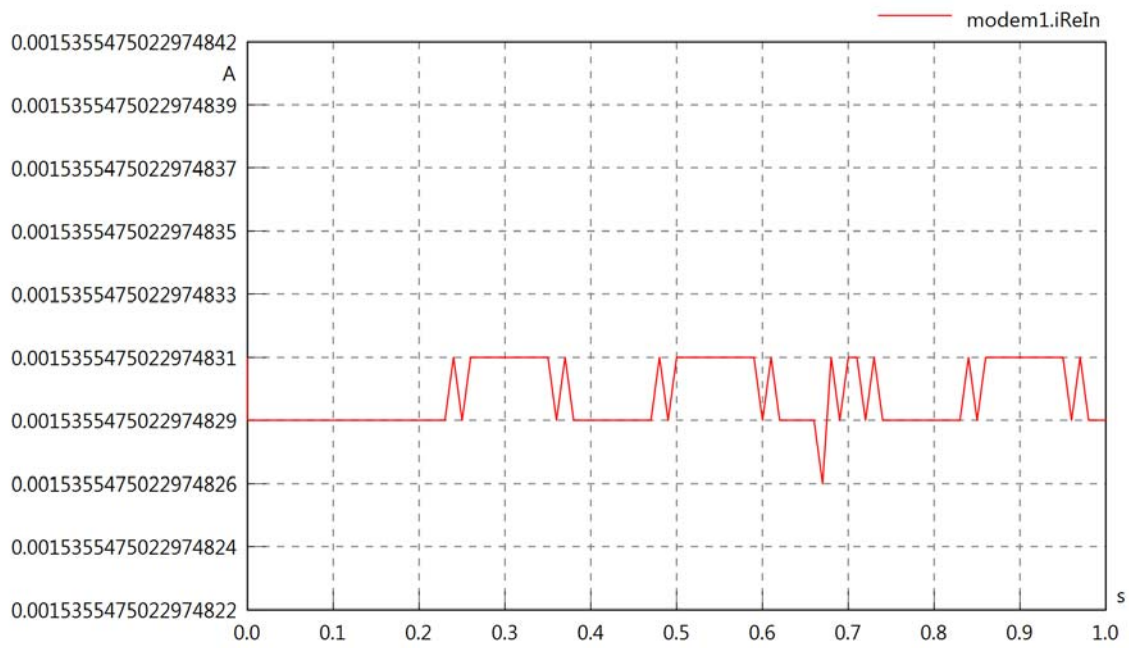

modem1.iImIn

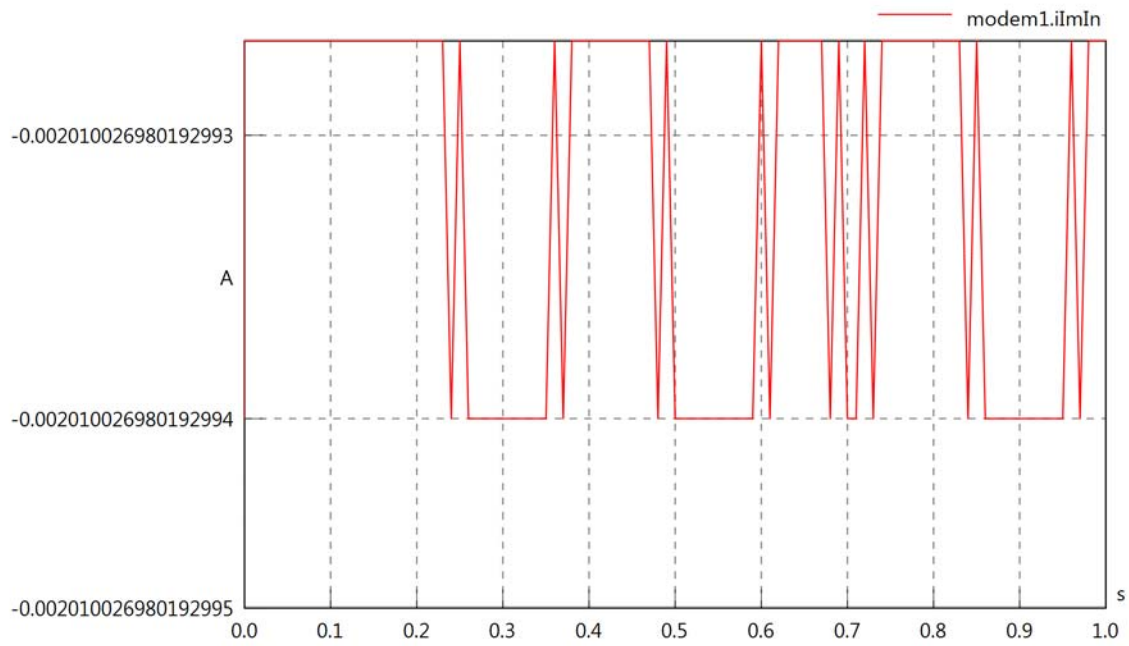

modem1.phiVIn

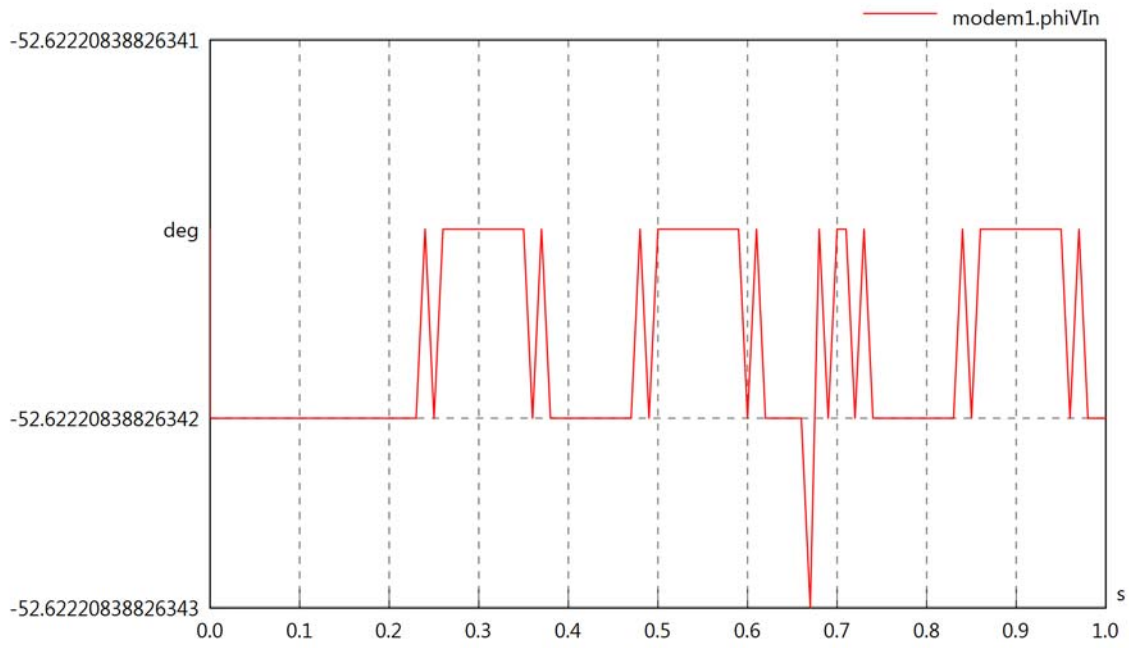

modem1.phiIIn

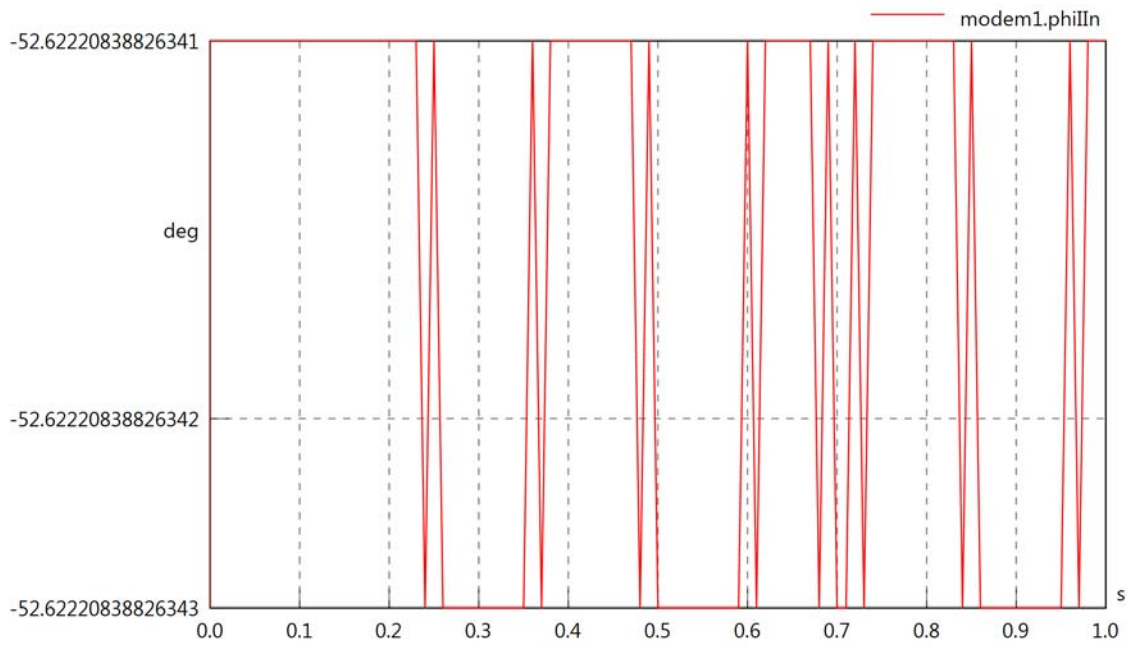

modem1.phiIVIn

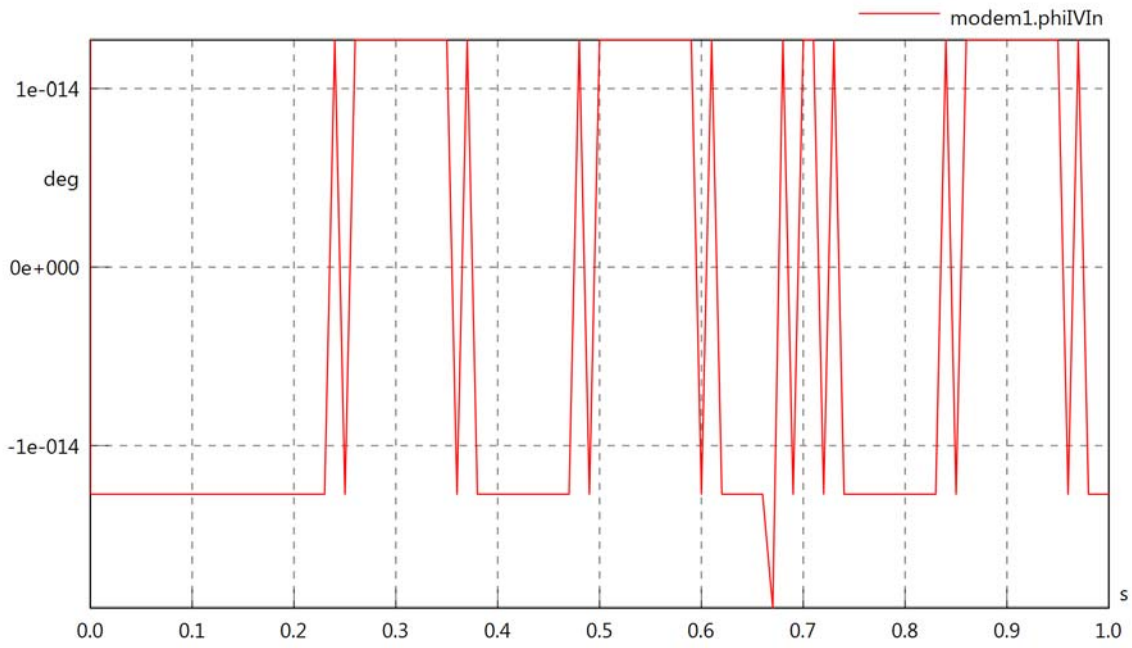

modem1.PReIn

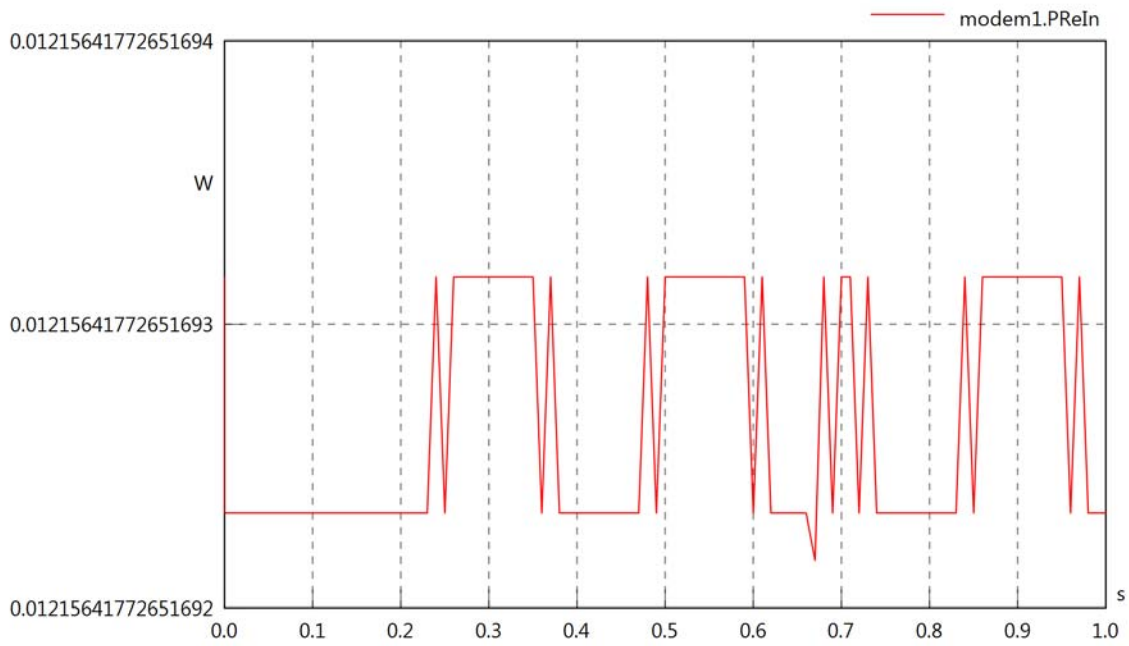

modem1.PImIn

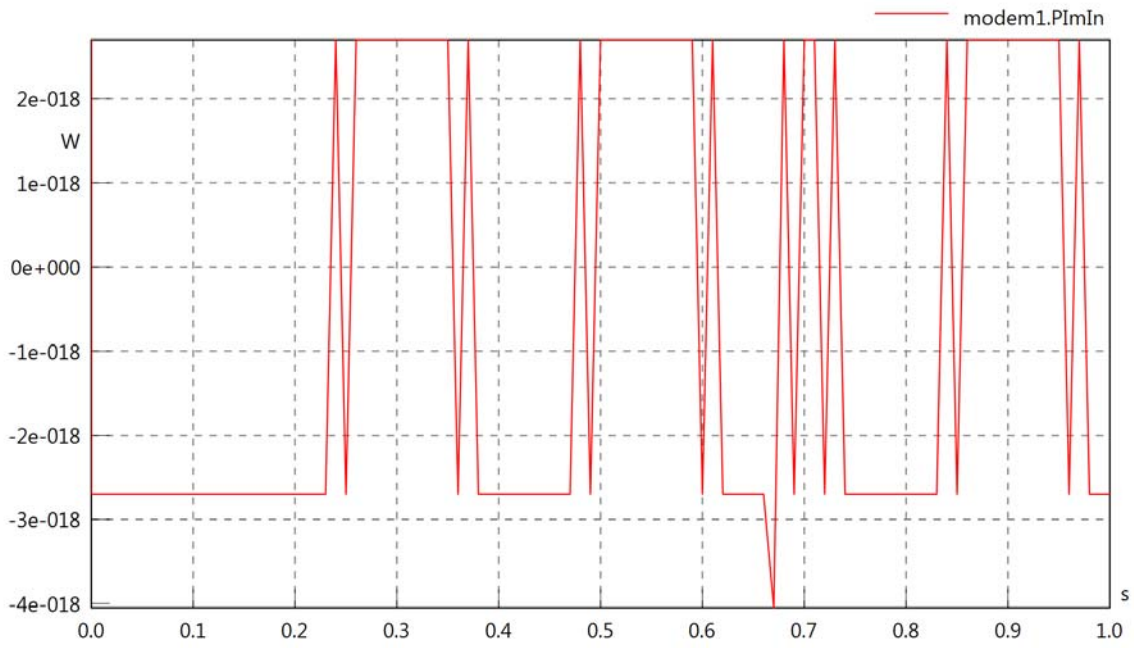

modem1.SIn

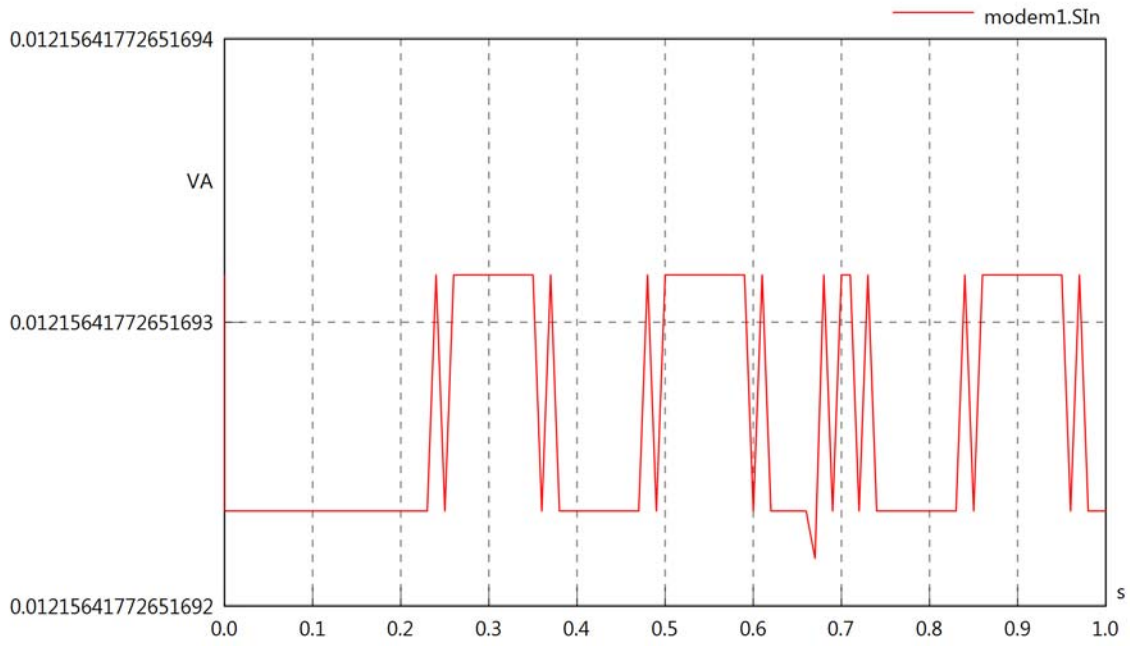
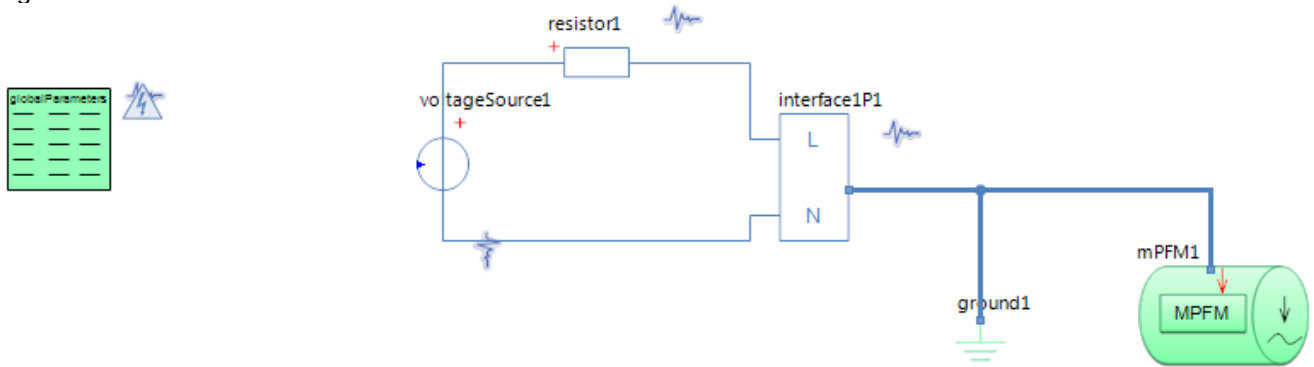

Diagram View



GlobalParameters globalParameters
Parameters

Comment	Name	Current Value	Unit
Type of Calculation	eCalculationKind	Signal Calculation	
Description of Frequency	eFrequencyKind	Linear	
Minimum Frequency	fMin	60	[Hz]
Maximum Frequency	fMax	60	[Hz]

Multiphase Flow Meter mPFM1
Parameters

Comment	Name	Current Value	Unit
EPU or Modem sending on system	sType	EPU sending	
Simulate with internal Transformer	trafoOn	false	
Constant or Variable Power	pType	Constant Power	
Output Power from PSU in MPFM	P	100	[VA]
PSU Power Factor	pf	0.7	[-]
PSU turn-off RMS Voltage	vMin	130	[V]
PSU turn-on RMS Voltage	vMax	180	[V]

Resistor resistor1
Parameters

Comment	Name	Current Value	Unit
Resistance	R	50	[Ohm]

Voltage Source voltageSource1
Parameters

Comment	Name	Current Value	Unit
Voltage RMS	VrmsSrc	$\min(230, 230000 * t)$	[V]
Phase	phi	0	[deg]

mPFM1.Rload

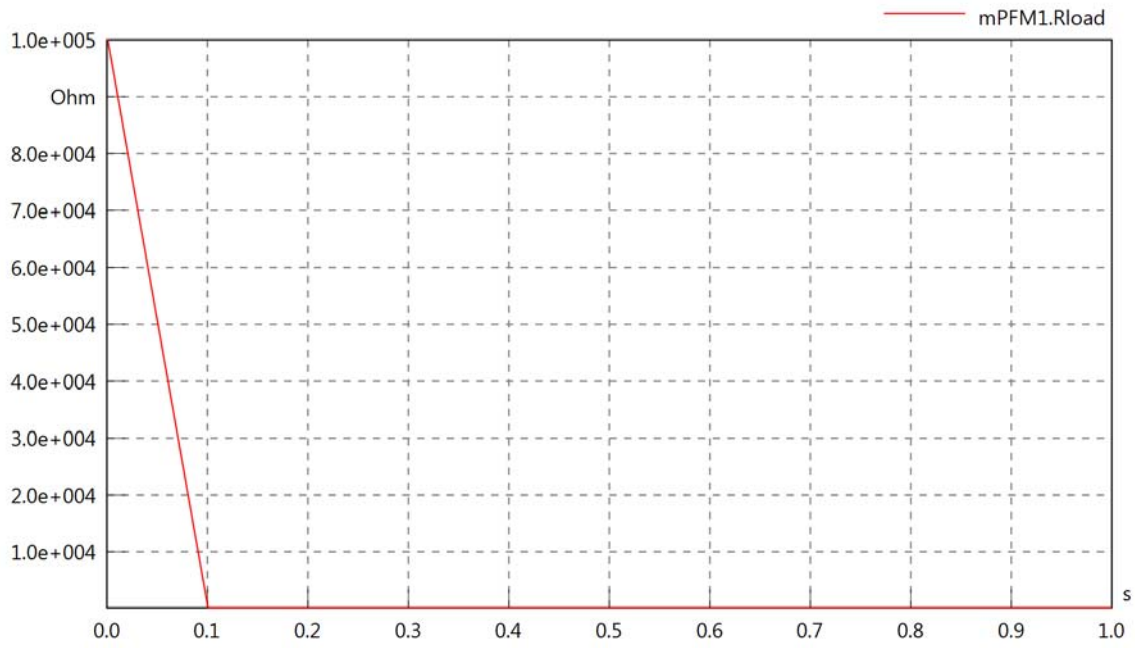

mPFM1.Cload

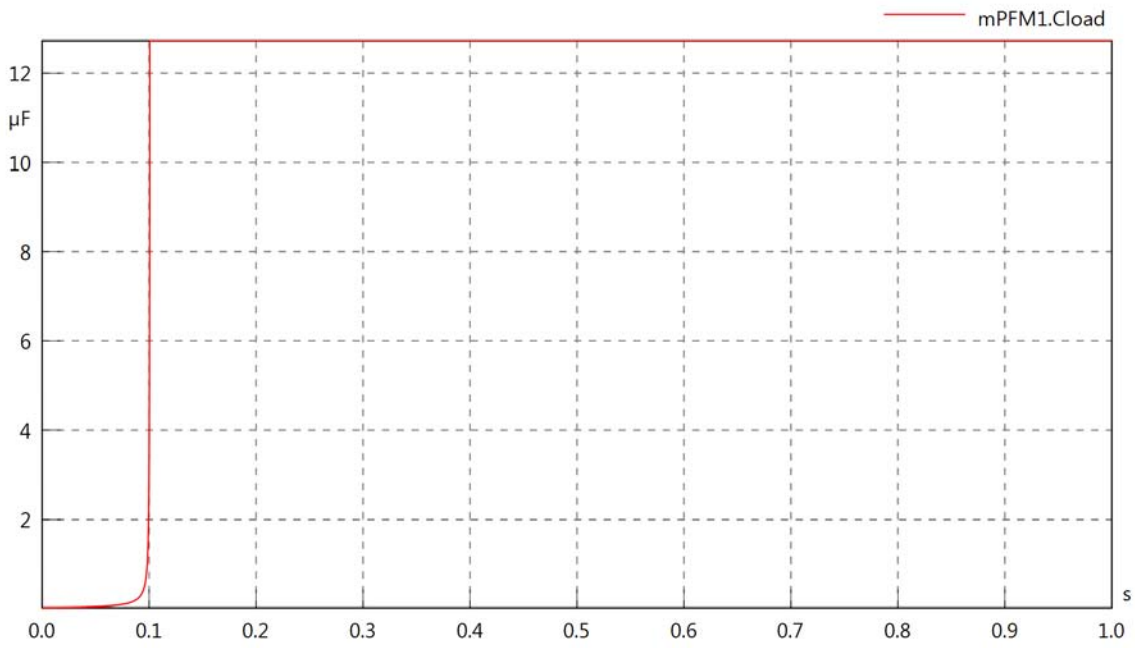

mPFM1.PsetX2

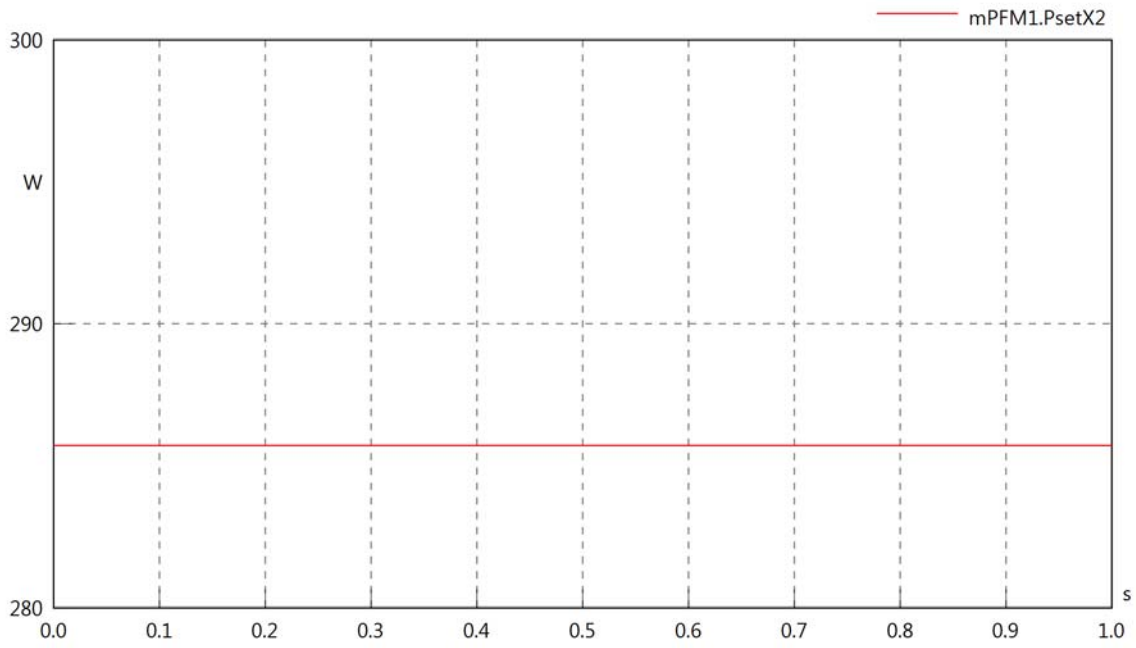

mPFM1.Pset

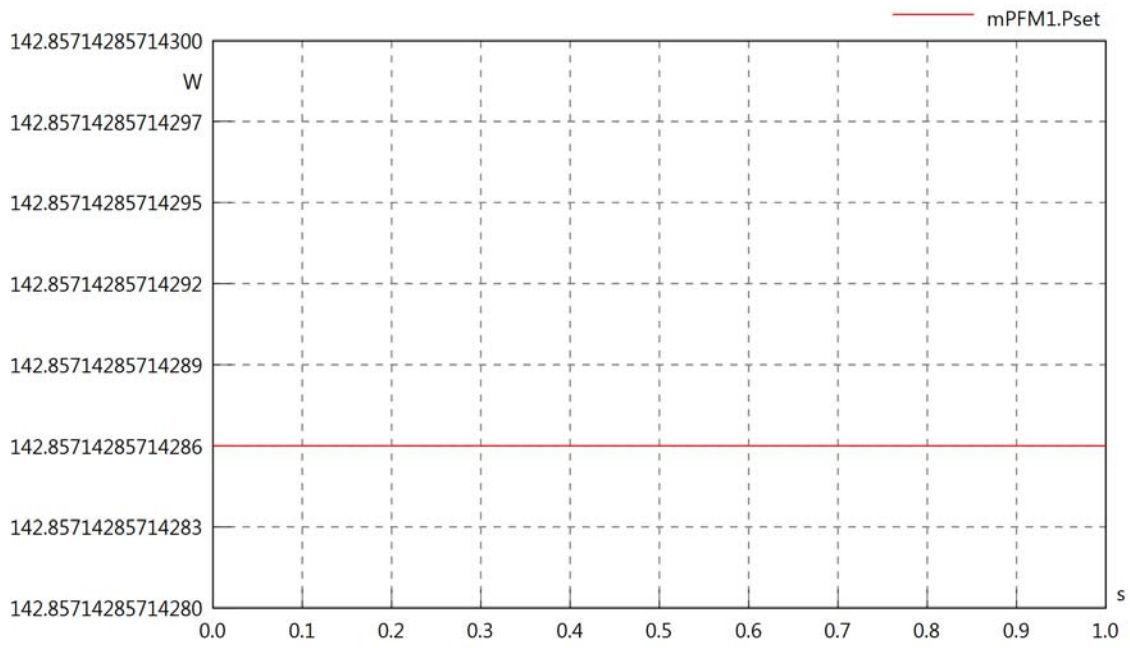

mPFM1.PCalc

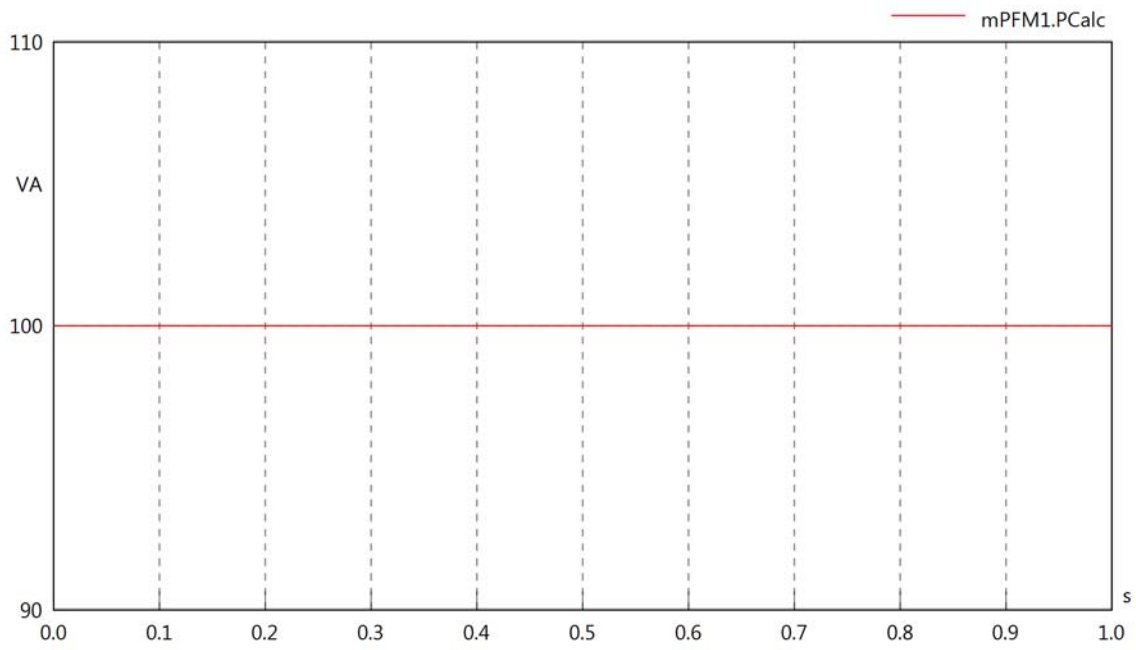

mPFM1.VrmsIn

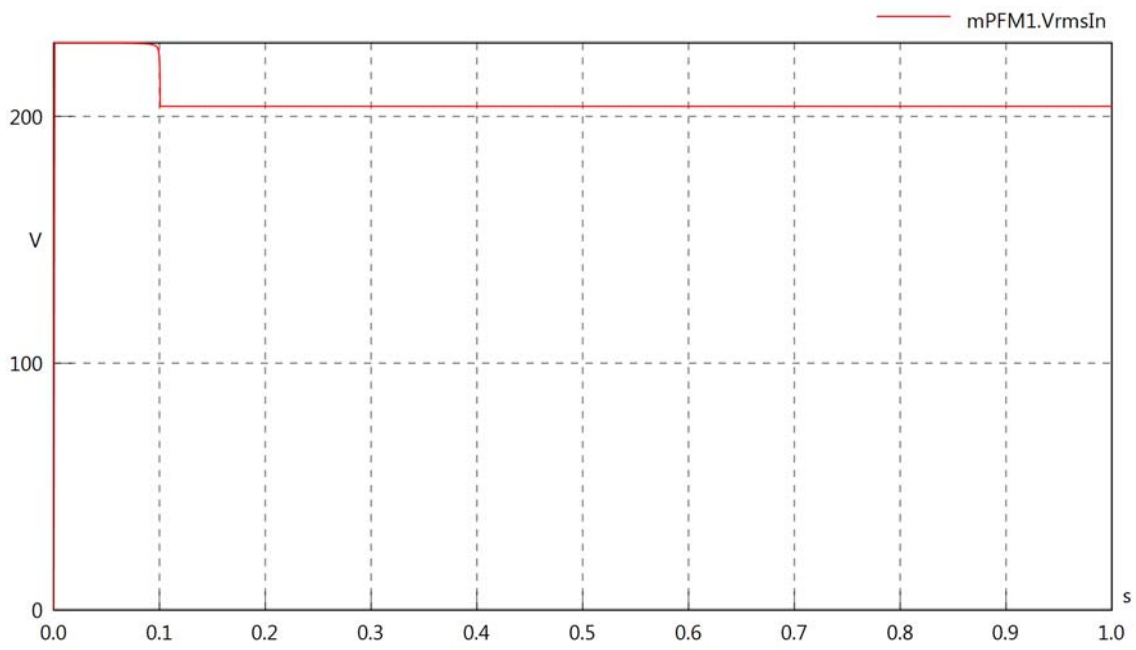

mPFM1.vReIn

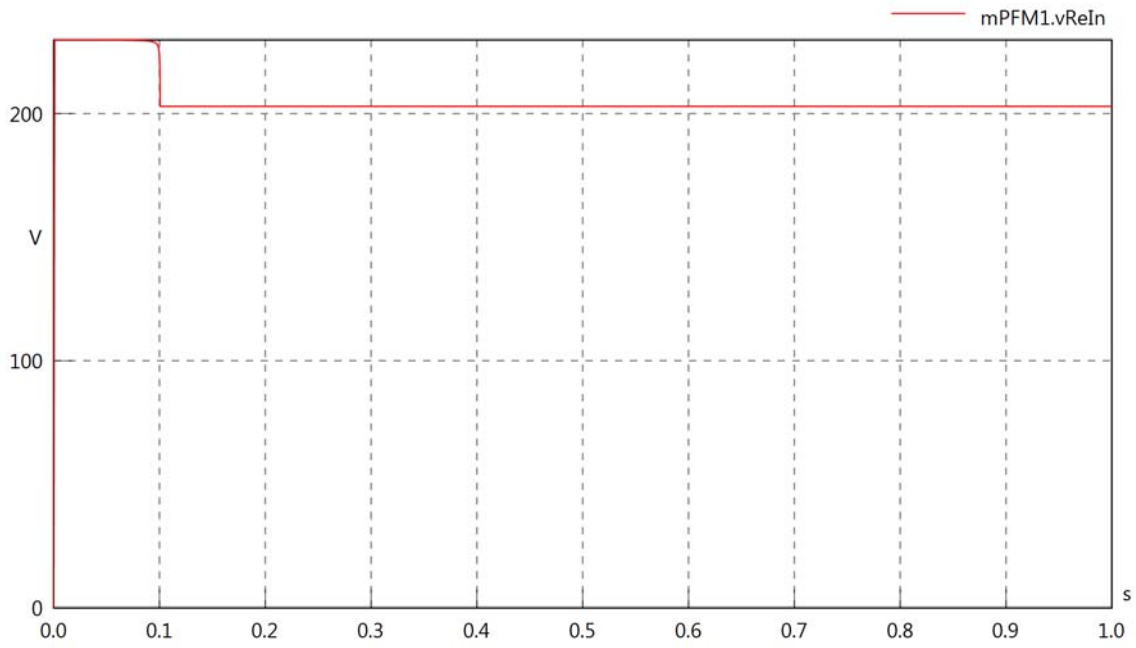

mPFM1.vImIn

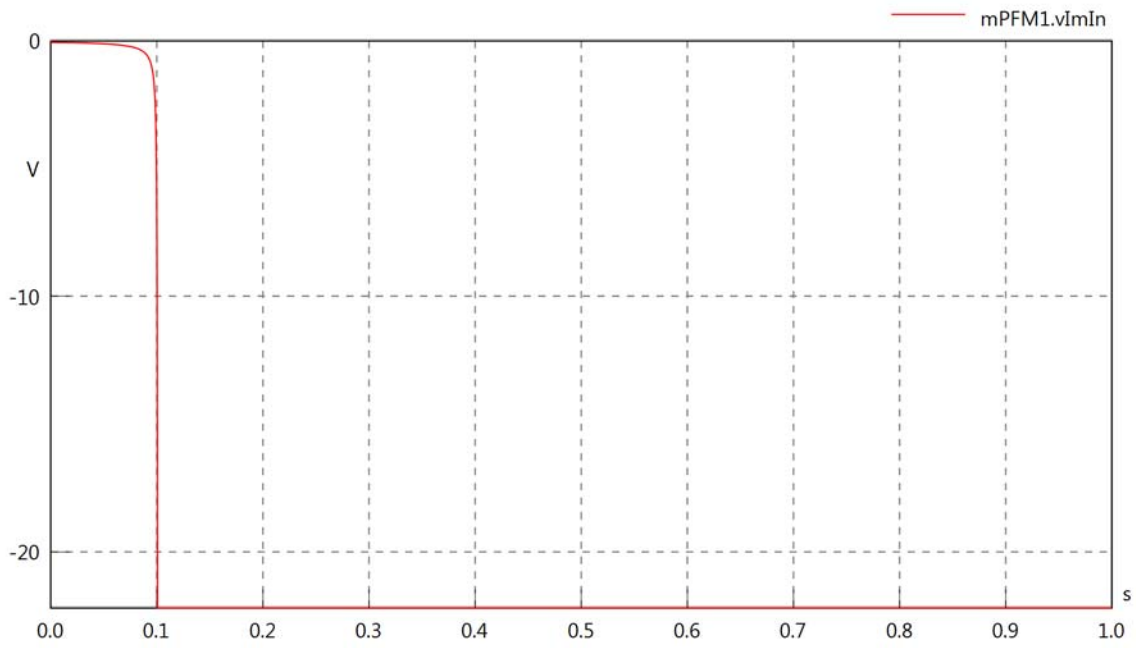

mPFM1.IrmsIn

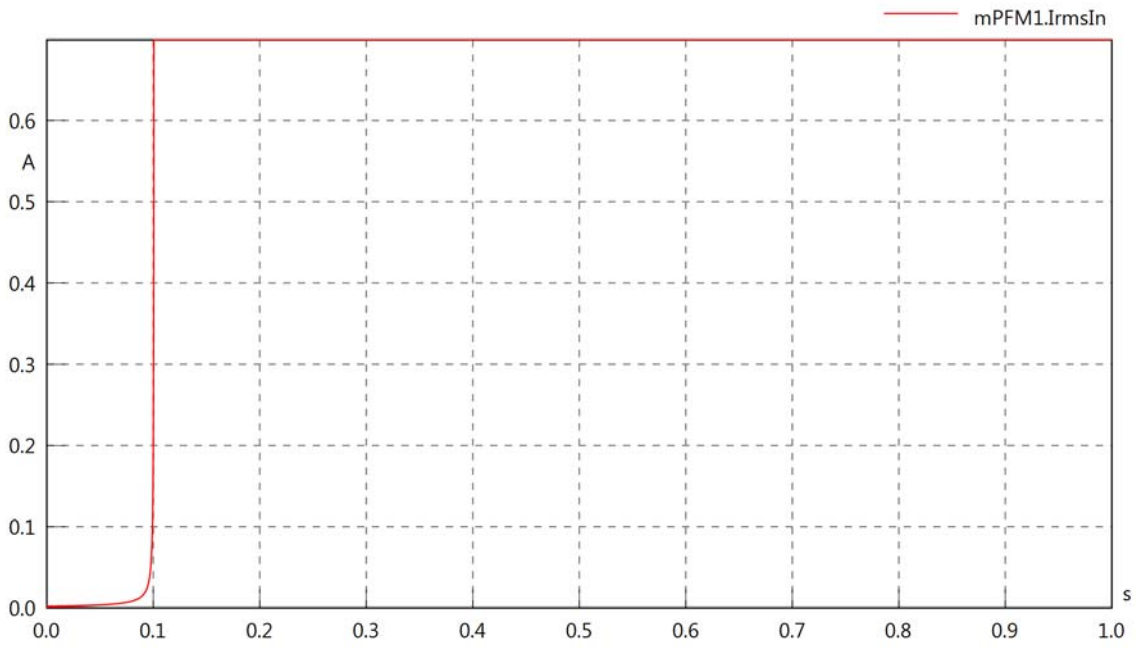

mPFM1.iReIn

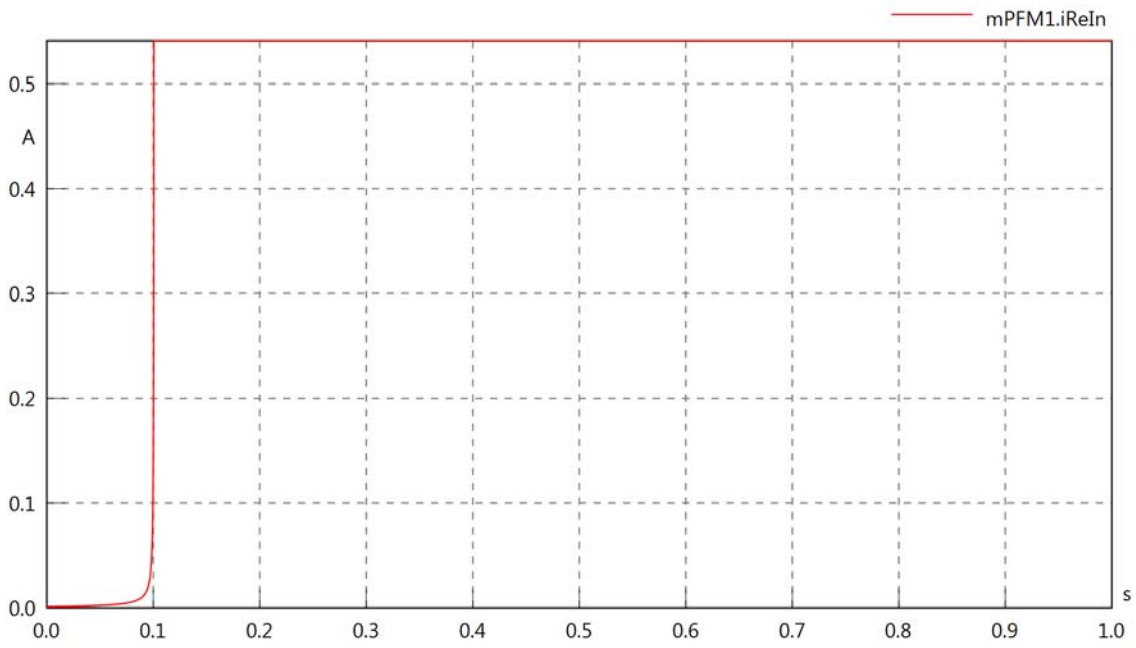

mPFM1.iImIn

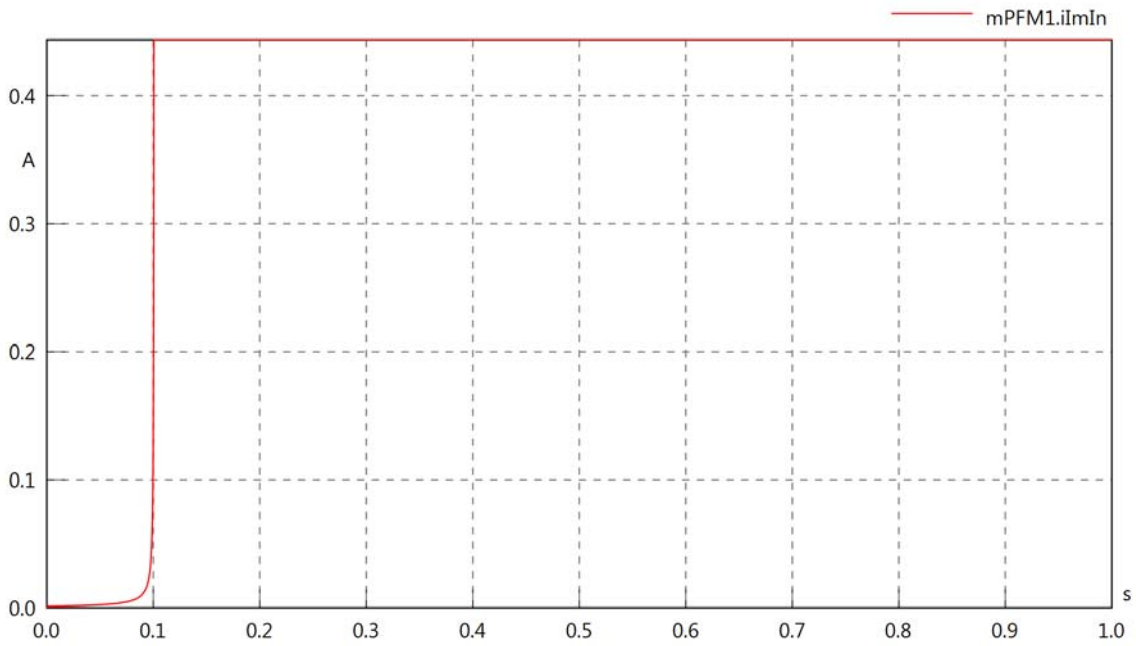

mPFM1.phiVIn

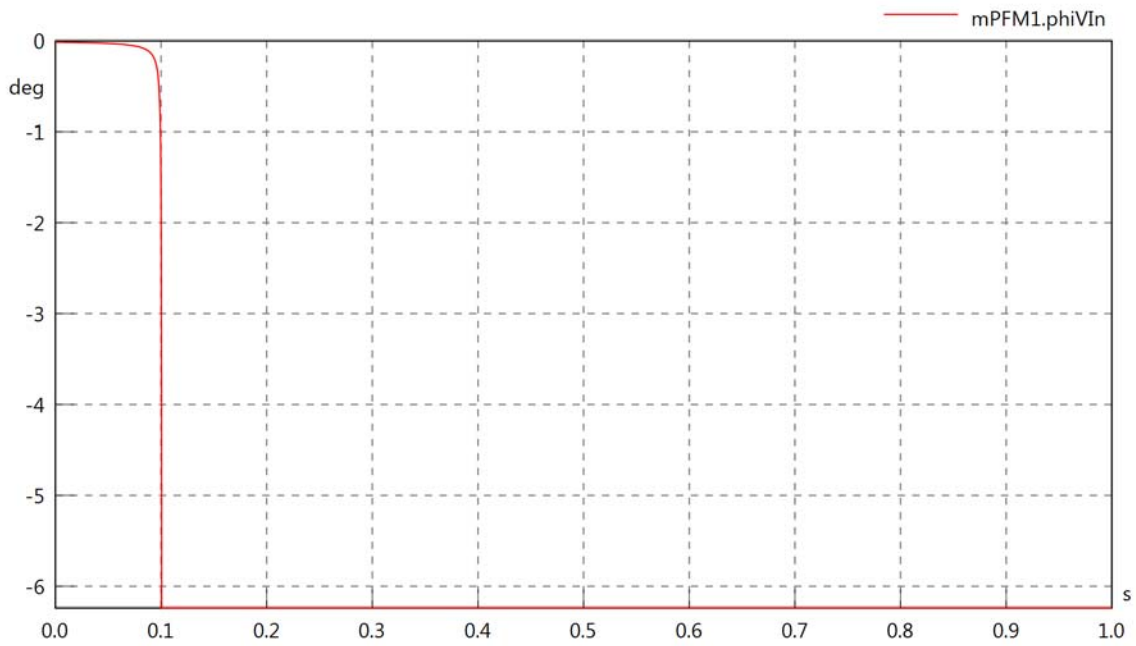

mPFM1.phiIn

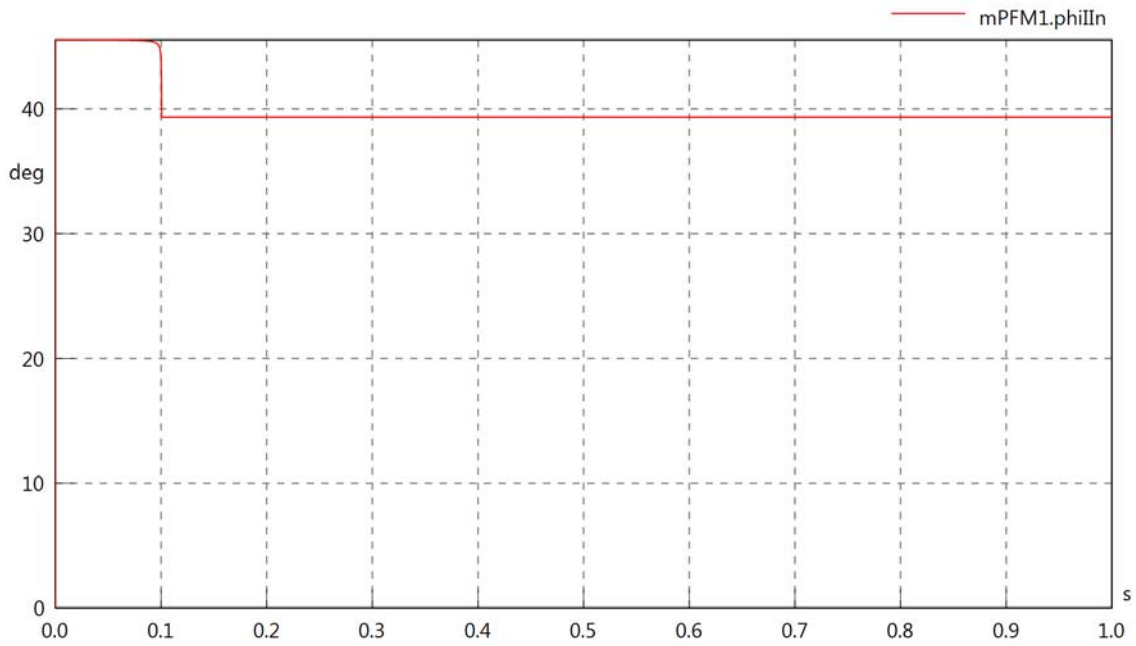

mPFM1.phiIVIn

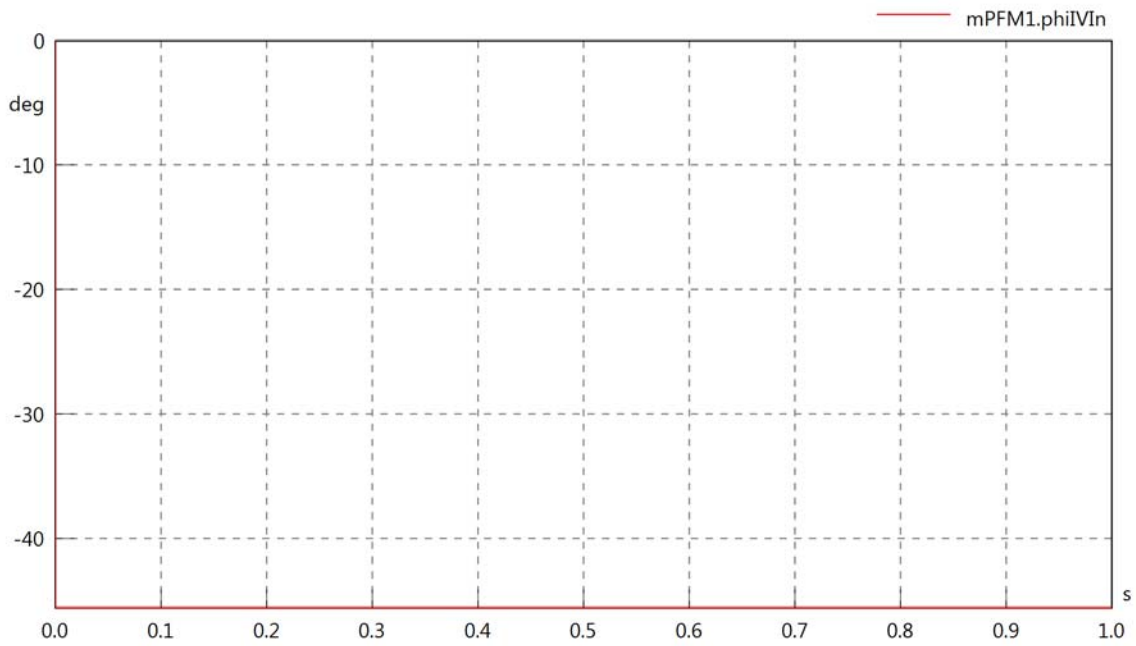

mPFM1.PReIn

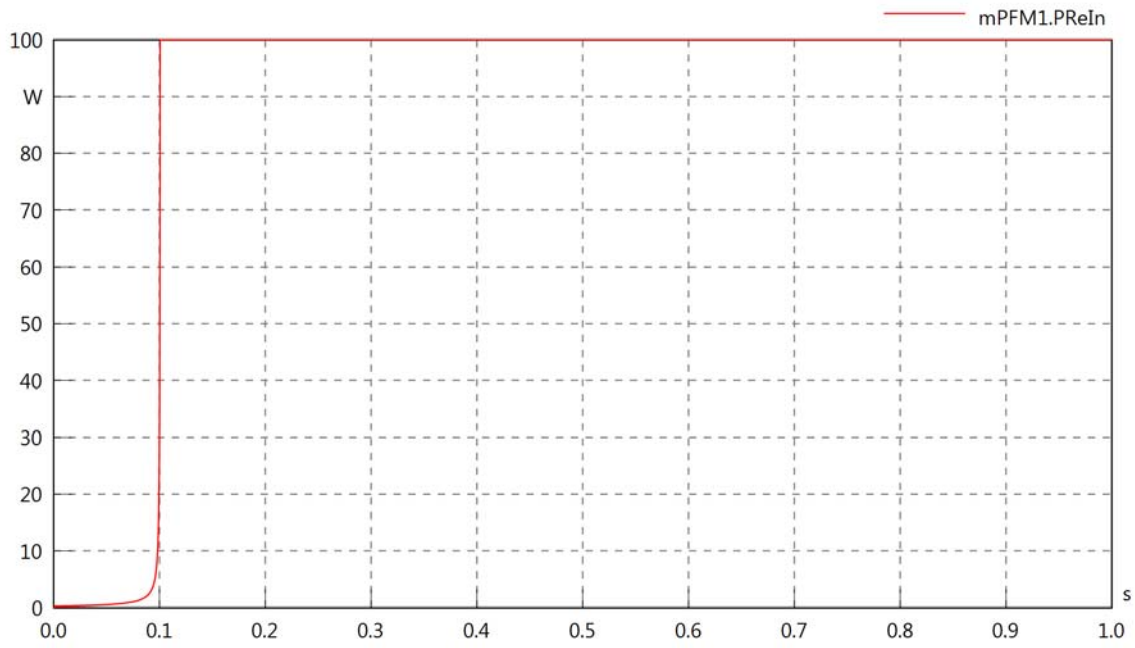

mPFM1.PImIn

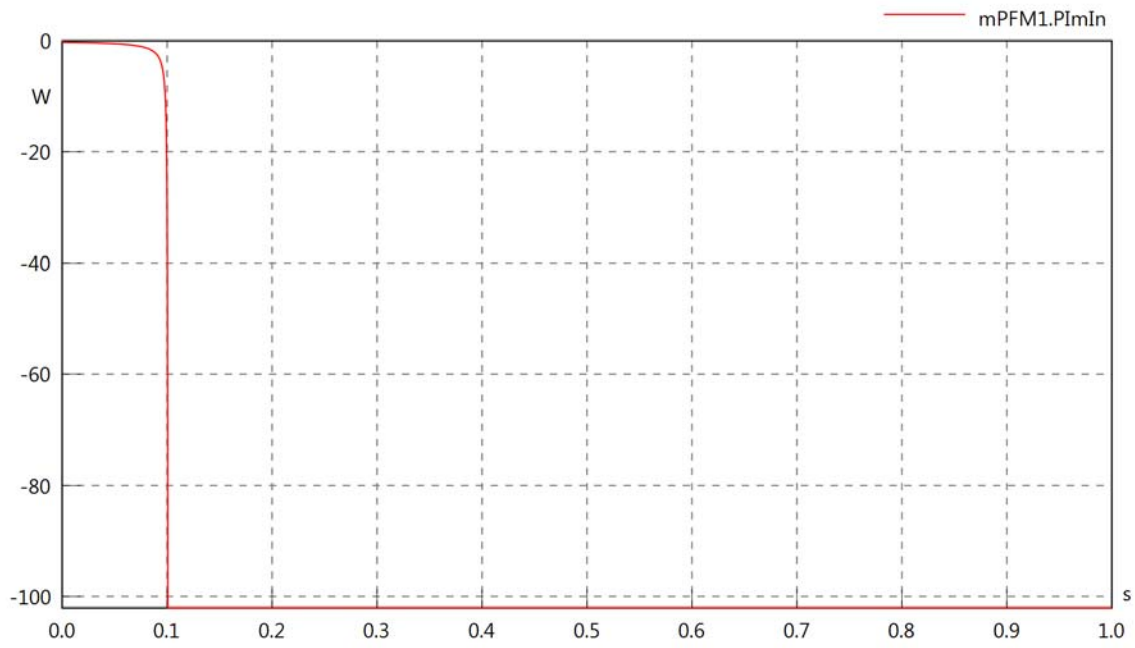

mPFM1.SIn

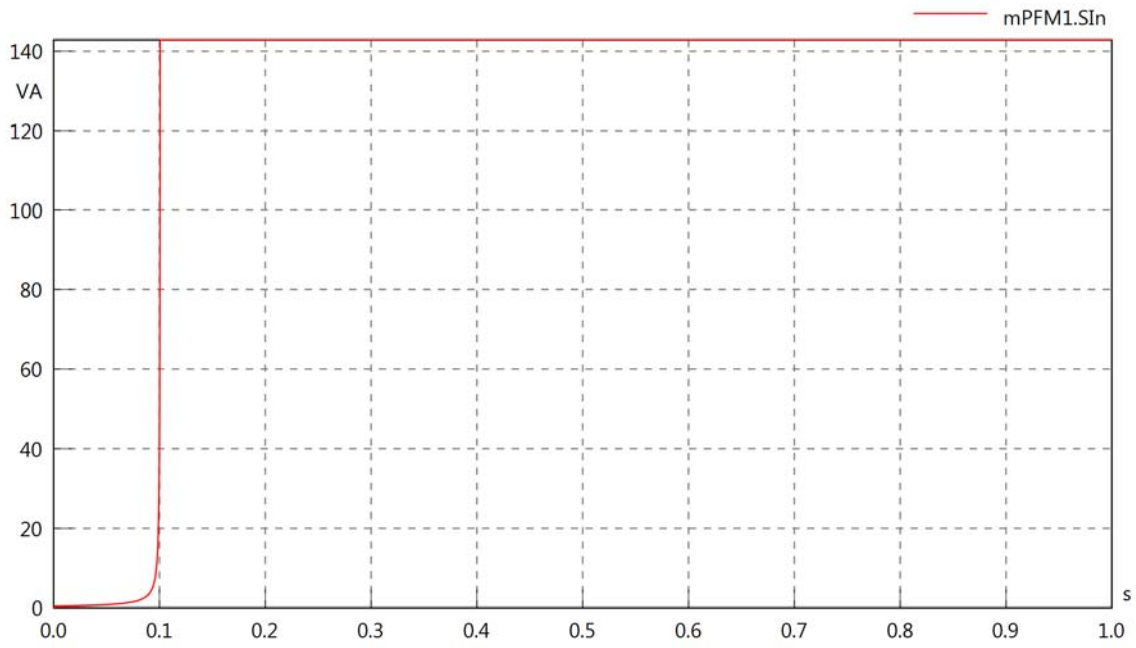

mPFM1.VrmsLoad

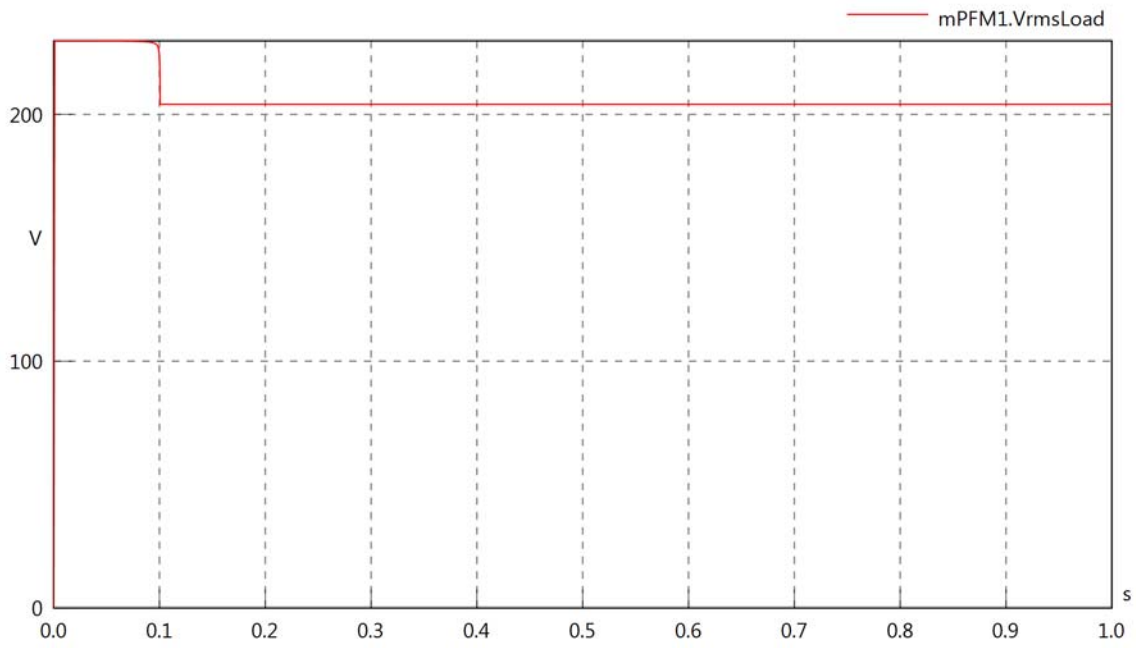

mPFM1.vReLoad

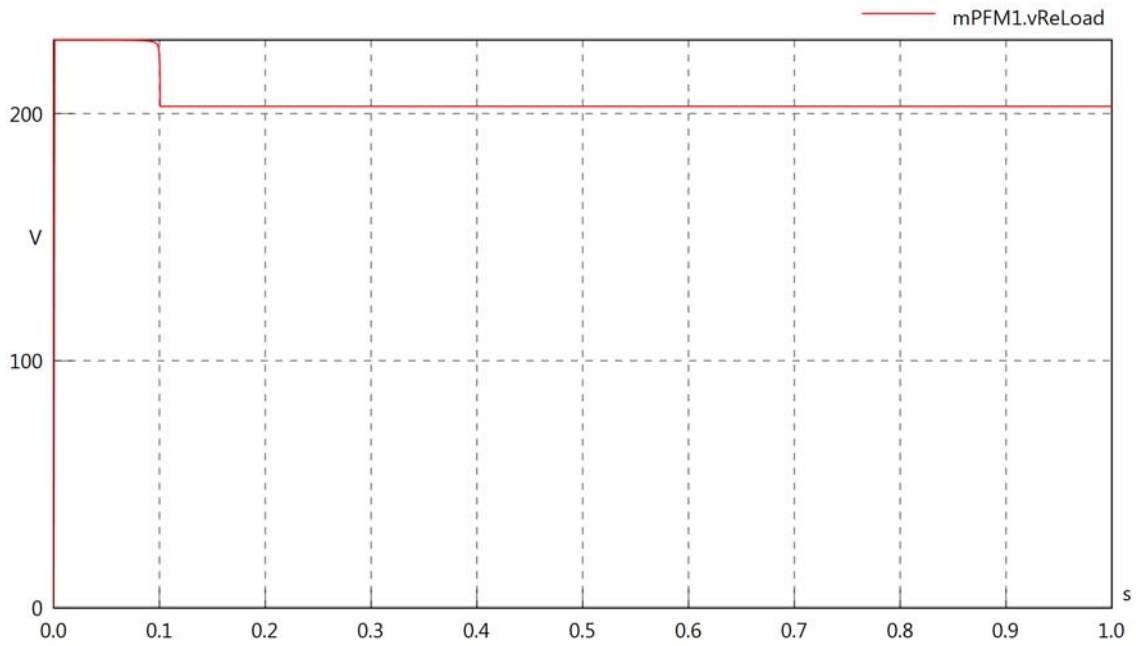

mPFM1.vImLoad

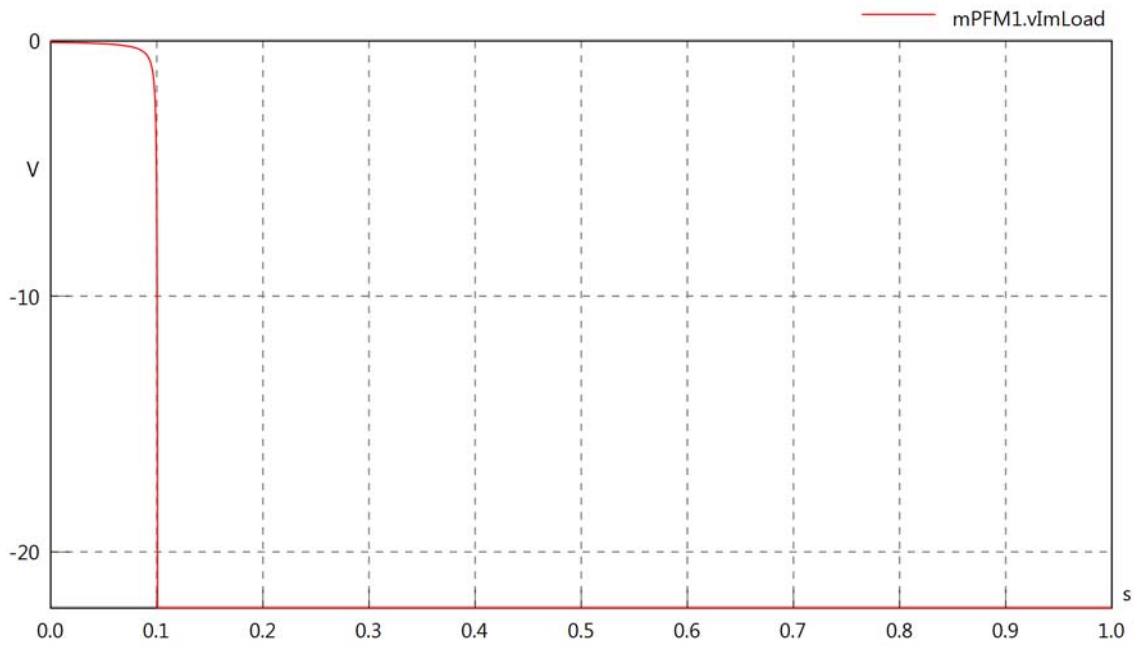

mPFM1.IrmsLoad

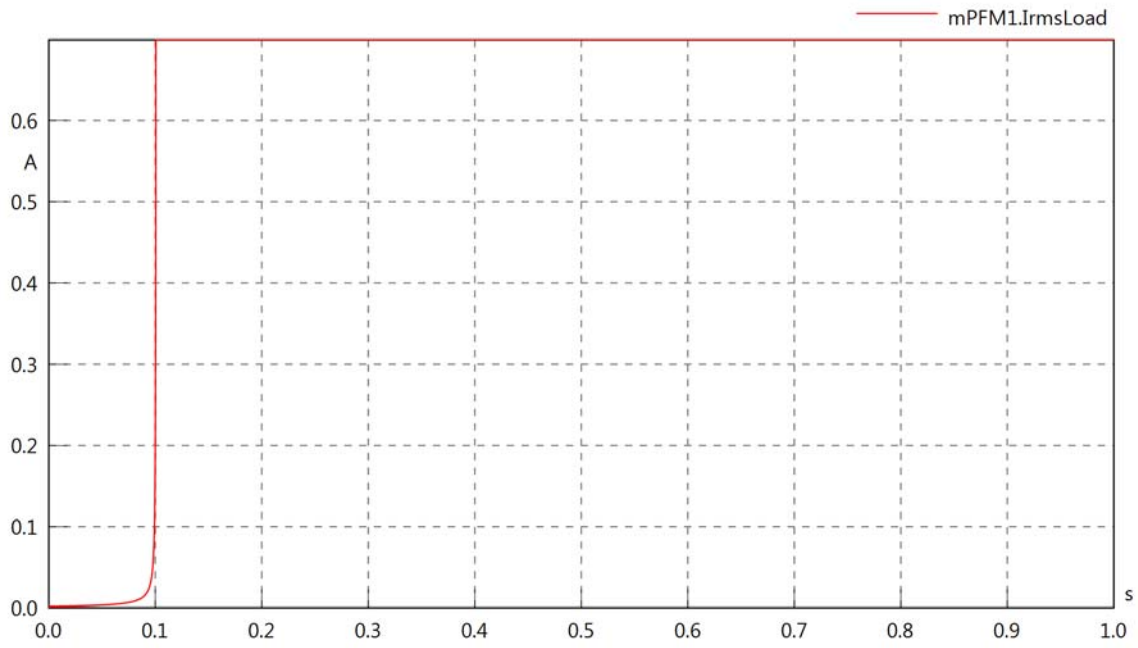

mPFM1.iReLoad

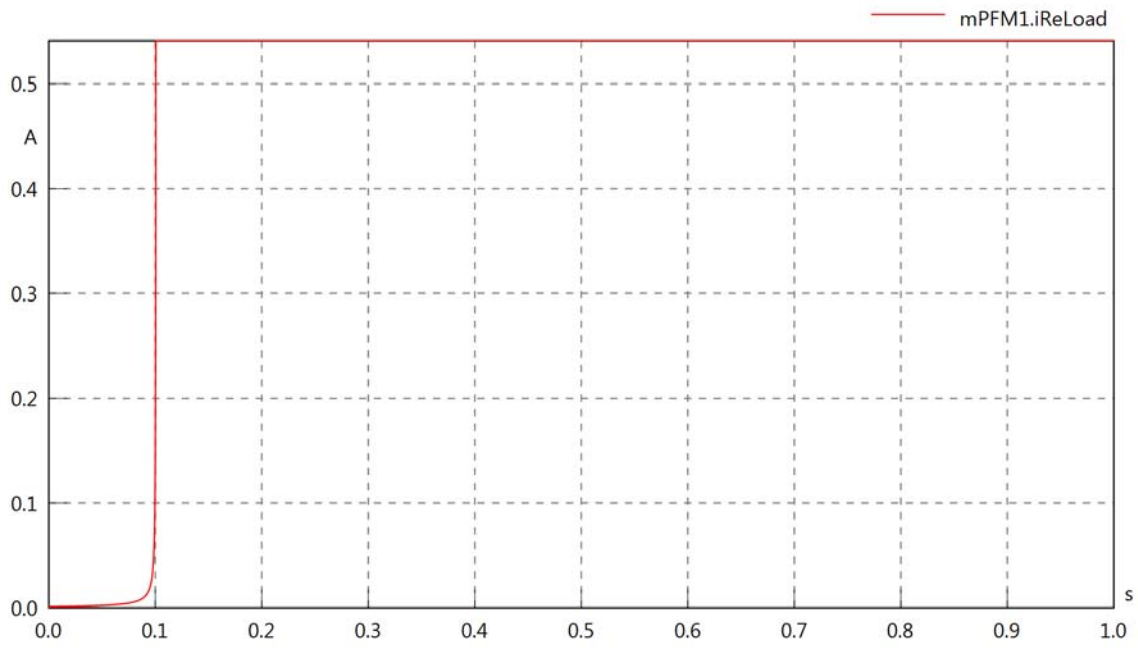

mPFM1.iImLoad

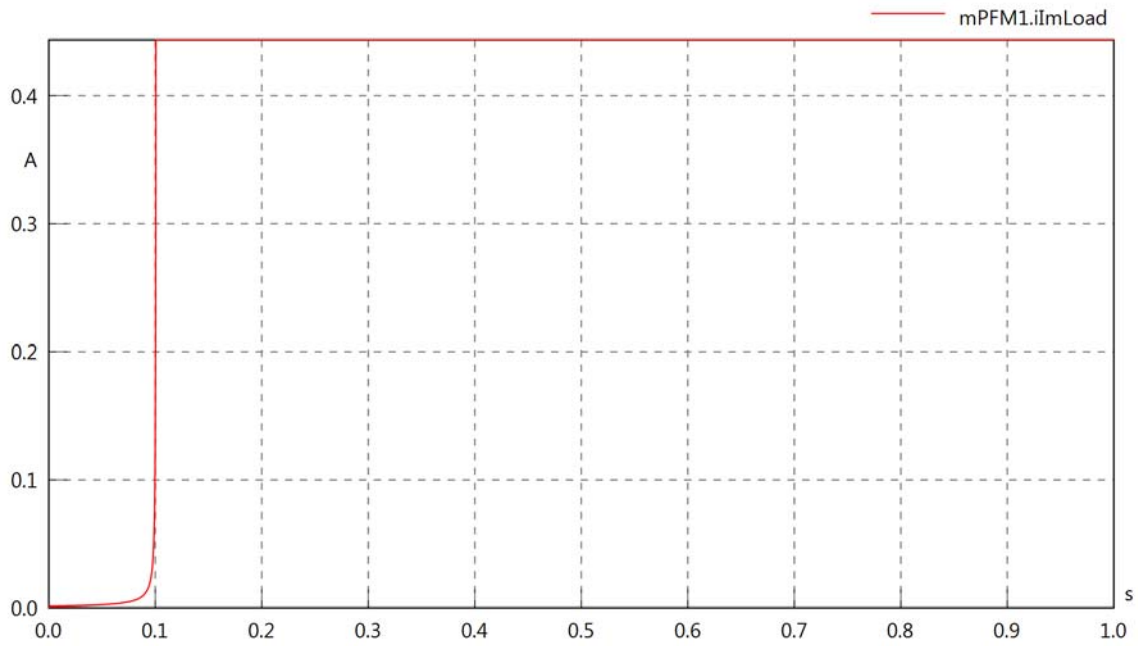

mPFM1.phiVLoad

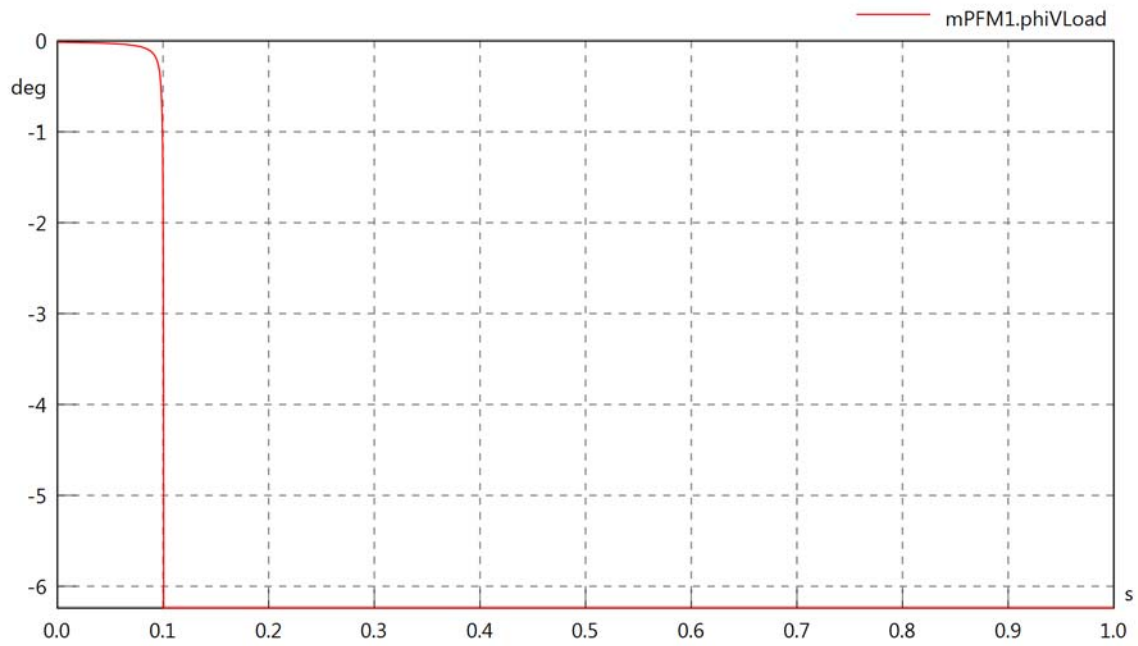

mPFM1.phiILoad

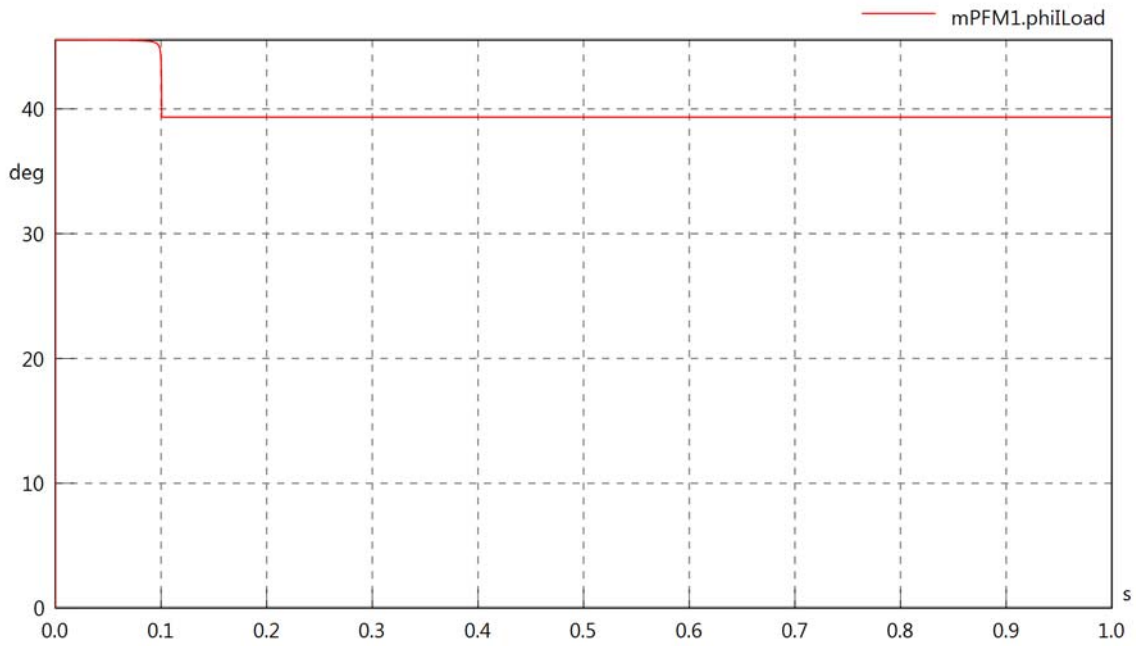

mPFM1.phiIVLoad

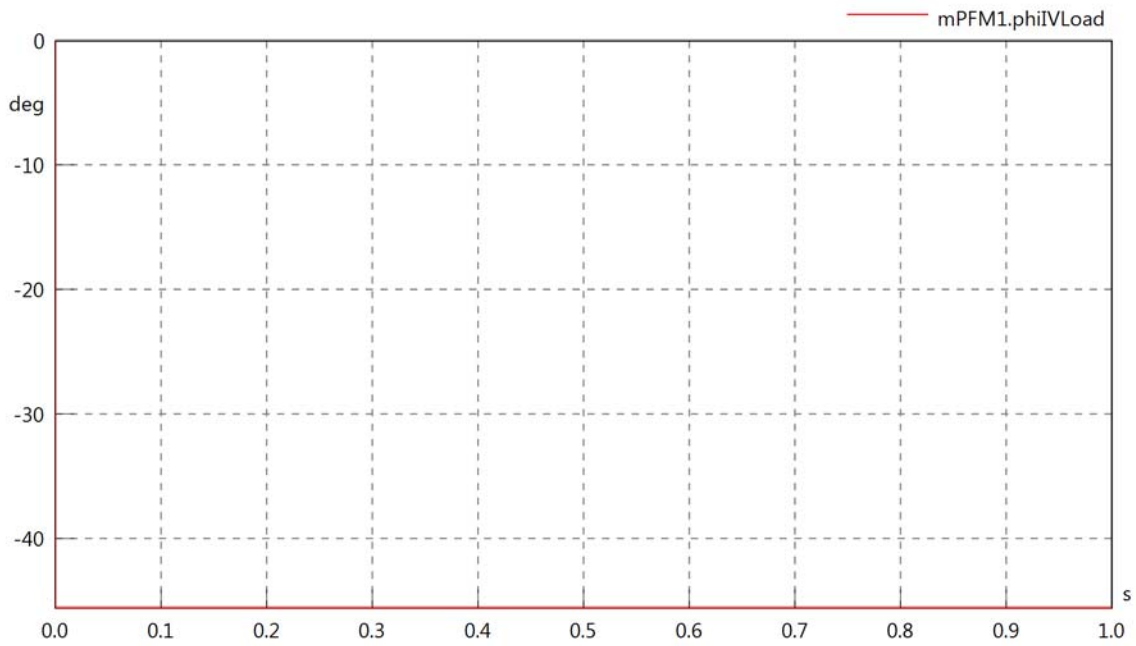

mPFM1.PReLoad

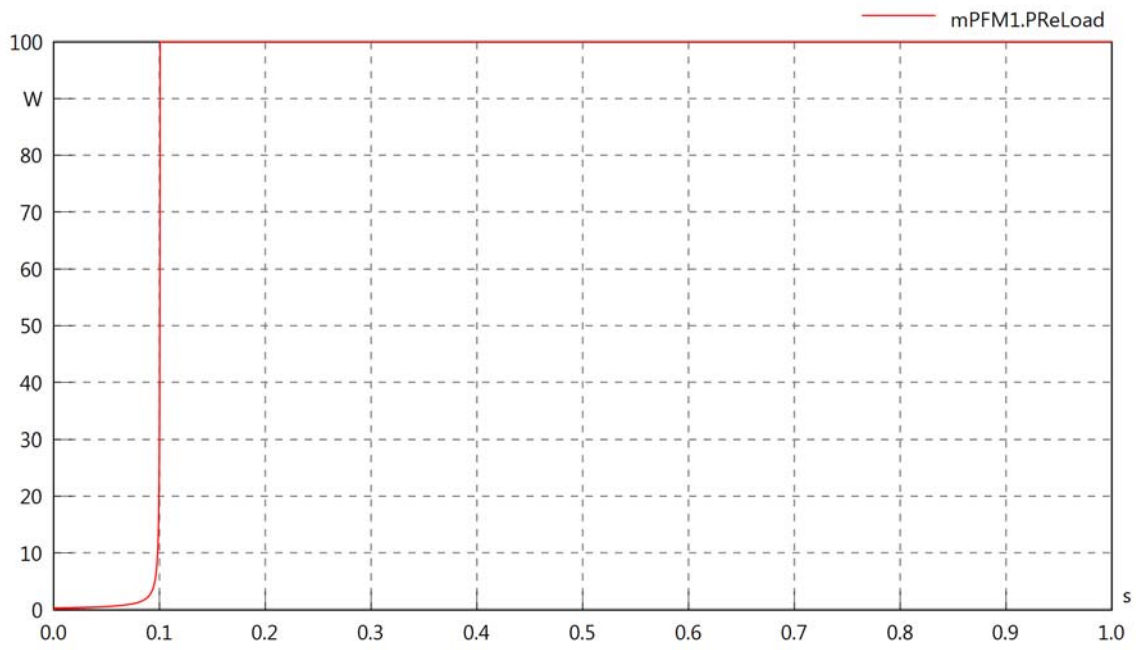

mPFM1.PImLoad

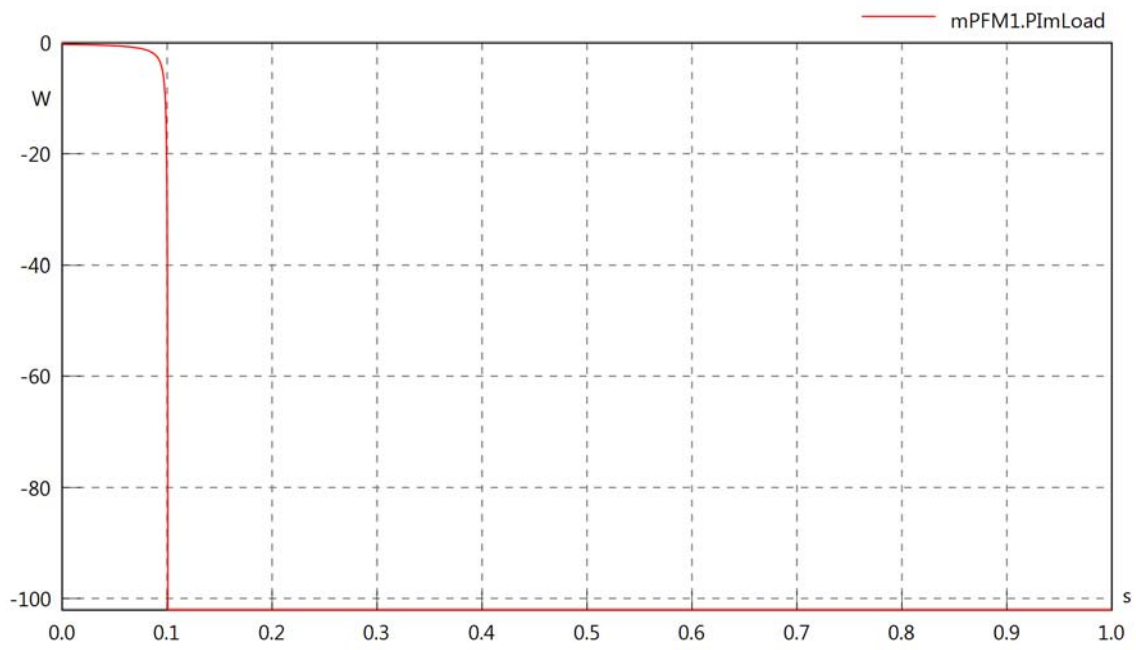

mPFM1.SLoad

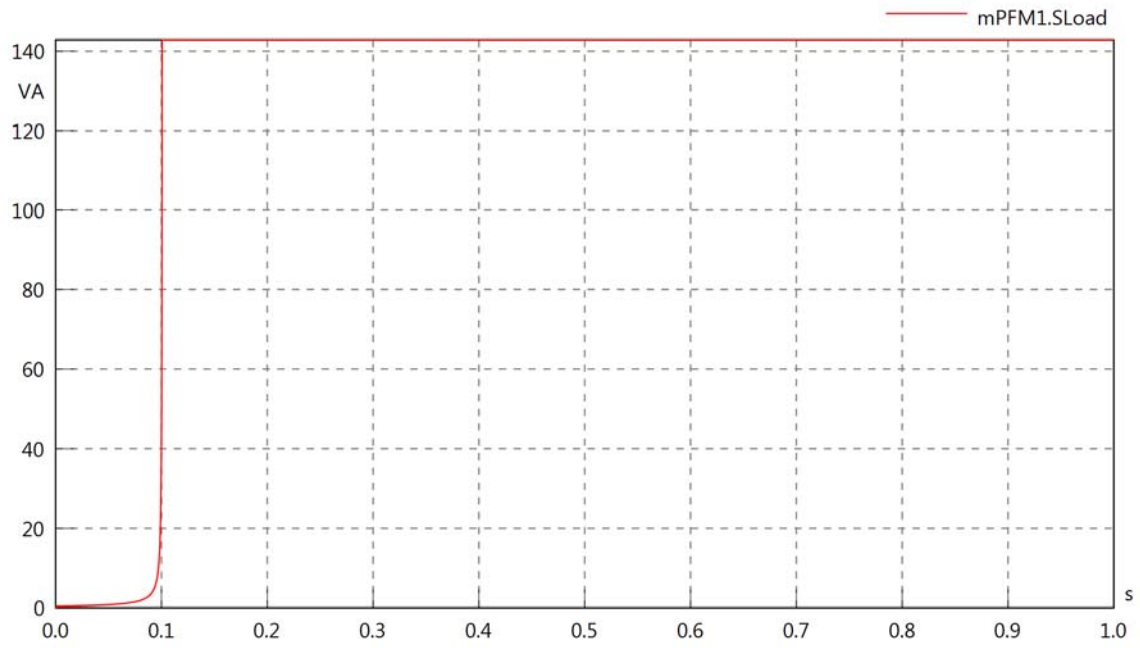
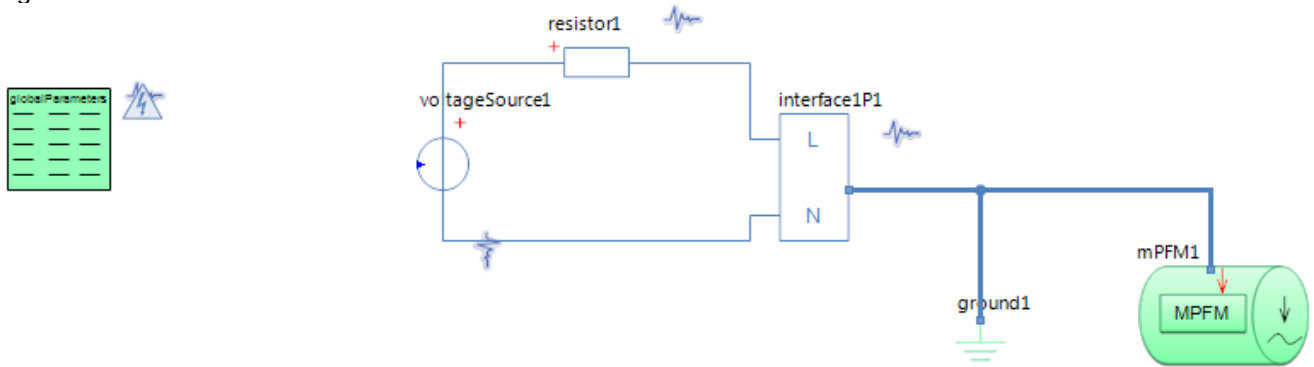

Diagram View



GlobalParameters globalParameters
Parameters

Comment	Name	Current Value	Unit
Type of Calculation	eCalculationKind	Signal Calculation	
Description of Frequency	eFrequencyKind	Linear	
Minimum Frequency	fMin	120	[Hz]
Maximum Frequency	fMax	120	[Hz]

Multiphase Flow Meter mPFM1
Parameters

Comment	Name	Current Value	Unit
EPU or Modem sending on system	sType	EPU sending	
Simulate with internal Transformer	trafoOn	false	
Constant or Variable Power	pType	Constant Power	
Output Power from PSU in MPFM	P	100	[VA]
PSU Power Factor	pf	0.7	[-]
PSU turn-off RMS Voltage	vMin	130	[V]
PSU turn-on RMS Voltage	vMax	180	[V]

Resistor resistor1
Parameters

Comment	Name	Current Value	Unit
Resistance	R	50	[Ohm]

Voltage Source voltageSource1
Parameters

Comment	Name	Current Value	Unit
Voltage RMS	VrmsSrc	$\min(230, 230000 \cdot t)$	[V]
Phase	phi	0	[deg]

mPFM1.Rload

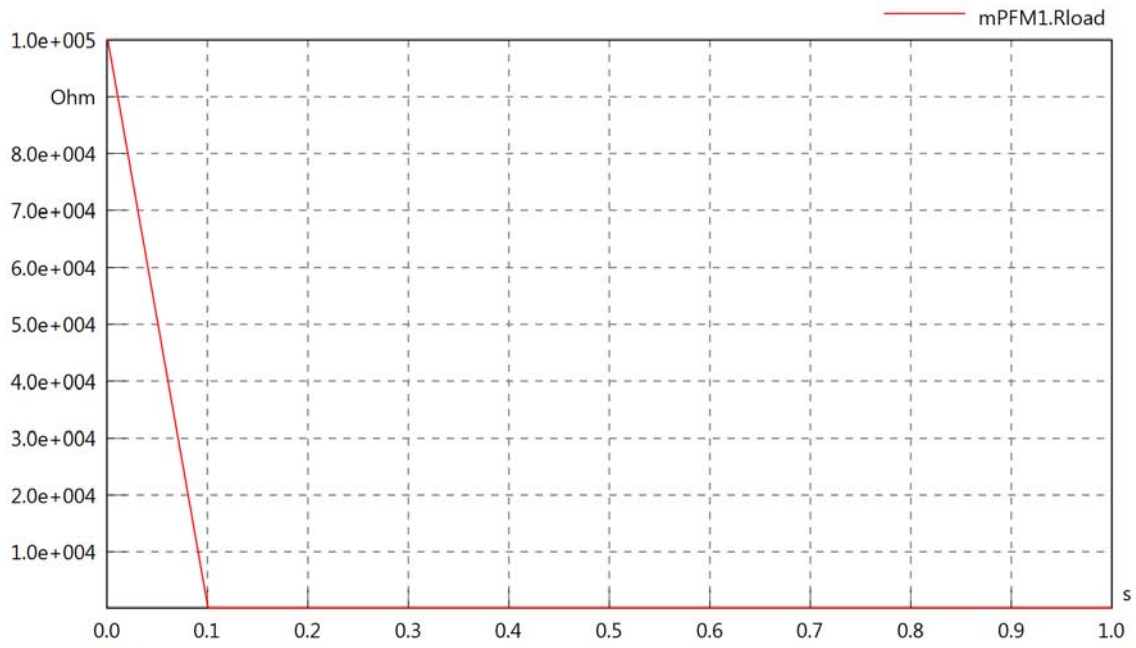

mPFM1.Cload

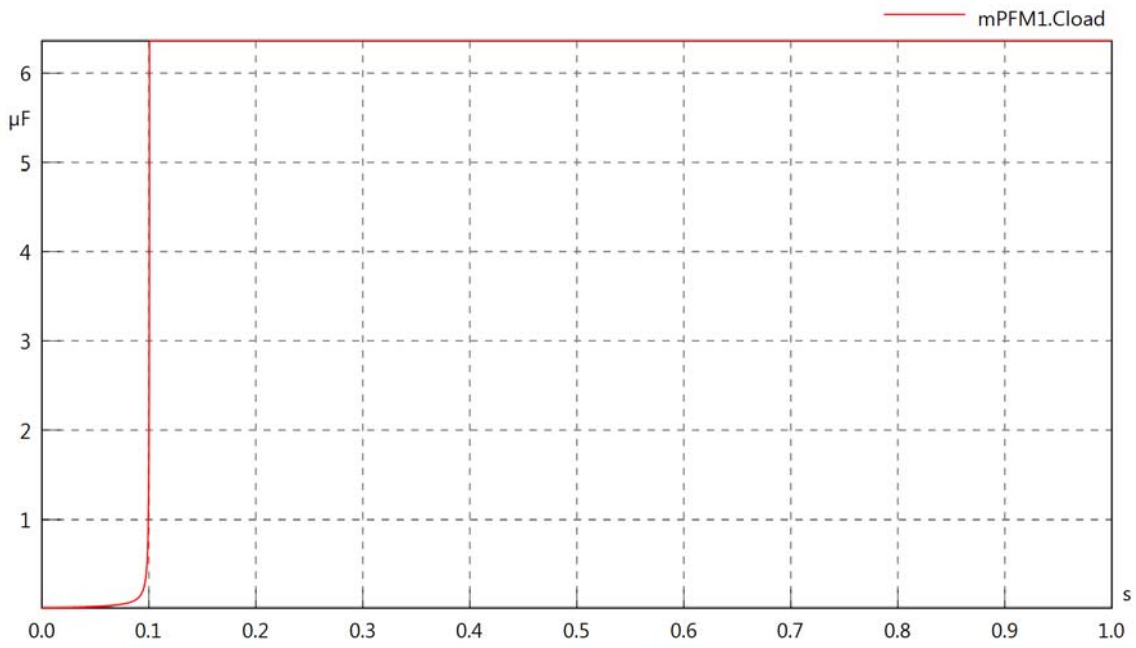

mPFM1.PsetX2

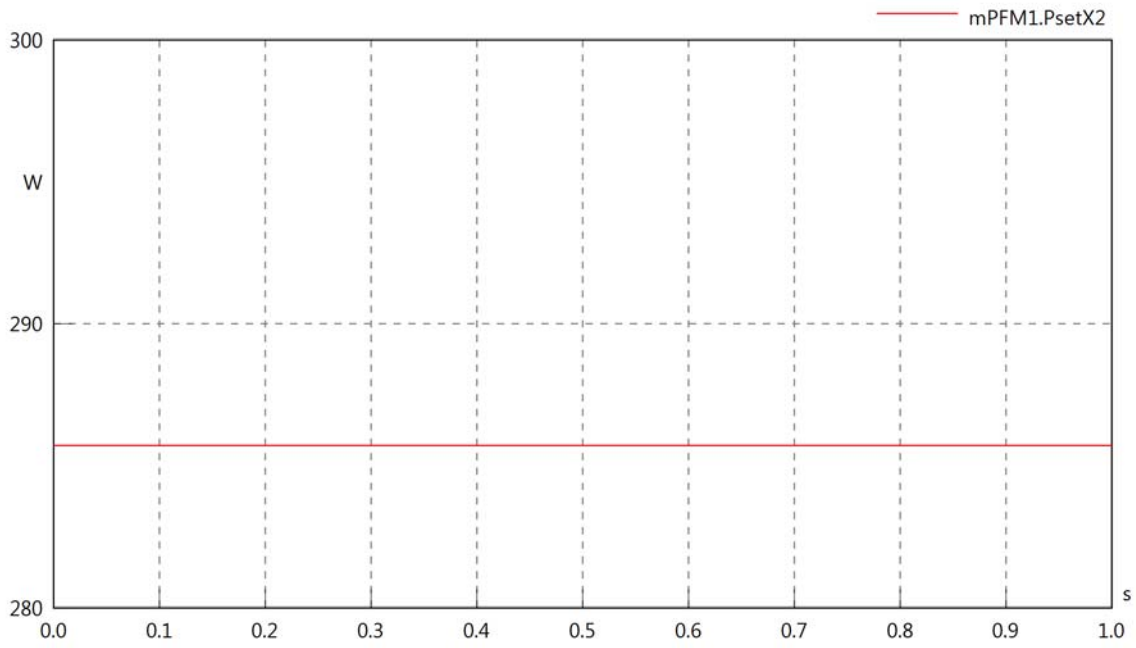

mPFM1.Pset

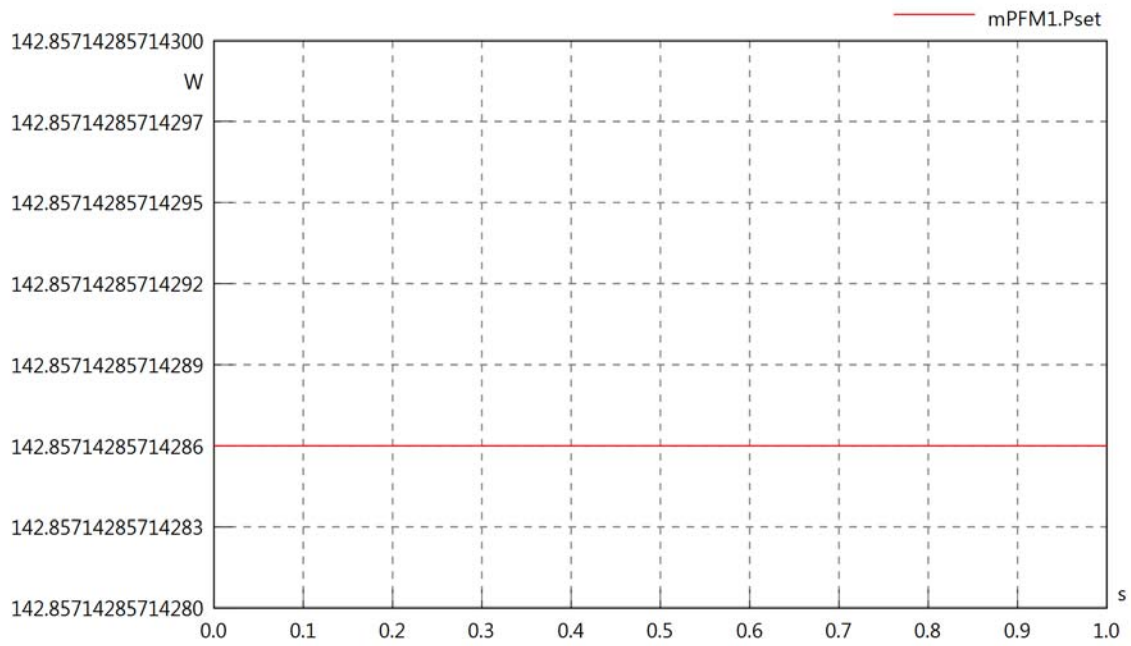

mPFM1.PCalc

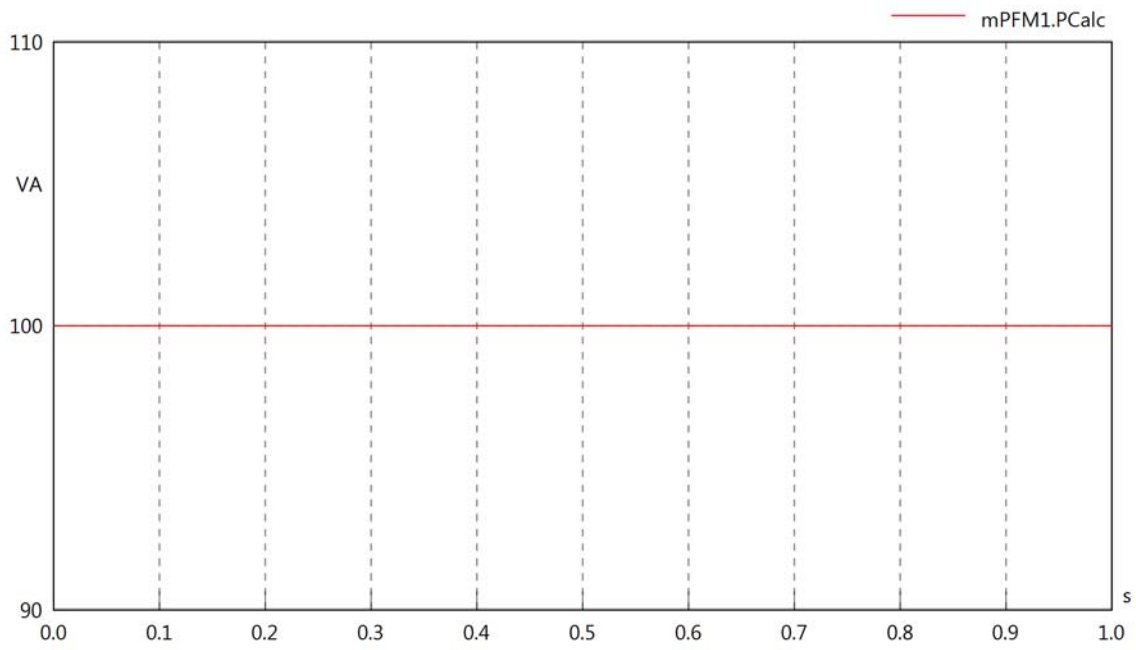

mPFM1.VrmsIn

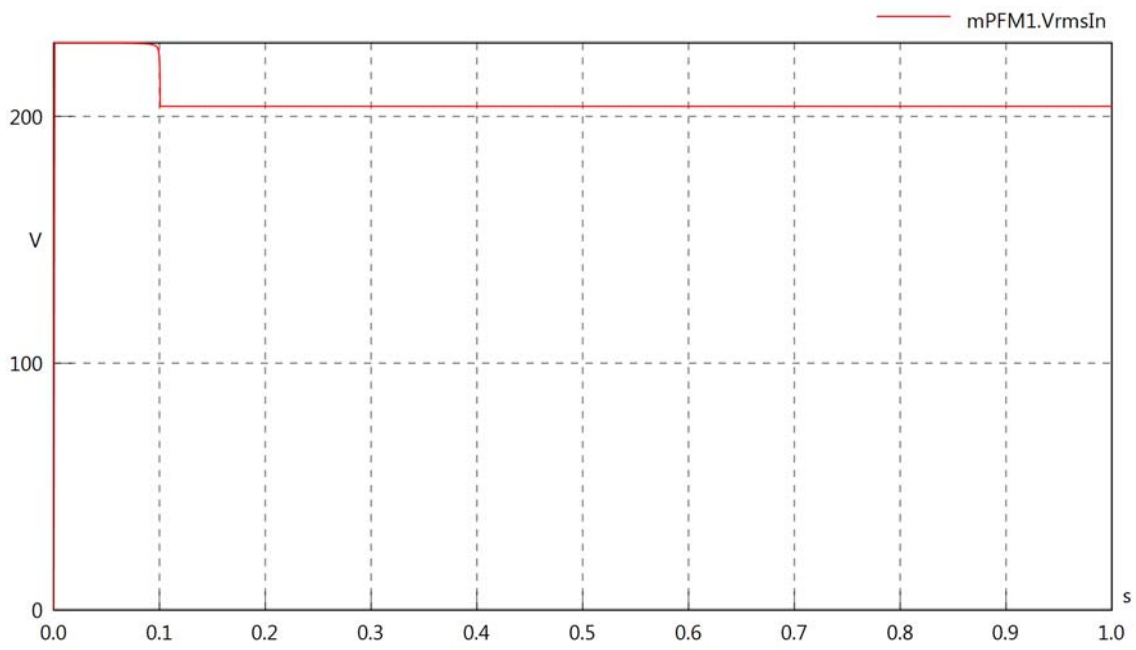

mPFM1.vReIn

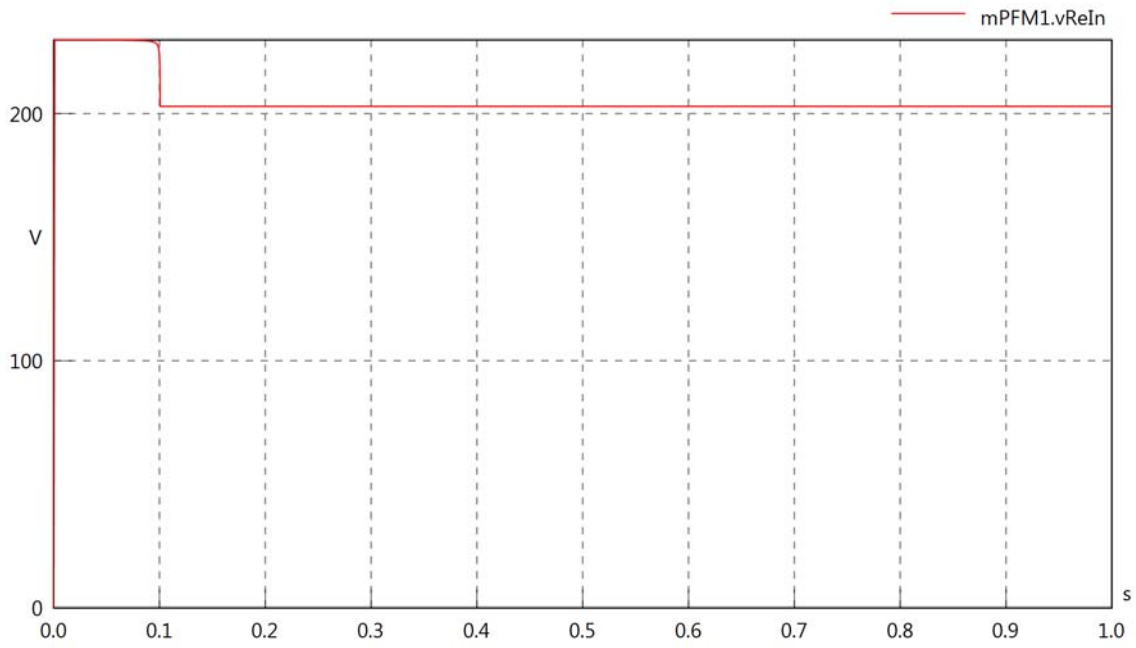

mPFM1.vImIn

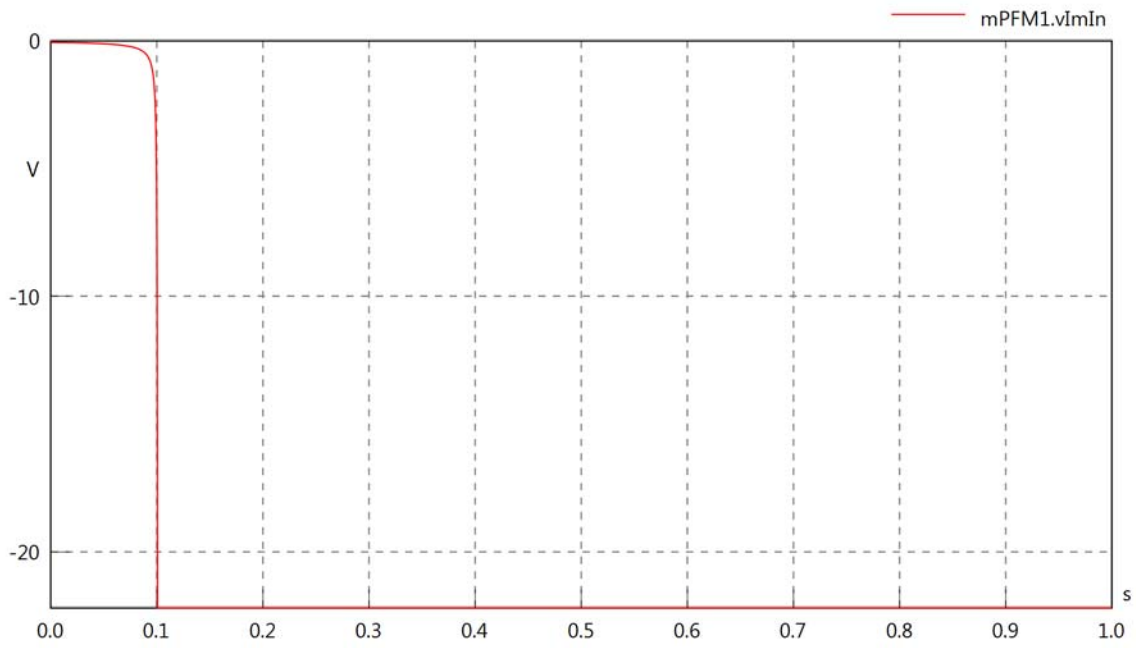

mPFM1.IrmsIn

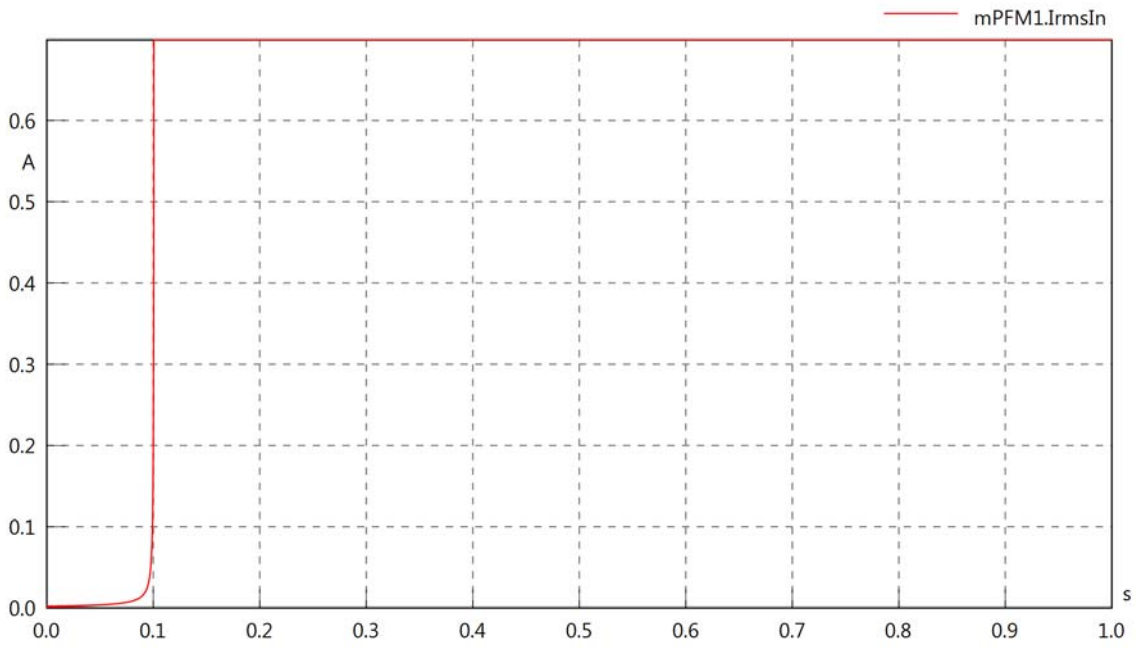

mPFM1.iReIn

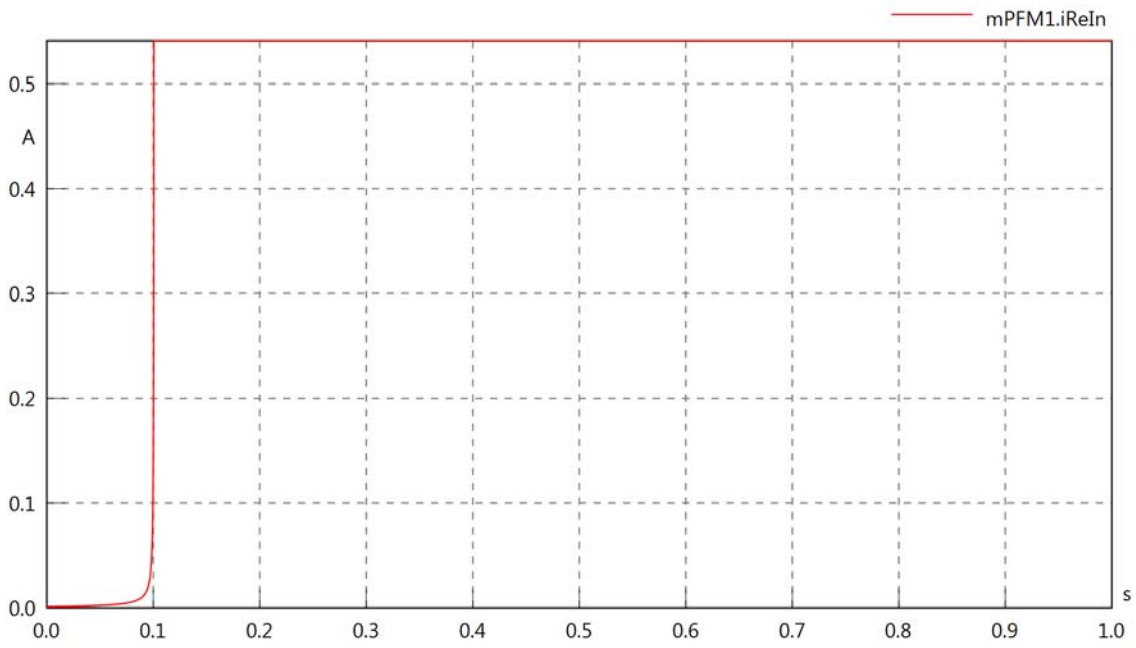

mPFM1.iImIn

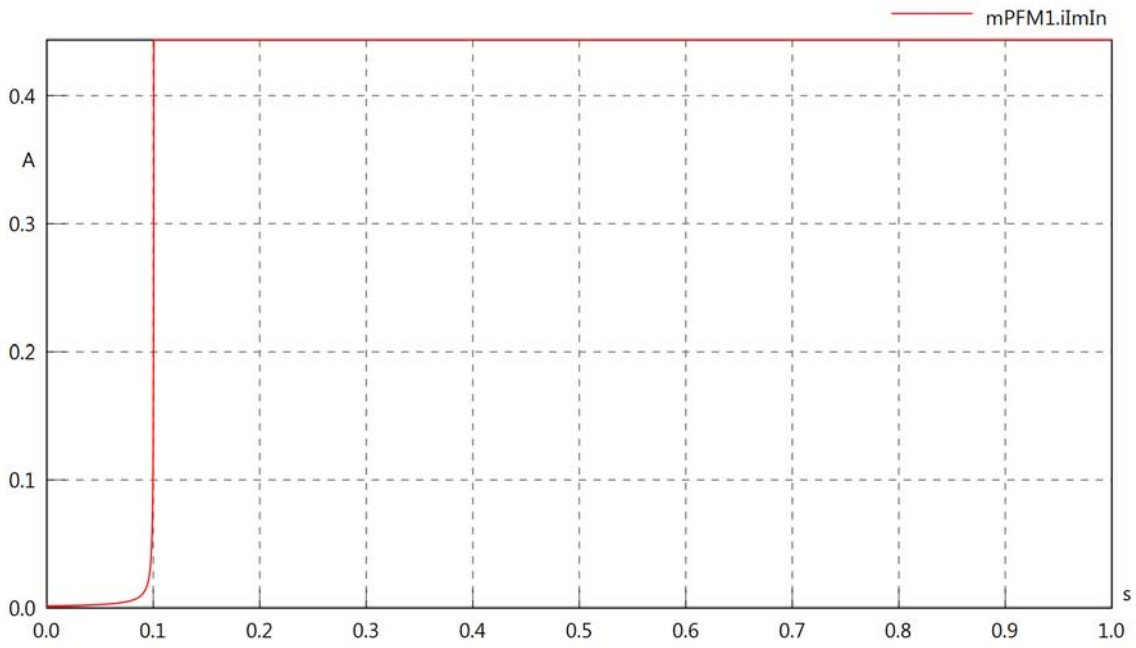

mPFM1.phiVIn

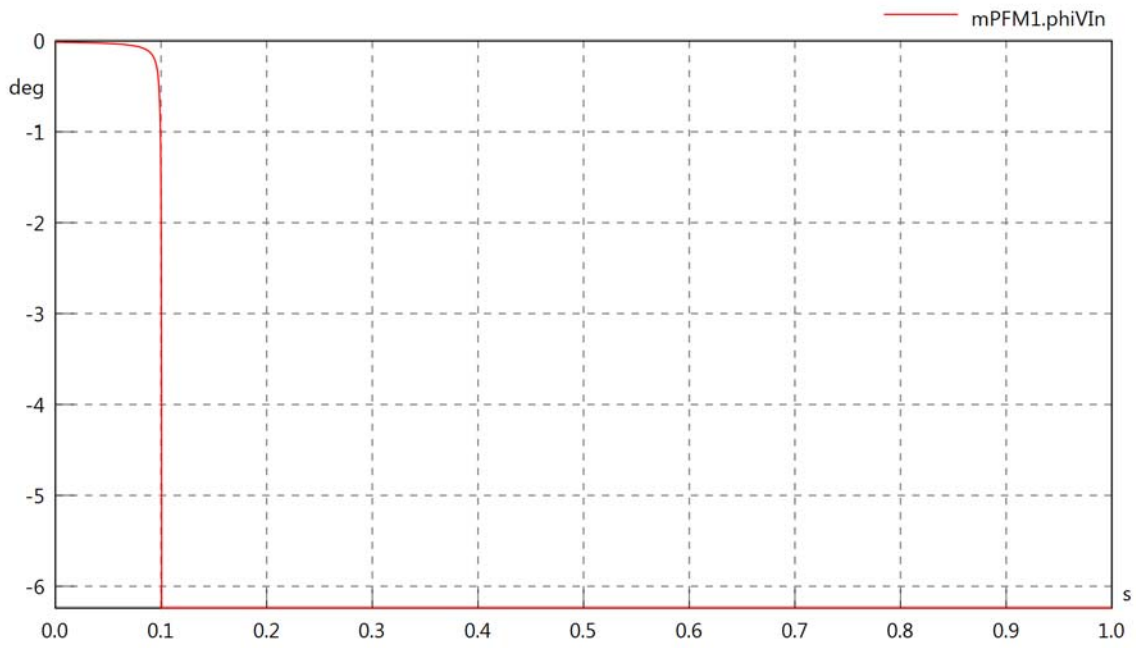

mPFM1.phiIn

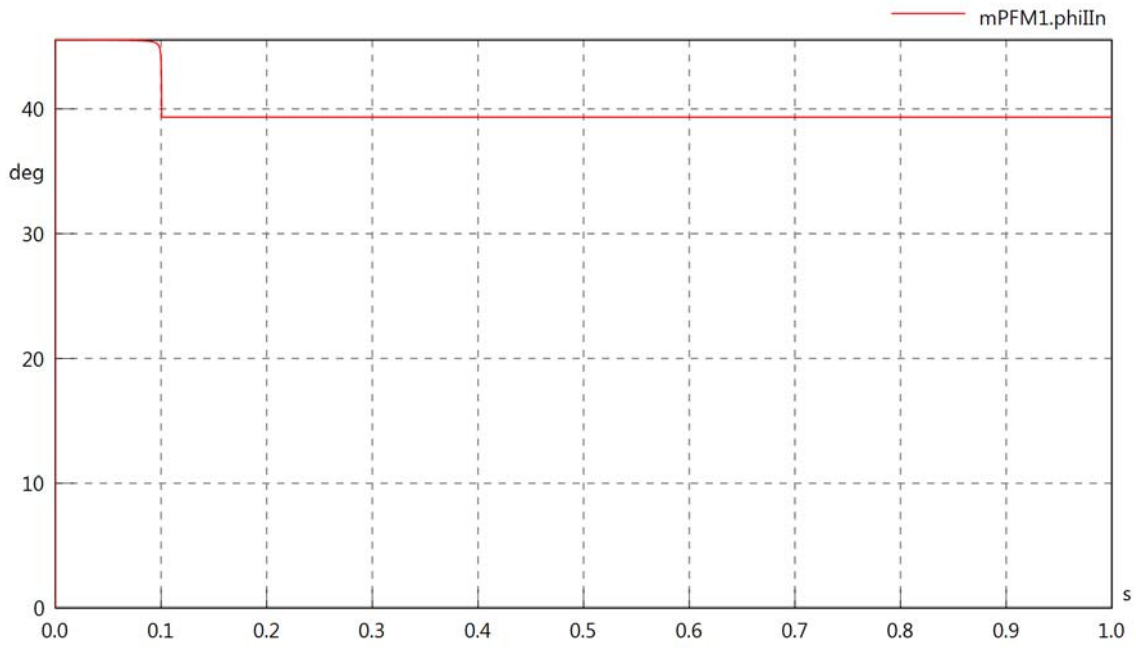

mPFM1.phiIVIn

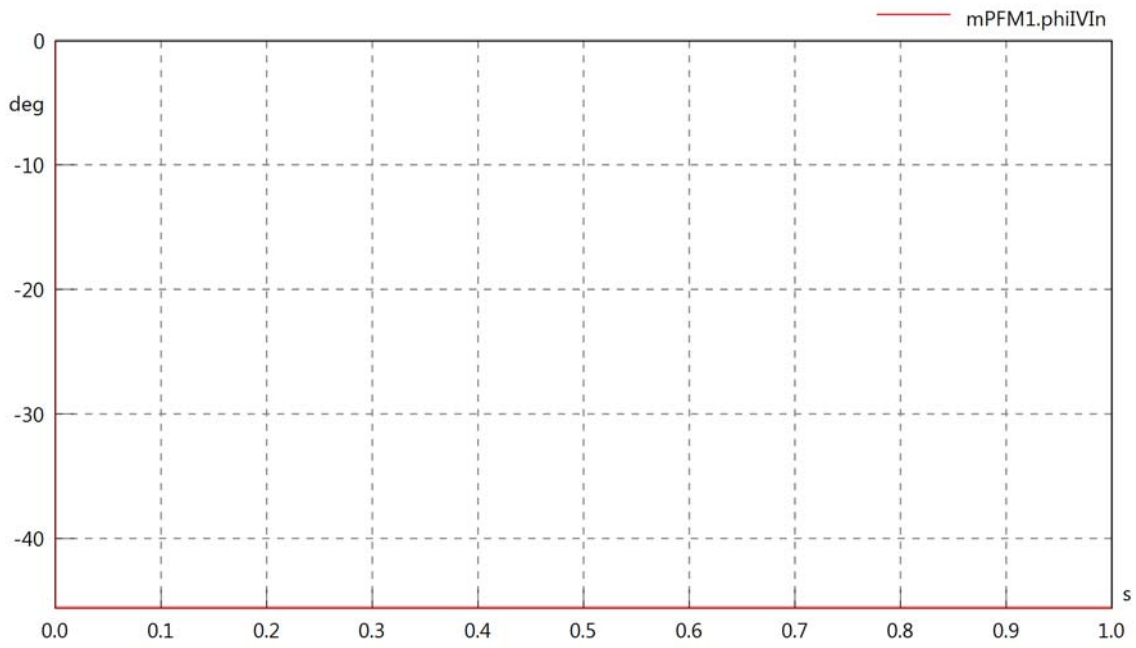

mPFM1.PReIn

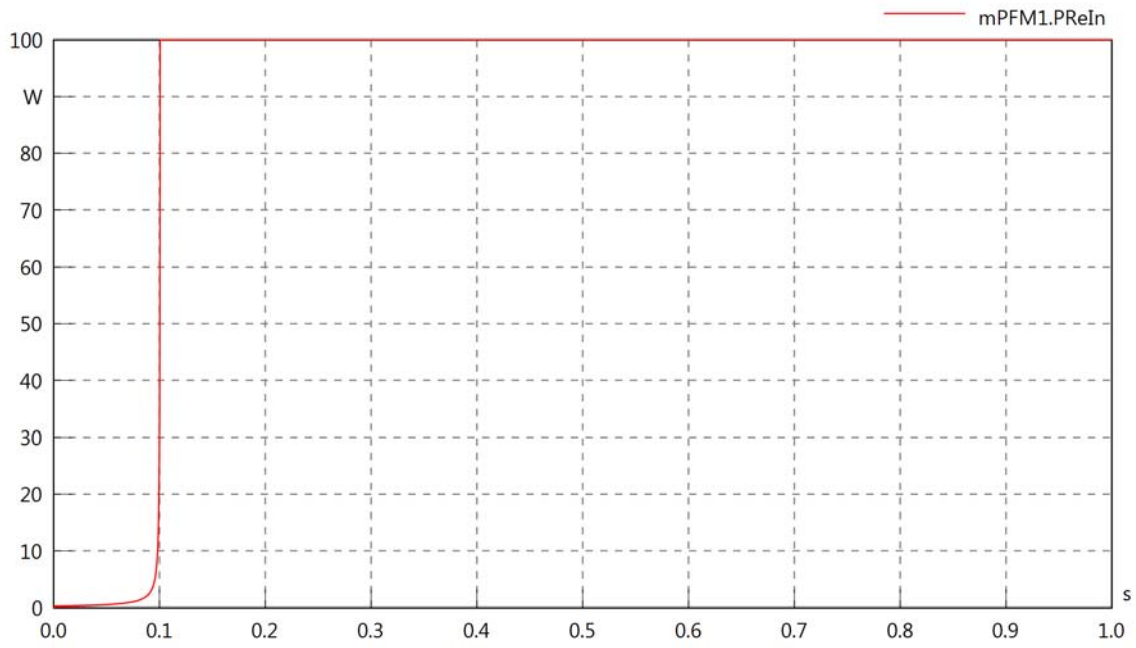

mPFM1.PImIn

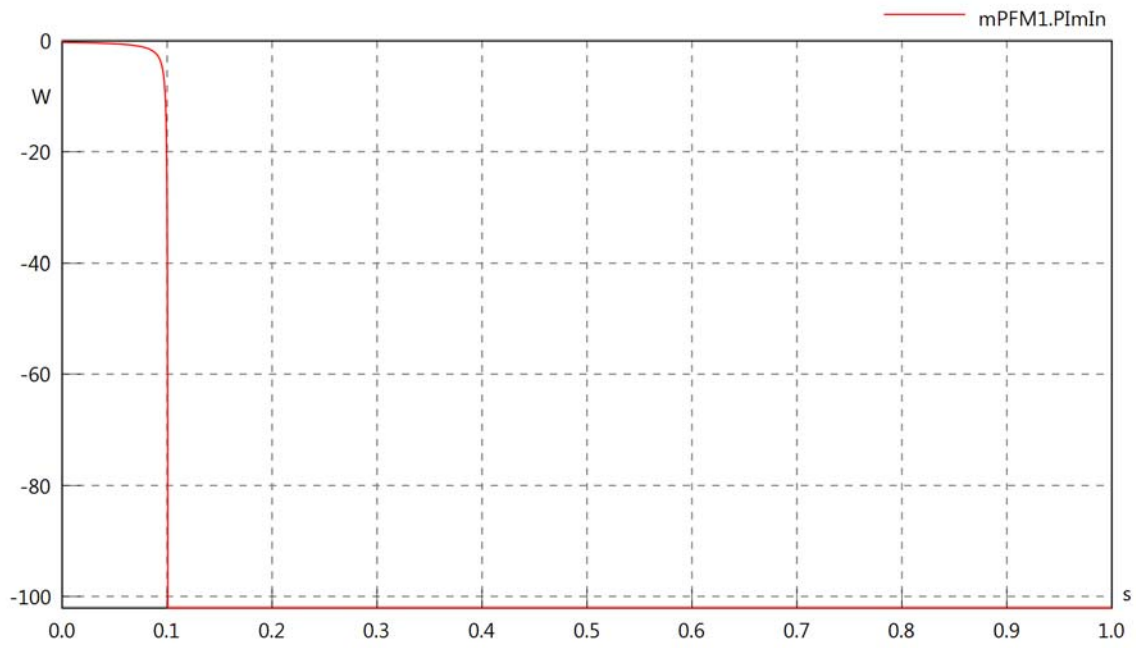

mPFM1.SIn

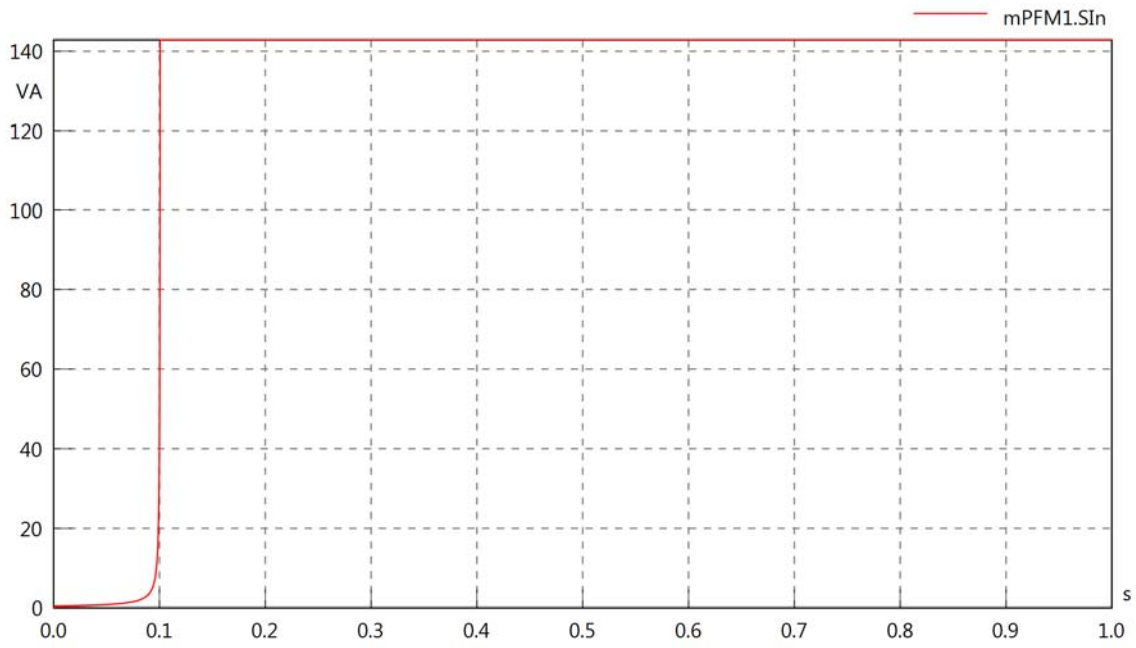

mPFM1.VrmsLoad

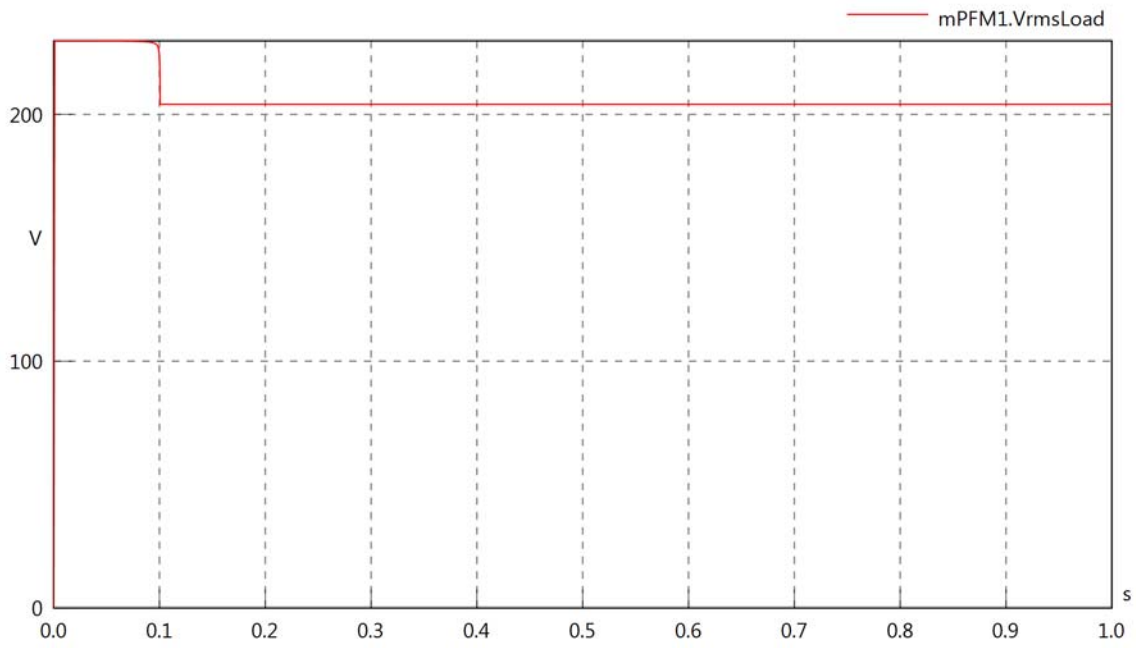

mPFM1.vReLoad

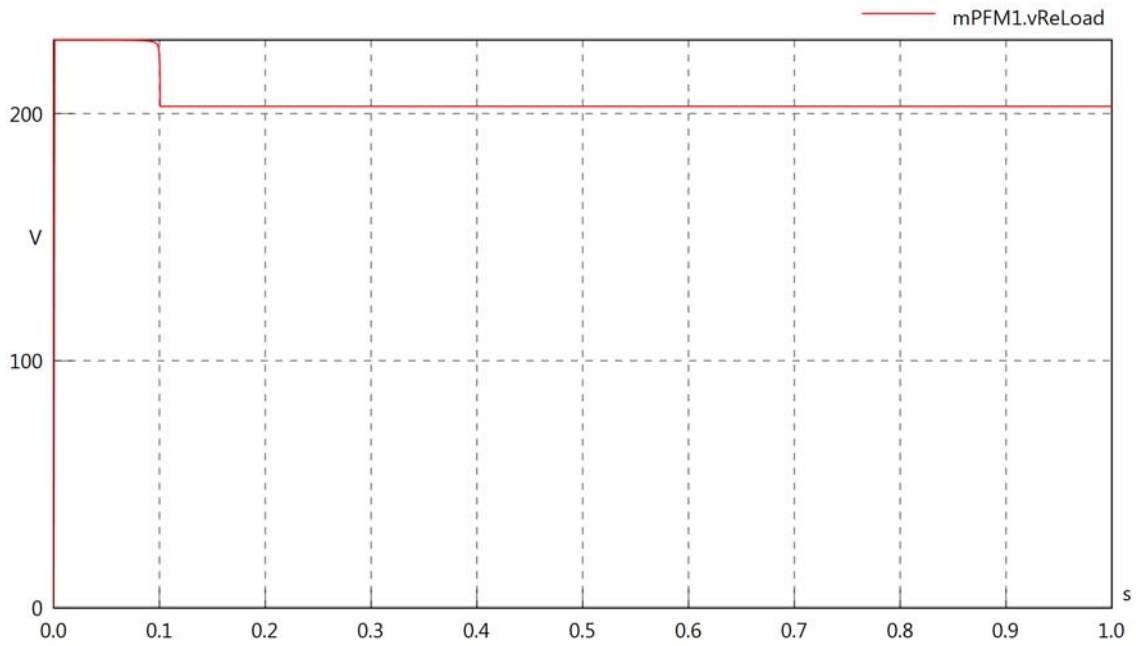

mPFM1.vImLoad

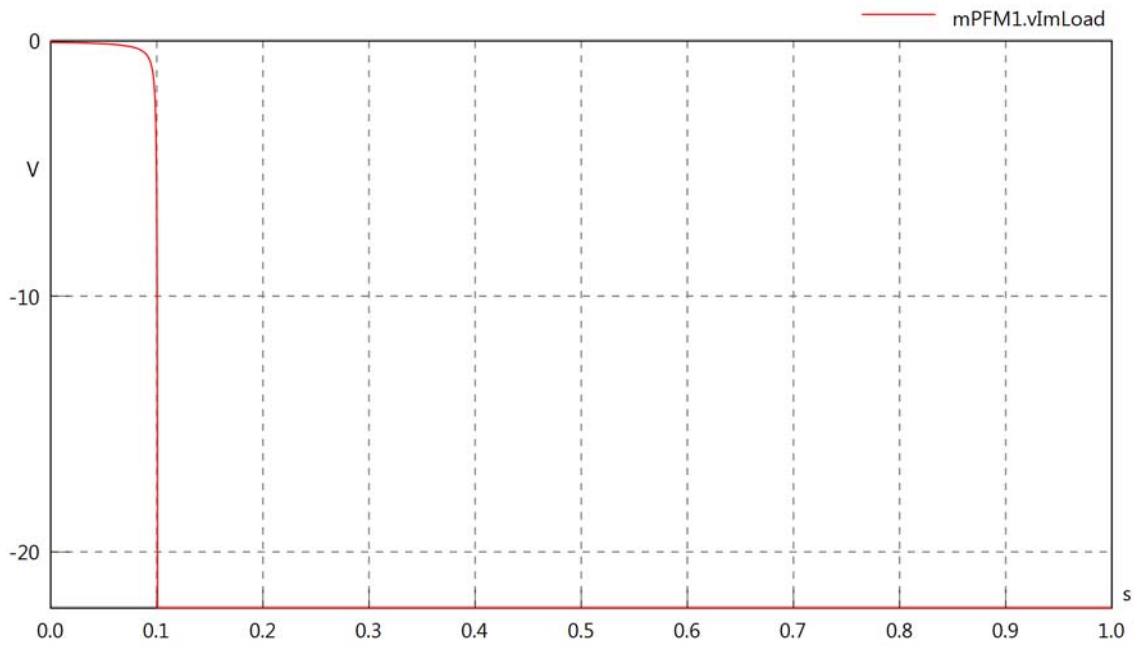

mPFM1.IrmsLoad

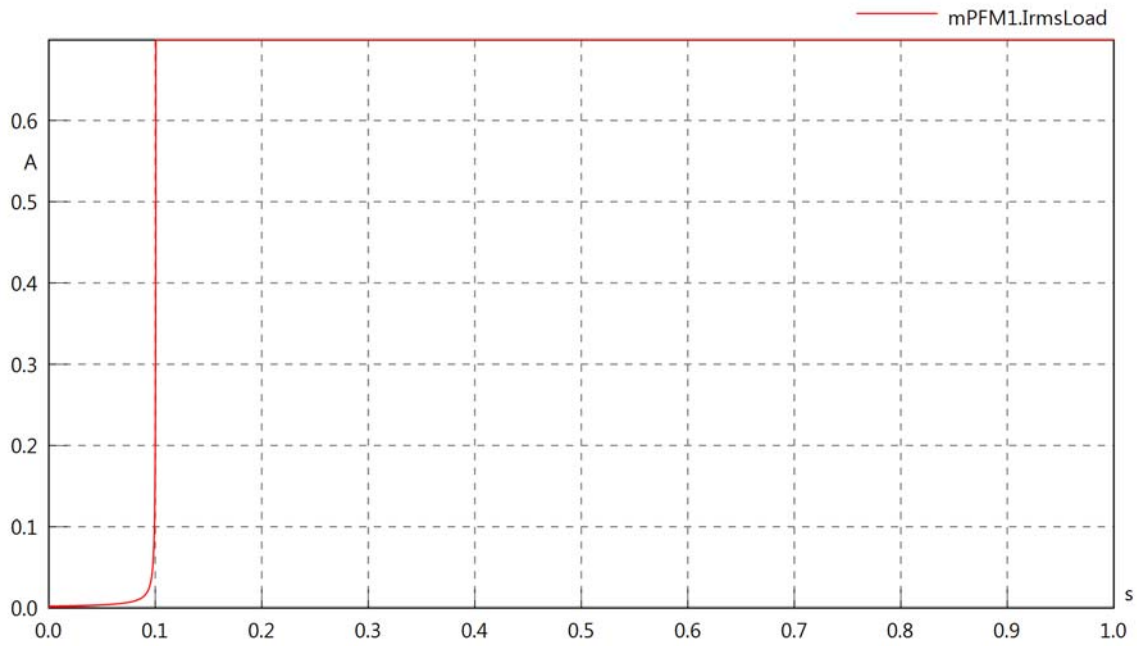

mPFM1.iReLoad

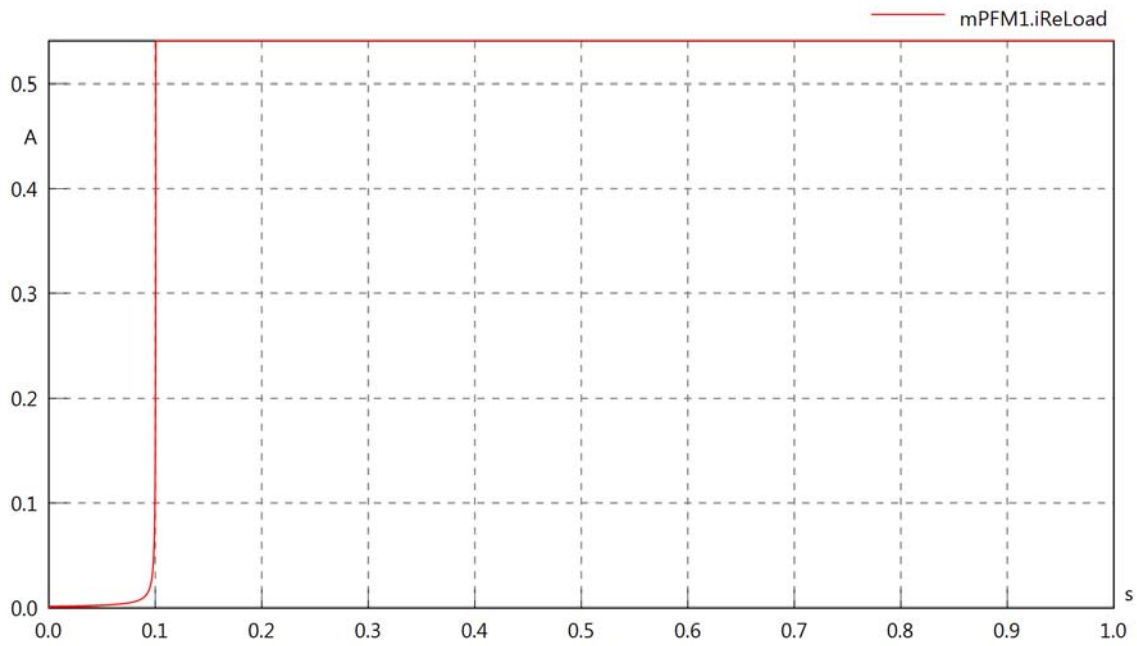

mPFM1.iImLoad

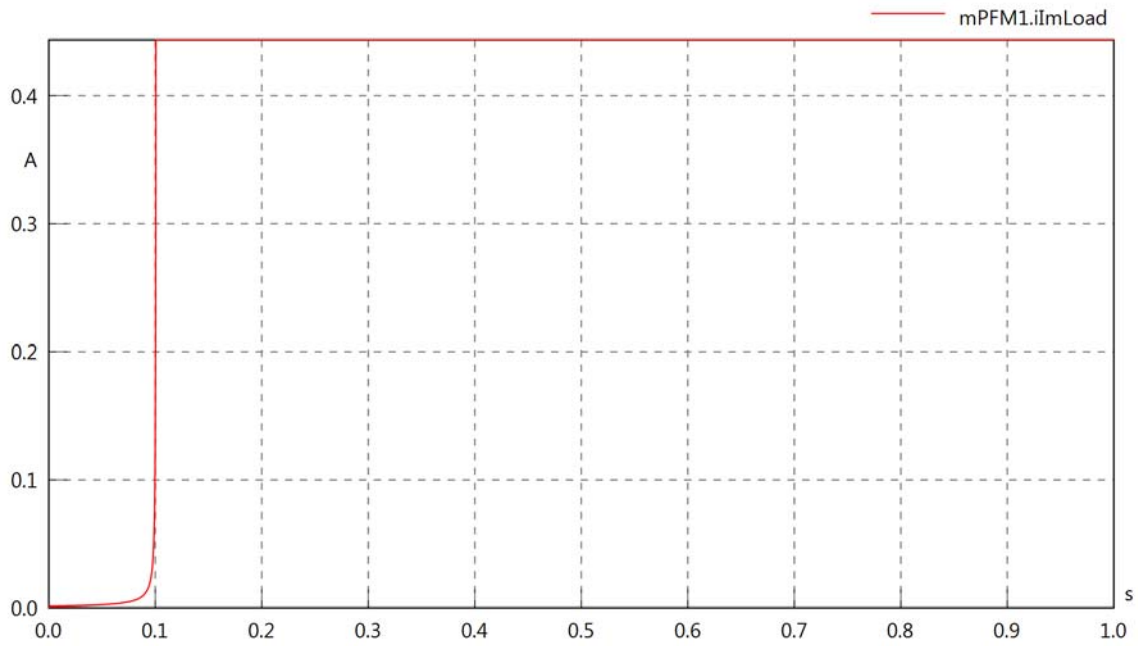

mPFM1.phiVLoad

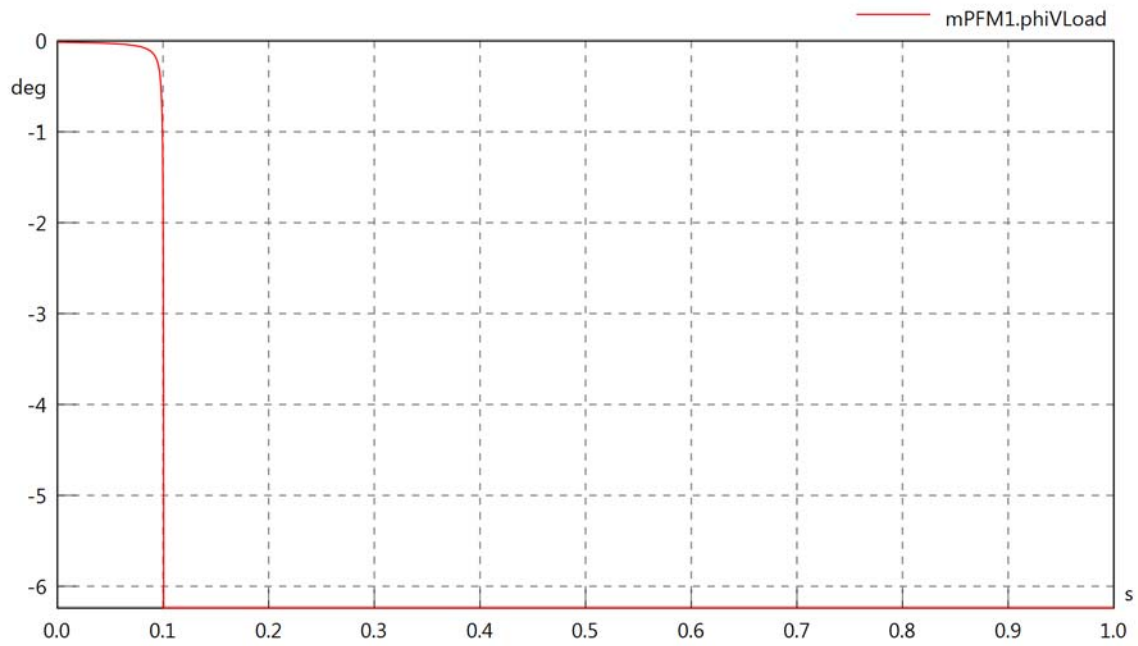

mPFM1.philLoad

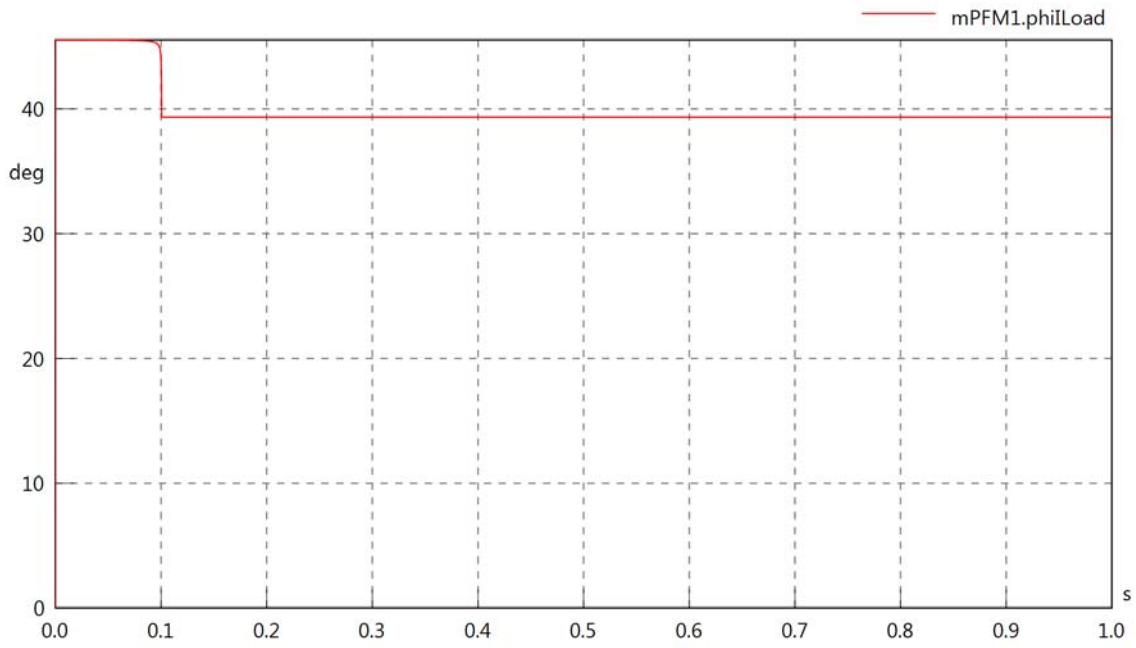

mPFM1.phiIVLoad

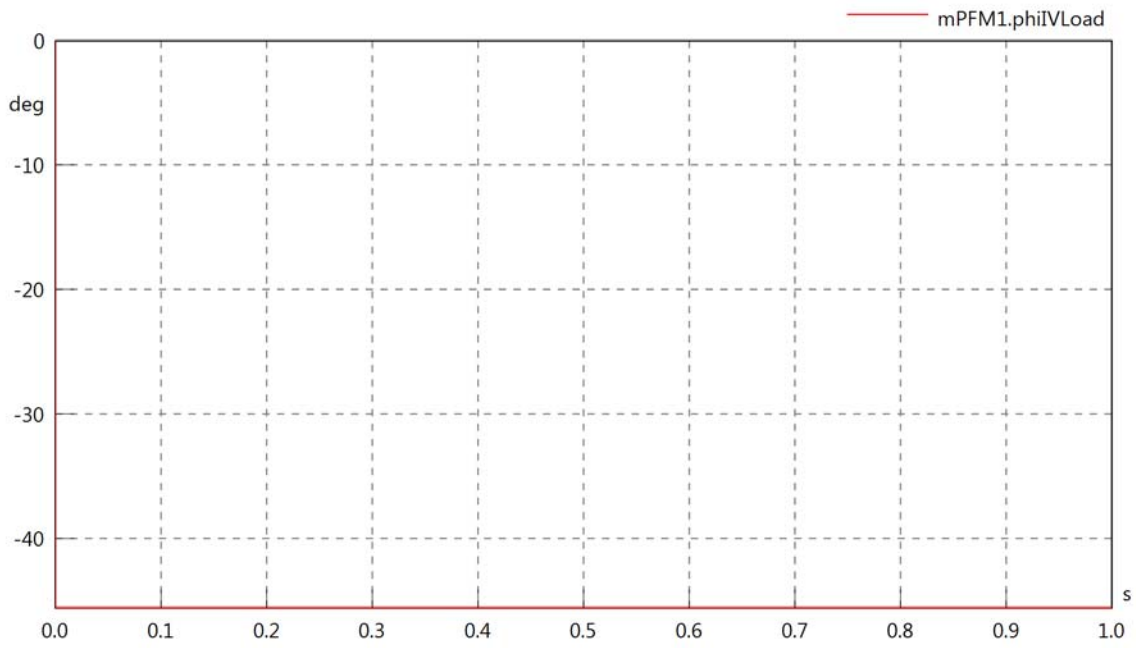

mPFM1.PReLoad

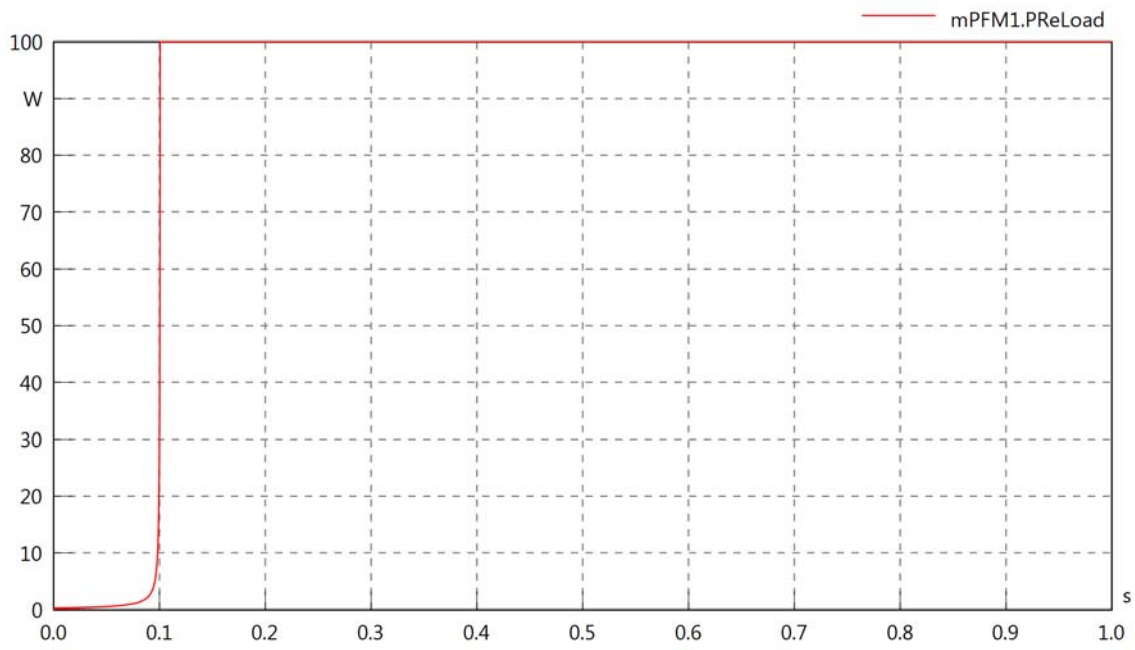

mPFM1.PImLoad

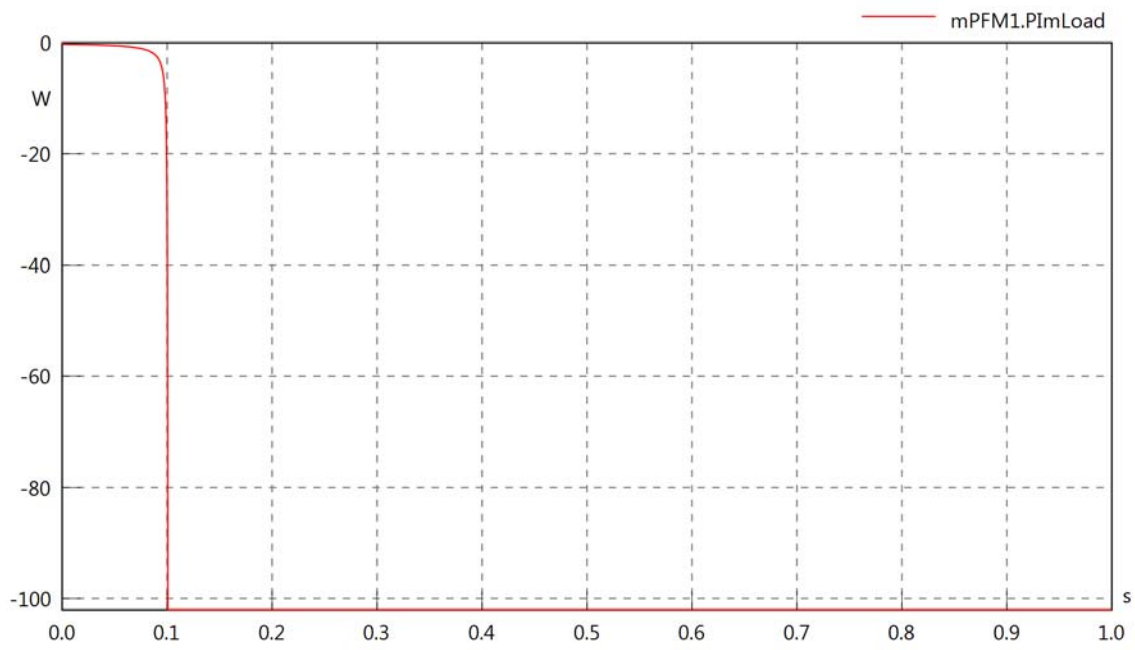

mPFM1.SLoad

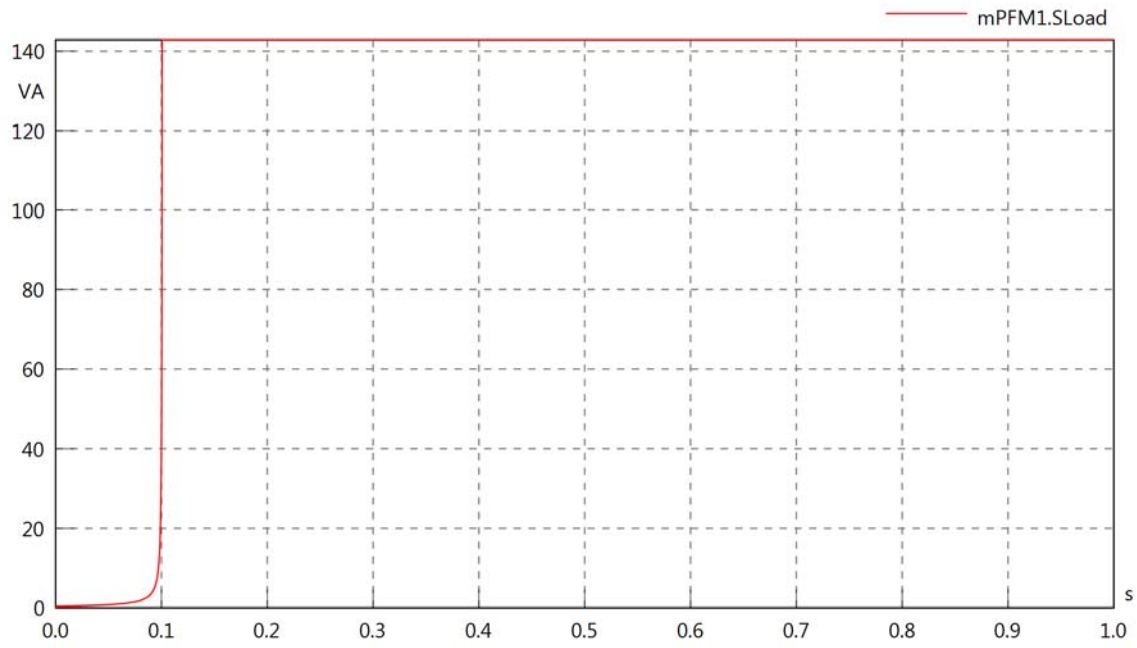
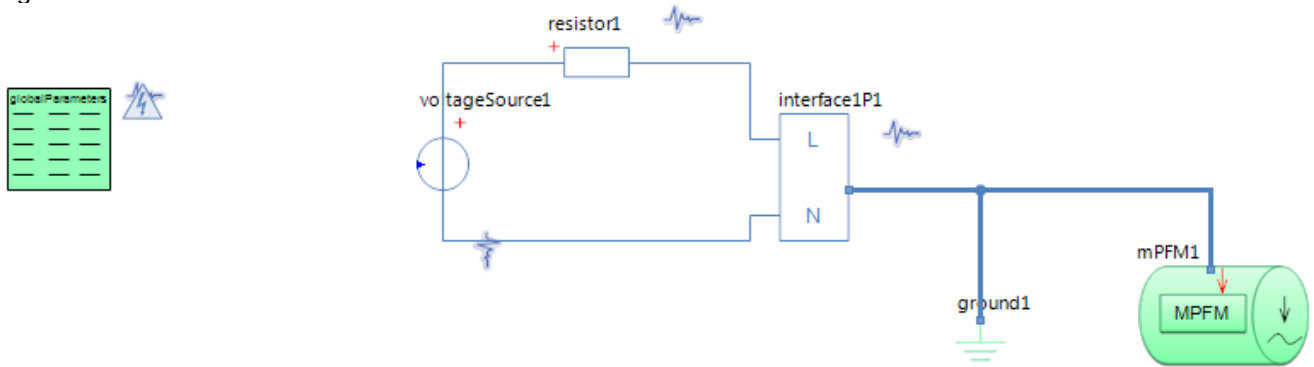

Diagram View



GlobalParameters globalParameters
Parameters

Comment	Name	Current Value	Unit
Type of Calculation	eCalculationKind	Signal Calculation	
Description of Frequency	eFrequencyKind	Linear	
Minimum Frequency	fMin	240	[Hz]
Maximum Frequency	fMax	240	[Hz]

Multiphase Flow Meter mPFM1
Parameters

Comment	Name	Current Value	Unit
EPU or Modem sending on system	sType	EPU sending	
Simulate with internal Transformer	trafoOn	false	
Constant or Variable Power	pType	Constant Power	
Output Power from PSU in MPFM	P	100	[VA]
PSU Power Factor	pf	0.7	[-]
PSU turn-off RMS Voltage	vMin	130	[V]
PSU turn-on RMS Voltage	vMax	180	[V]

Resistor resistor1
Parameters

Comment	Name	Current Value	Unit
Resistance	R	50	[Ohm]

Voltage Source voltageSource1
Parameters

Comment	Name	Current Value	Unit
Voltage RMS	VrmsSrc	$\min(230, 230000 \cdot t)$	[V]
Phase	phi	0	[deg]

mPFM1.Rload

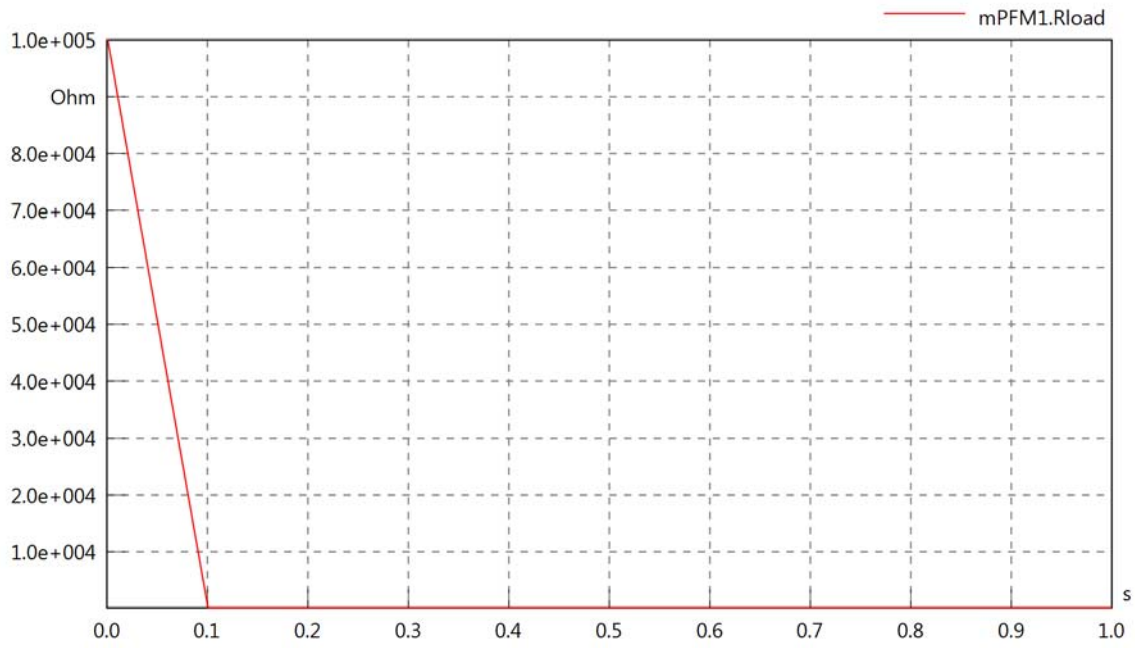

mPFM1.Cload

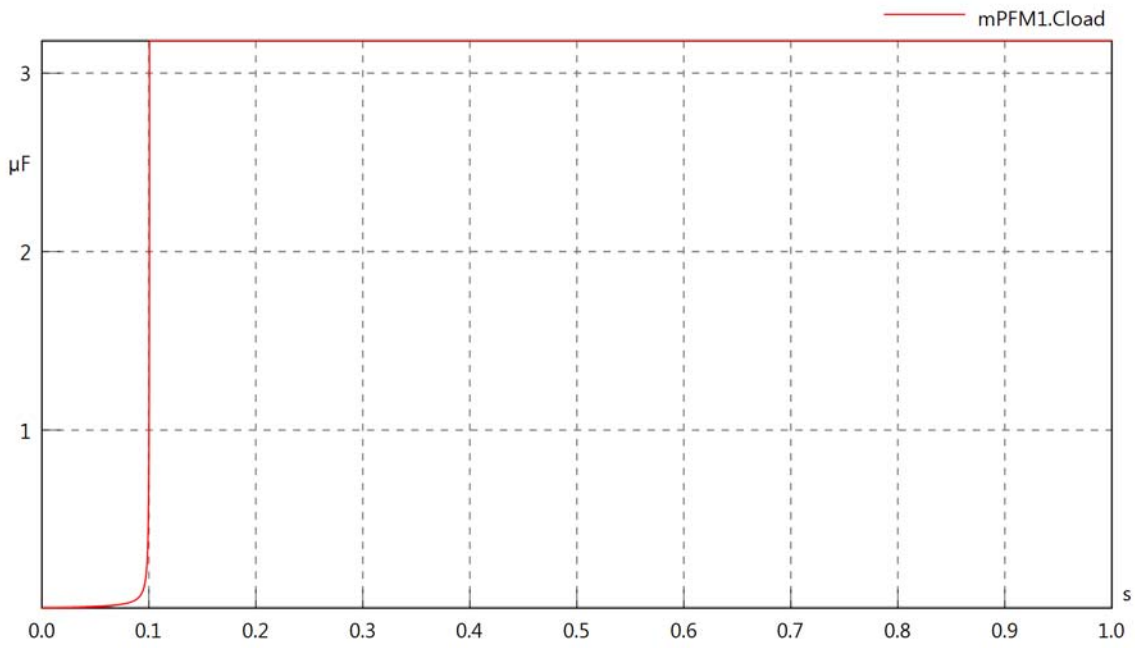

mPFM1.PsetX2

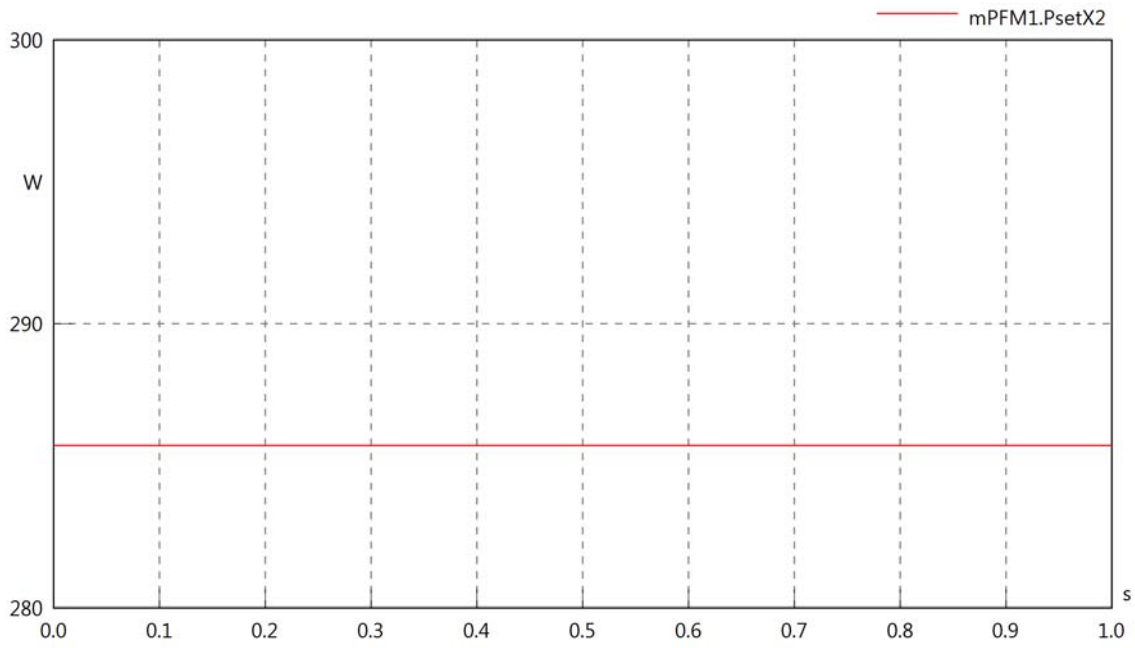

mPFM1.Pset

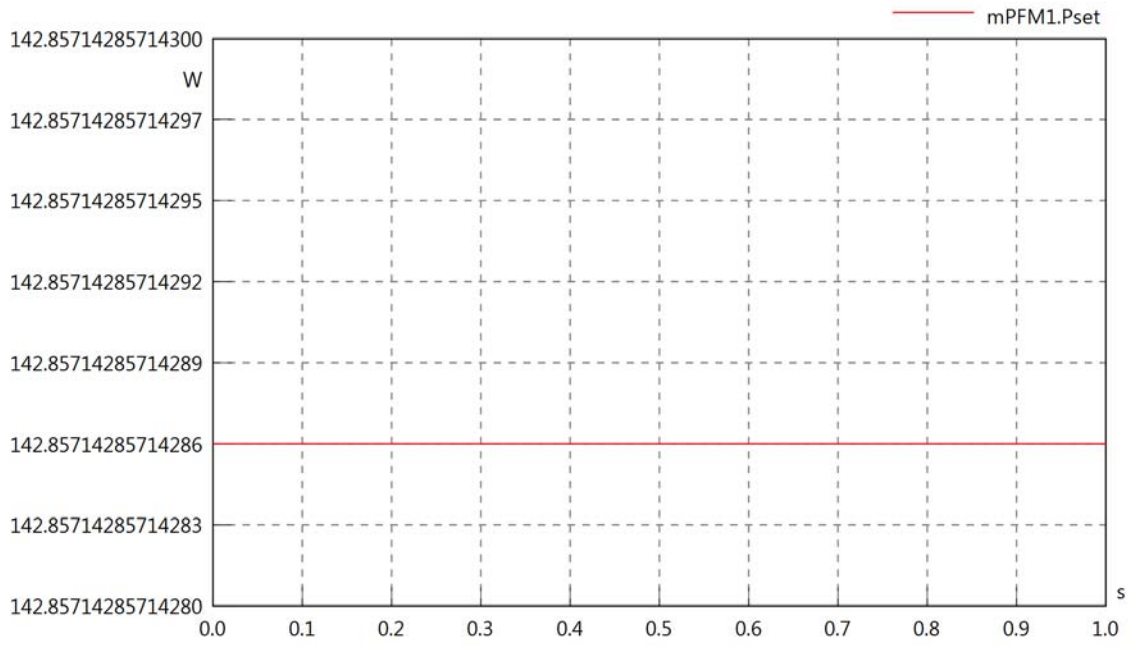

mPFM1.PCalc

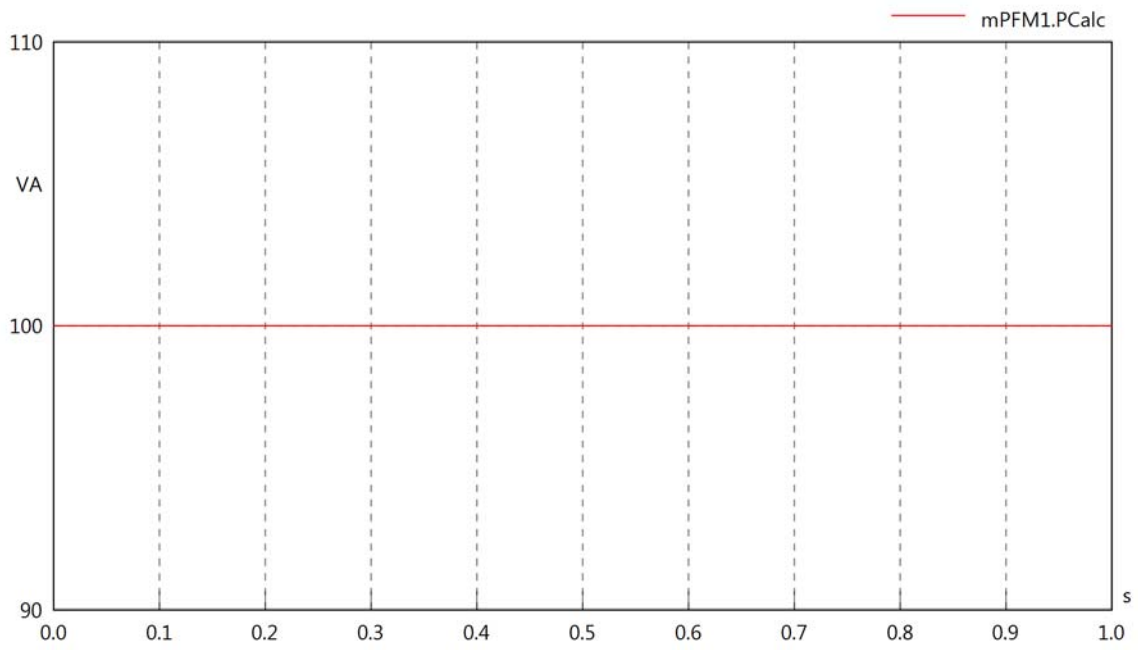

mPFM1.VrmsIn

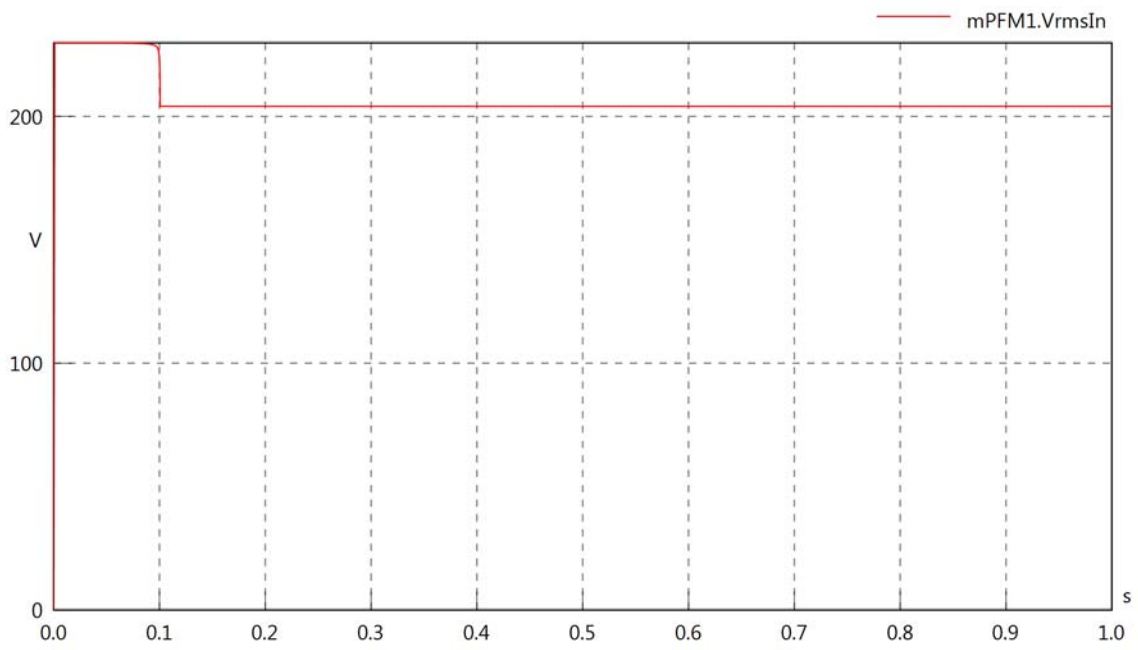

mPFM1.vReIn

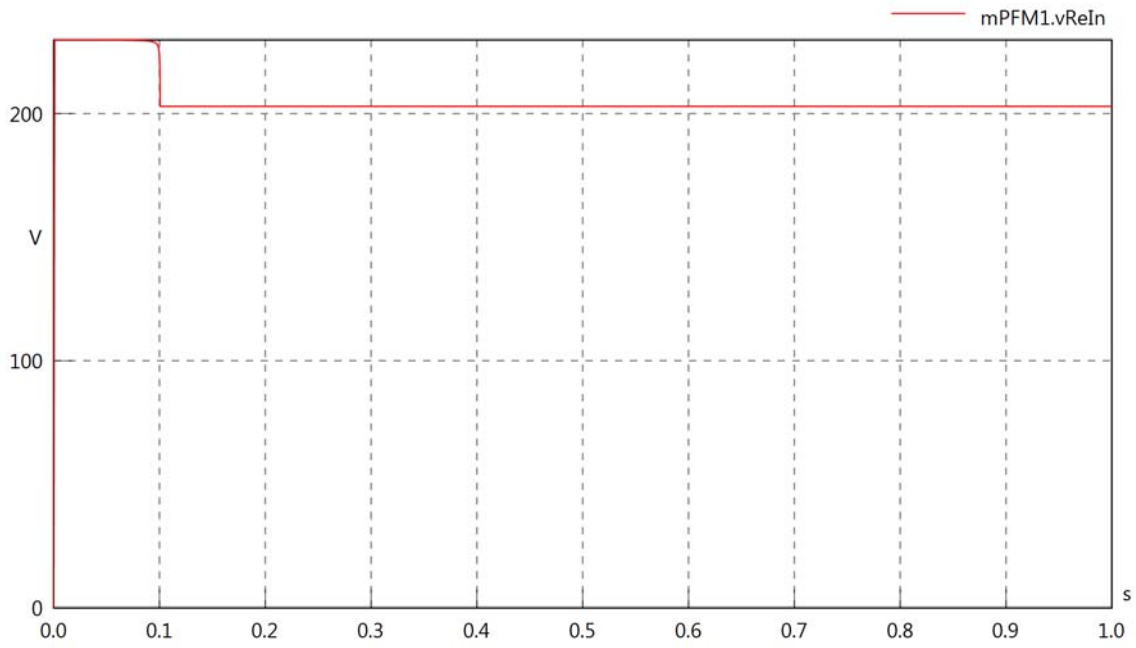

mPFM1.vImIn

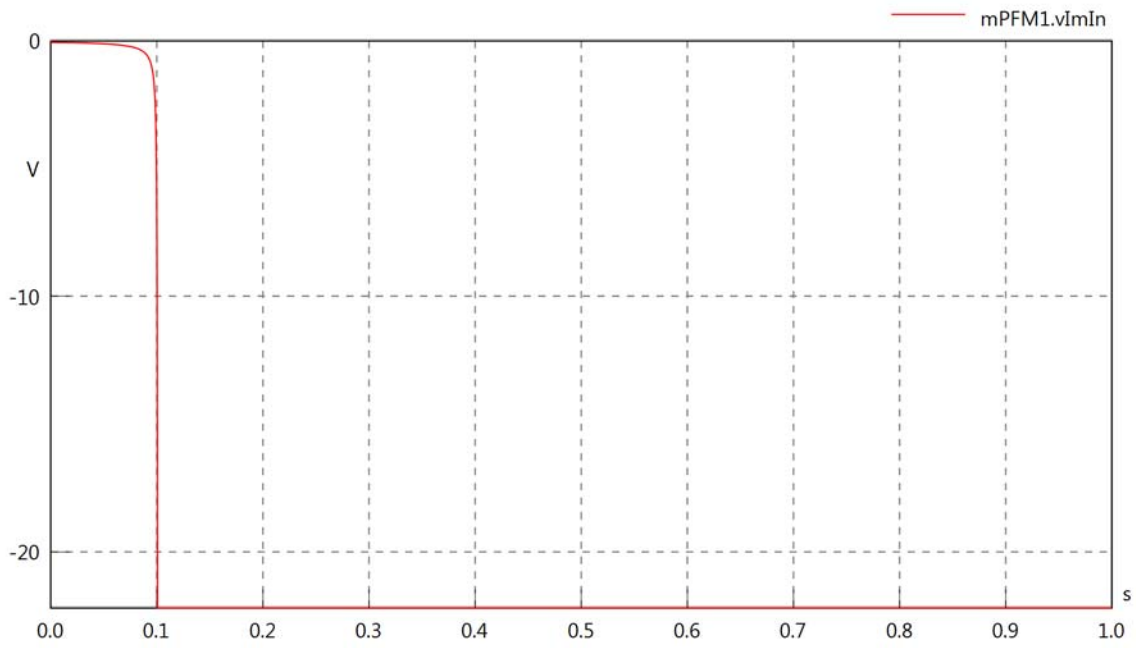

mPFM1.IrmsIn

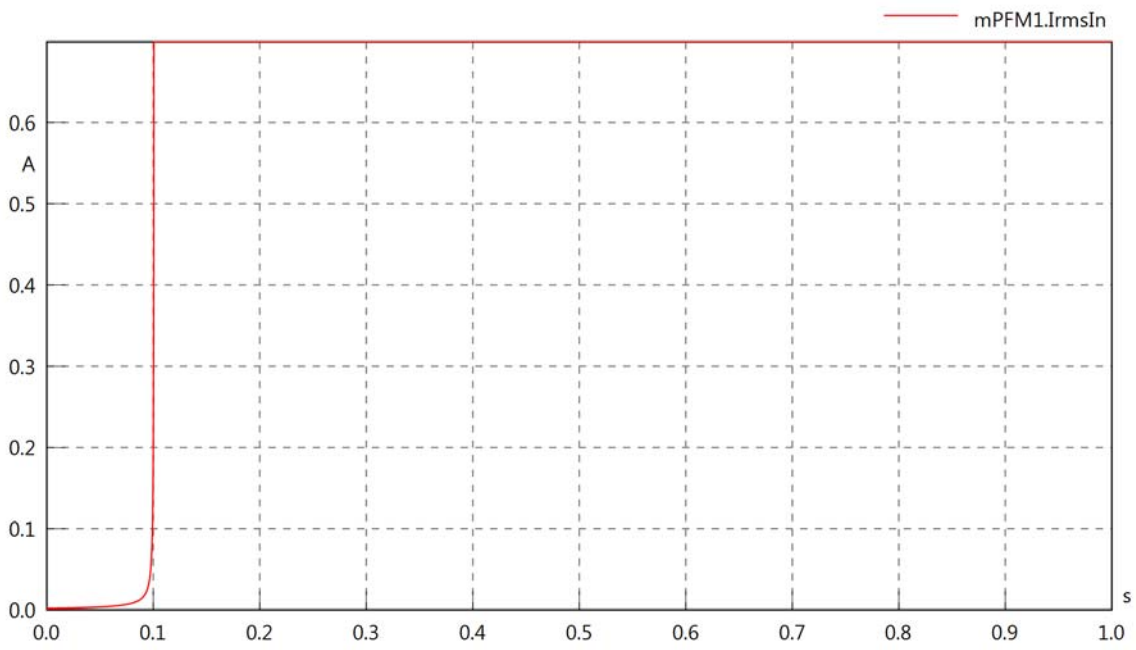

mPFM1.iReIn

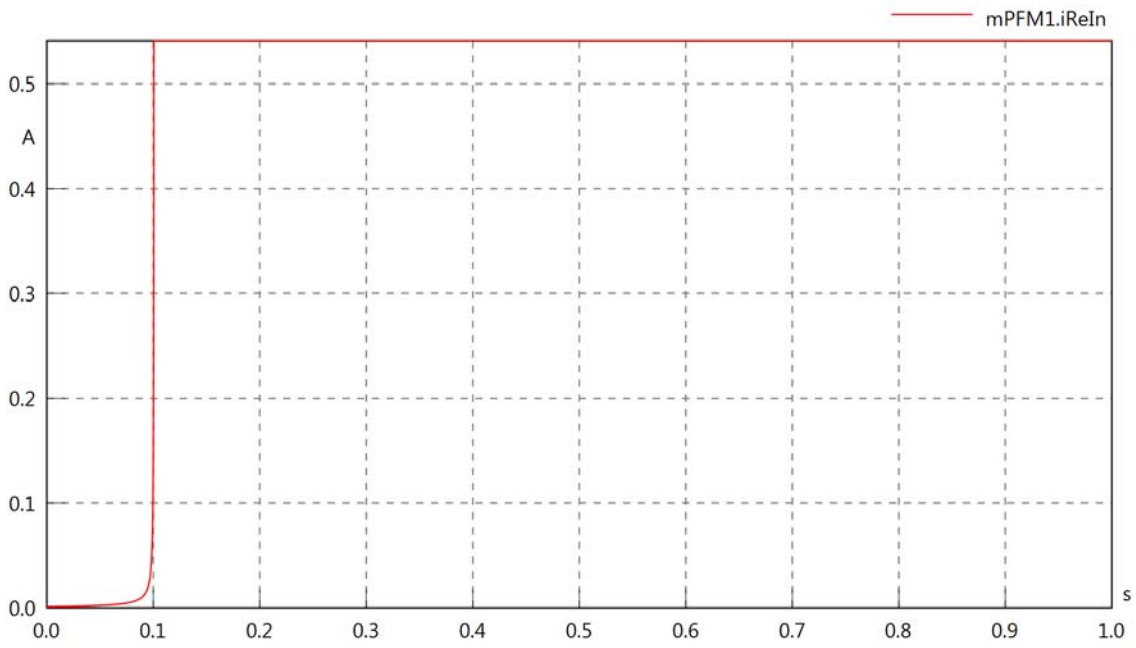

mPFM1.iImIn

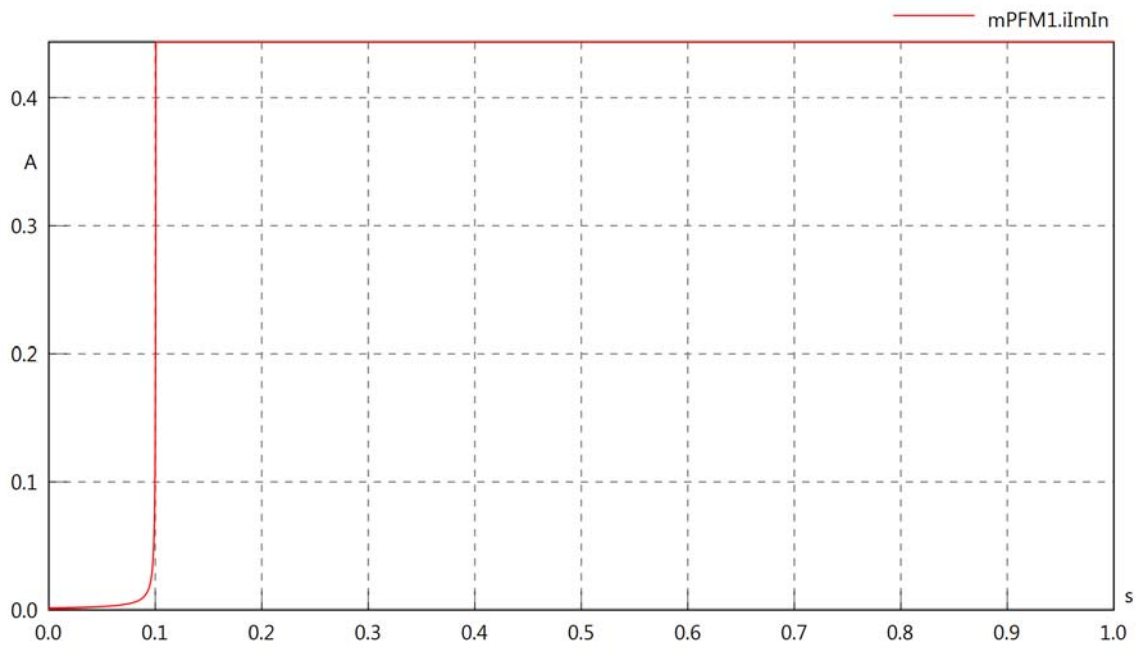

mPFM1.phiVIn

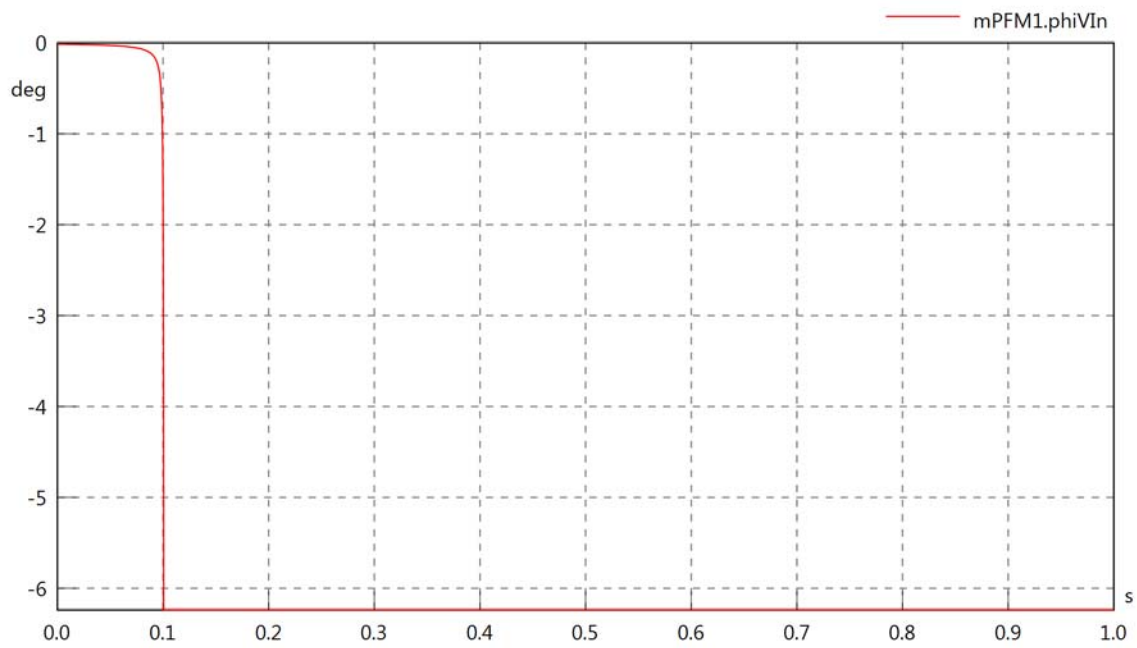

mPFM1.phiIn

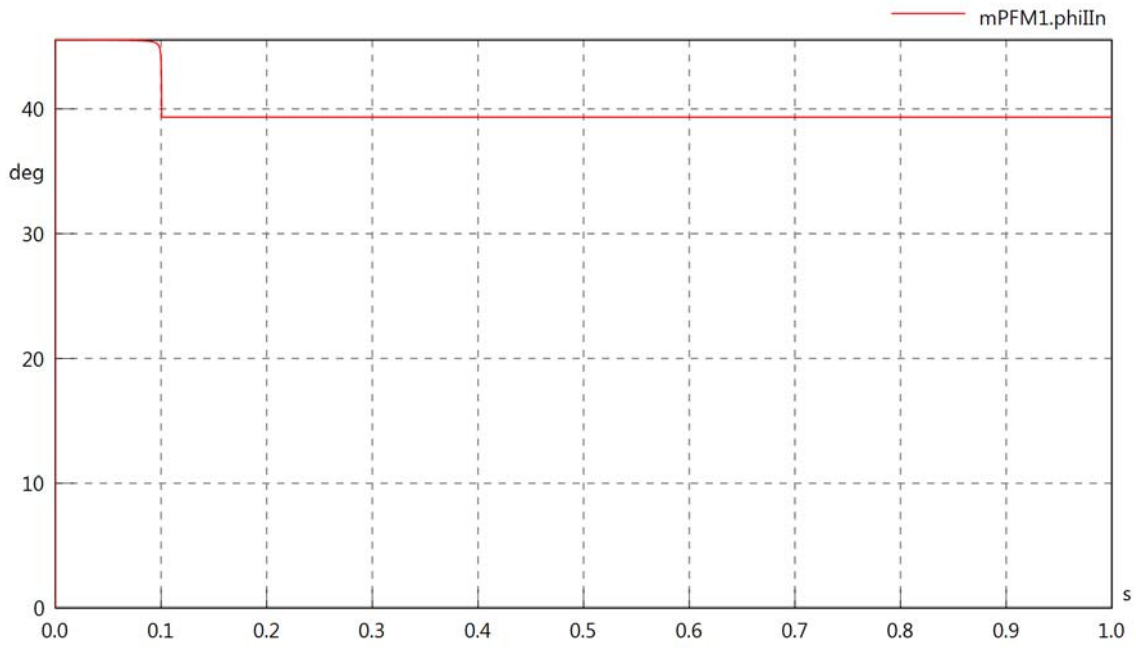

mPFM1.phiIVIn

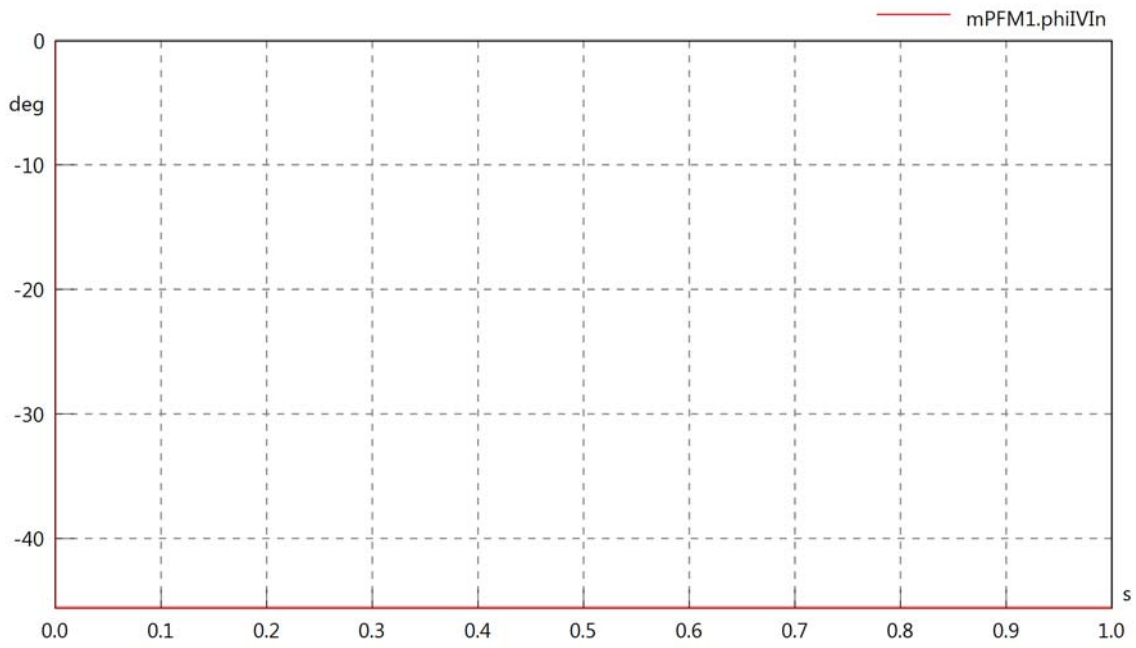

mPFM1.PReIn

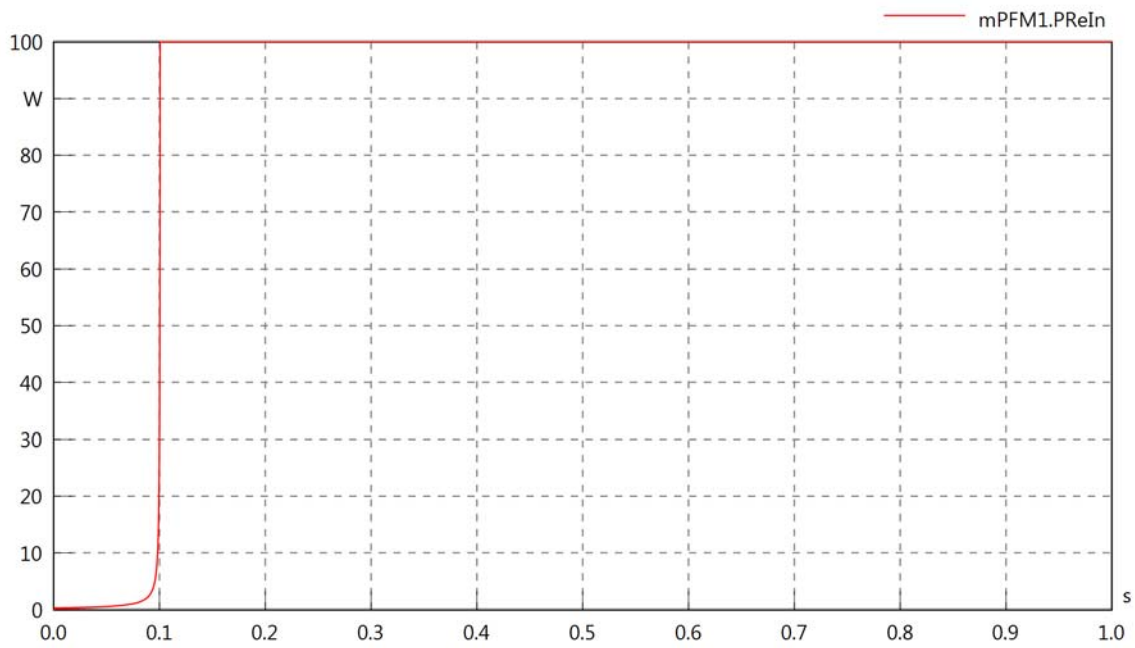

mPFM1.PImIn

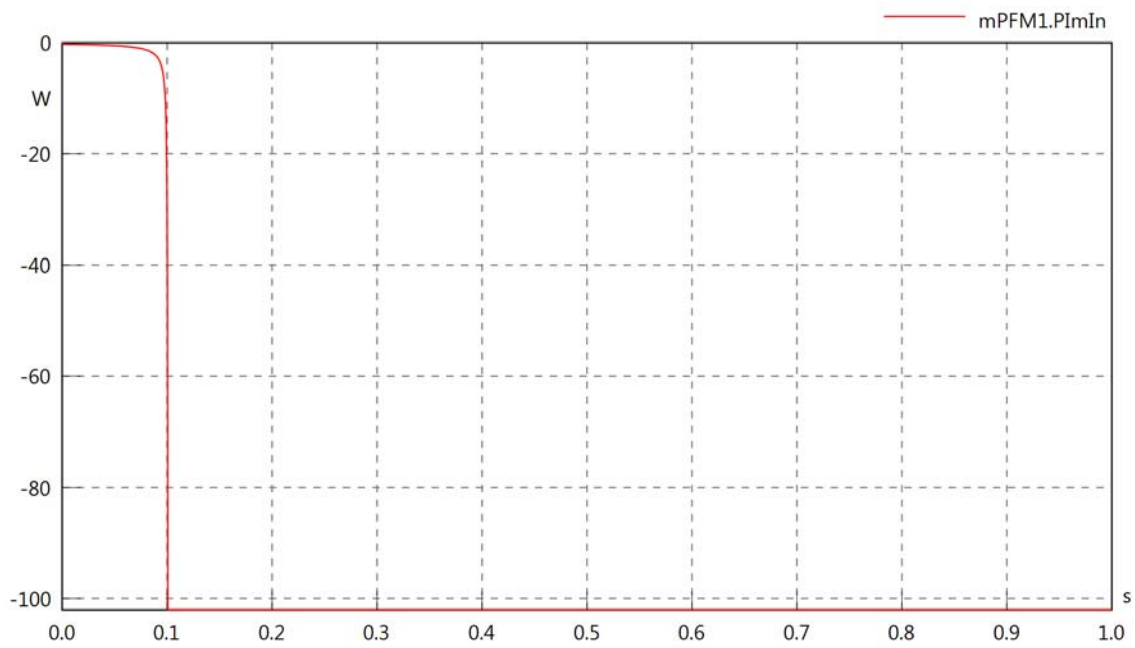

mPFM1.SIn

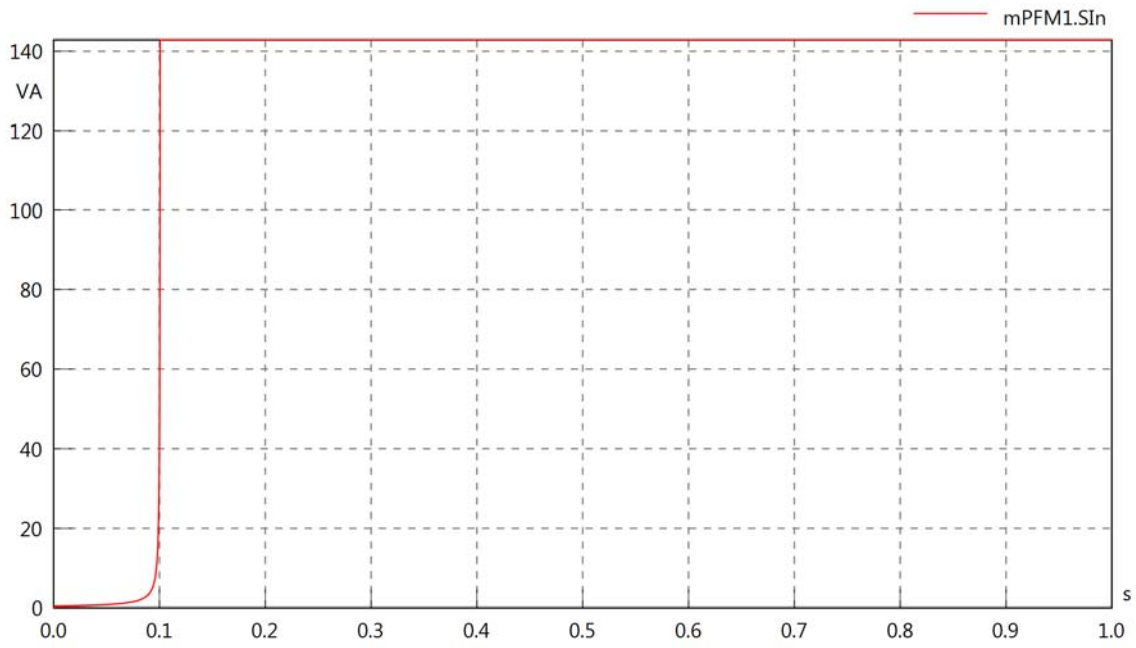

mPFM1.VrmsLoad

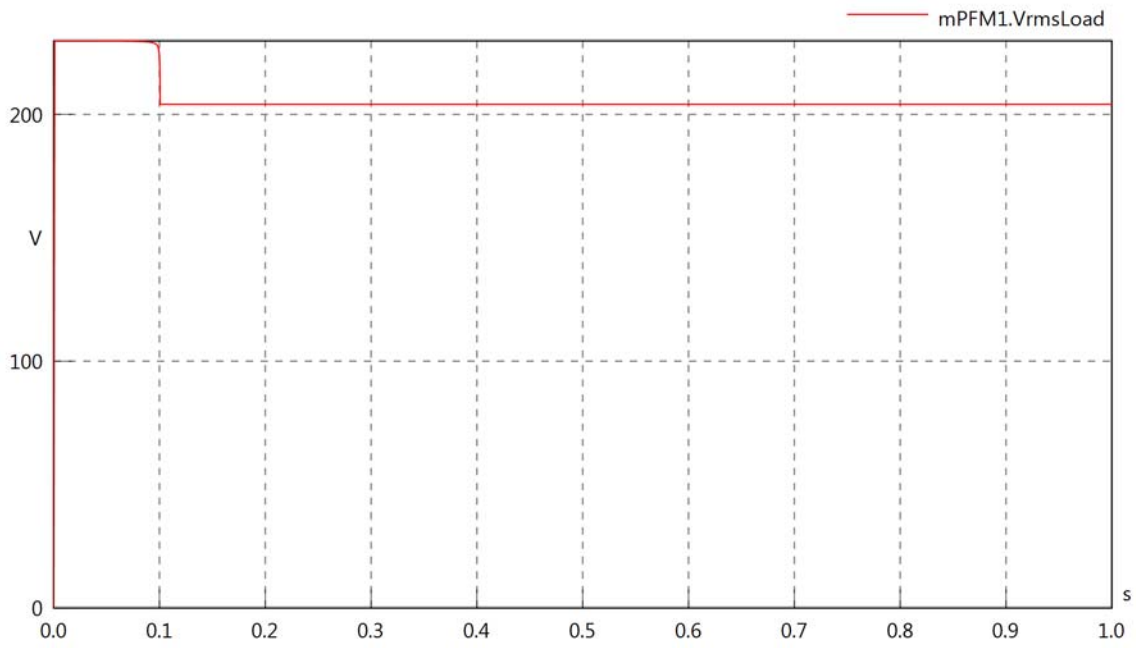

mPFM1.vReLoad

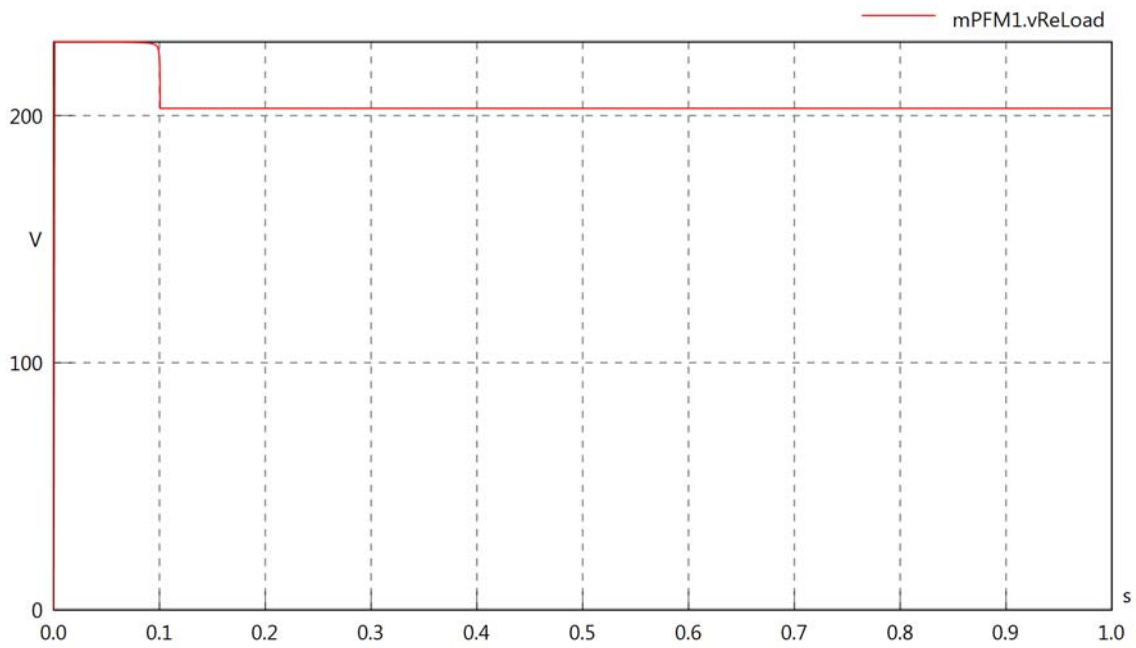

mPFM1.vImLoad

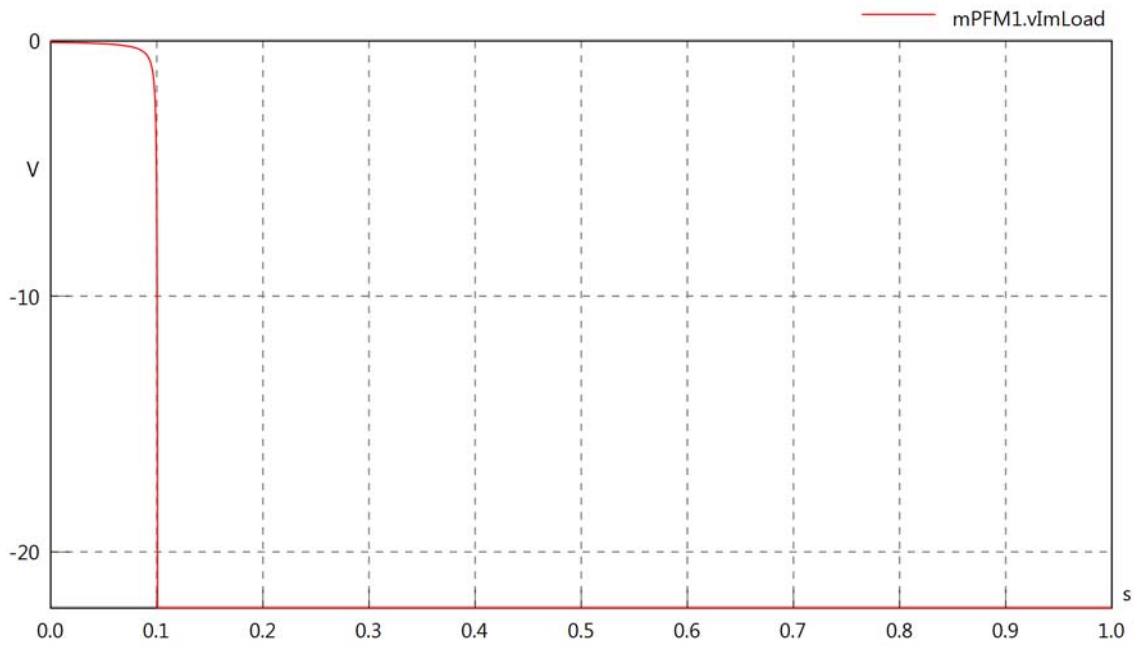

mPFM1.IrmsLoad

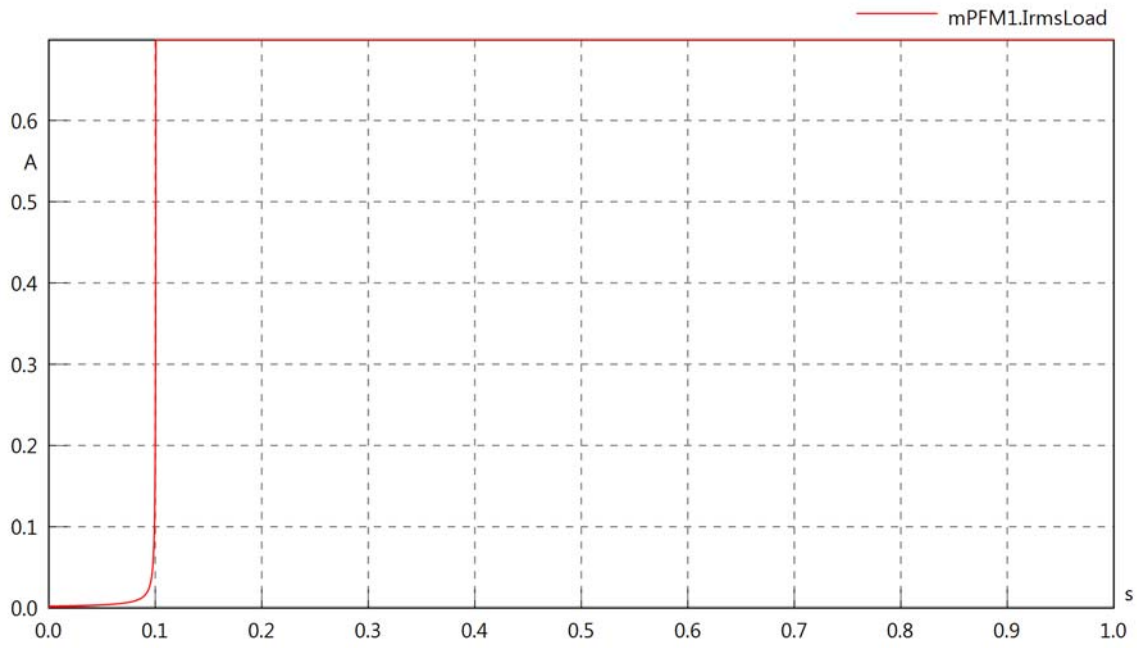

mPFM1.iReLoad

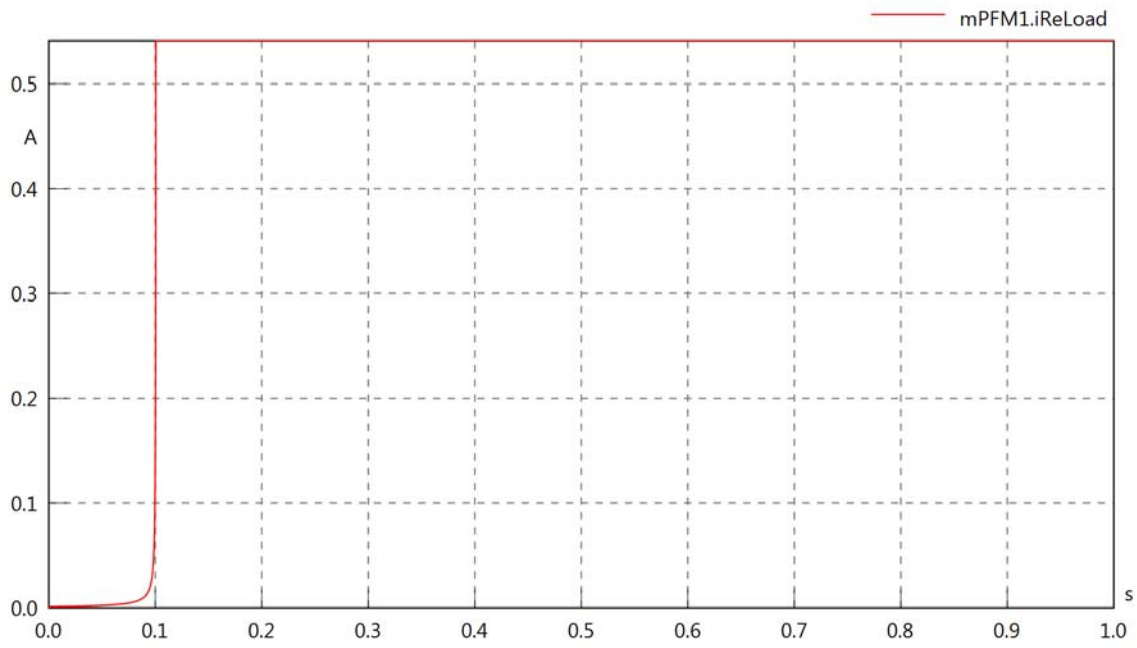

mPFM1.iImLoad

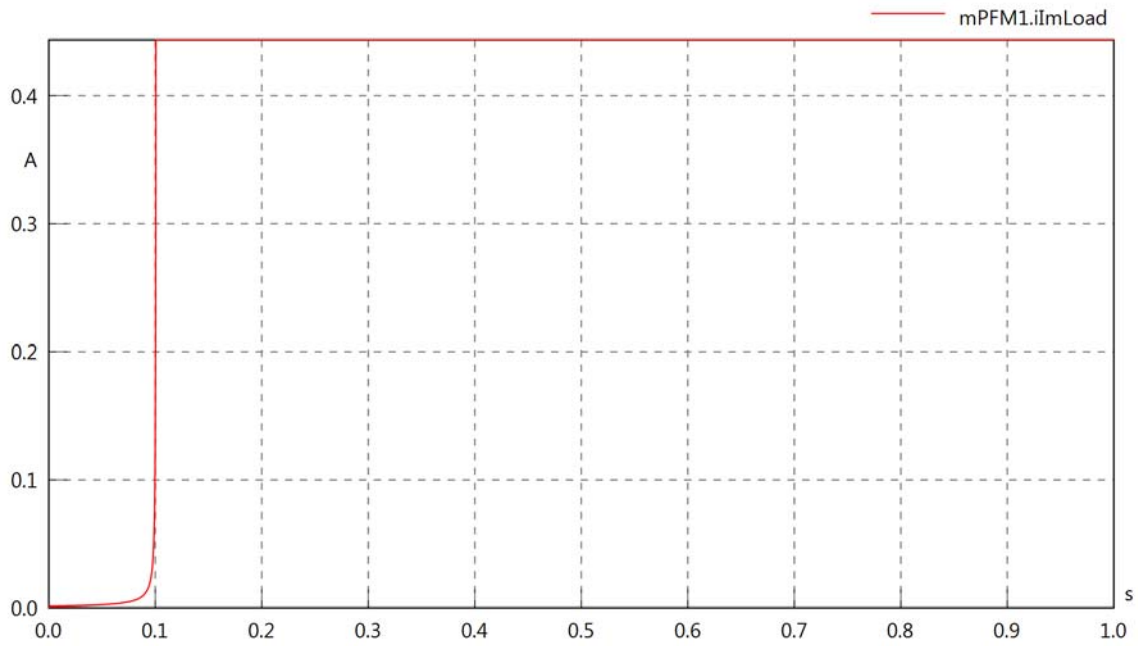

mPFM1.phiVLoad

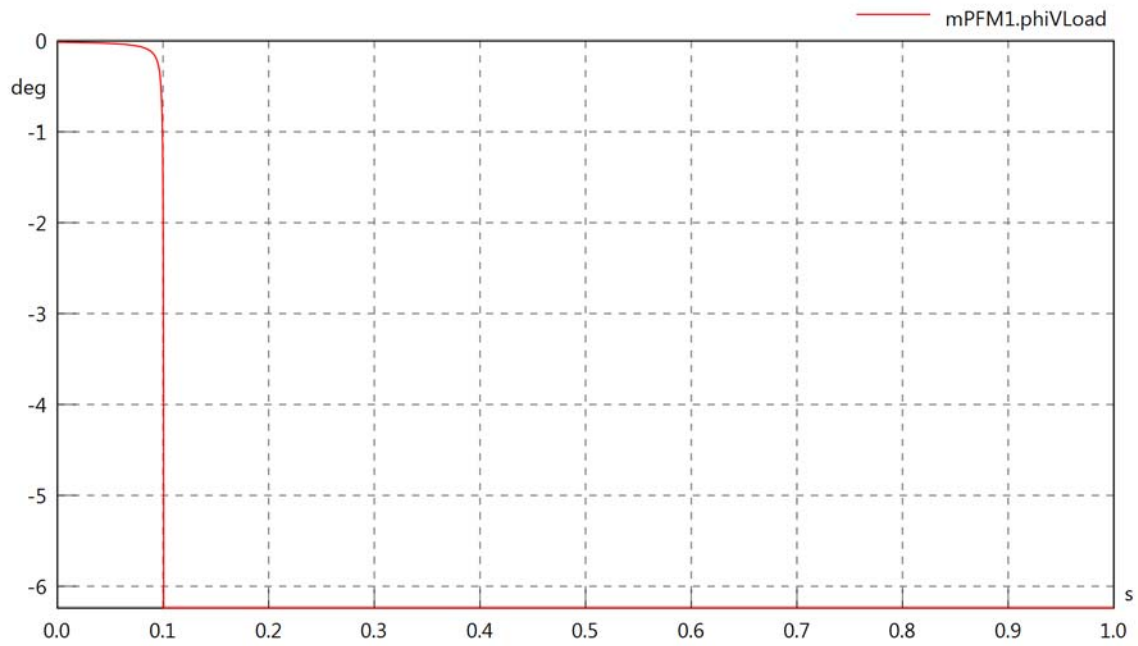

mPFM1.phiILoad

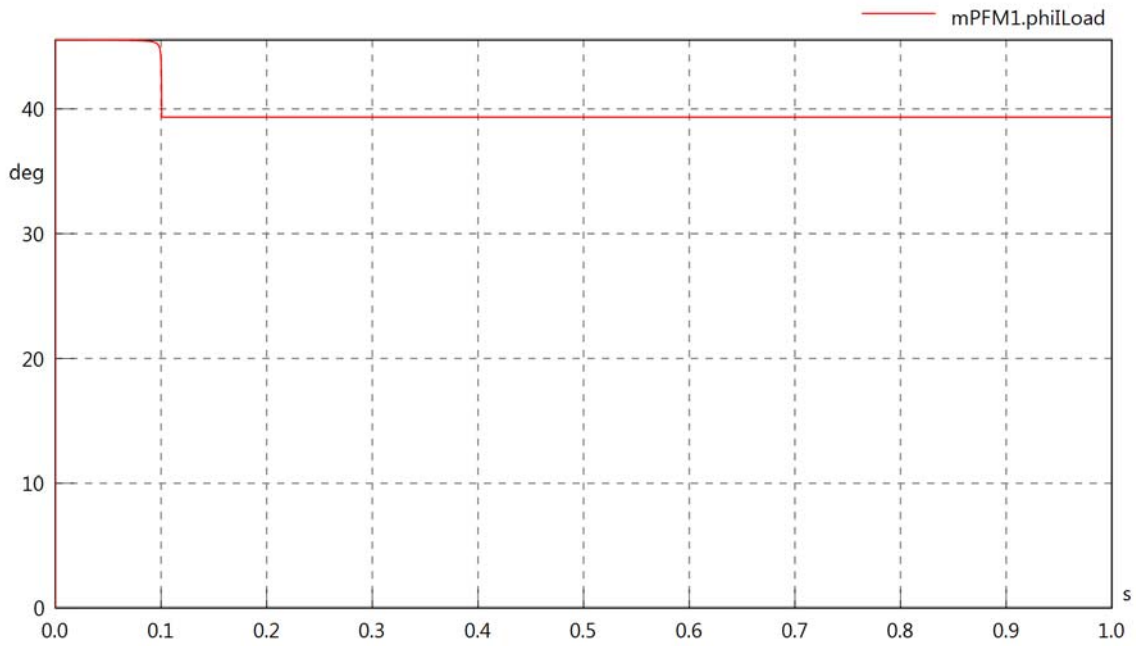

mPFM1.phiIVLoad

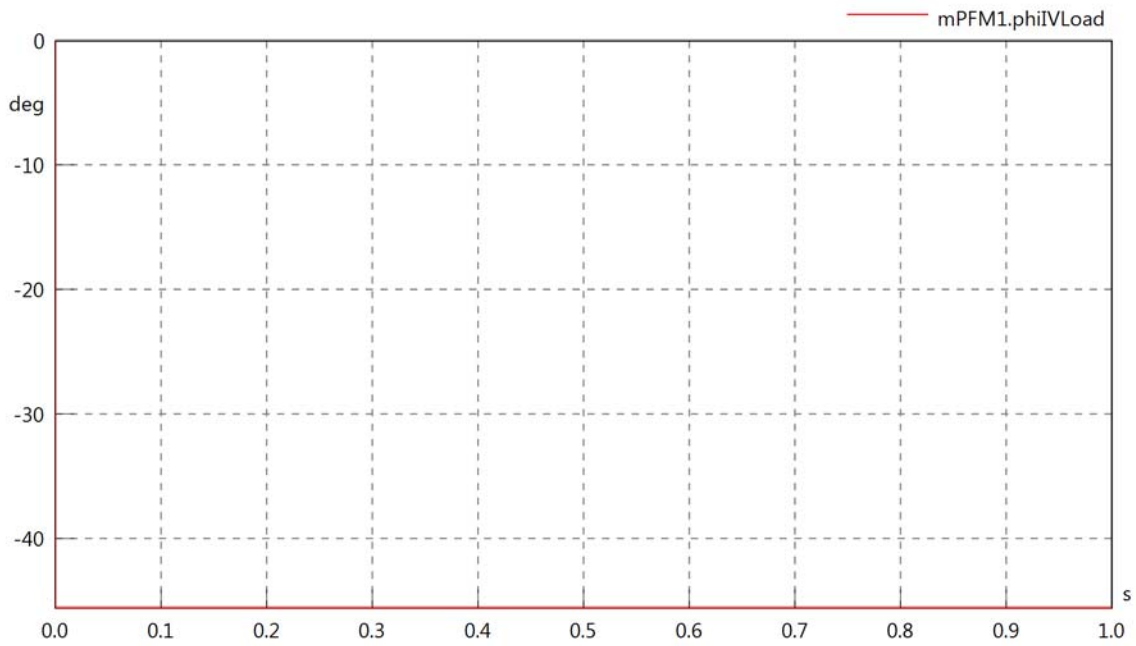

mPFM1.PReLoad

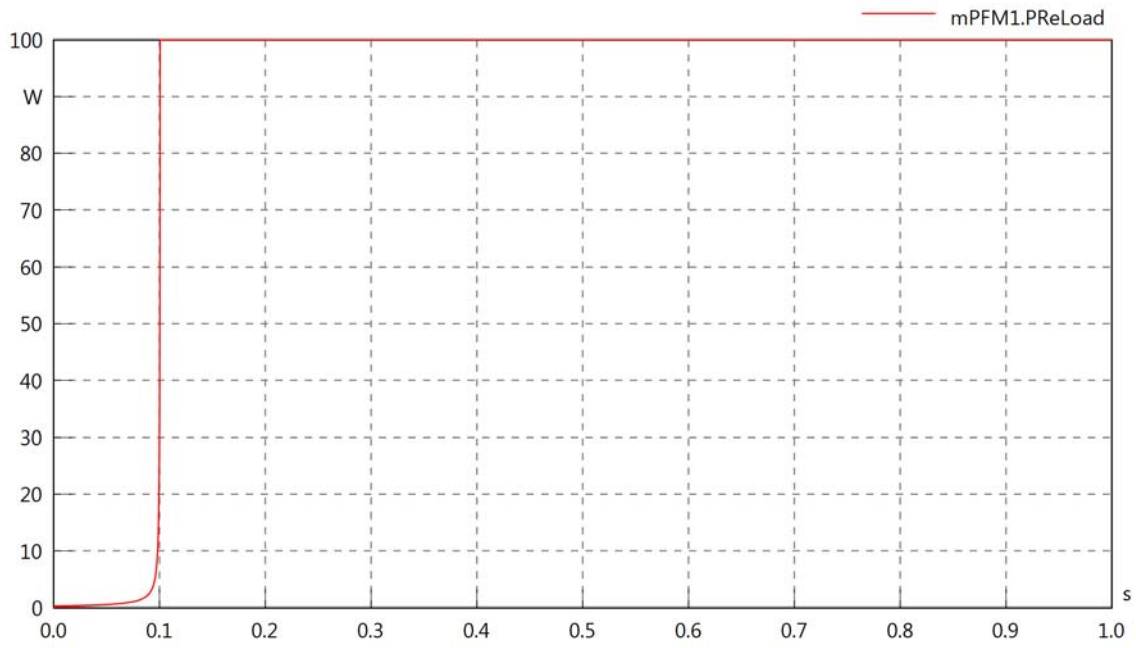

mPFM1.PImLoad

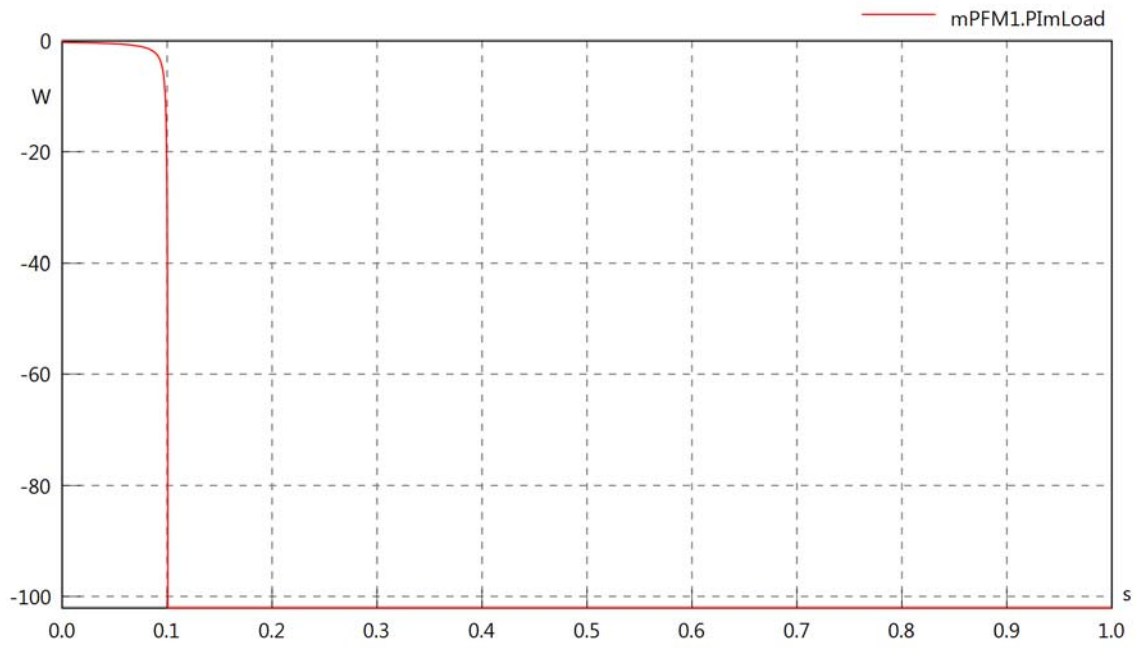

mPFM1.SLoad

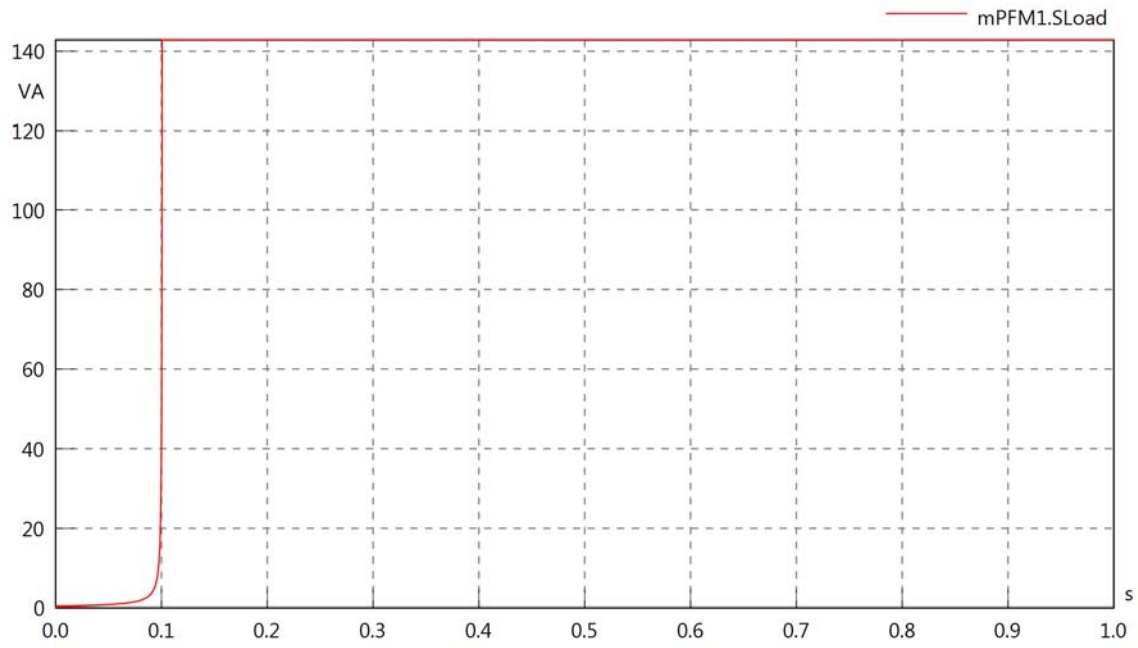
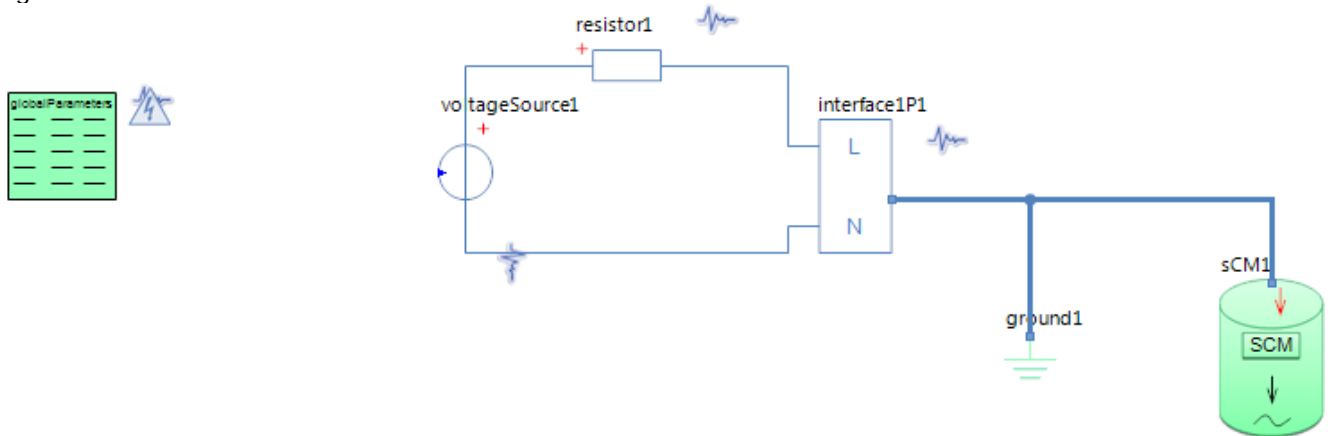

Diagram View



GlobalParameters globalParameters
Parameters

Comment	Name	Current Value	Unit
Type of Calculation	eCalculationKind	Signal Calculation	
Description of Frequency	eFrequencyKind	Linear	
Minimum Frequency	fMin	60	[Hz]
Maximum Frequency	fMax	60	[Hz]

Resistor resistor1
Parameters

Comment	Name	Current Value	Unit
Resistance	R	50	[Ohm]

Voltage Source voltageSource1
Parameters

Comment	Name	Current Value	Unit
Voltage RMS	VrmsSrc	$\min(230, 230000 \cdot t)$	[V]
Phase	phi	0	[deg]

Subsea Control Module sCM1
Parameters

Comment	Name	Current Value	Unit
EPU or Modem sending on system	sType	EPU sending	
Simulate with internal Transformer	trafoOn	false	
Constant or Variable Power	pType	Constant Power	
Output Power from PSU in SCM	P	100	[VA]
PSU Power Factor	pf	0.7	[-]
PSU turn-off RMS Voltage	vMin	130	[V]
PSU turn-on RMS Voltage	vMax	180	[V]

sCM1.Rload

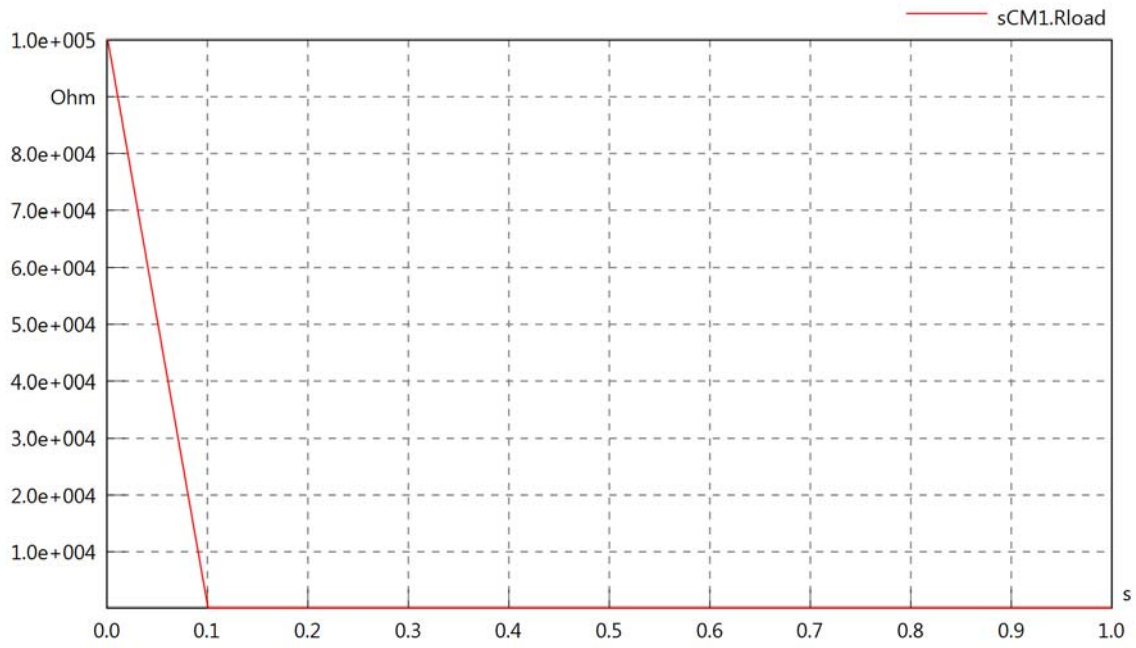

sCM1.Cload

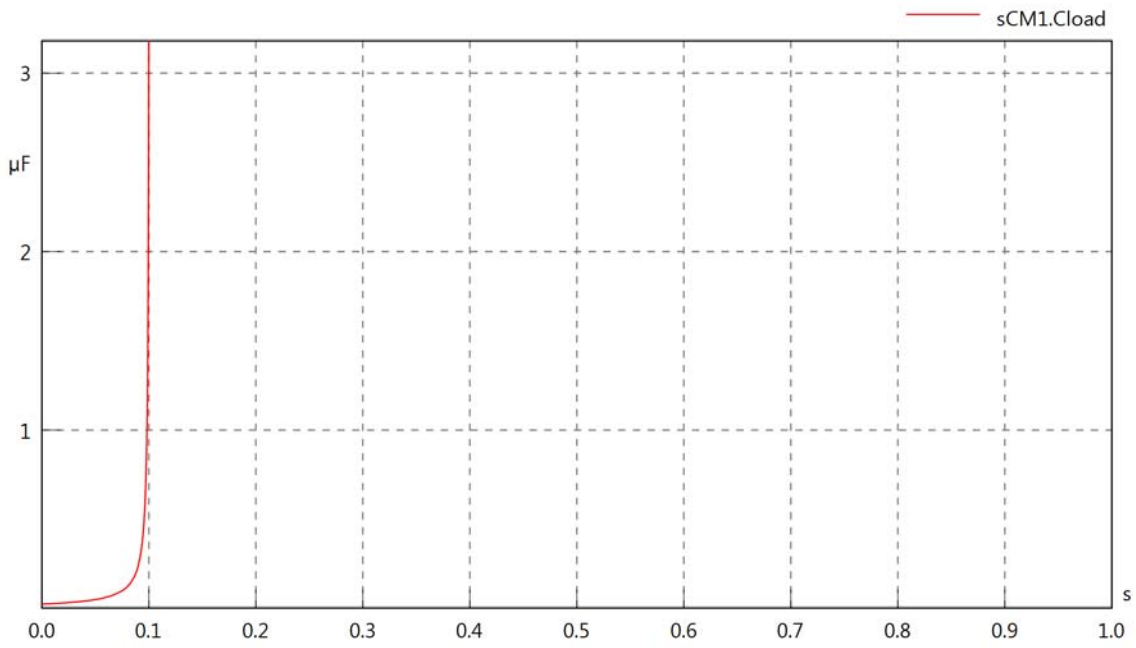

sCM1.PsetX2

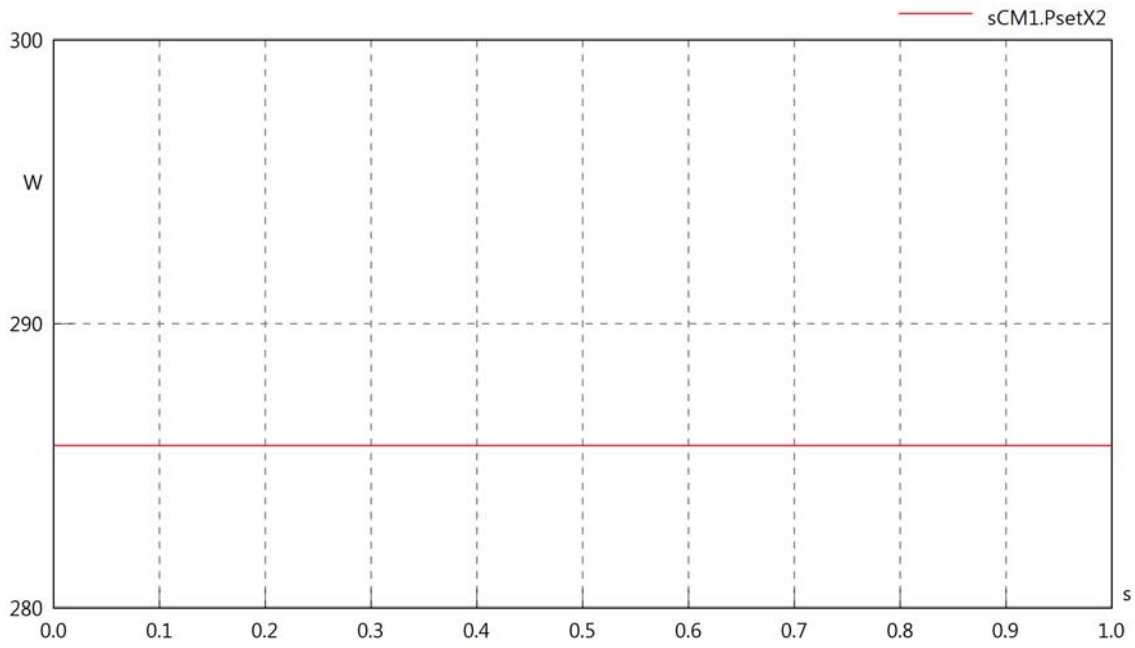

sCM1.Pset

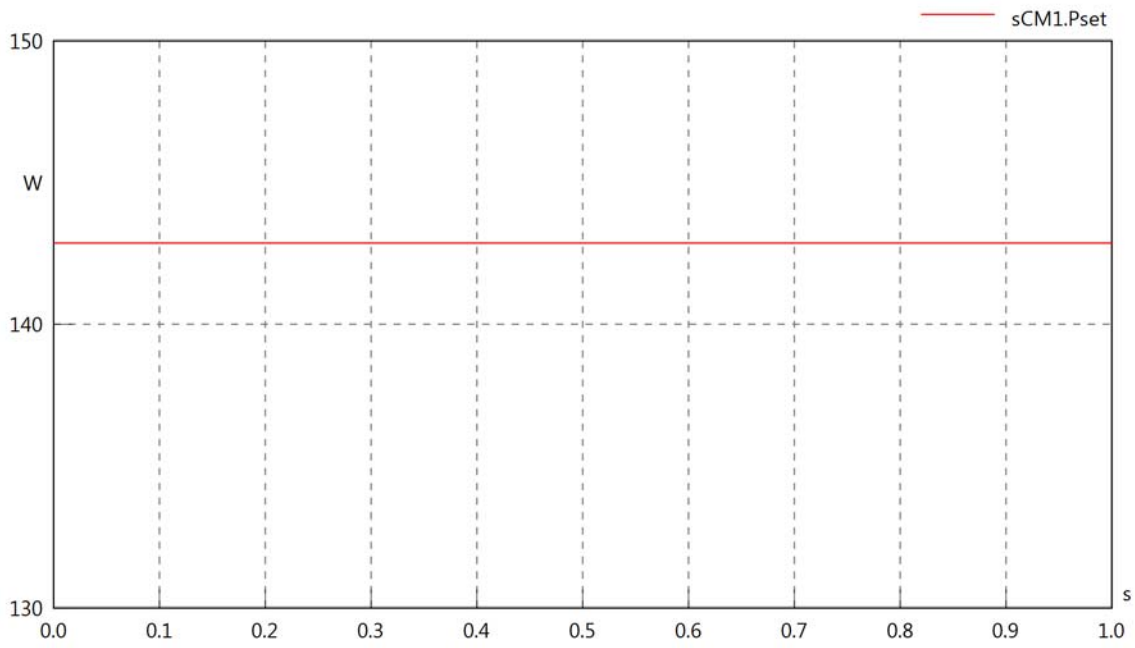

sCM1.PCalc

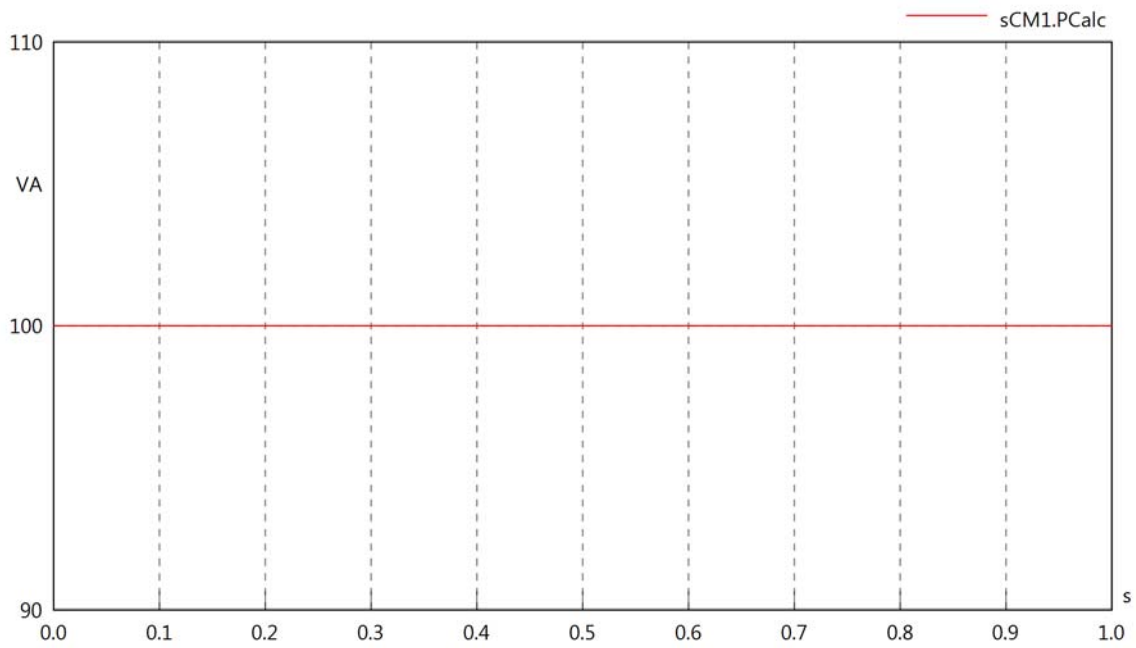

sCM1.VrmsIn

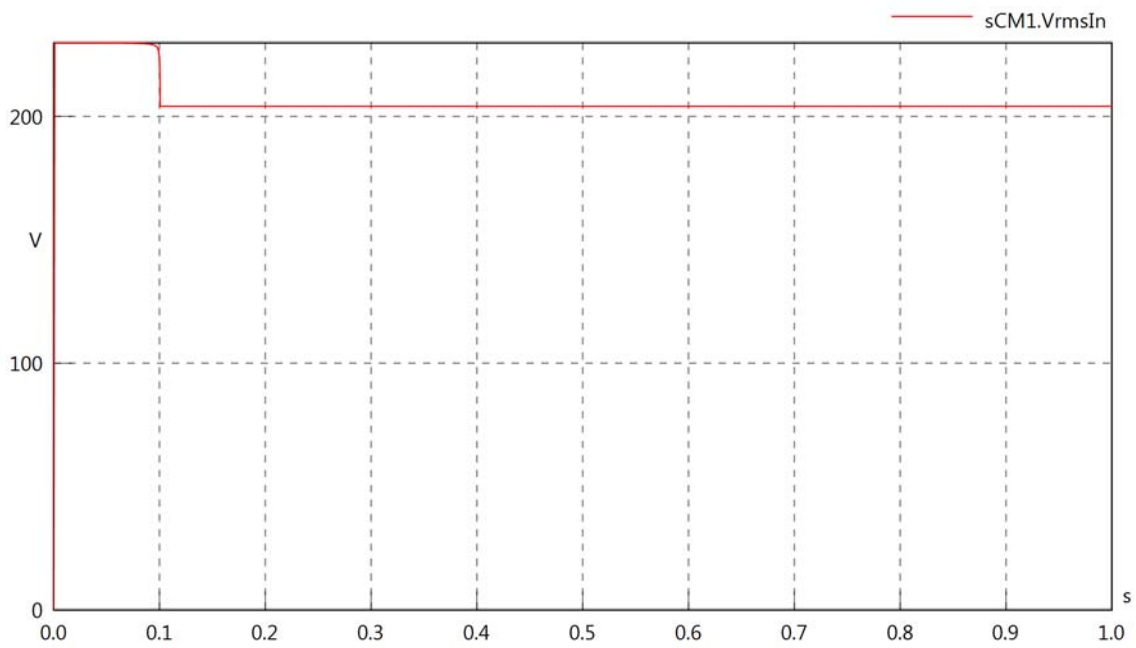

sCM1.vReIn

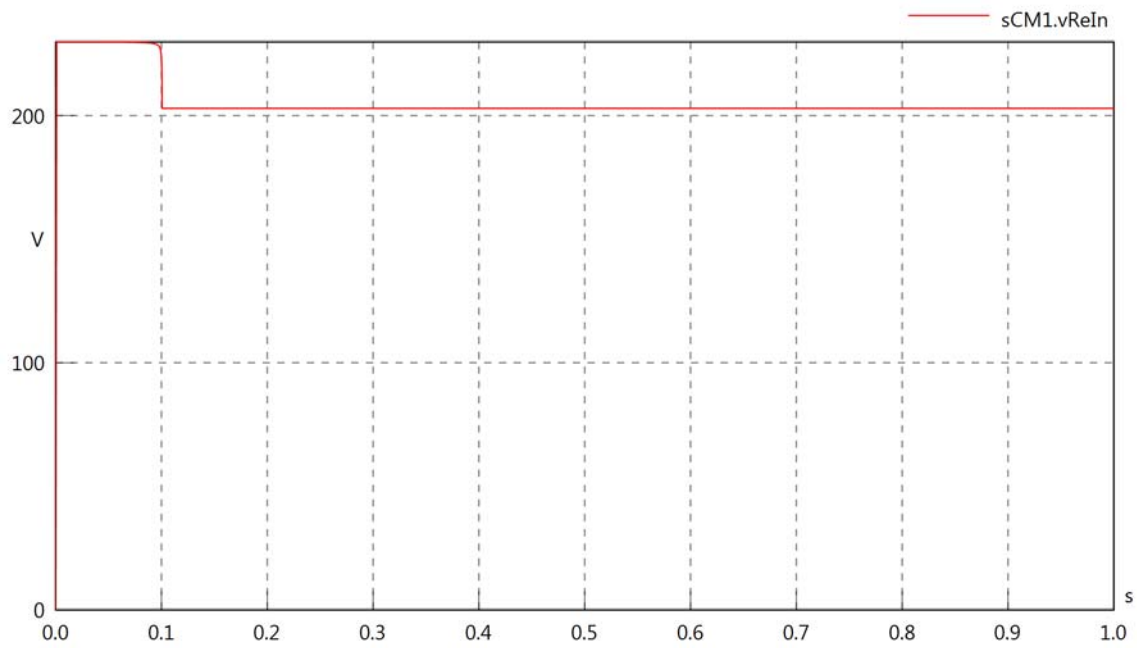

sCM1.vImIn

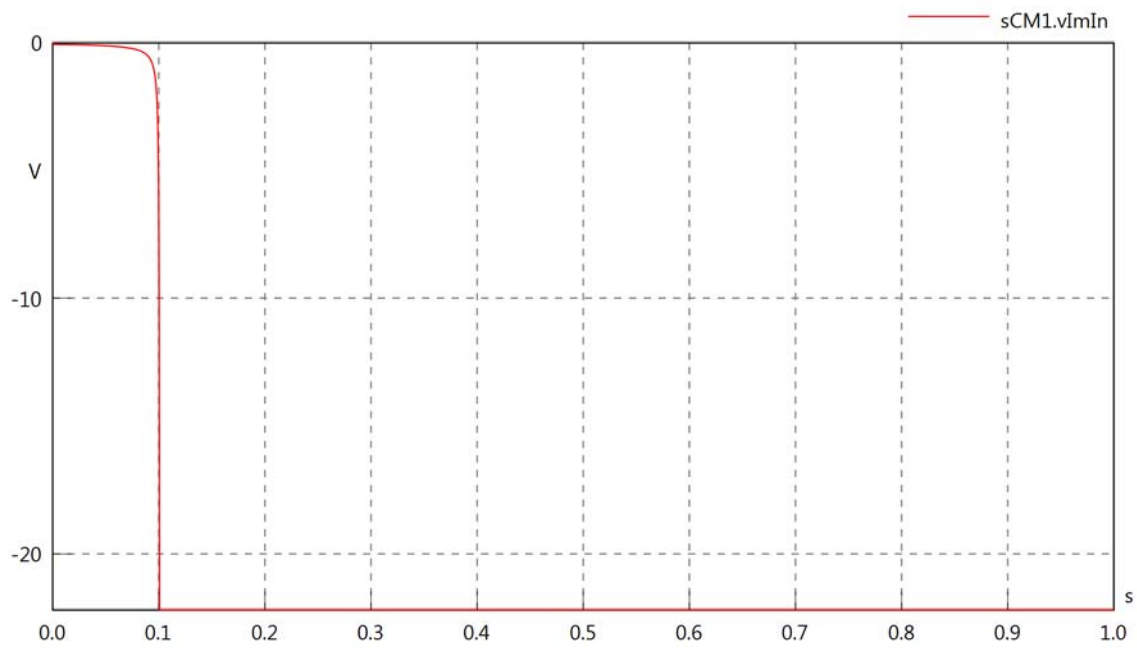

sCM1.IrmsIn

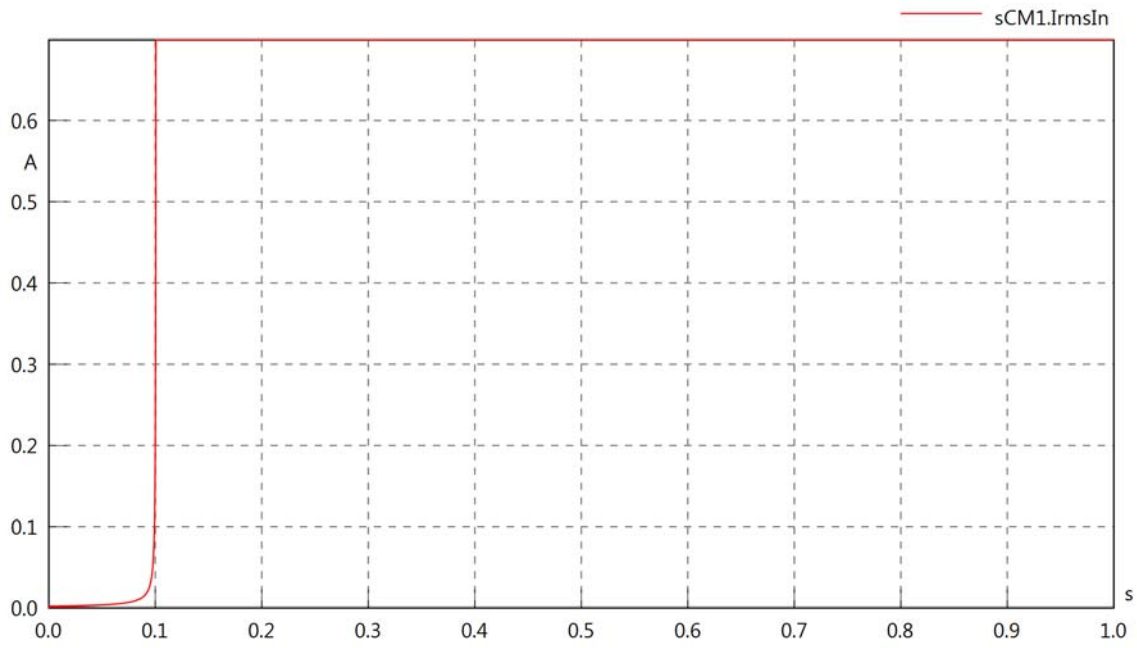

sCM1.iReIn

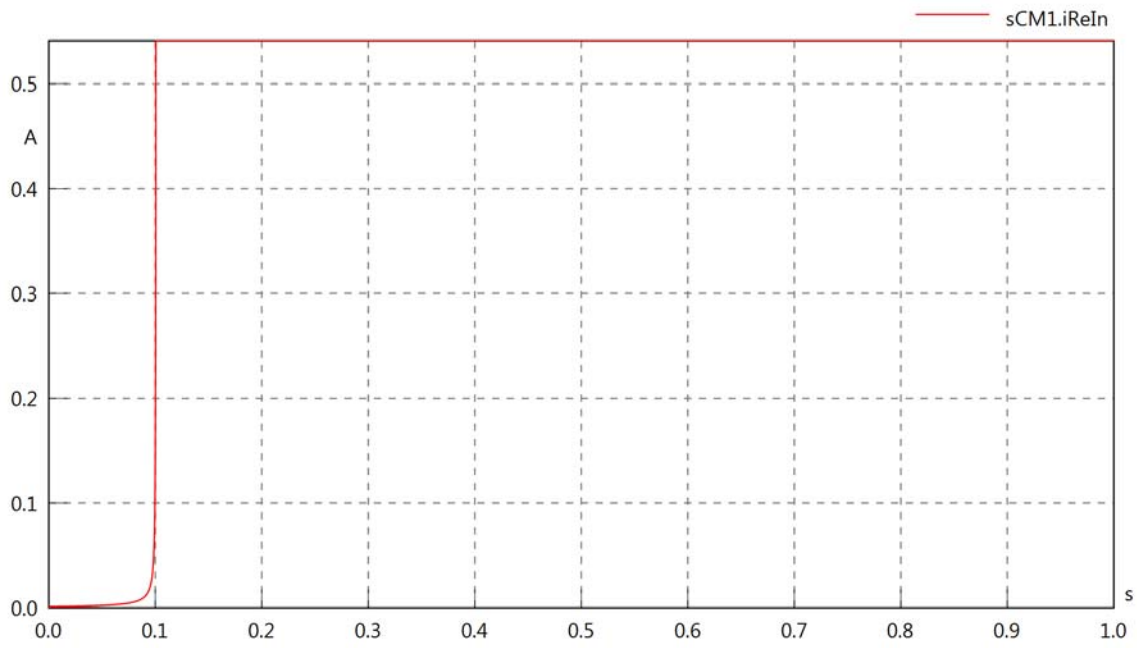

sCM1.ilmIn

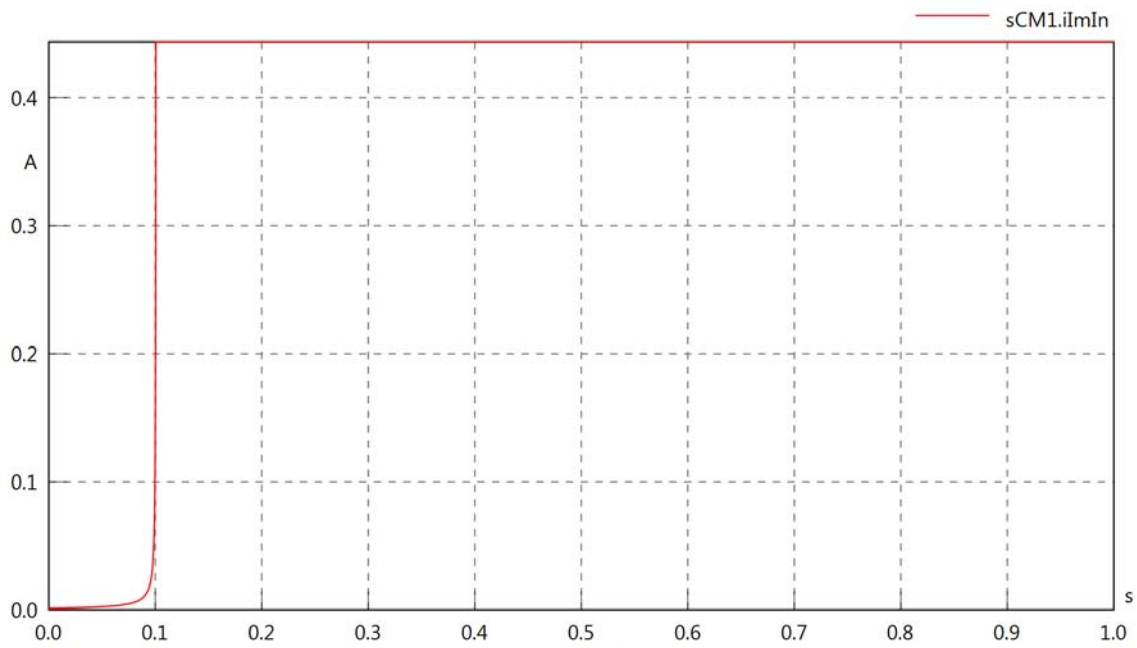

sCM1.phiVIn

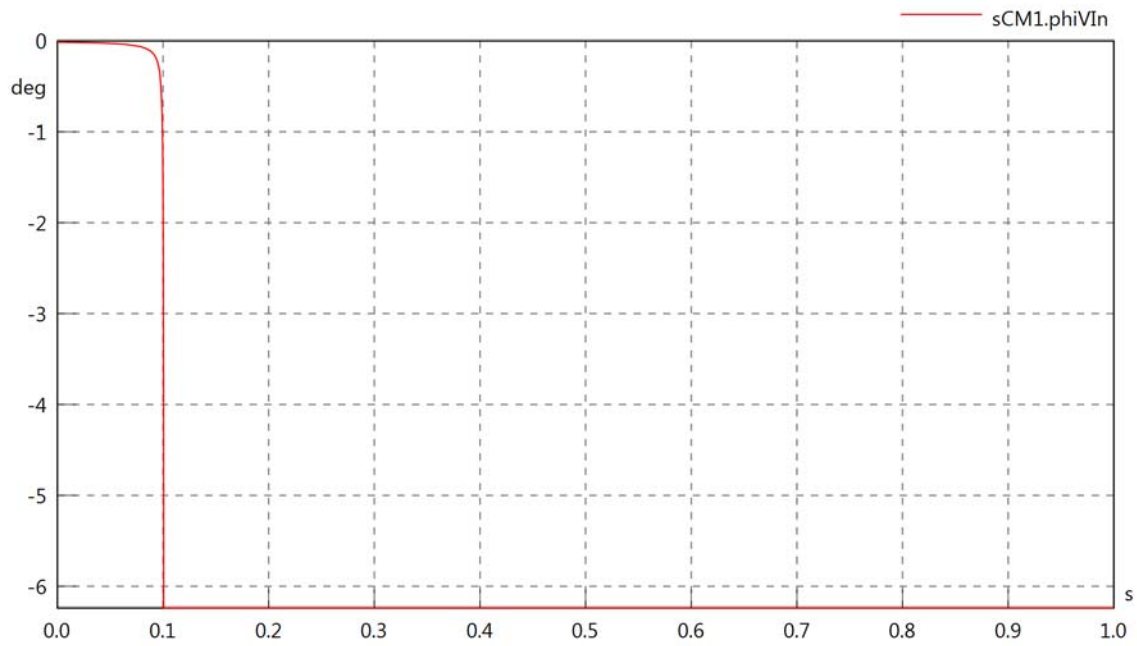

sCM1.philIn

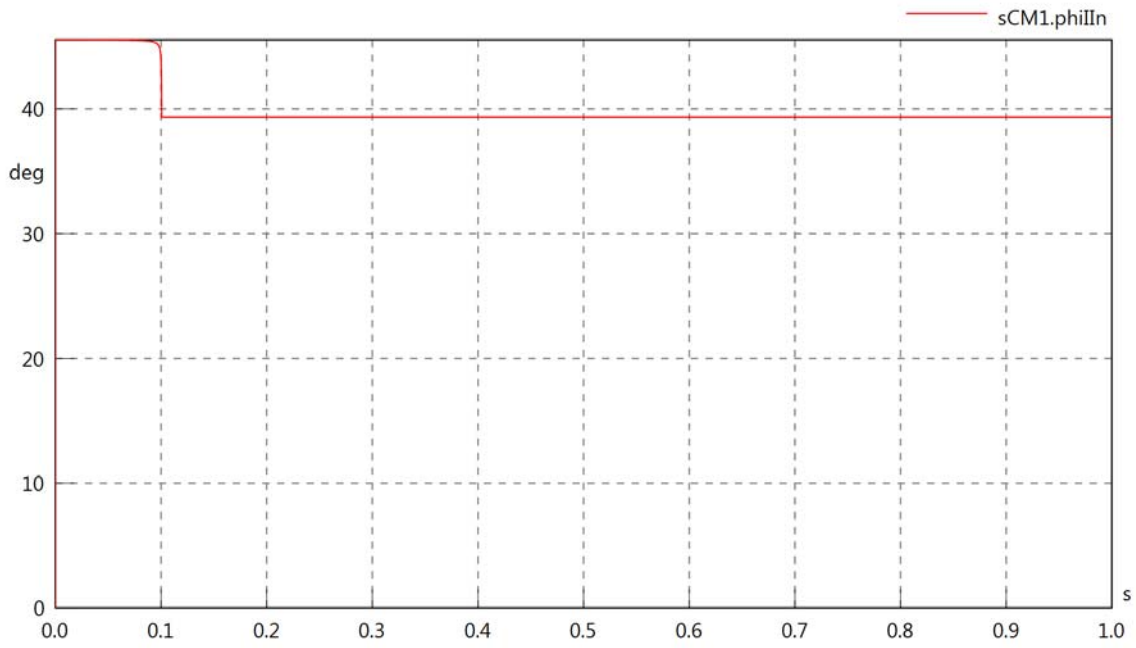

sCM1.philVIn

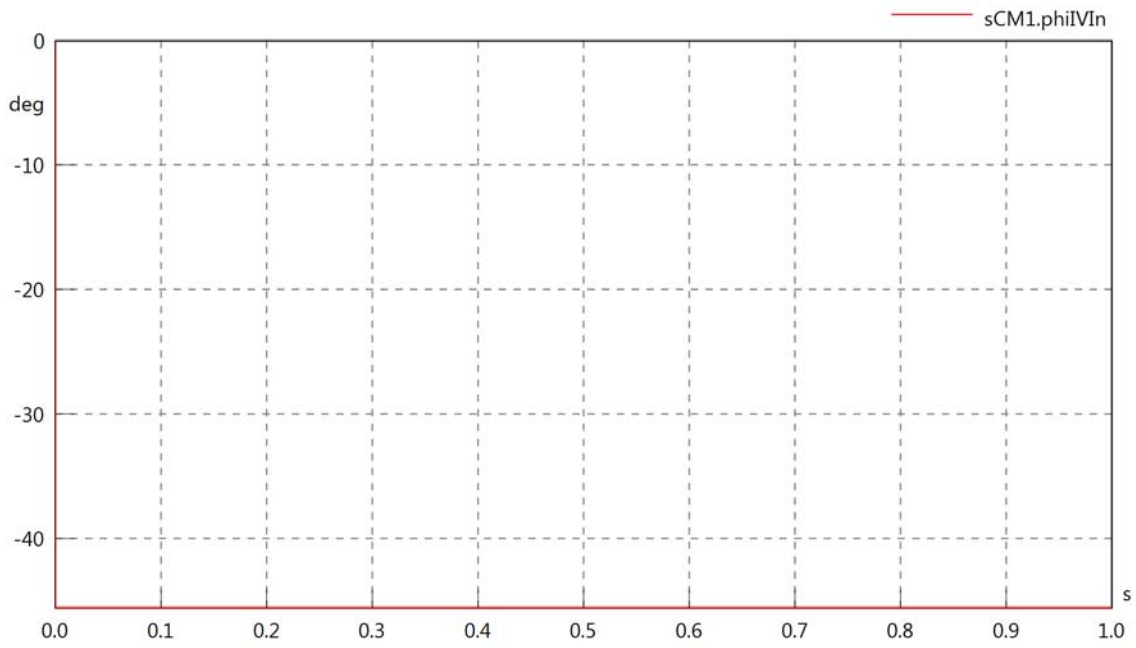

sCM1.PReIn

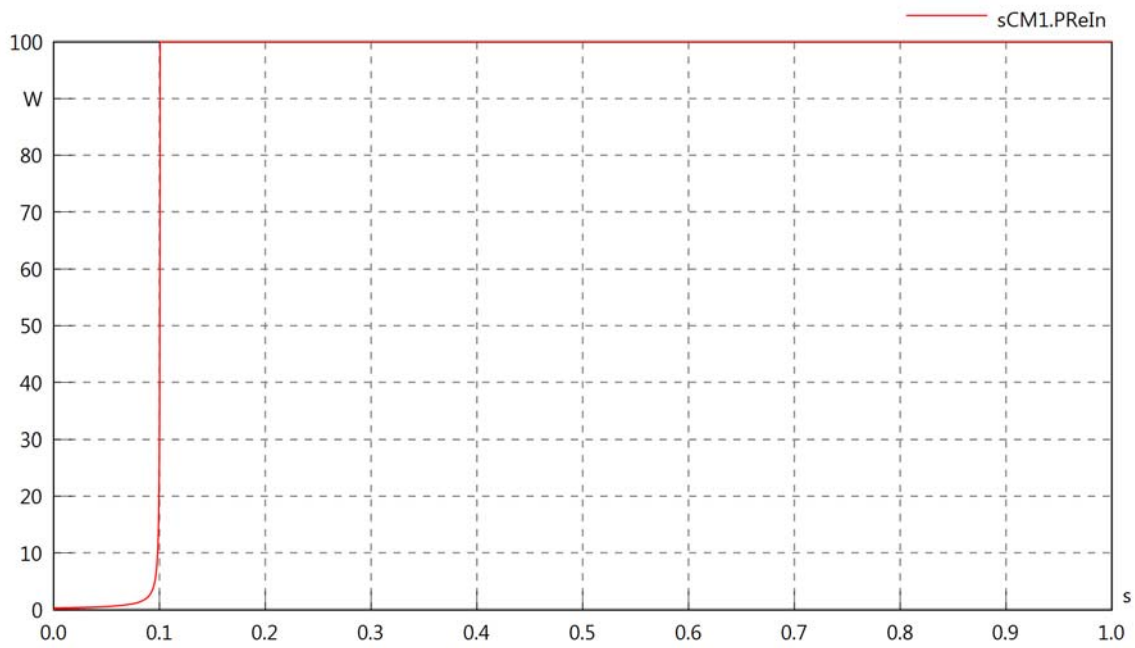

sCM1.PImIn

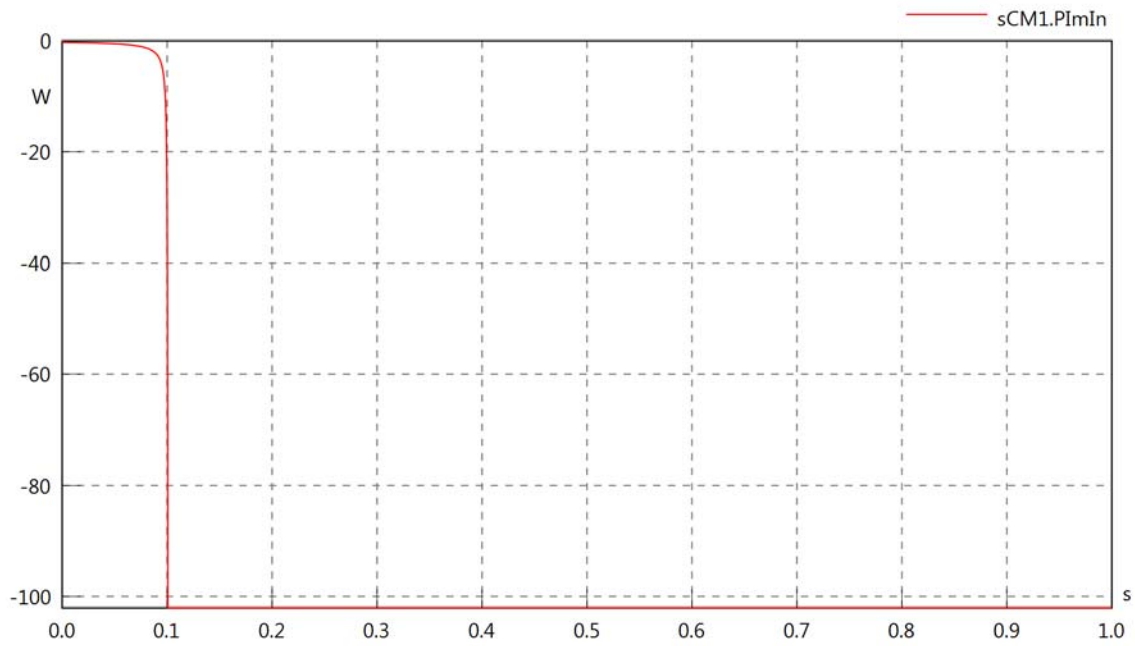

sCM1.SIn

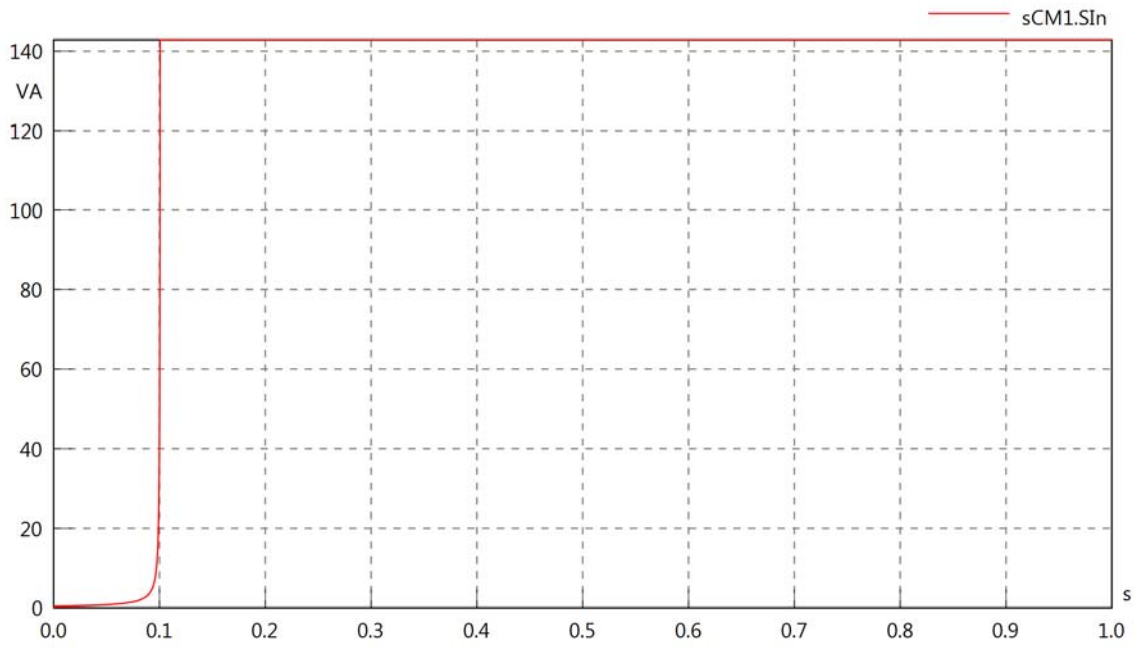

sCM1.VrmsLoad

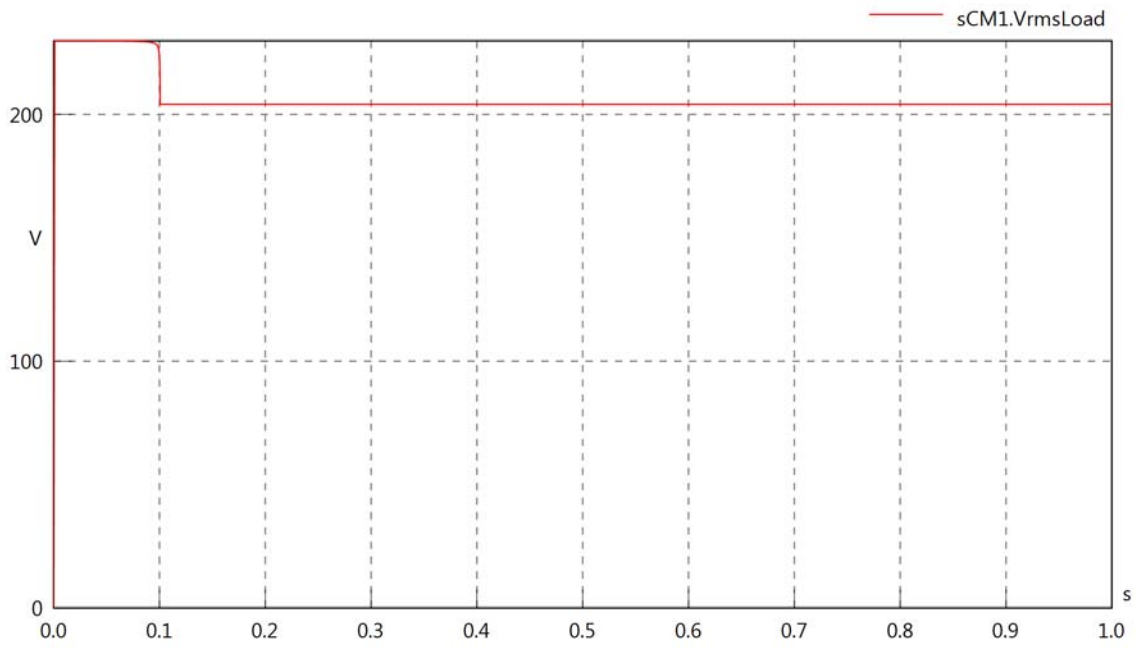

sCM1.vReLoad

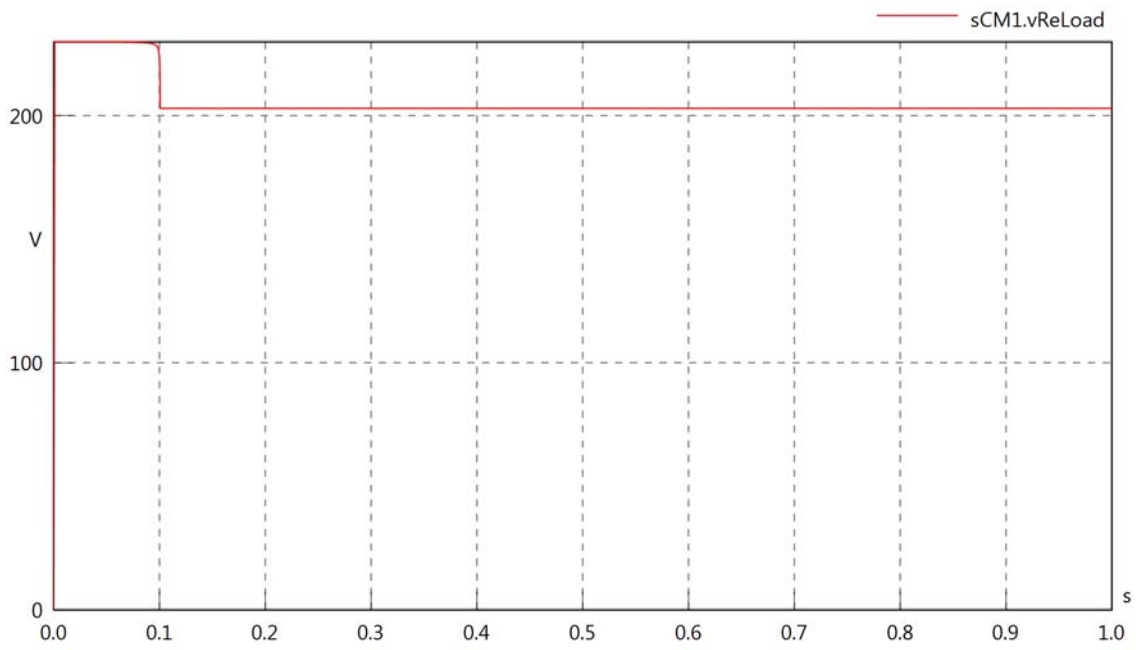

sCM1.vImLoad

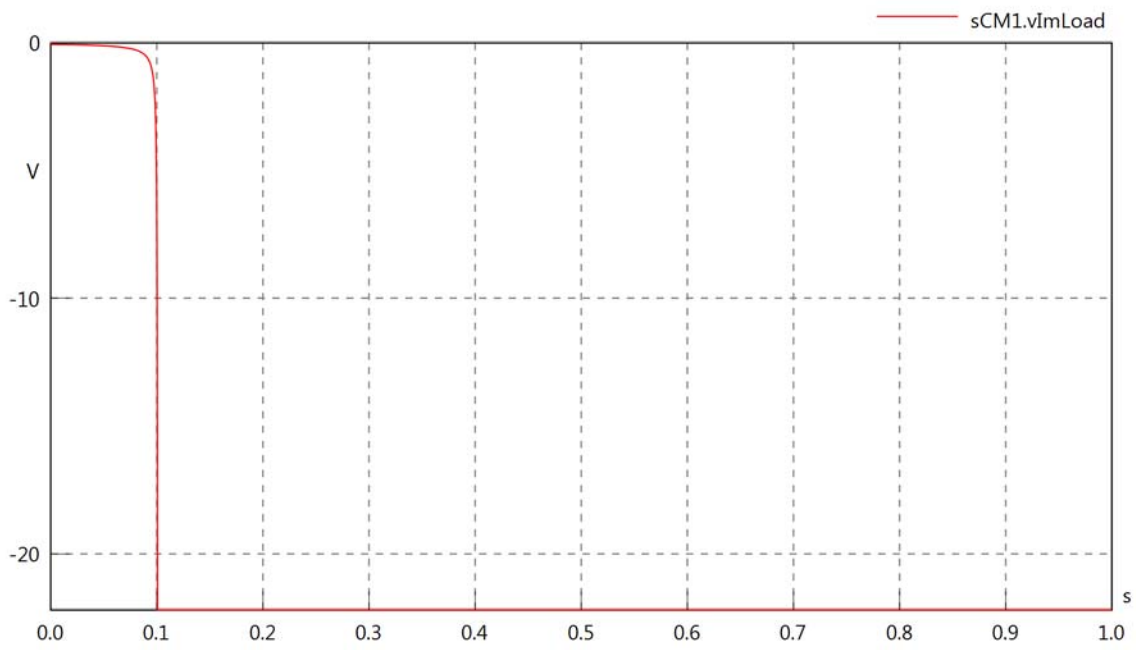

sCM1.IrmsLoad

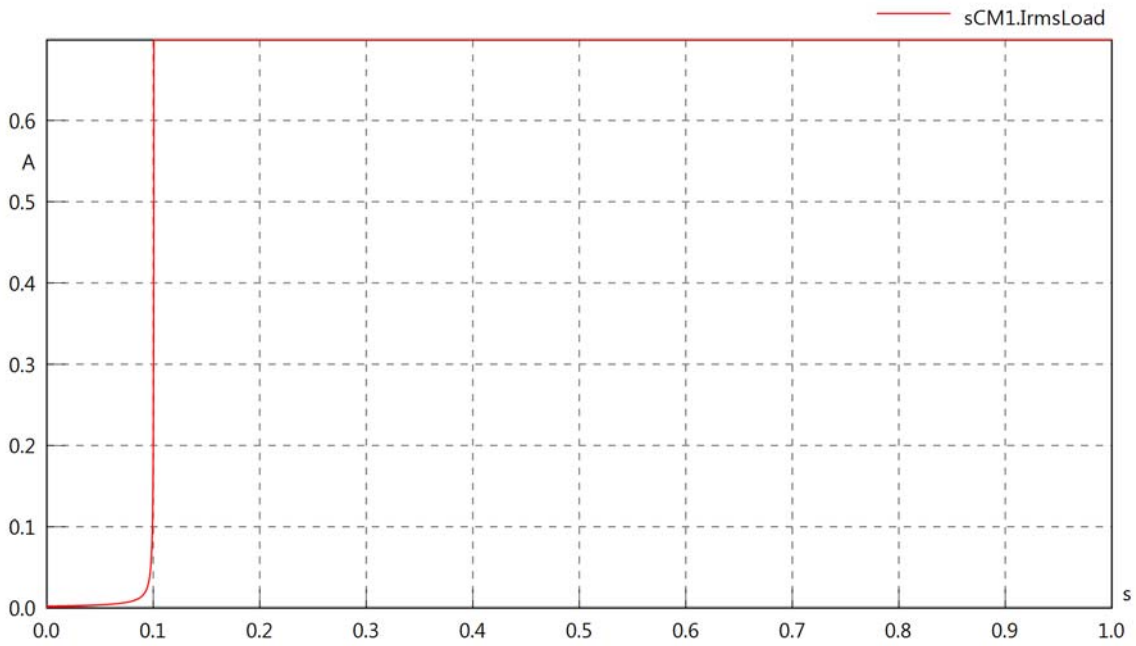

sCM1.iReLoad

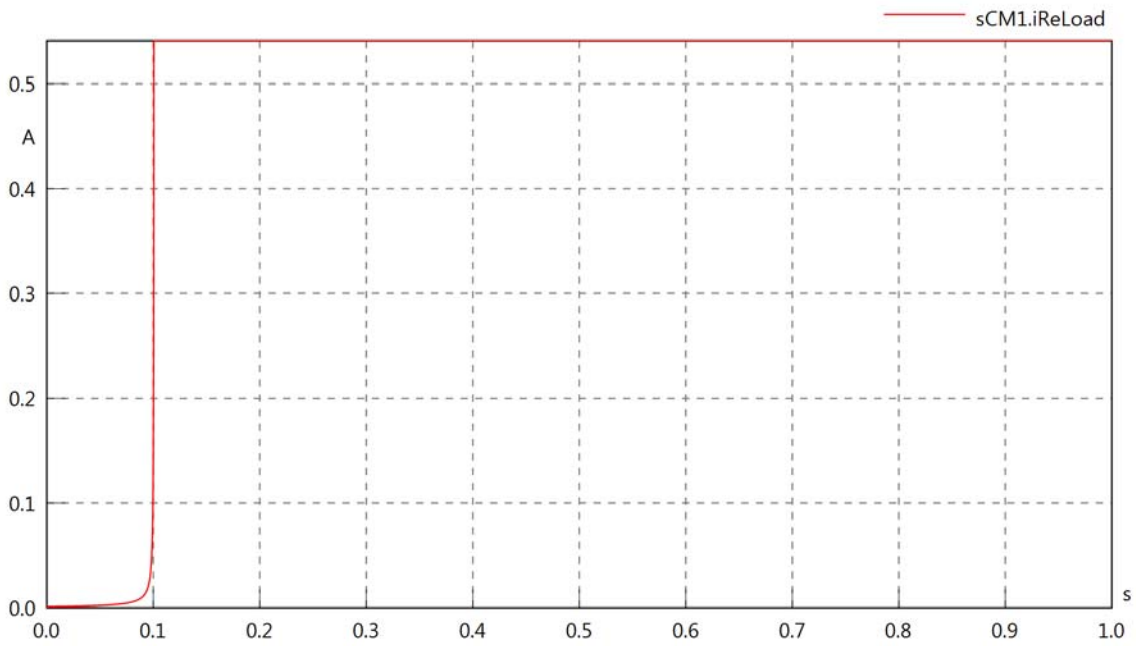

sCM1.iImLoad

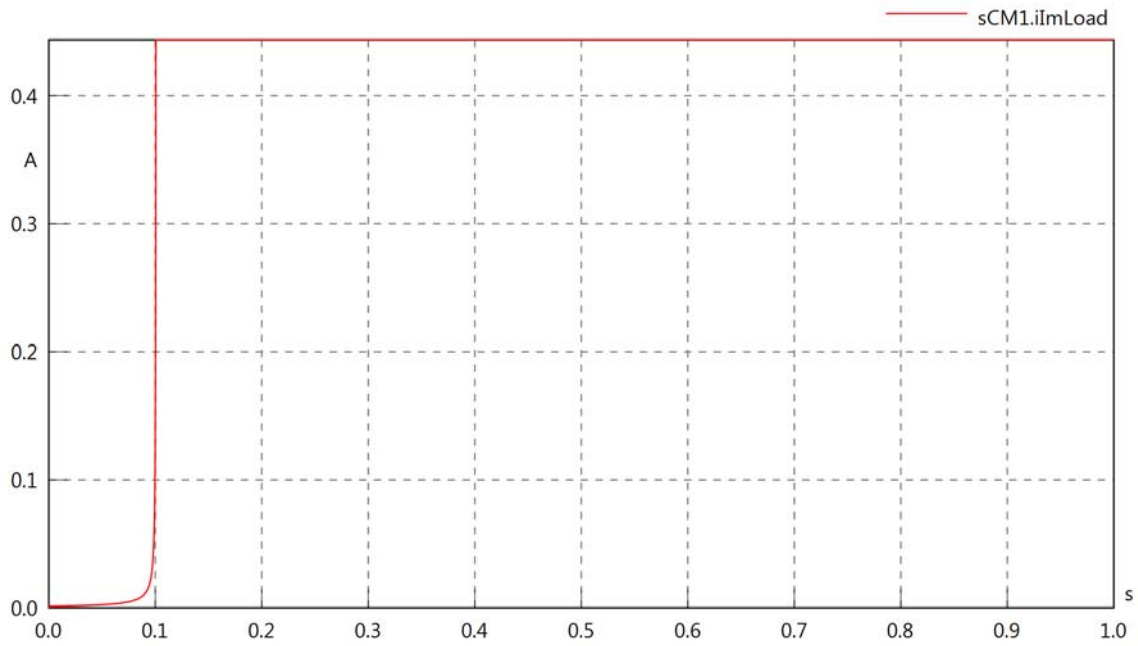

sCM1.phiVLoad

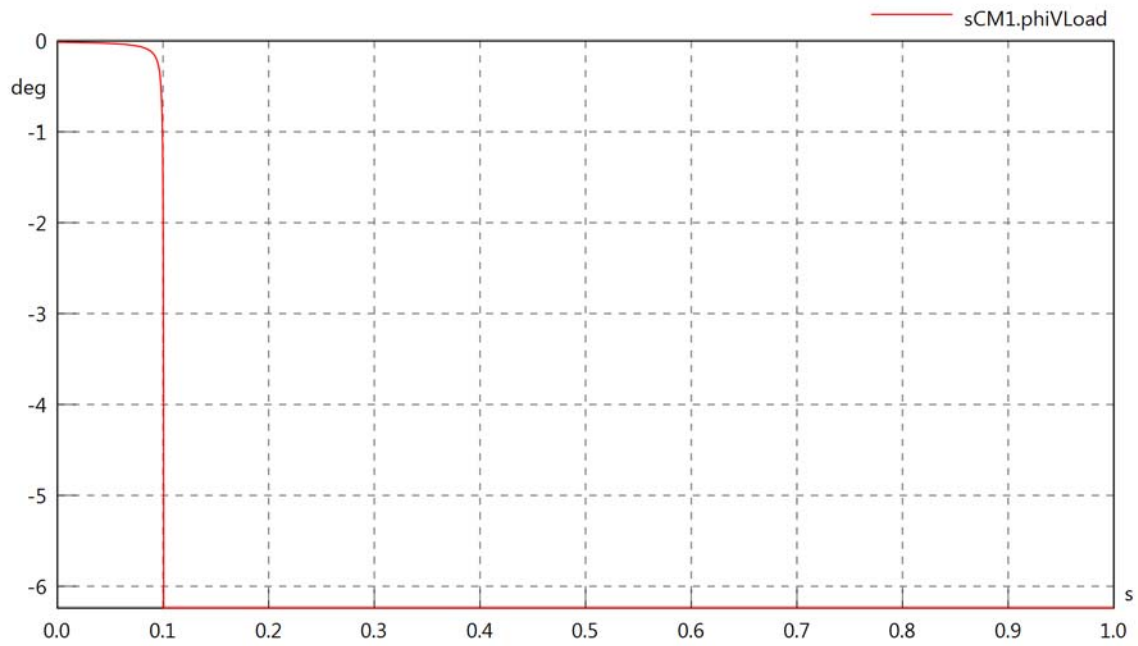

sCM1.philLoad

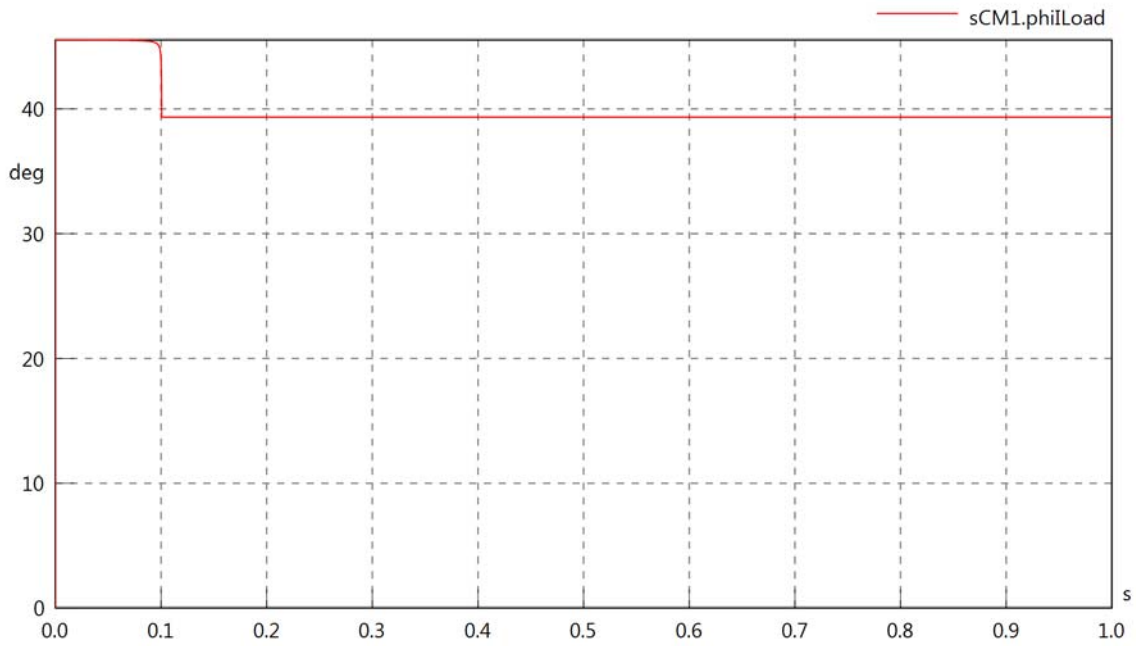

sCM1.philVLoad

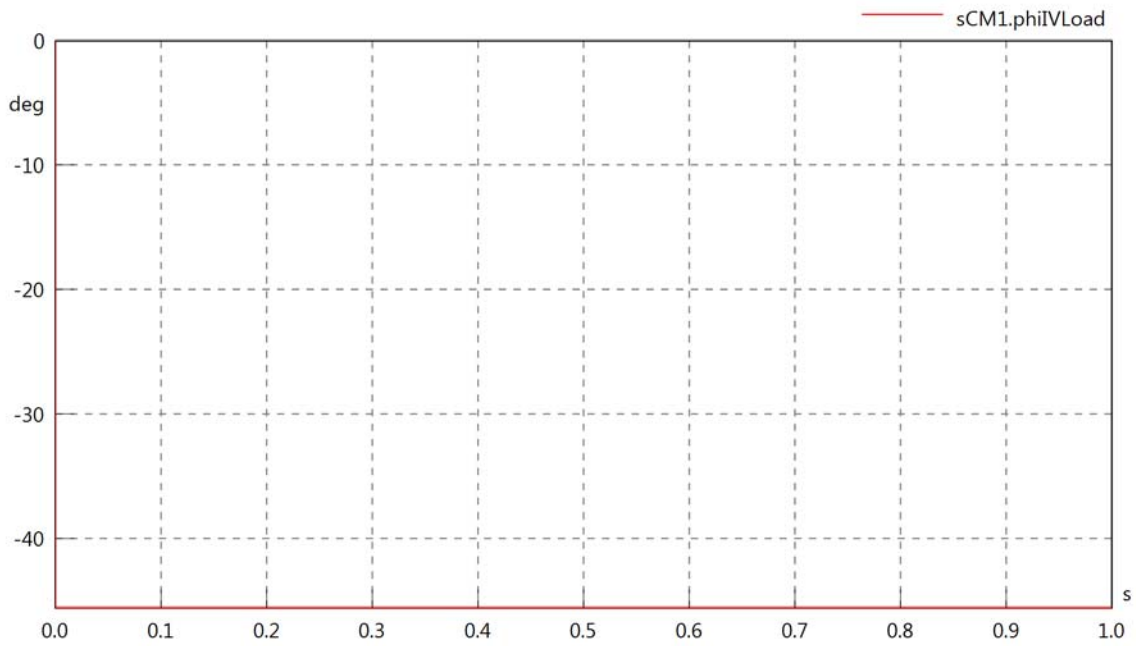

sCM1.PReLoad

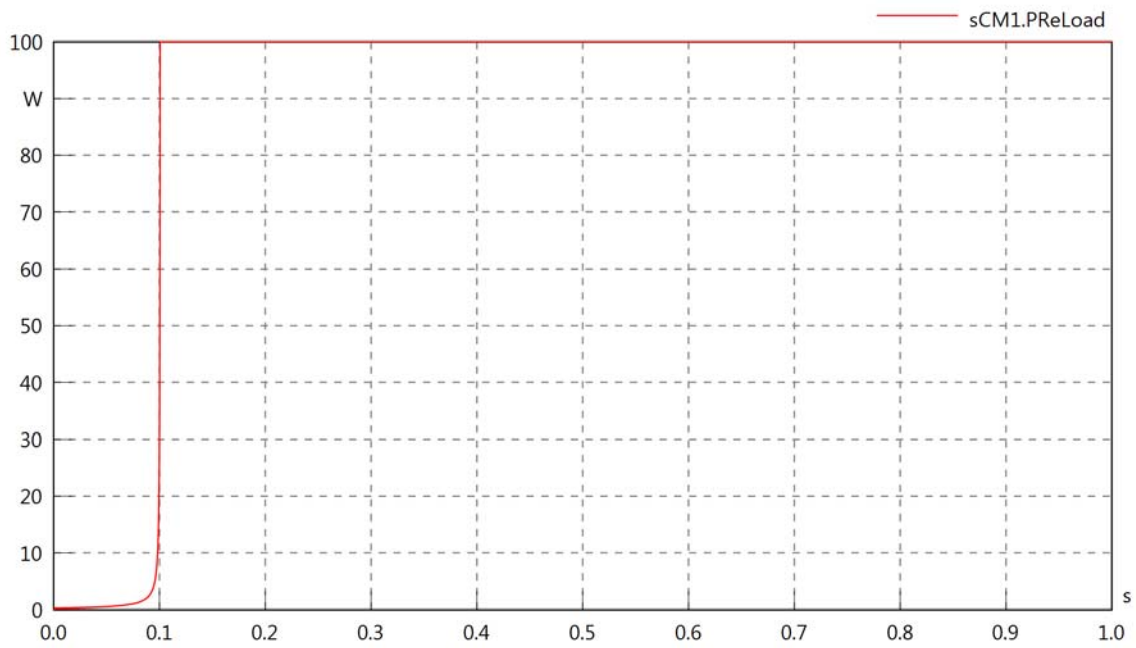

sCM1.PImLoad

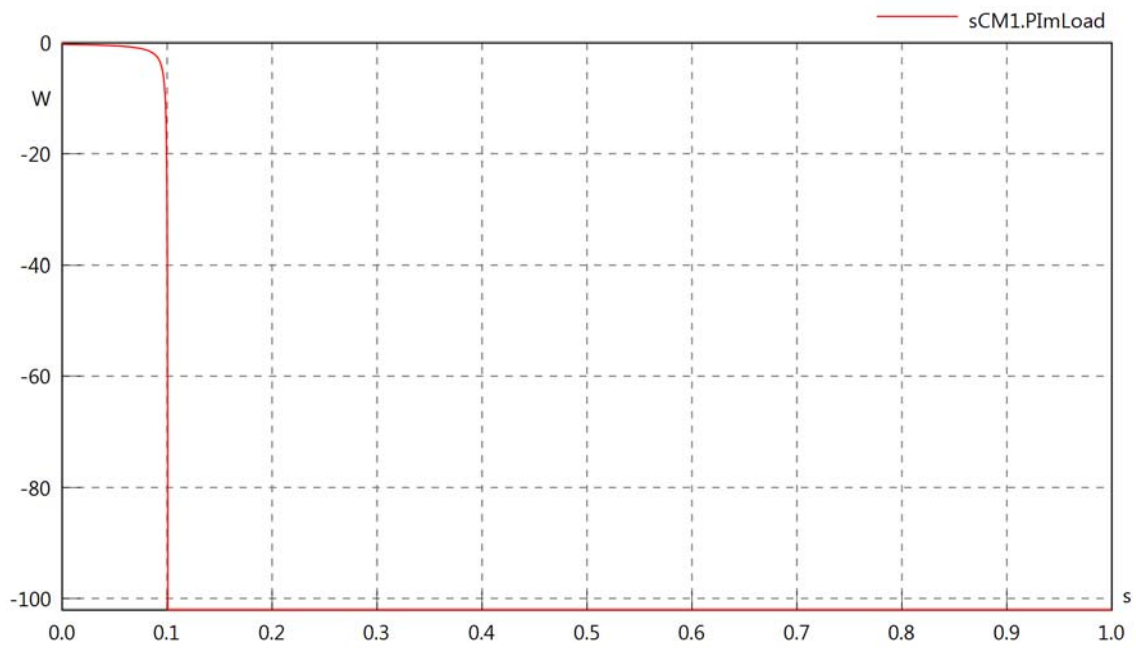

sCM1.SLoad

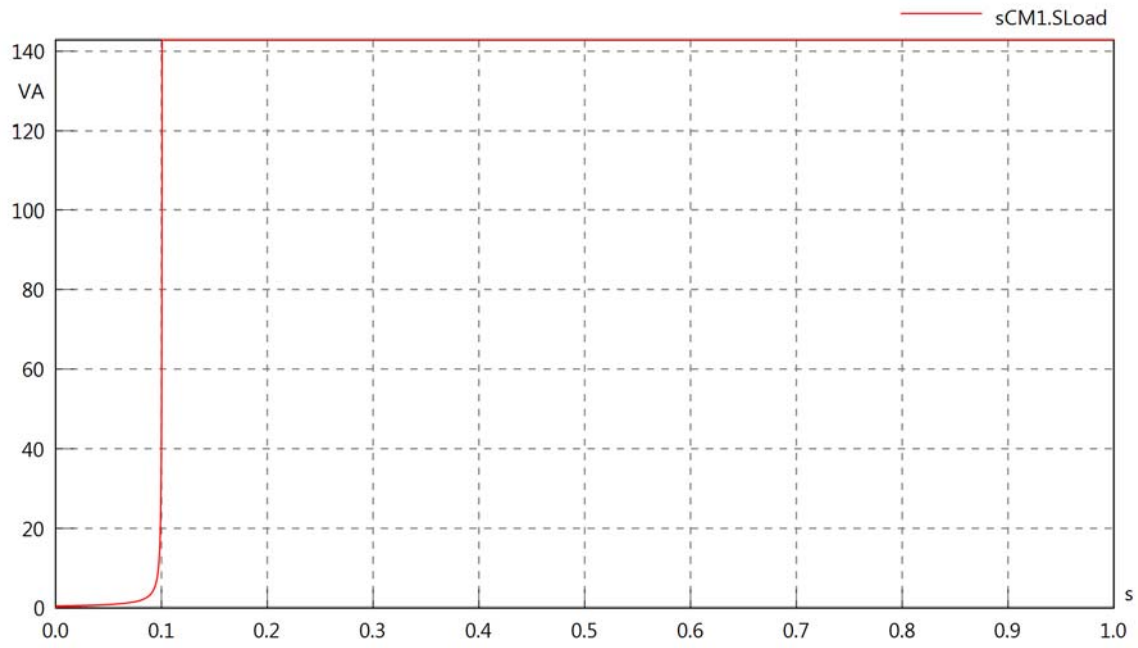
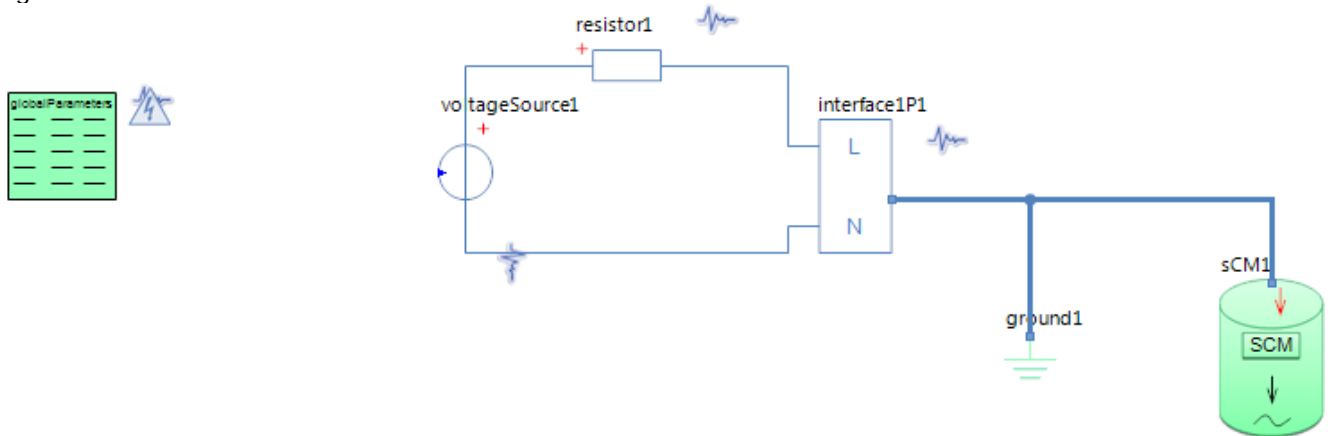

Diagram View



GlobalParameters globalParameters
Parameters

Comment	Name	Current Value	Unit
Type of Calculation	eCalculationKind	Signal Calculation	
Description of Frequency	eFrequencyKind	Linear	
Minimum Frequency	fMin	120	[Hz]
Maximum Frequency	fMax	120	[Hz]

Resistor resistor1
Parameters

Comment	Name	Current Value	Unit
Resistance	R	50	[Ohm]

Voltage Source voltageSource1
Parameters

Comment	Name	Current Value	Unit
Voltage RMS	VrmsSrc	$\min(230, 230000 \cdot t)$	[V]
Phase	phi	0	[deg]

Subsea Control Module sCM1
Parameters

Comment	Name	Current Value	Unit
EPU or Modem sending on system	sType	EPU sending	
Simulate with internal Transformer	trafoOn	false	
Constant or Variable Power	pType	Constant Power	
Output Power from PSU in SCM	P	100	[VA]
PSU Power Factor	pf	0.7	[-]
PSU turn-off RMS Voltage	vMin	130	[V]
PSU turn-on RMS Voltage	vMax	180	[V]

sCM1.Rload

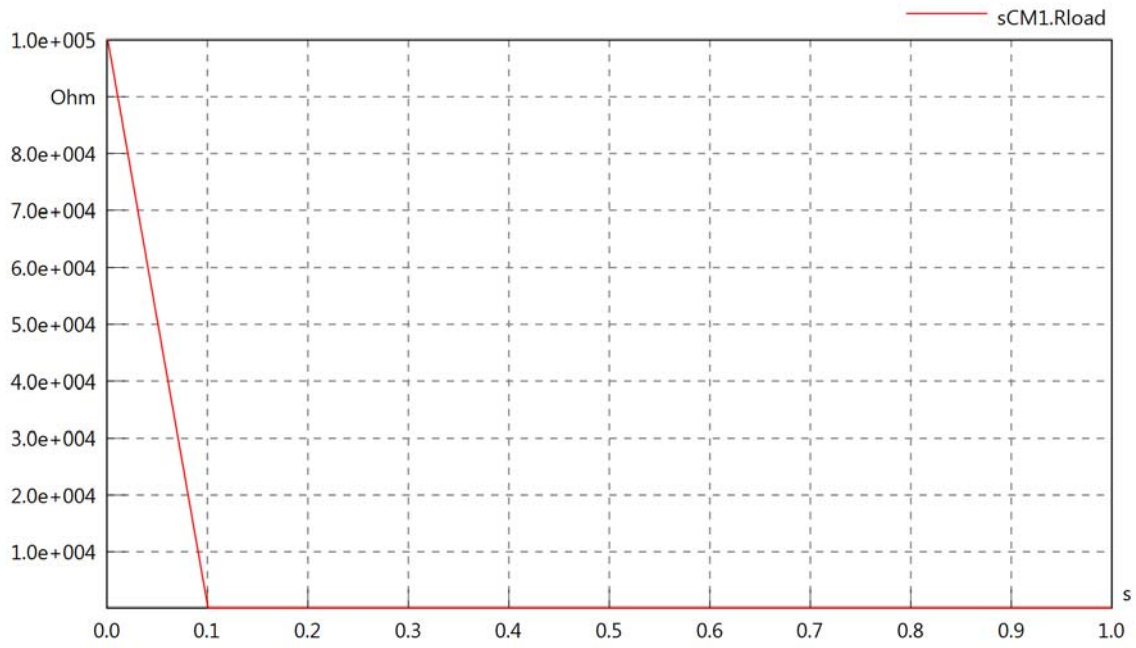

sCM1.Cload

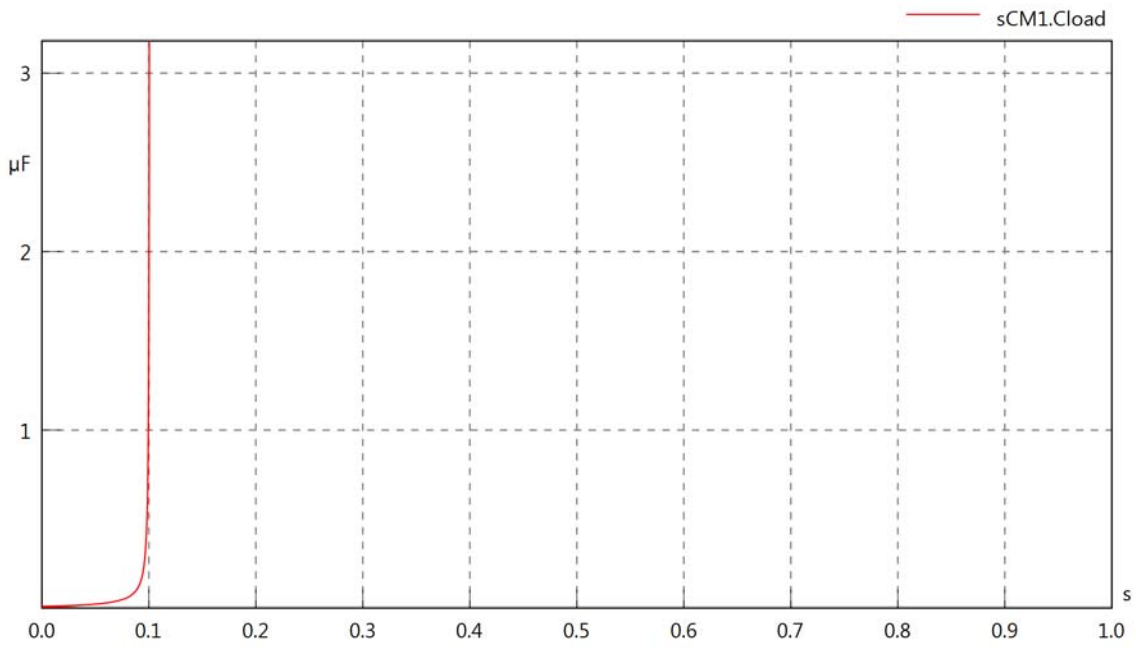

sCM1.PsetX2

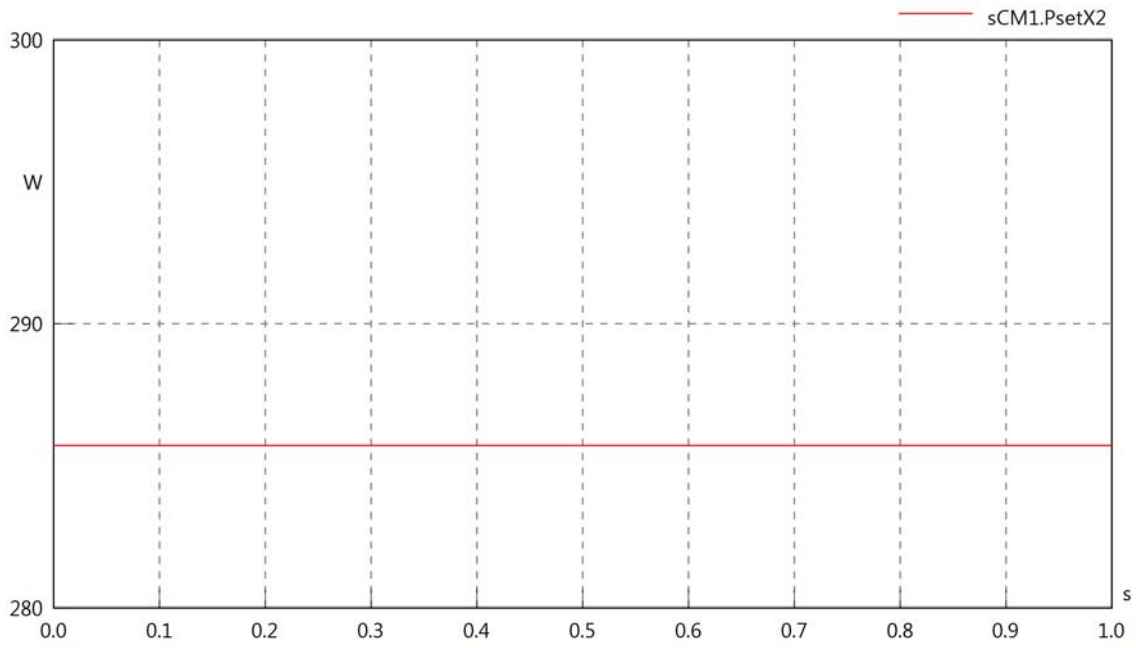

sCM1.Pset

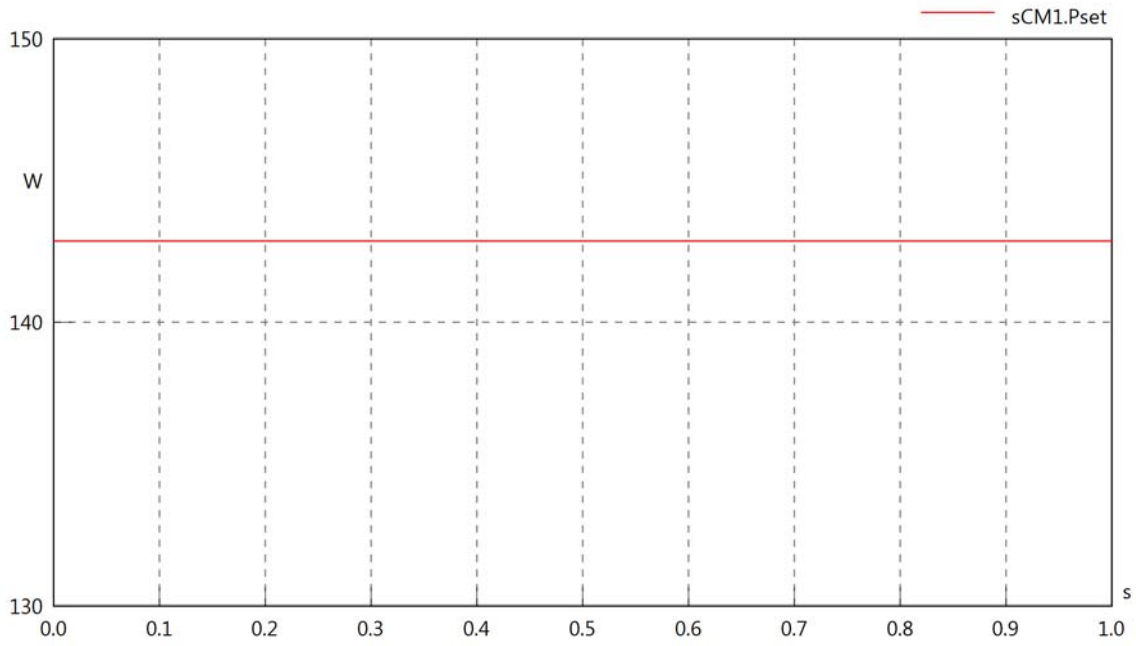

sCM1.PCalc

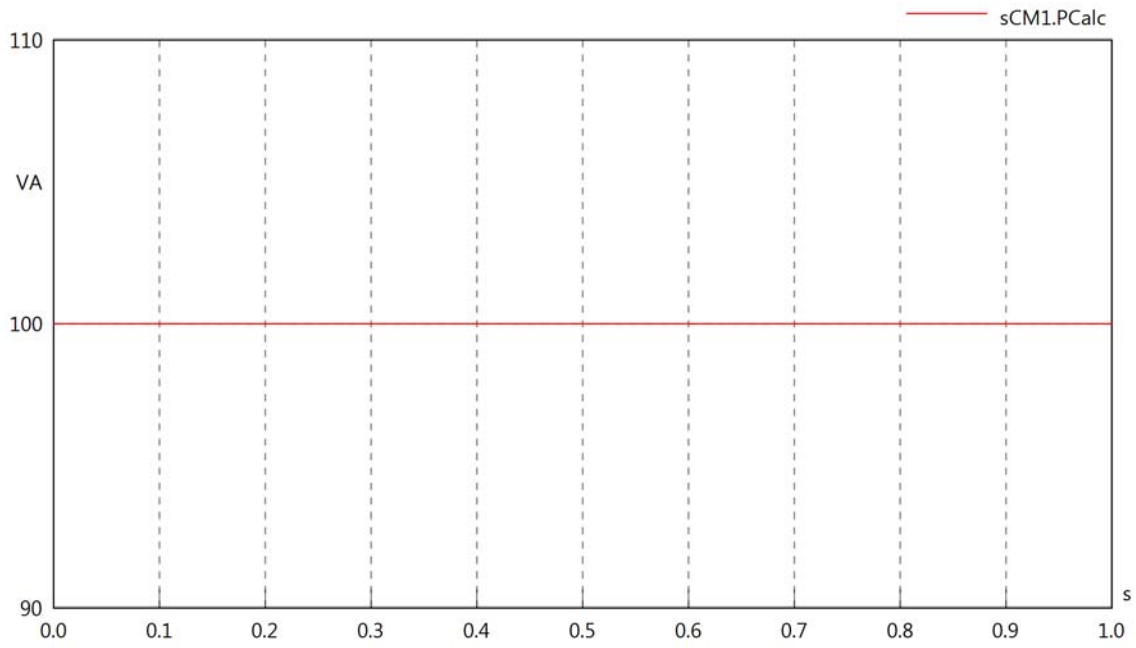

sCM1.VrmsIn

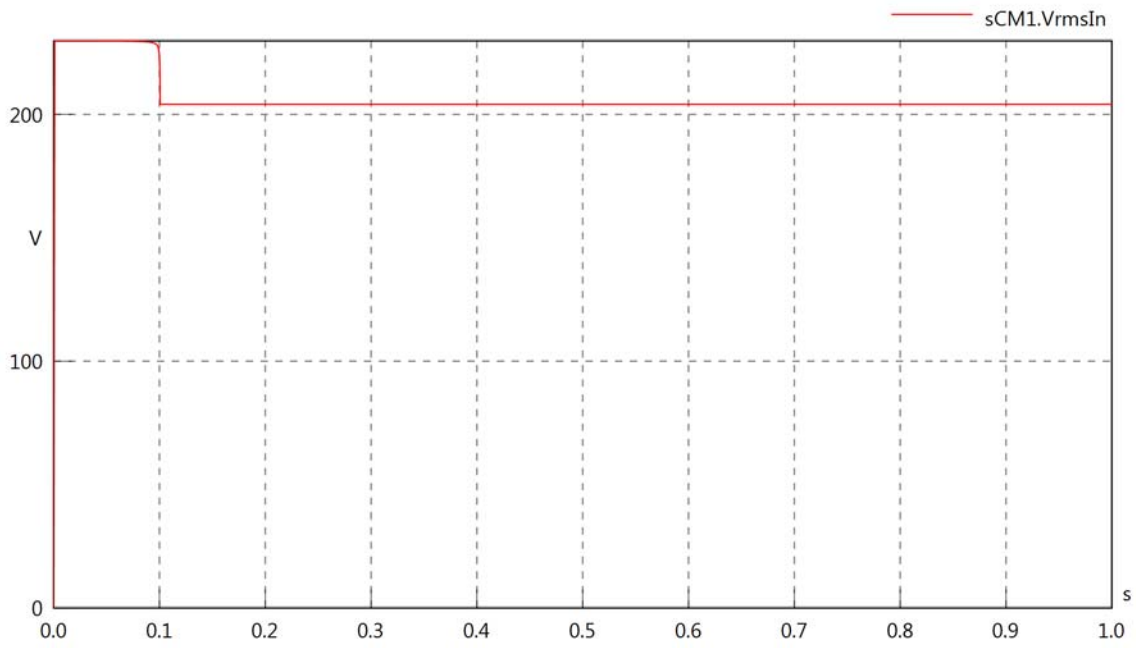

sCM1.vReIn

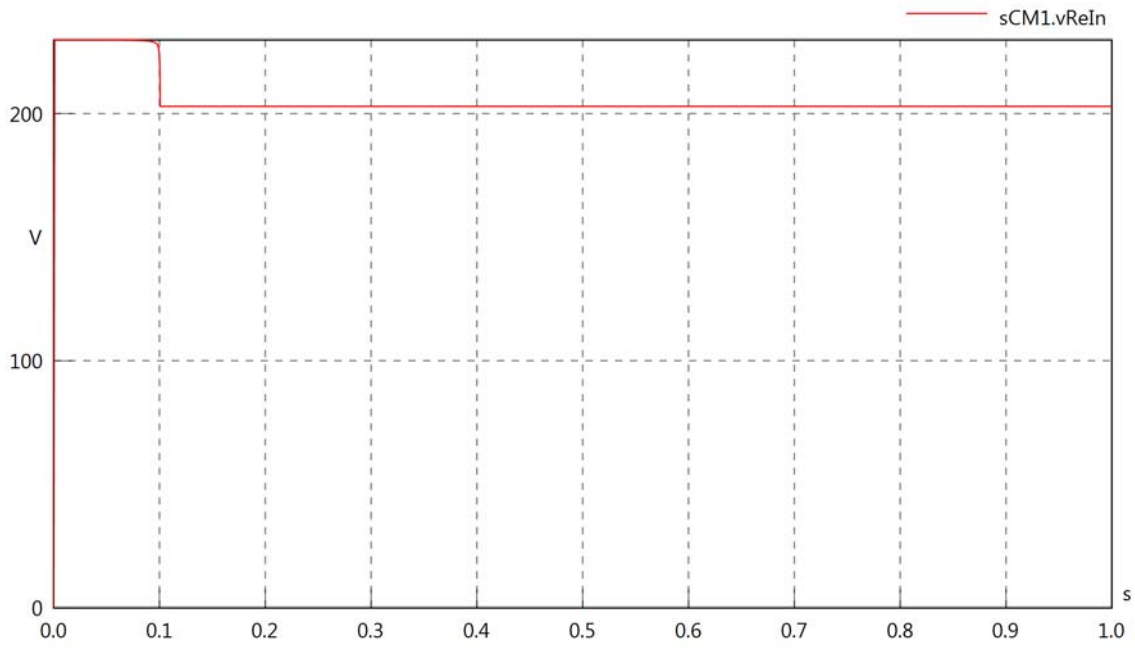

sCM1.vImIn

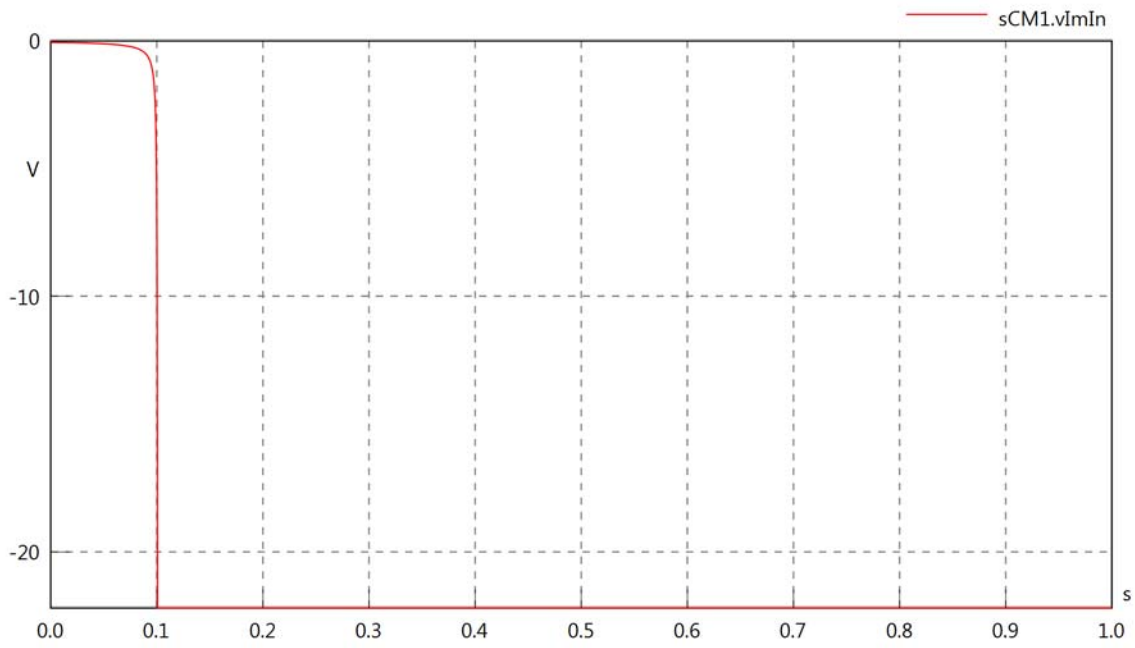

sCM1.IrmsIn

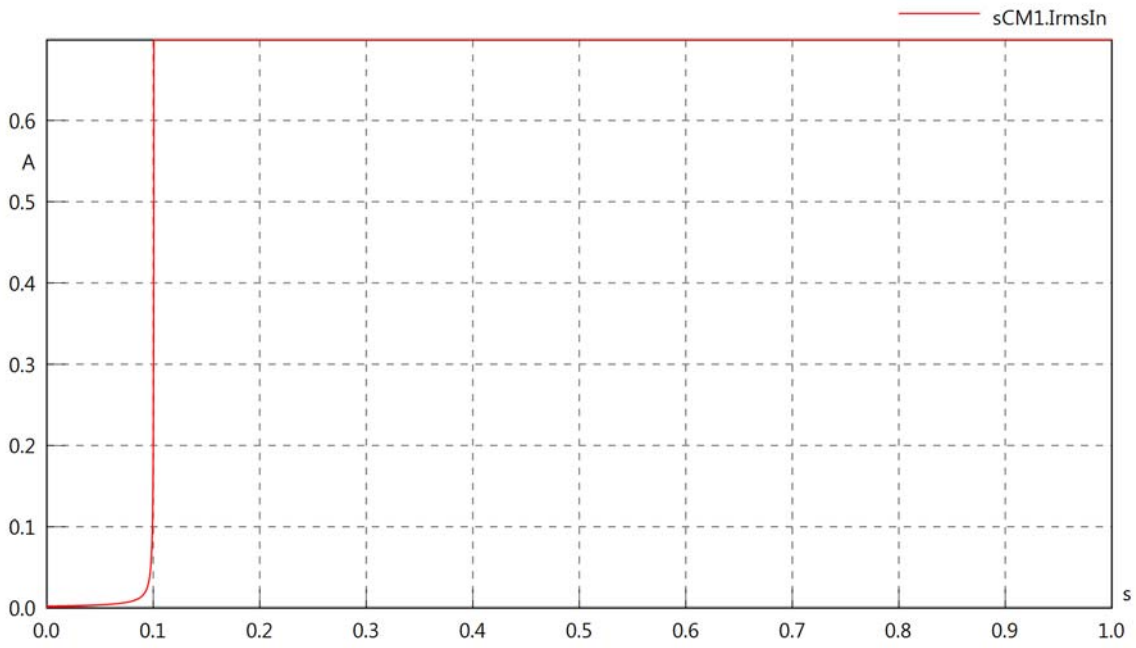

sCM1.iReIn

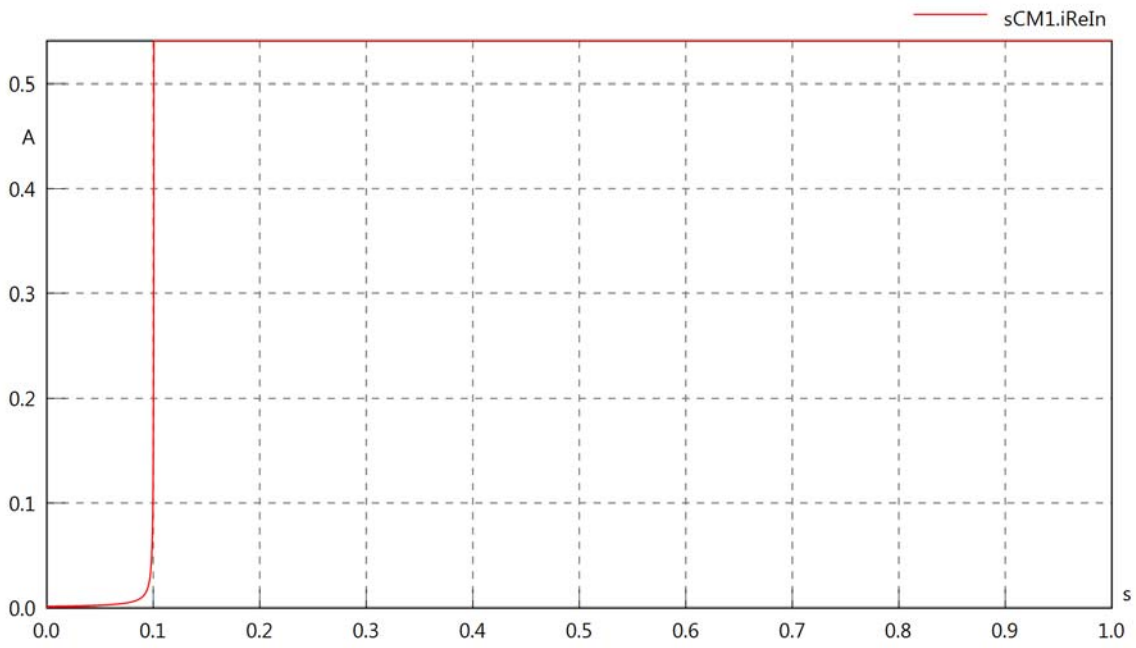

sCM1.ilmIn

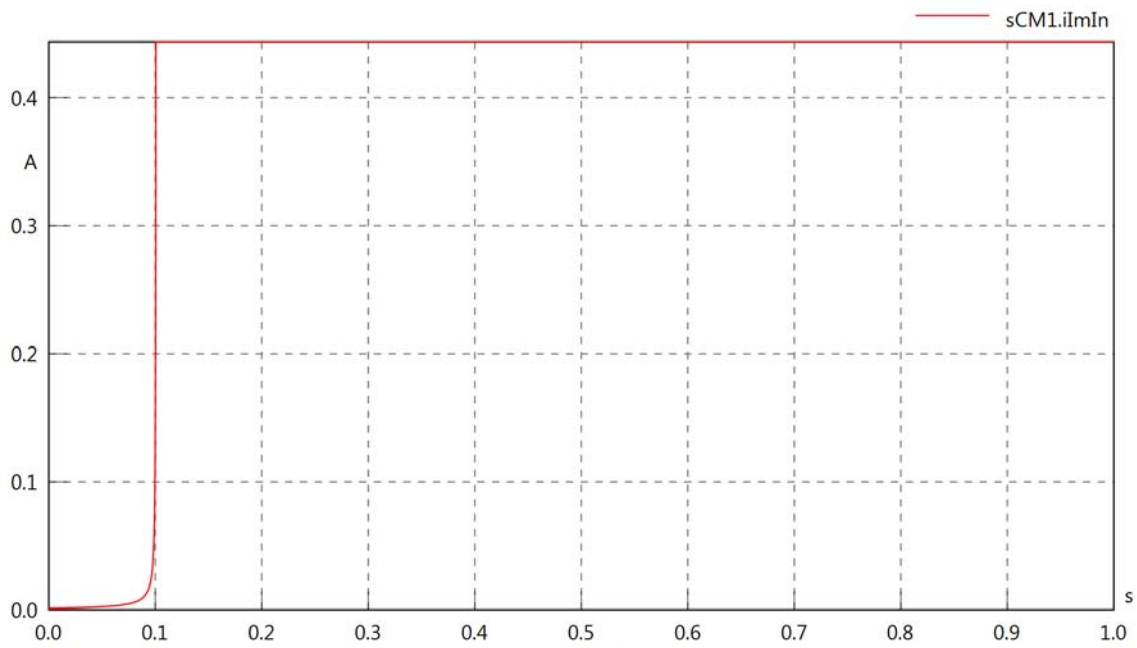

sCM1.phiVIn

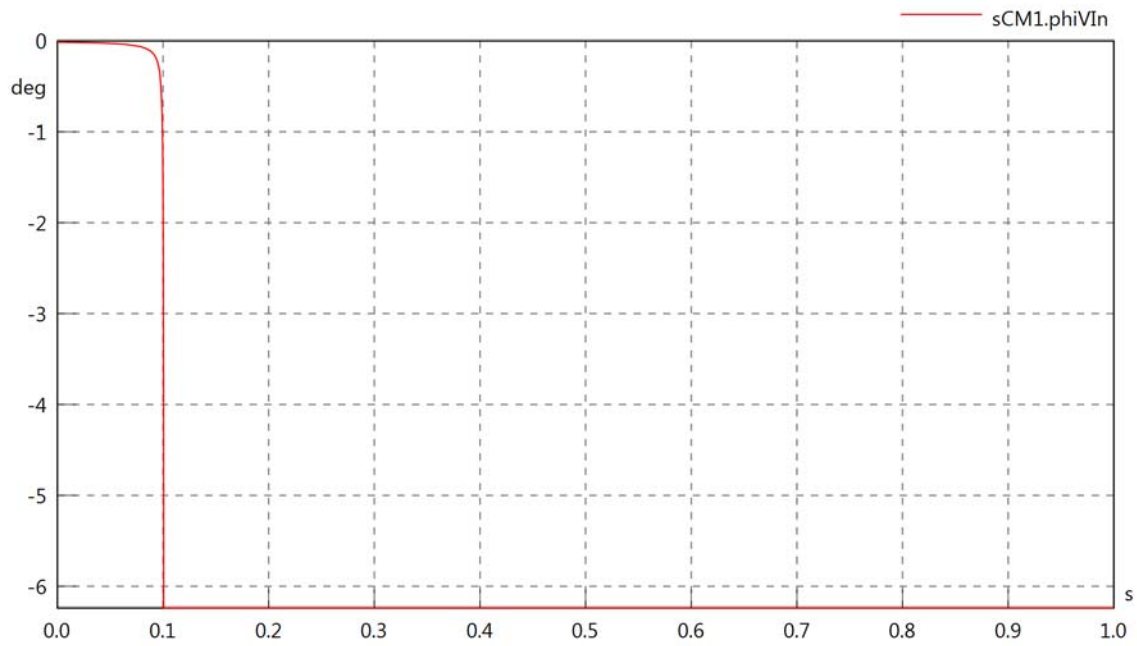

sCM1.philIn

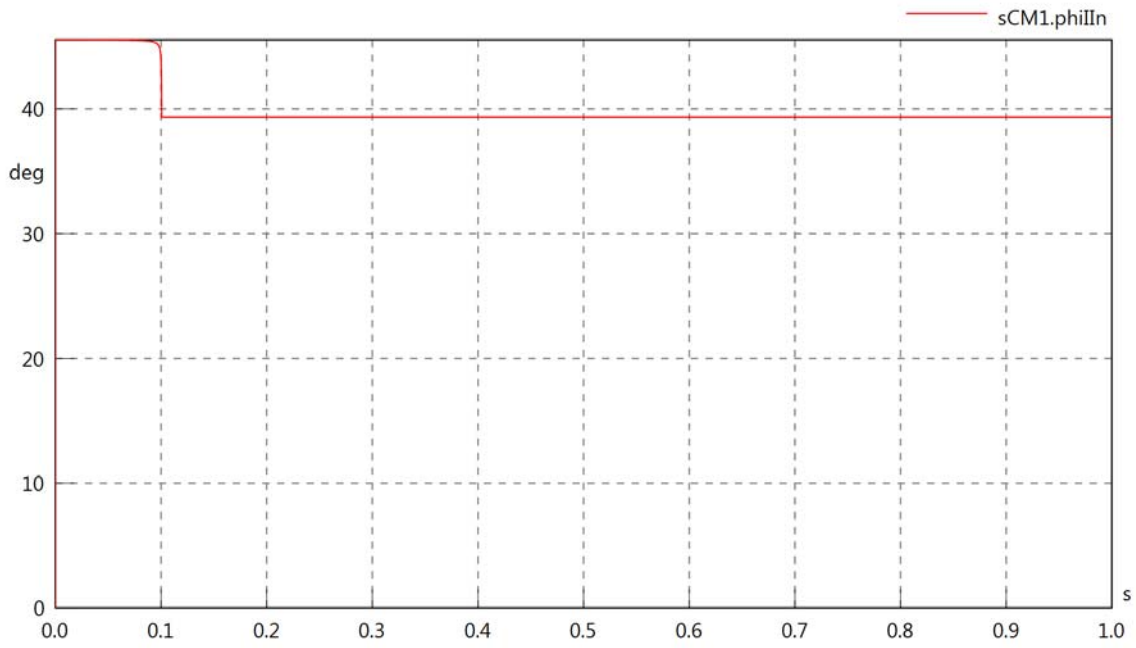

sCM1.philVIn

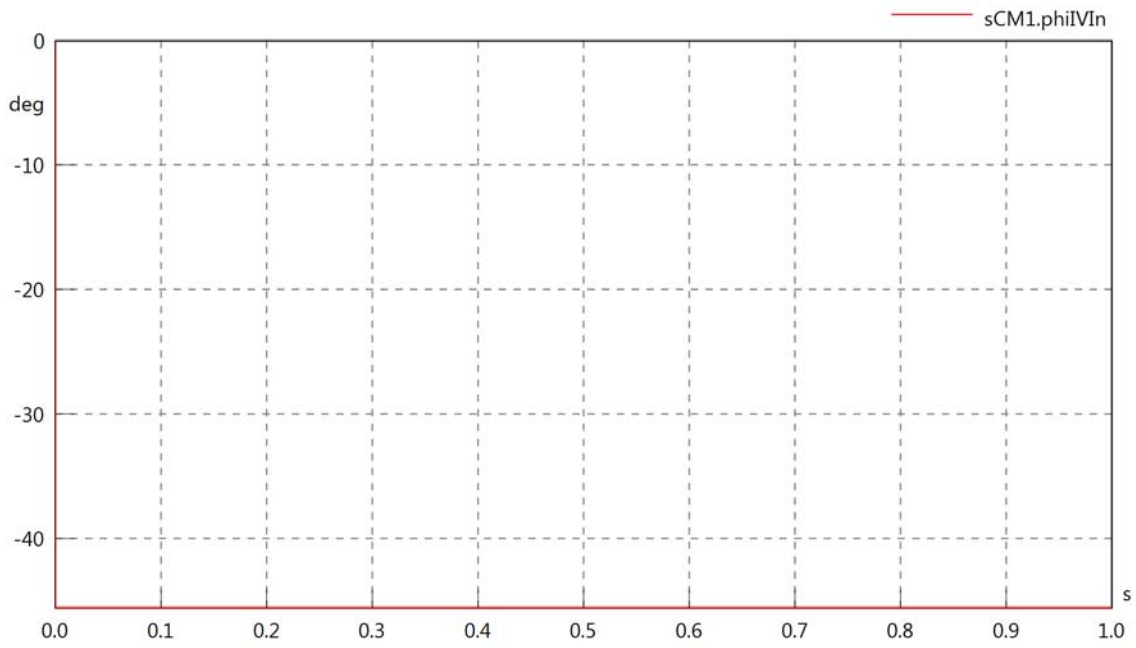

sCM1.PReIn

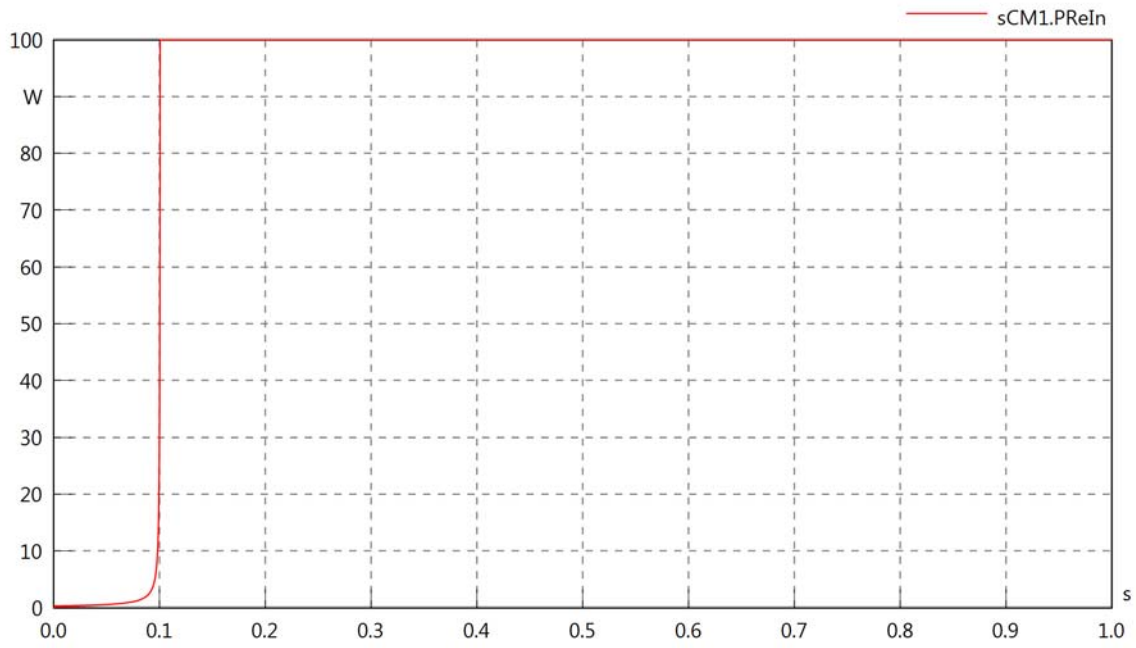

sCM1.PImIn

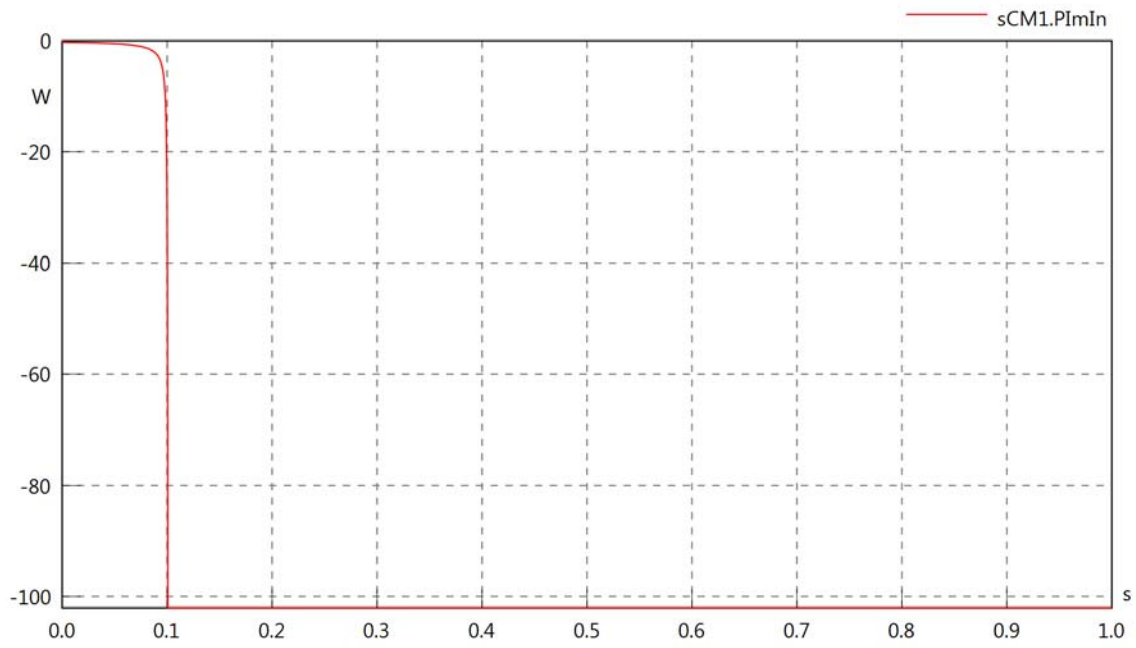

sCM1.SIn

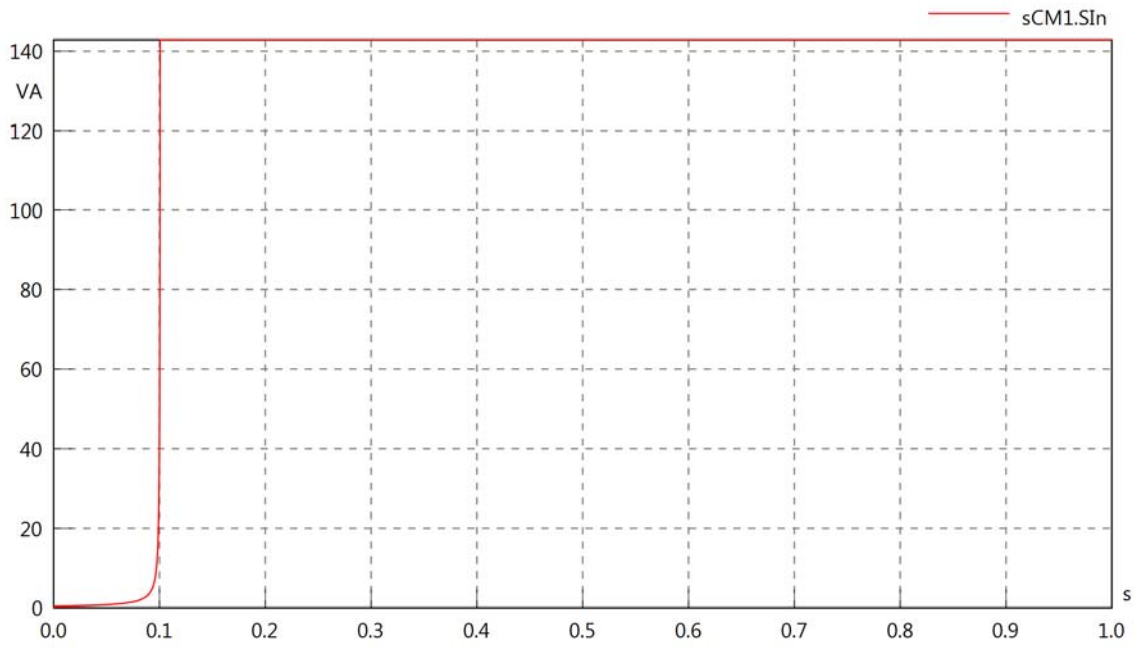

sCM1.VrmsLoad

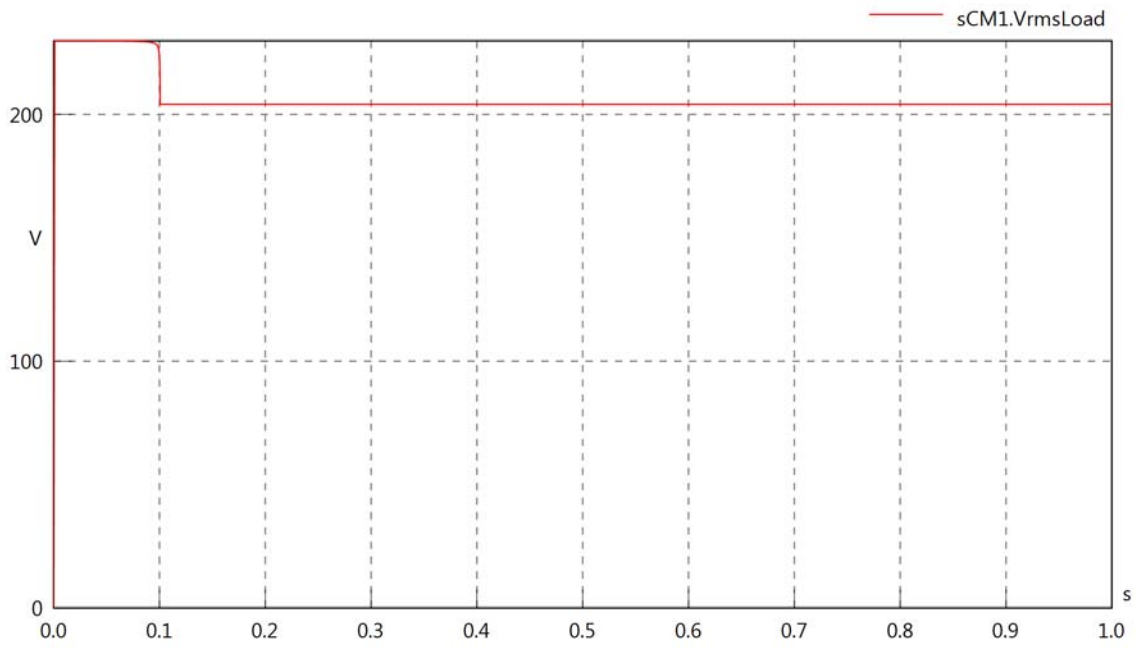

sCM1.vReLoad

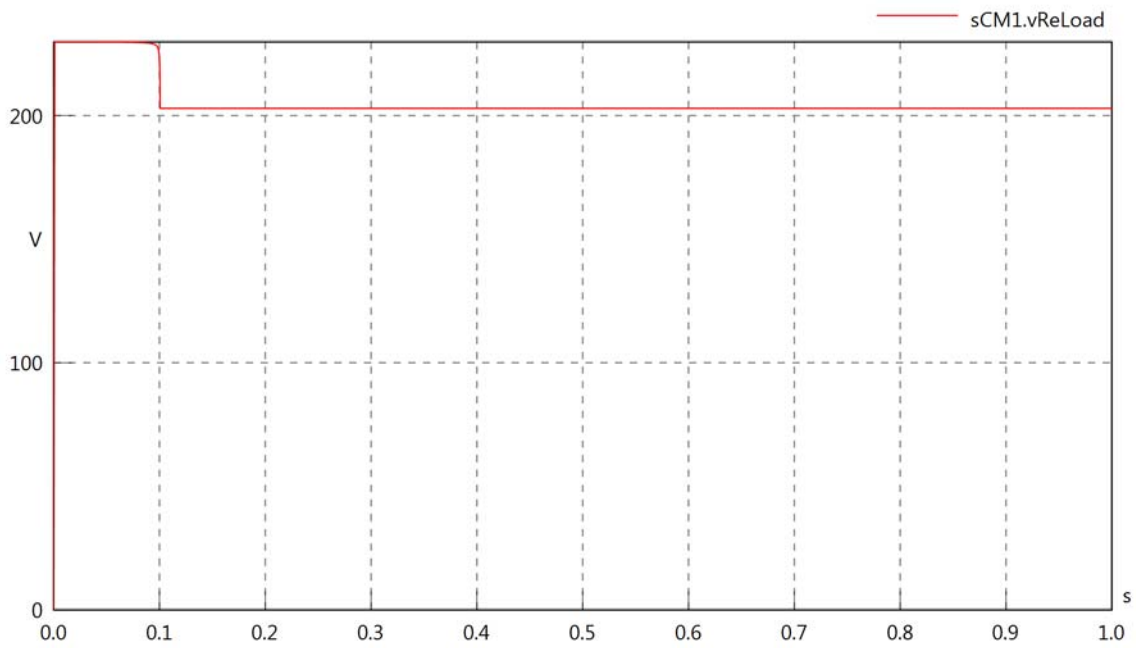

sCM1.vImLoad

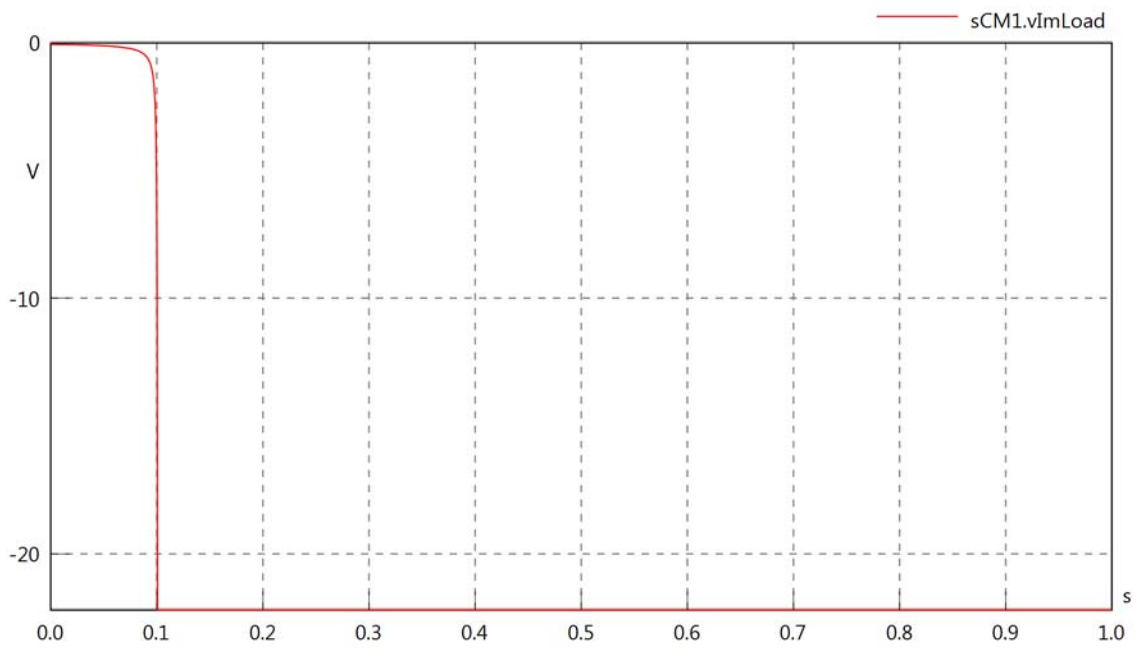

sCM1.IrmsLoad

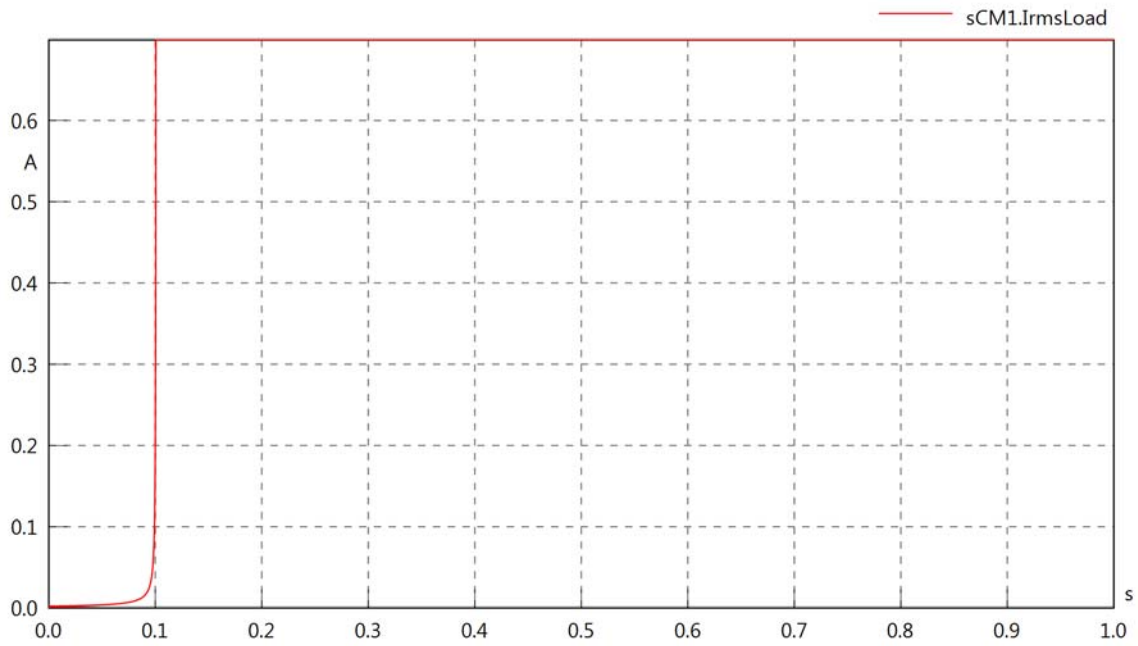

sCM1.iReLoad

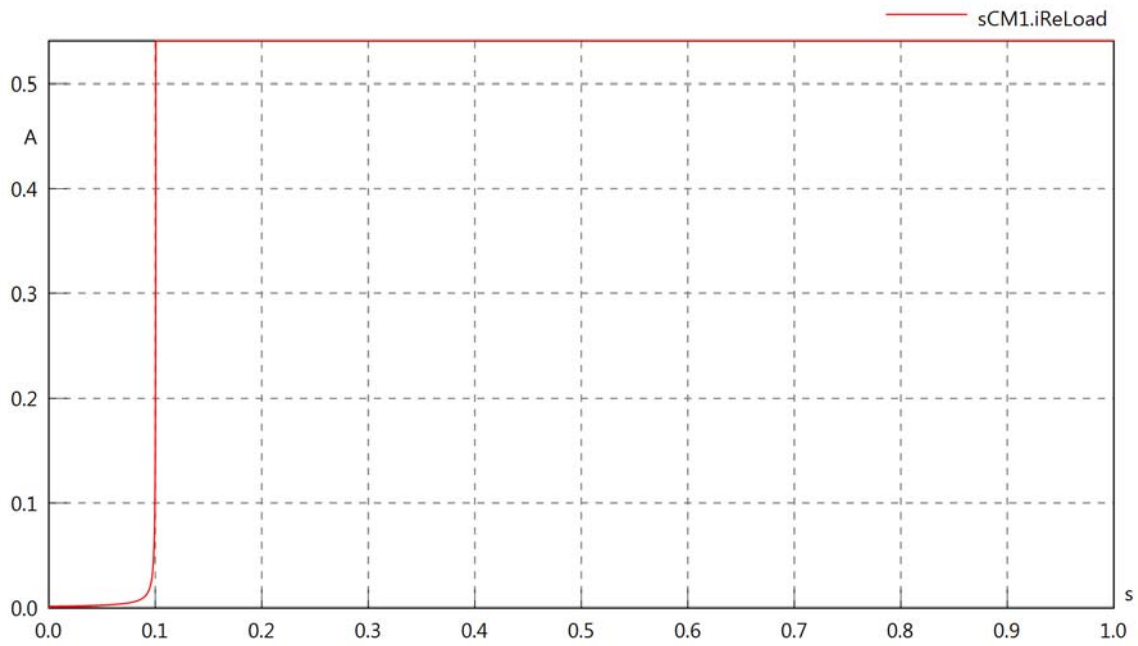

sCM1.iImLoad

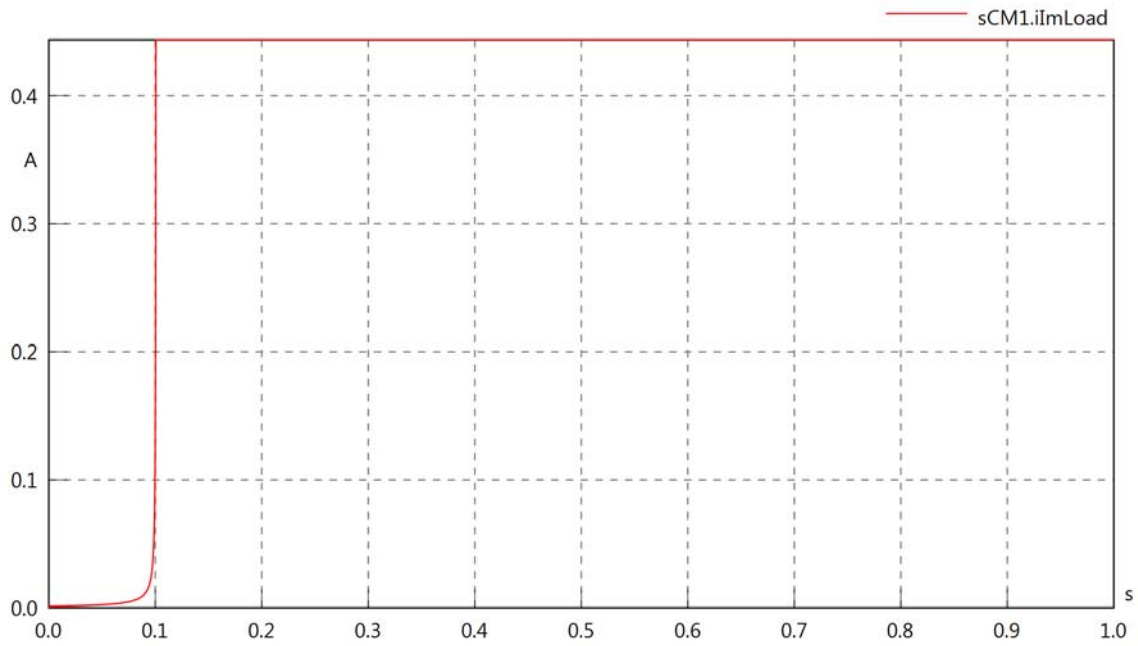

sCM1.phiVLoad

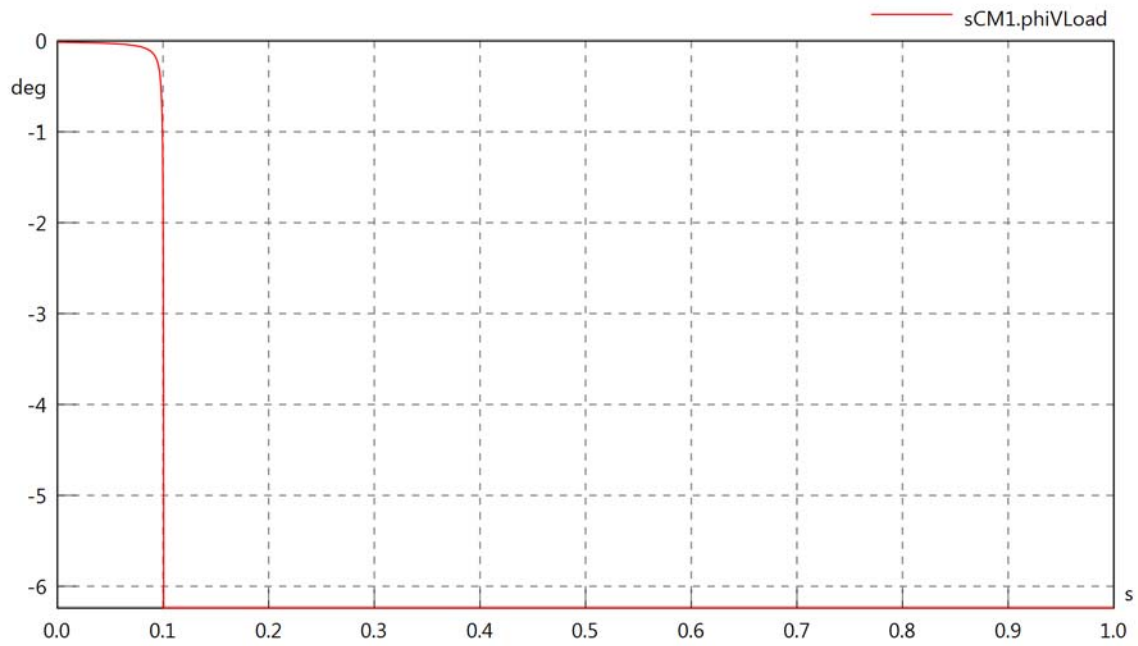

sCM1.philLoad

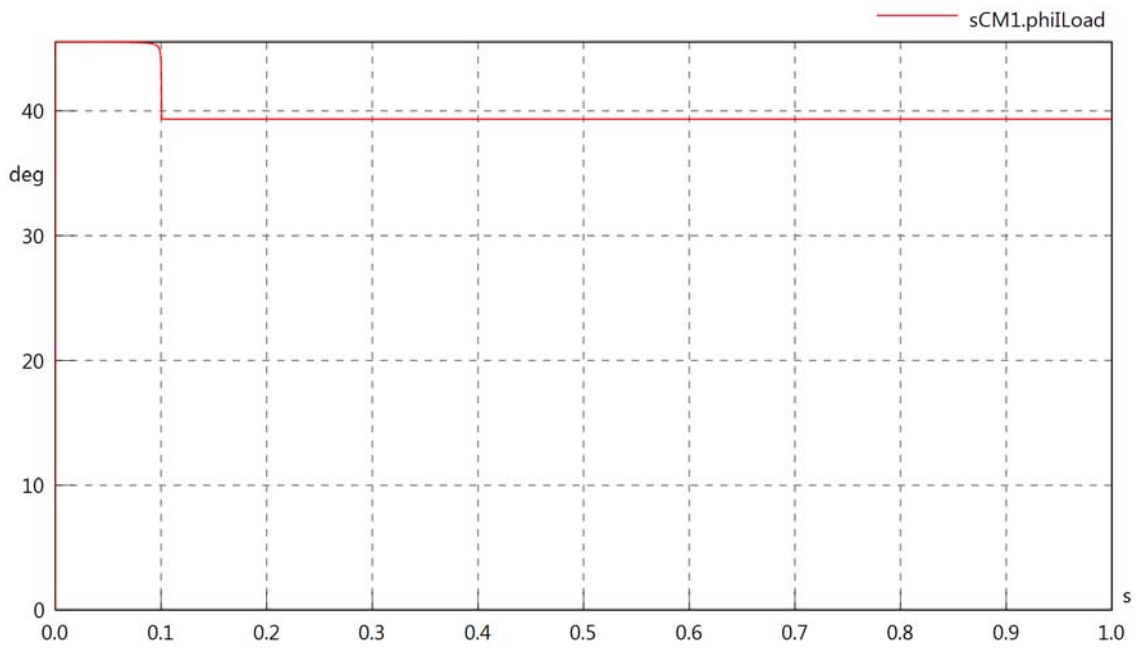

sCM1.philVLoad

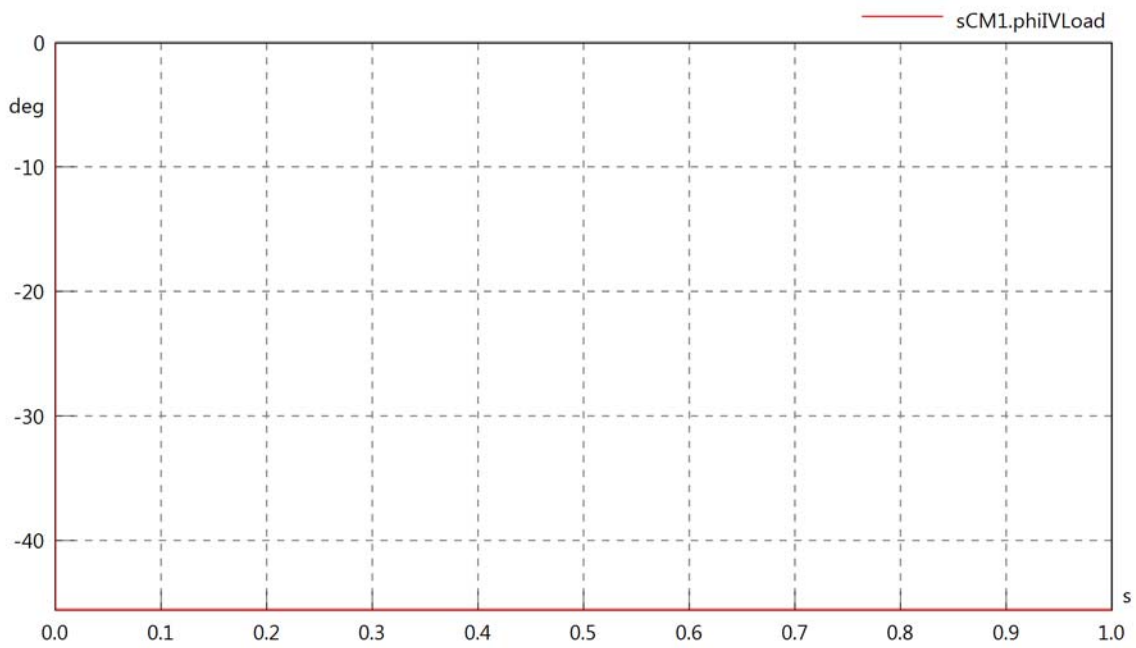

sCM1.PReLoad

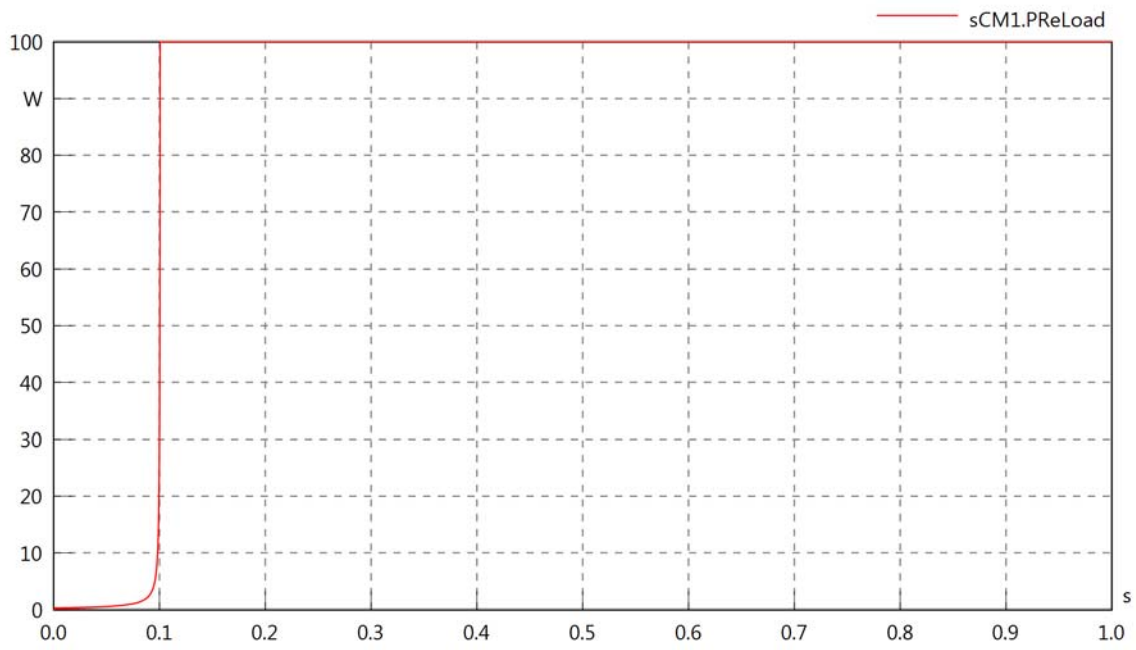

sCM1.PImLoad

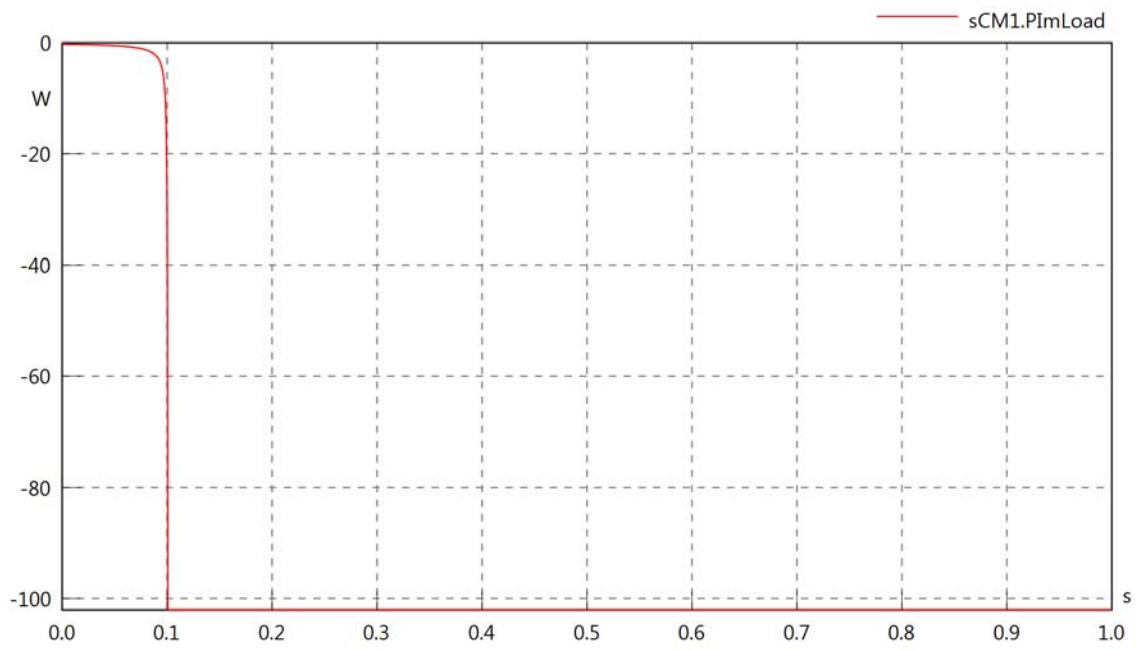

sCM1.SLoad

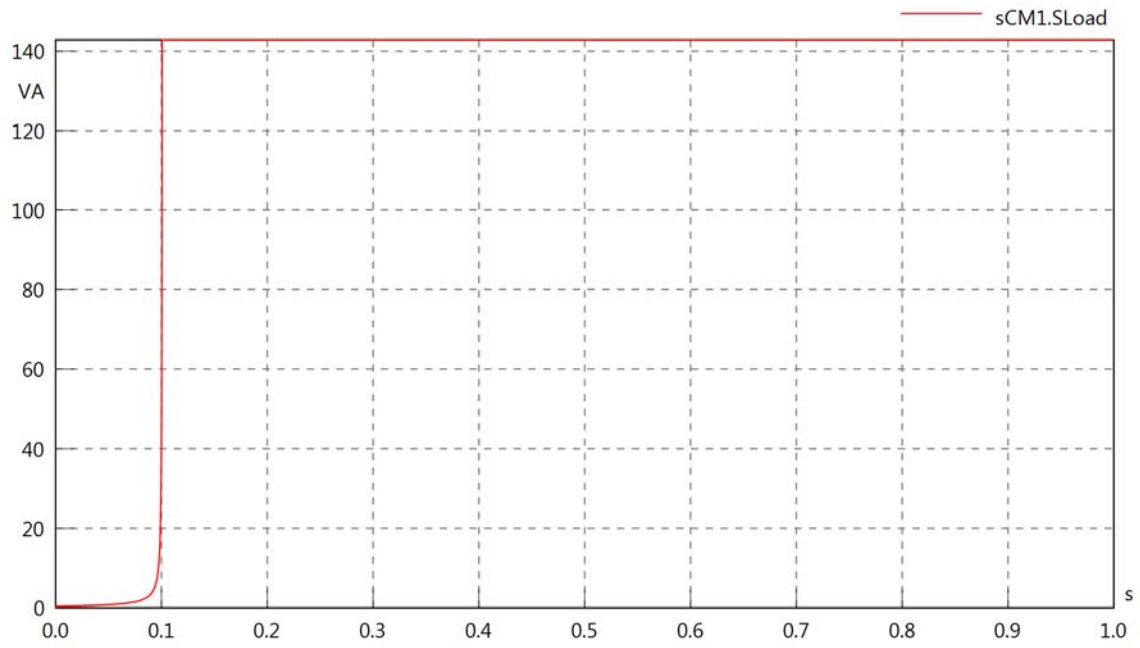
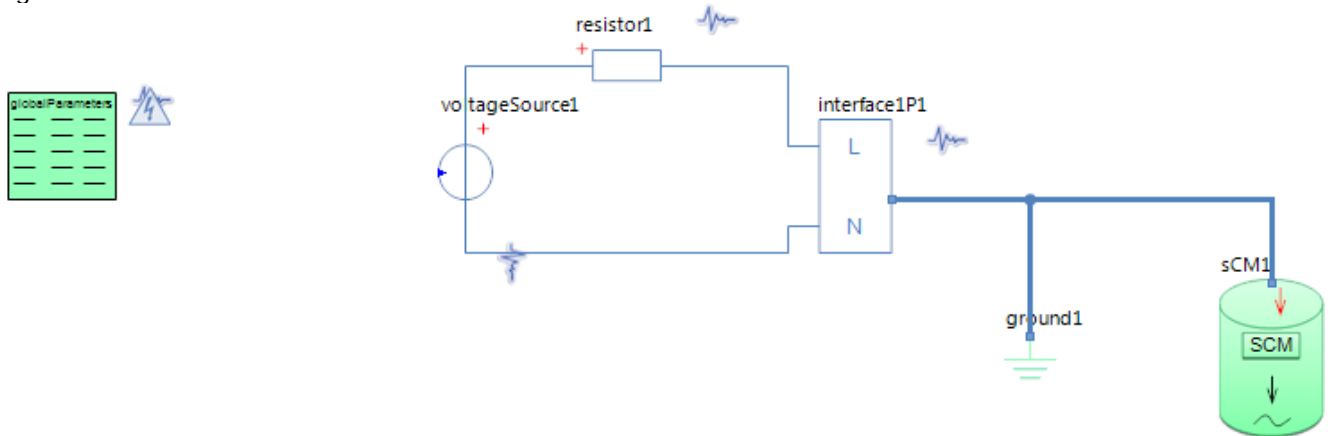

Diagram View



GlobalParameters globalParameters
Parameters

Comment	Name	Current Value	Unit
Type of Calculation	eCalculationKind	Signal Calculation	
Description of Frequency	eFrequencyKind	Linear	
Minimum Frequency	fMin	240	[Hz]
Maximum Frequency	fMax	240	[Hz]

Resistor resistor1
Parameters

Comment	Name	Current Value	Unit
Resistance	R	50	[Ohm]

Voltage Source voltageSource1
Parameters

Comment	Name	Current Value	Unit
Voltage RMS	VrmsSrc	$\min(230, 230000 * t)$	[V]
Phase	phi	0	[deg]

Subsea Control Module sCM1
Parameters

Comment	Name	Current Value	Unit
EPU or Modem sending on system	sType	EPU sending	
Simulate with internal Transformer	trafoOn	false	
Constant or Variable Power	pType	Constant Power	
Output Power from PSU in SCM	P	100	[VA]
PSU Power Factor	pf	0.7	[-]
PSU turn-off RMS Voltage	vMin	130	[V]
PSU turn-on RMS Voltage	vMax	180	[V]

sCM1.Rload

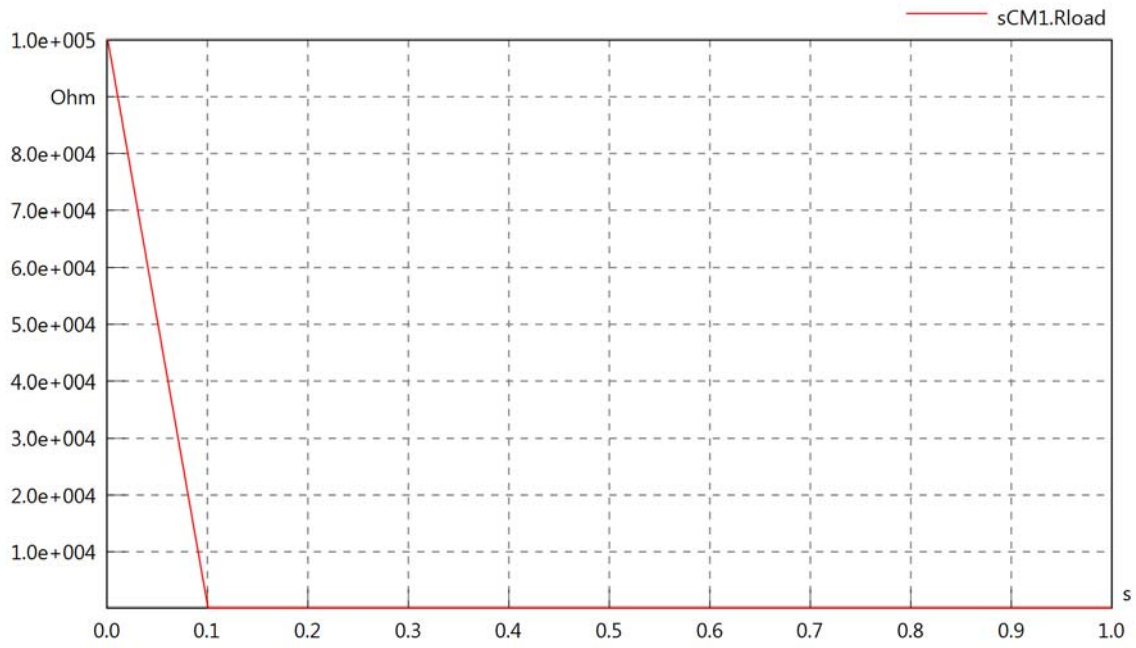

sCM1.Cload

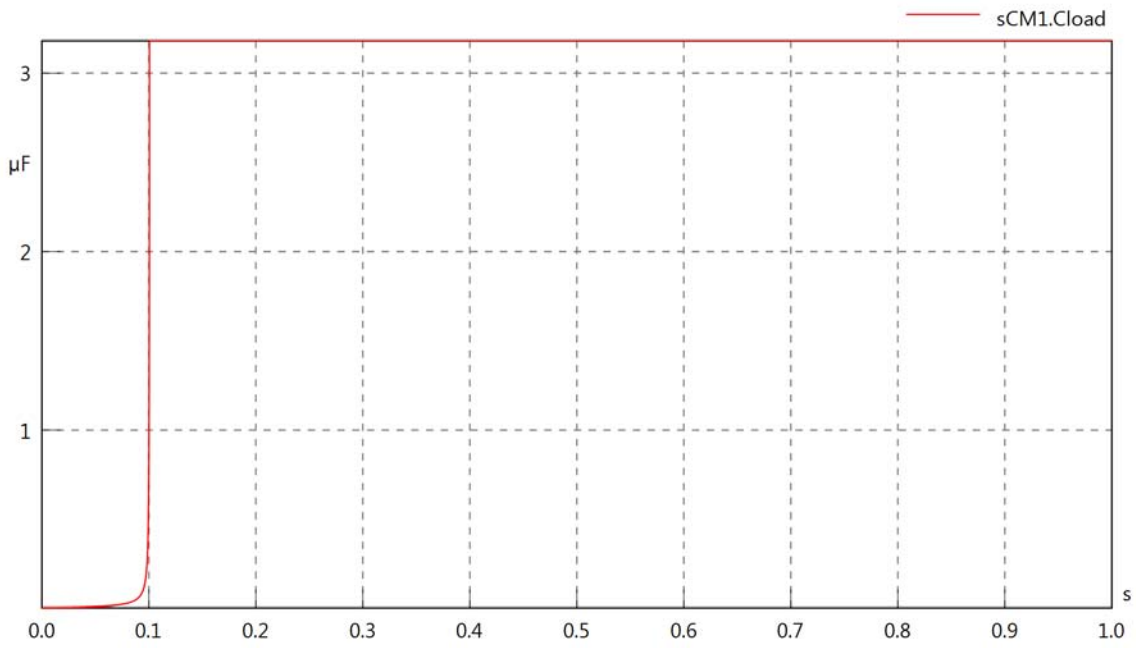

sCM1.PsetX2

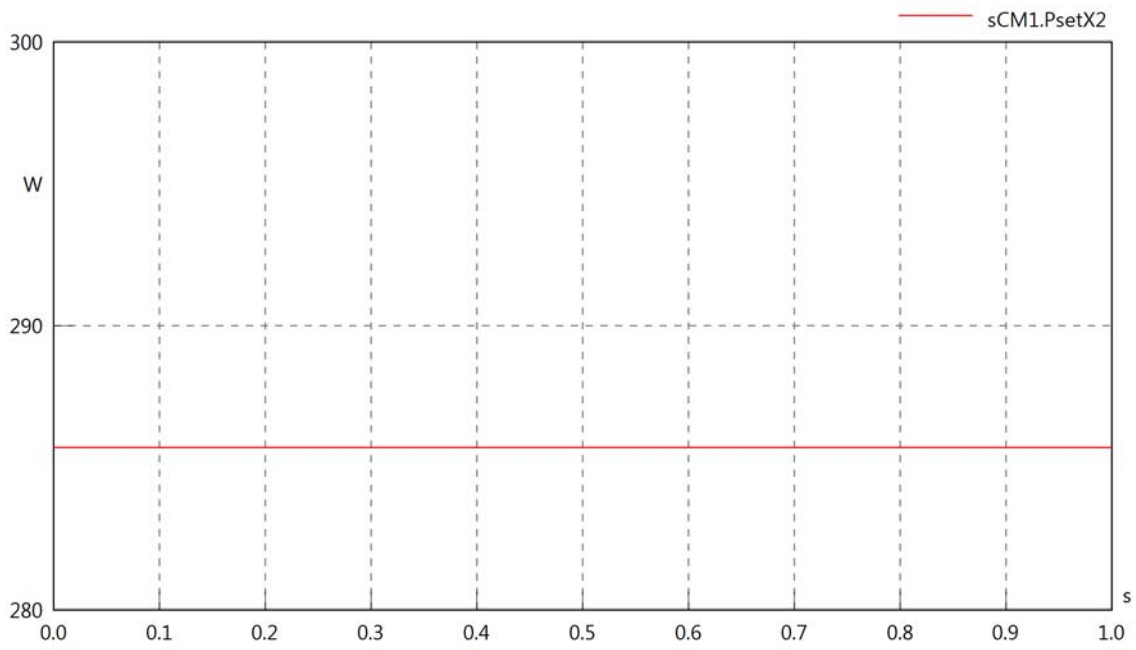

sCM1.Pset

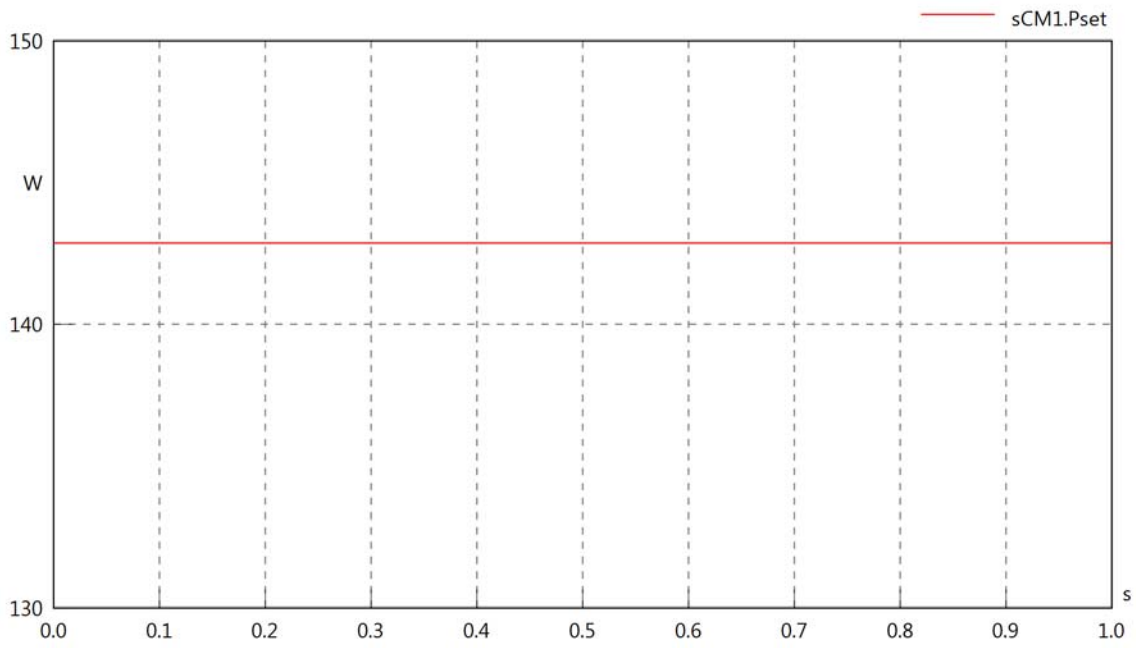

sCM1.PCalc

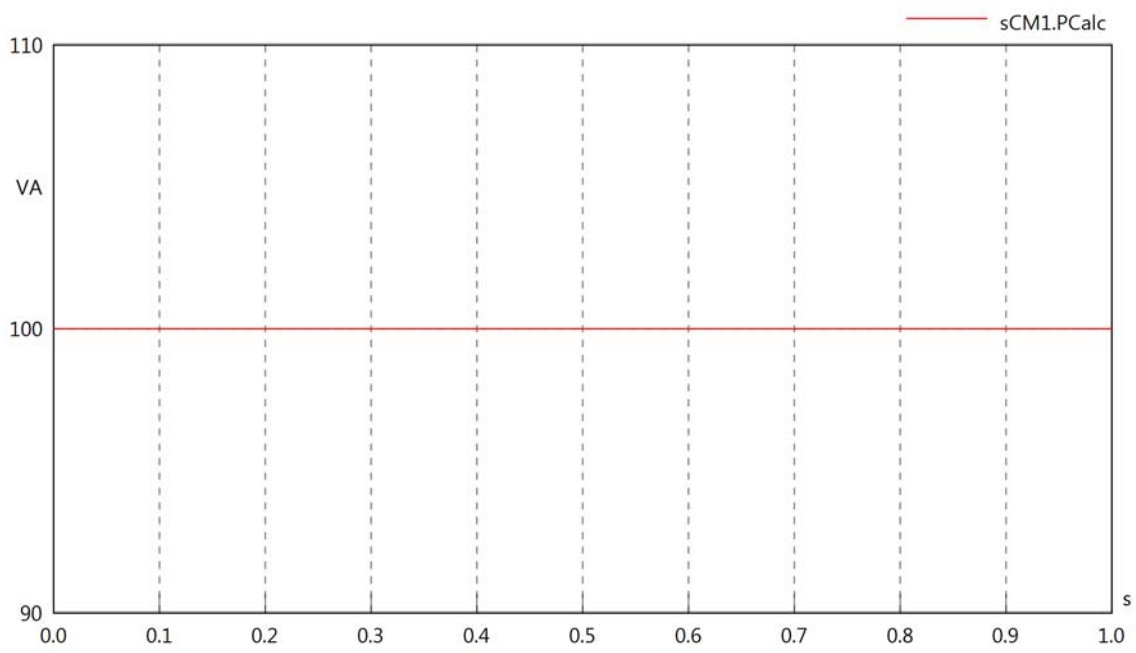

sCM1.VrmsIn

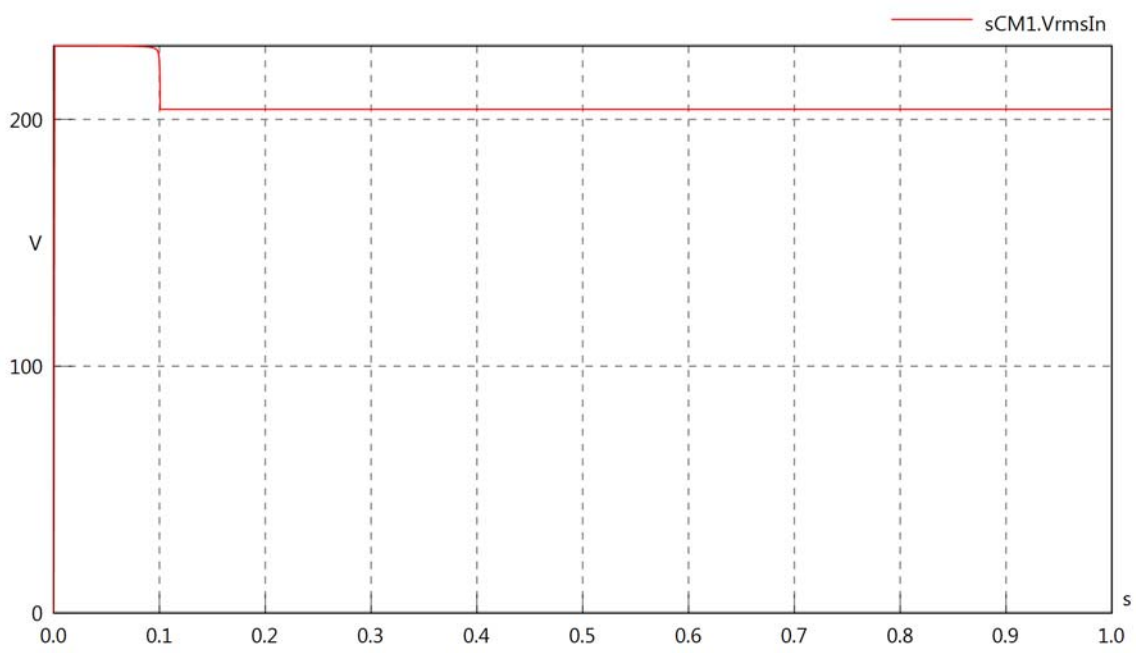

sCM1.vReIn

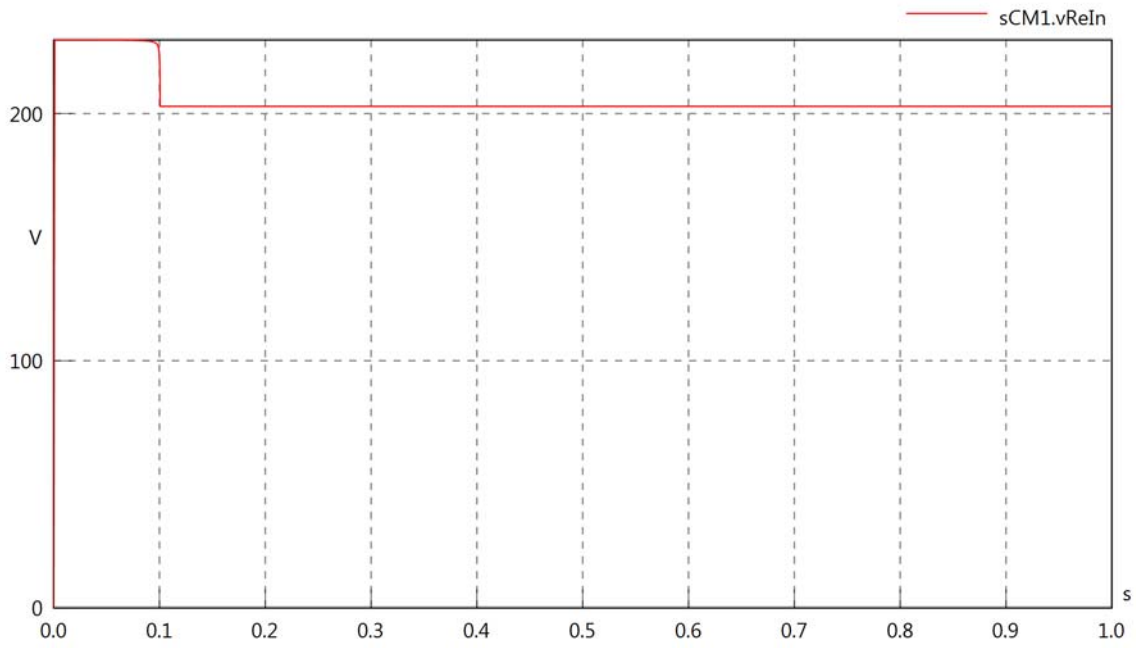

sCM1.vImIn

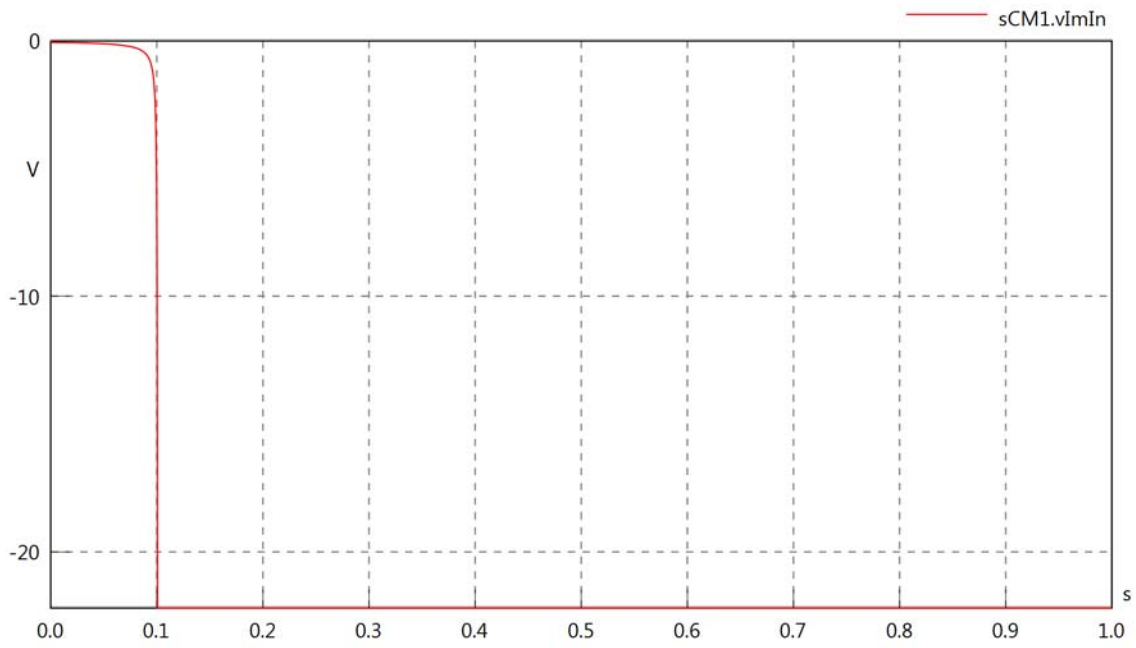

sCM1.IrmsIn

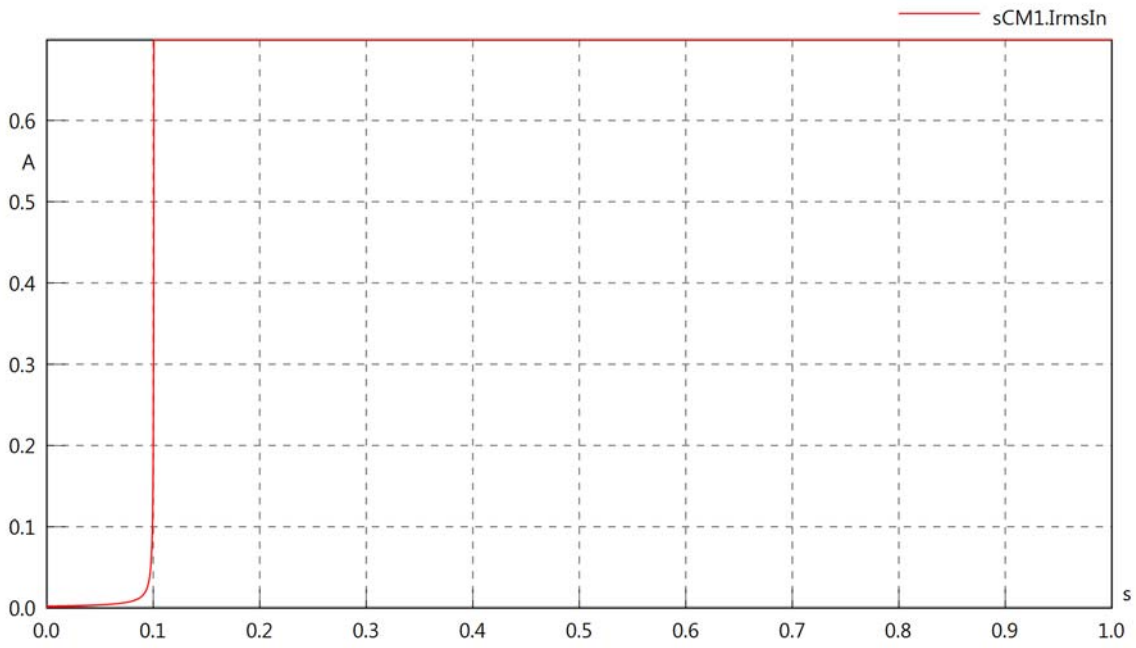

sCM1.iReIn

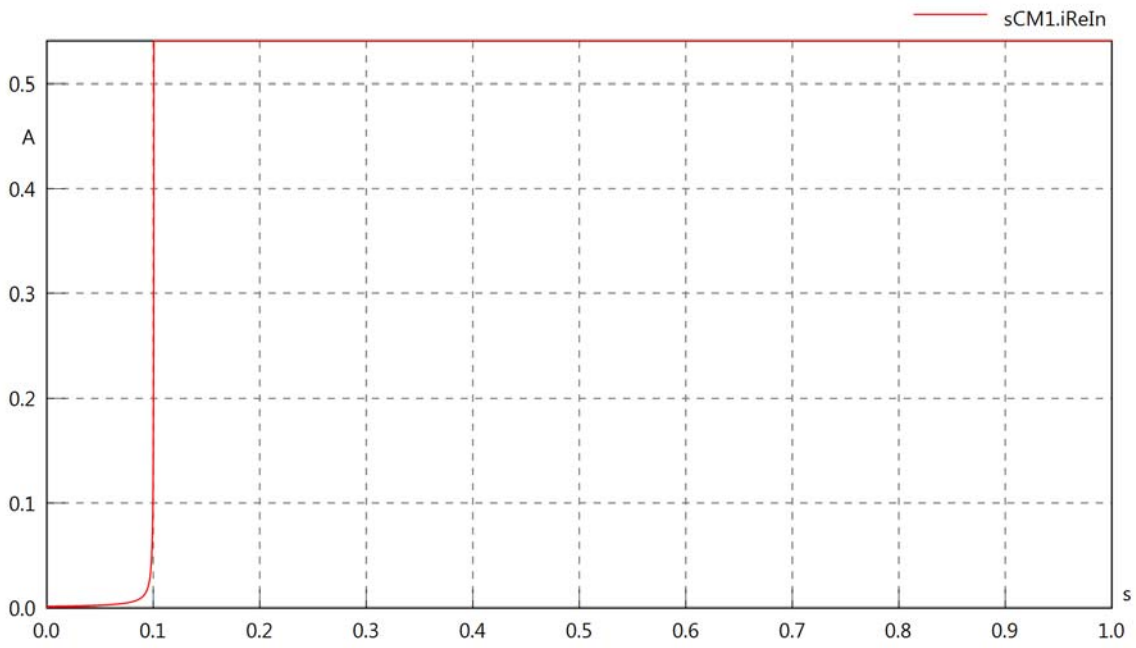

sCM1.ilmIn

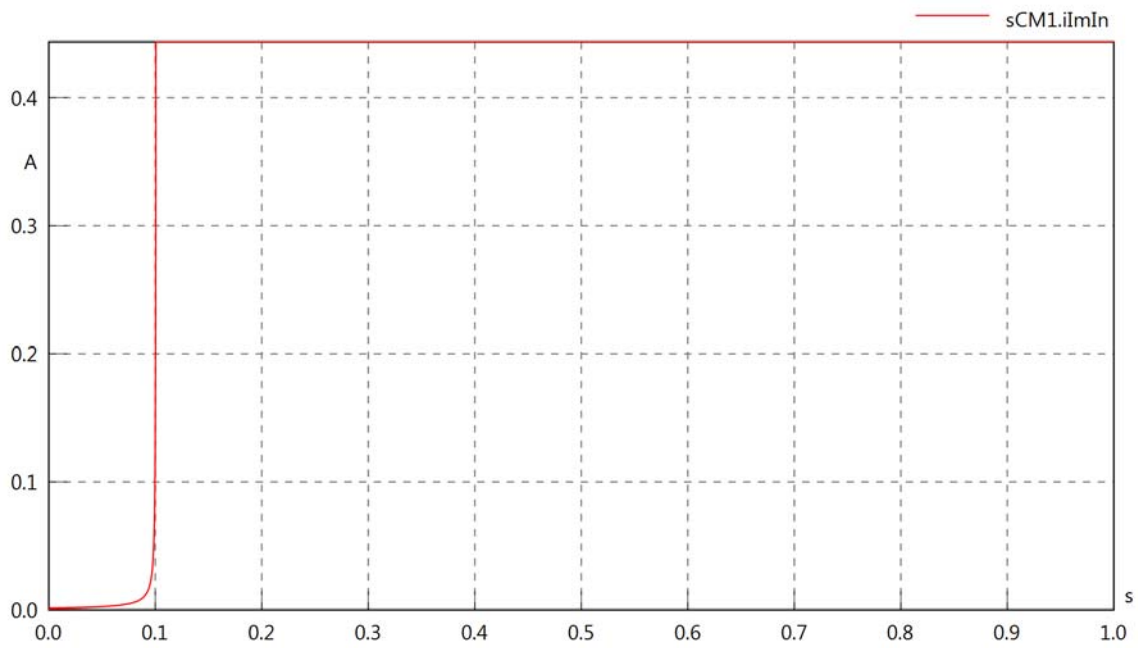

sCM1.phiVIn

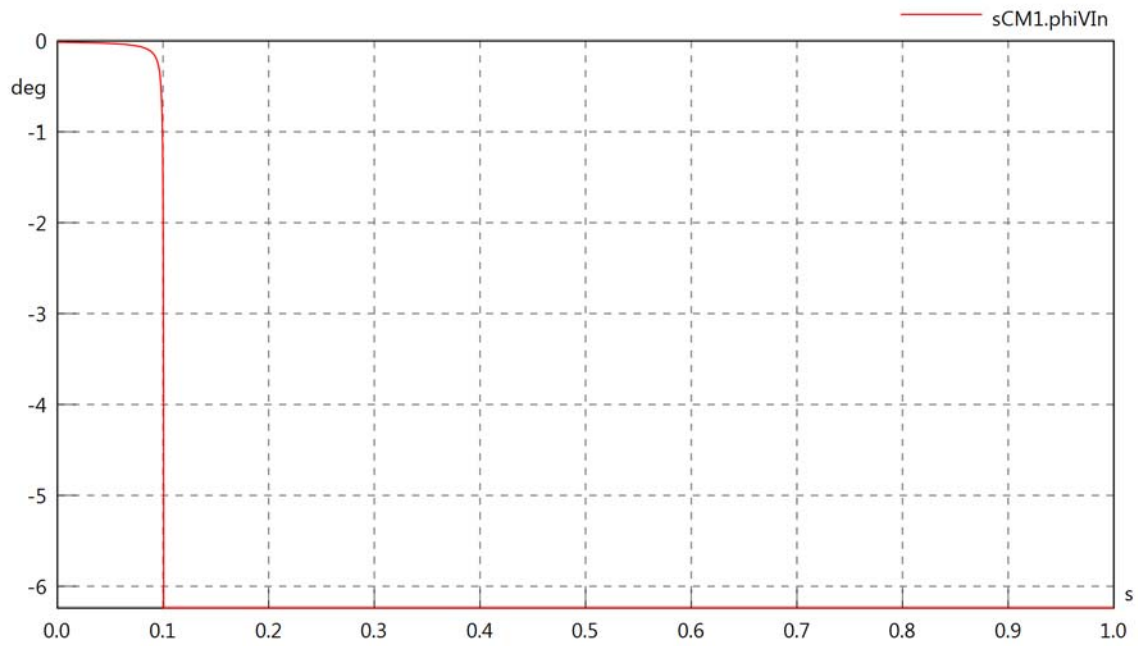

sCM1.philIn

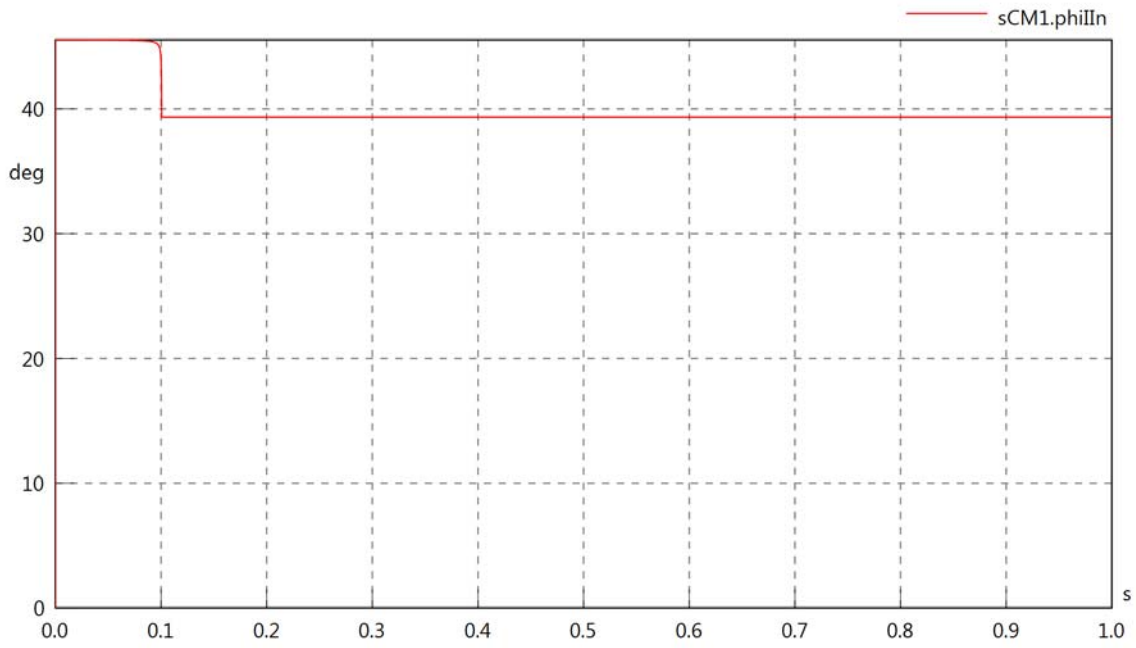

sCM1.philVIn

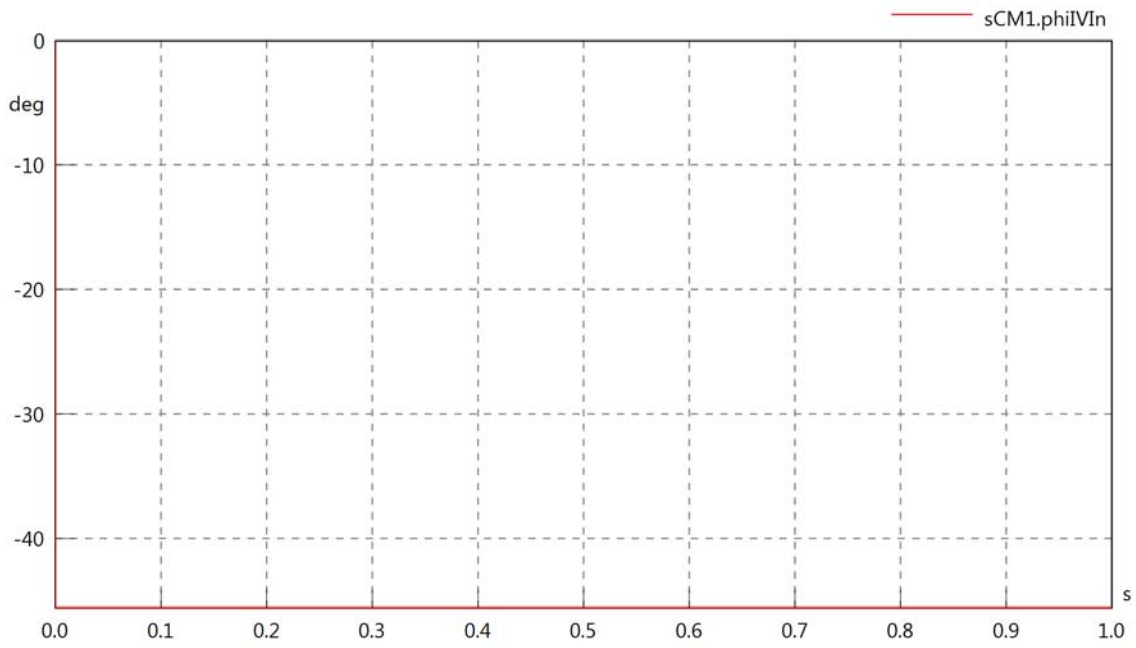

sCM1.PReIn

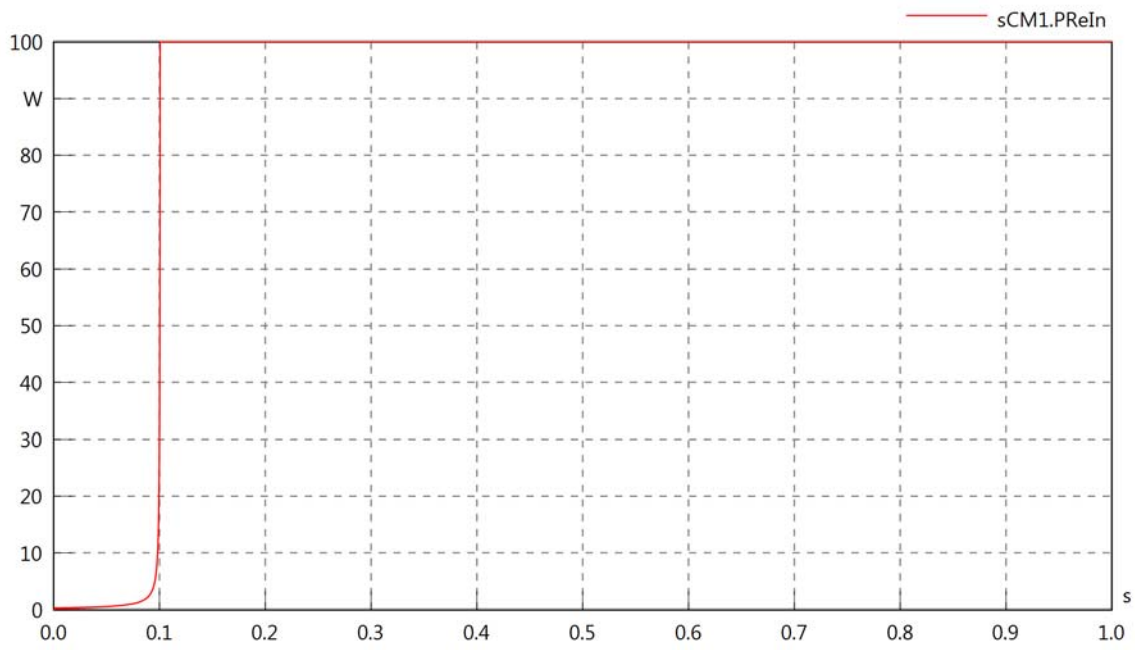

sCM1.PImIn

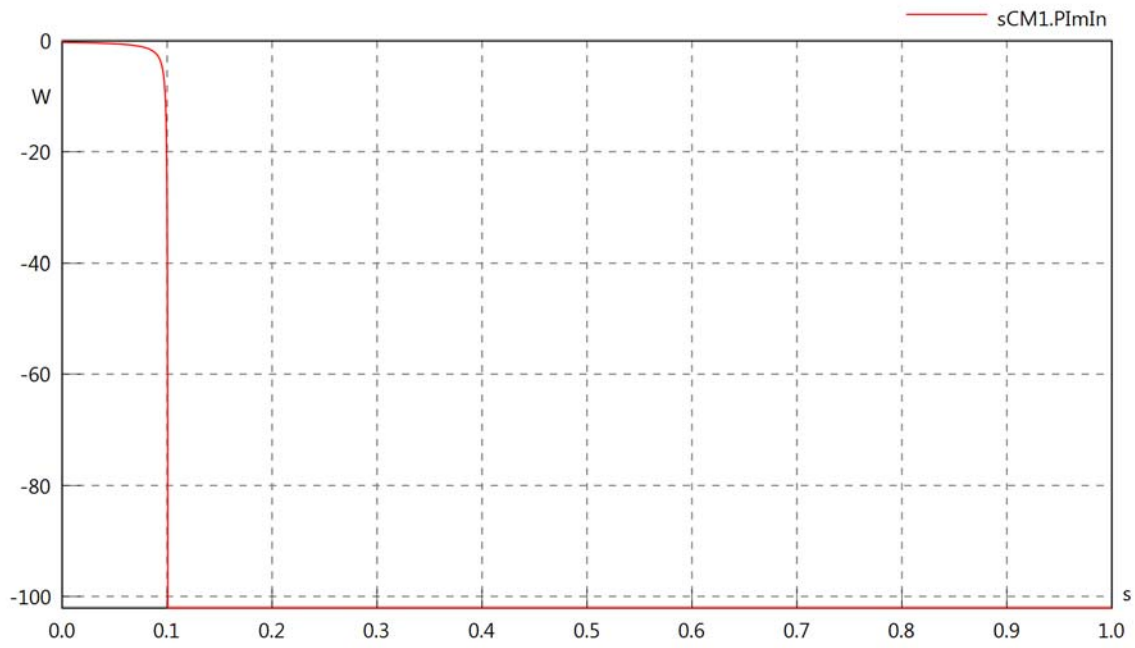

sCM1.SIn

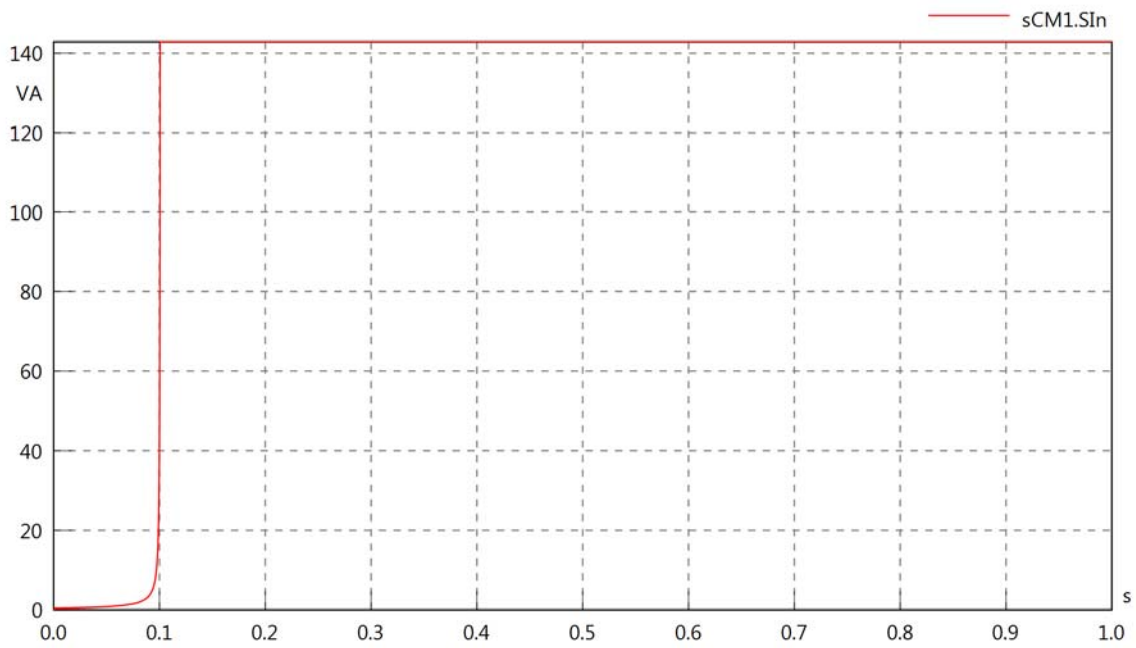

sCM1.VrmsLoad

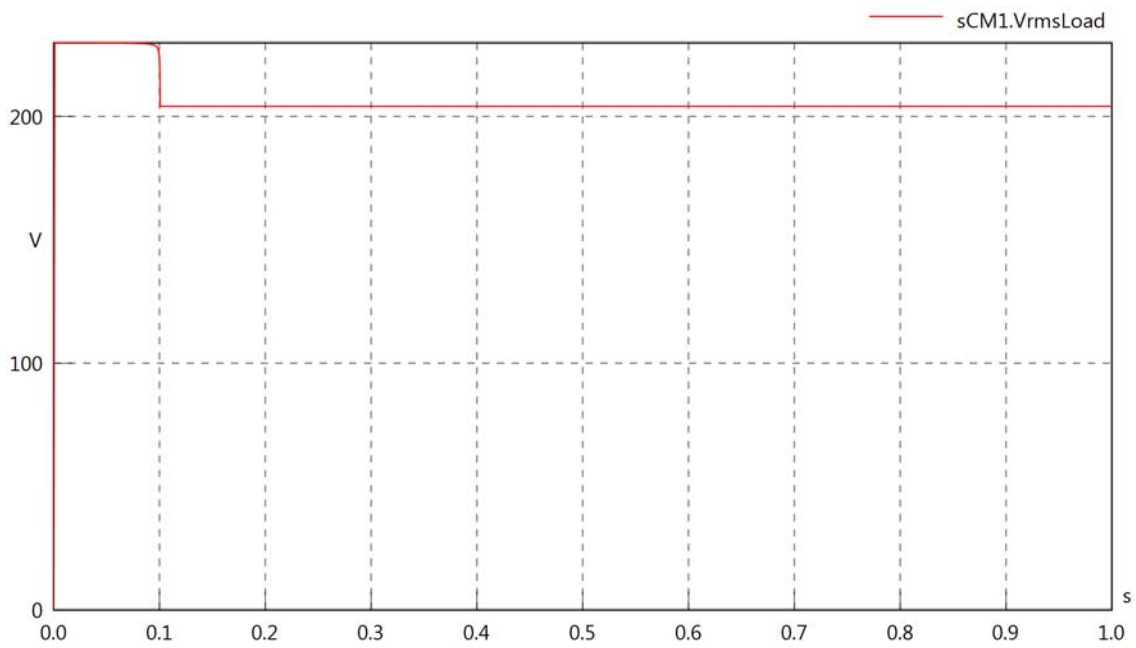

sCM1.vReLoad

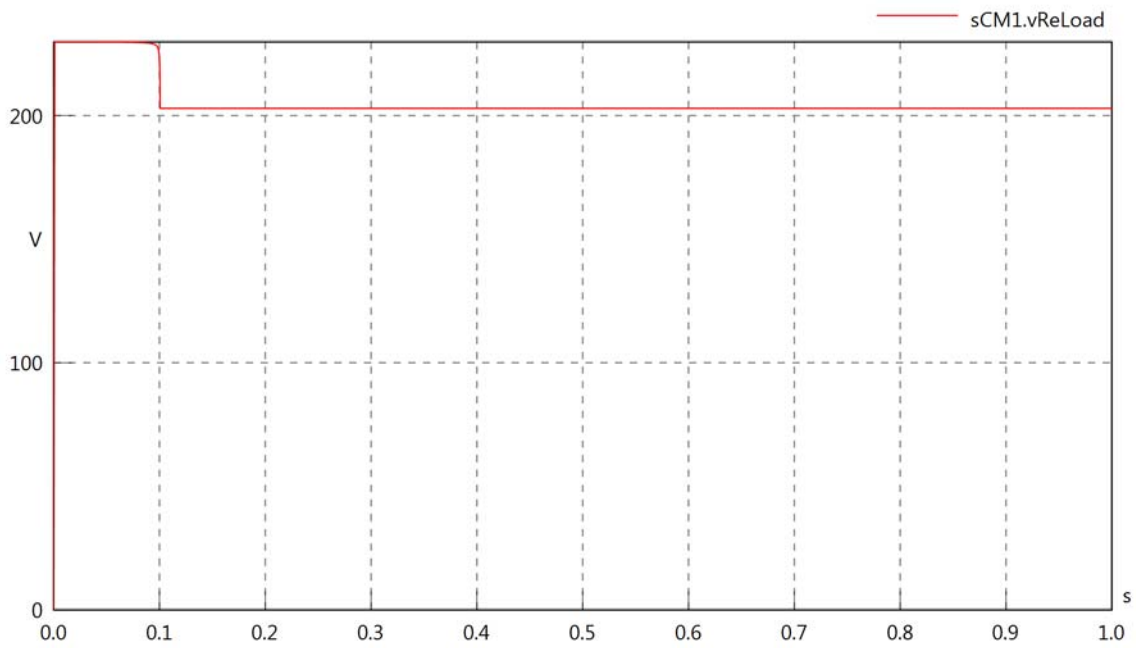

sCM1.vImLoad

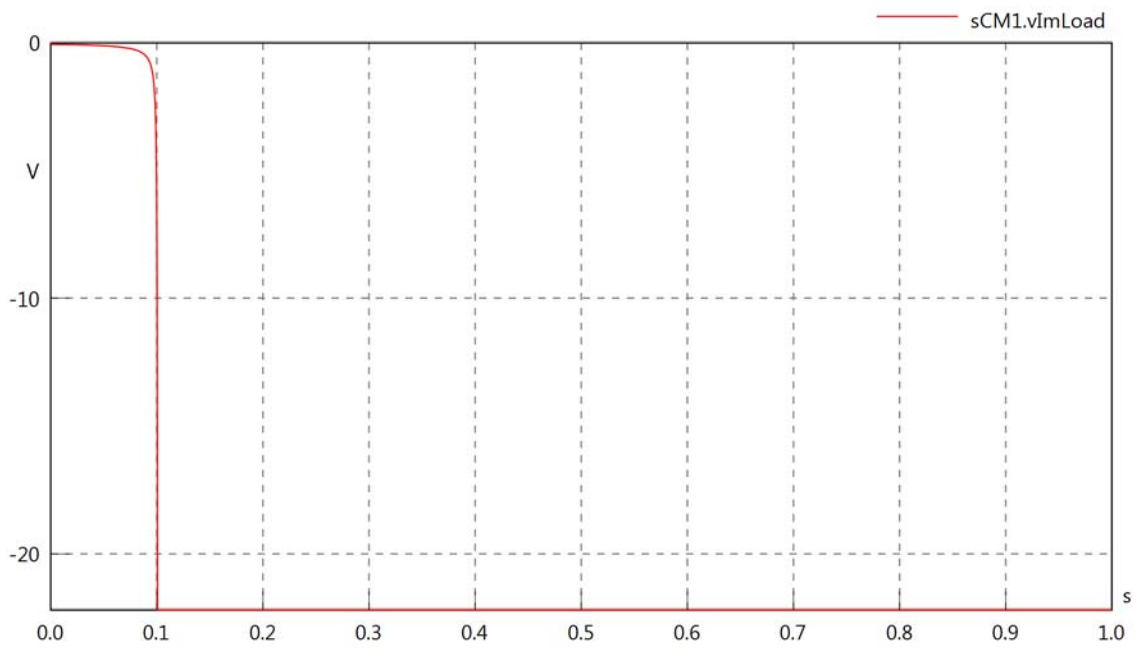

sCM1.IrmsLoad

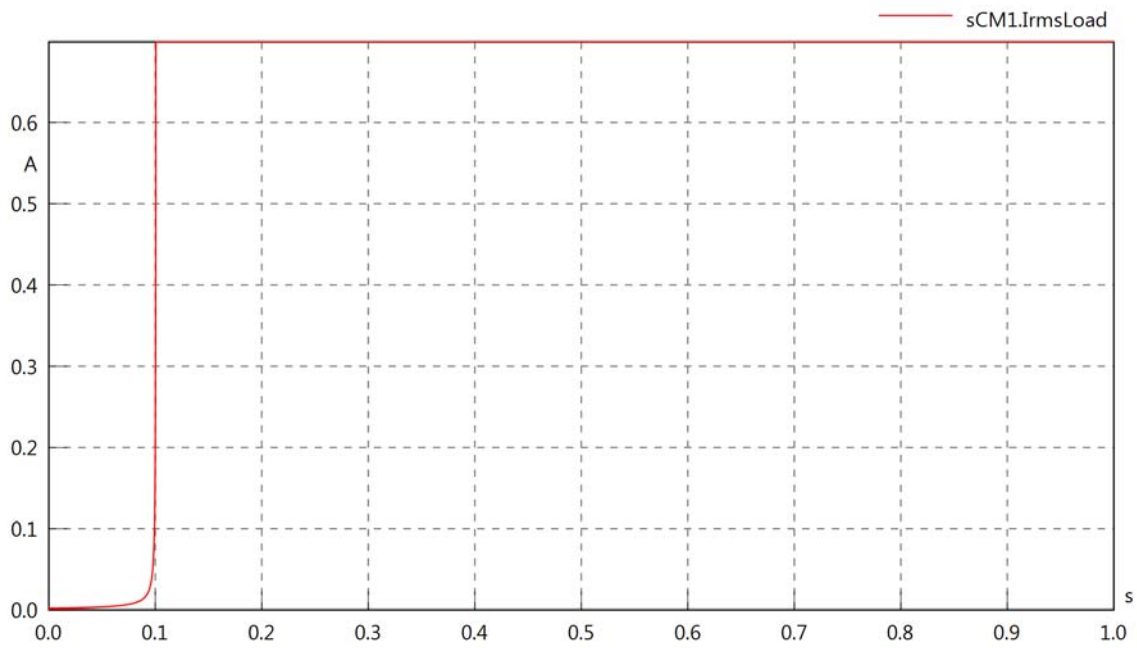

sCM1.iReLoad

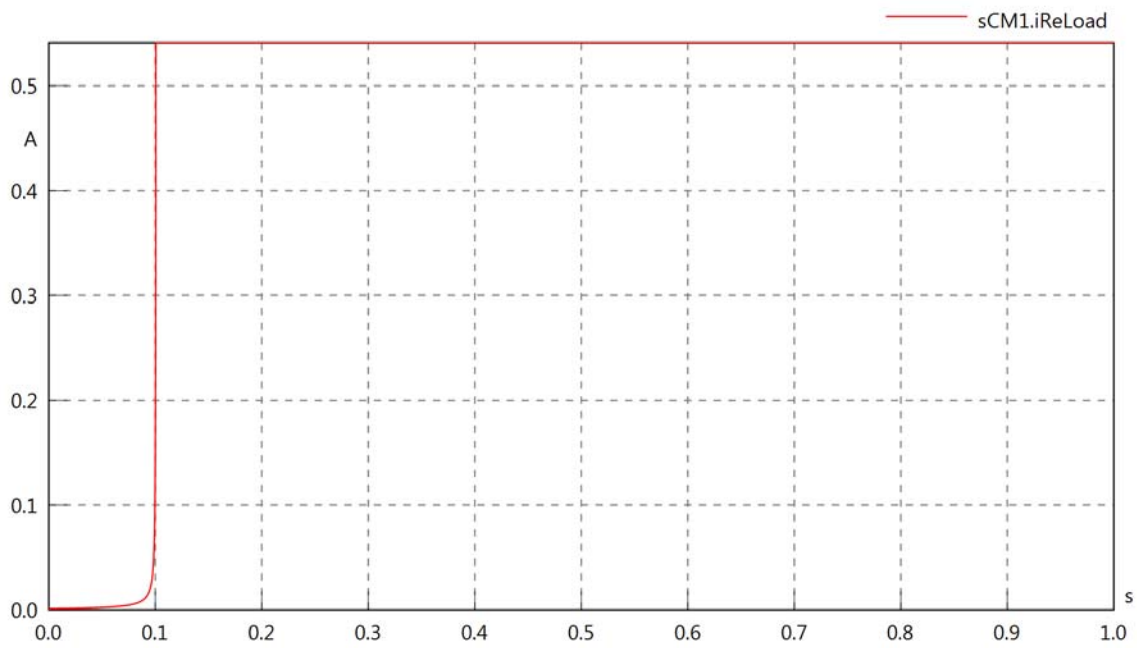

sCM1.iImLoad

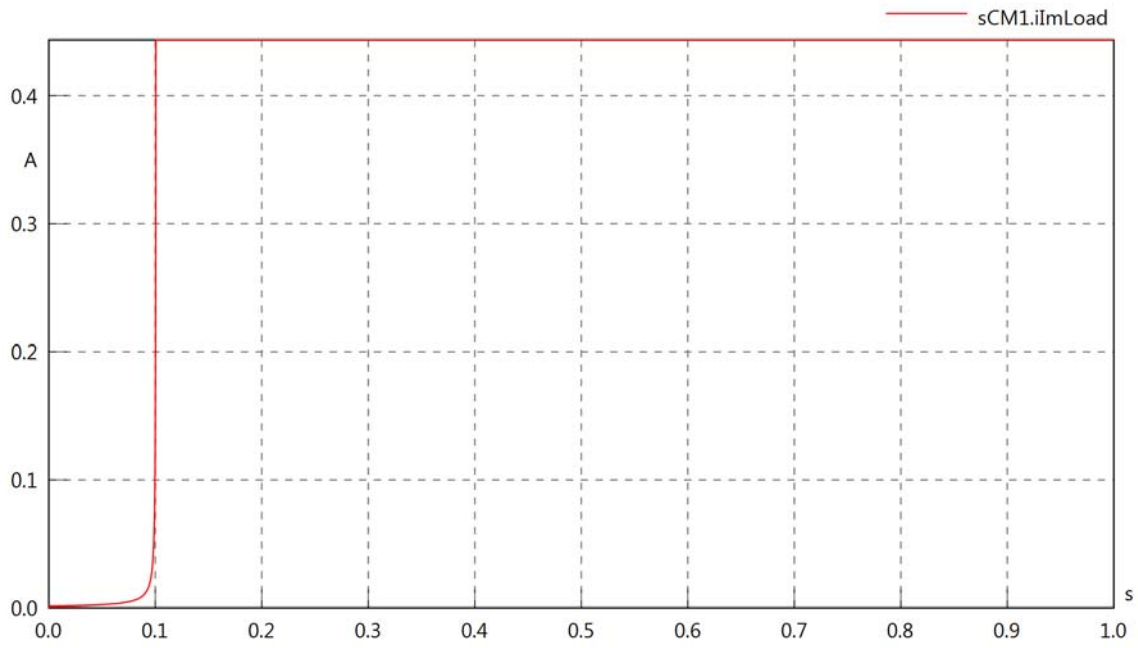

sCM1.phiVLoad

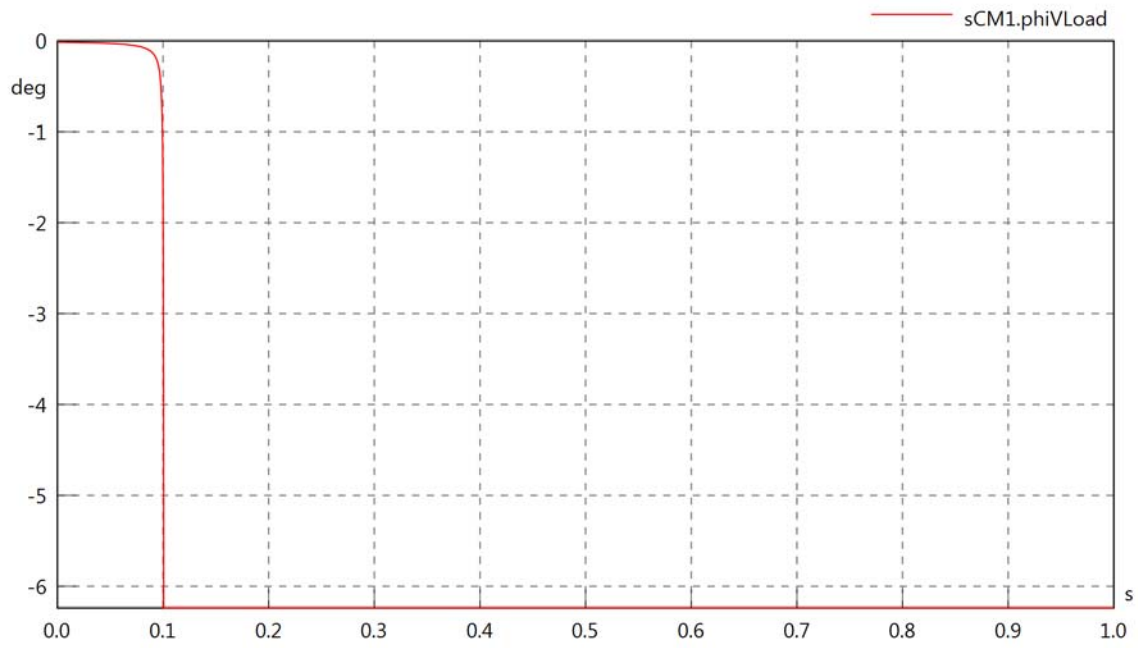

sCM1.philLoad

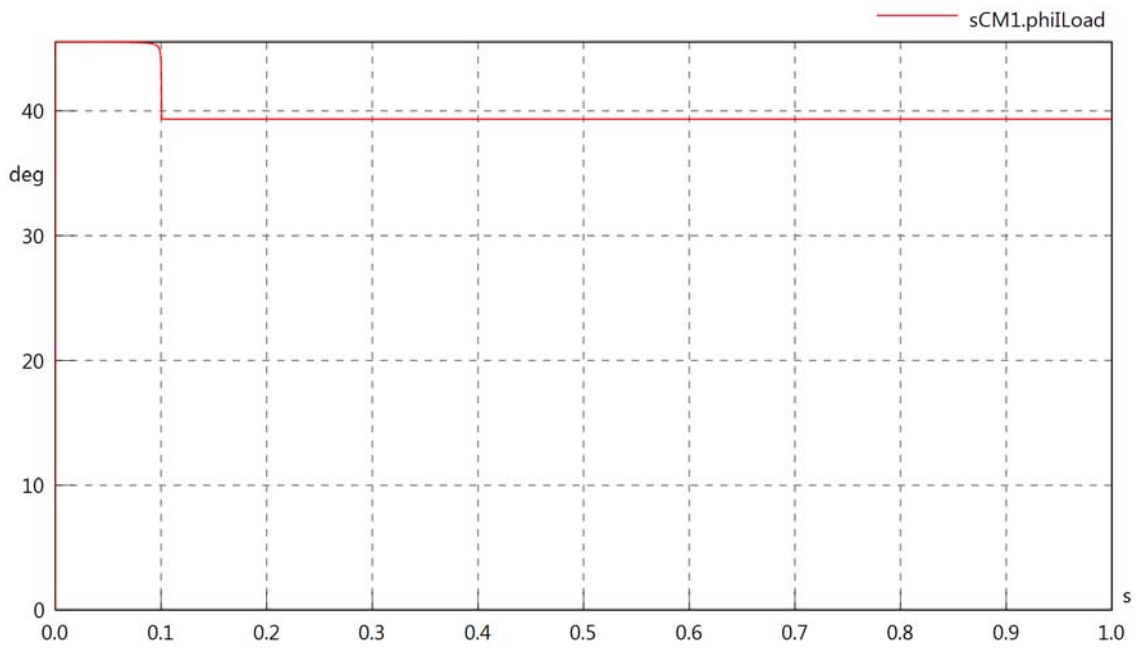

sCM1.philVLoad

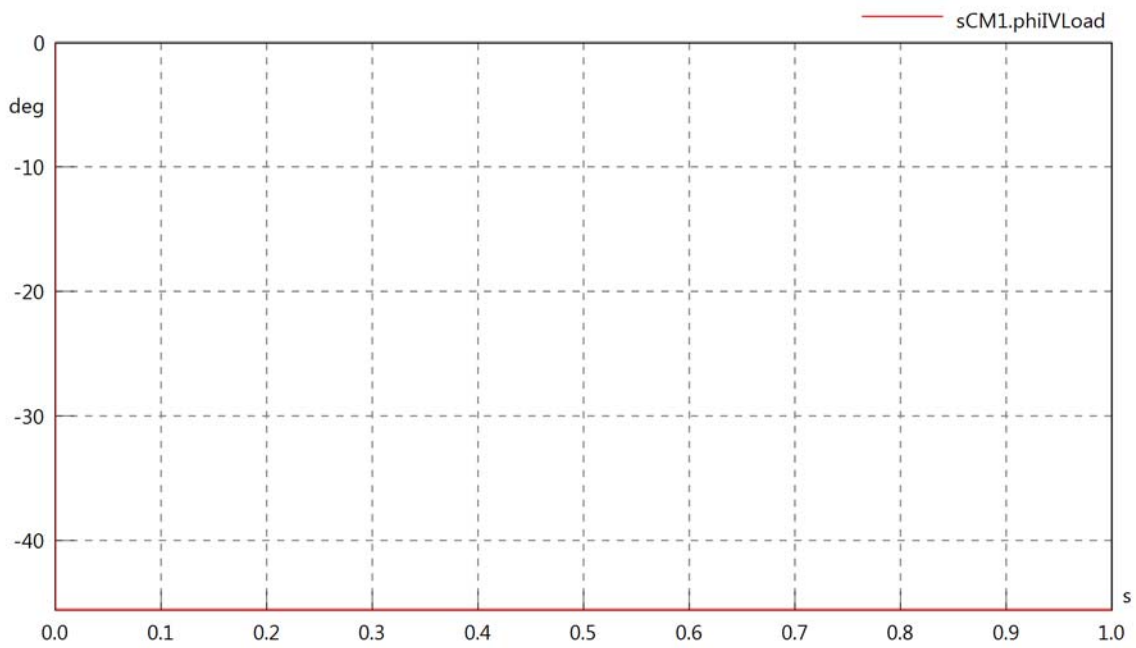

sCM1.PReLoad

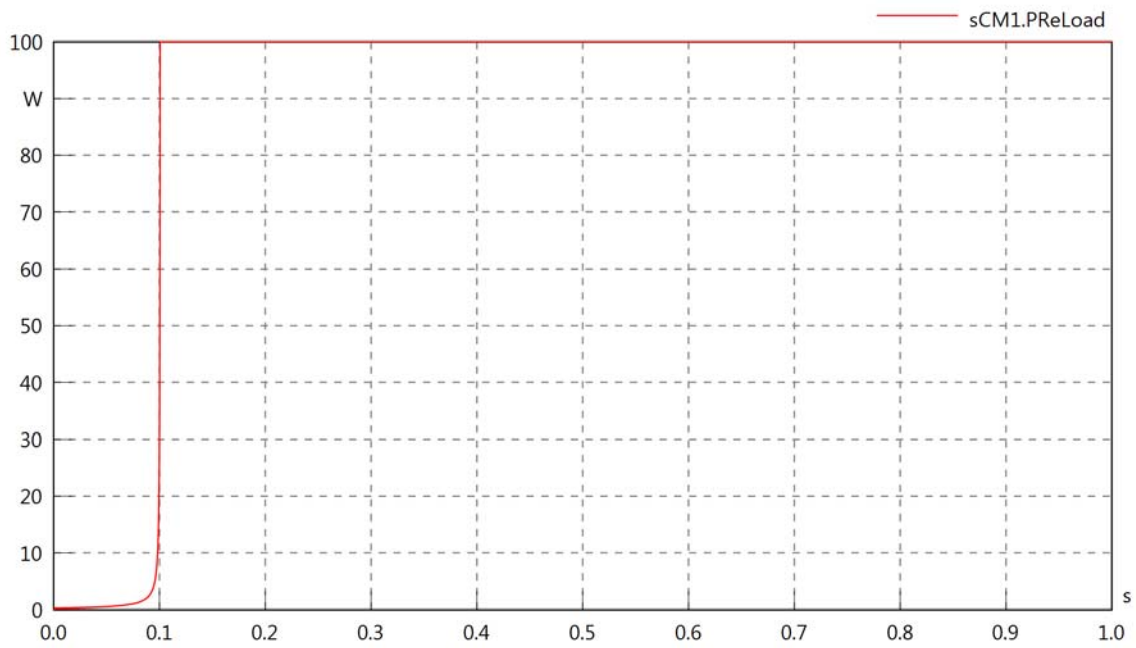

sCM1.PImLoad

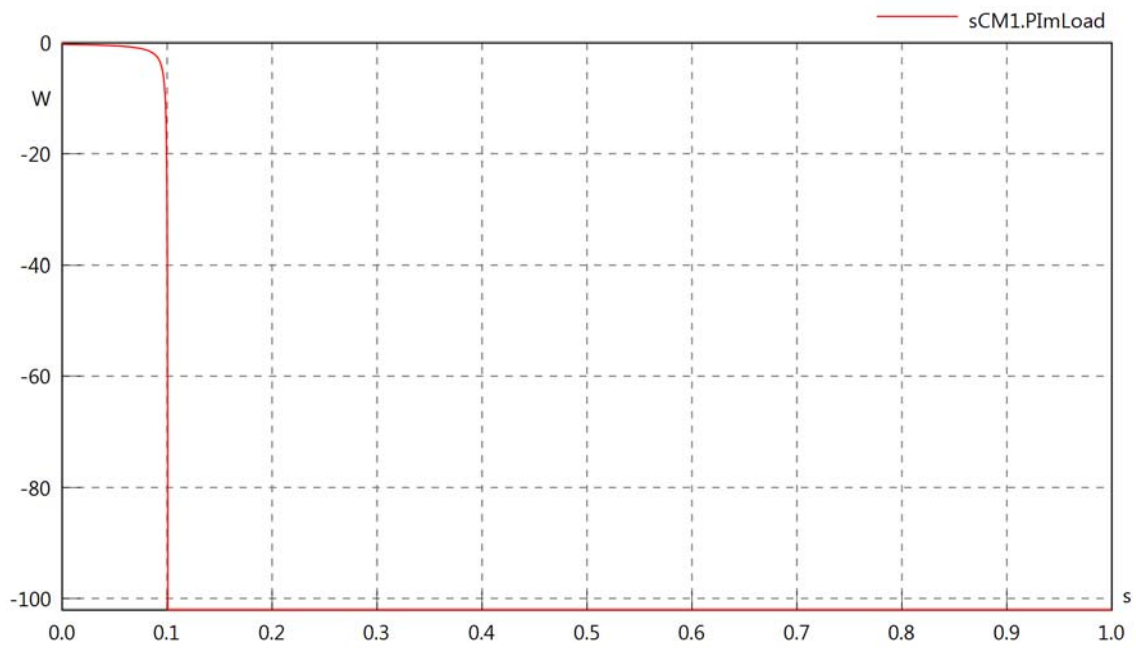

sCM1.SLoad

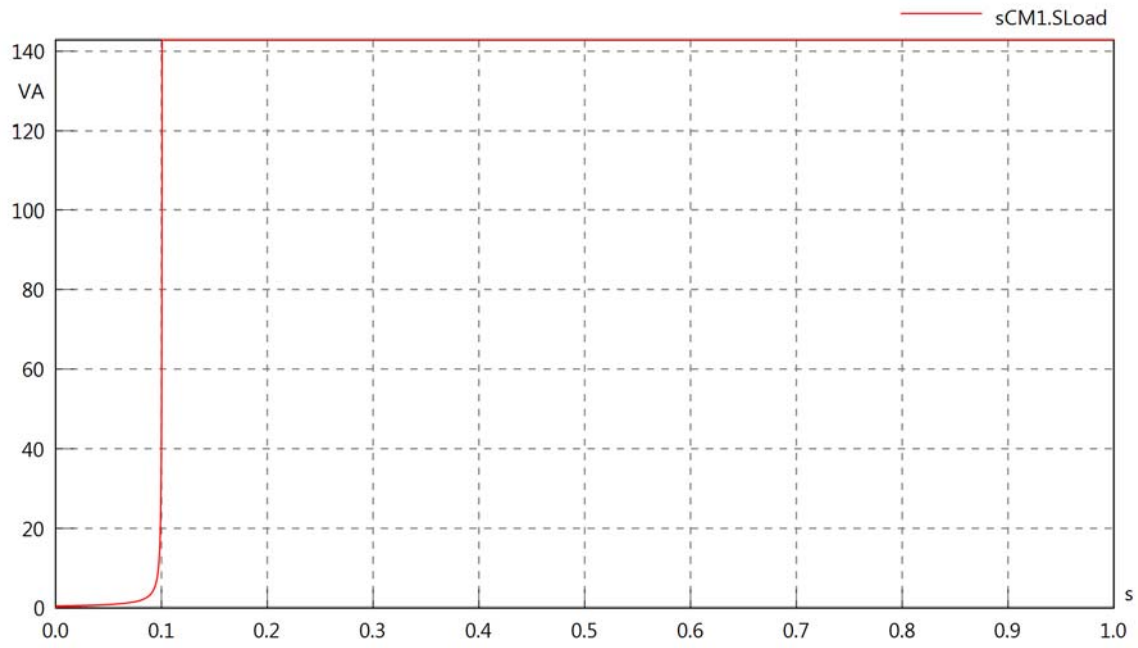
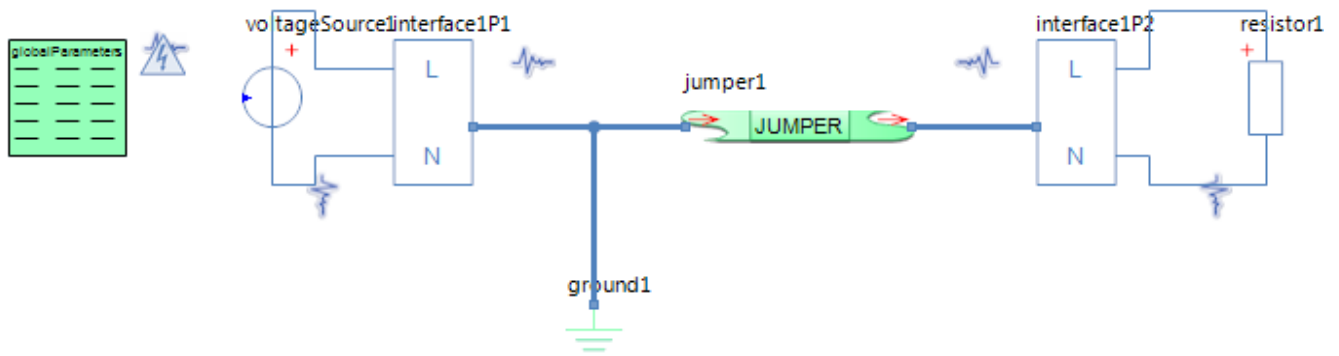

Diagram View



GlobalParameters globalParameters
Parameters

Comment	Name	Current Value	Unit
Type of Calculation	eCalculationKind	Signal Calculation	
Description of Frequency	eFrequencyKind	Linear	
Minimum Frequency	fMin	60	[Hz]
Maximum Frequency	fMax	60	[Hz]

Jumper jumper1
Parameters

Comment	Name	Current Value	Unit
Resistance per length for each Line at 20 °C (68 °F)	r	1	[Ohm/km]
Inductance per length for each Line	l	0.5	[mH/km]
Conductance per length between Lines	g	1e-10	[1/(Ohm·m)]
Capacitance per length between Lines	c	0.1	[µF/km]
Length of Jumper for each Line	length	10	[km]
Temperature of the conductor	temp	5	[°C]
Skin effect	skinEff	Round, stranded or solid copper conductor	
Conductor area	area	6	[mm²]

Voltage Source voltageSource1
Parameters

Comment	Name	Current Value	Unit
Voltage RMS	VrmsSrc	min(230,230000*t)	[V]
Phase	phi	0	[deg]

Resistor resistor1
Parameters

Comment	Name	Current Value	Unit
Resistance	R	100	[Ohm]

jumper1.rTemp

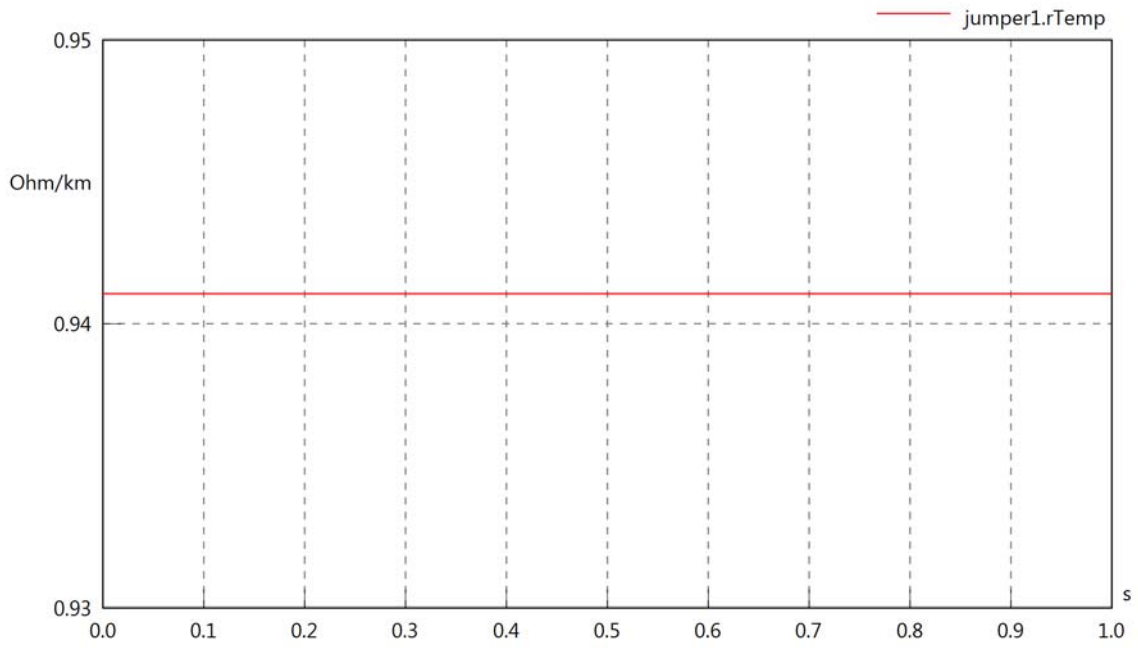

jumper1.skinDepth

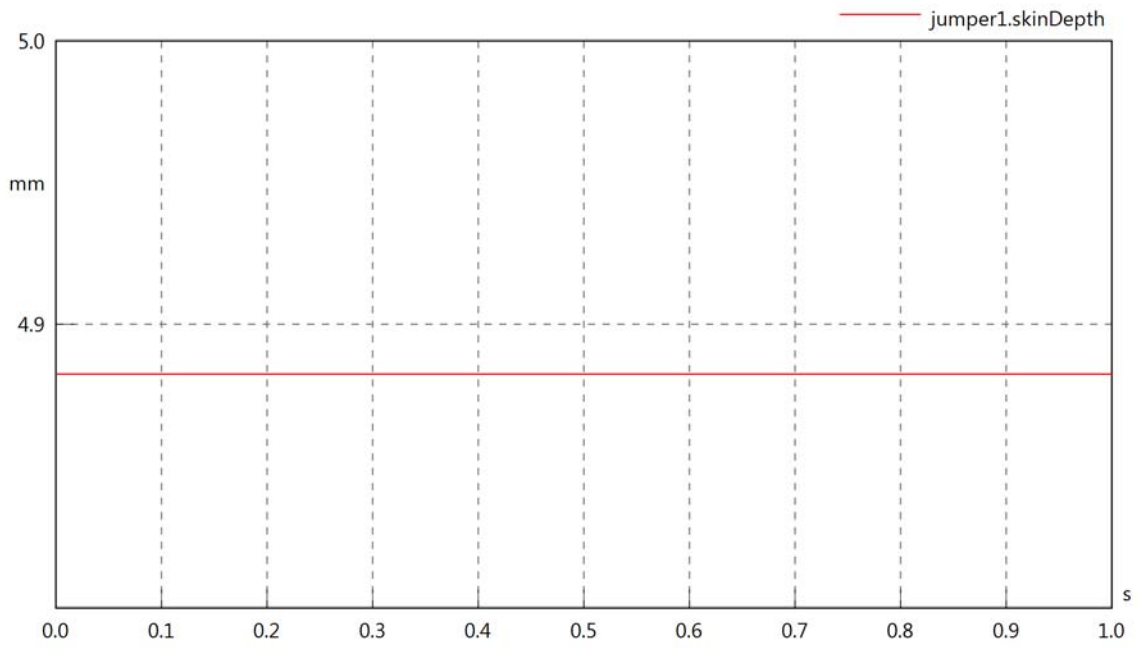

jumper1.diameter

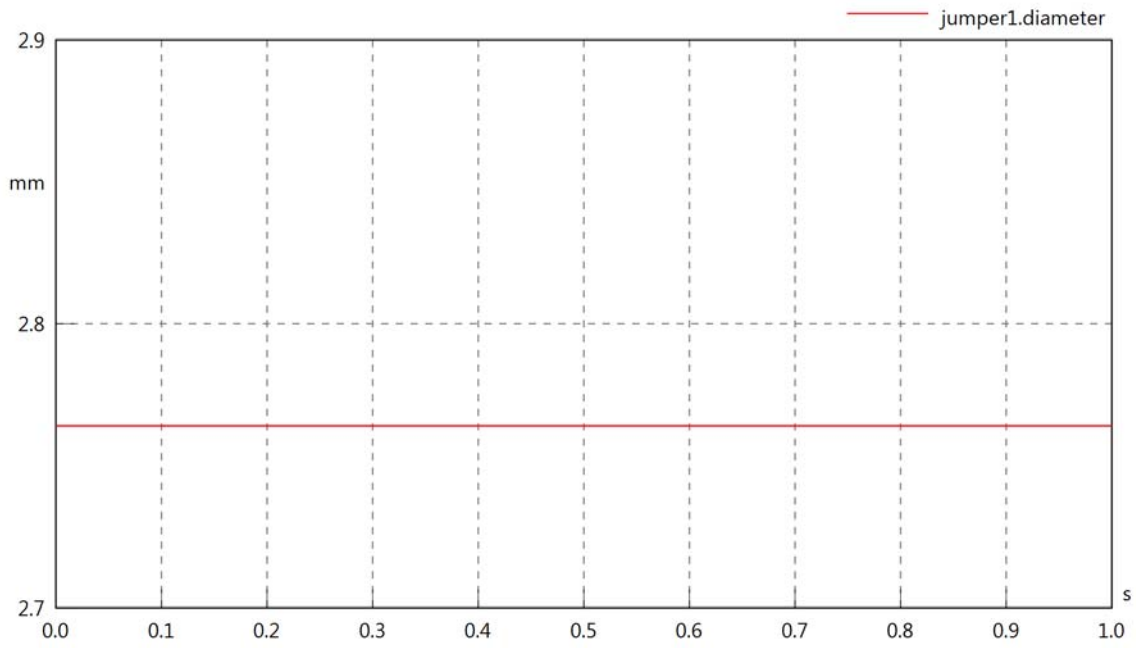

jumper1.resistivity

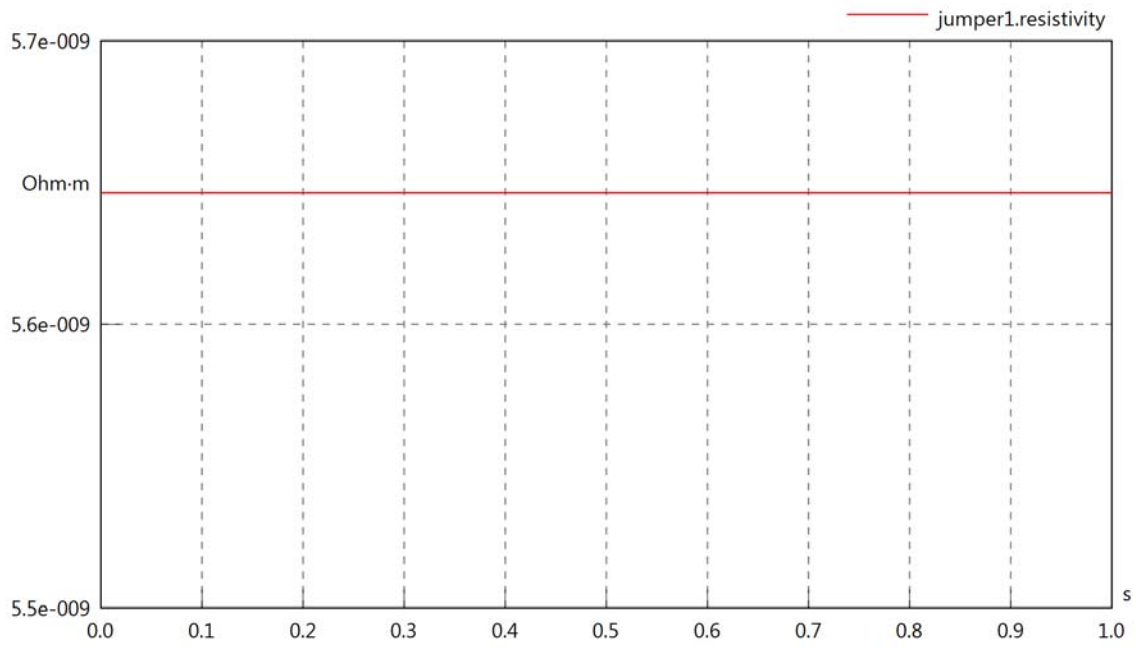

jumper1.rInternal

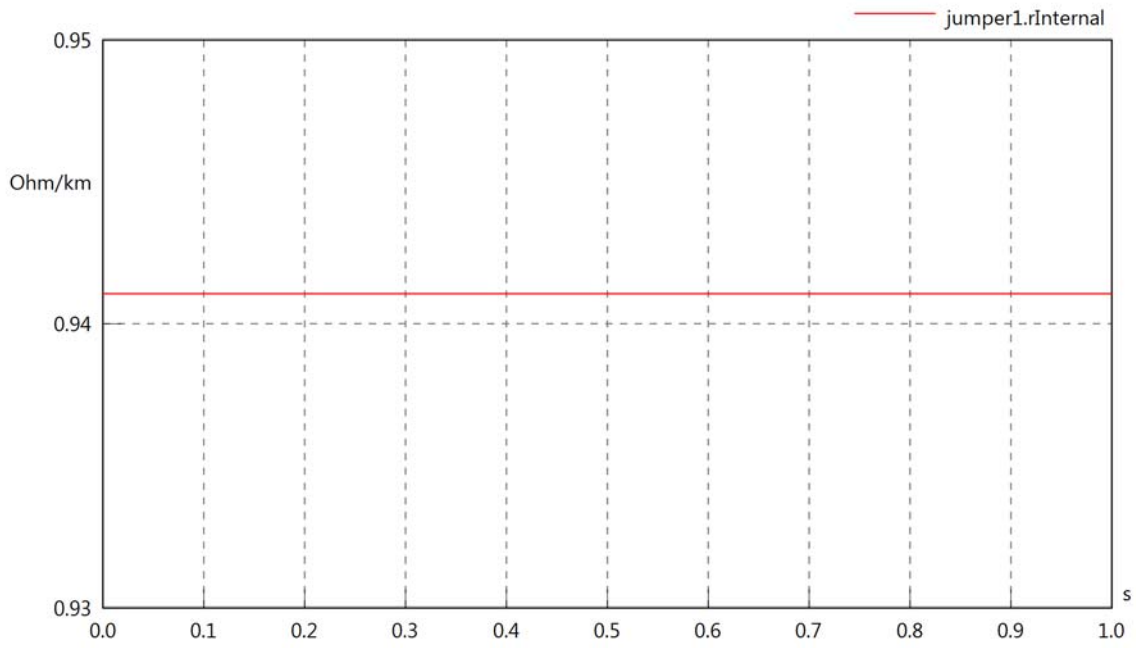

jumper1.VrmsIn

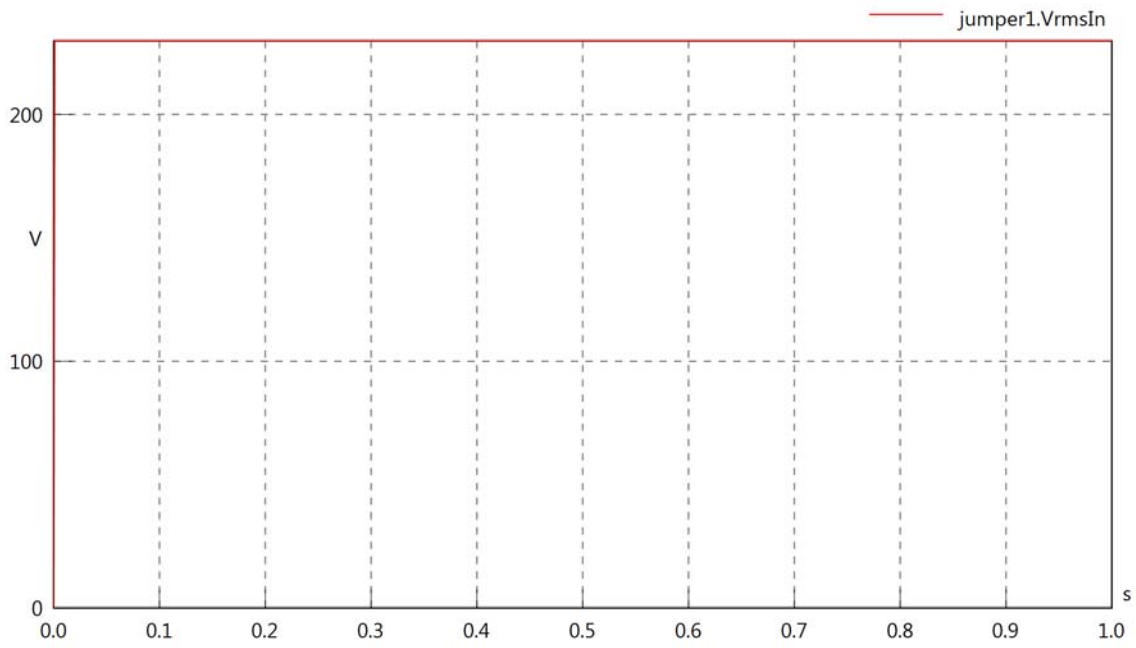

jumper1.vReIn

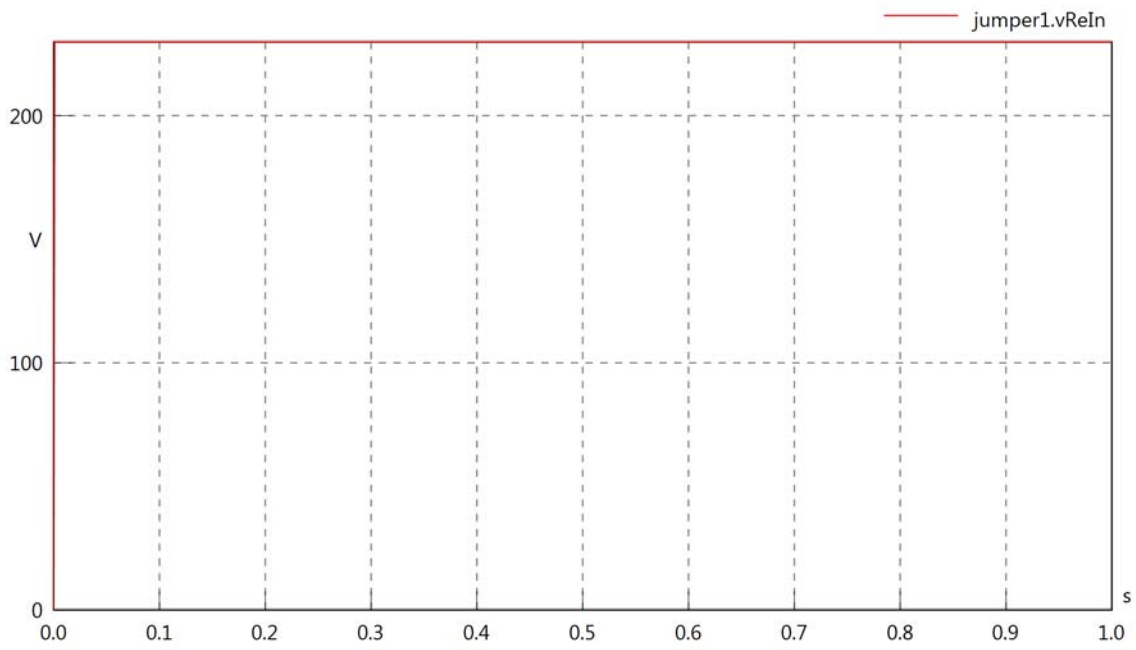

jumper1.vImIn

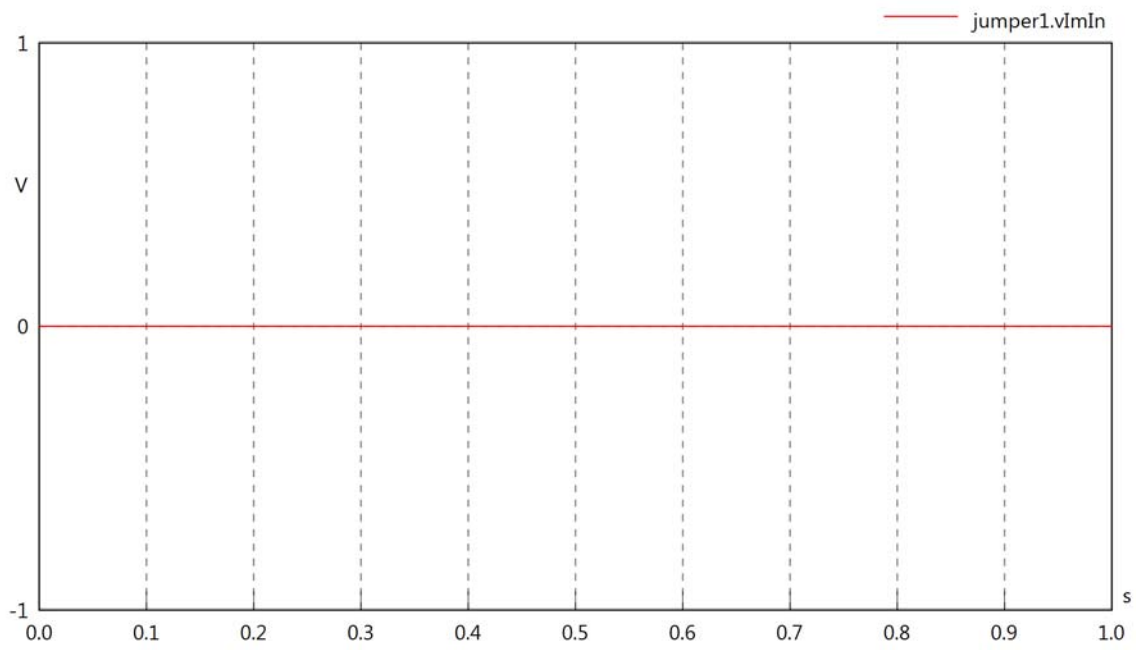

jumper1.VrmsOut

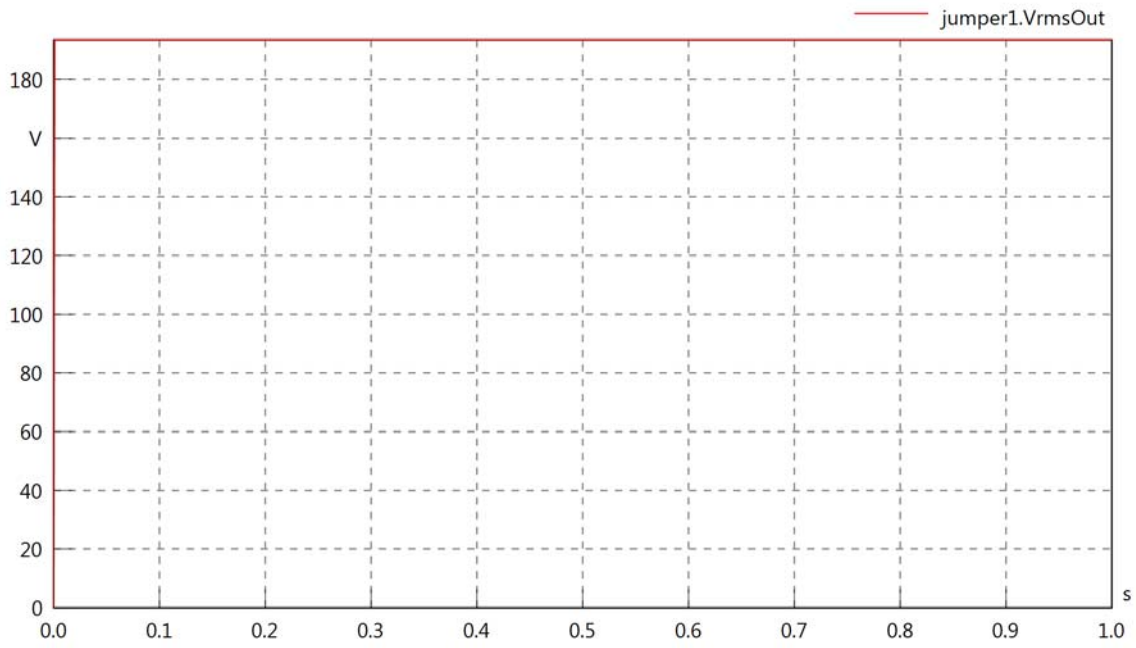

jumper1.vReOut

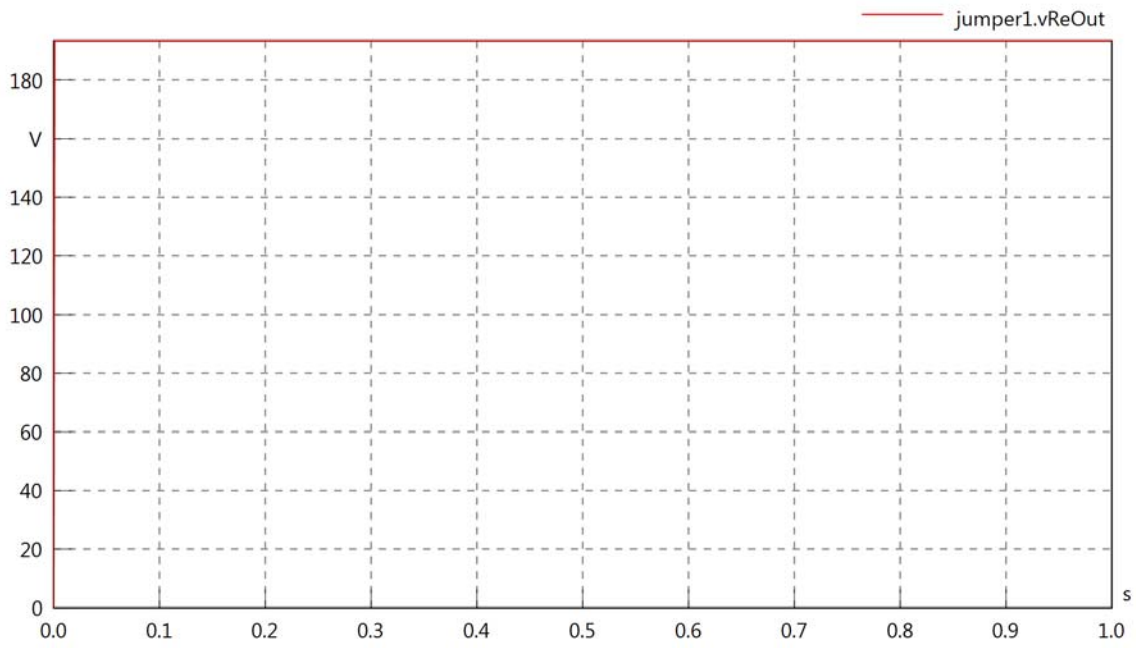

jumper1.vImOut

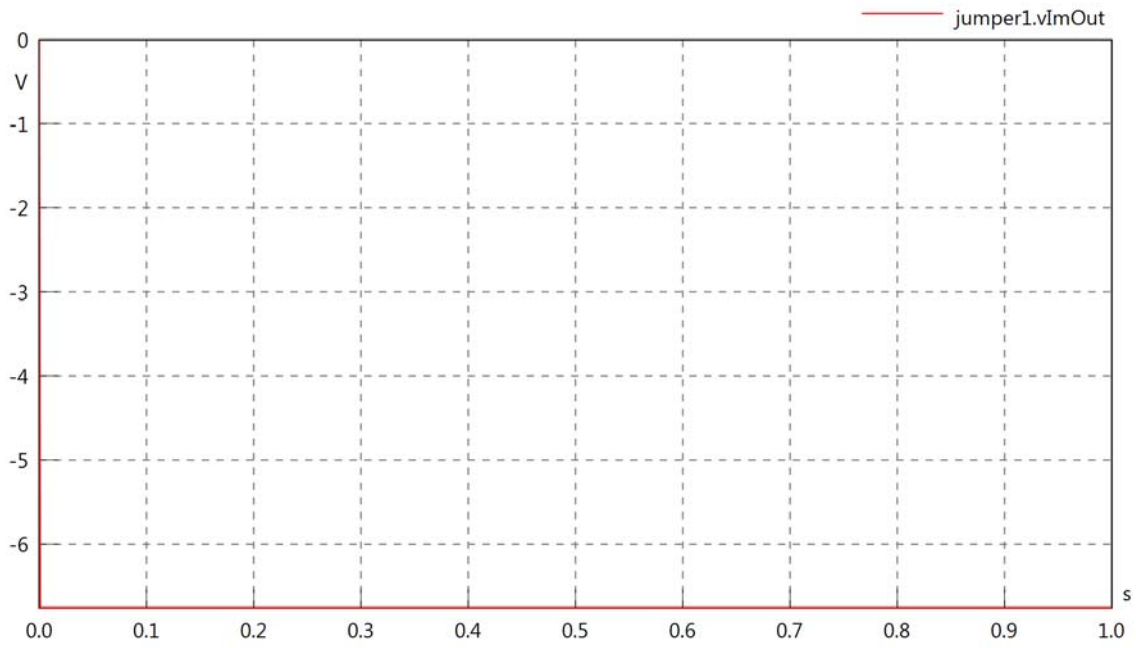

jumper1.Vrms

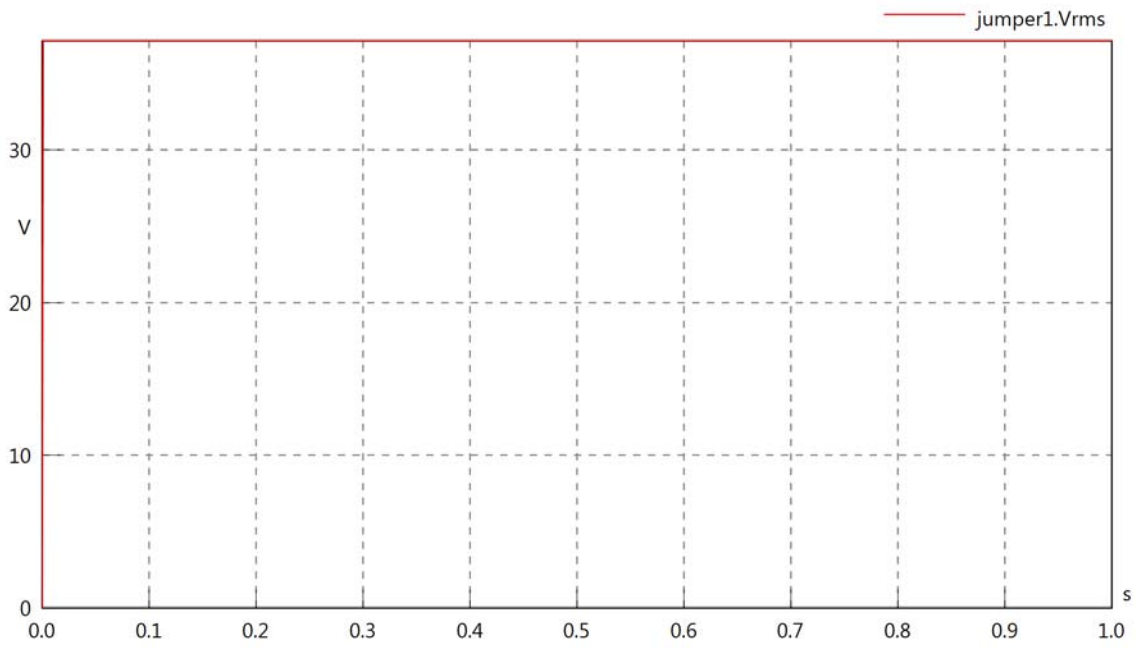

jumper1.vRe

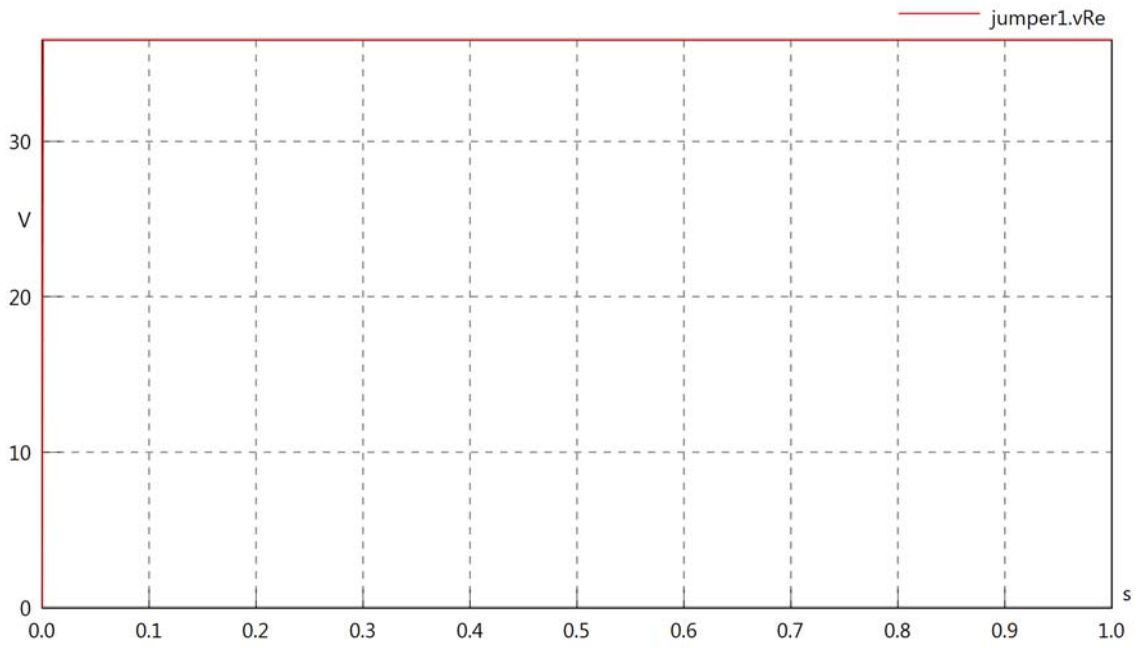

jumper1.vIm

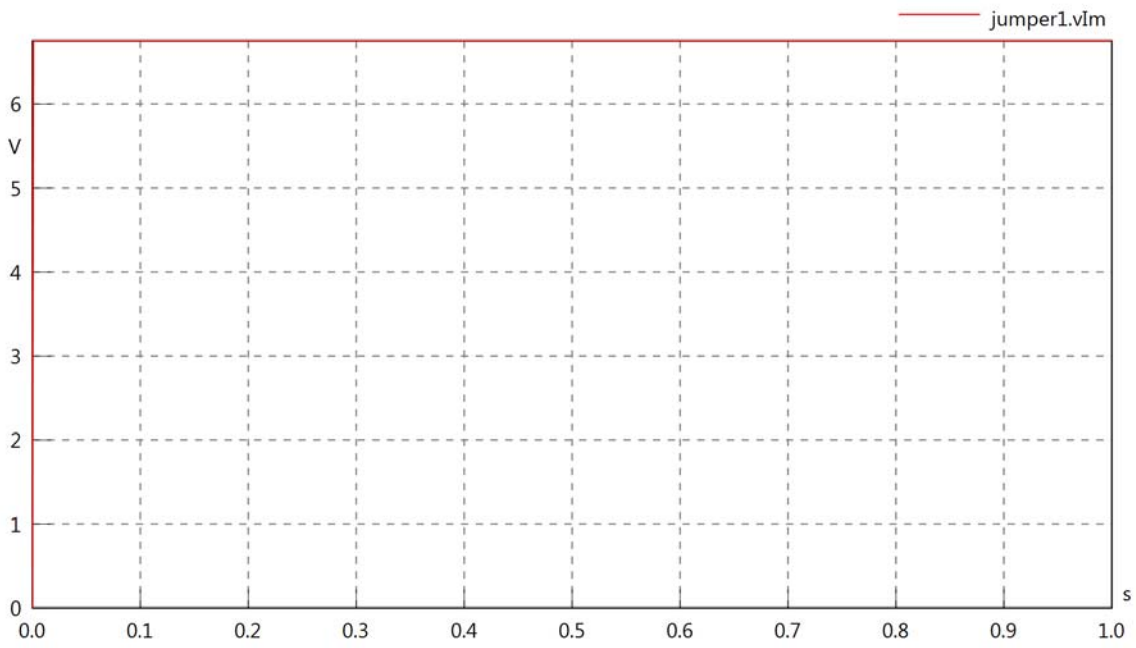

jumper1.IrmsIn

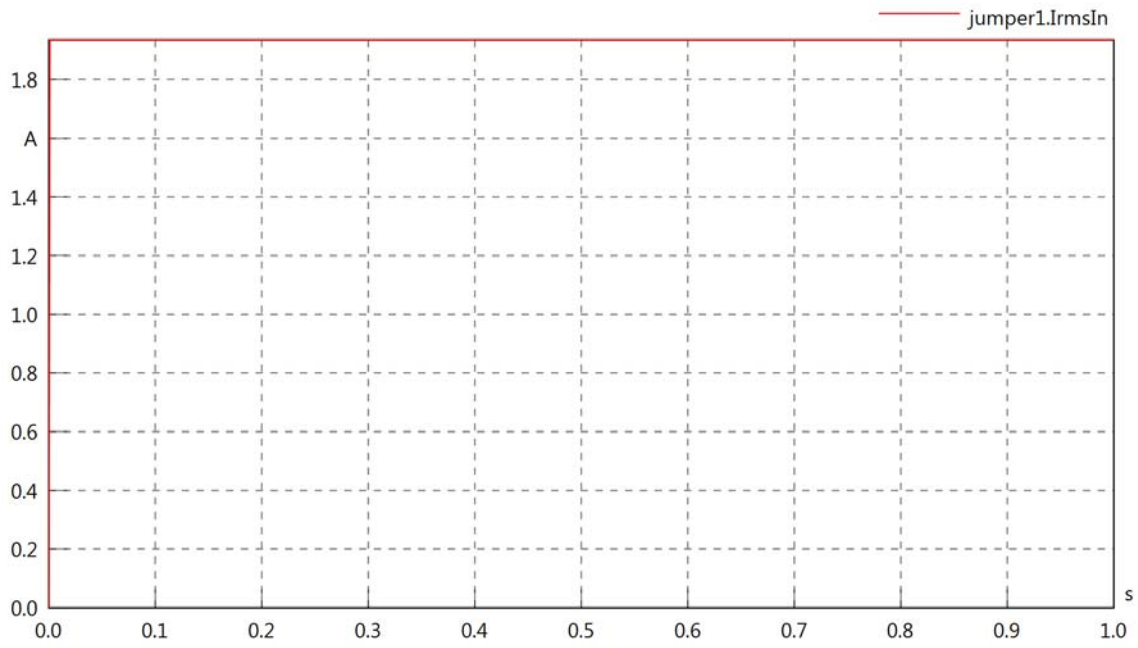

jumper1.iReIn

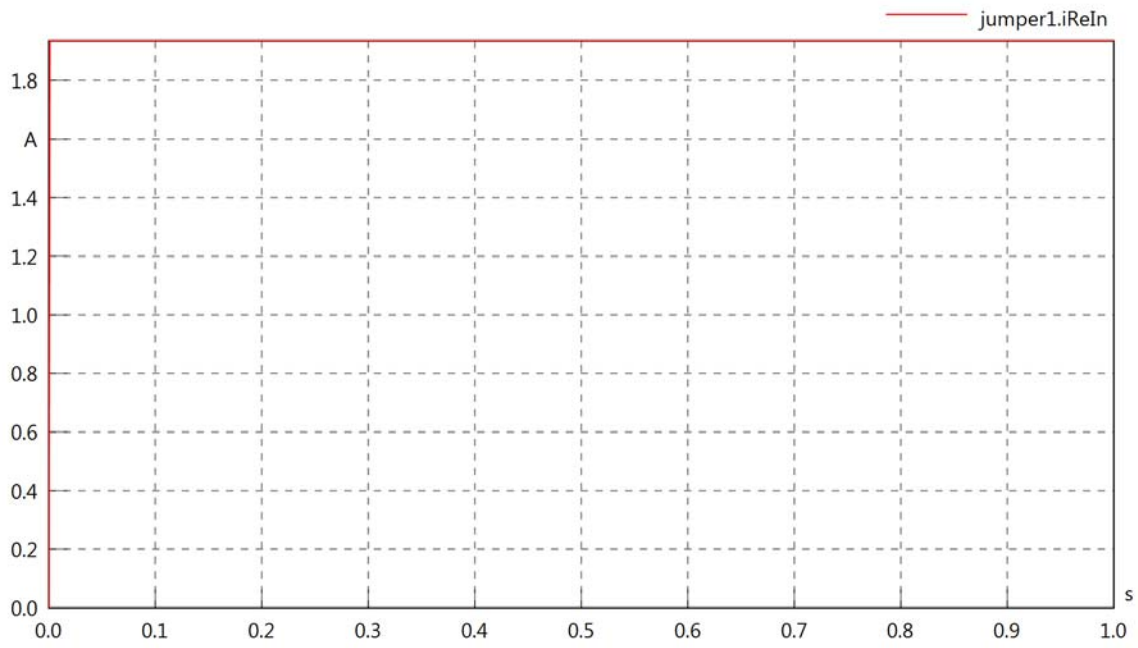

jumper1.ilmIn

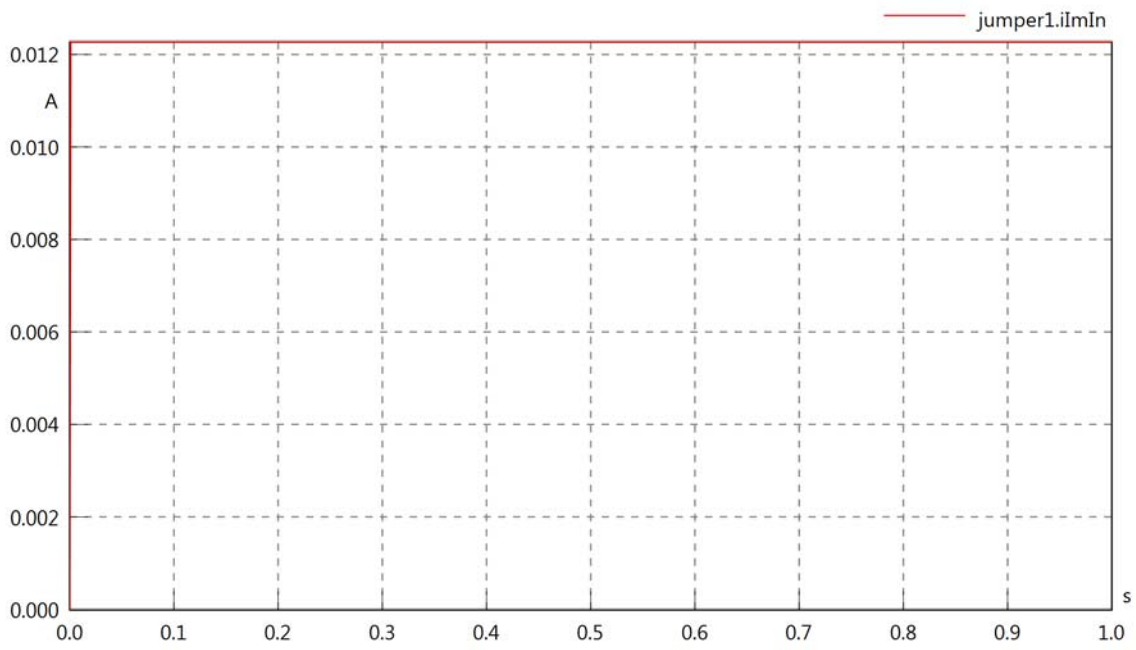

jumper1.IrmsOut

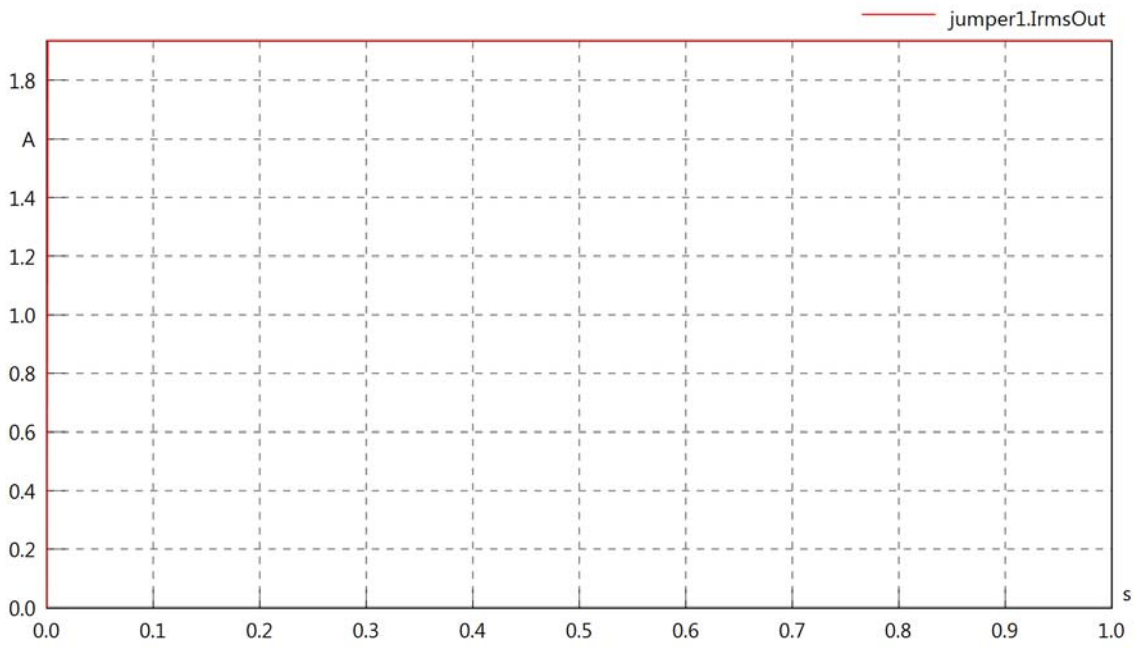

jumper1.iReOut

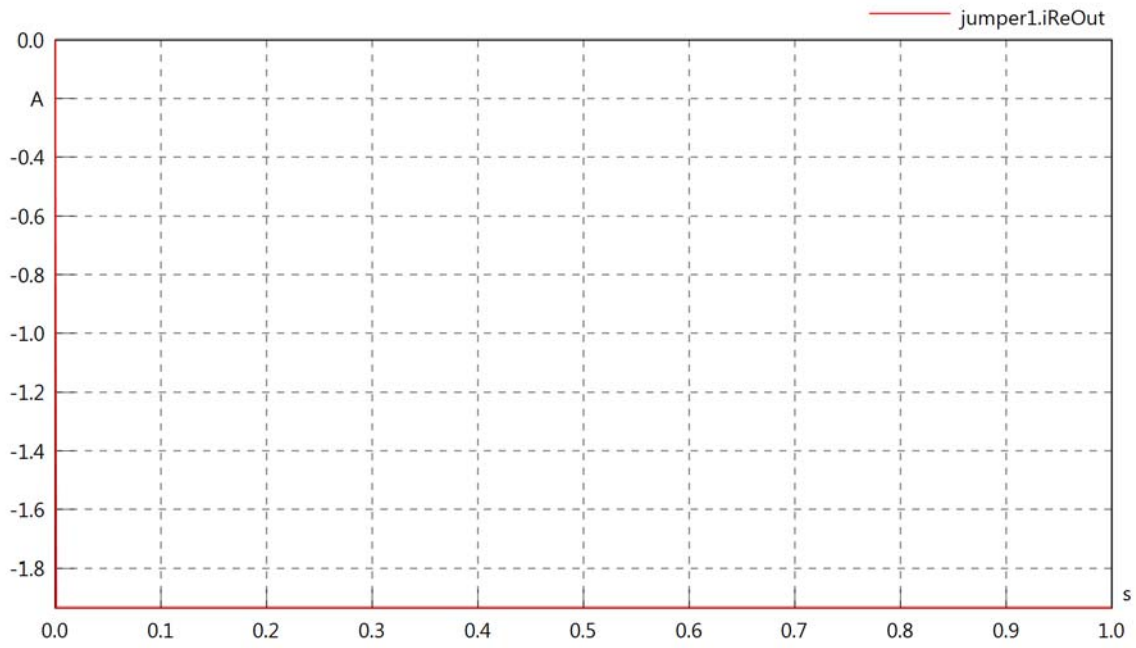

jumper1.iImOut

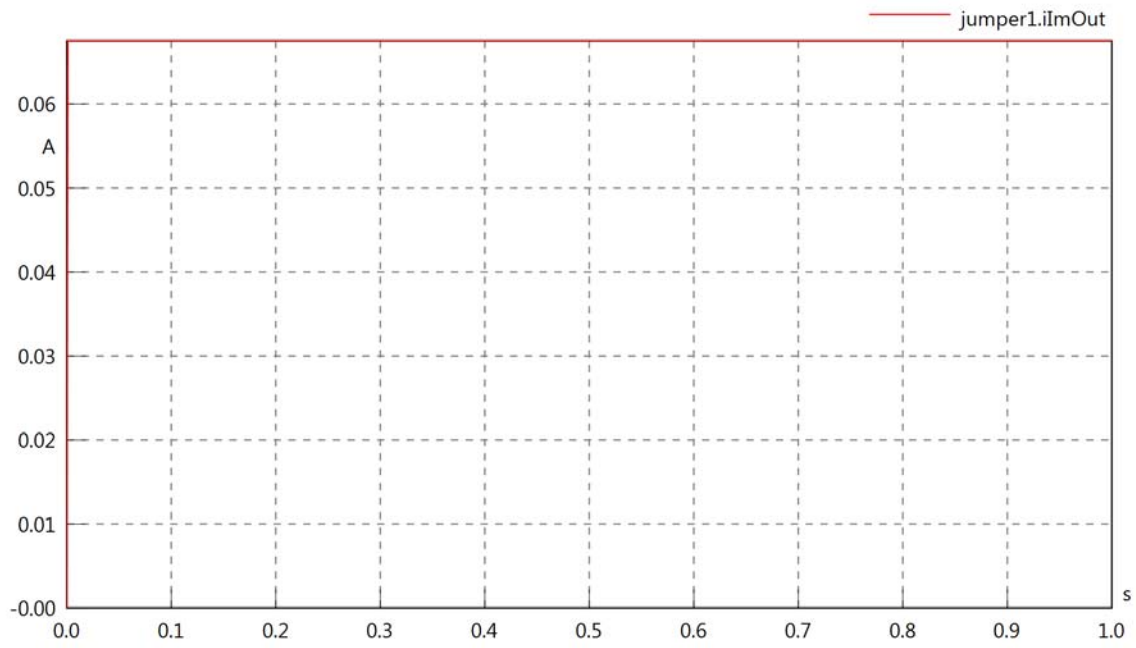

jumper1.phiVIn

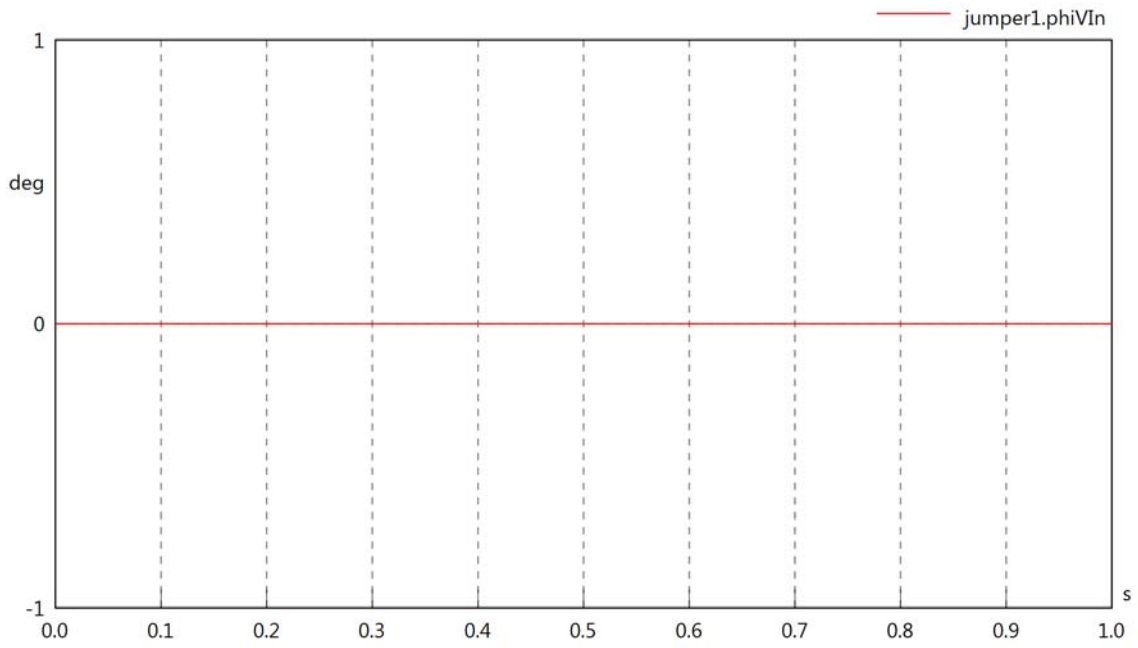

jumper1.phiIn

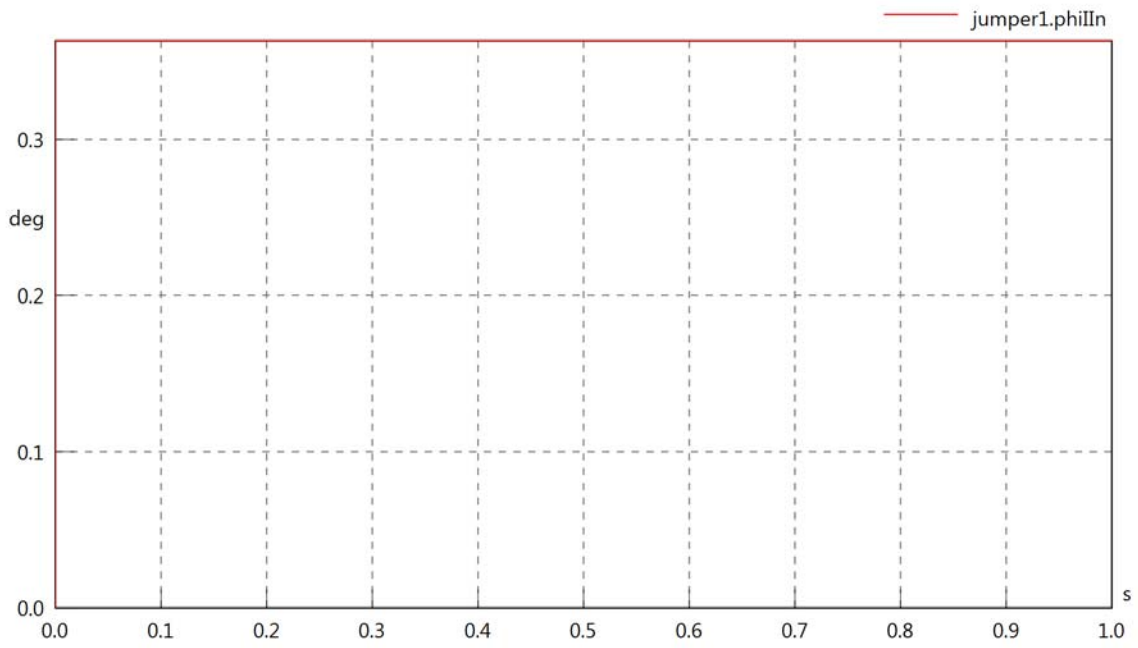

jumper1.phiVIn

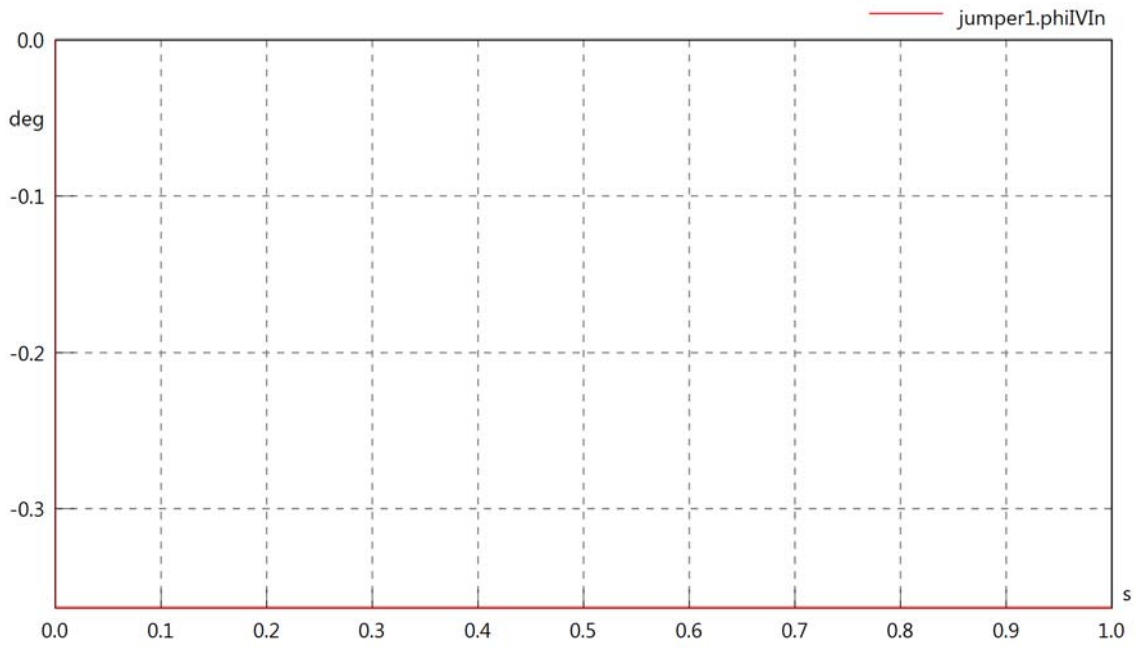

jumper1.phiVOut

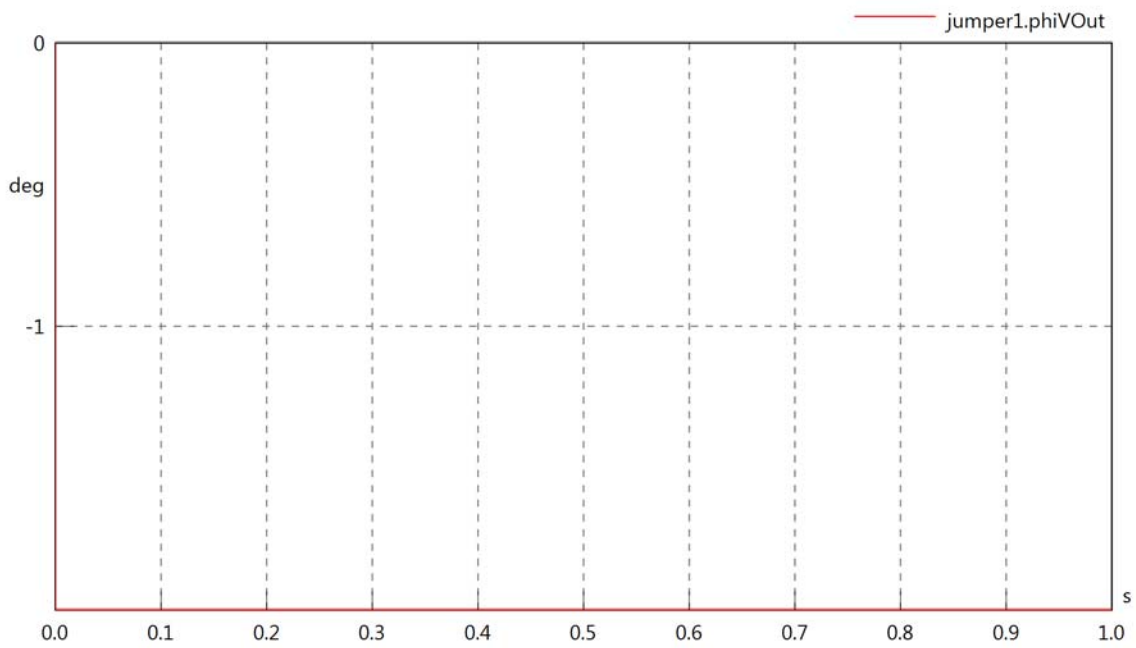

jumper1.phiIOut

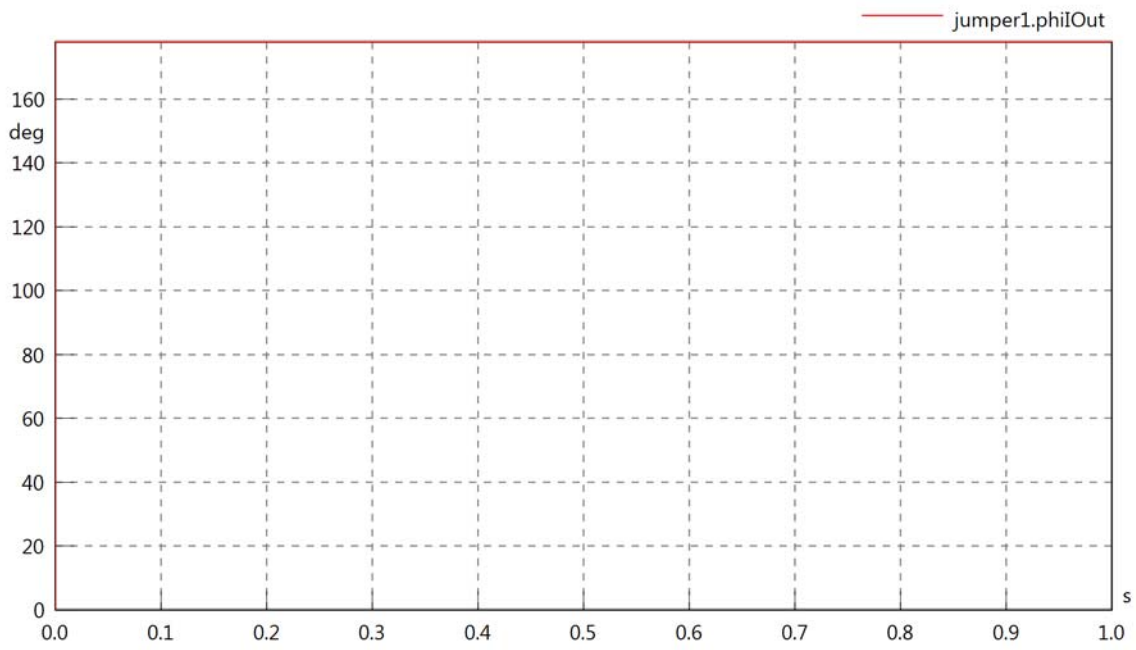

jumper1.phiIVOut

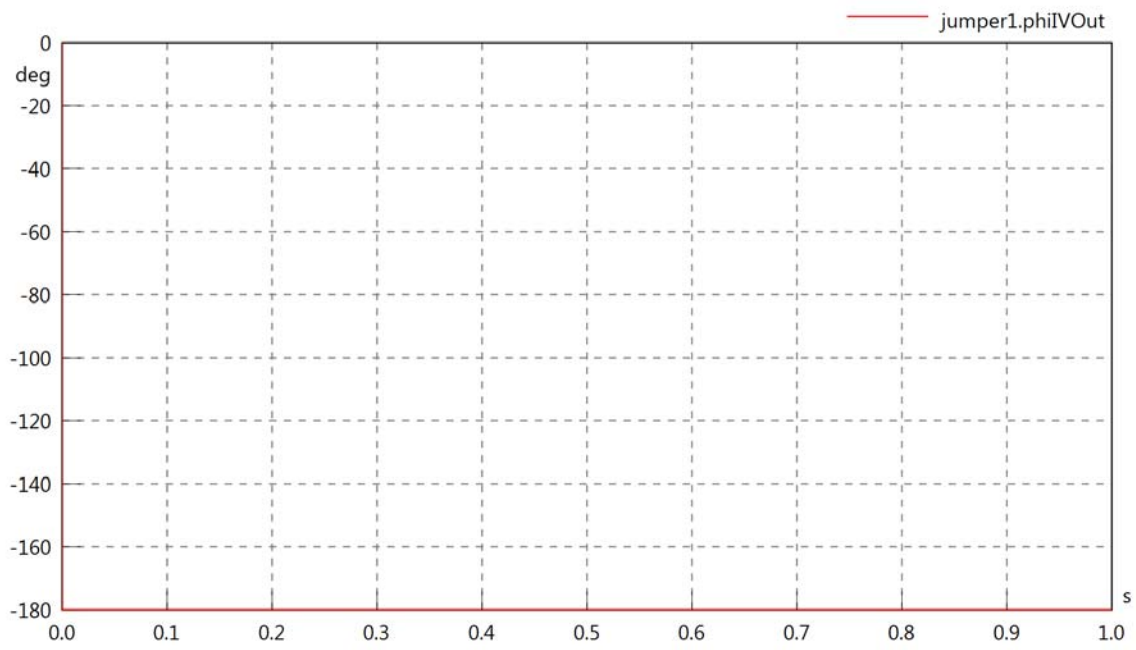

jumper1.phiVL1

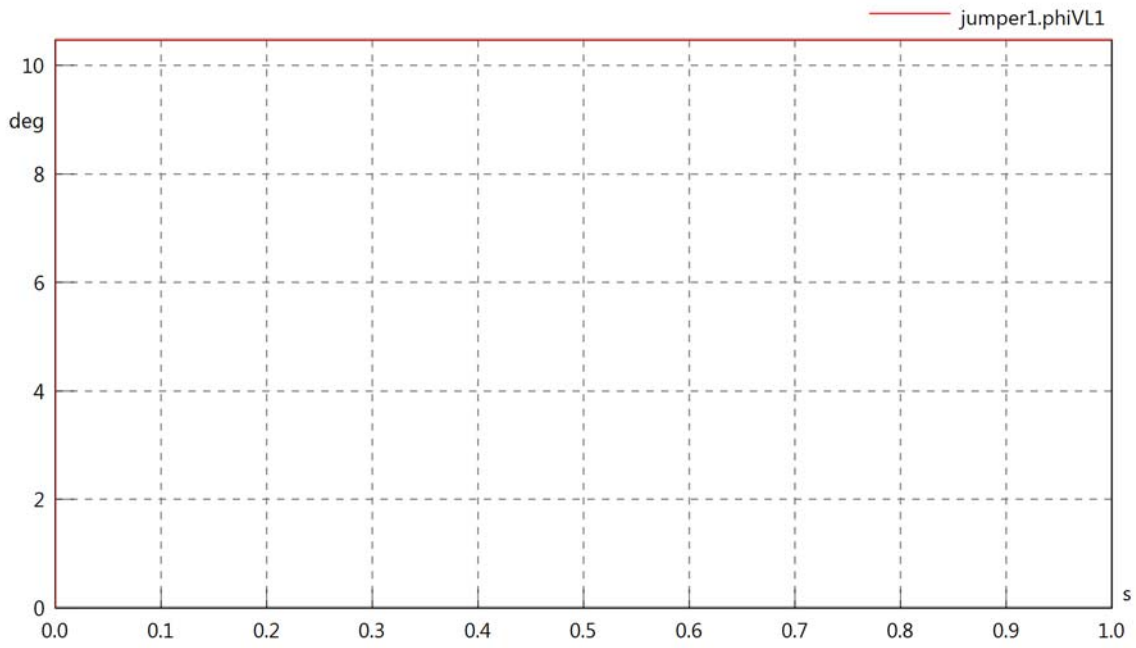

jumper1.phiIL1

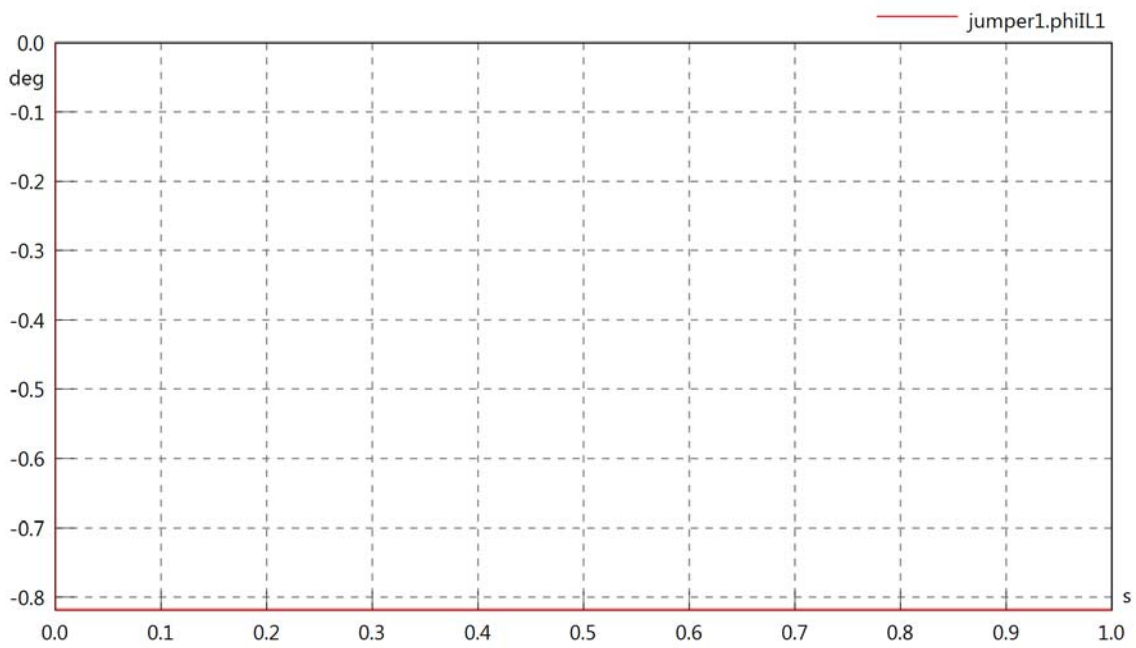

jumper1.phiIVL1

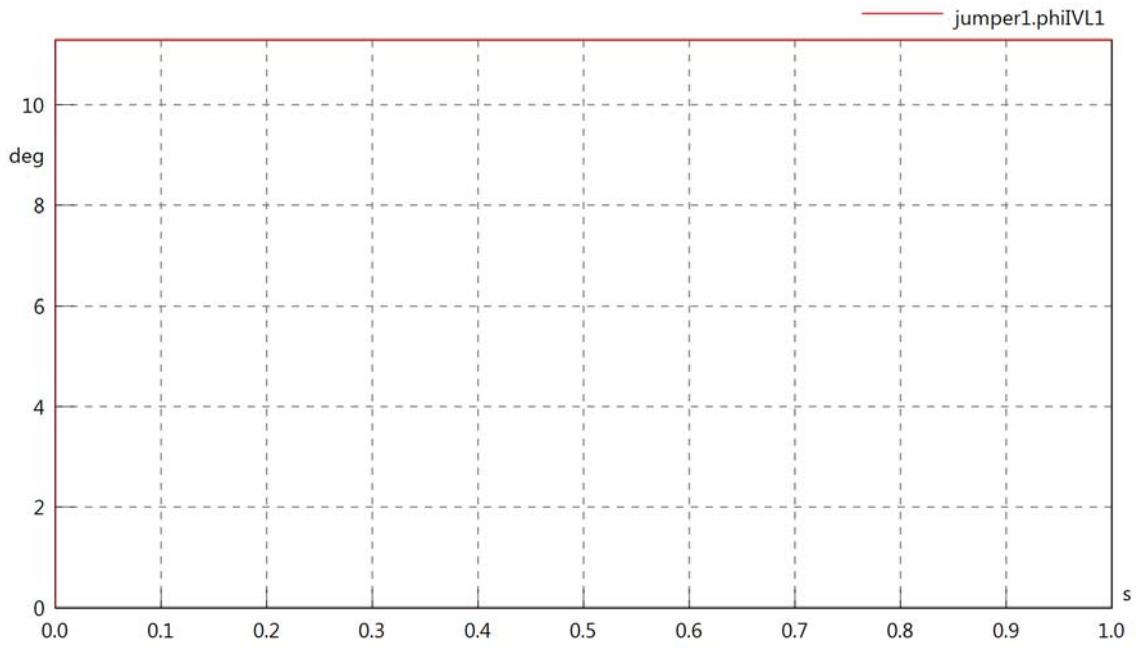

jumper1.PReIn

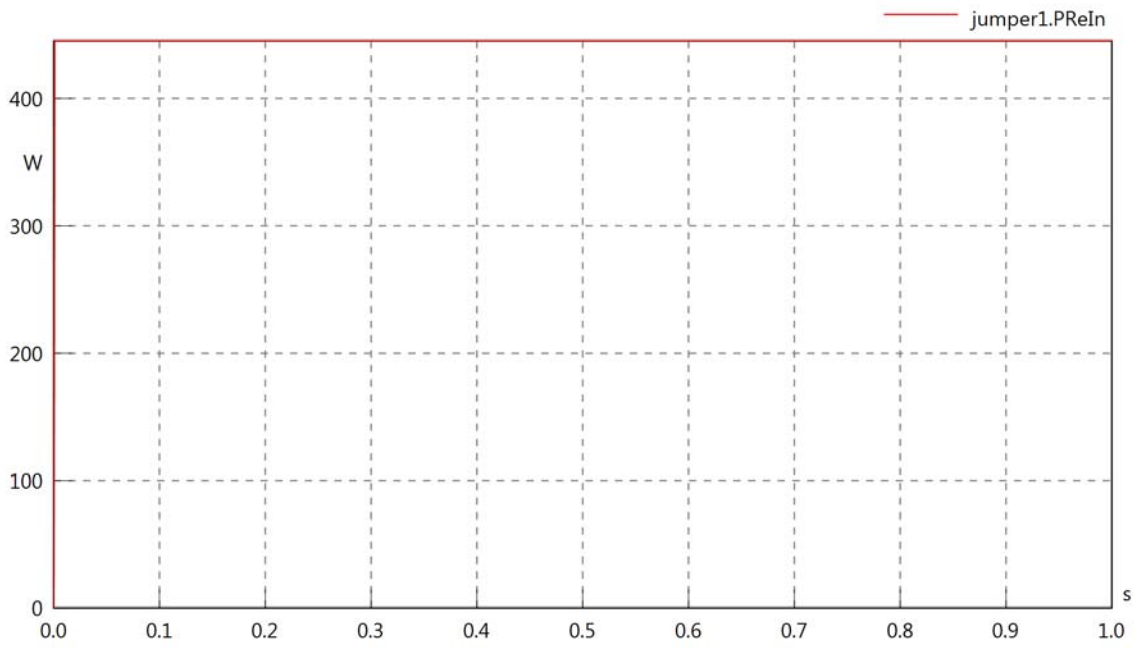

jumper1.PImIn

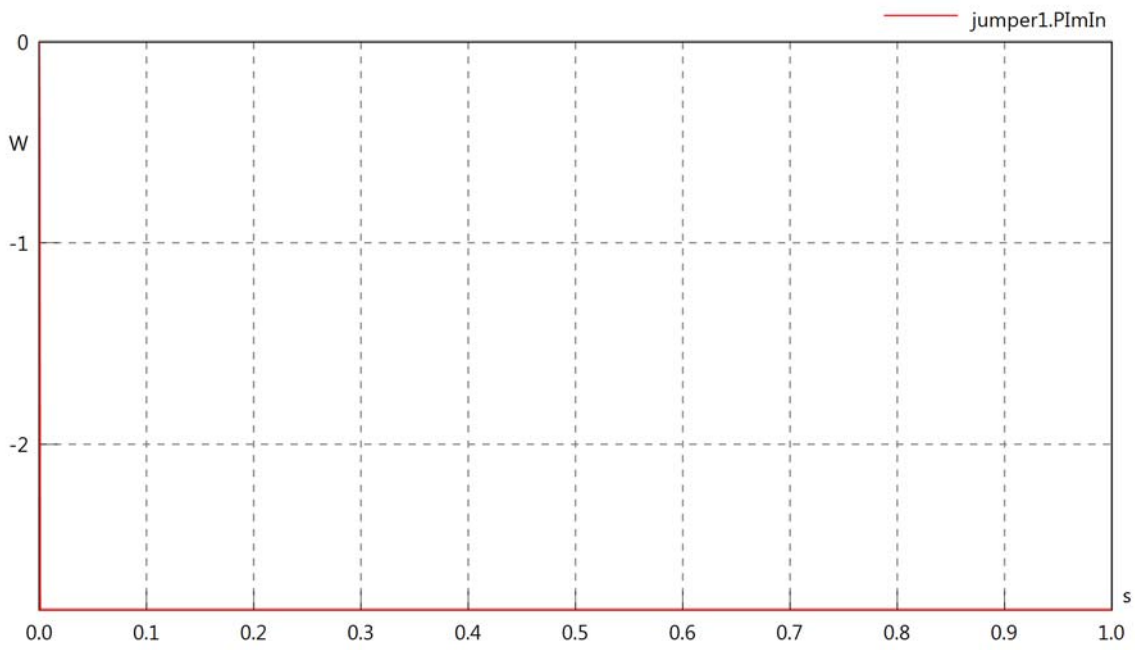

jumper1.SIn

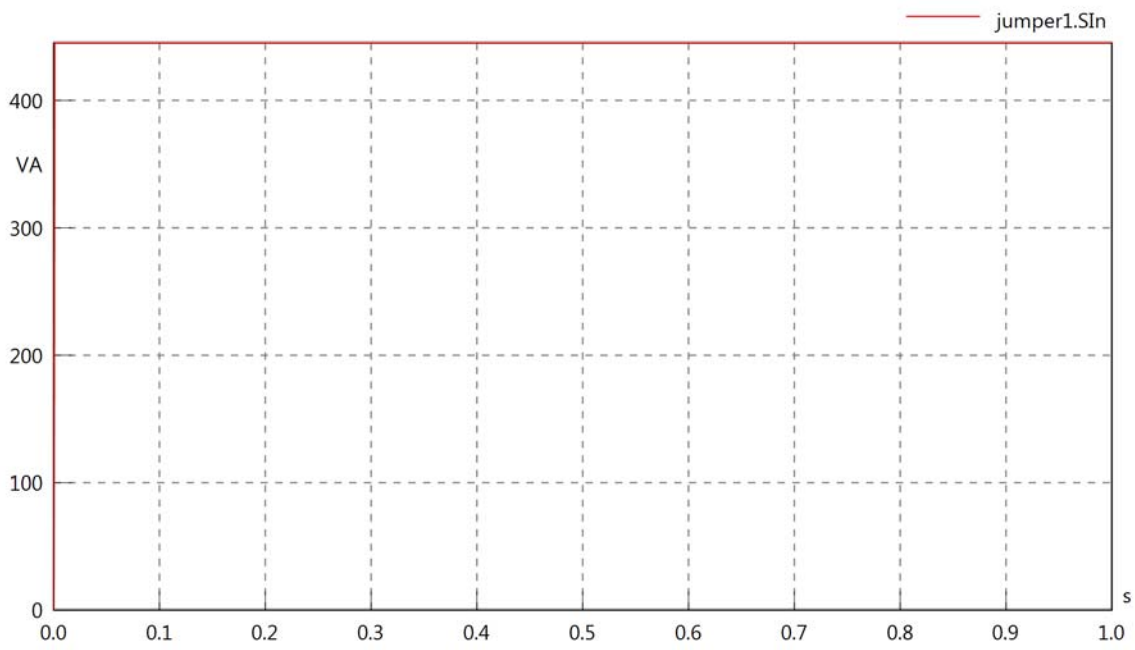

jumper1.PReOut

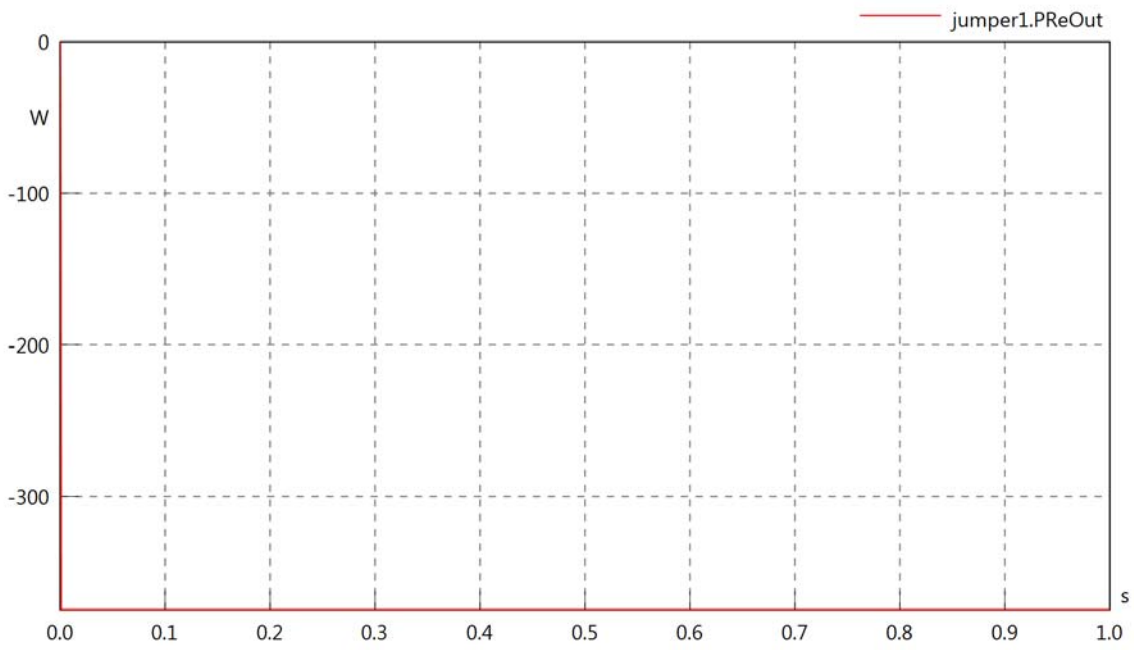

jumper1.PImOut

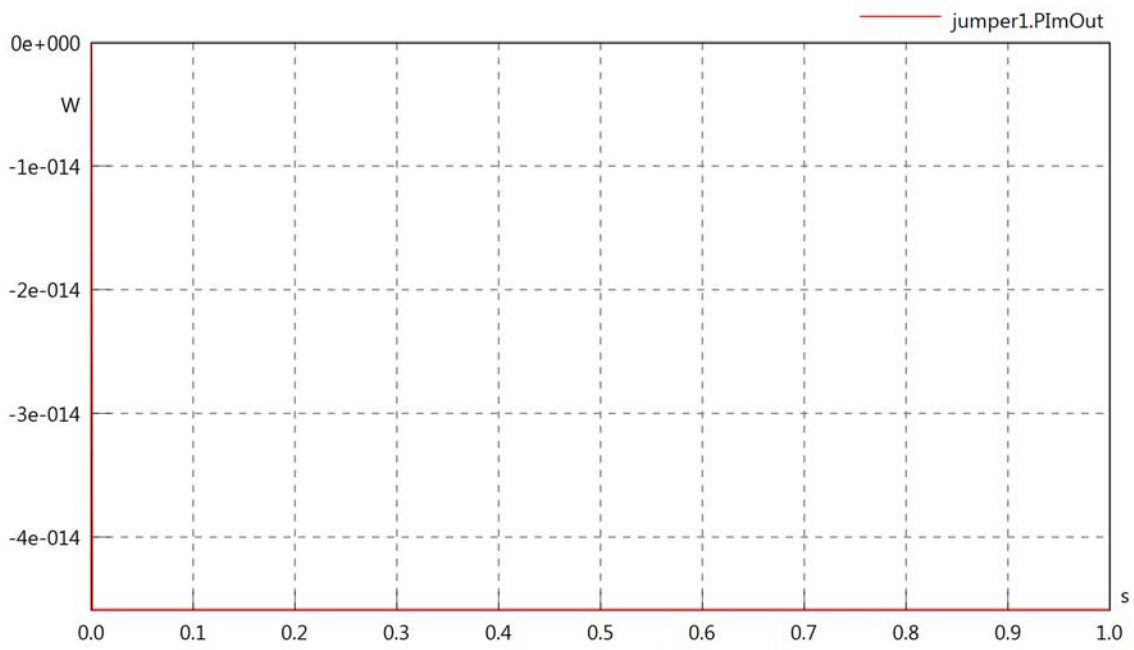

jumper1.SOut

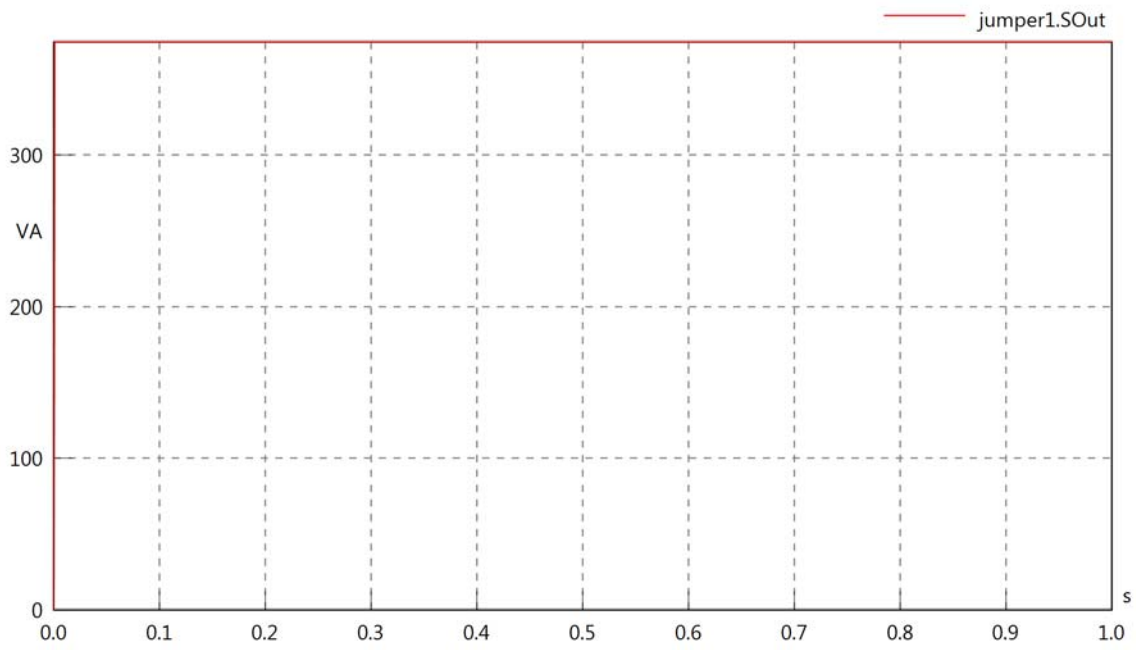

jumper1.PRe

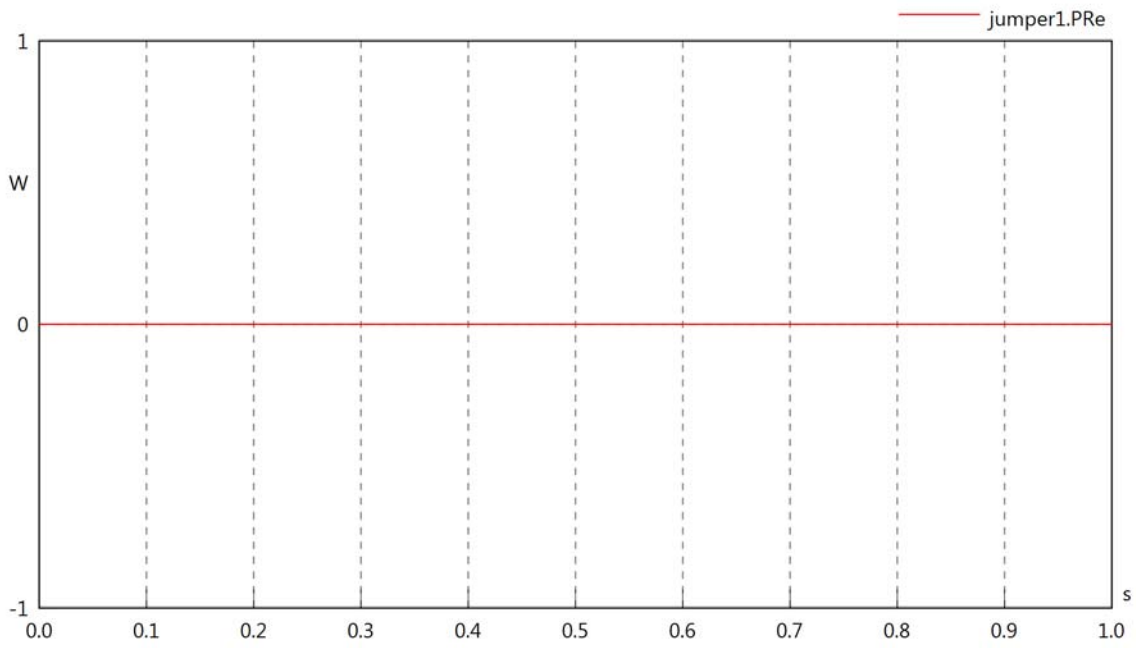

jumper1.PIm

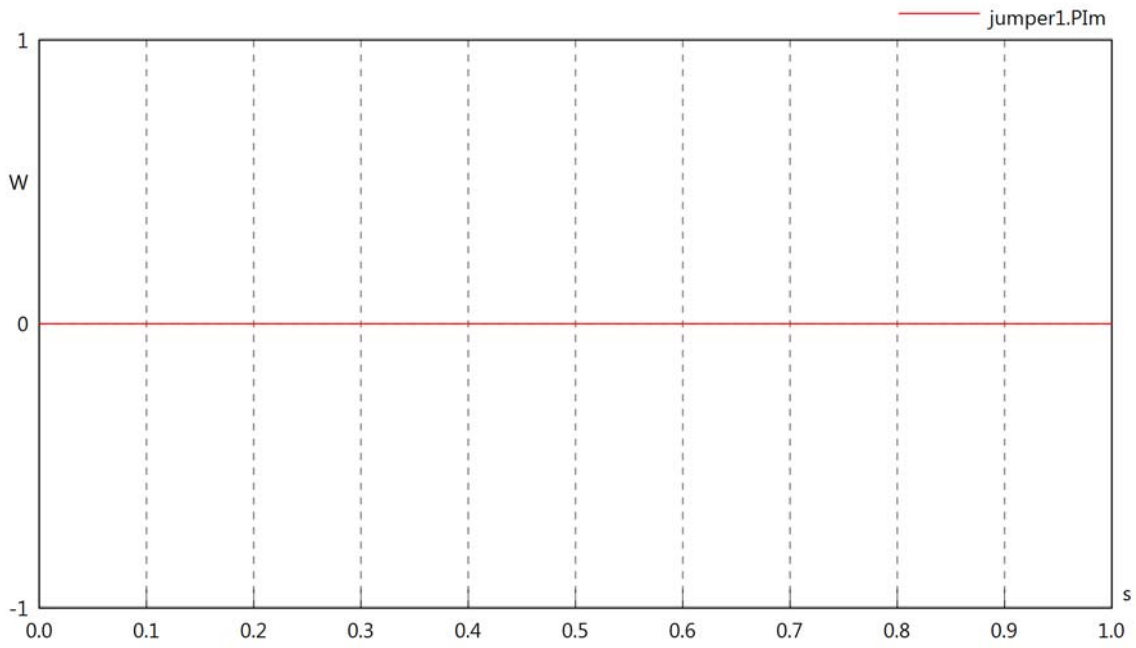

jumper1.S

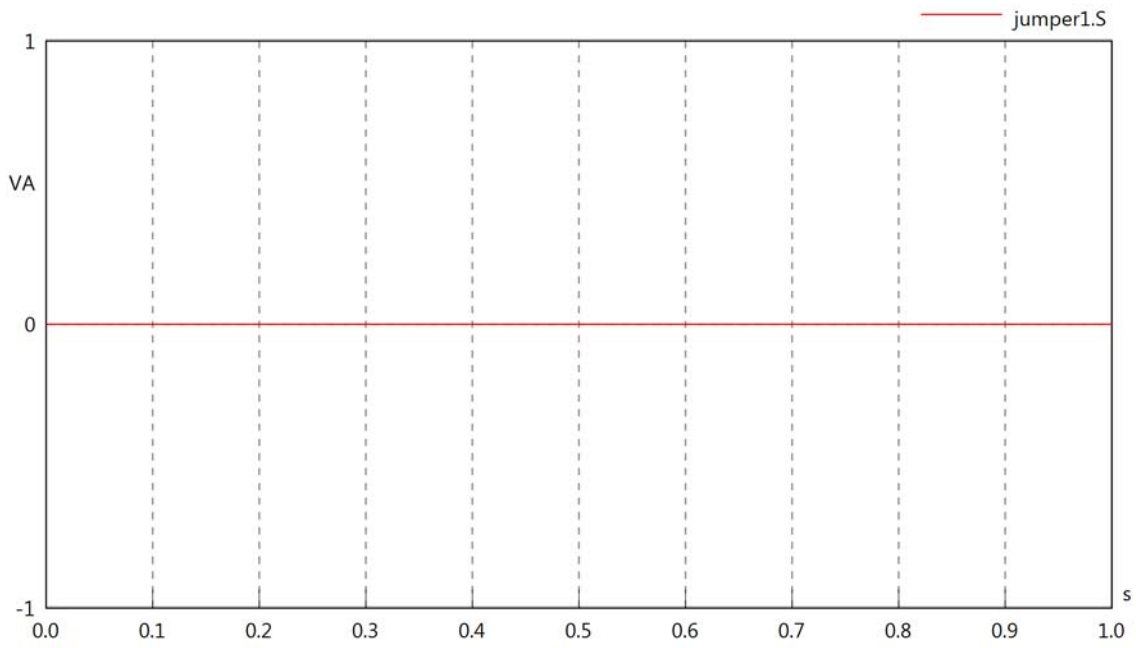

jumper1.dB

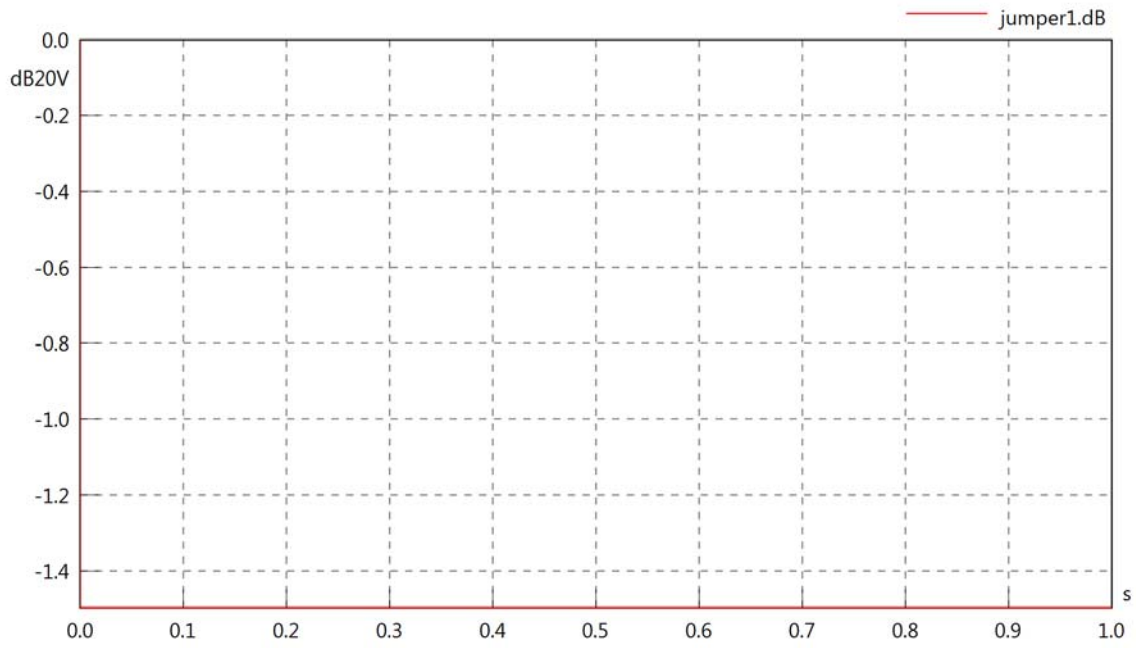
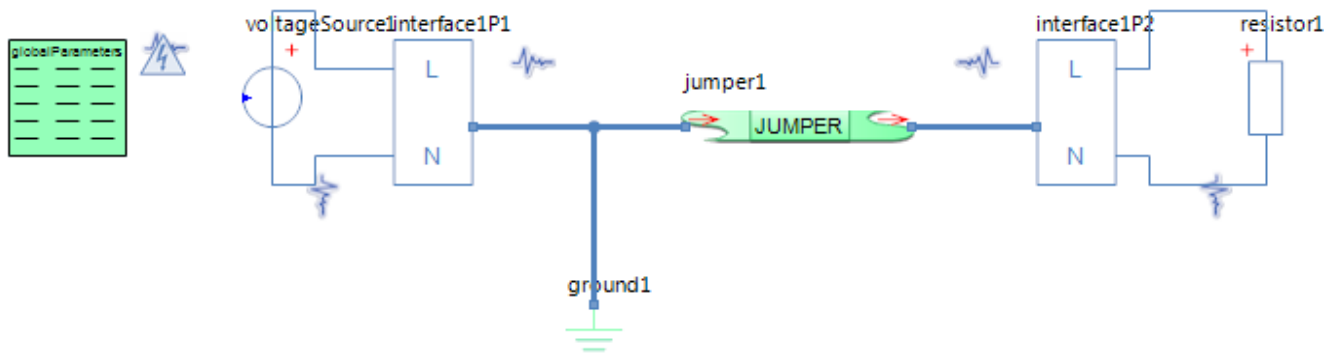

Diagram View



GlobalParameters globalParameters
Parameters

Comment	Name	Current Value	Unit
Type of Calculation	eCalculationKind	Signal Calculation	
Description of Frequency	eFrequencyKind	Linear	
Minimum Frequency	fMin	4	[kHz]
Maximum Frequency	fMax	4	[kHz]

Jumper jumper1
Parameters

Comment	Name	Current Value	Unit
Resistance per length for each Line at 20 °C (68 °F)	r	1	[Ohm/km]
Inductance per length for each Line	l	0.5	[mH/km]
Conductance per length between Lines	g	1e-10	[1/(Ohm·m)]
Capacitance per length between Lines	c	0.1	[µF/km]
Length of Jumper for each Line	length	10	[km]
Temperature of the conductor	temp	5	[°C]
Skin effect	skinEff	Round, stranded or solid copper conductor	
Conductor area	area	6	[mm²]

Voltage Source voltageSource1
Parameters

Comment	Name	Current Value	Unit
Voltage RMS	VrmsSrc	min(230,230000*t)	[V]
Phase	phi	0	[deg]

Resistor resistor1
Parameters

Comment	Name	Current Value	Unit
Resistance	R	100	[Ohm]

jumper1.rTemp

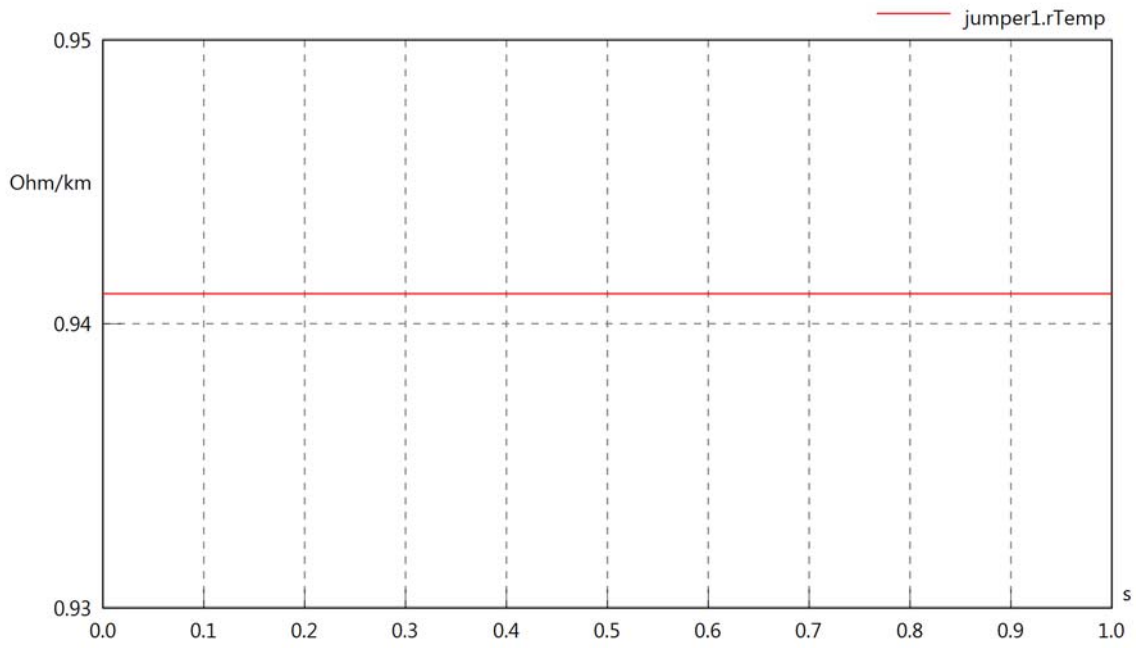

jumper1.skinDepth

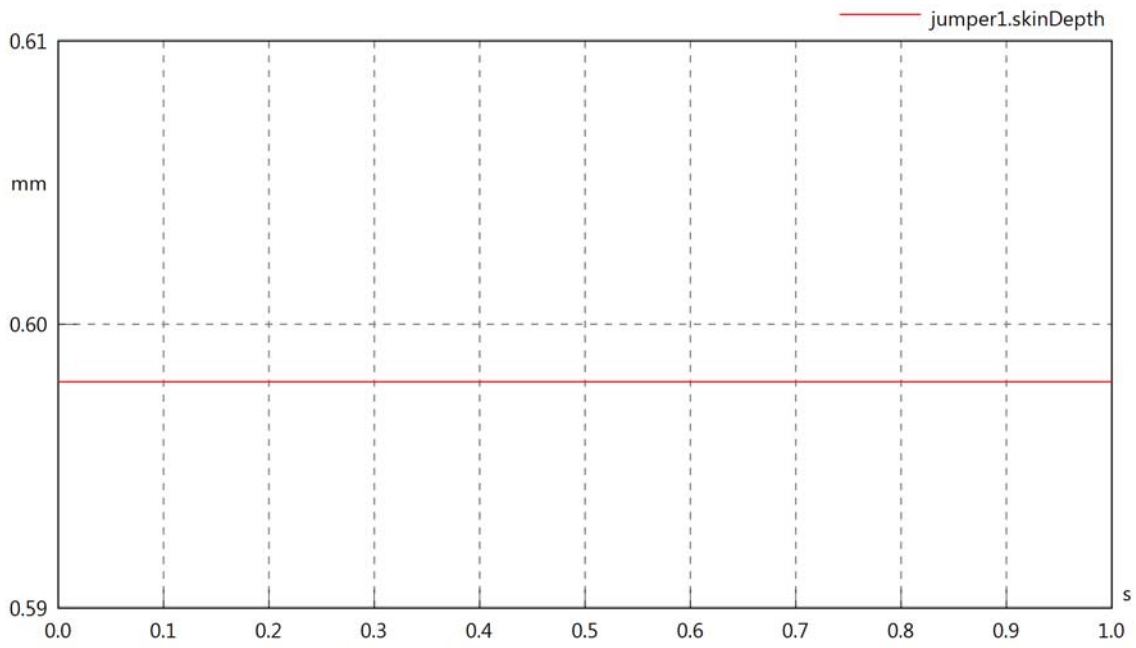

jumper1.diameter

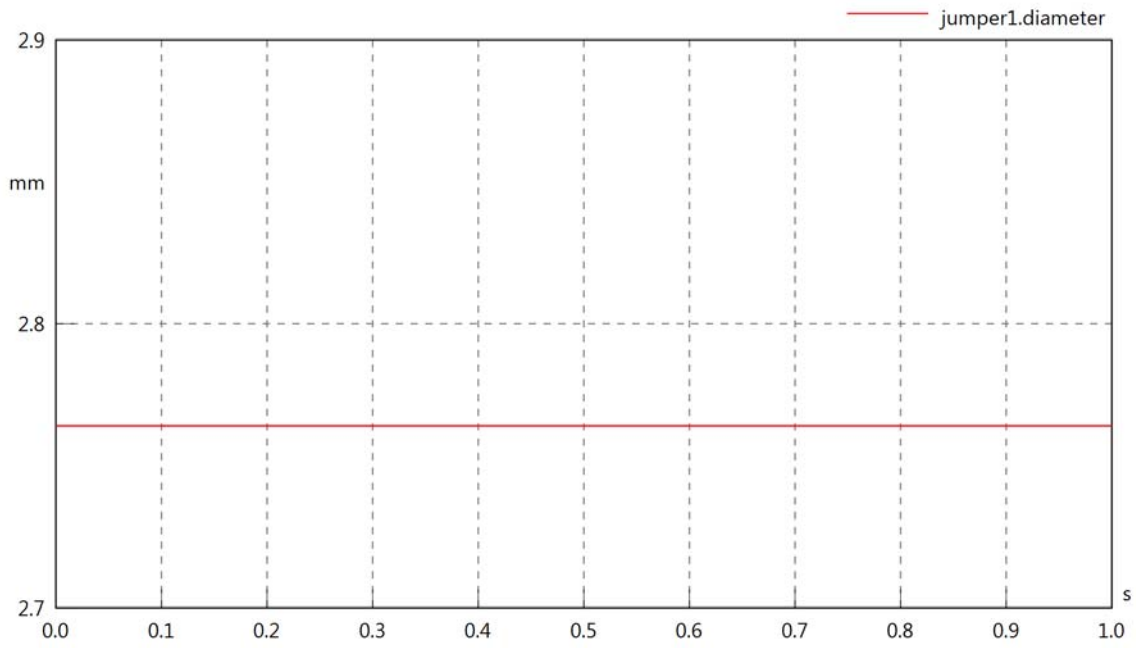

jumper1.resistivity

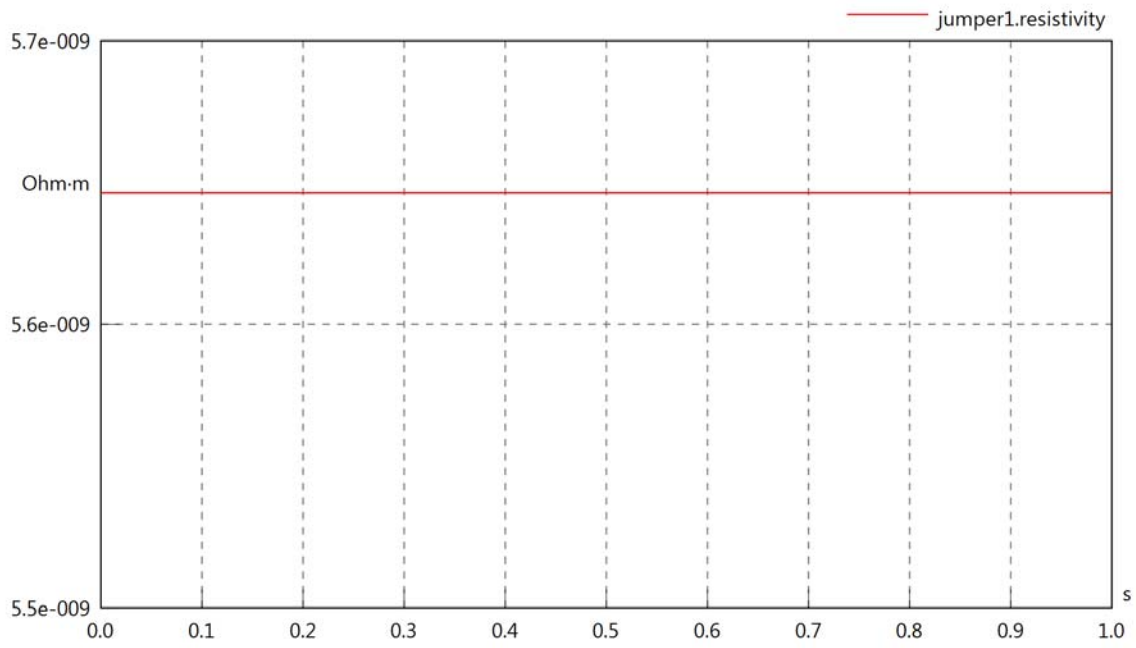

jumper1.rInternal

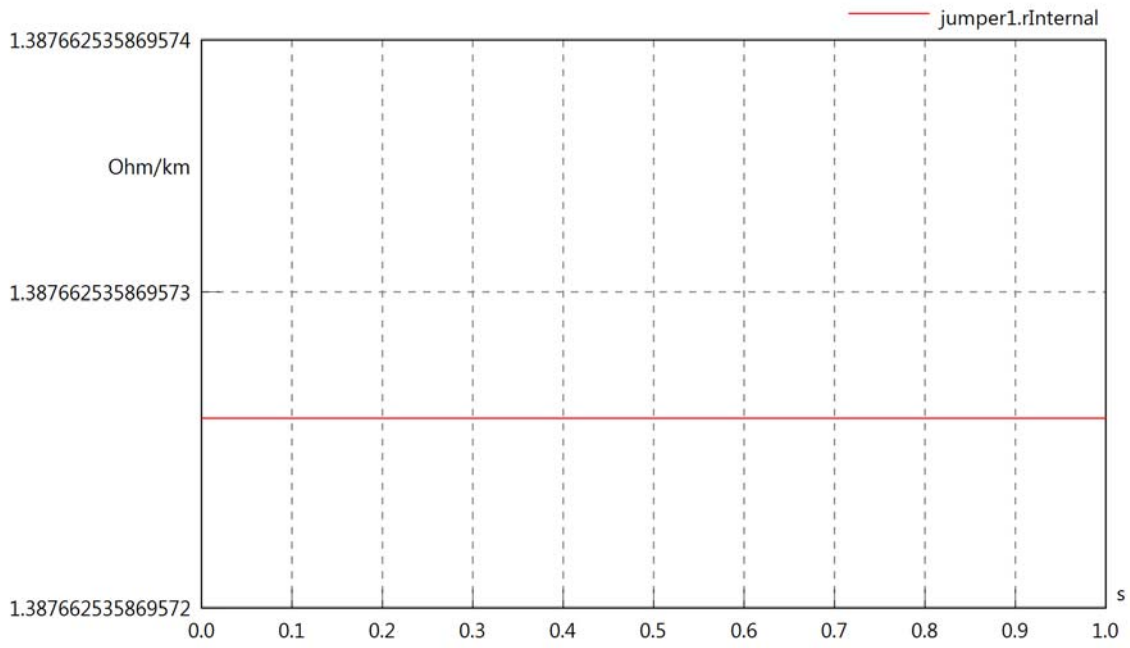

jumper1.VrmsIn

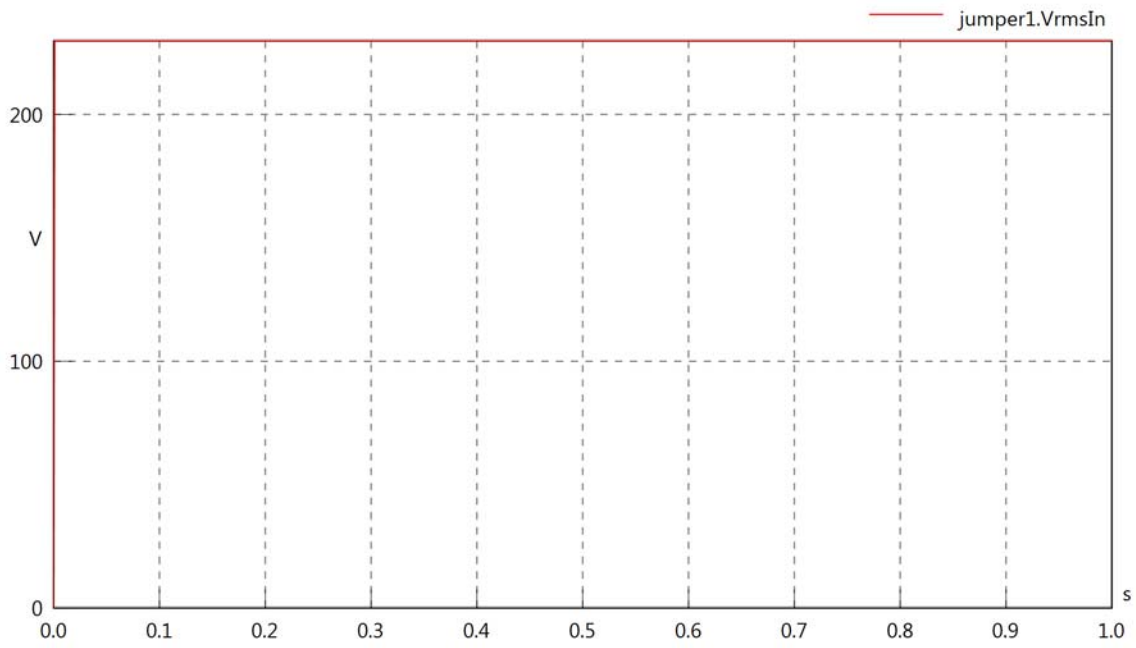

jumper1.vReIn

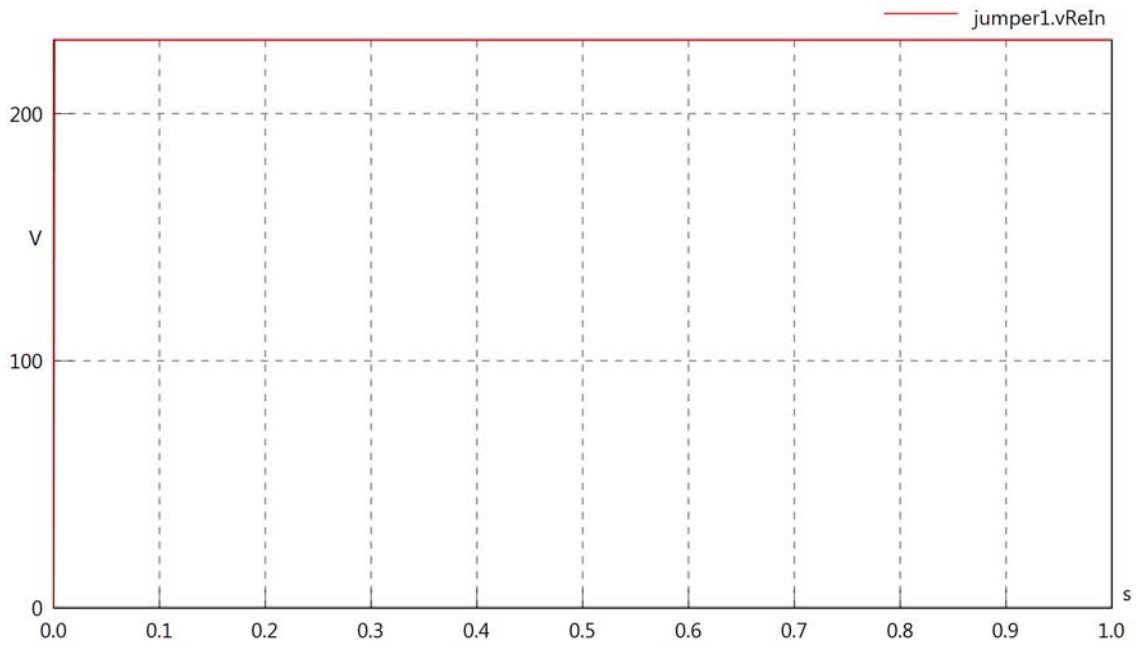

jumper1.vImIn

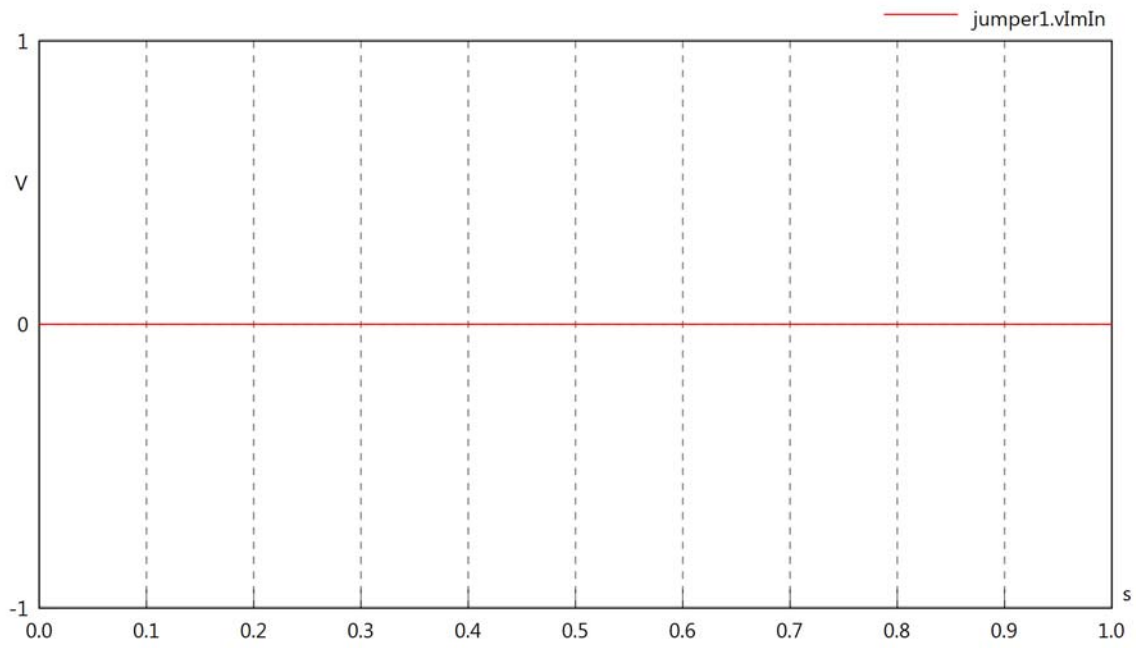

jumper1.VrmsOut

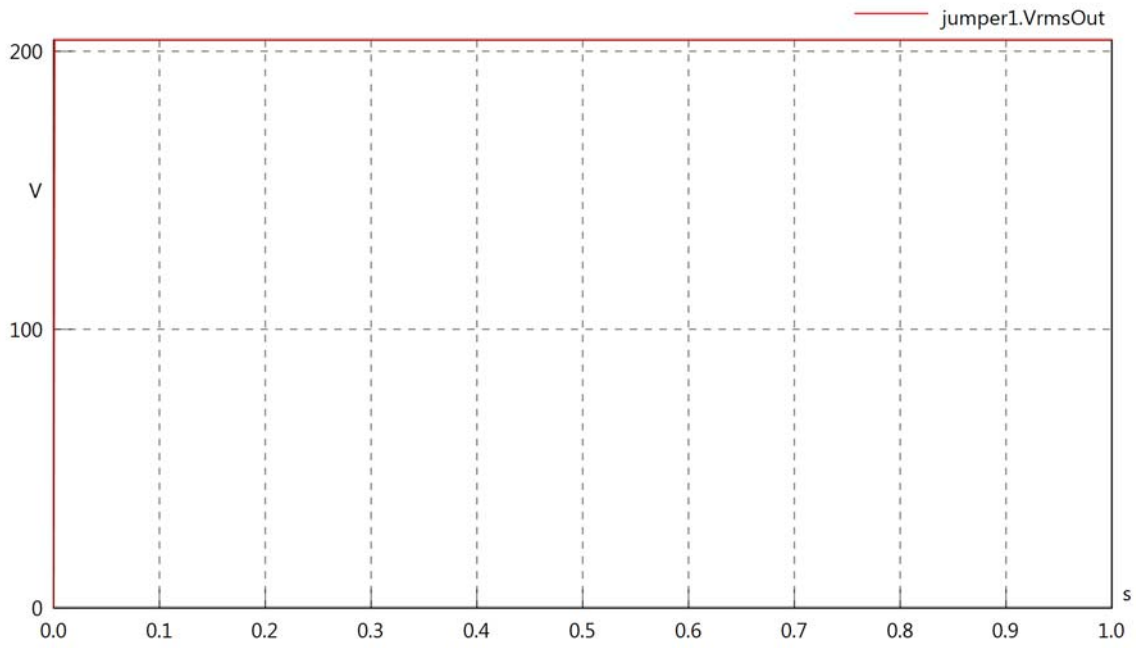

jumper1.vReOut

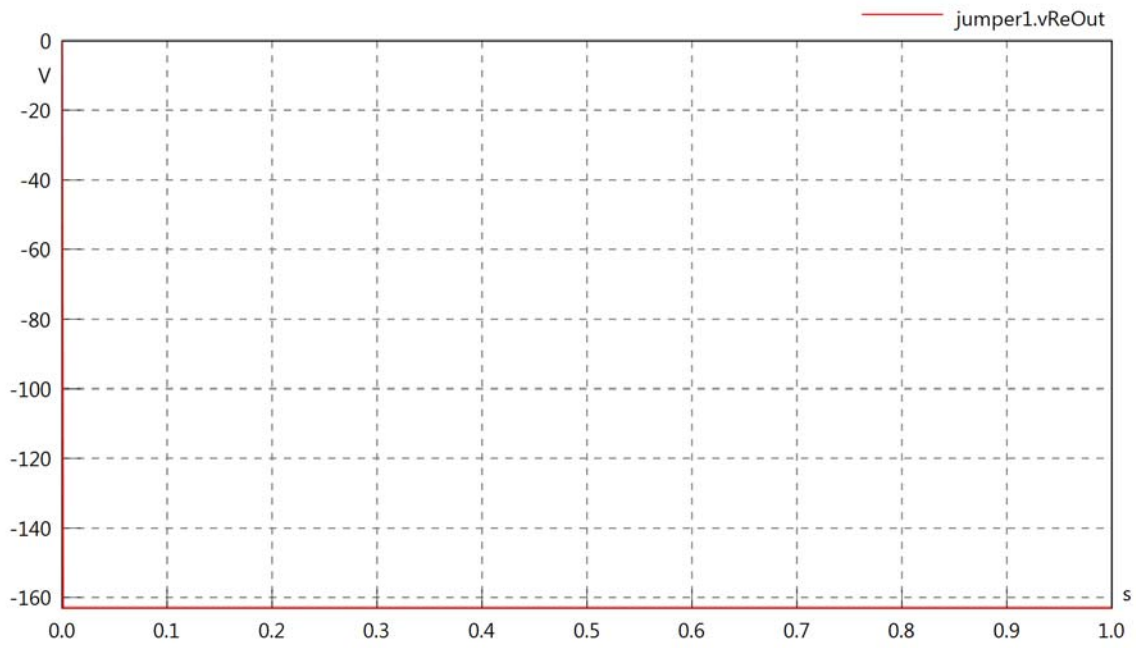

jumper1.vImOut

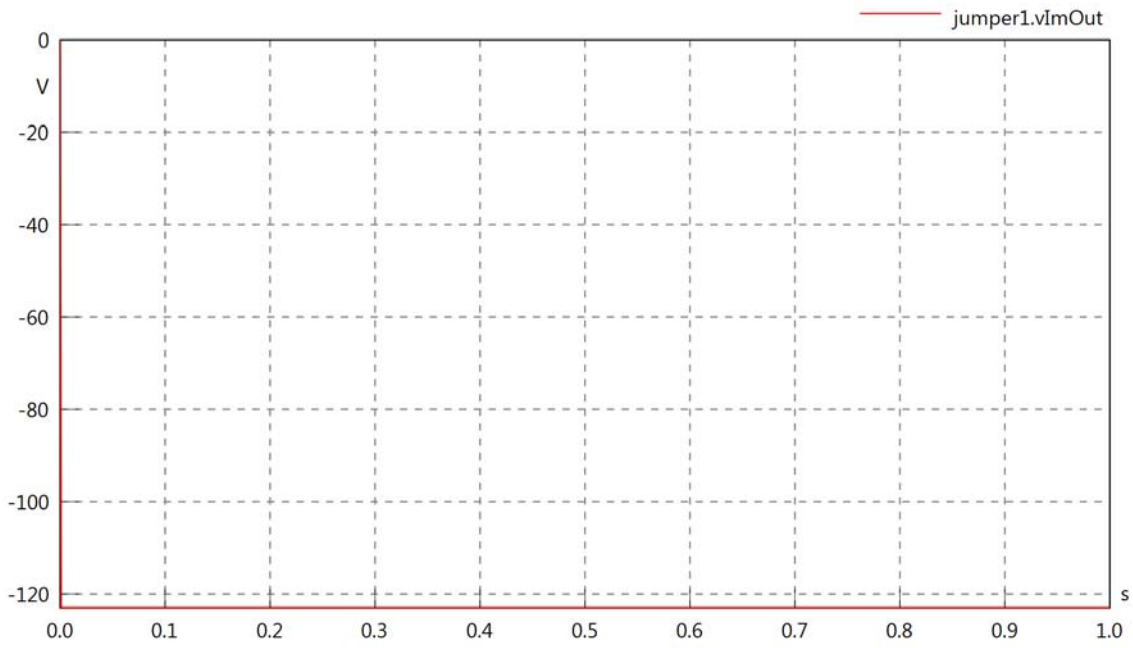

jumper1.Vrms

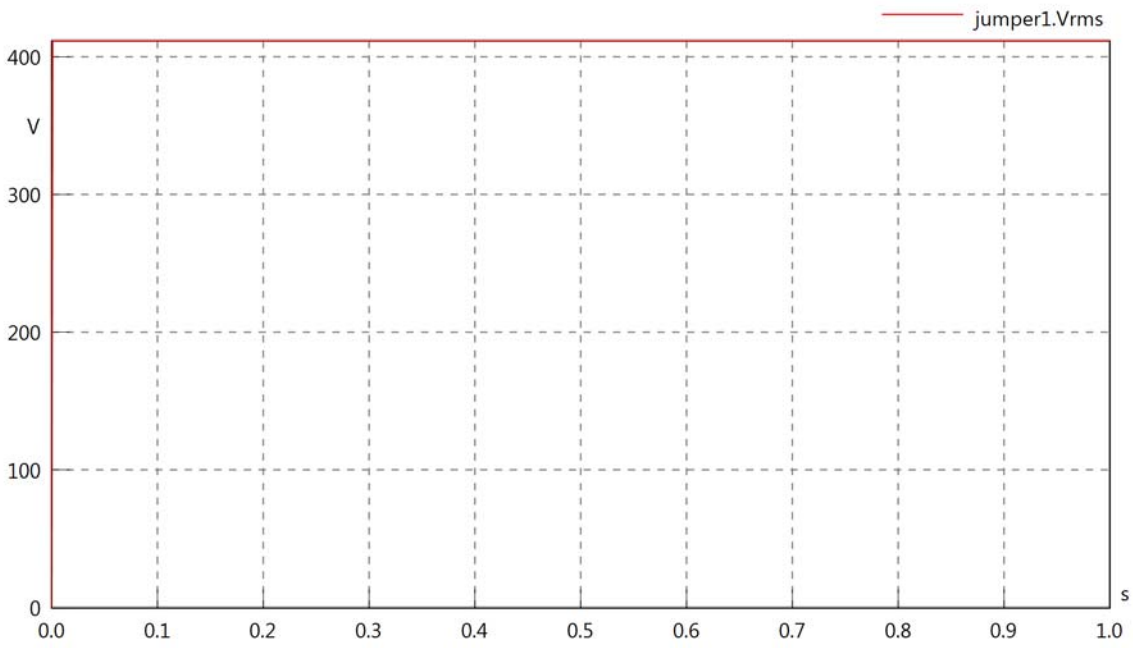

jumper1.vRe

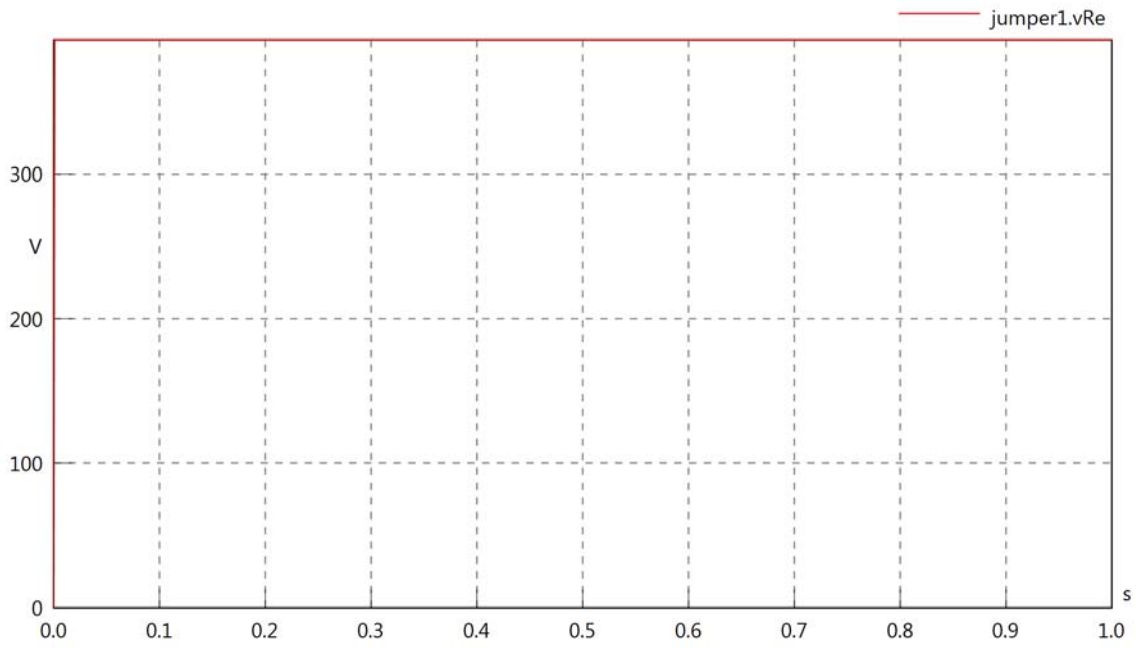

jumper1.vIm

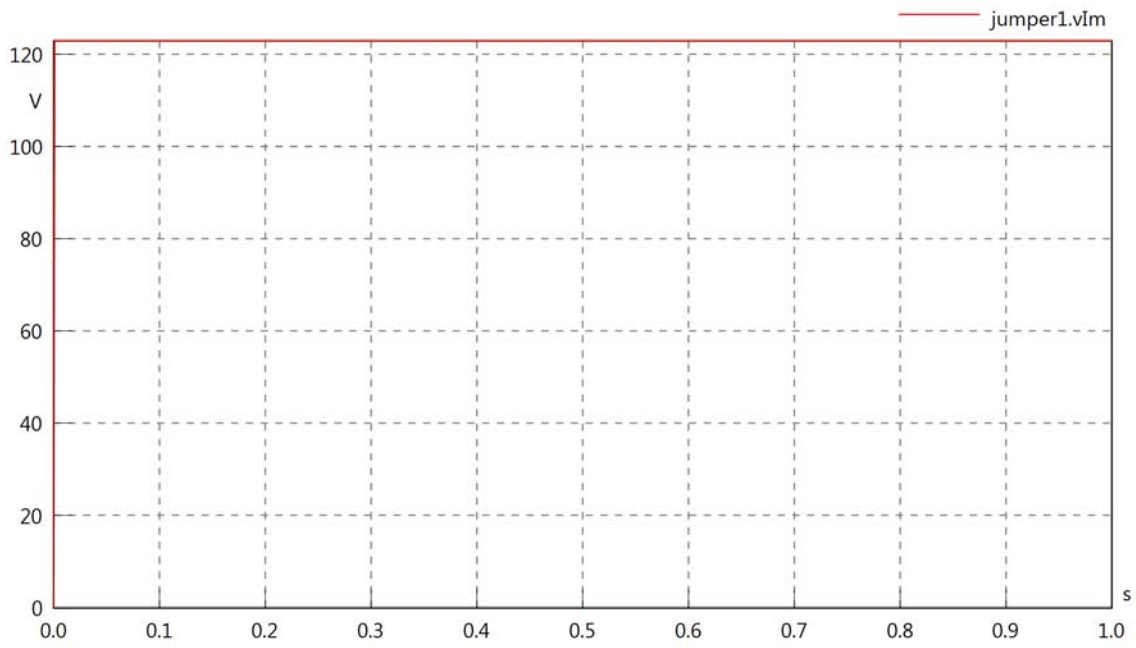

jumper1.IrmsIn

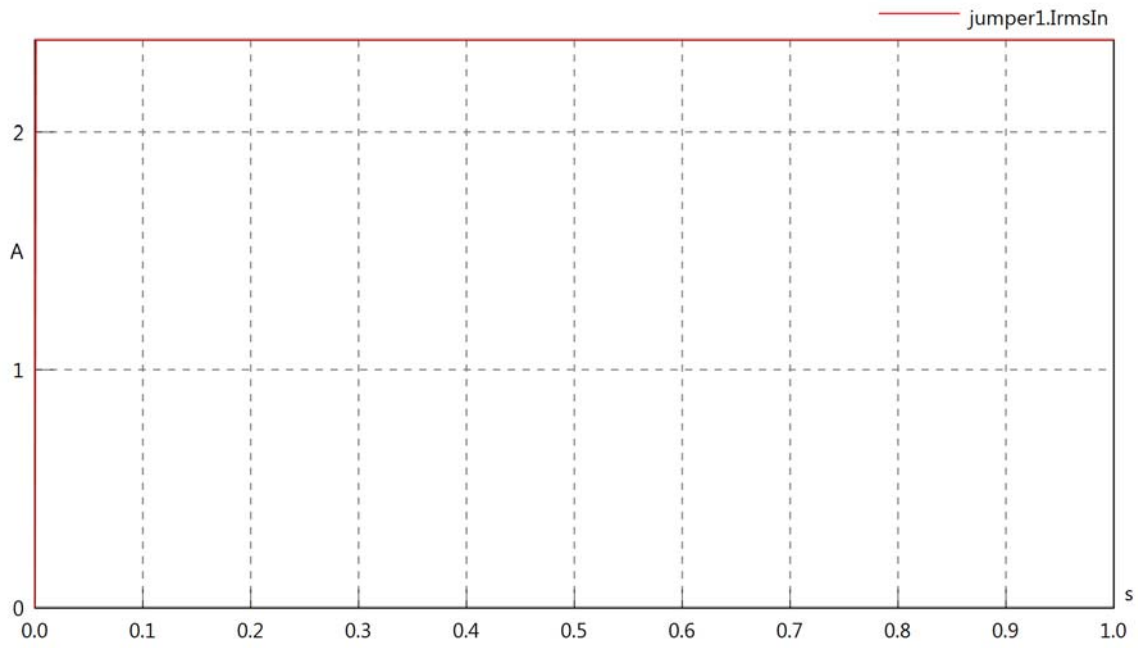

jumper1.iReIn

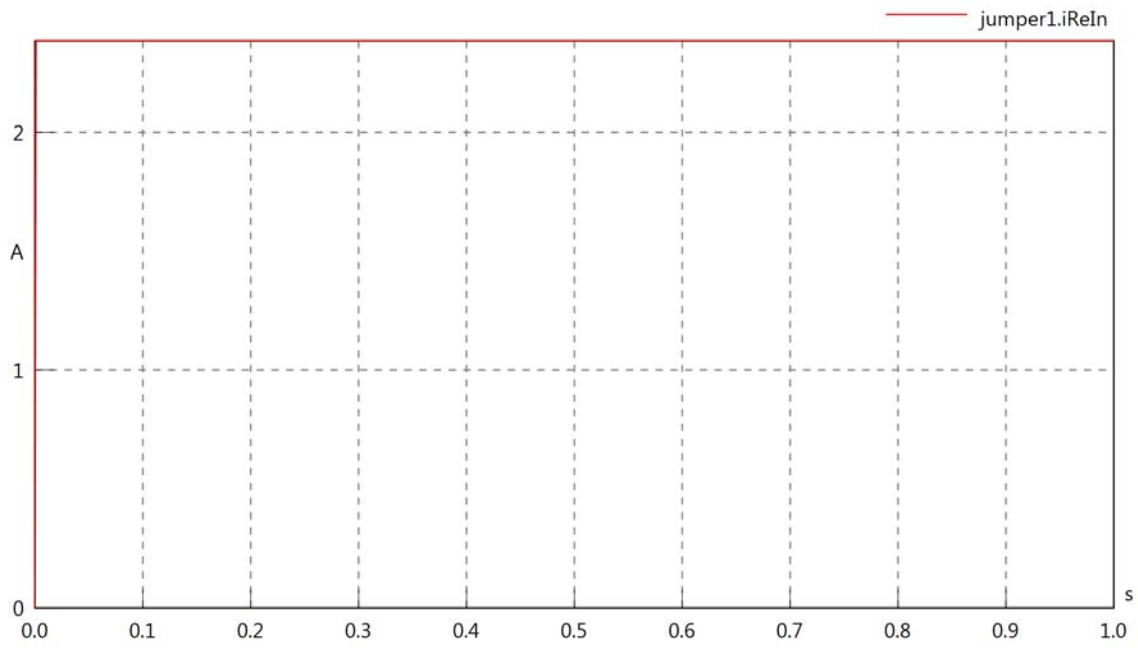

jumper1.ilmIn

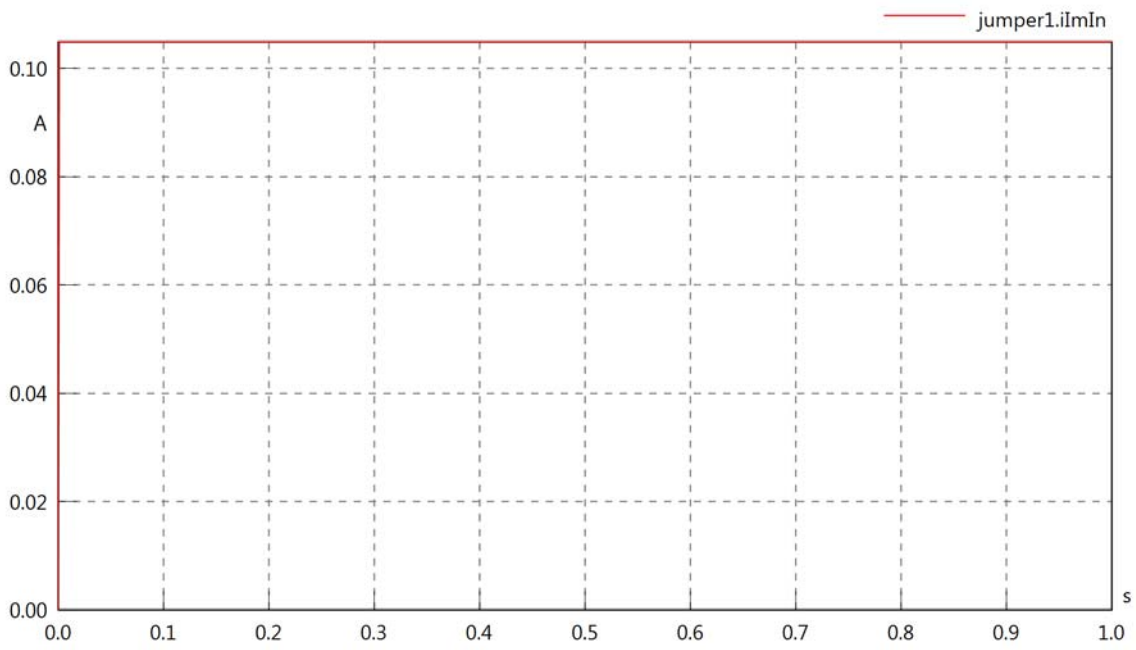

jumper1.IrmsOut

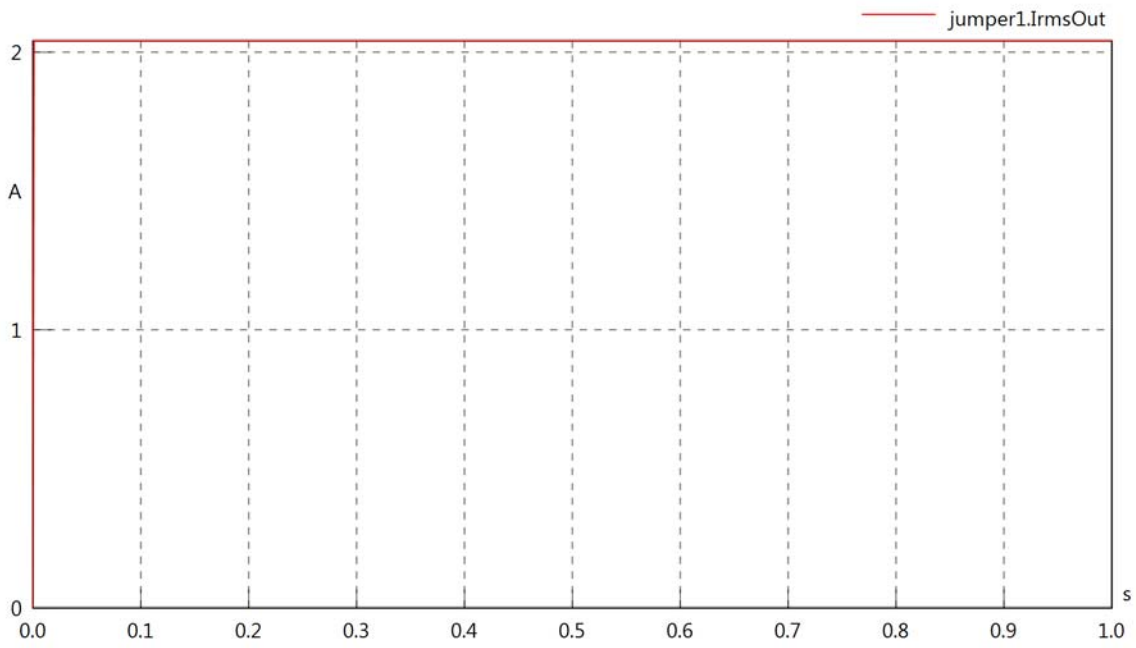

jumper1.iReOut

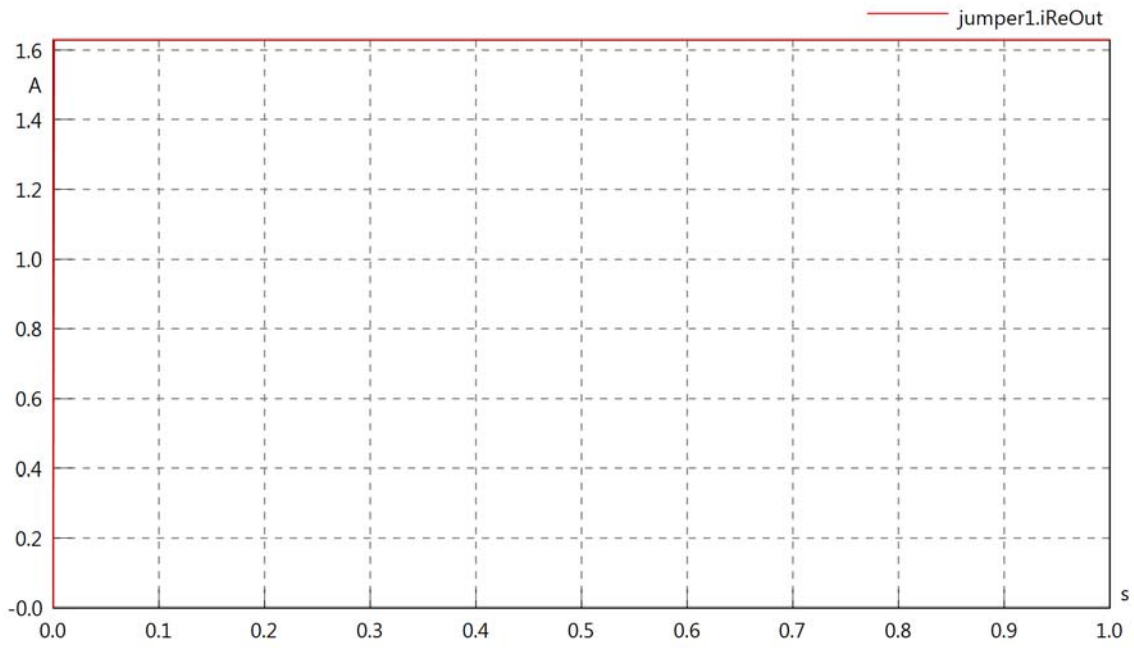

jumper1.iImOut

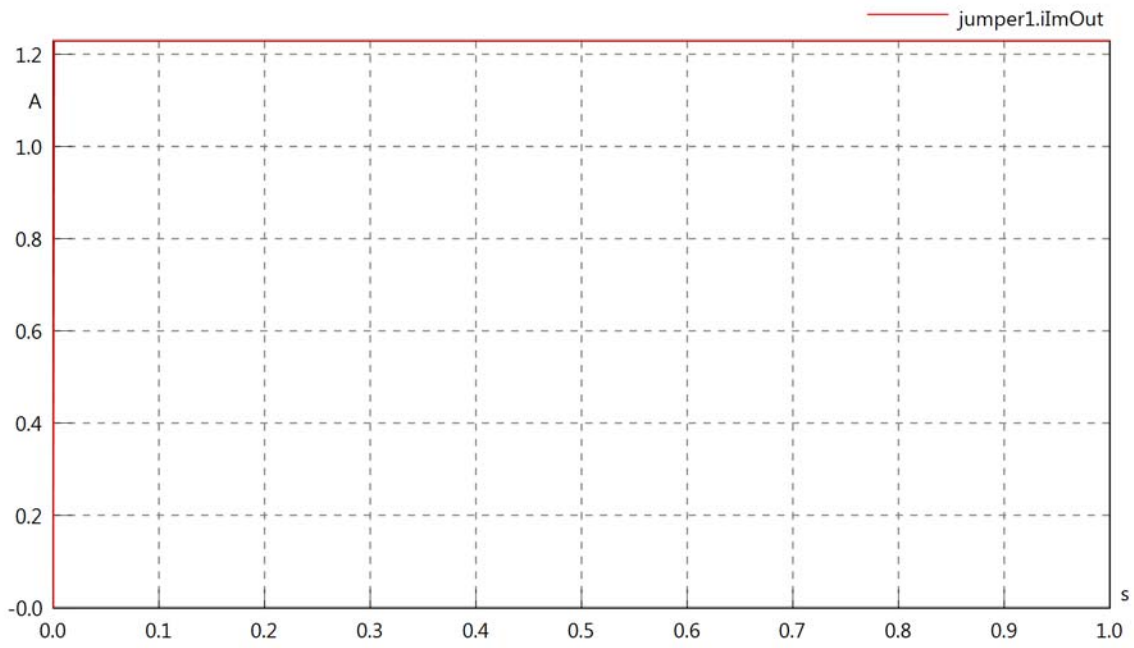

jumper1.phiVIn

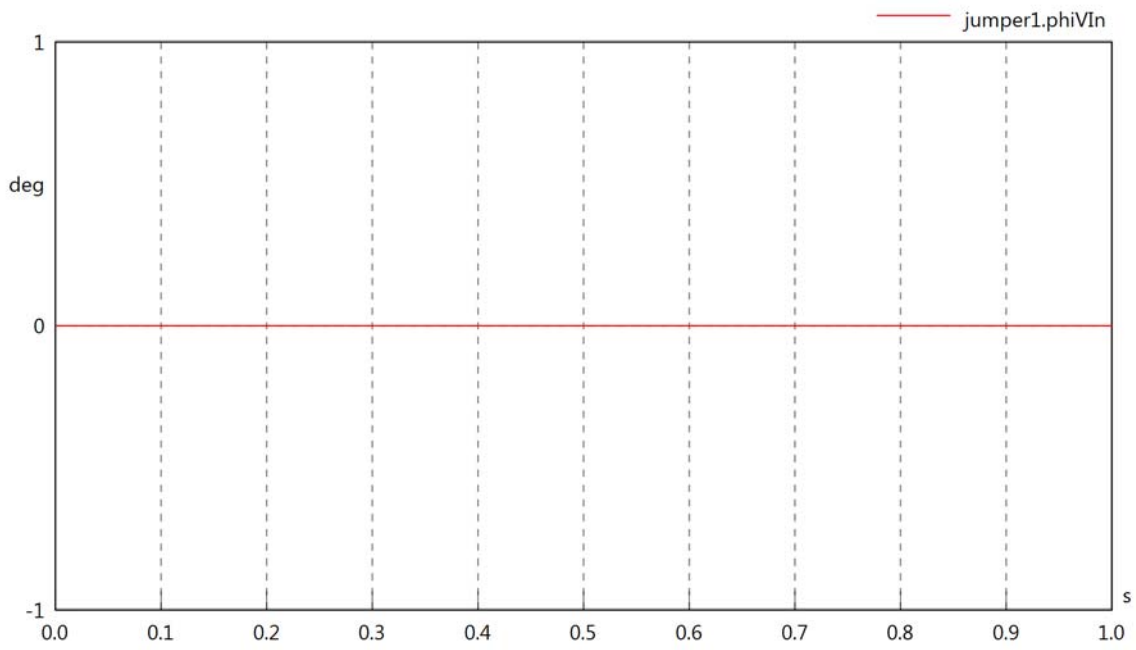

jumper1.phiIn

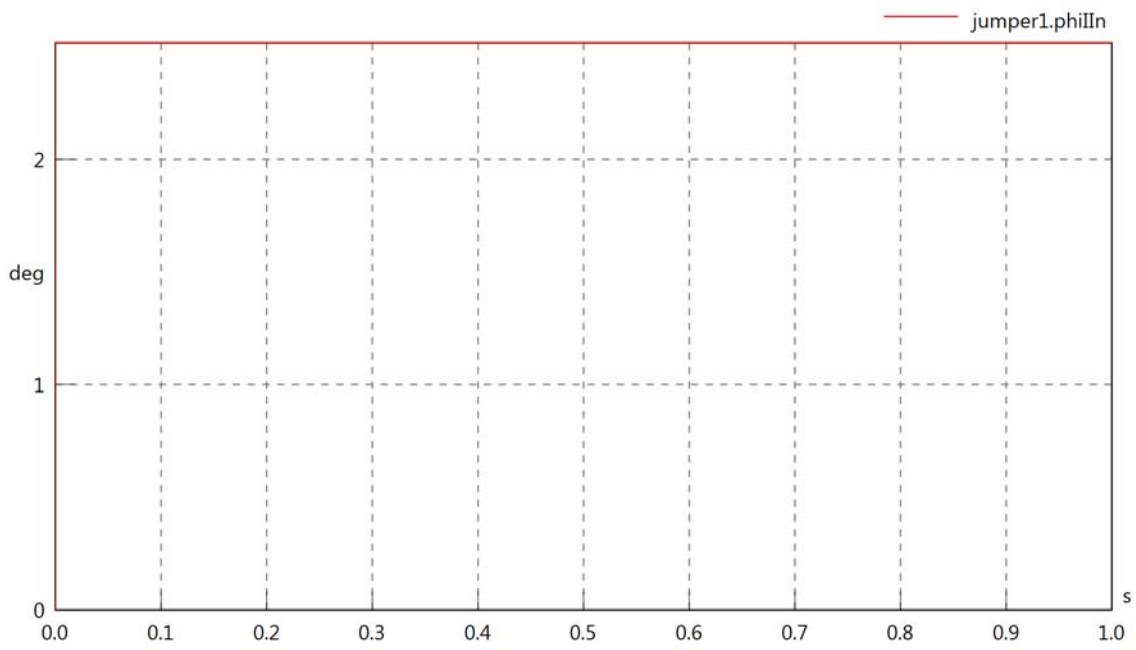

jumper1.phiVIn

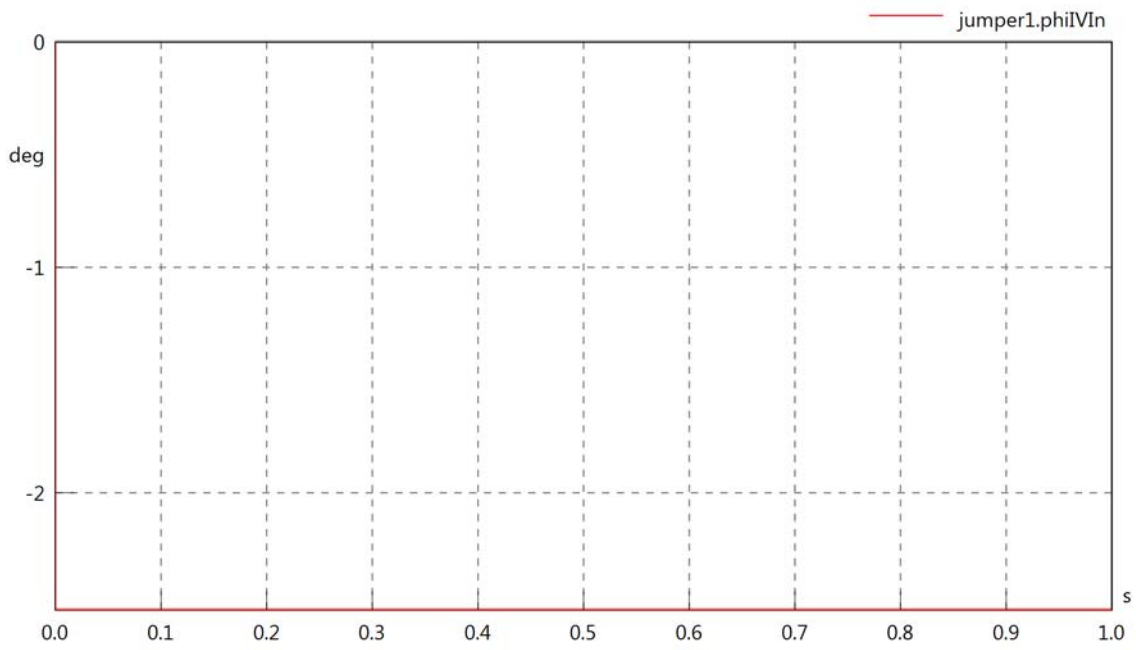

jumper1.phiVOut

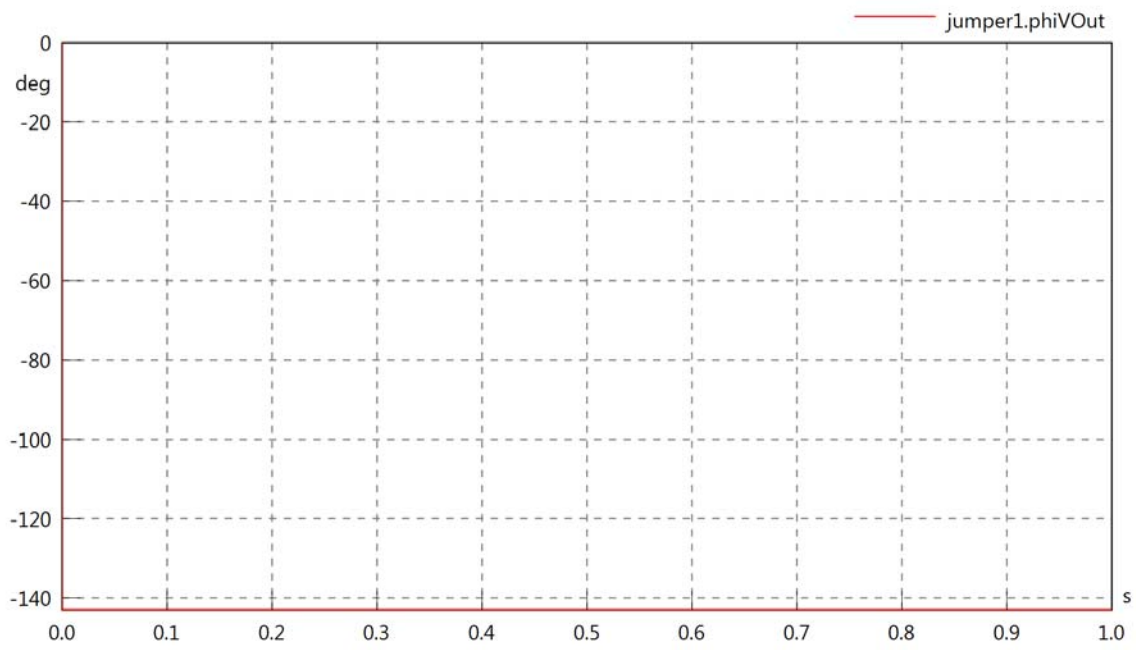

jumper1.phiIOut

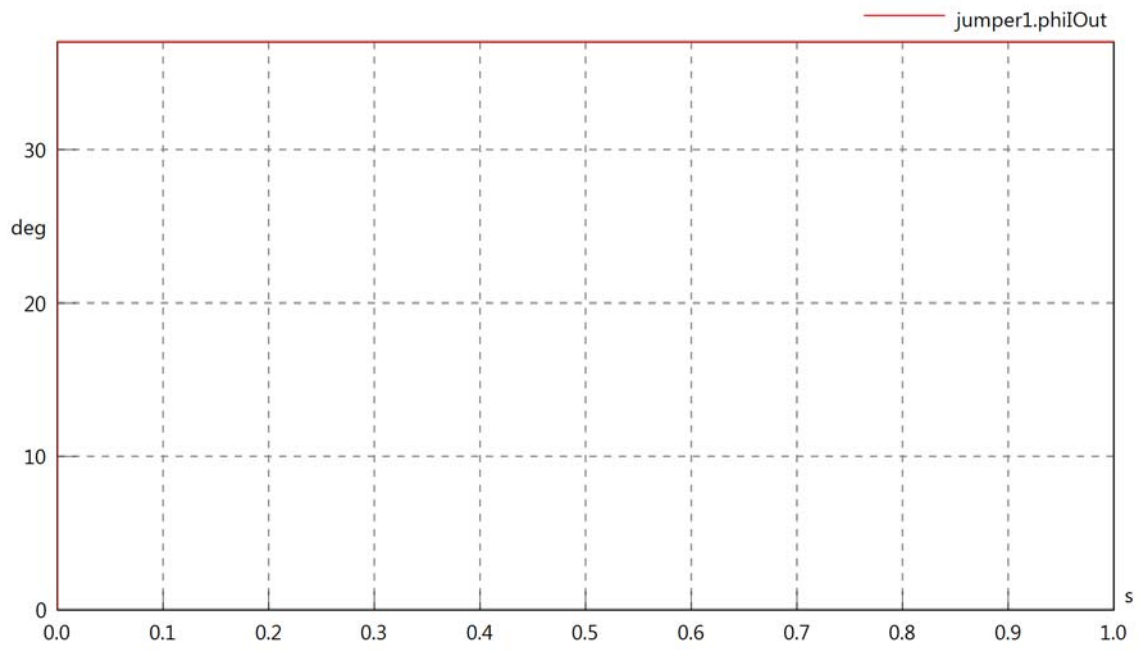

jumper1.phiIVOut

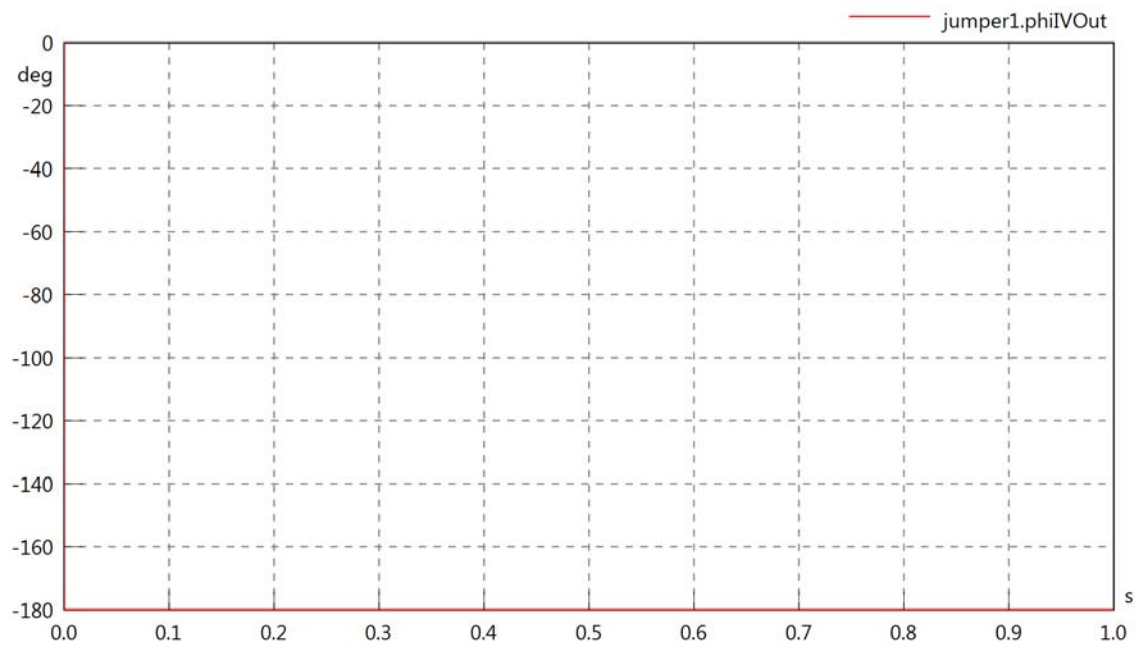

jumper1.phiVL1

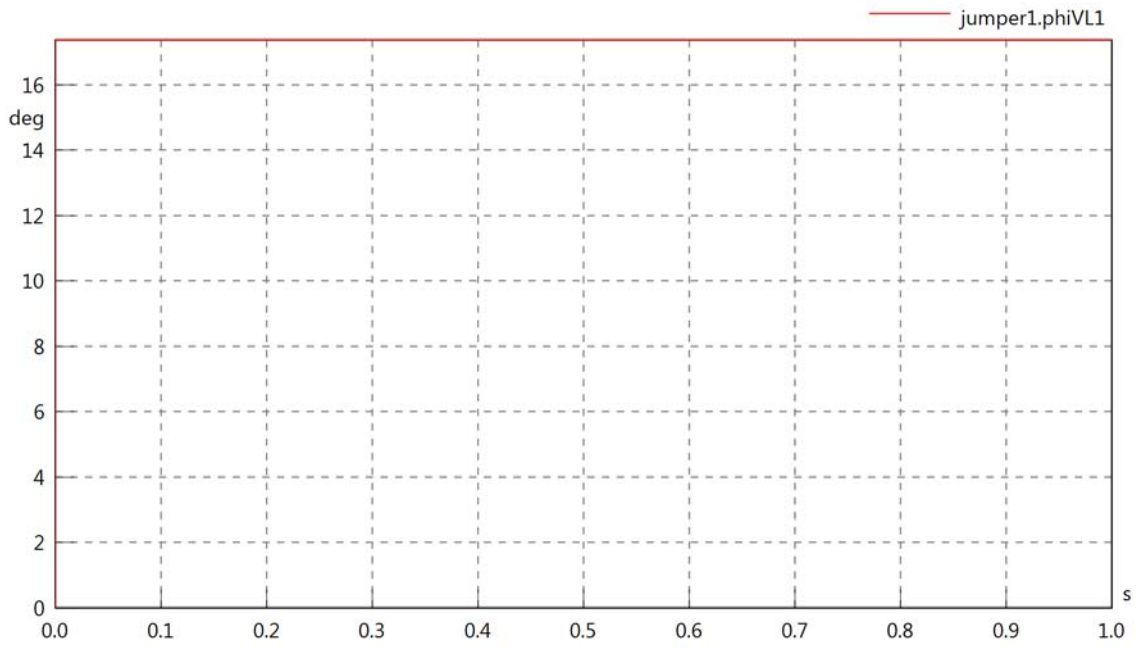

jumper1.phiIL1

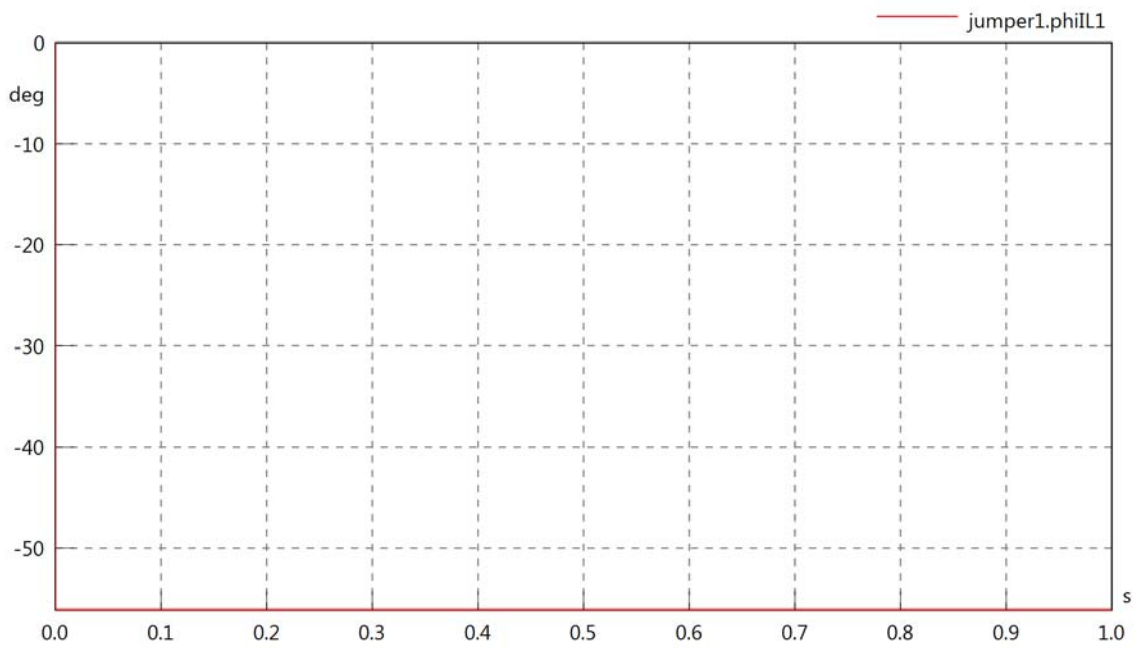

jumper1.phiIVL1

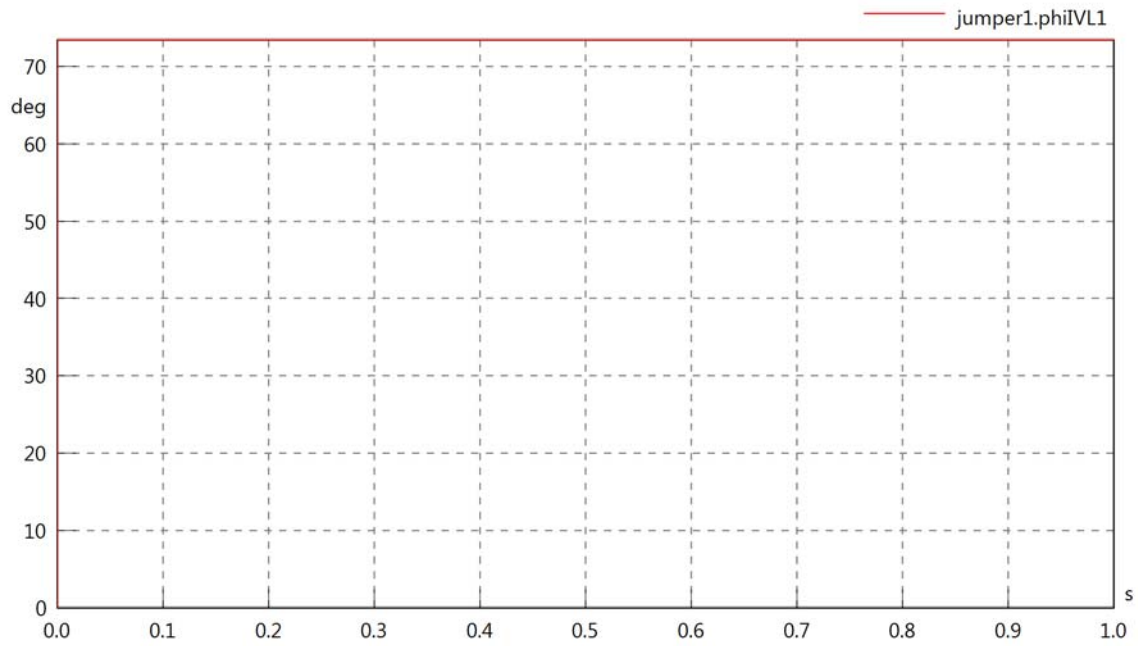

jumper1.PReIn

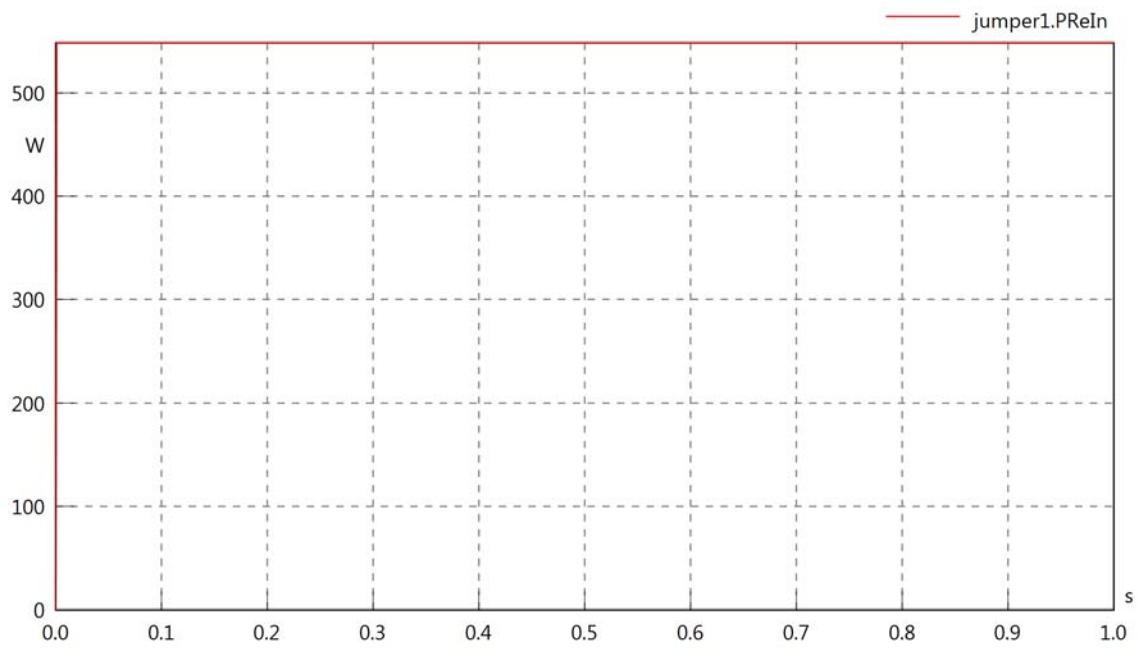

jumper1.PImIn

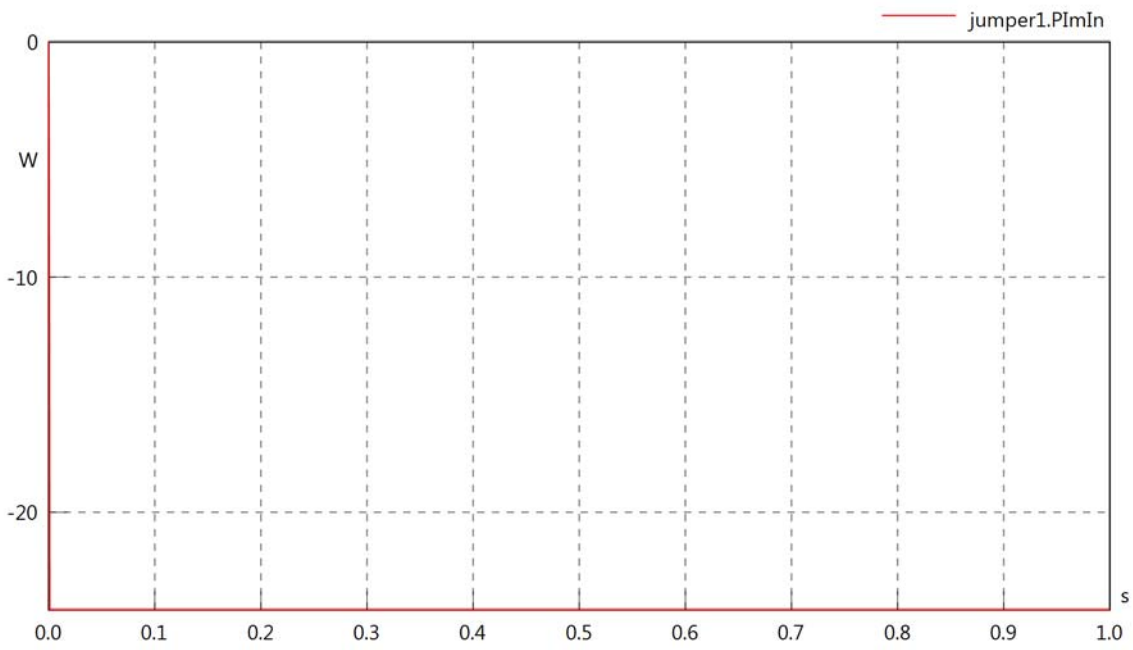

jumper1.SIn

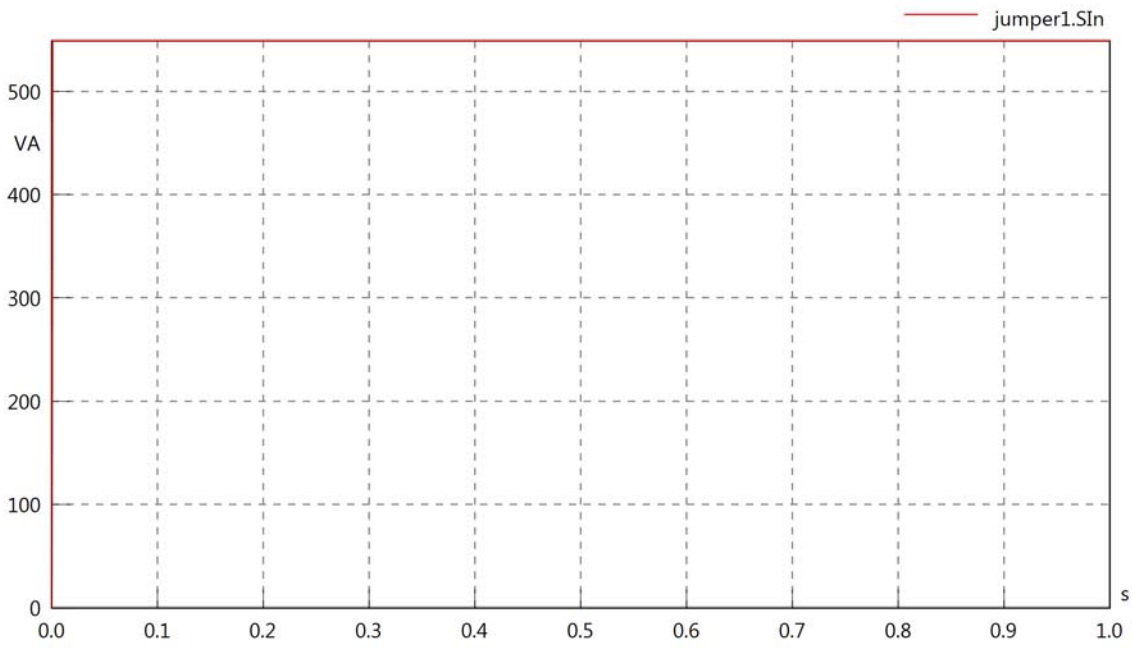

jumper1.PReOut

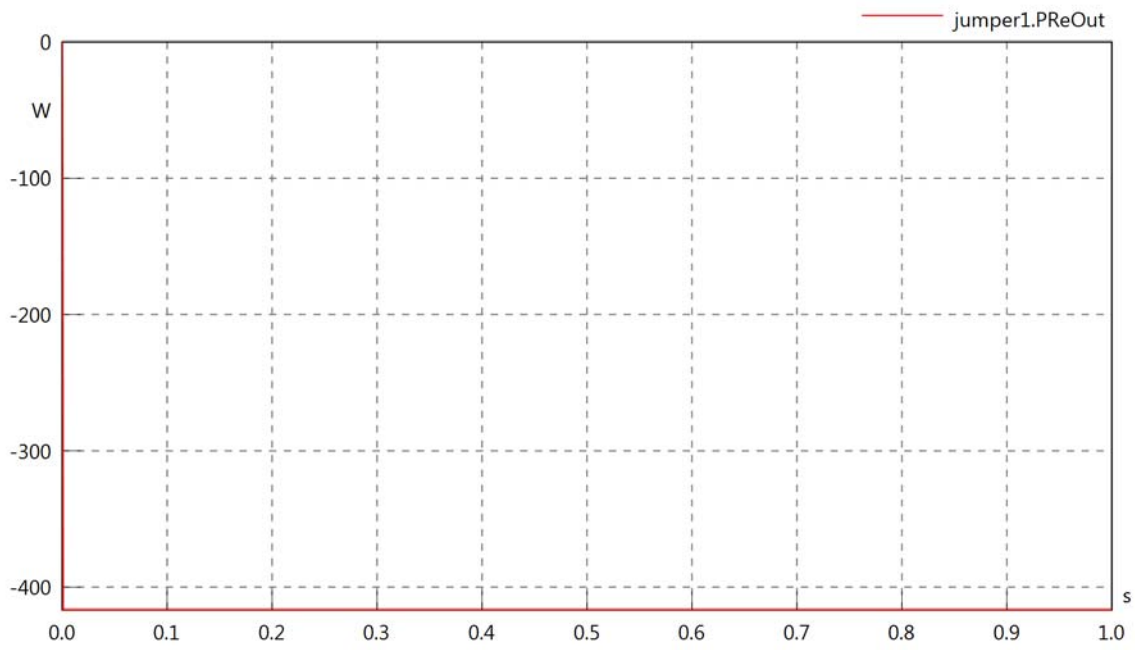

jumper1.PImOut

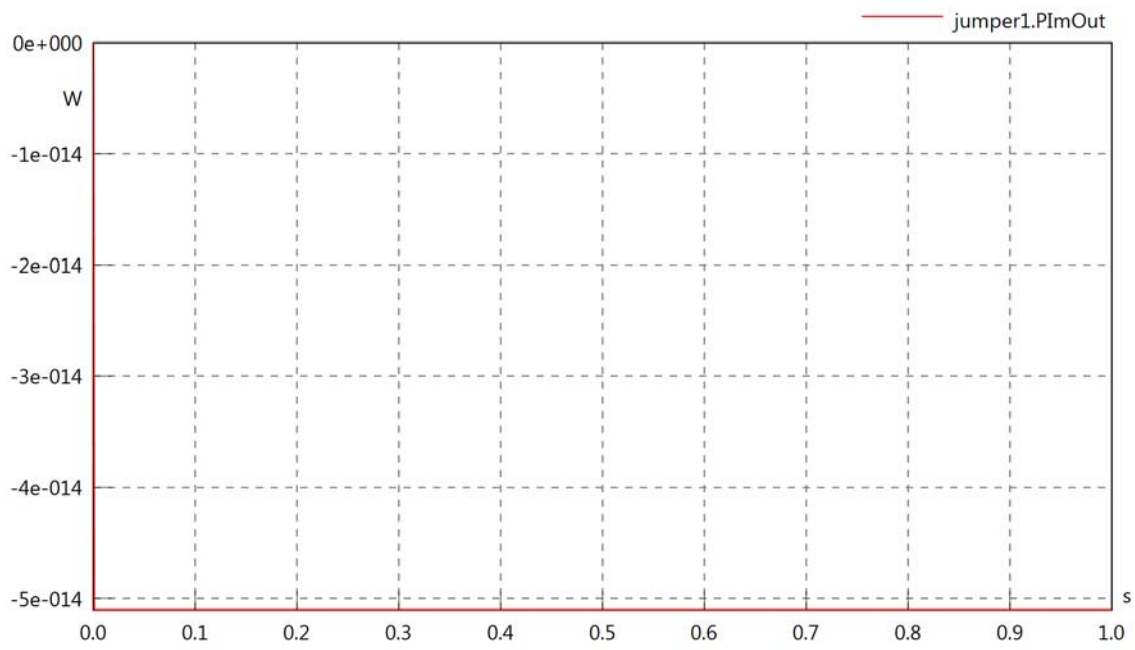

jumper1.SOut

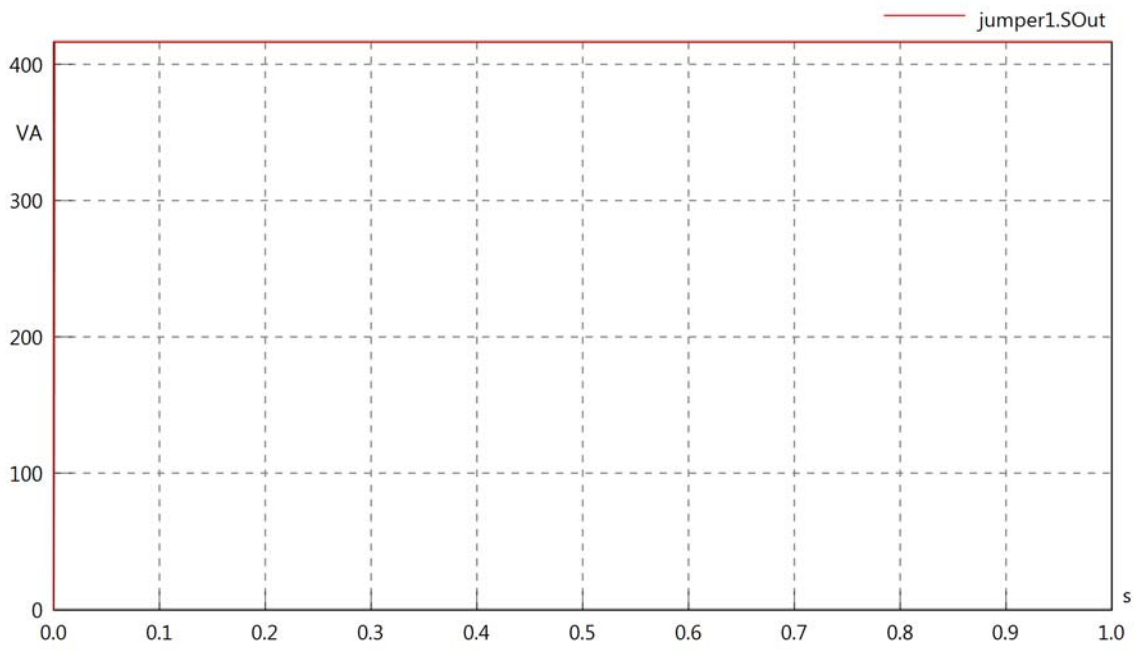

jumper1.PRe

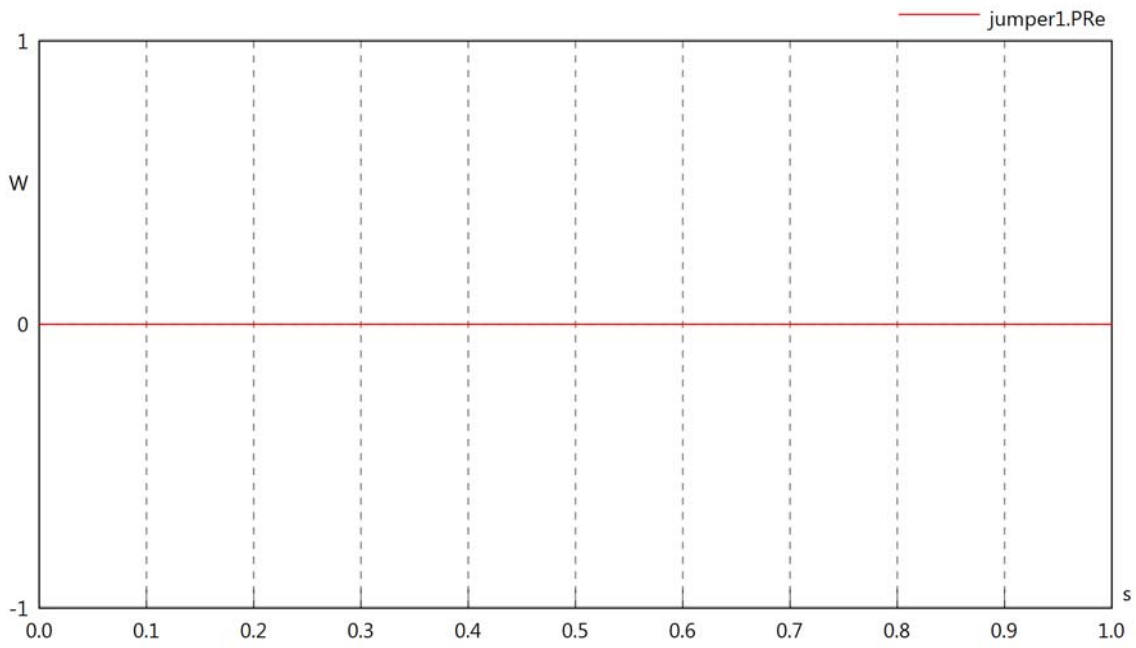

jumper1.PIm

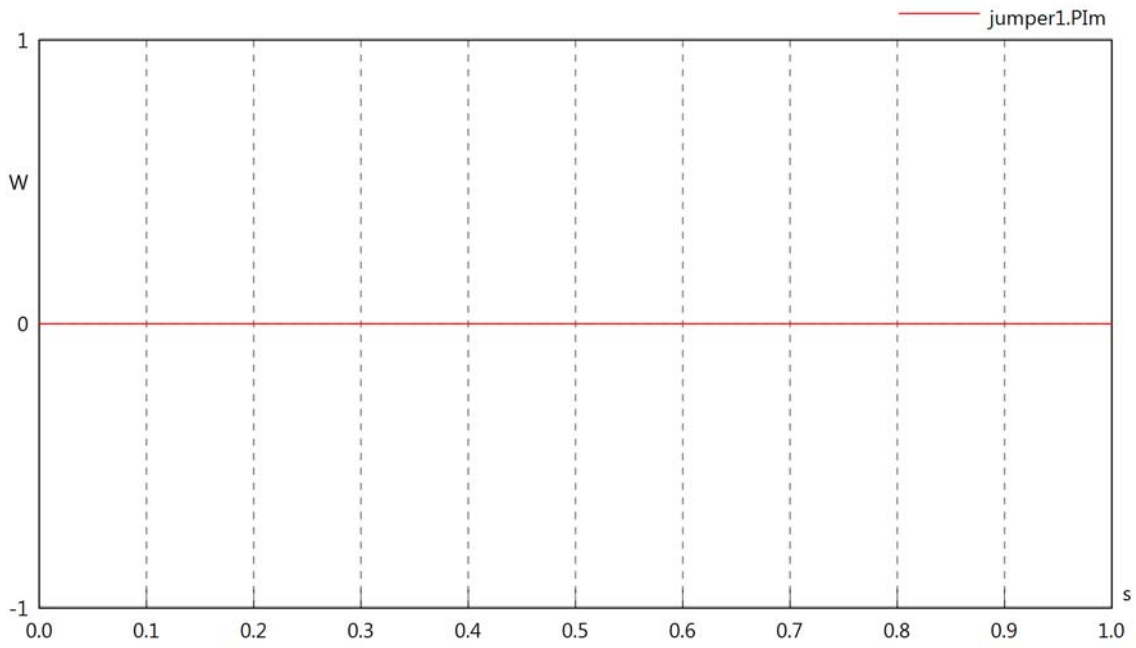

jumper1.S

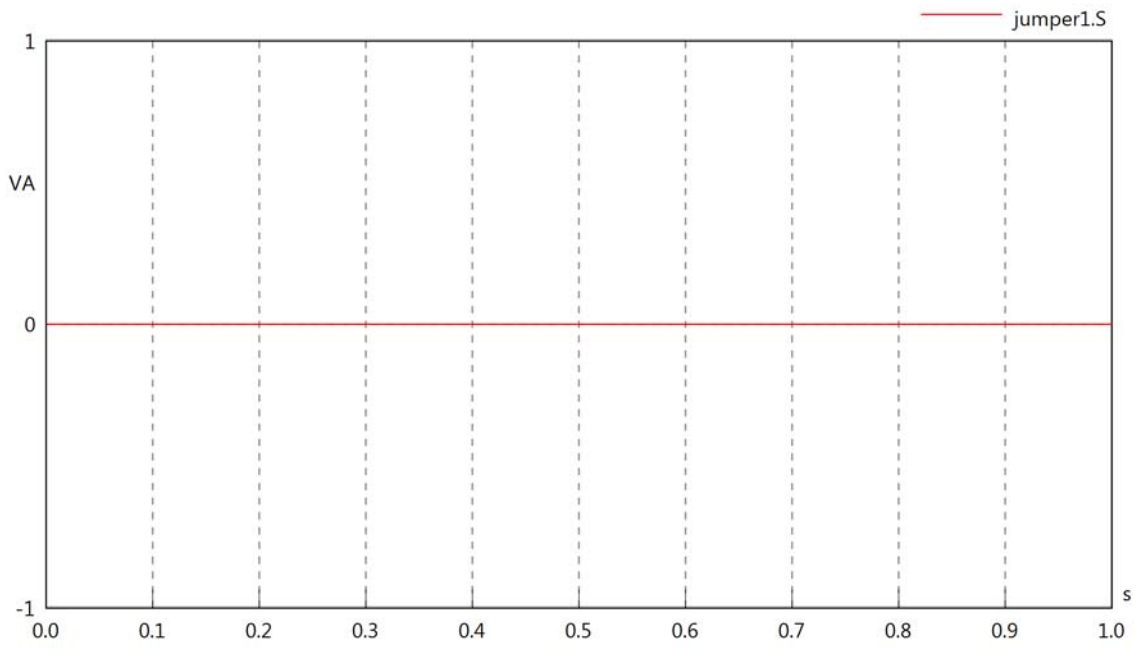

jumper1.dB

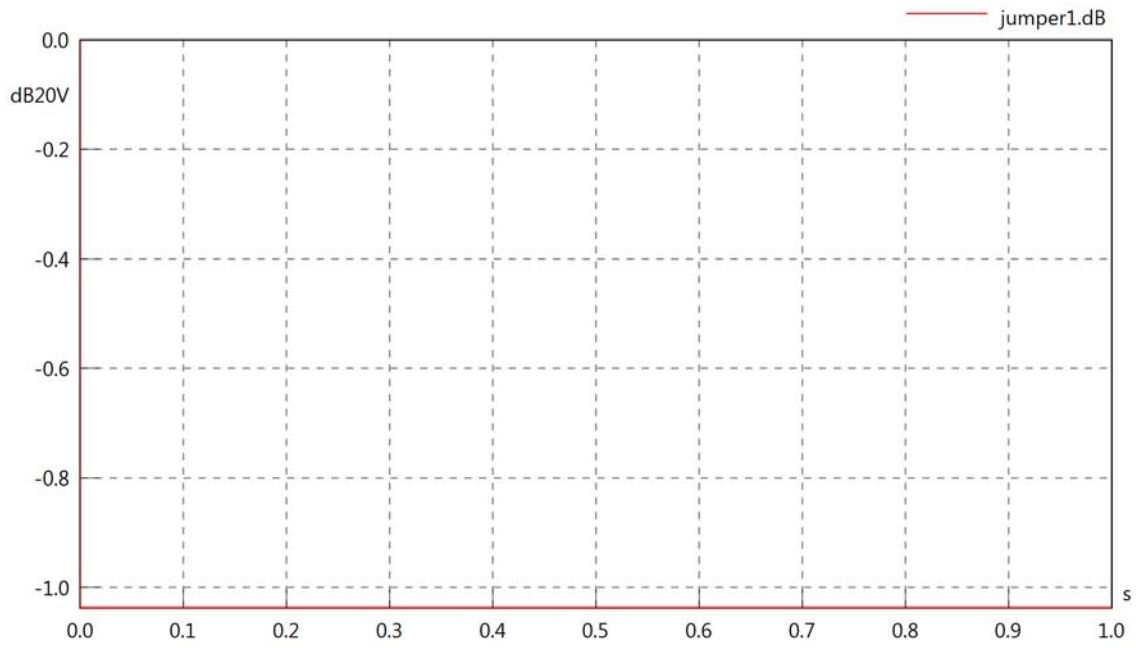
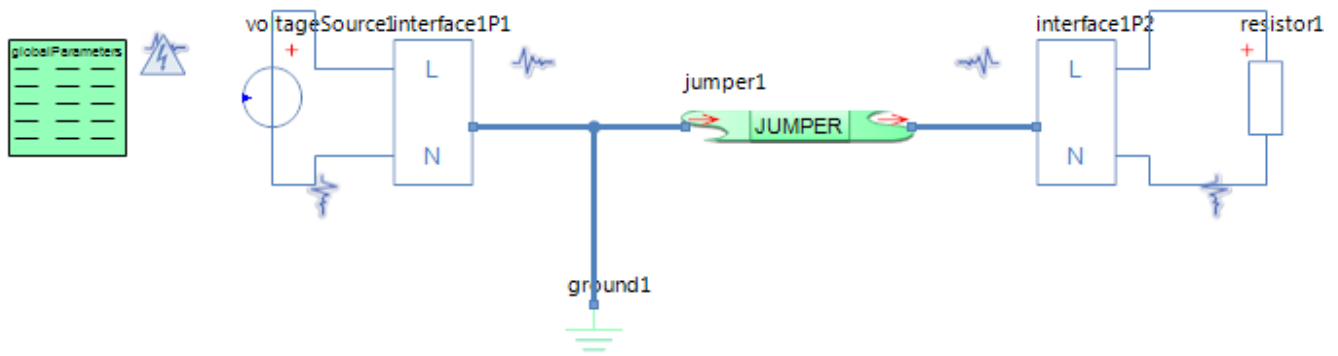

Diagram View



GlobalParameters globalParameters
Parameters

Comment	Name	Current Value	Unit
Type of Calculation	eCalculationKind	Signal Calculation	
Description of Frequency	eFrequencyKind	Linear	
Minimum Frequency	fMin	100	[kHz]
Maximum Frequency	fMax	100	[kHz]

Jumper jumper1
Parameters

Comment	Name	Current Value	Unit
Resistance per length for each Line at 20 °C (68 °F)	r	1	[Ohm/km]
Inductance per length for each Line	l	0.5	[mH/km]
Conductance per length between Lines	g	1e-10	[1/(Ohm·m)]
Capacitance per length between Lines	c	0.1	[µF/km]
Length of Jumper for each Line	length	10	[km]
Temperature of the conductor	temp	5	[°C]
Skin effect	skinEff	Round, stranded or solid copper conductor	
Conductor area	area	6	[mm²]

Voltage Source voltageSource1
Parameters

Comment	Name	Current Value	Unit
Voltage RMS	VrmsSrc	min(230,230000*t)	[V]
Phase	phi	0	[deg]

Resistor resistor1
Parameters

Comment	Name	Current Value	Unit
Resistance	R	100	[Ohm]

jumper1.rTemp

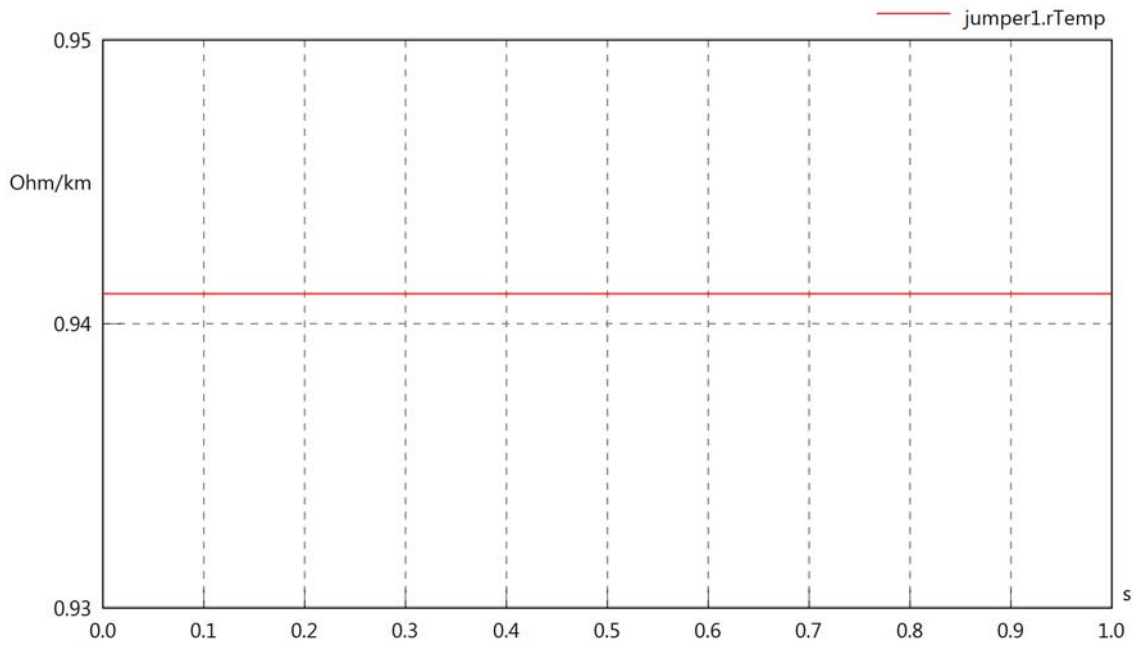

jumper1.skinDepth

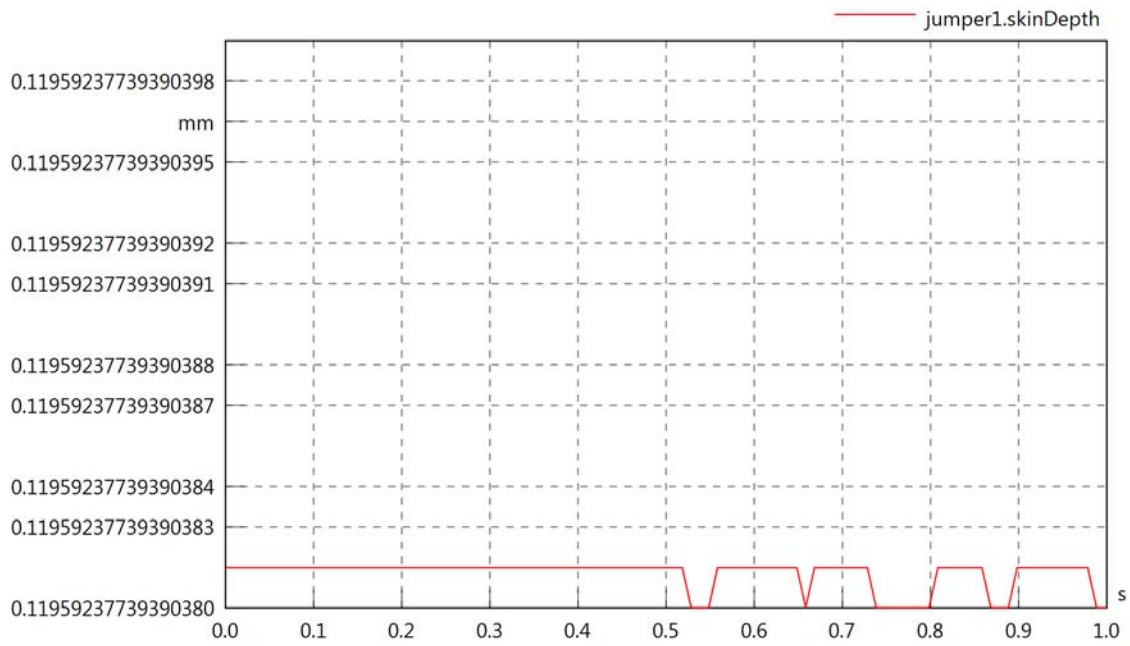

jumper1.diameter

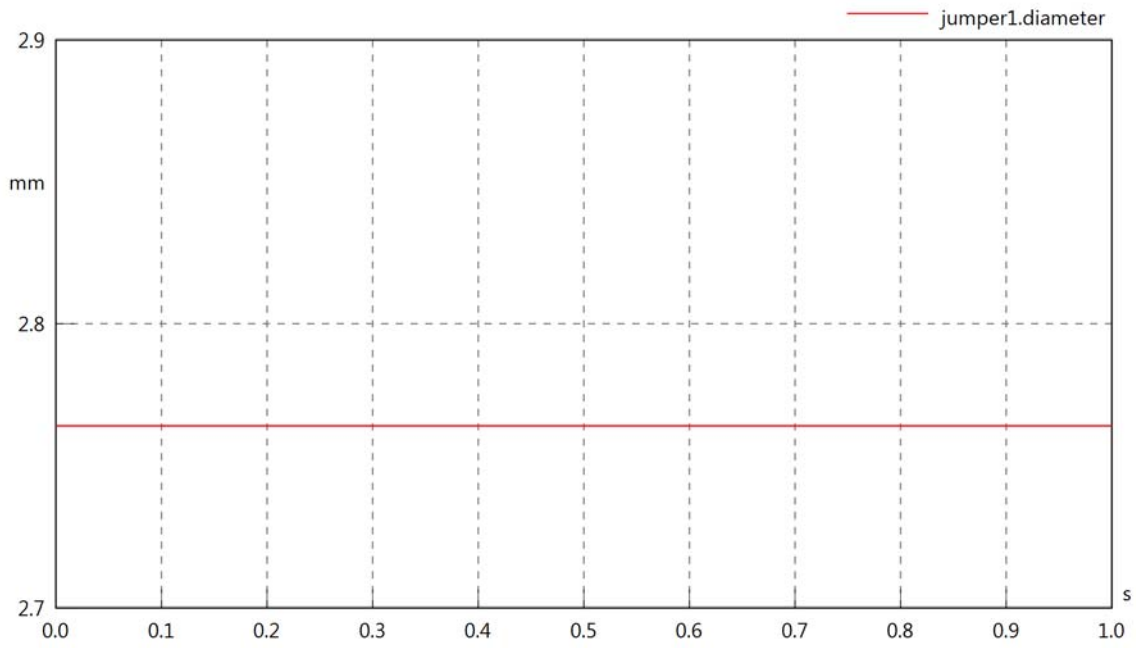

jumper1.resistivity

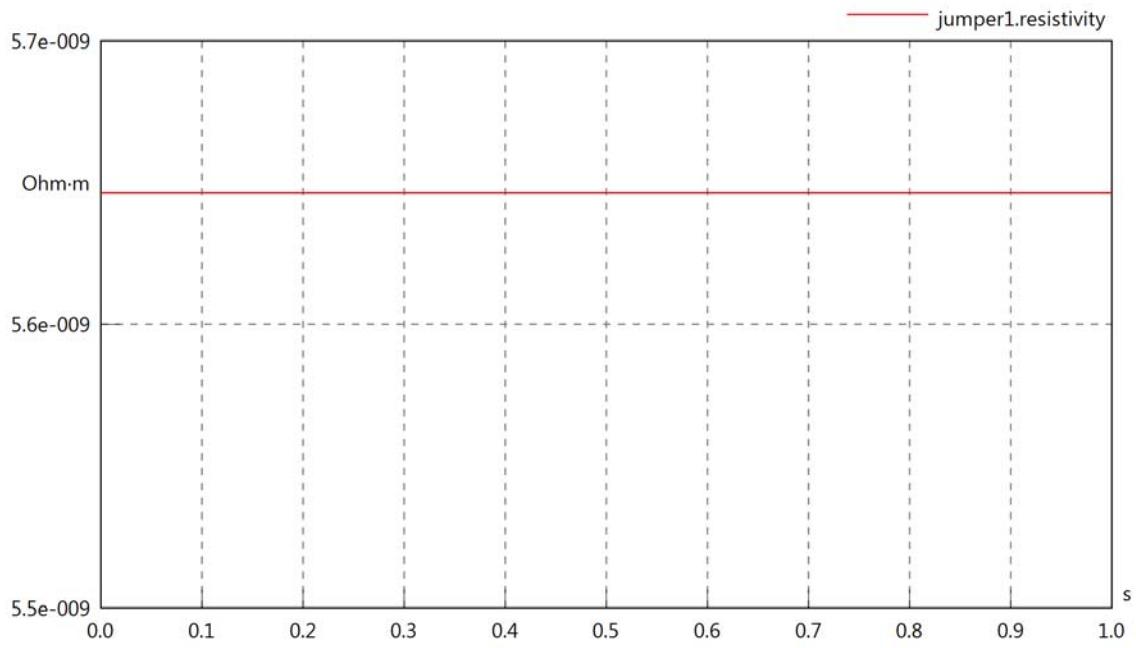

jumper1.rInternal

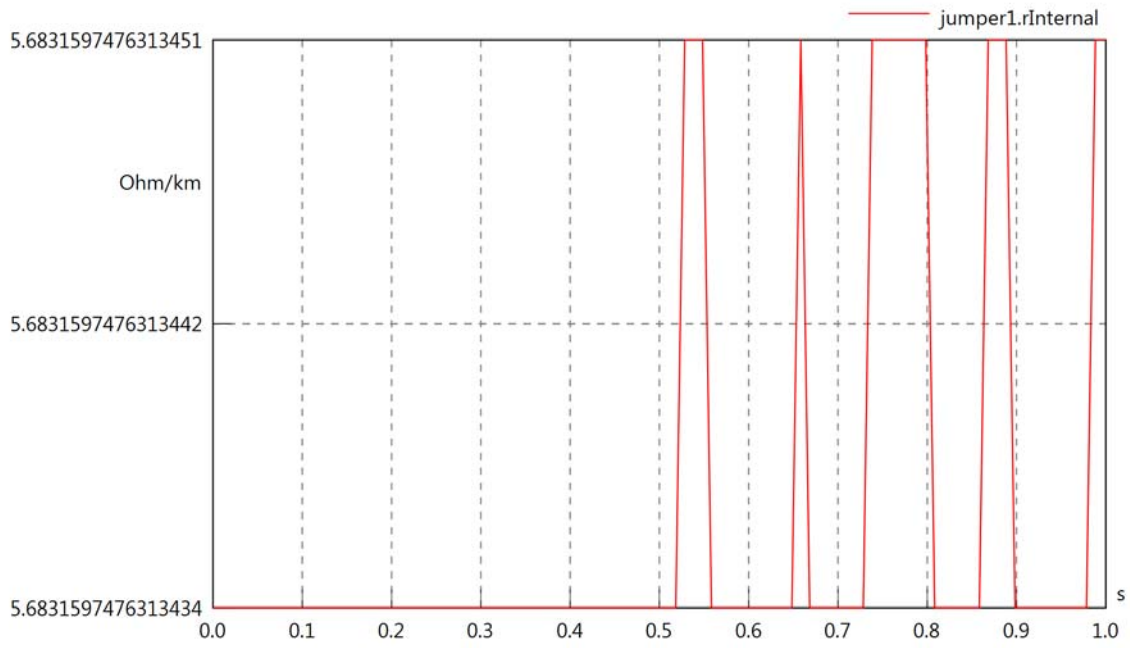

jumper1.VrmsIn

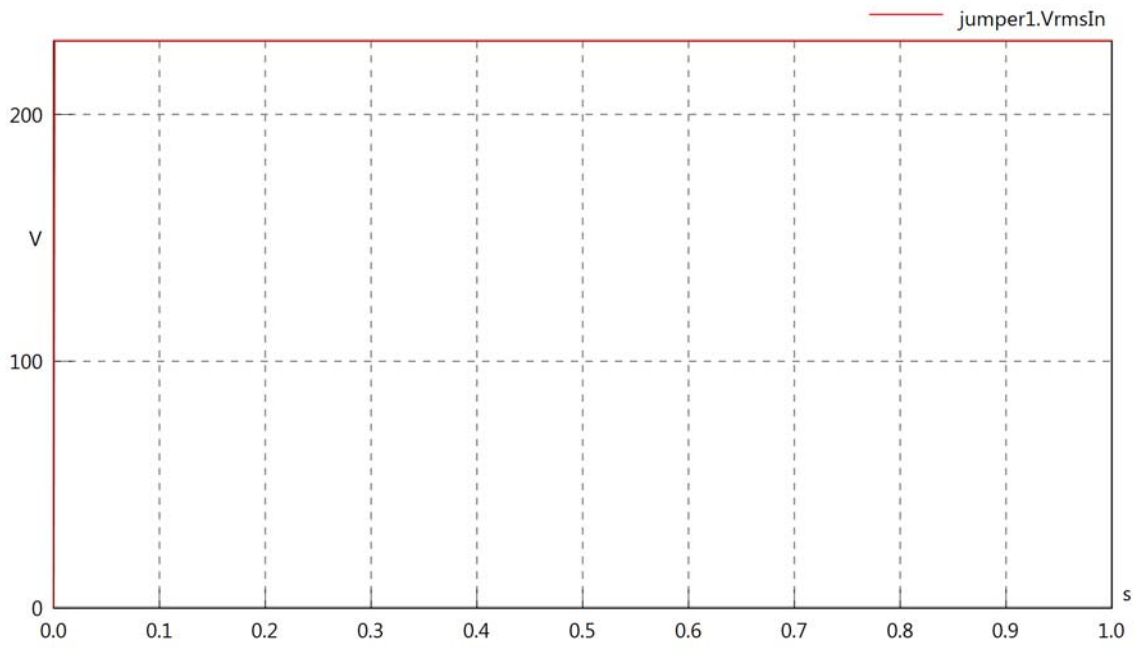

jumper1.vReIn

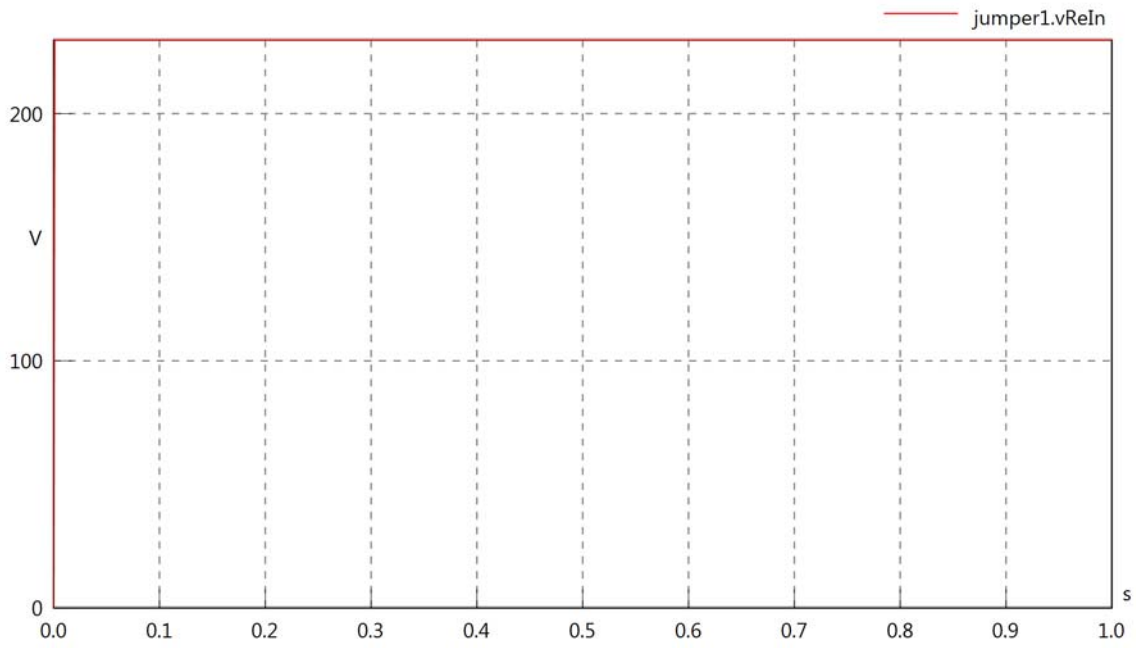

jumper1.vImIn

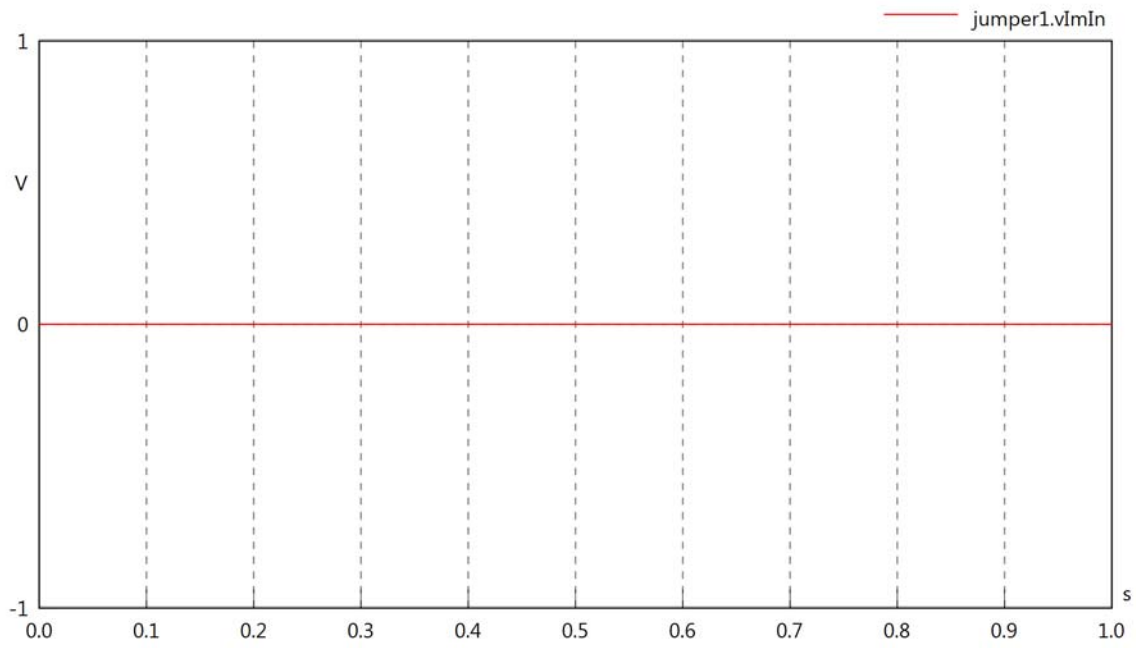

jumper1.VrmsOut

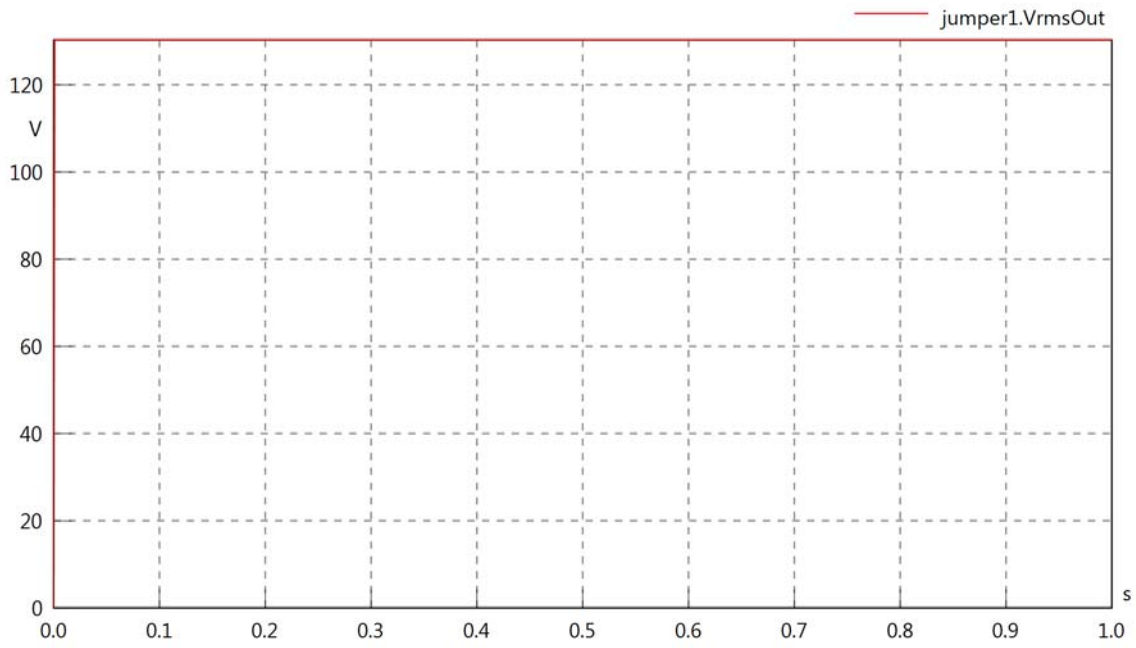

jumper1.vReOut

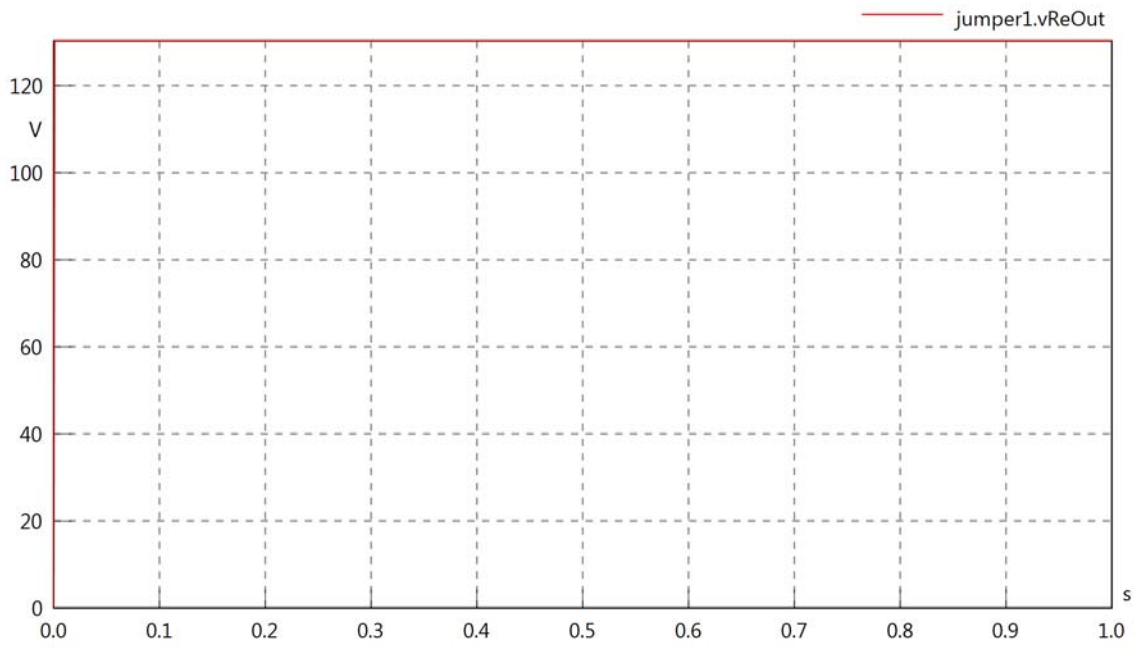

jumper1.vImOut

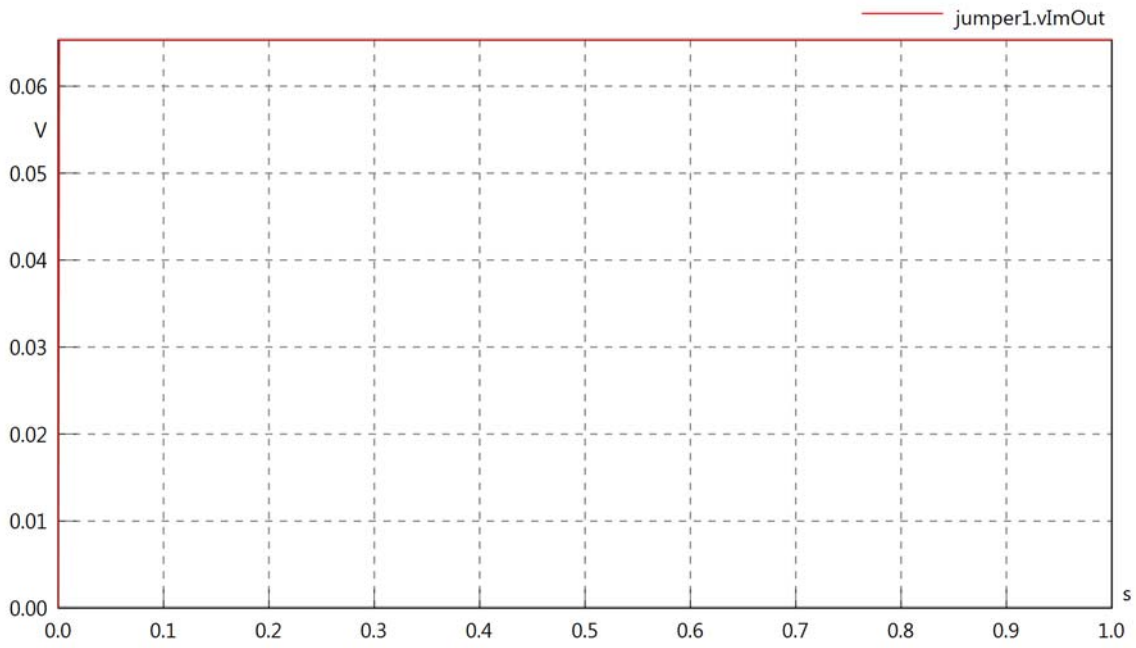

jumper1.Vrms

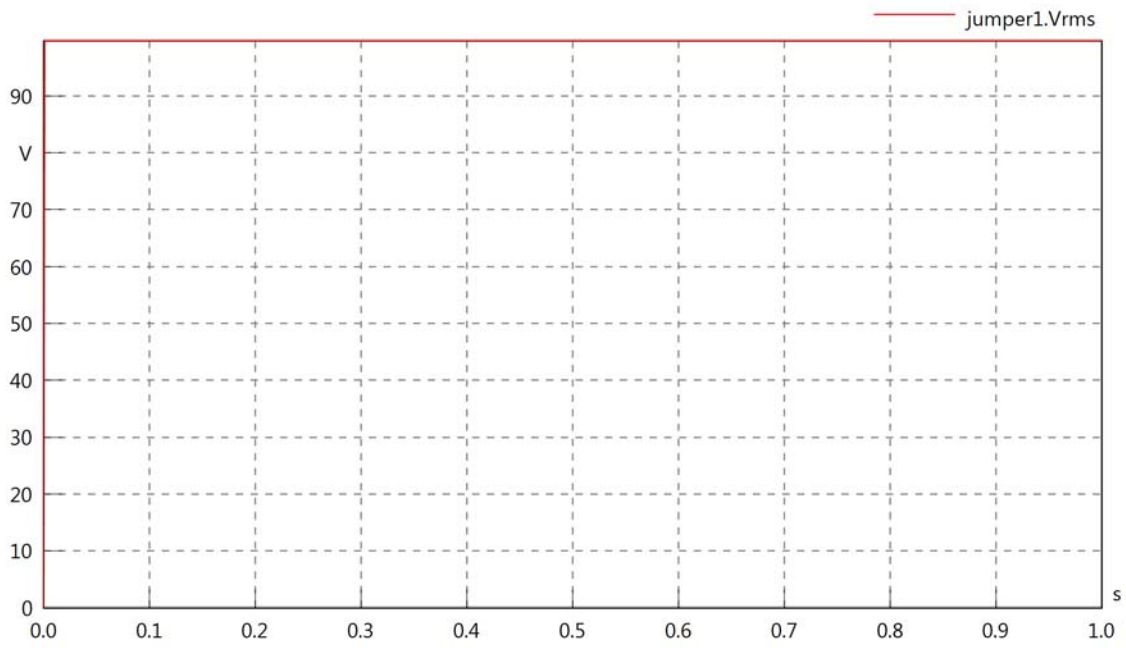

jumper1.vRe

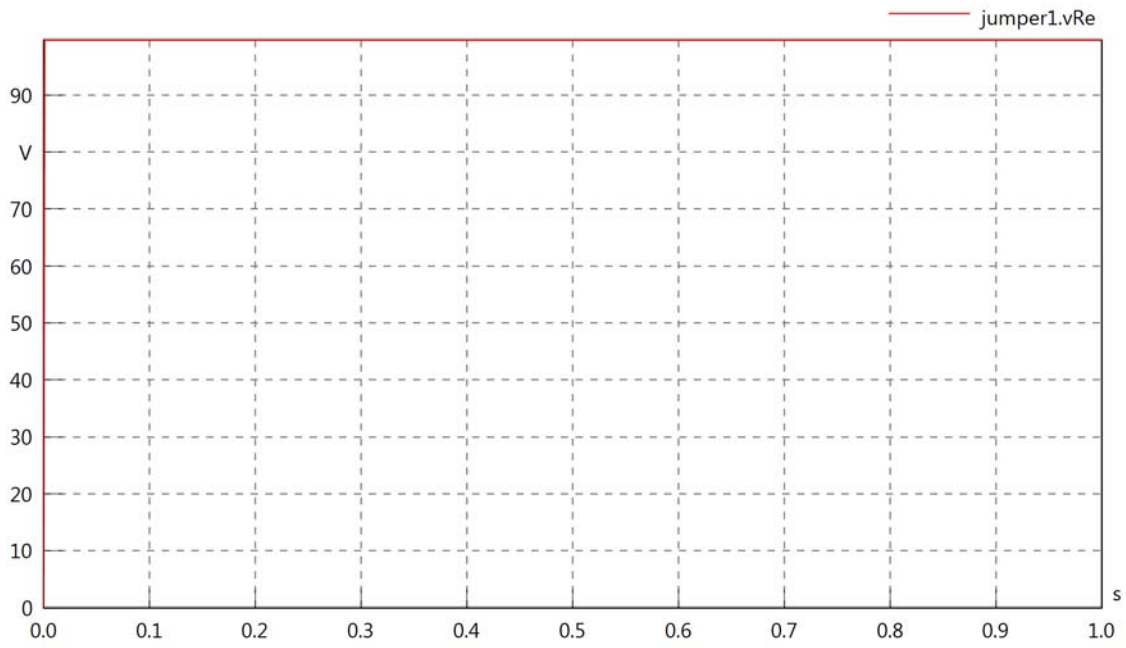

jumper1.vIm

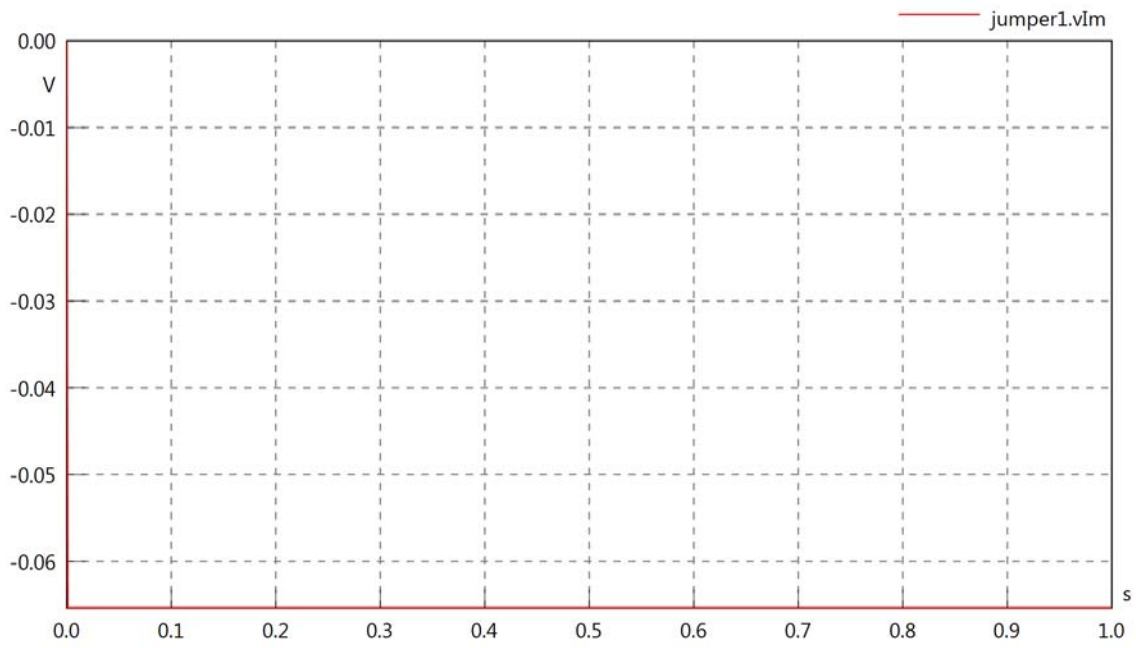

jumper1.IrmsIn

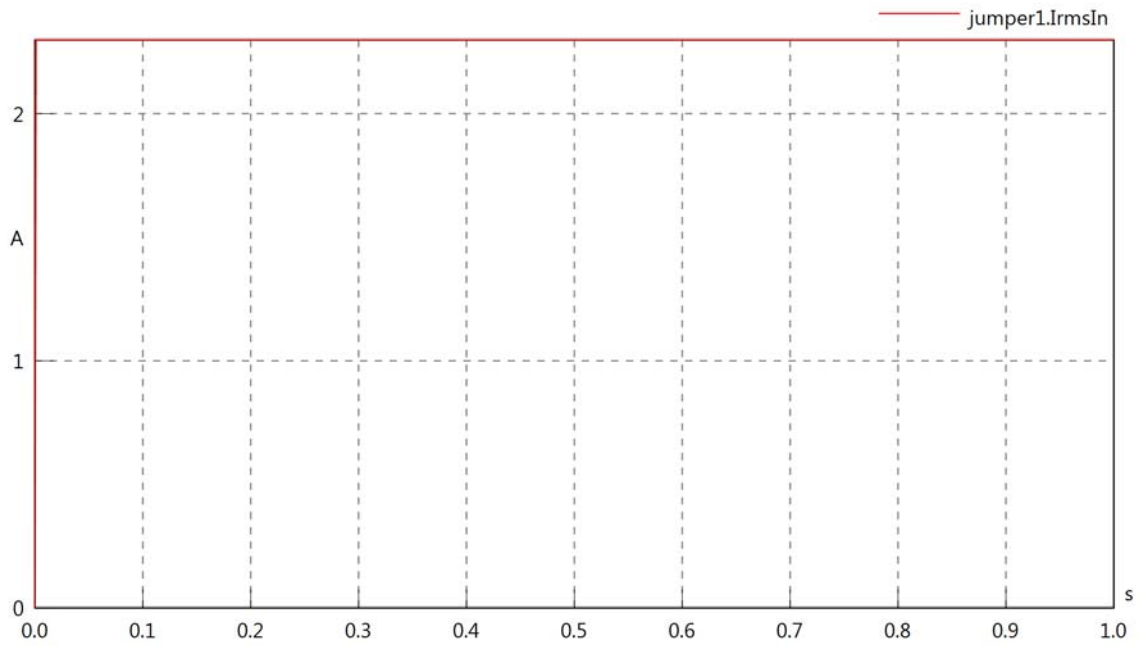

jumper1.iReIn

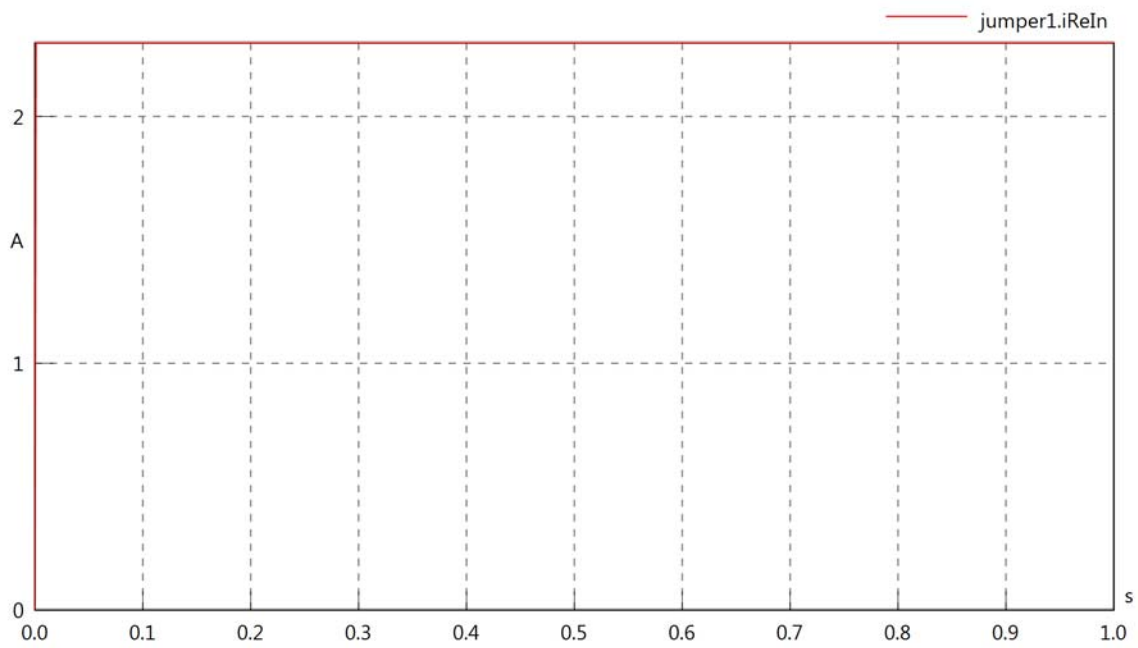

jumper1.ilmIn

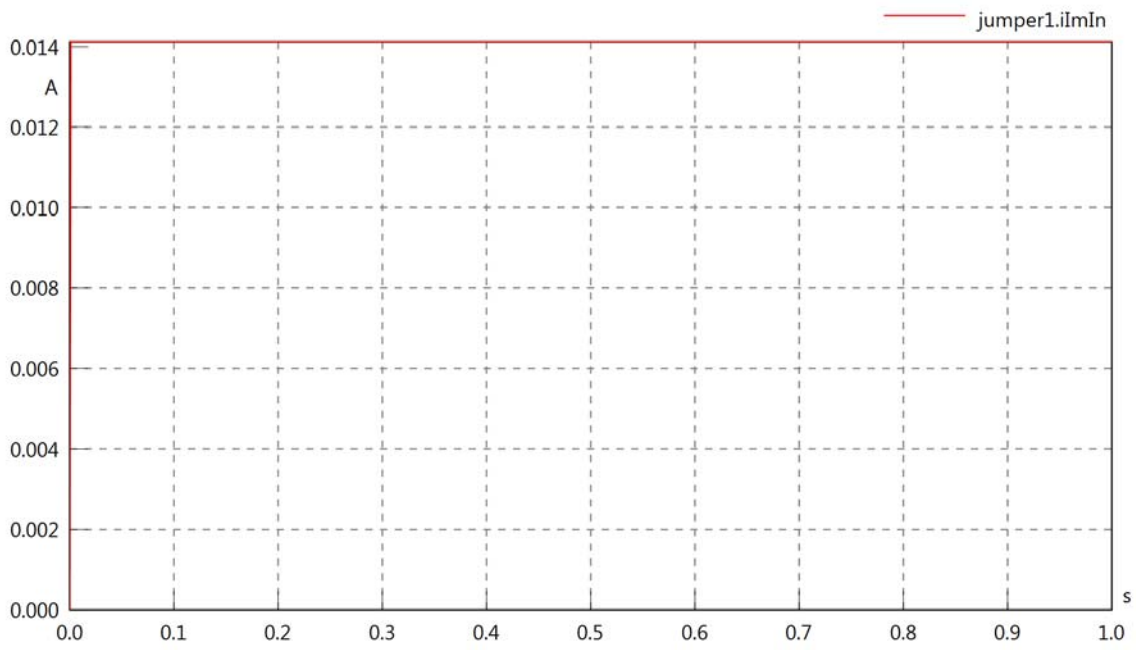

jumper1.IrmsOut

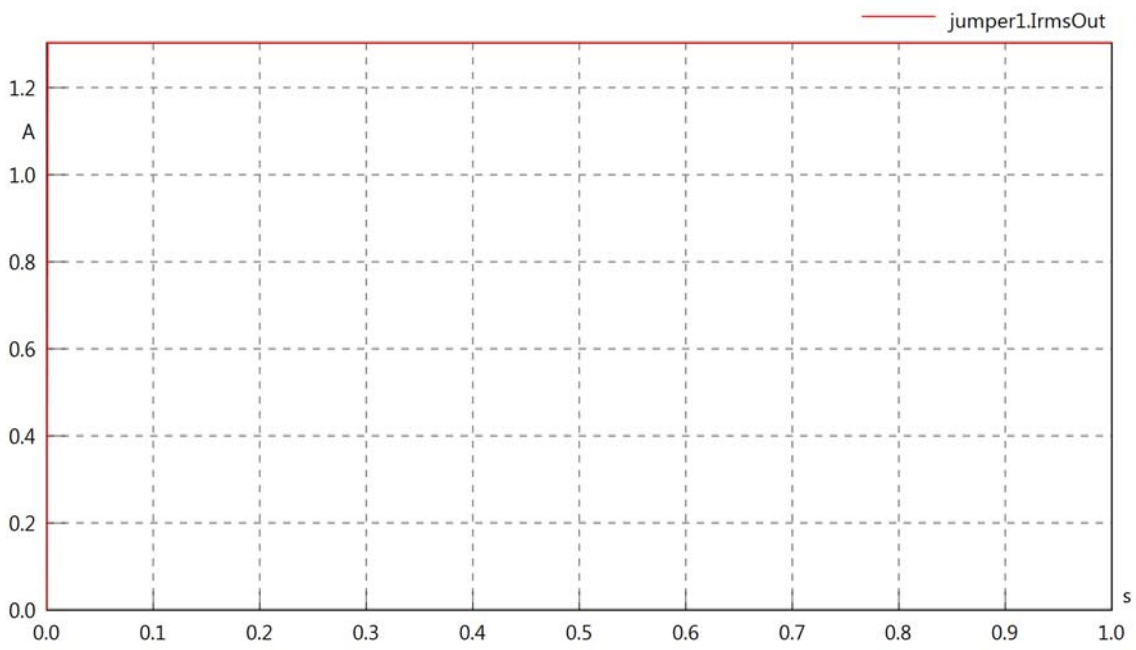

jumper1.iReOut

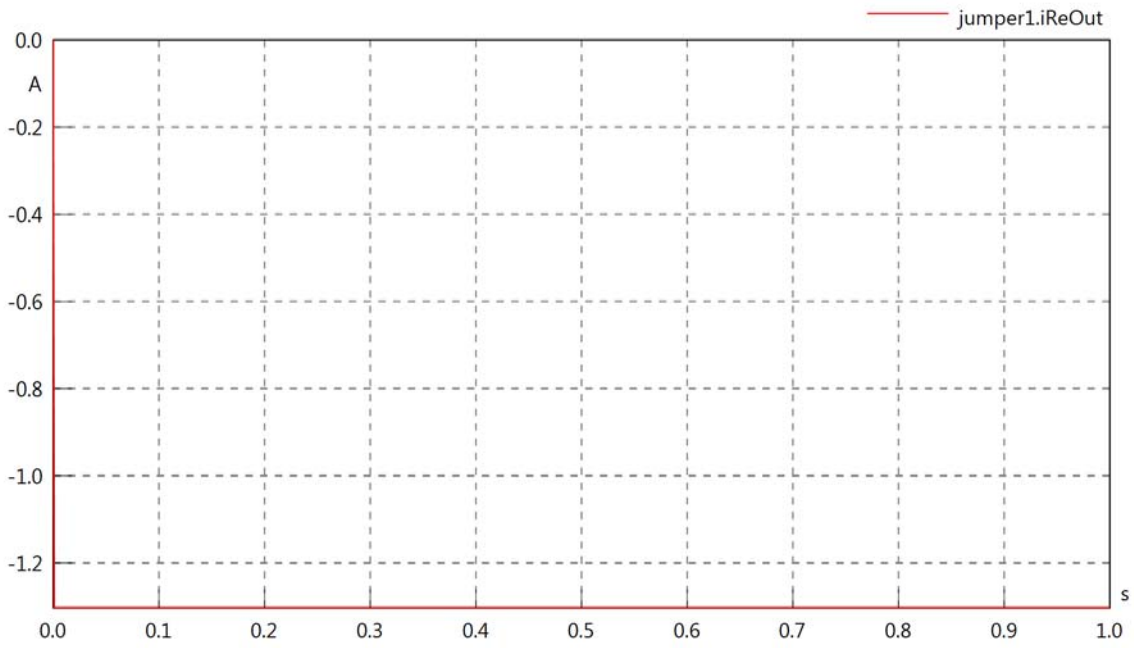

jumper1.iImOut

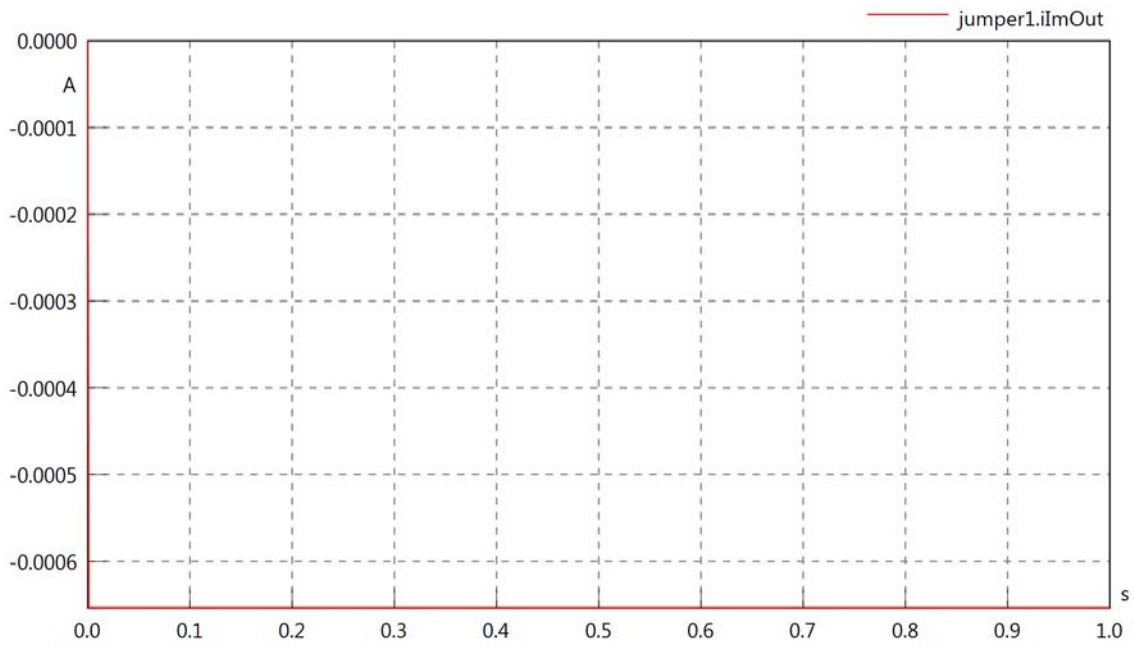

jumper1.phiVIn

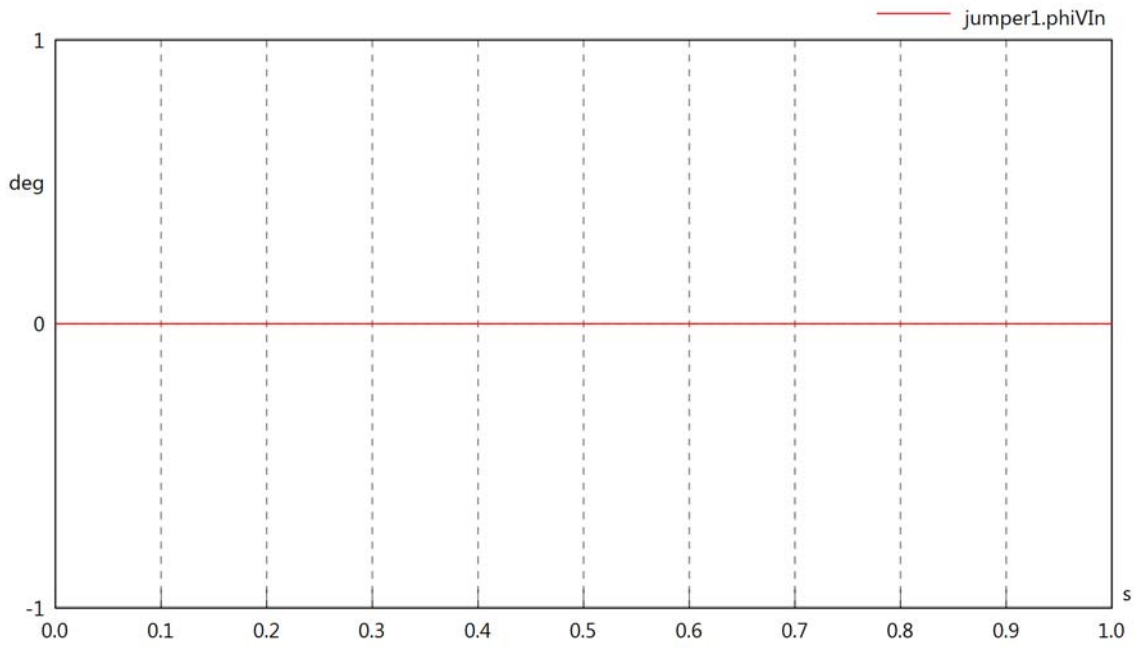

jumper1.phiIn

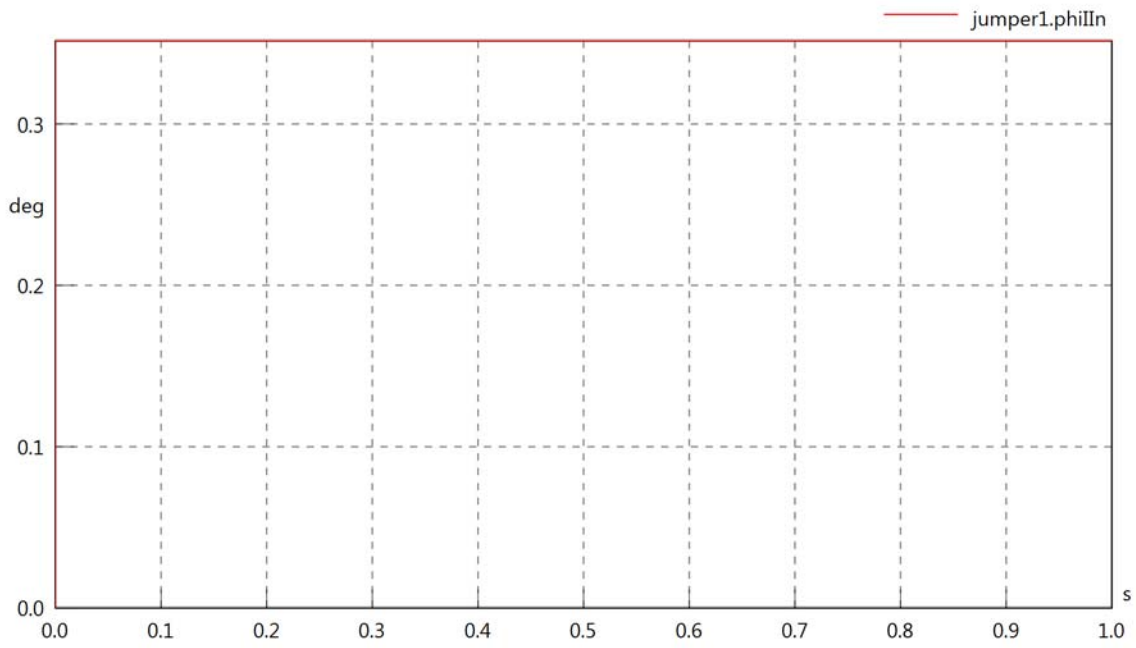

jumper1.phiVIn

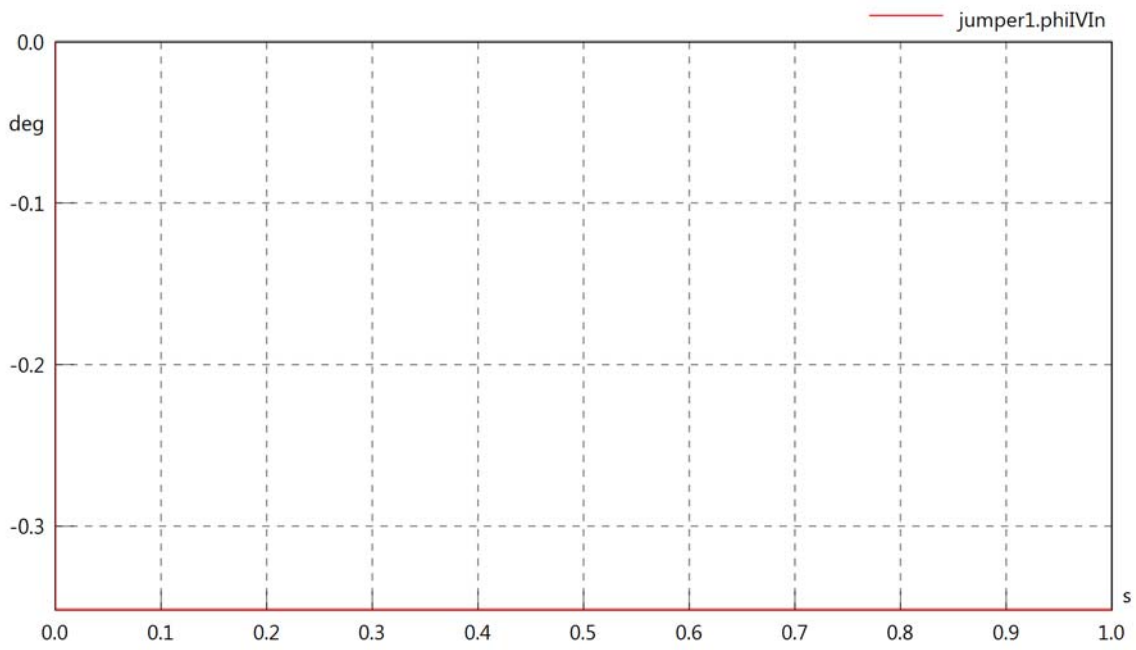

jumper1.phiVOut

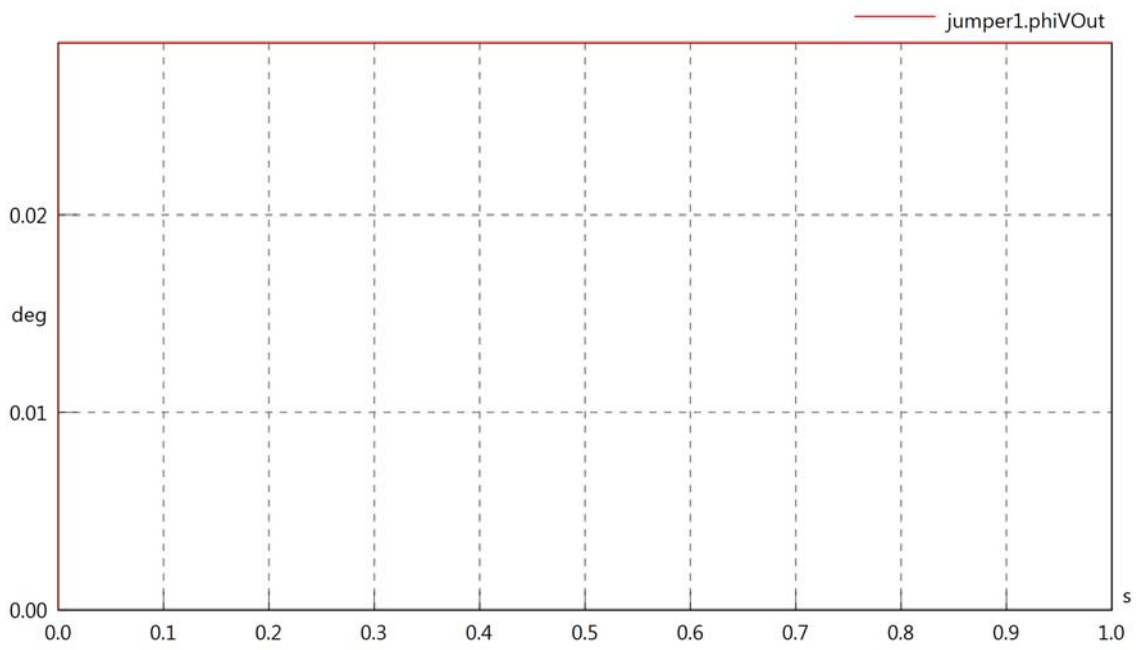

jumper1.phiIOut

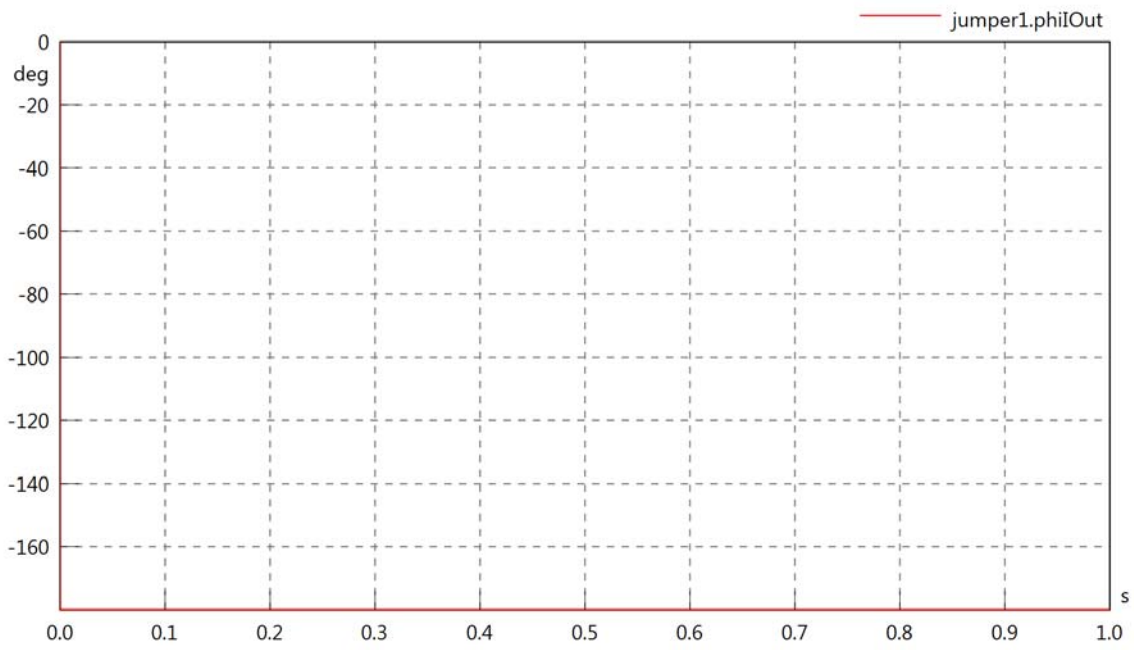

jumper1.phiIVOut

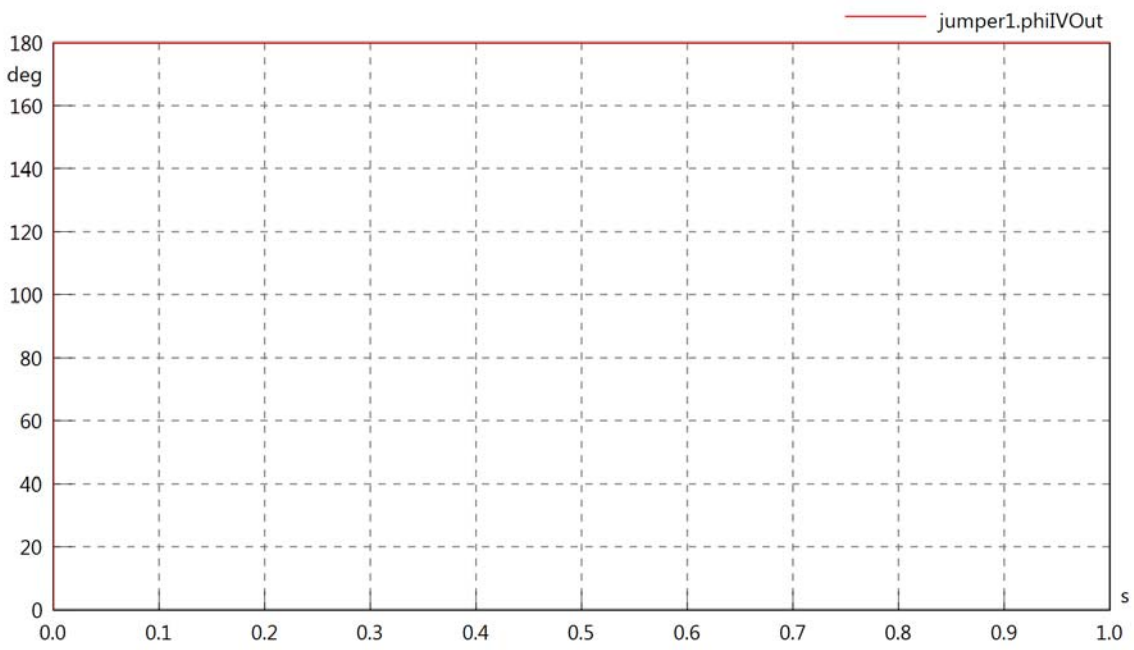

jumper1.phiVL1

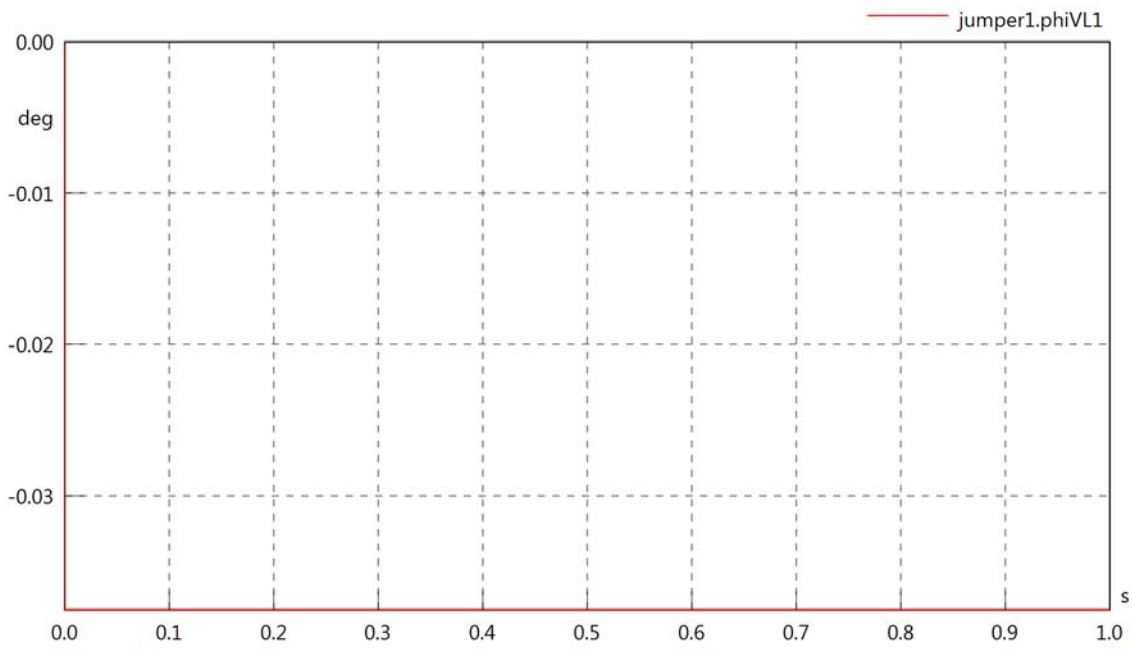

jumper1.phiIL1

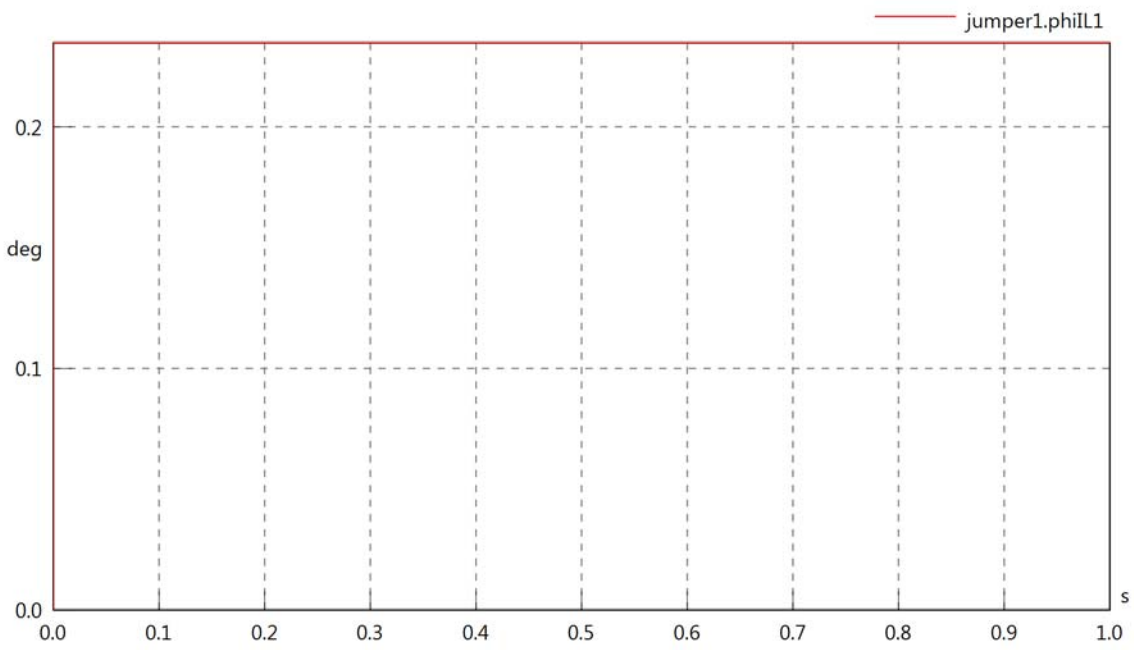

jumper1.phiVL1

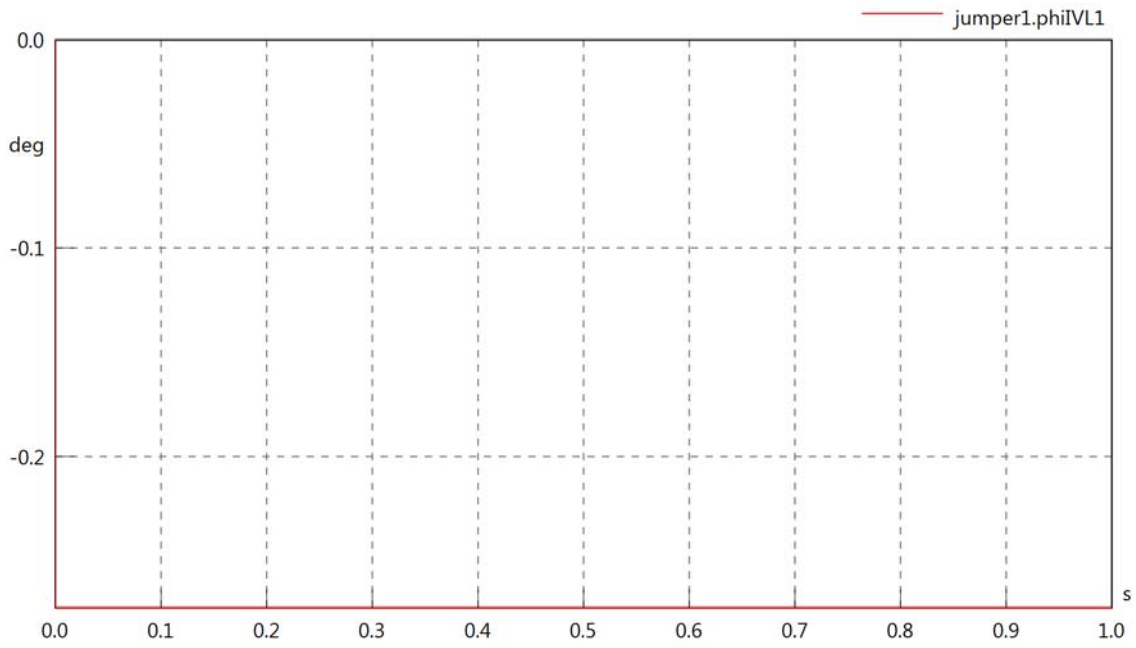

jumper1.PReIn

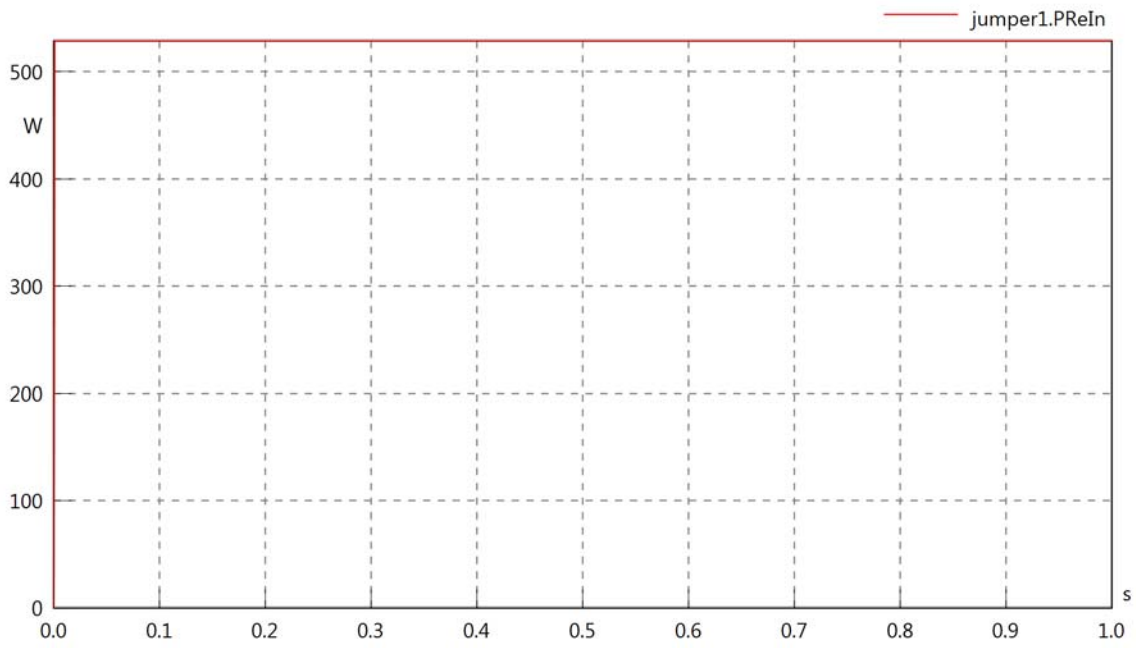

jumper1.PImIn

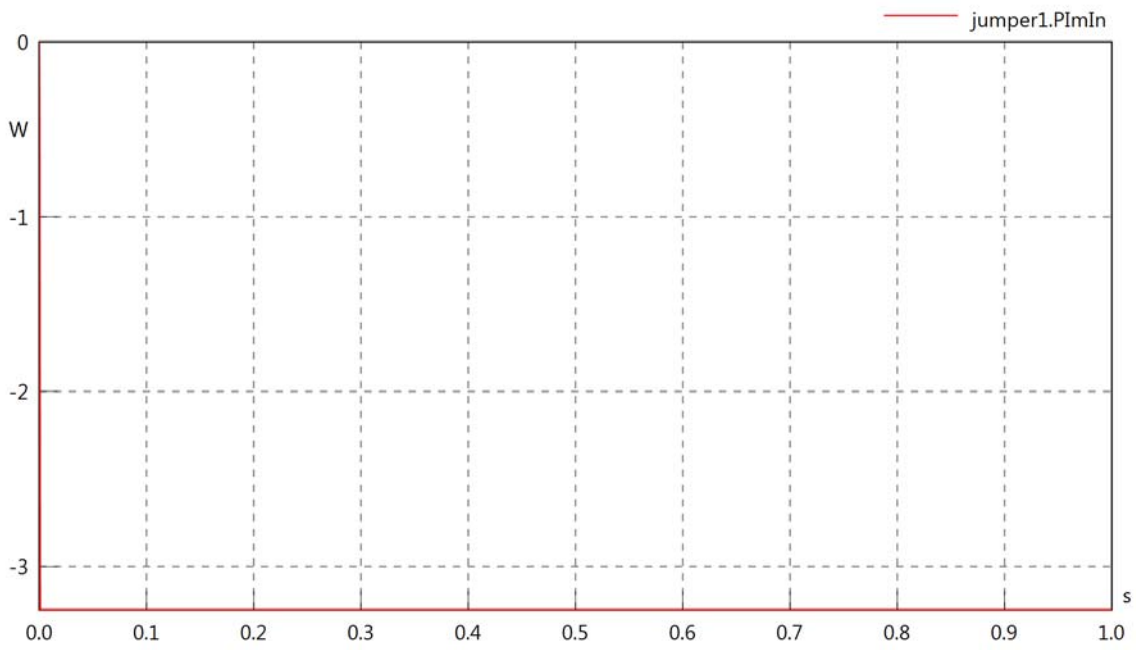

jumper1.SIn

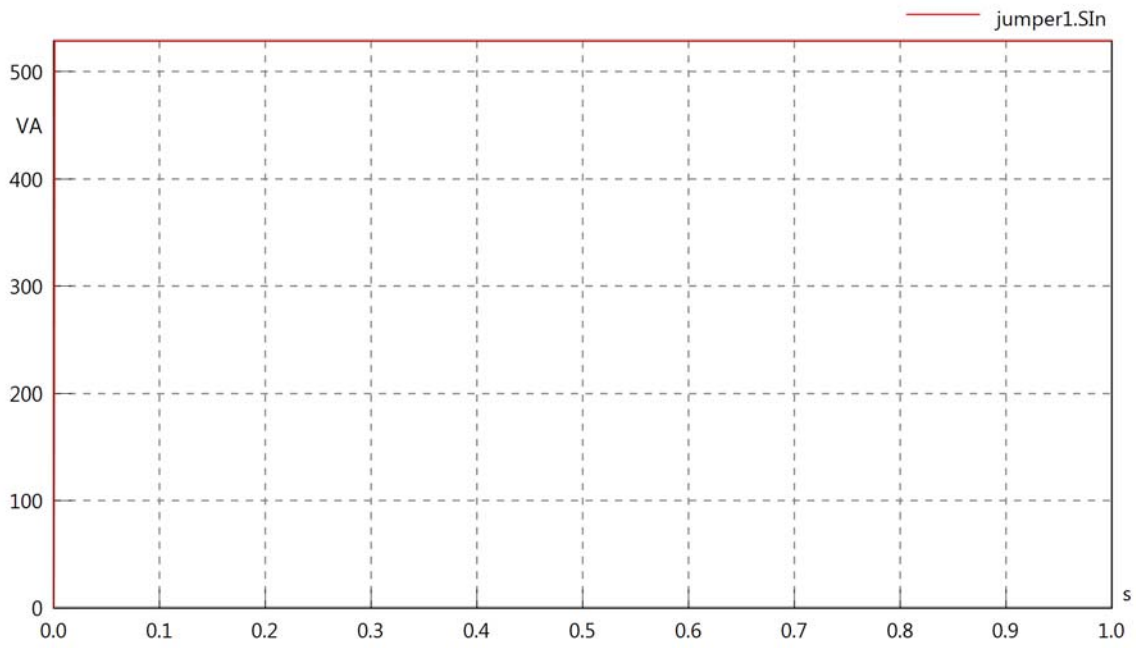

jumper1.PReOut

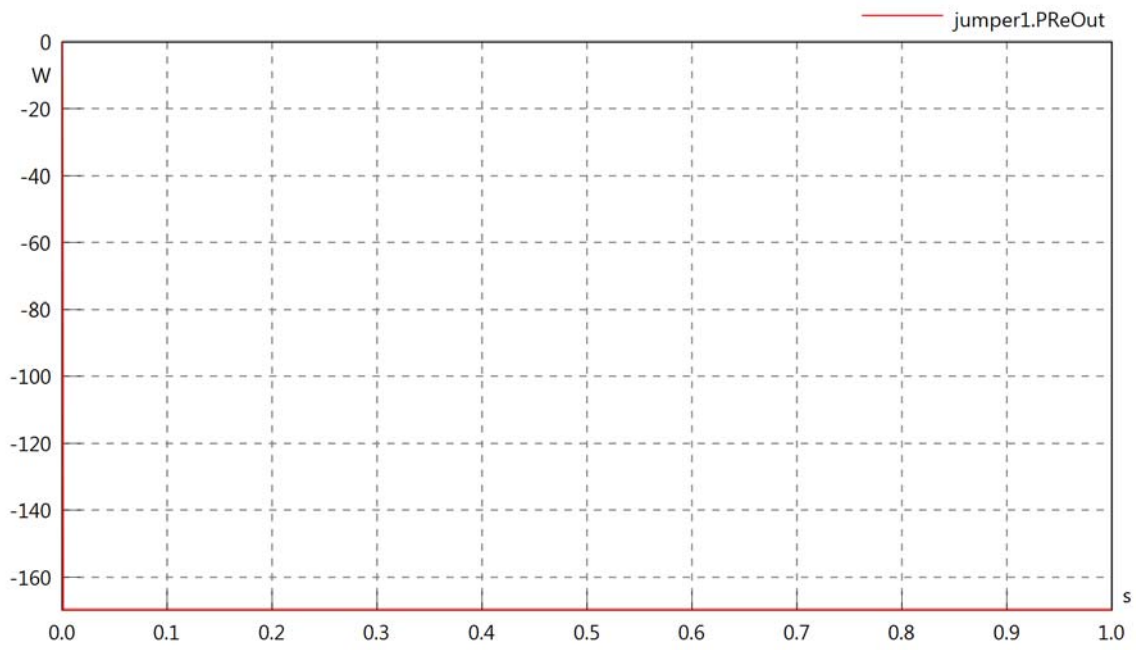

jumper1.PImOut

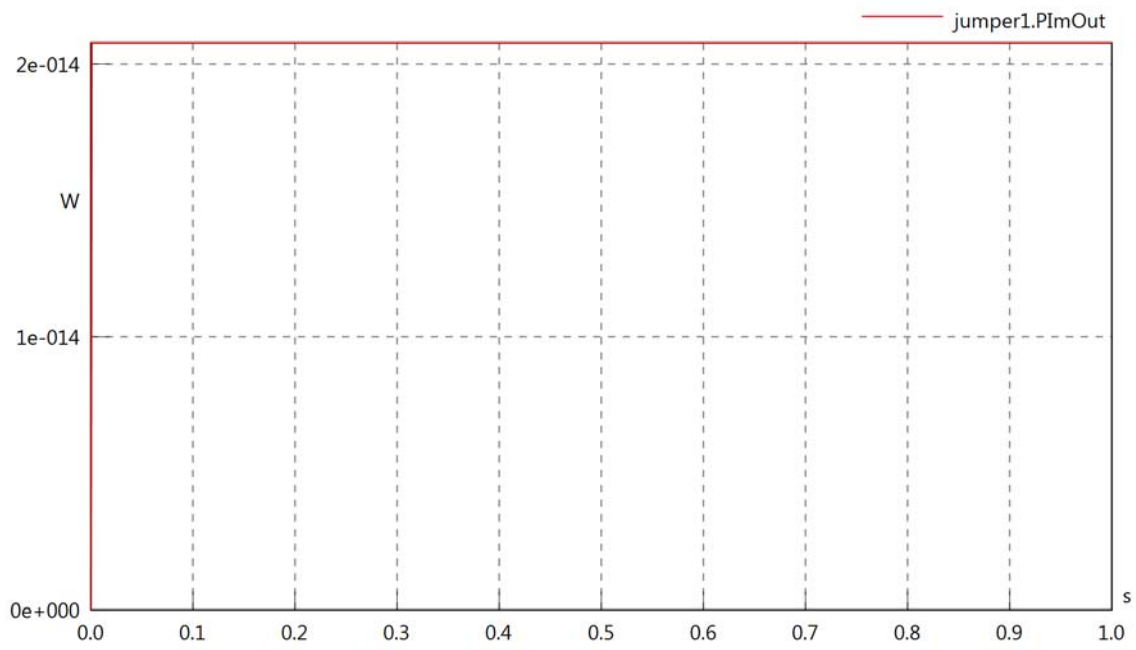

jumper1.SOut

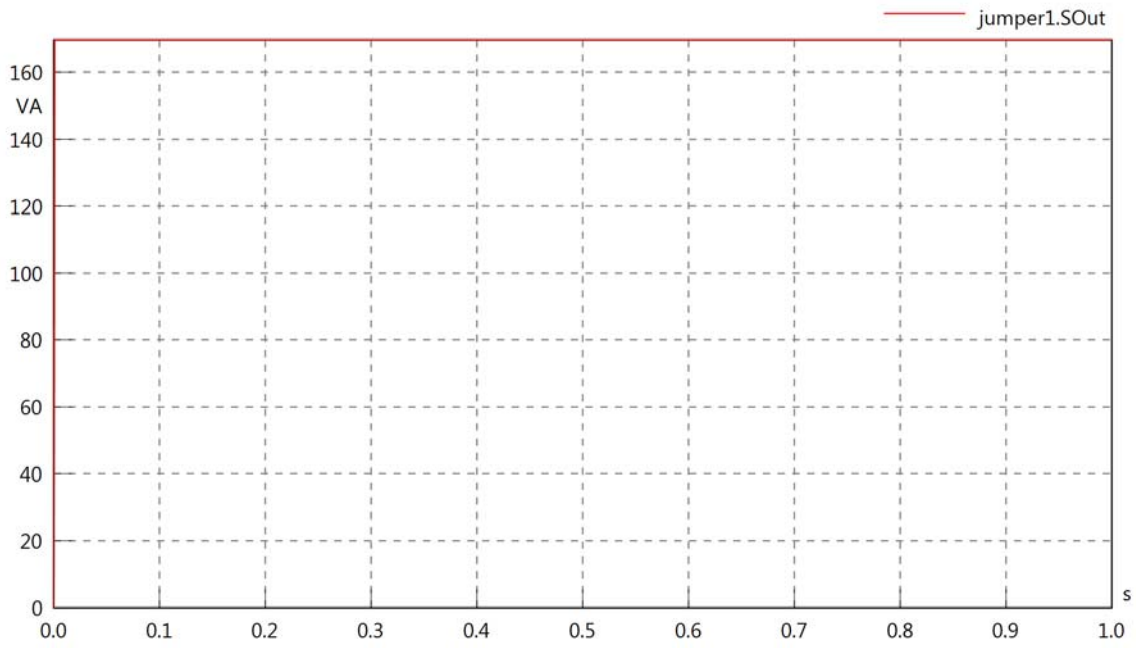

jumper1.PRe

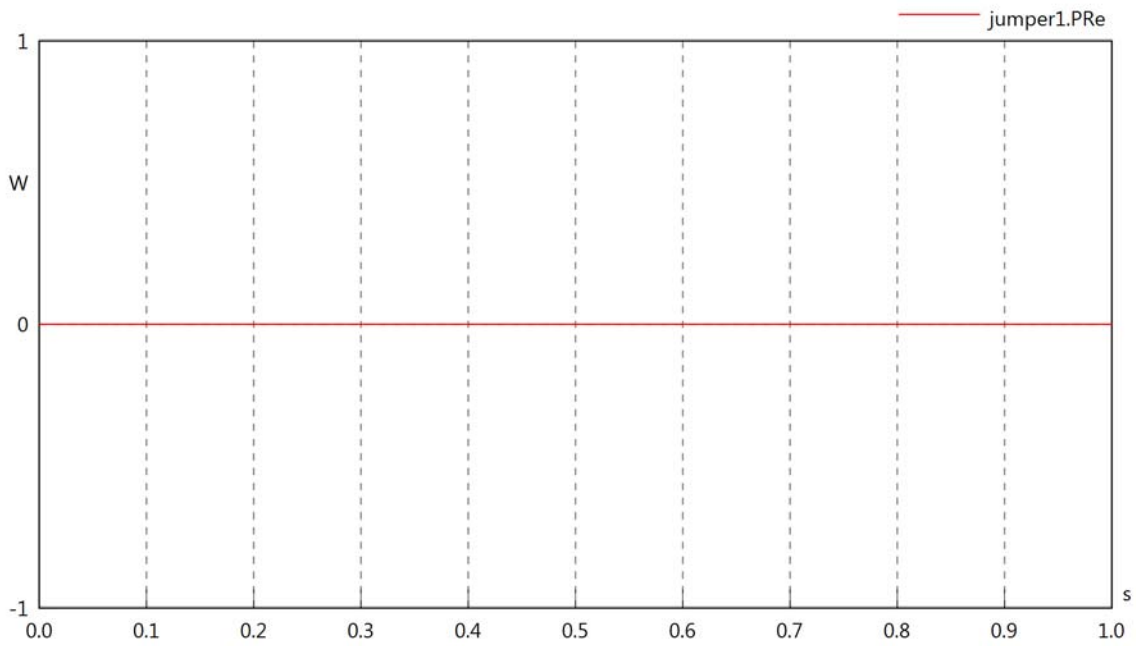

jumper1.PIm

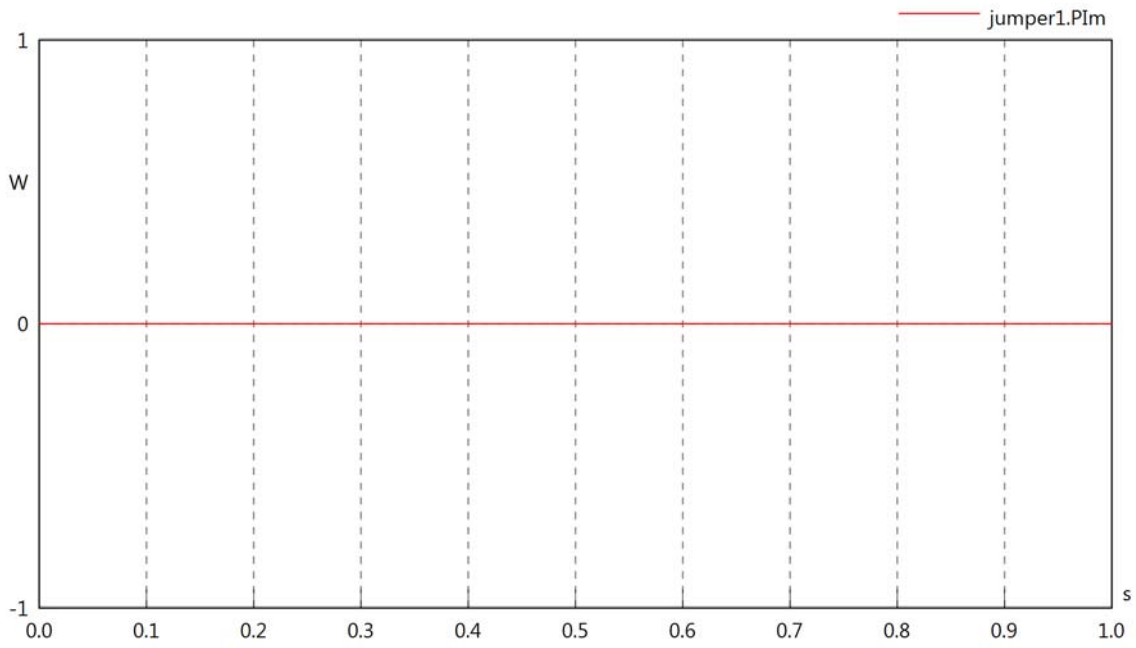

jumper1.S

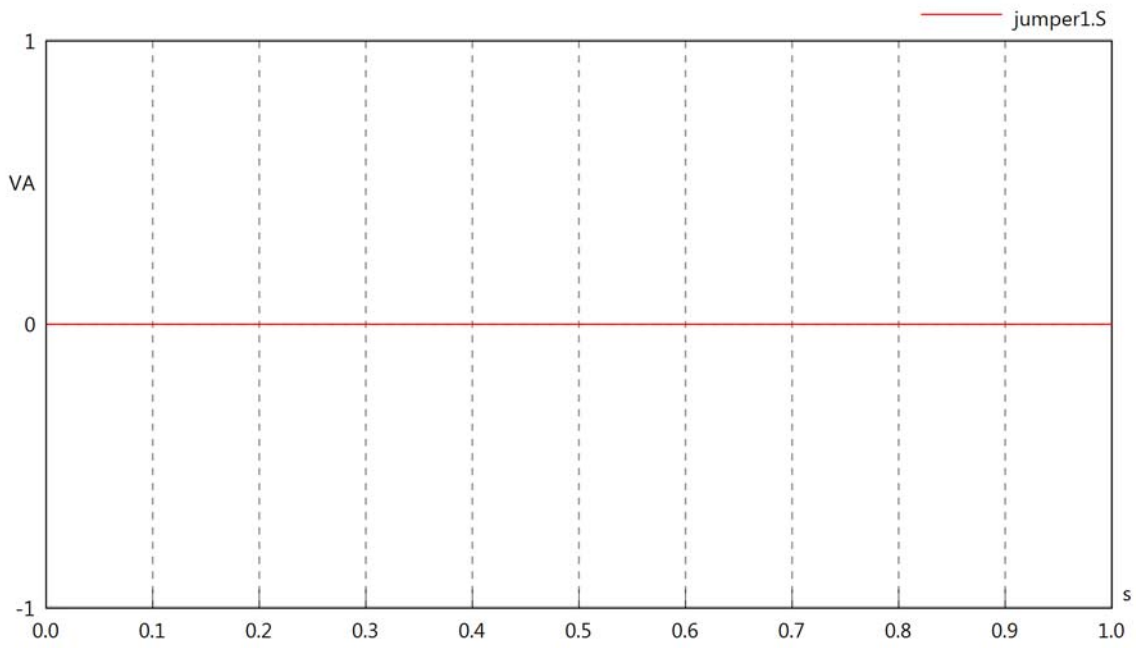

jumper1.dB

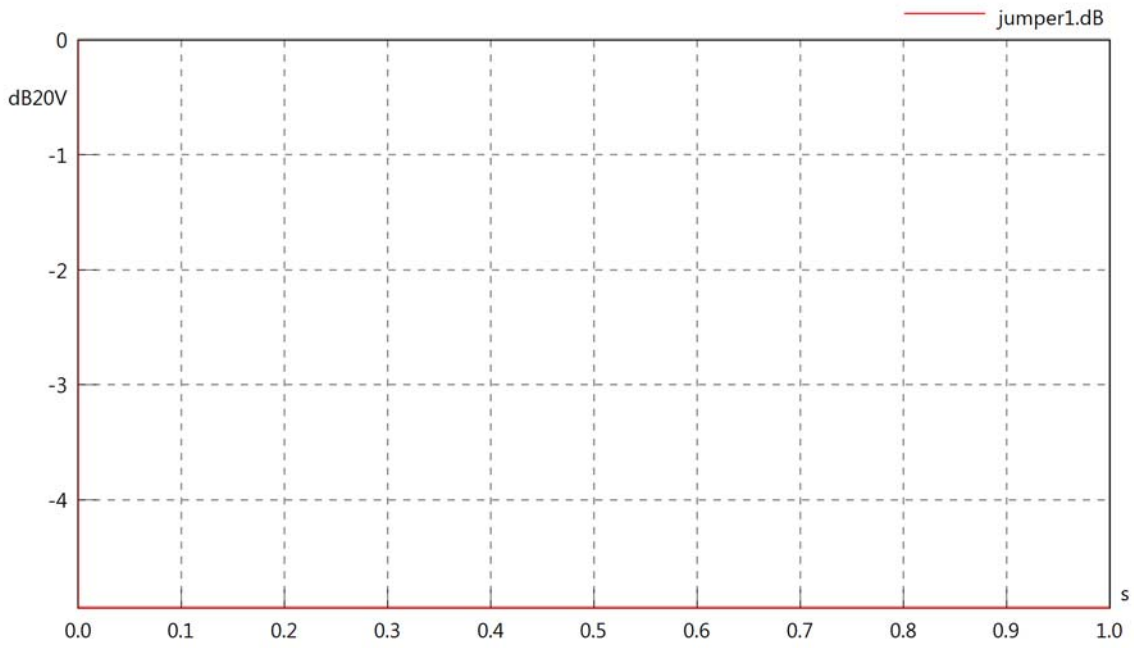
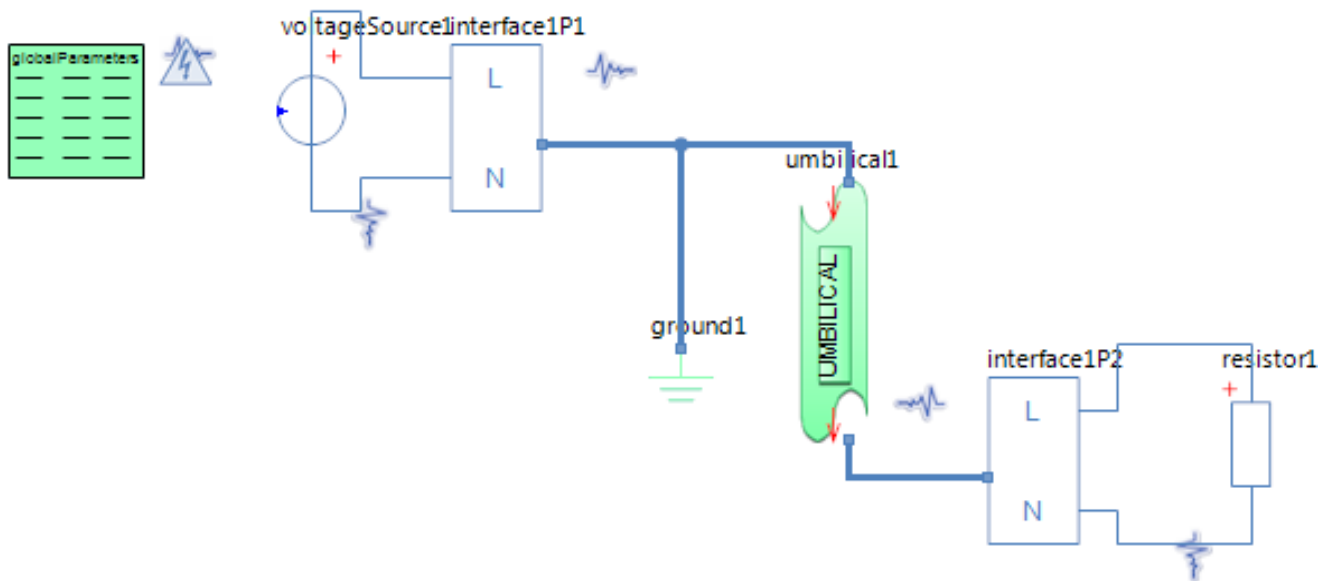

Diagram View



GlobalParameters globalParameters
Parameters

Comment	Name	Current Value	Unit
Type of Calculation	eCalculationKind	Signal Calculation	
Description of Frequency	eFrequencyKind	Linear	
Minimum Frequency	fMin	60	[Hz]
Maximum Frequency	fMax	60	[Hz]

Voltage Source voltageSource1
Parameters

Comment	Name	Current Value	Unit
Voltage RMS	VrmsSrc	$\min(230, 230000 * t)$	[V]
Phase	phi	0	[deg]

Resistor resistor1
Parameters

Comment	Name	Current Value	Unit
Resistance	R	100	[Ohm]

Umbilical umbilical1
Parameters

Comment	Name	Current Value	Unit
Resistance per length for each Line at 20 °C (68 °F)	r	1	[Ohm/km]
Inductance per length for each Line	l	0.5	[mH/km]
Conductance per length between Lines	g	1e-10	[1/(Ohm·m)]
Capacitance per length between Lines	c	0.1	[µF/km]
Length of Umbilical for each Line	length	10	[km]
Temperature of the conductor	temp	5	[°C]
Skin effect	skinEff	Round, stranded or solid copper conductor	
Conductor area	area	6	[mm²]

umbilical1.rTemp

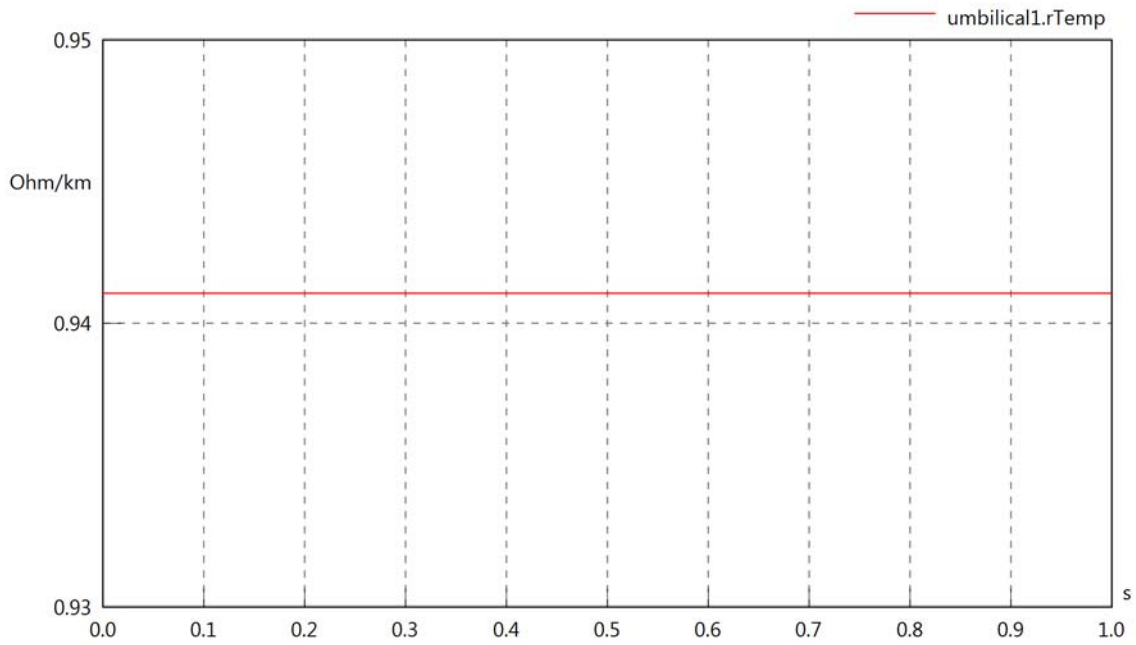

umbilical1.skinDepth

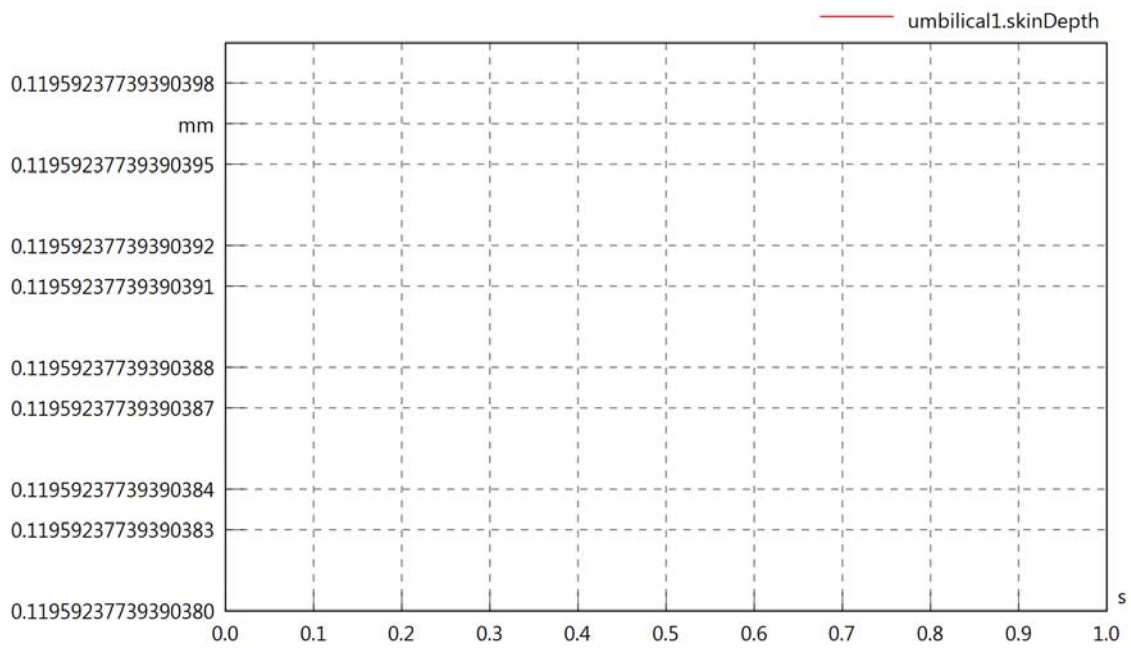

umbilical1.diameter

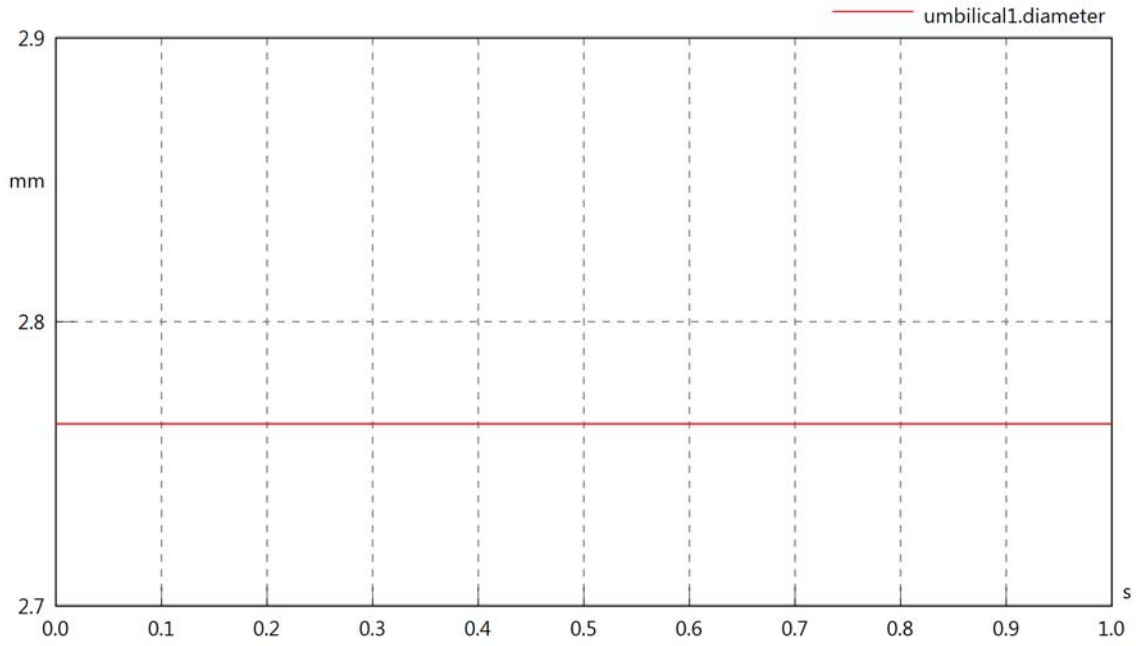

umbilical1.resistivity

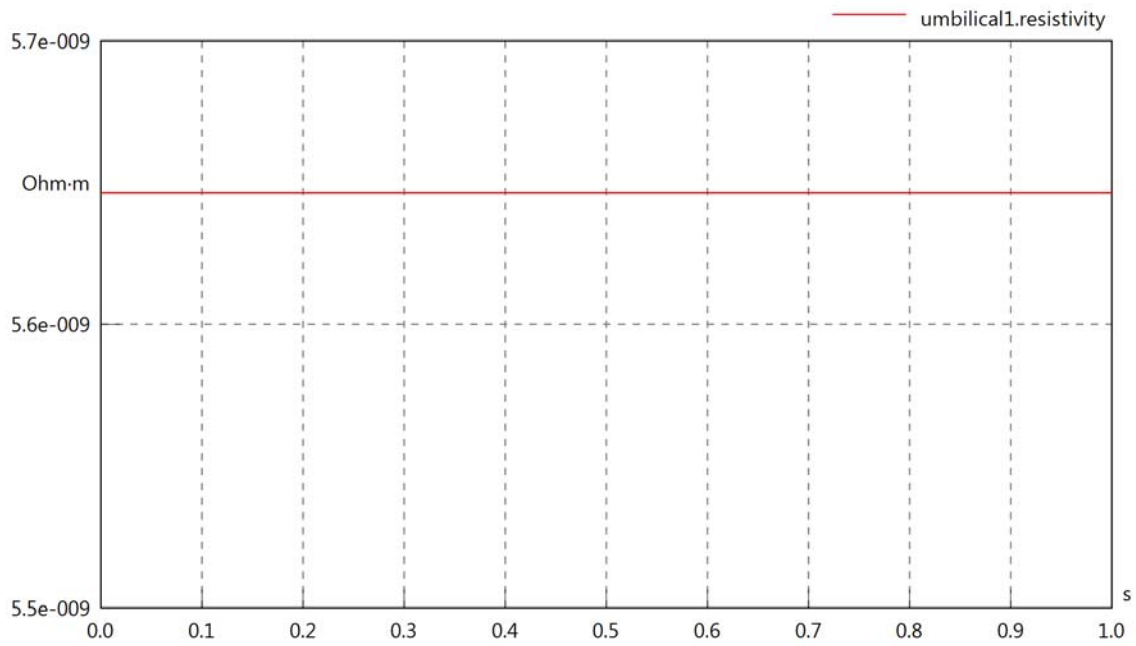

umbilical1.rInternal

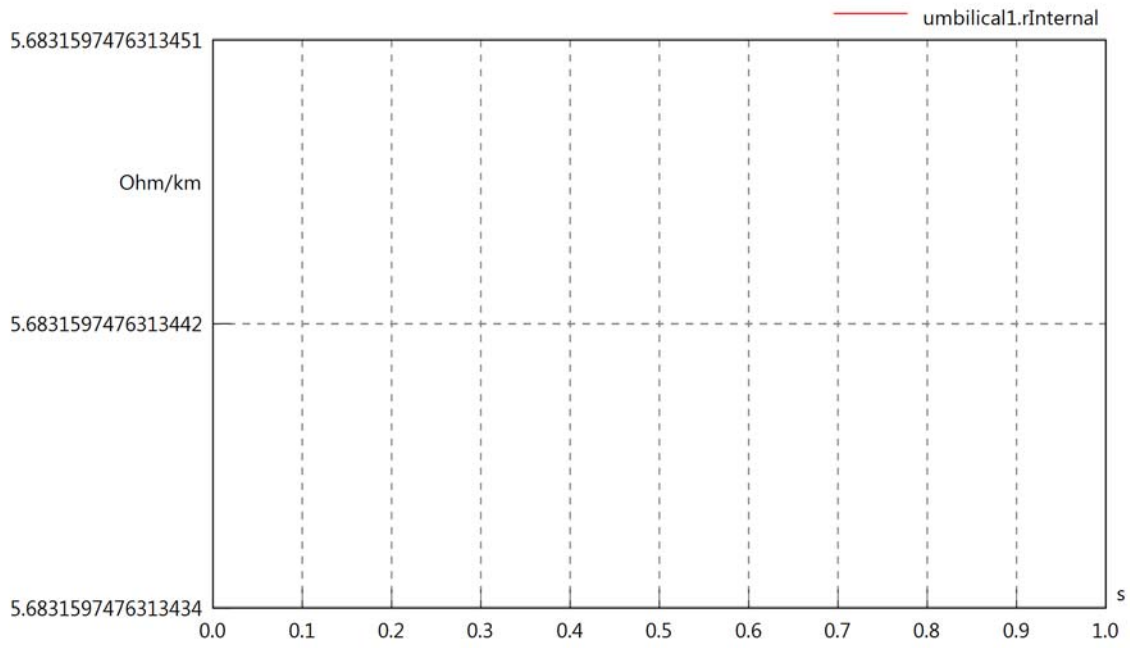

umbilical1.VrmsIn

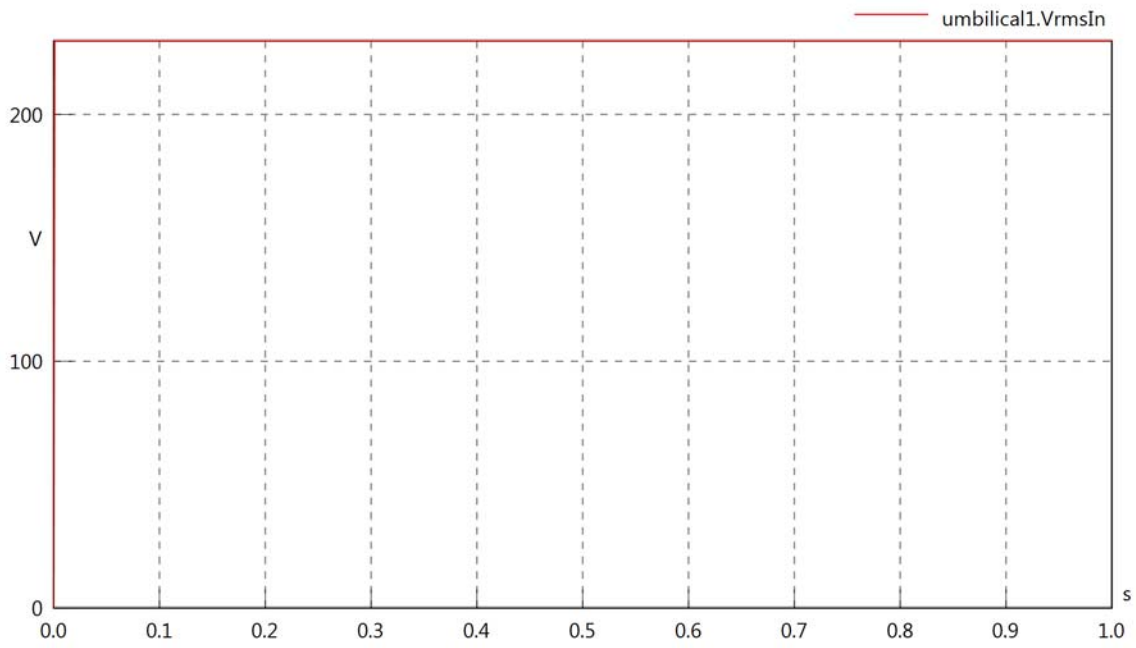

umbilical1.vReIn

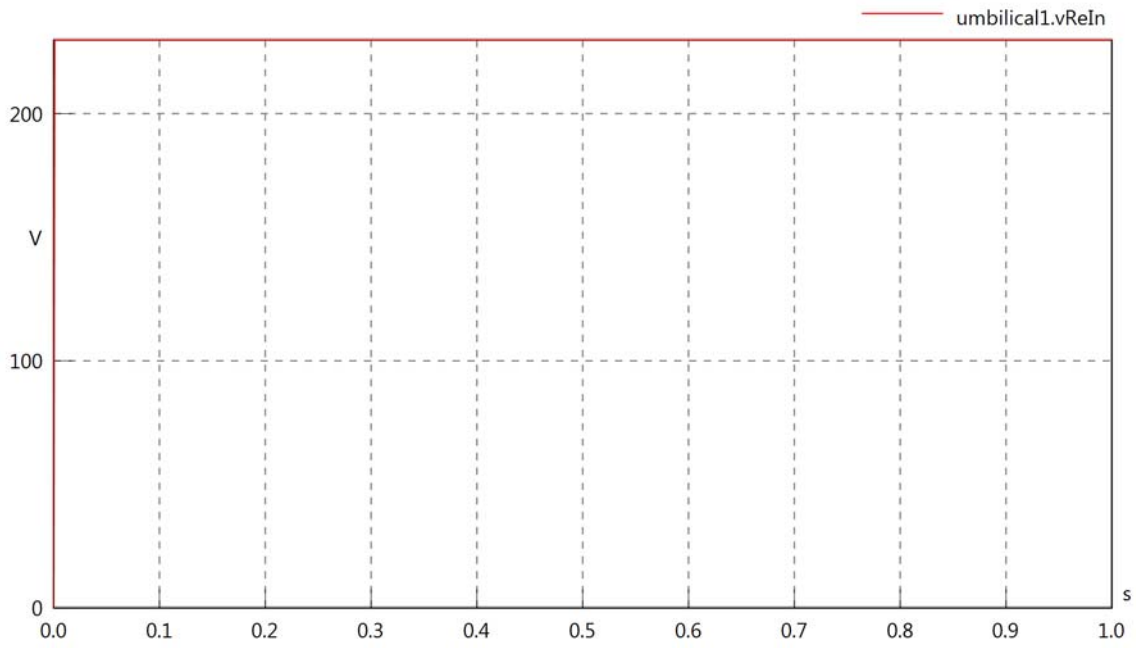

umbilical1.vImIn

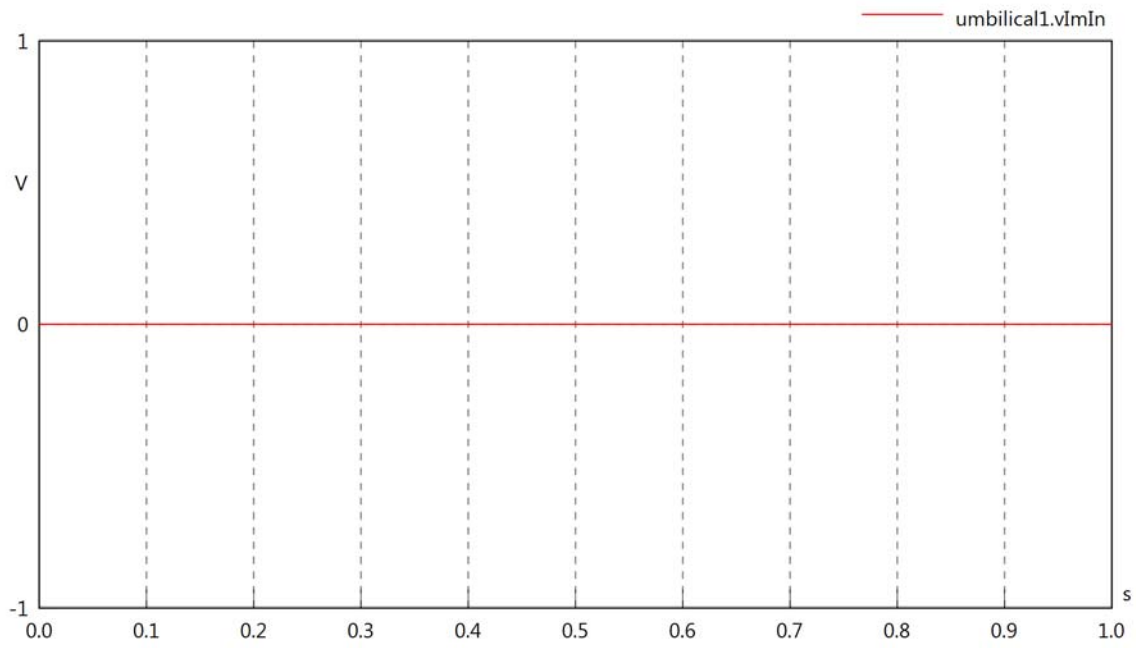

umbilical1.VrmsOut

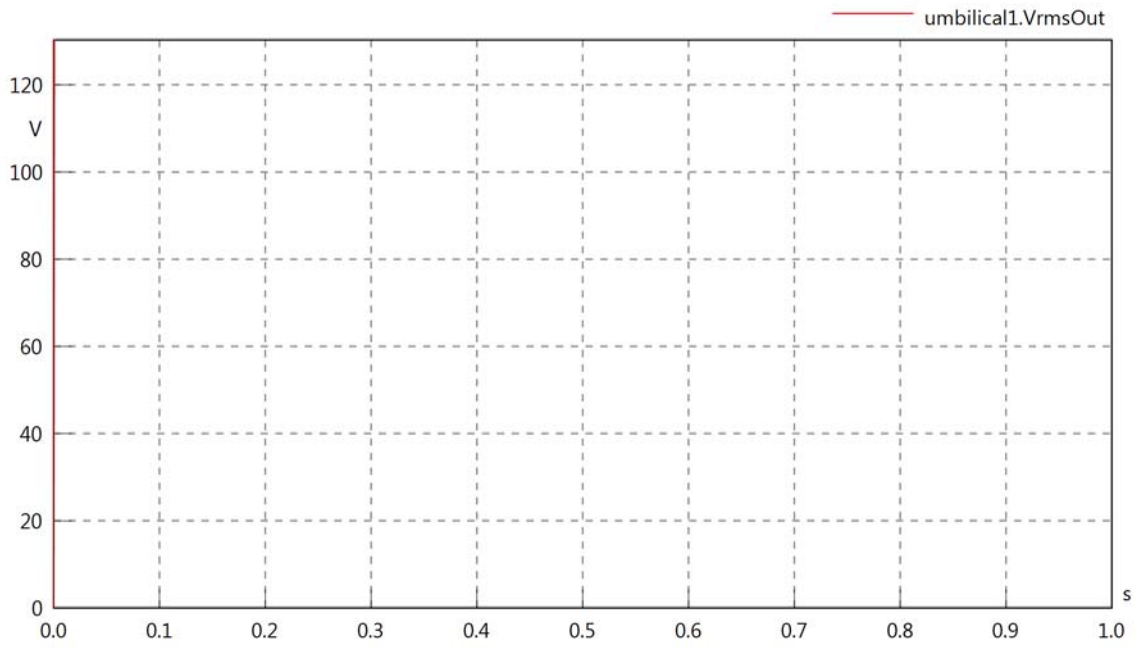

umbilical1.vReOut

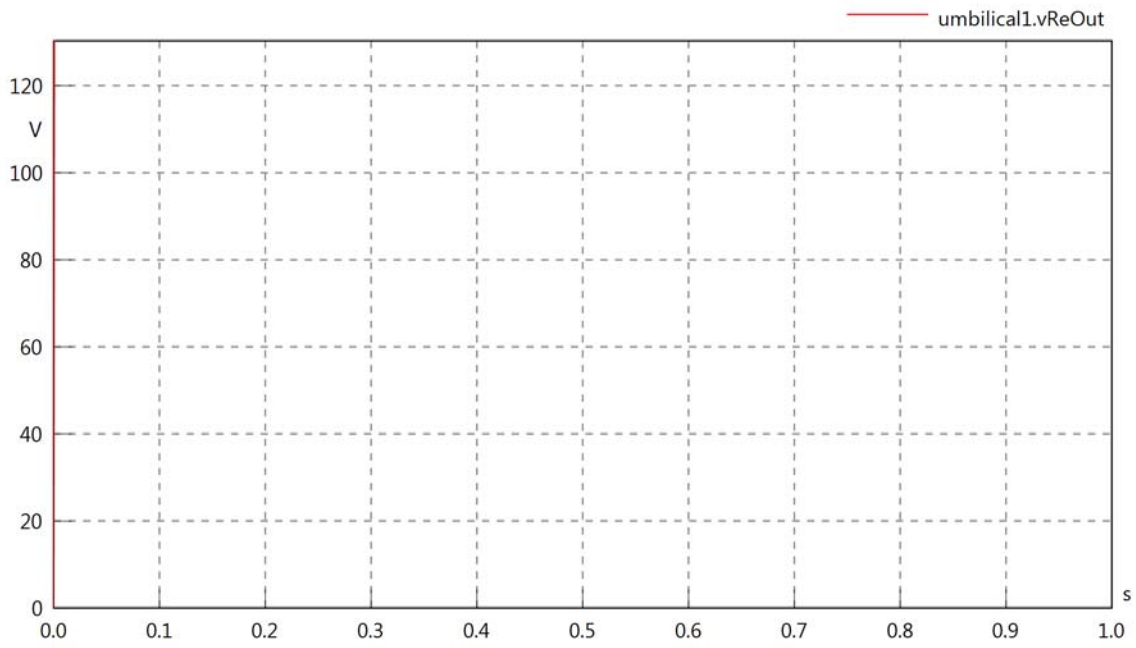

7/24
3.6.2.27707 x64
SimulationX

umbilical1.vImOut



Supporting your visions

umbilical1.Vrms

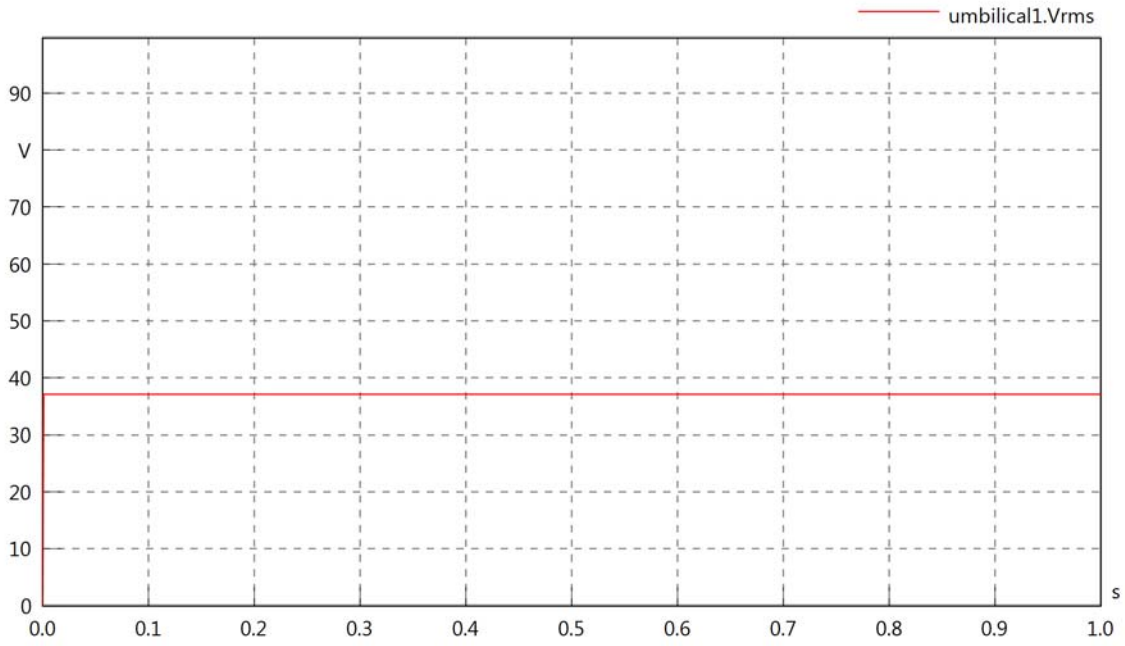

umbilical1.vRe

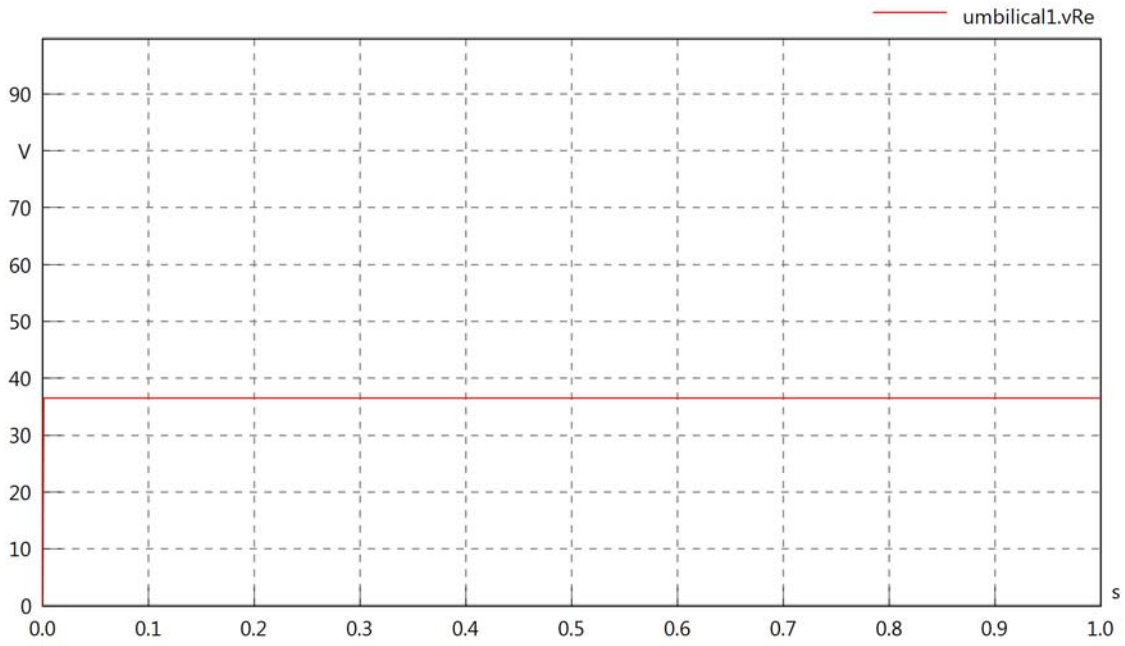

umbilical1.vIm

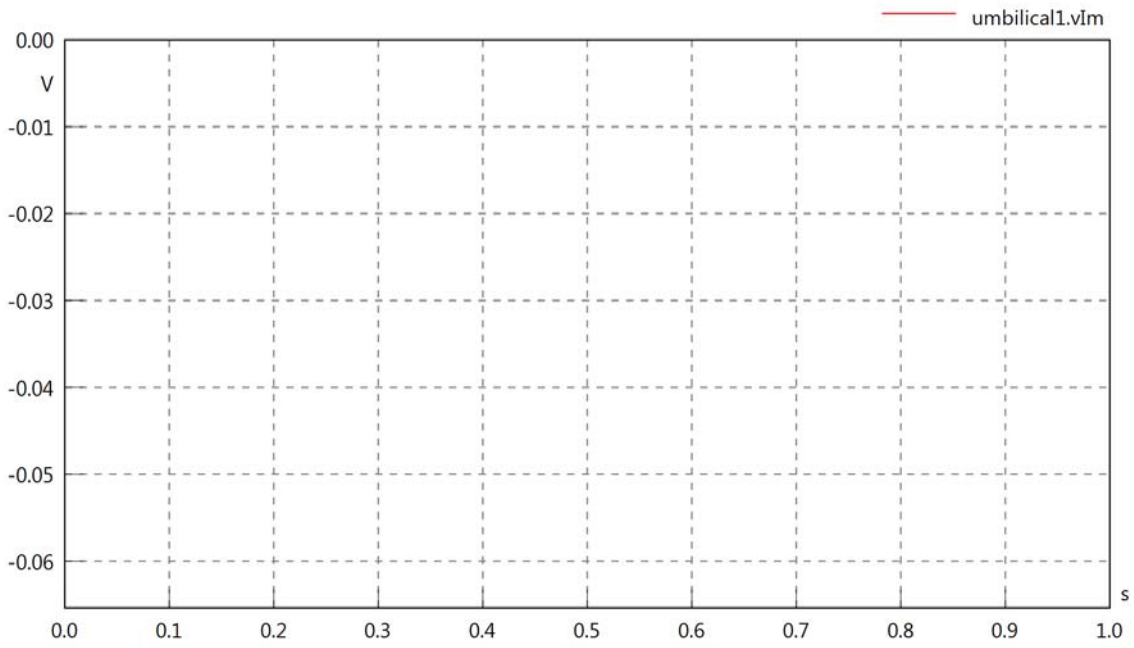

umbilical1.IrmsIn

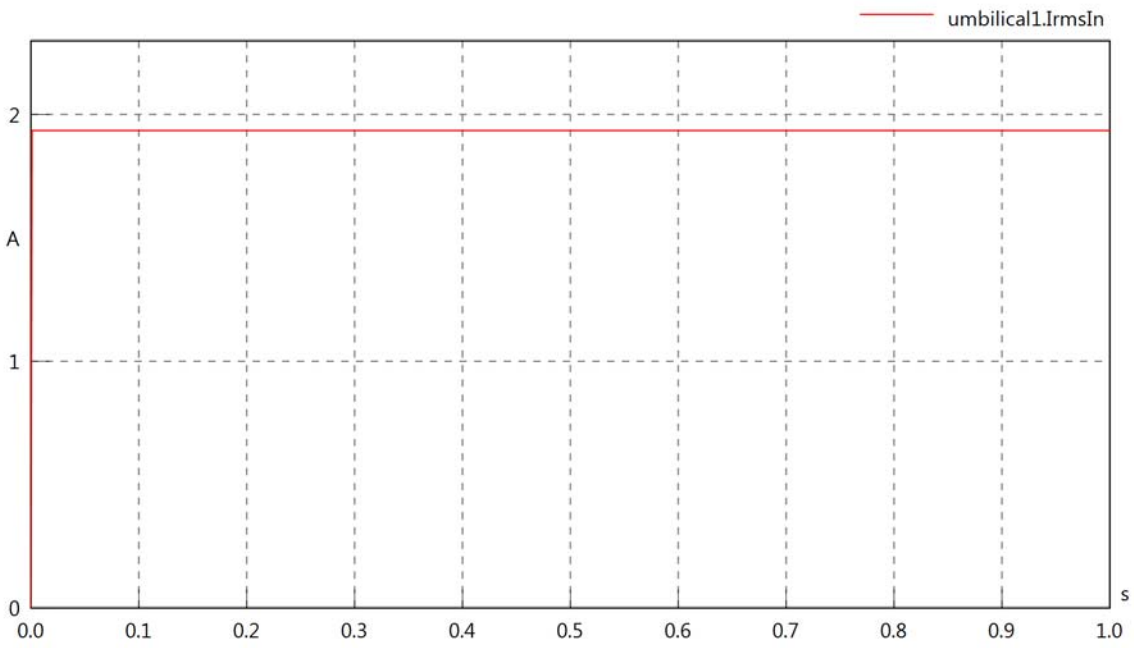

umbilical1.iReIn

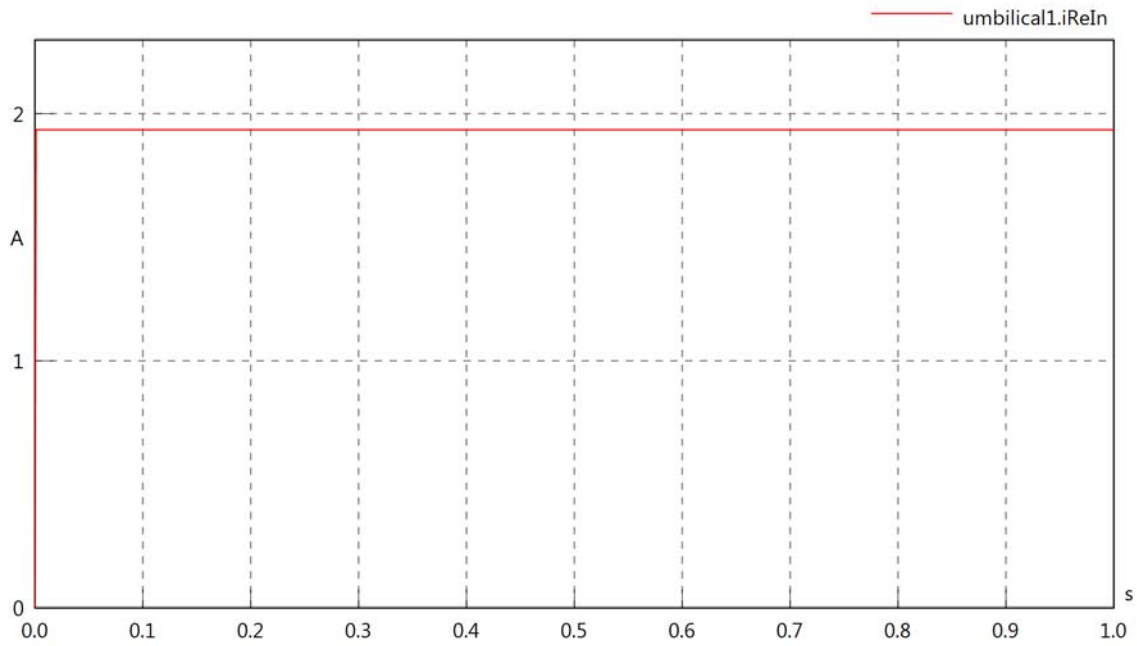

umbilical1.iImIn

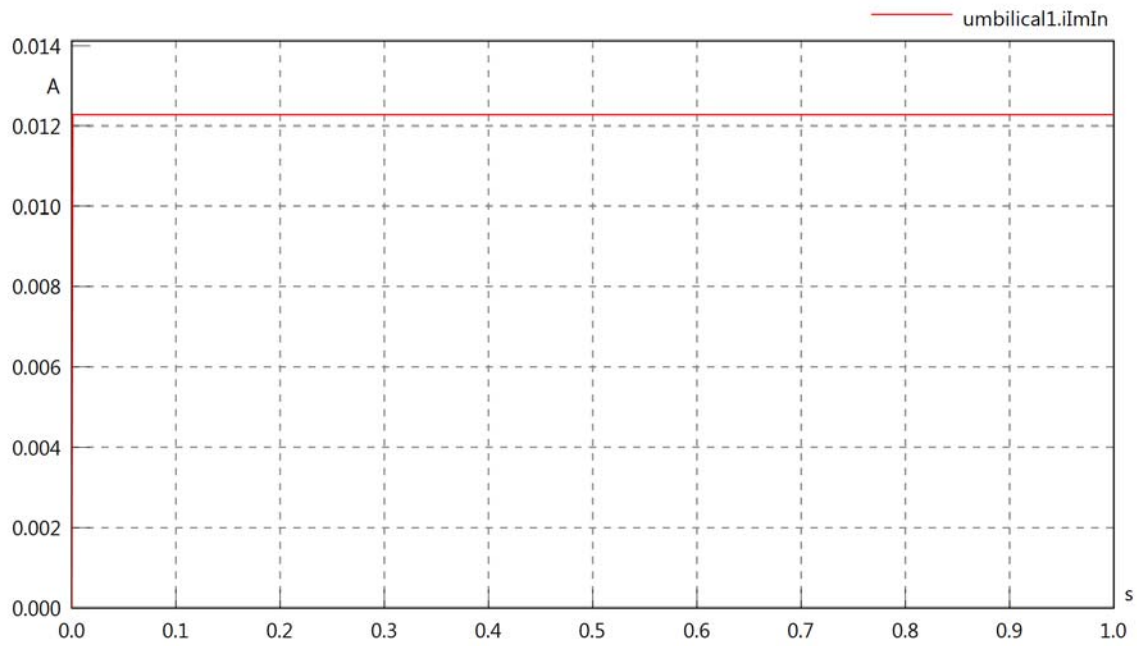

umbilical1.IrmsOut

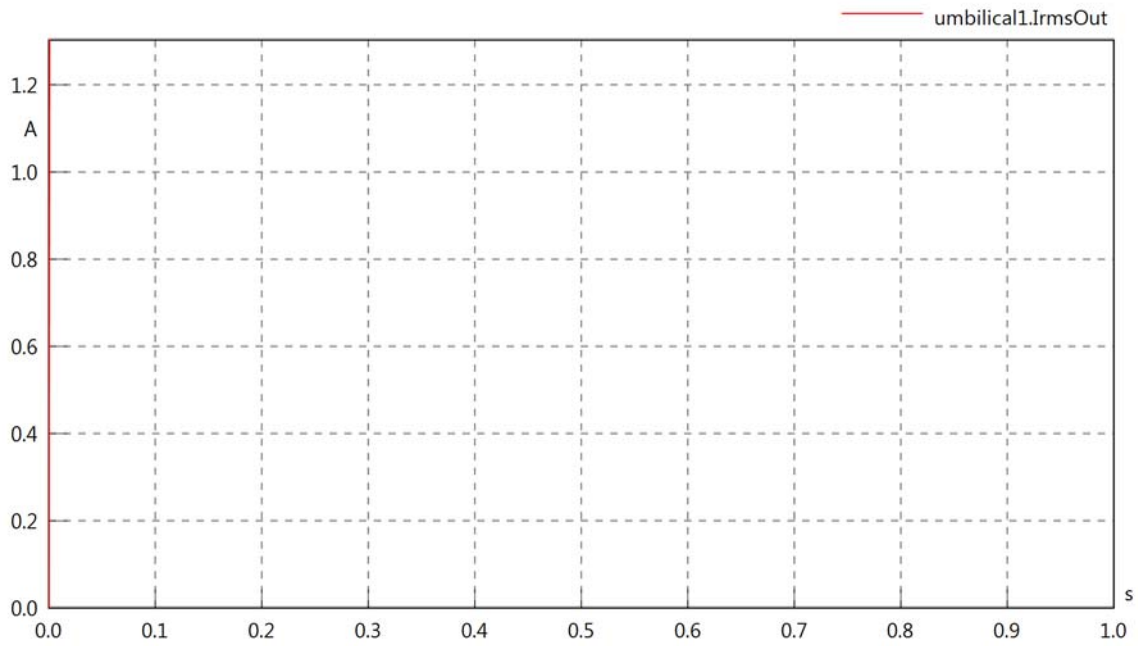

umbilical1.iReOut

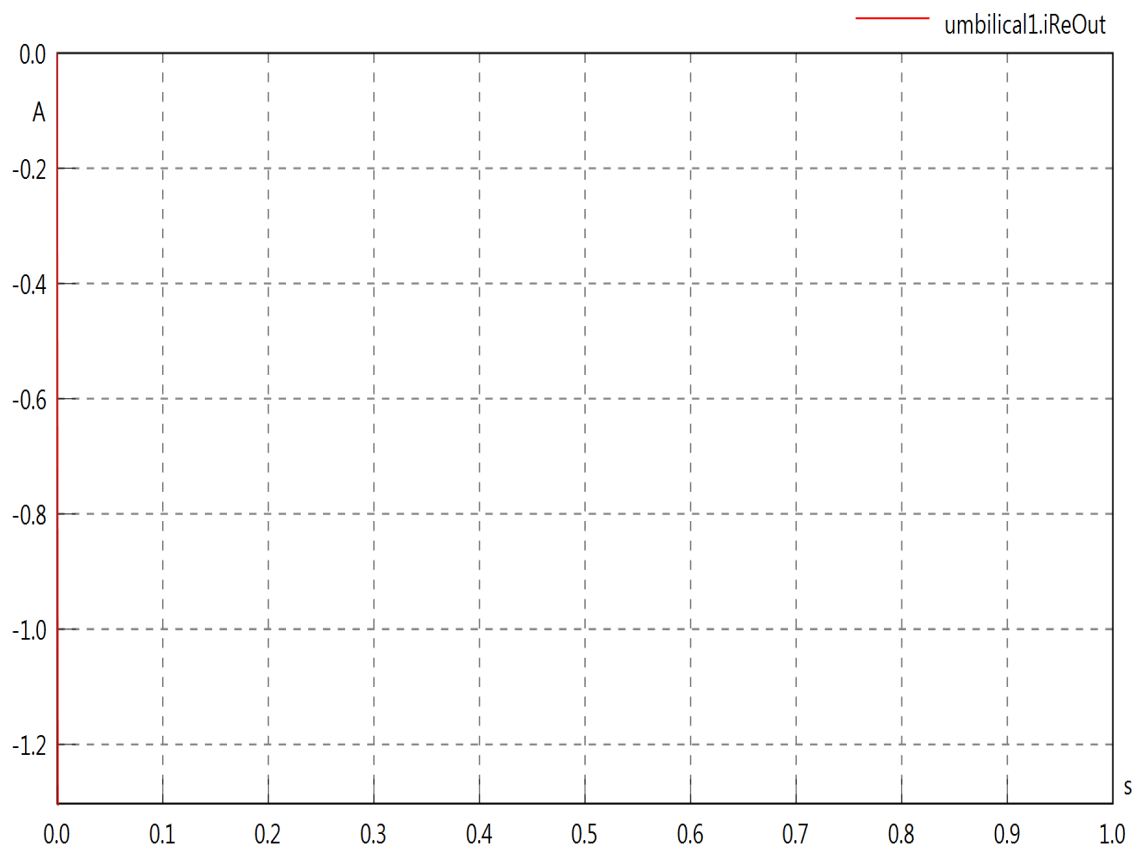

umbilical1.iImOut

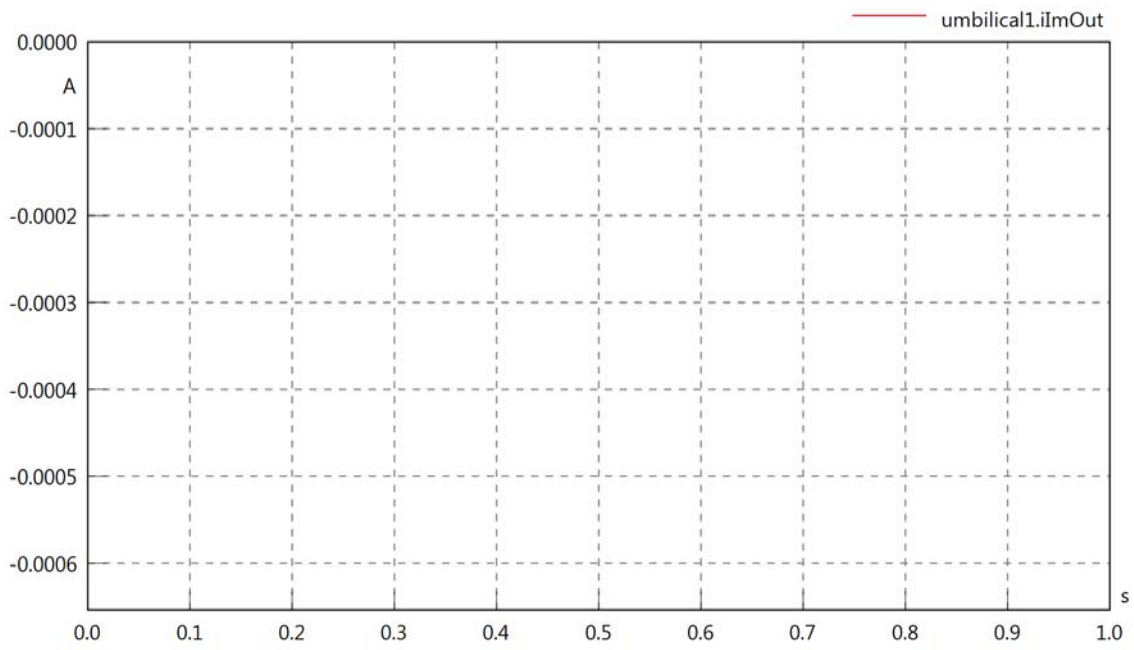

umbilical1.phiVIn

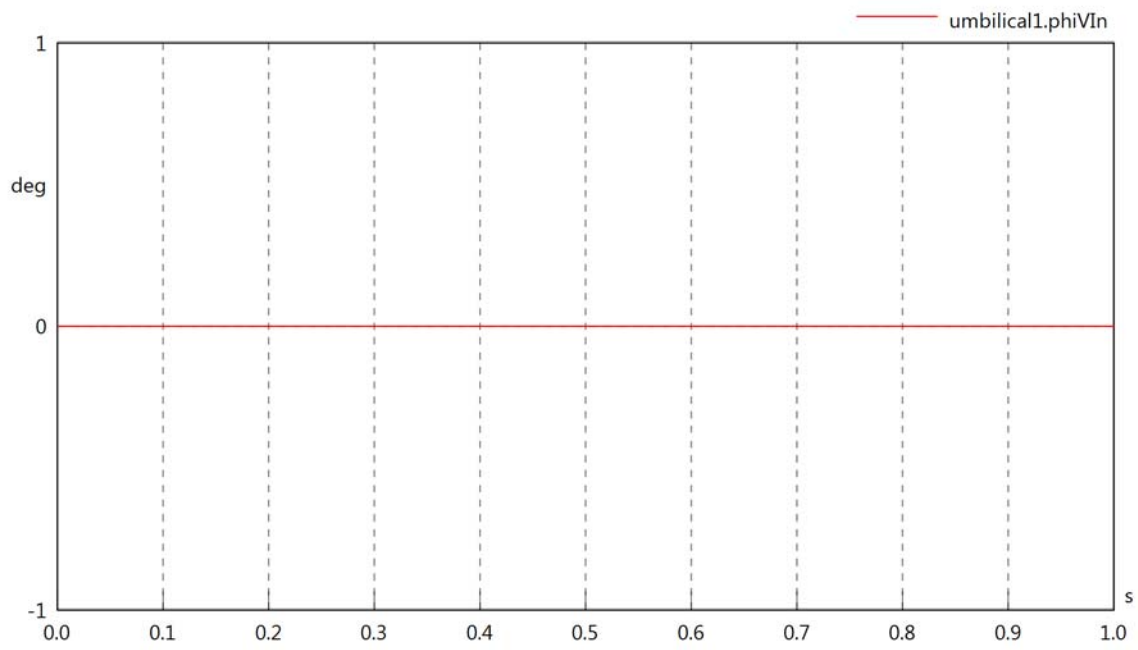

umbilical1.phiIn

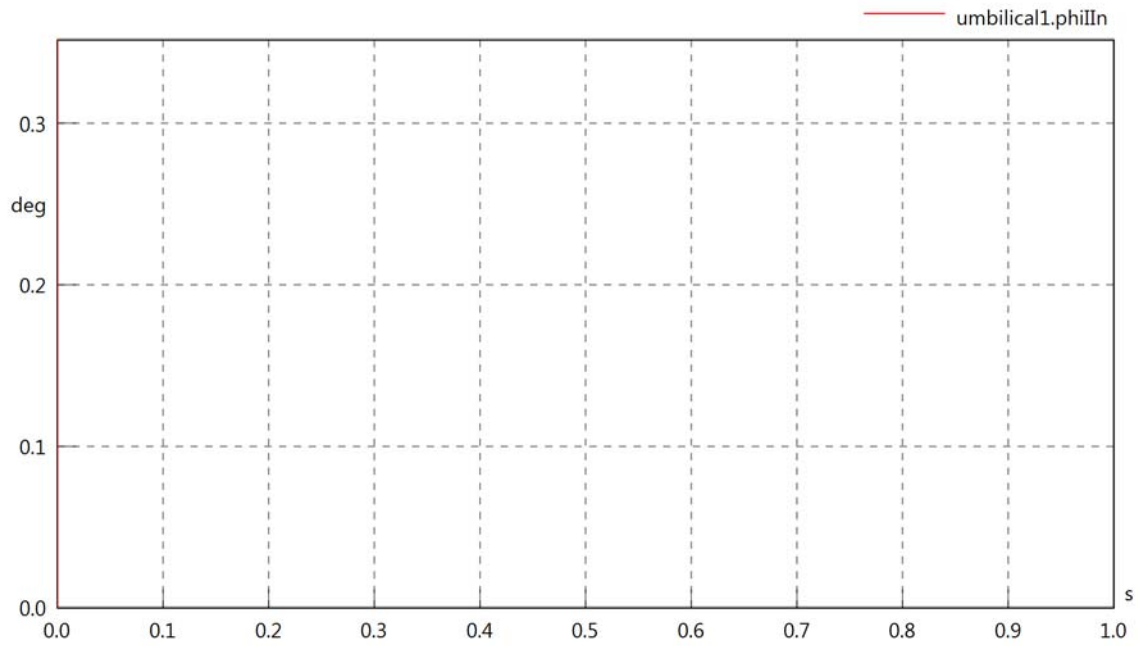

umbilical1.phiIVIn

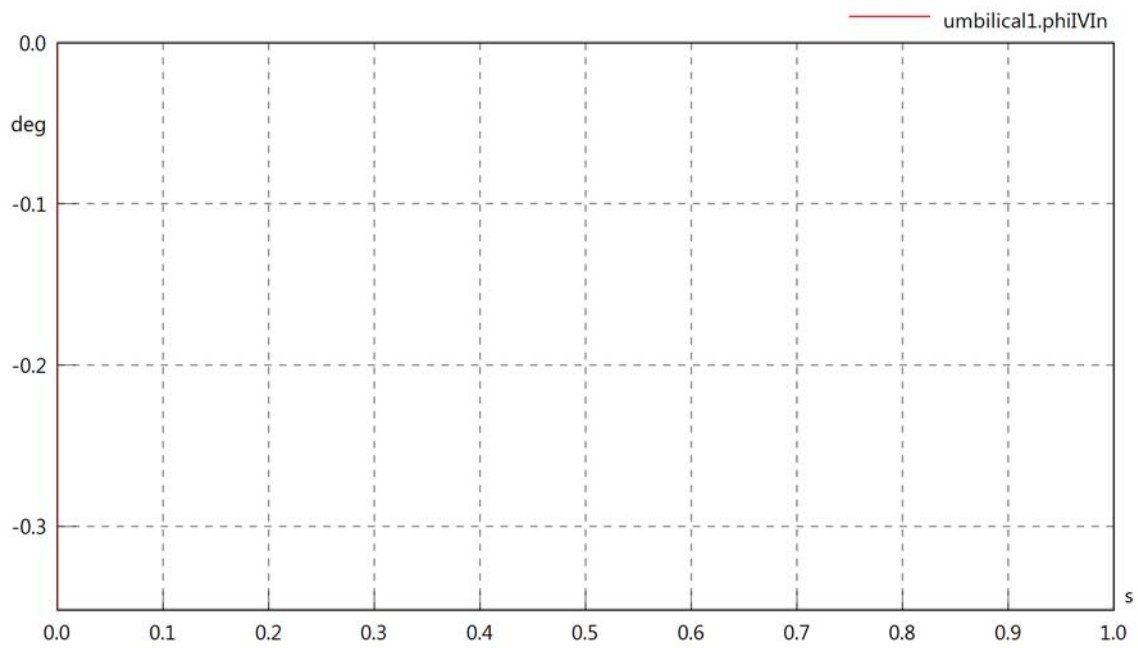



umbilical1.phiVOut

umbilical1.phiIOut

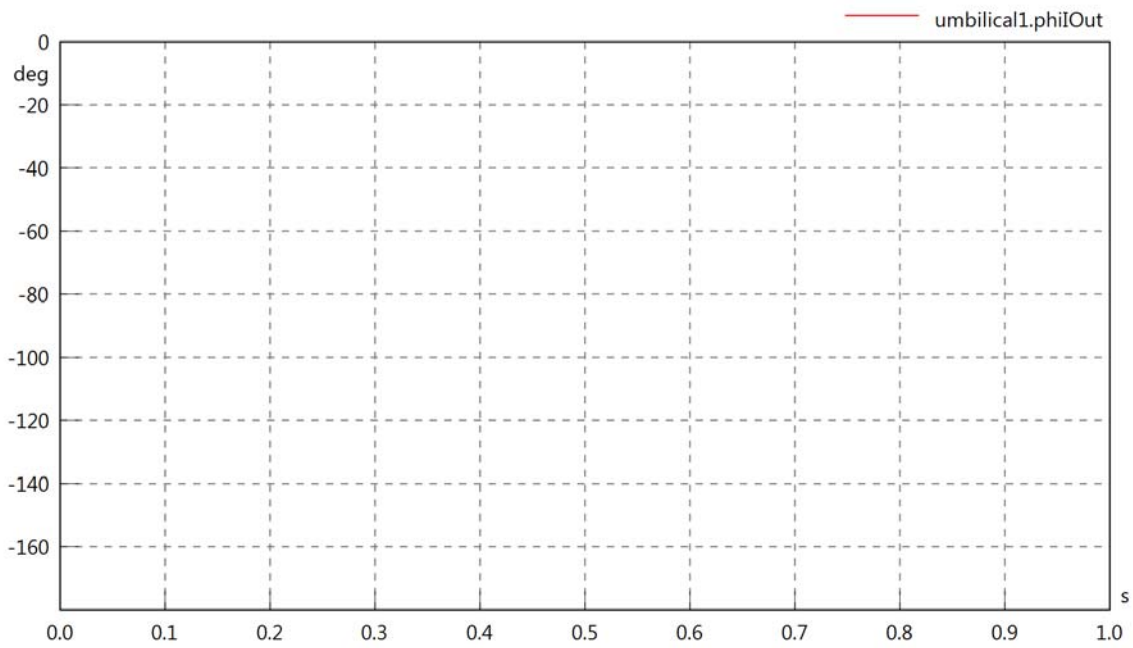

umbilical1.phiIVOut

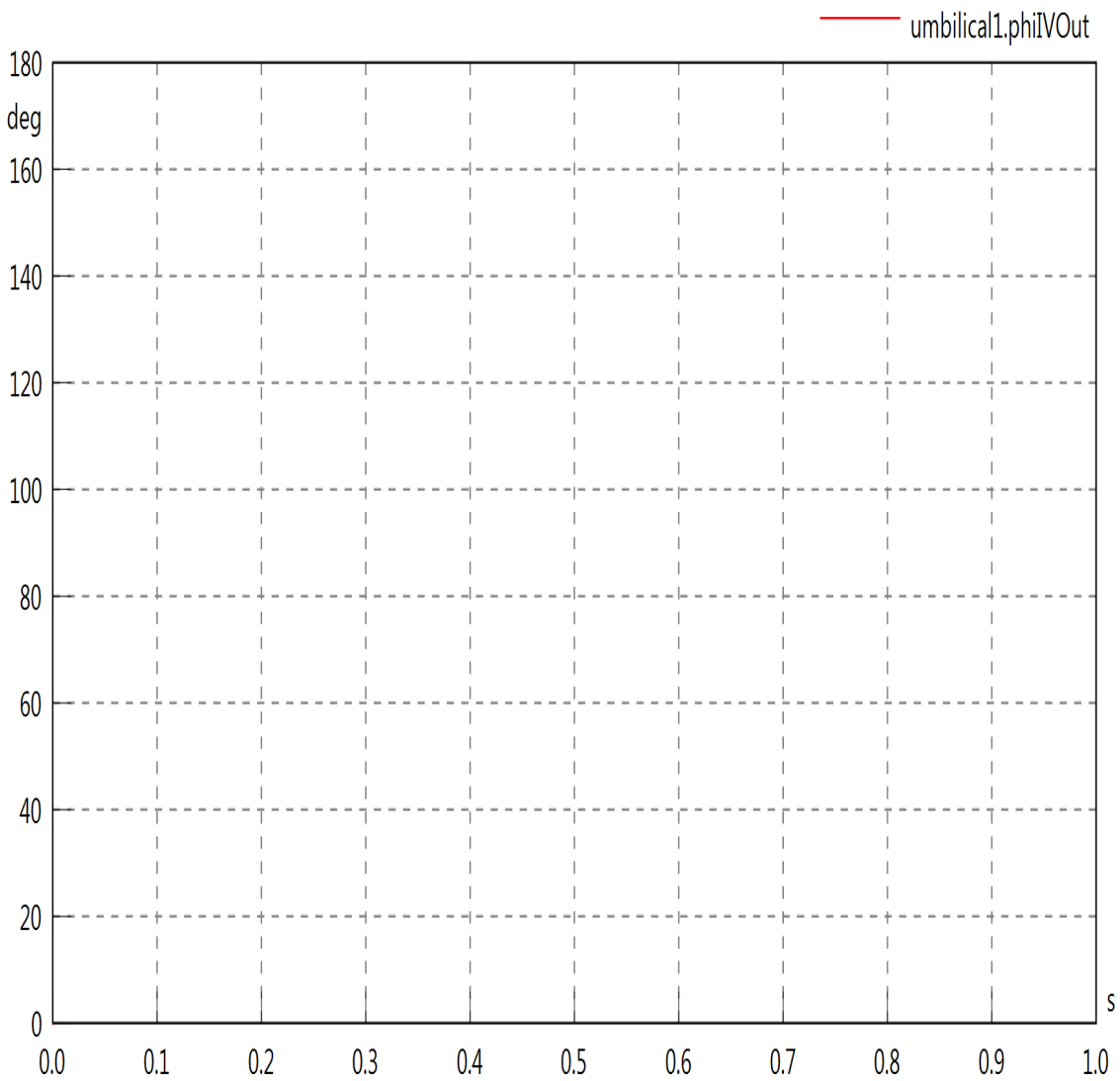

umbilical1.phiVL1

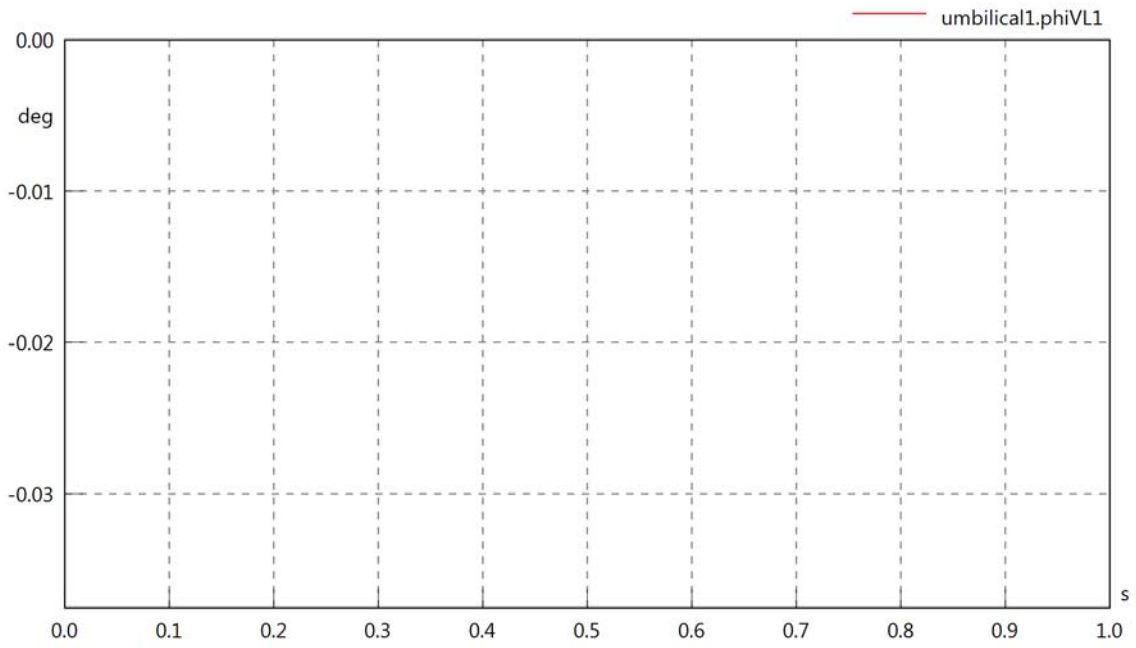

umbilical1.philL1

— umbilical1.philL1

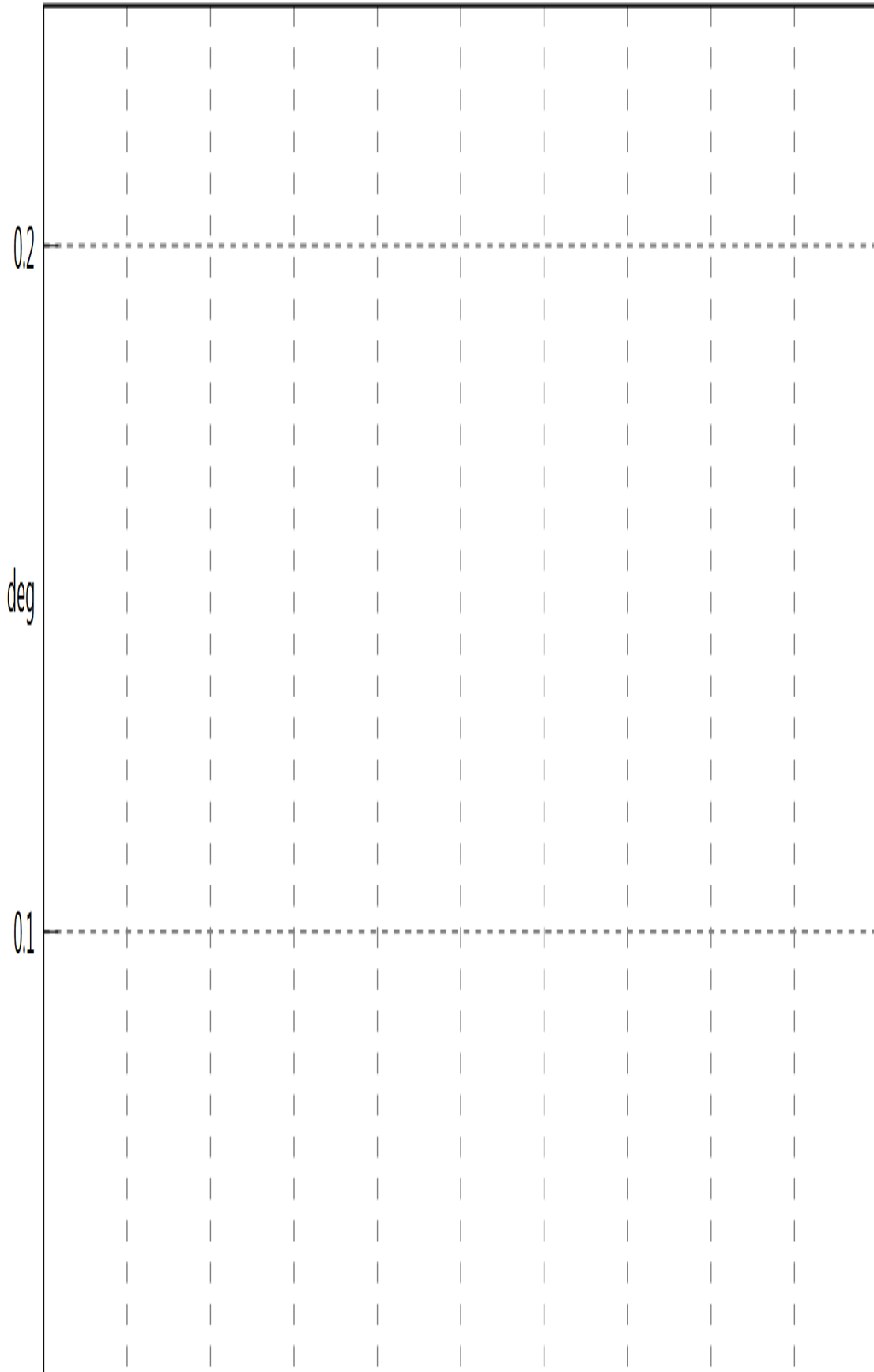

umbilical1.phiIVL1

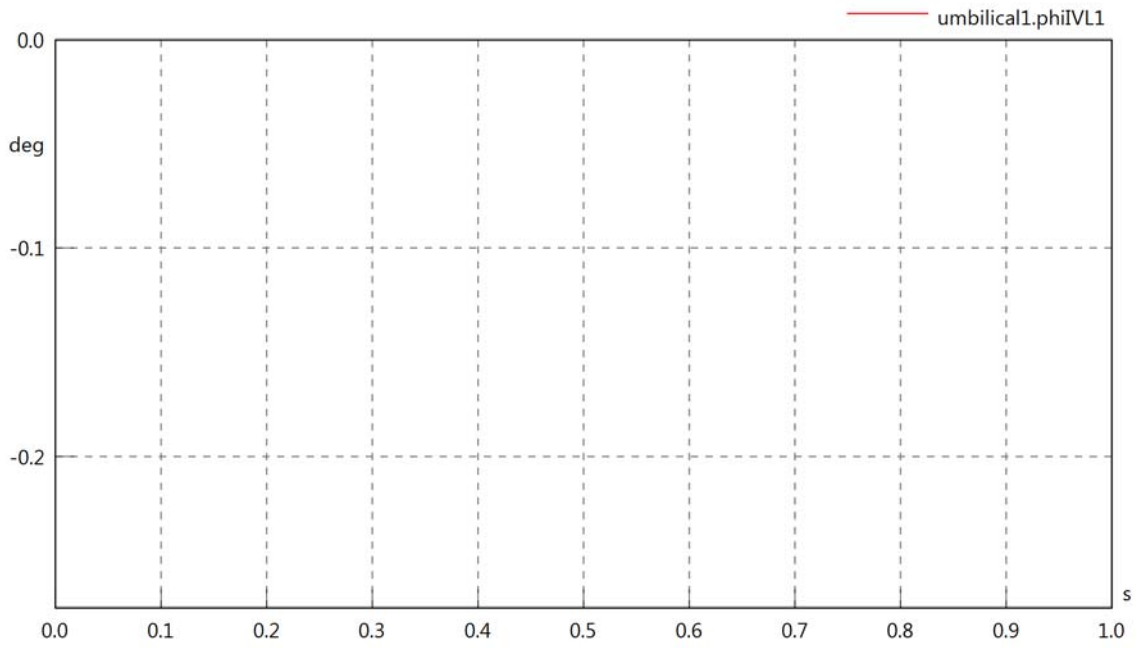

umbilical1.PReIn

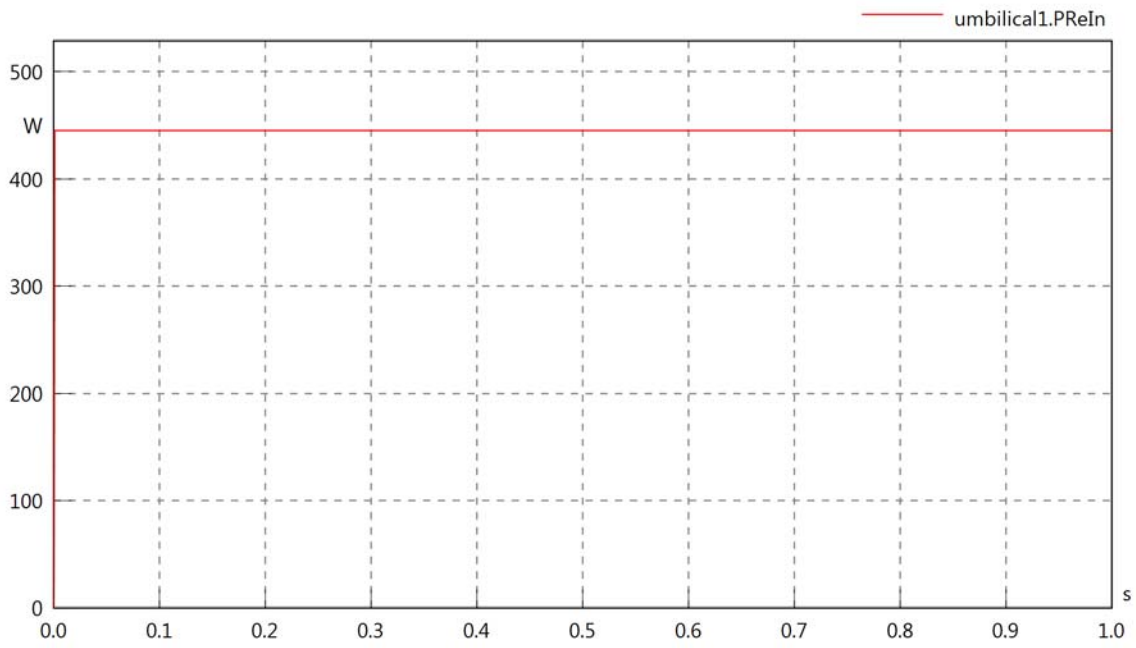

umbilical1.PImIn

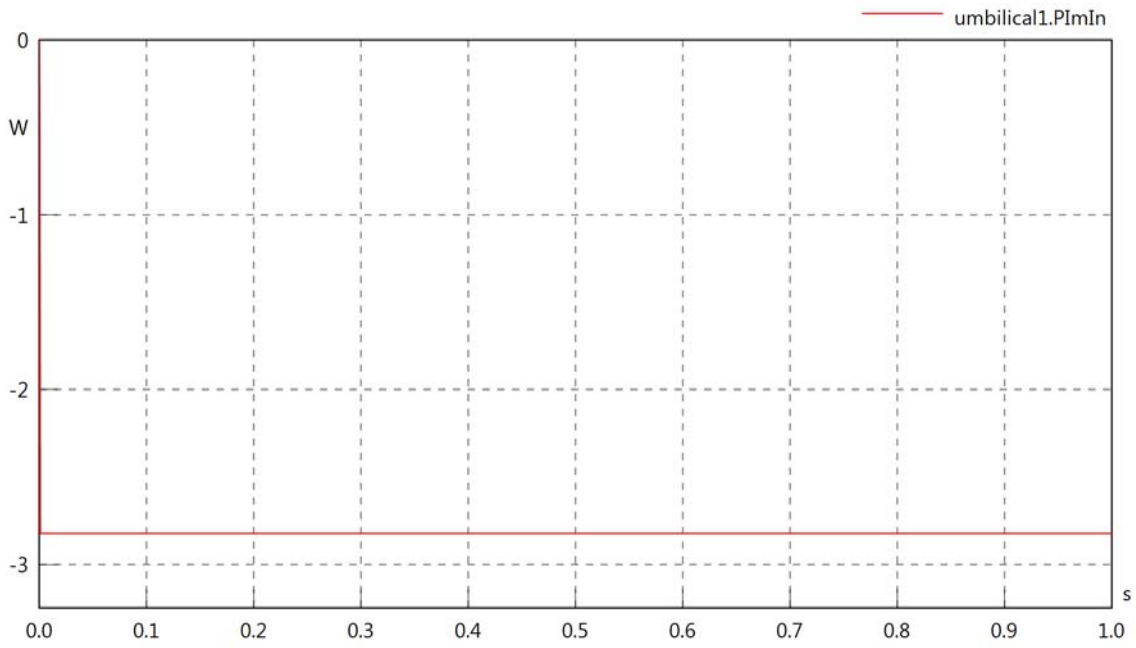

umbilical1.SIn

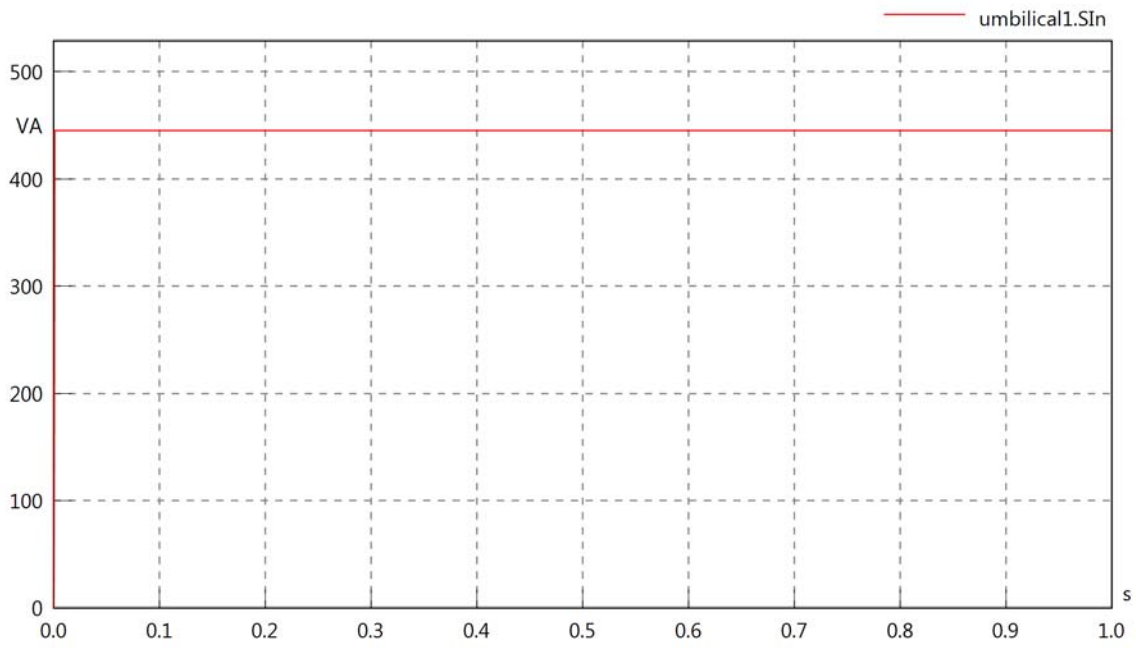

umbilical1.PReOut

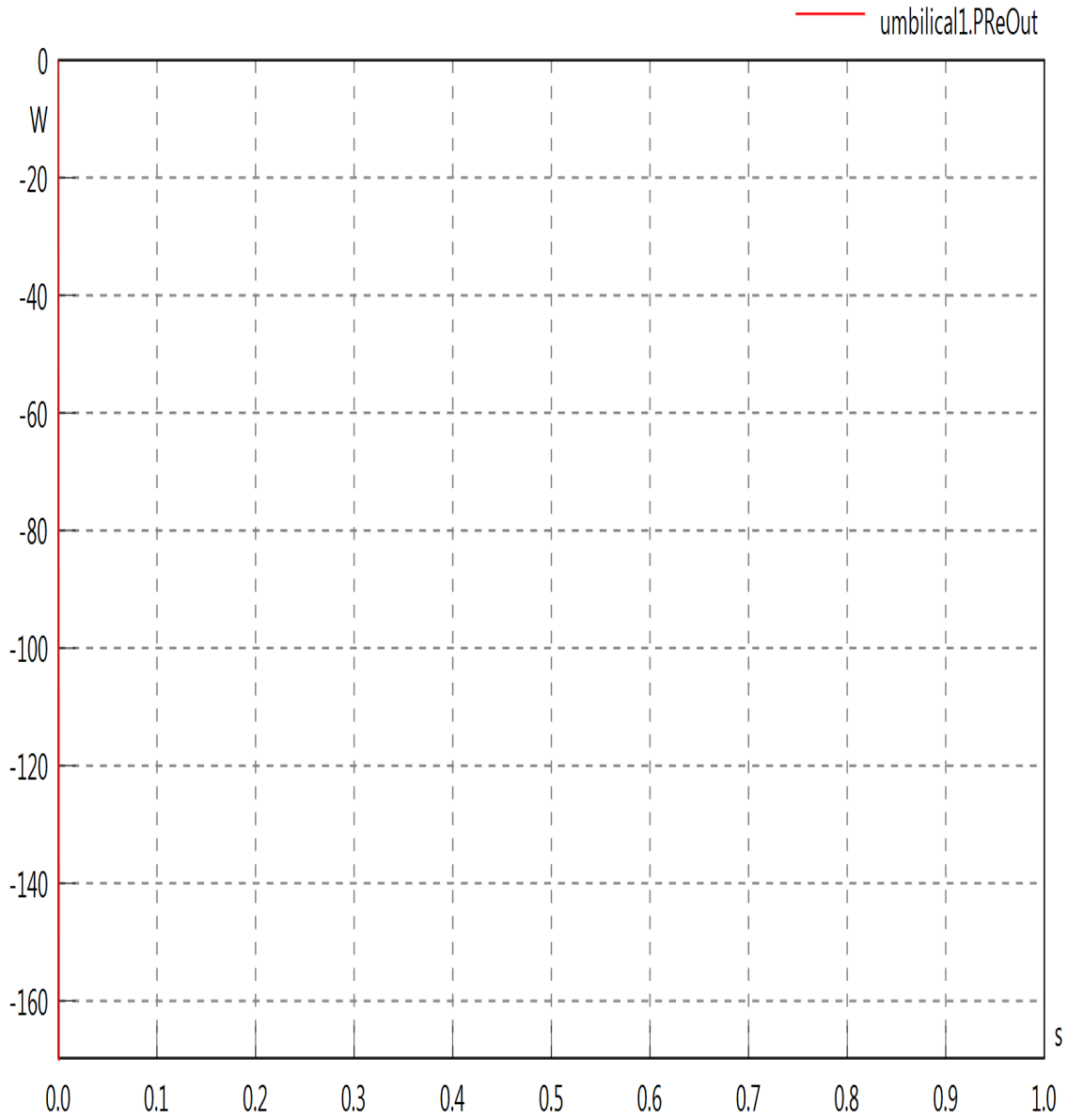

umbilical1.PIImOut

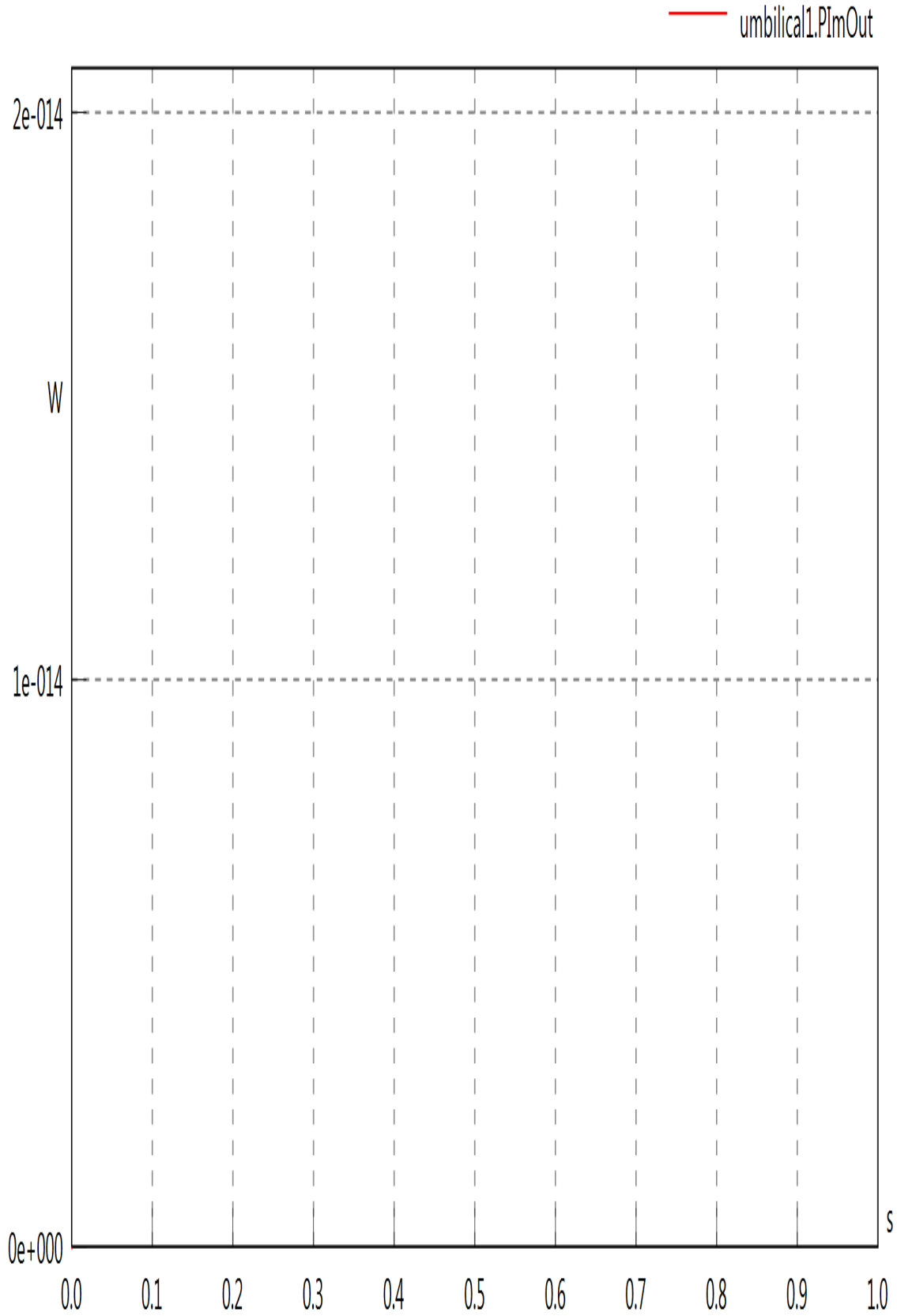

umbilical1.SOut

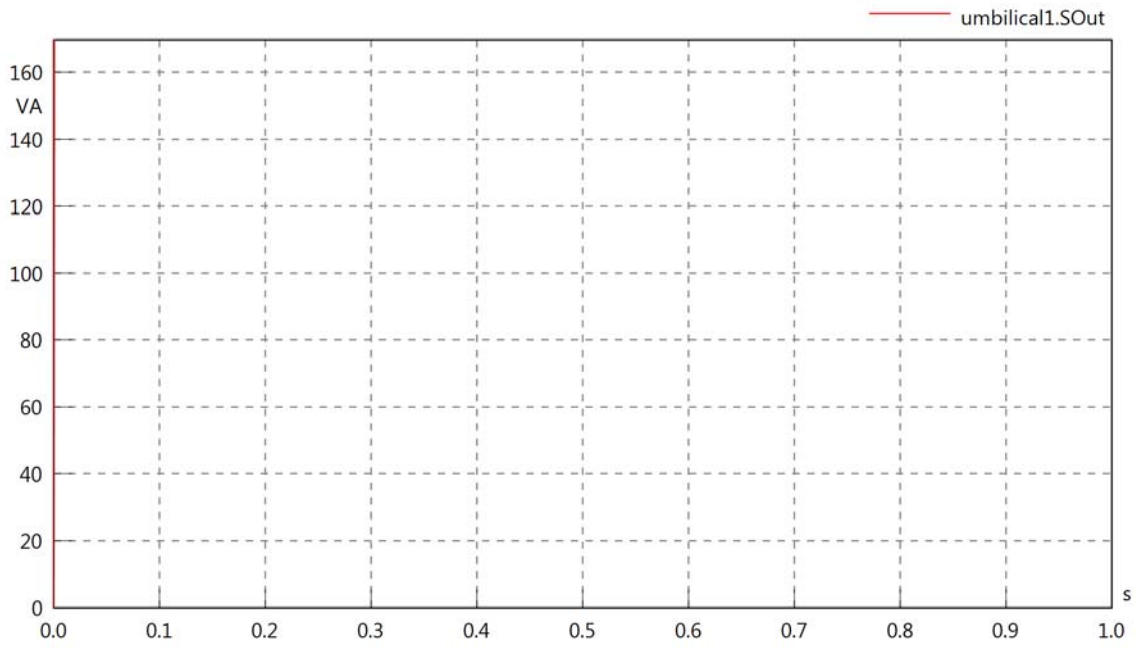

umbilical1.PRe

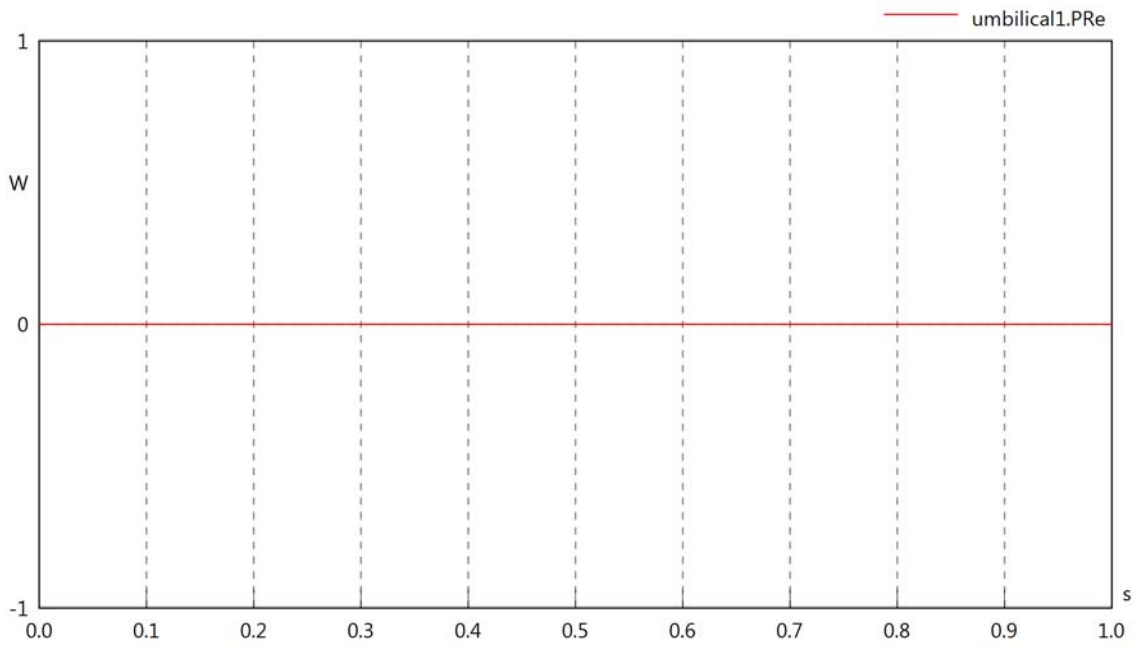

umbilical1.PIm

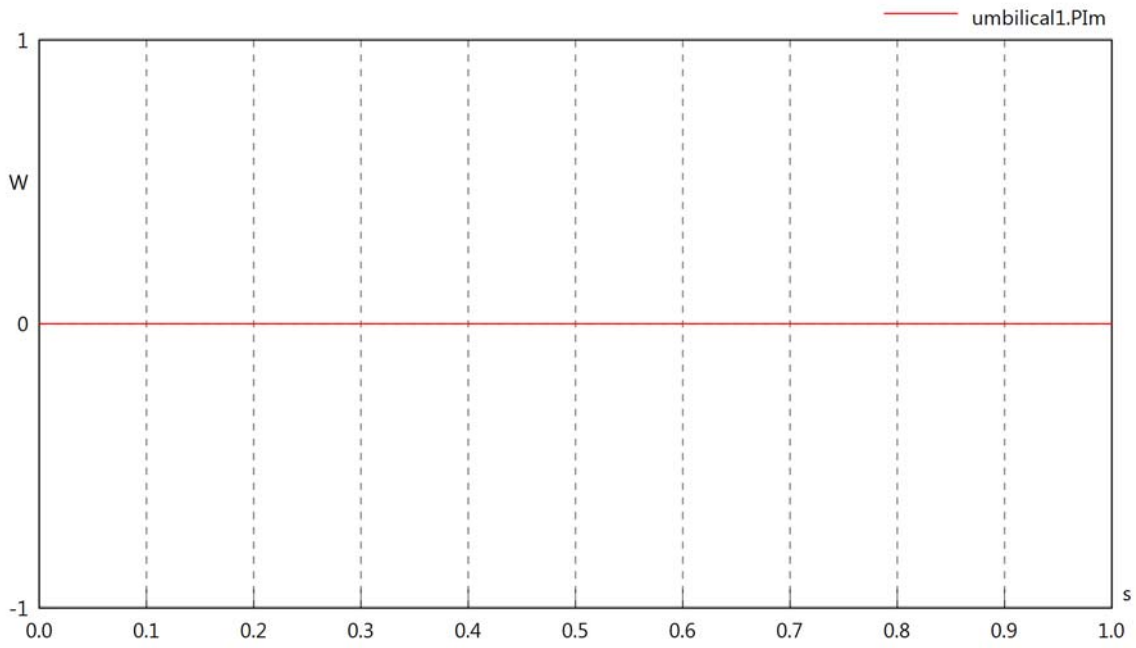

umbilical1.S

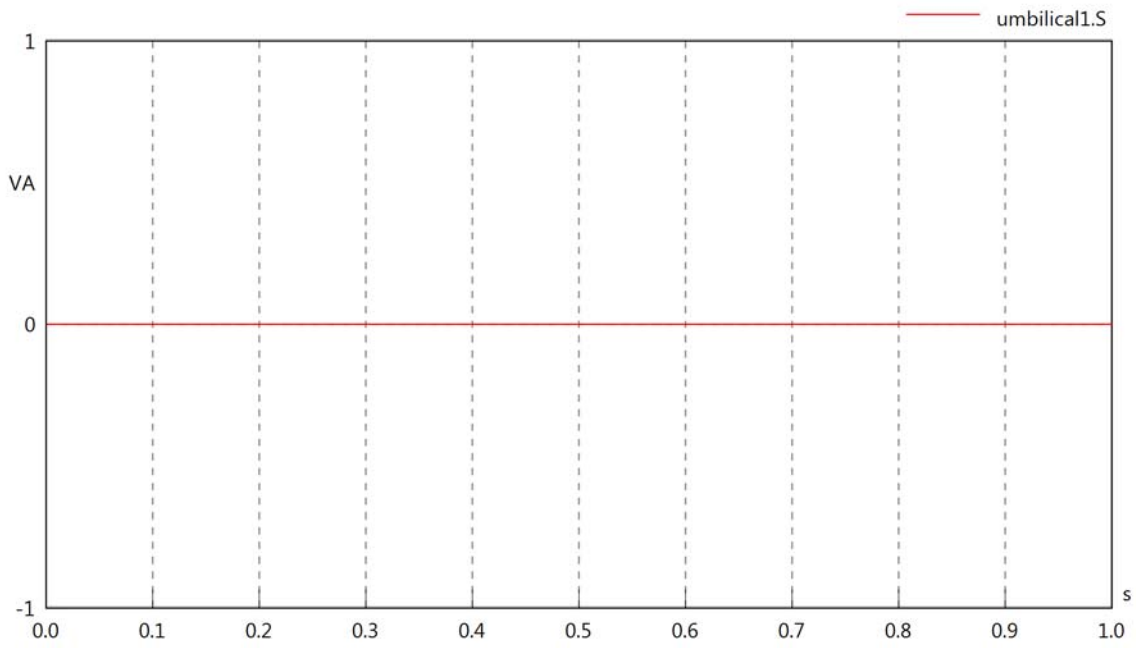

umbilical1.dB

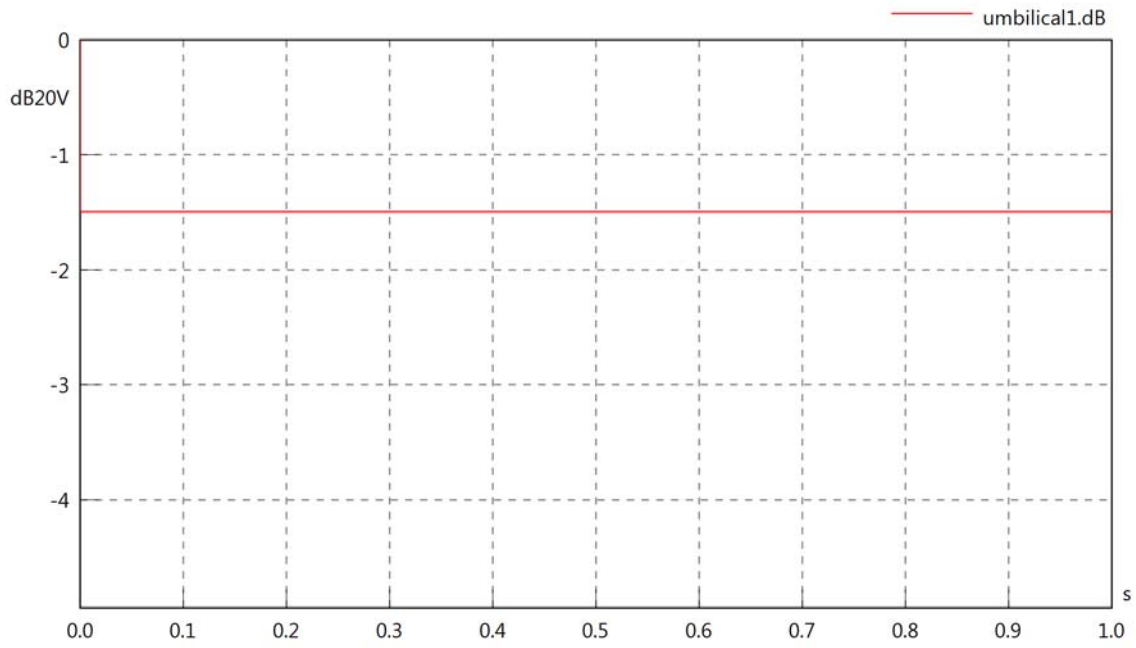
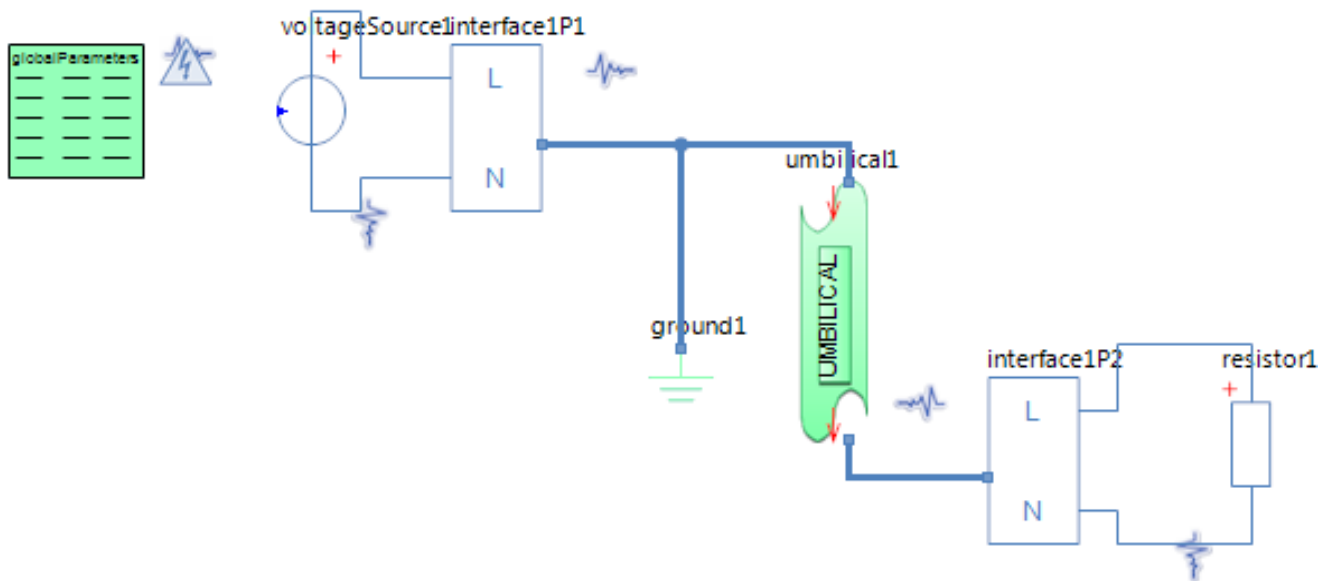

Diagram View



GlobalParameters globalParameters
Parameters

Comment	Name	Current Value	Unit
Type of Calculation	eCalculationKind	Signal Calculation	
Description of Frequency	eFrequencyKind	Linear	
Minimum Frequency	fMin	4	[kHz]
Maximum Frequency	fMax	4	[kHz]

Voltage Source voltageSource1
Parameters

Comment	Name	Current Value	Unit
Voltage RMS	VrmsSrc	$\min(230, 230000 * t)$	[V]
Phase	phi	0	[deg]

Resistor resistor1
Parameters

Comment	Name	Current Value	Unit
Resistance	R	100	[Ohm]

Umbilical umbilical1
Parameters

Comment	Name	Current Value	Unit
Resistance per length for each Line at 20 °C (68 °F)	r	1	[Ohm/km]
Inductance per length for each Line	l	0.5	[mH/km]
Conductance per length between Lines	g	1e-10	[1/(Ohm·m)]
Capacitance per length between Lines	c	0.1	[µF/km]
Length of Umbilical for each Line	length	10	[km]
Temperature of the conductor	temp	5	[°C]
Skin effect	skinEff	Round, stranded or solid copper conductor	
Conductor area	area	6	[mm²]

umbilical1.rTemp

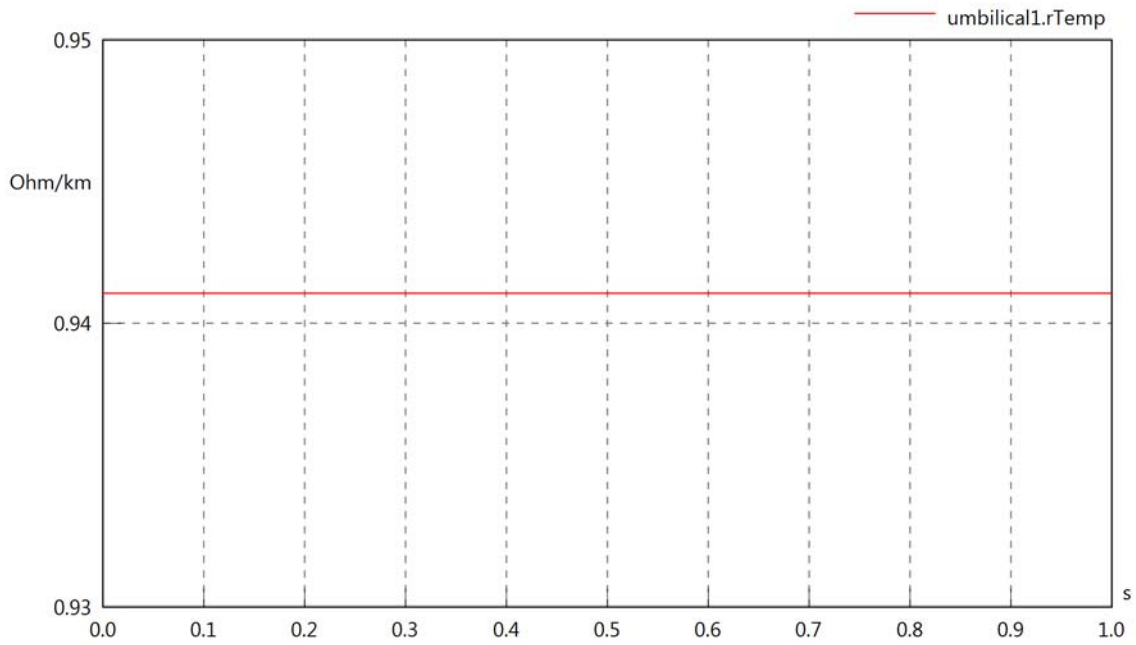

umbilical1.skinDepth

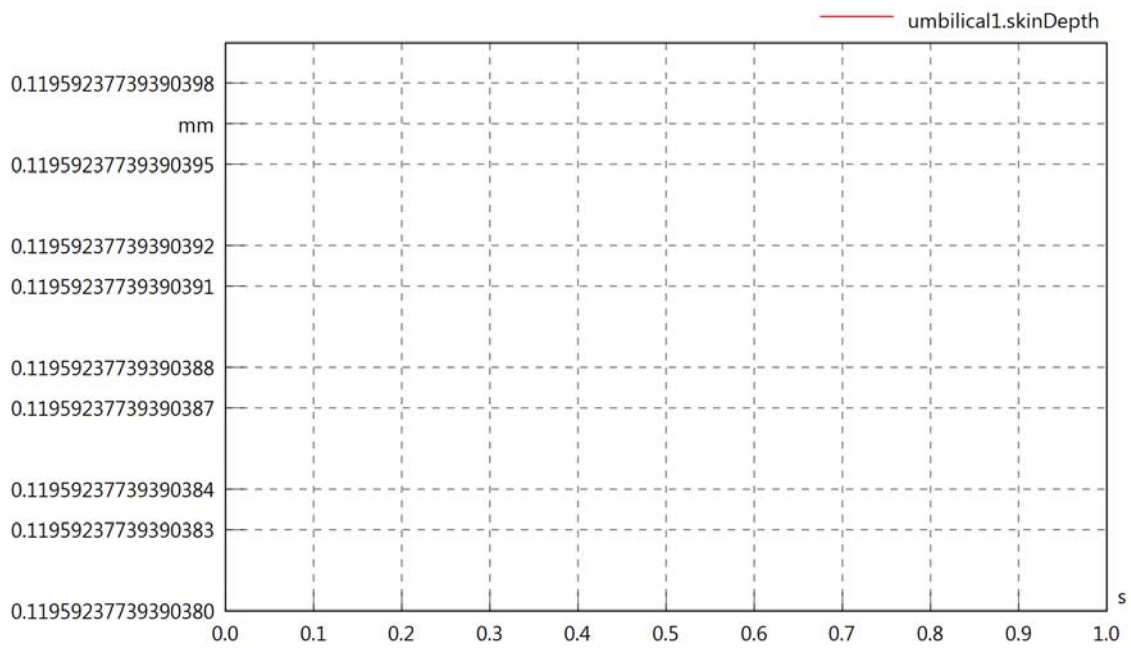

umbilical1.diameter

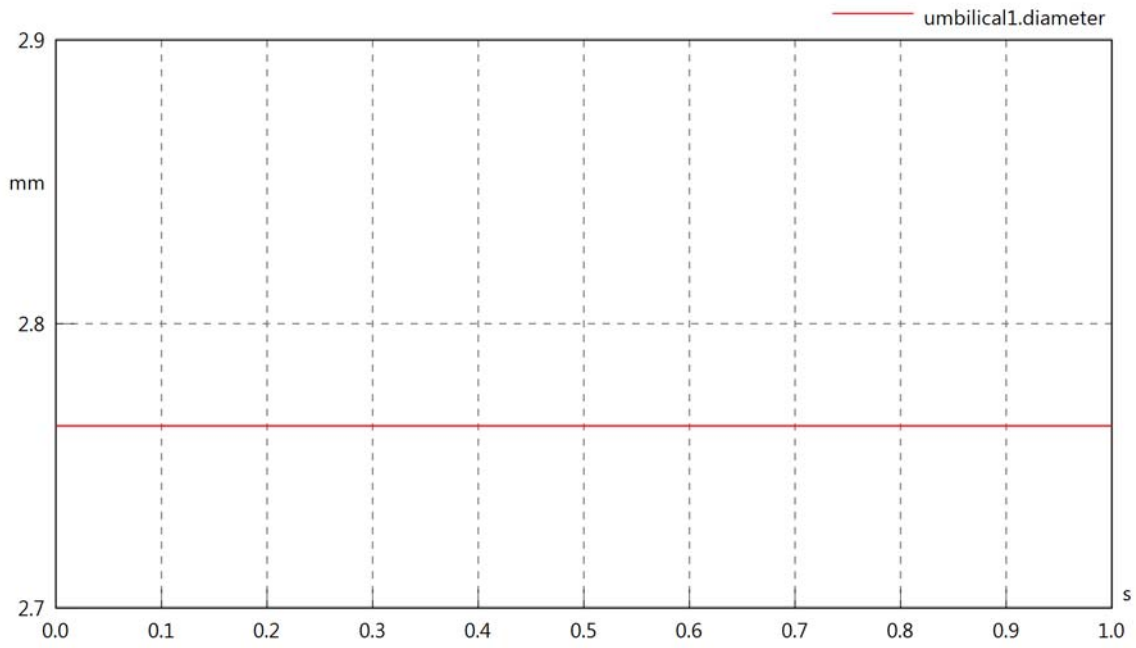

umbilical1.resistivity

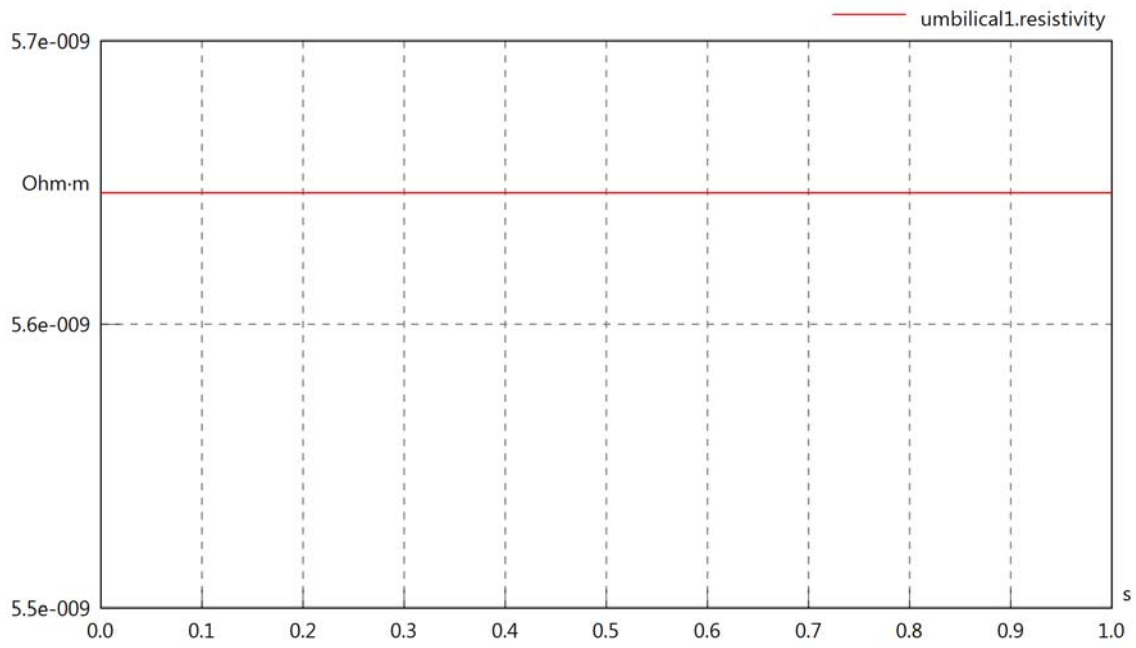

umbilical1.rInternal

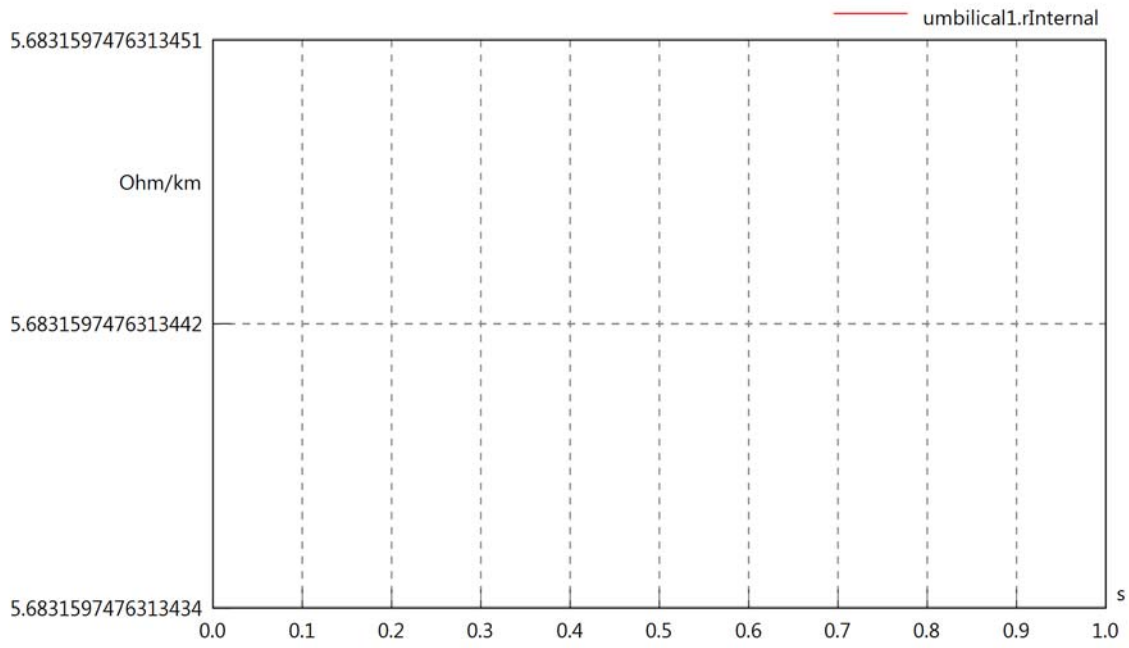

umbilical1.VrmsIn

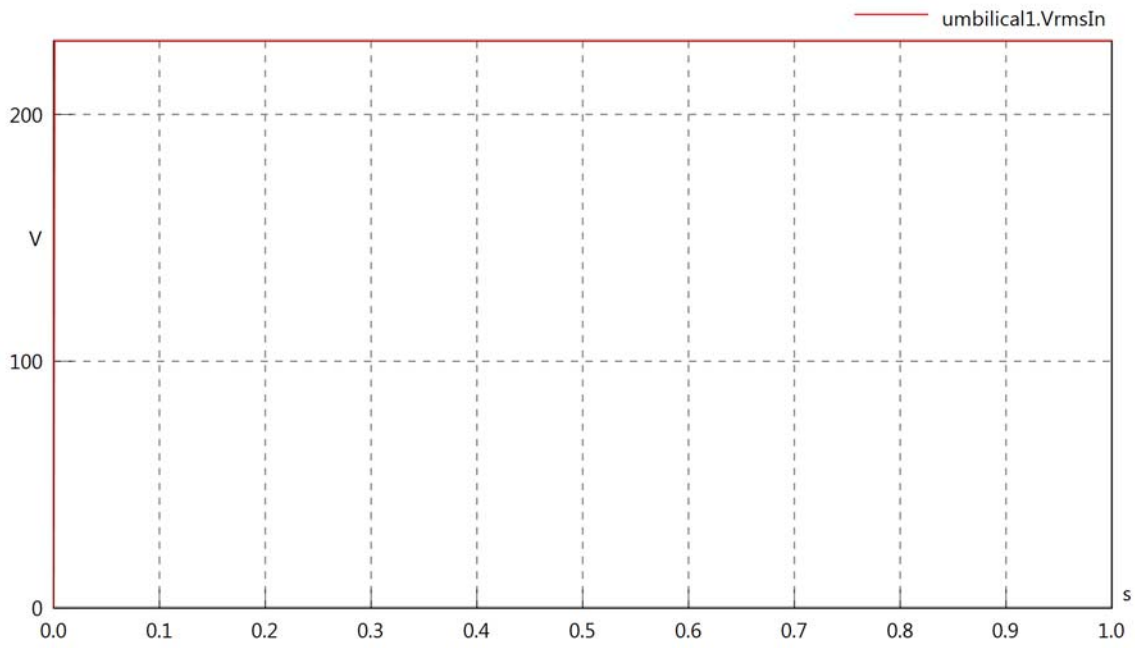

umbilical1.vReIn

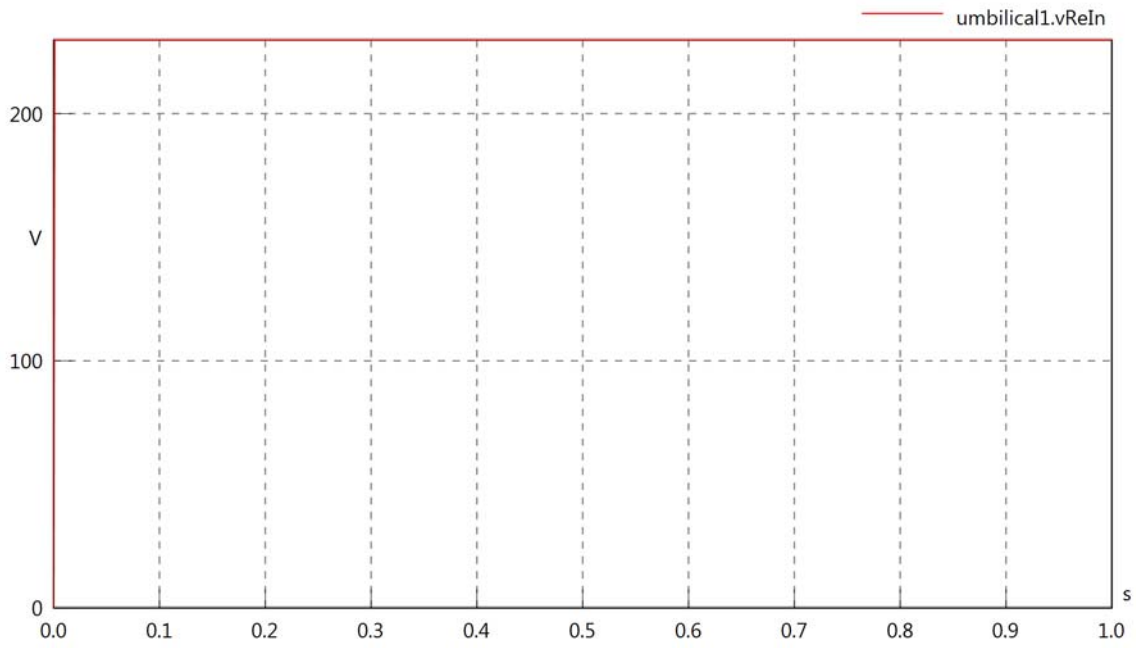

umbilical1.vImIn

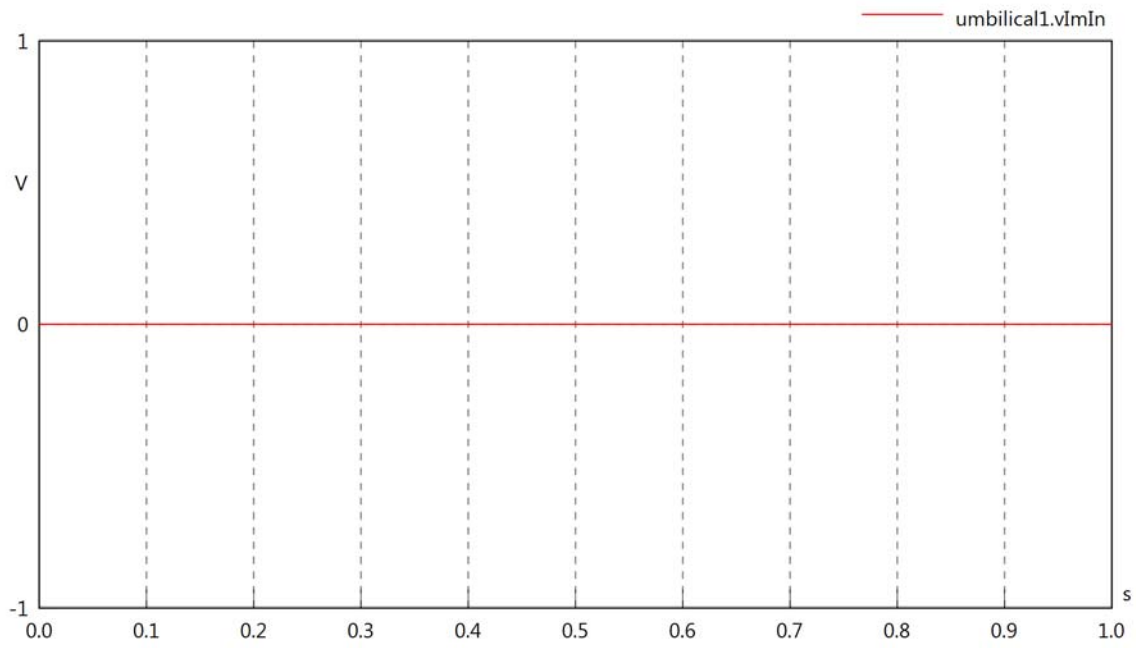

umbilical1.VrmsOut

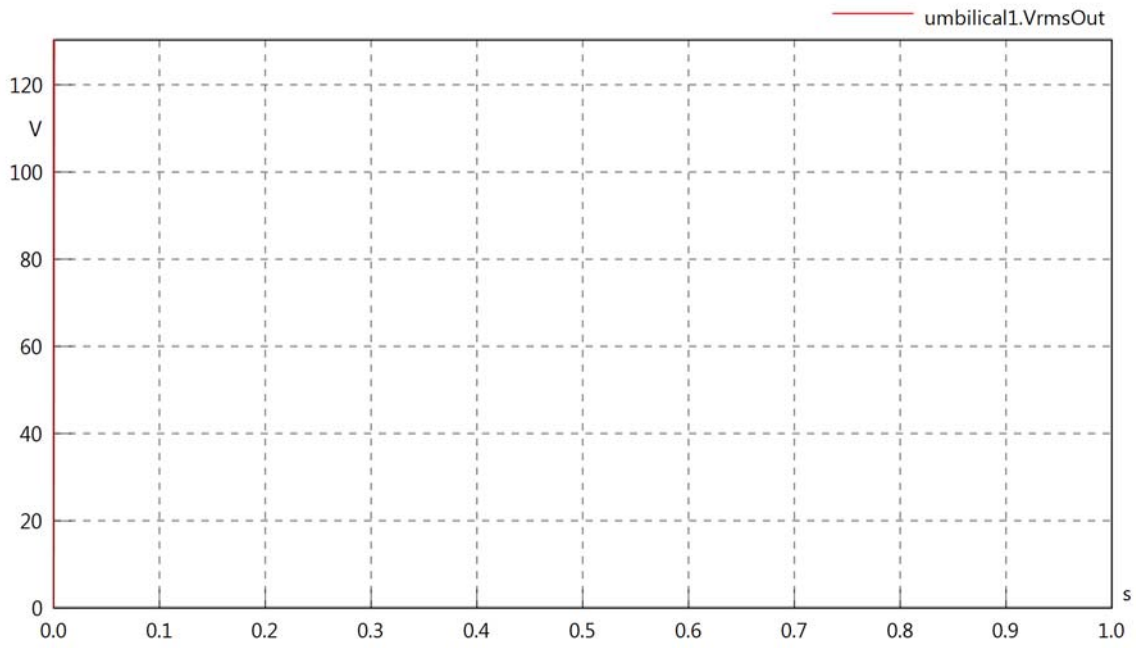

umbilical1.vReOut

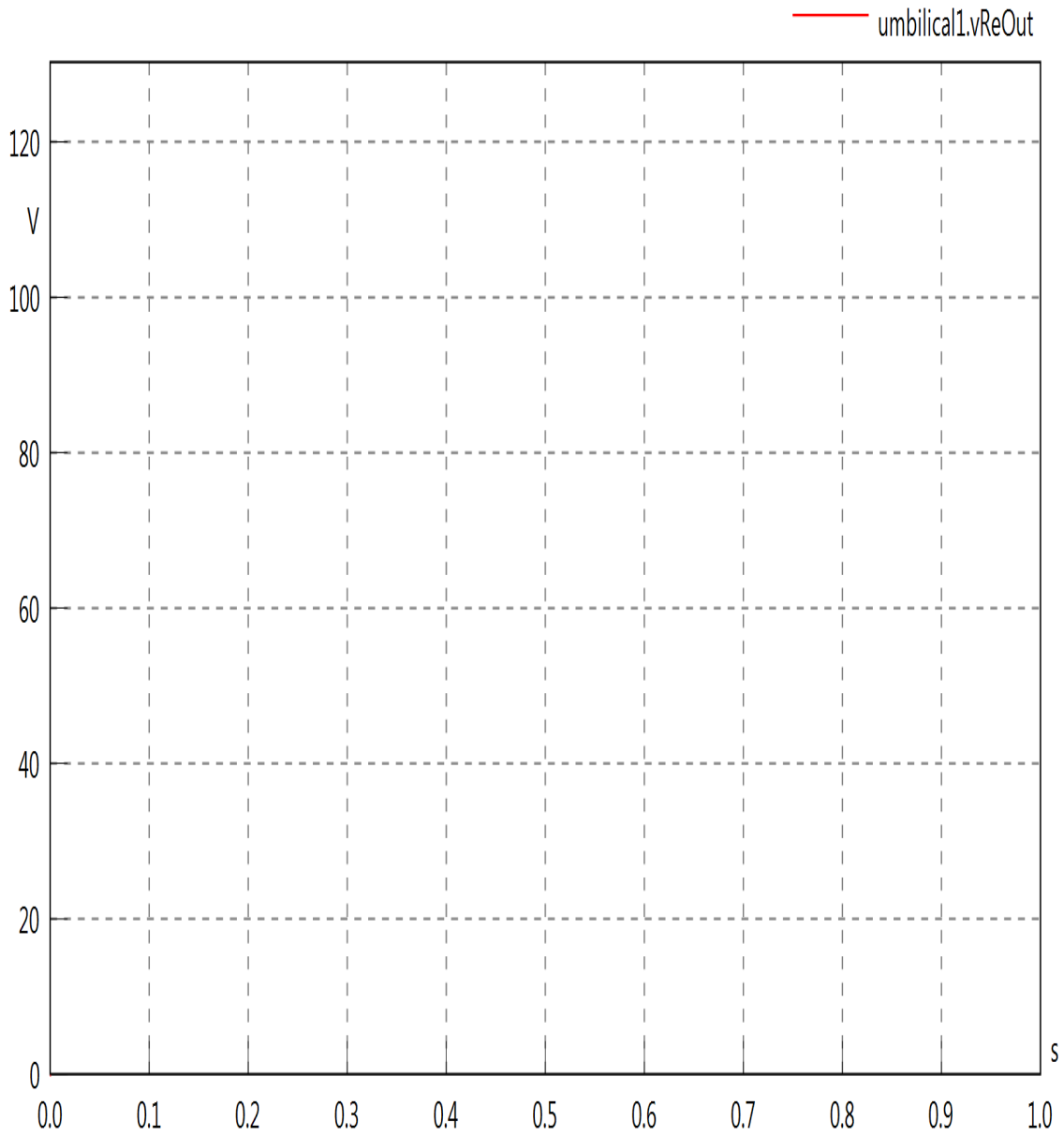

8/27
3.6.2.27707 x64
SimulationX

umbilical1.vImOut



Supporting your visions

umbilical1.Vrms

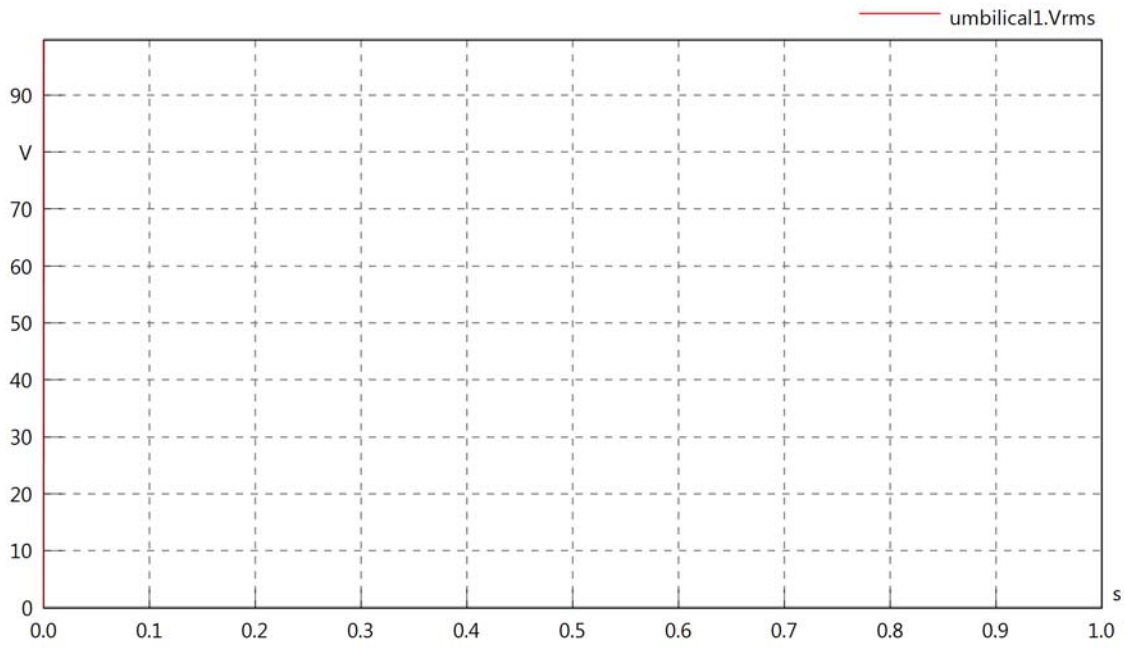

umbilical1.vRe

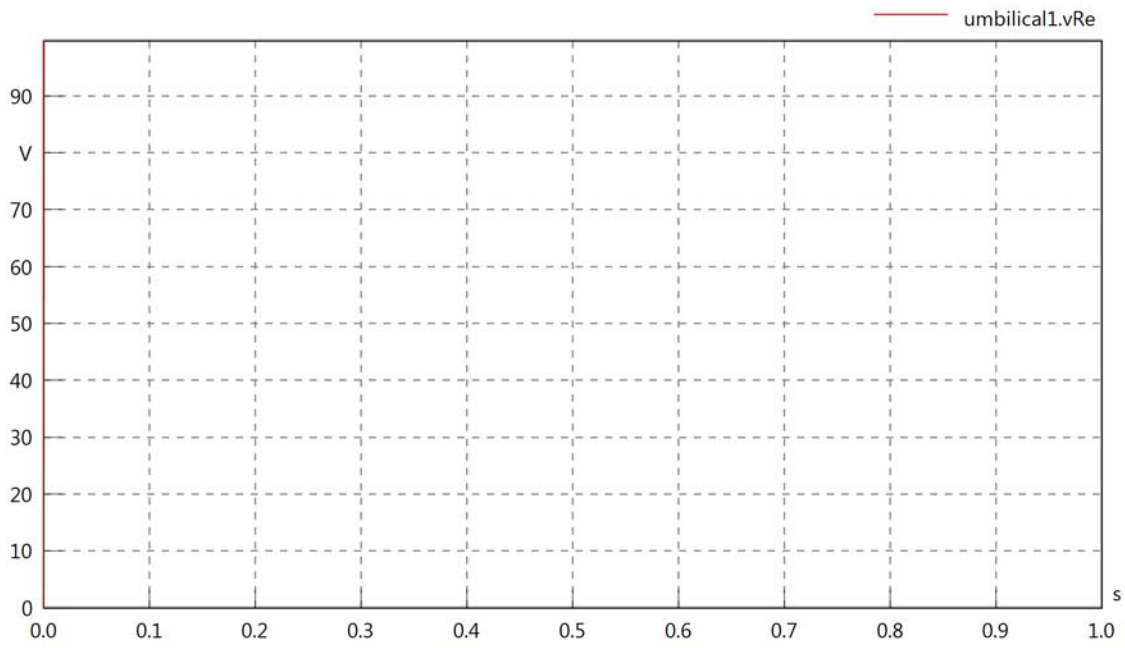

umbilical1.vIm

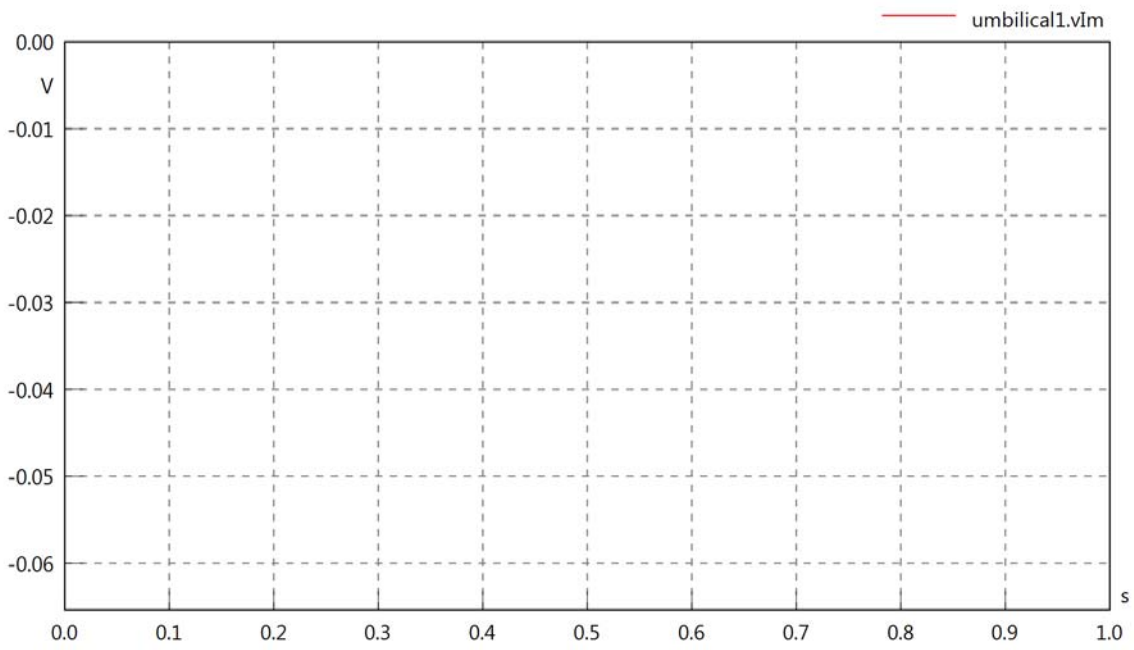

umbilical1.IrmsIn

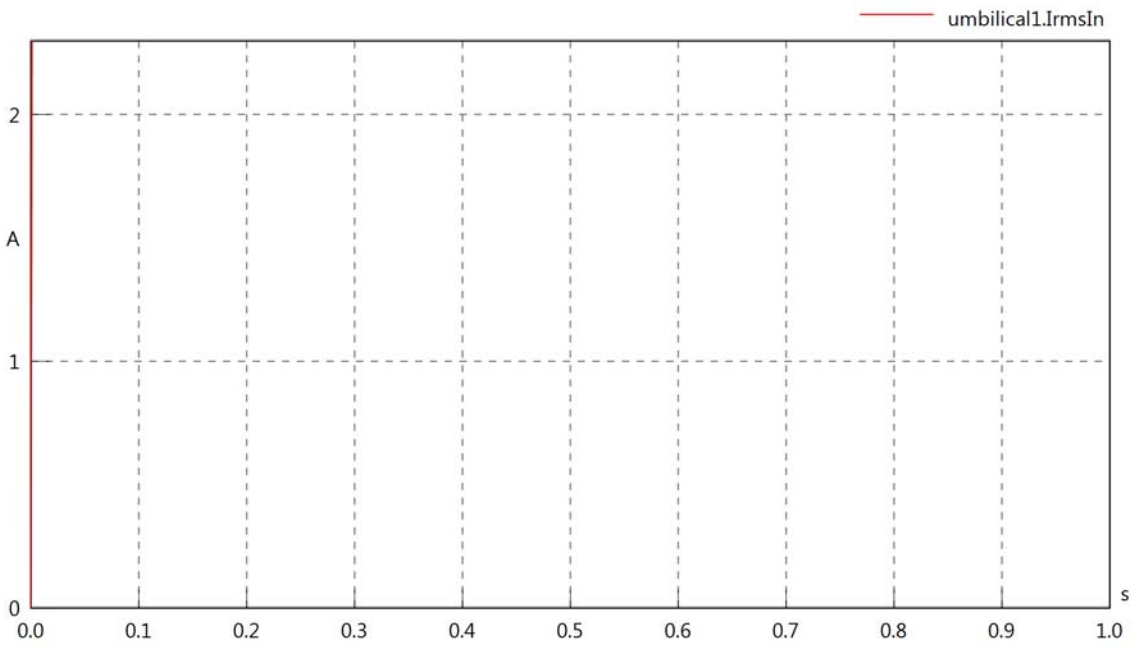

umbilical1.iReIn

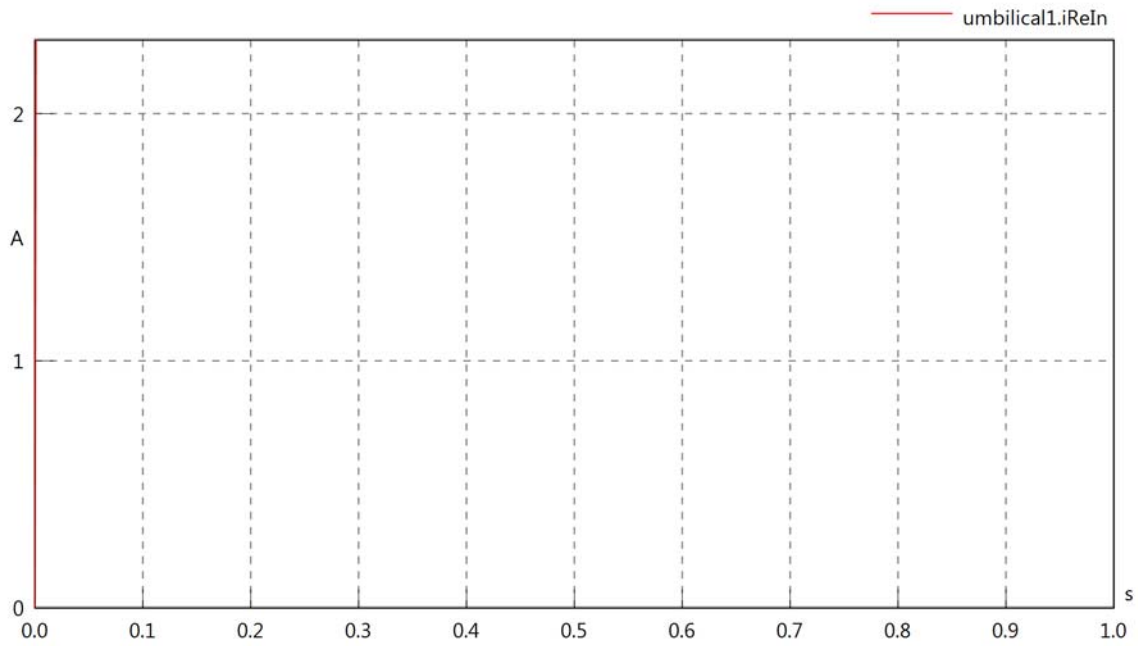

umbilical1.iImIn

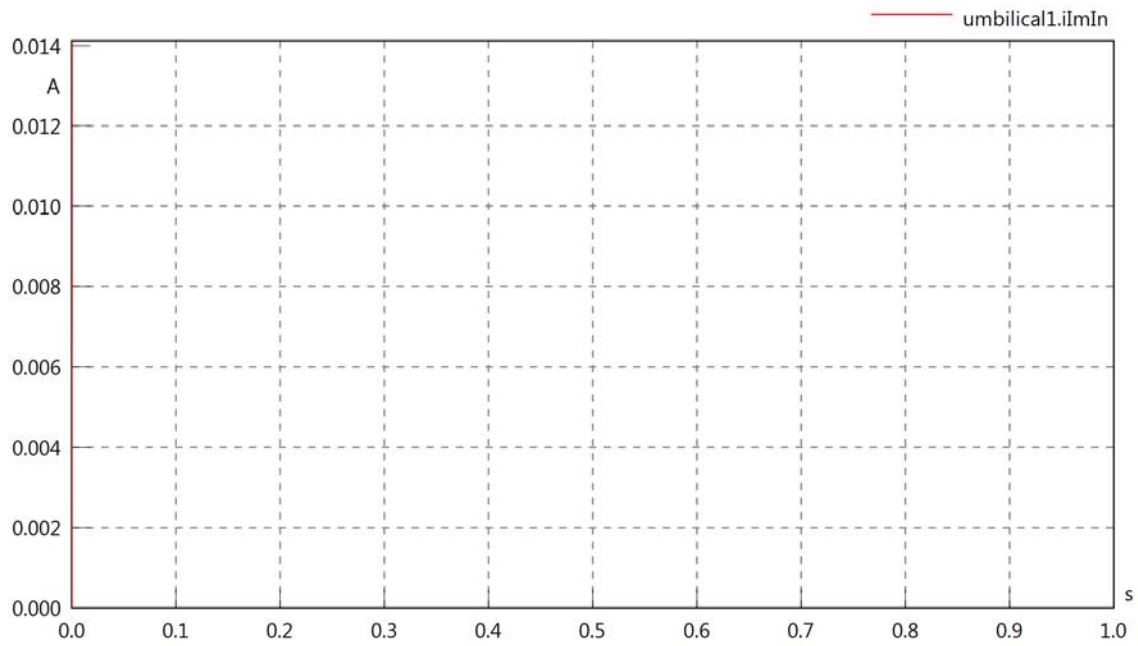

umbilical1.IrmsOut

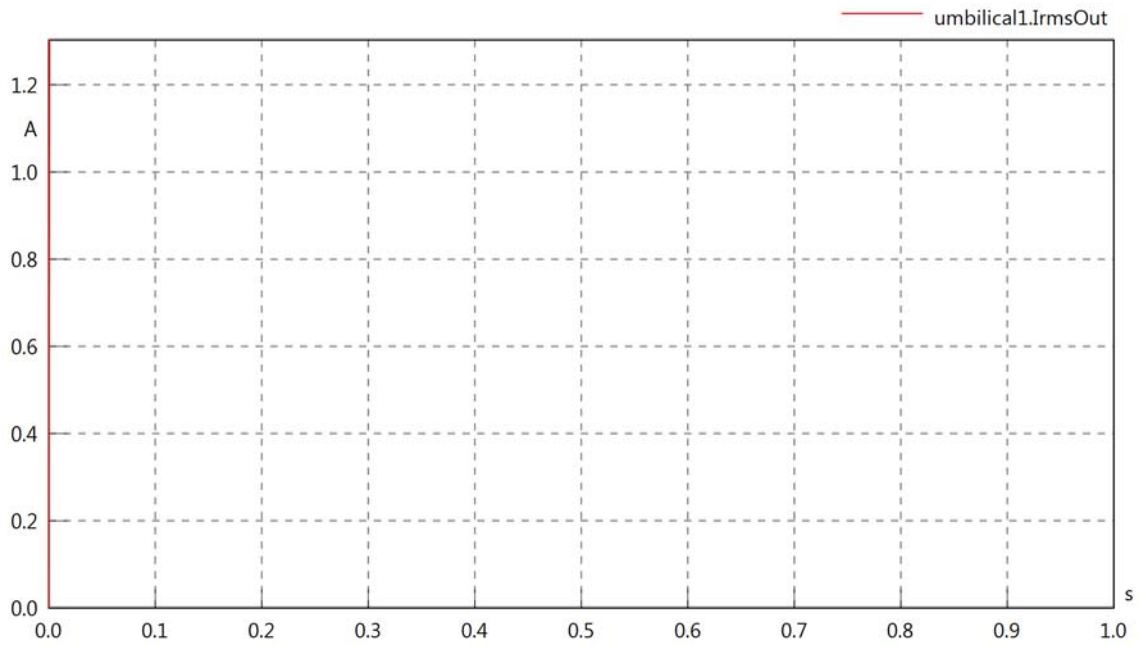

umbilical1.iReOut

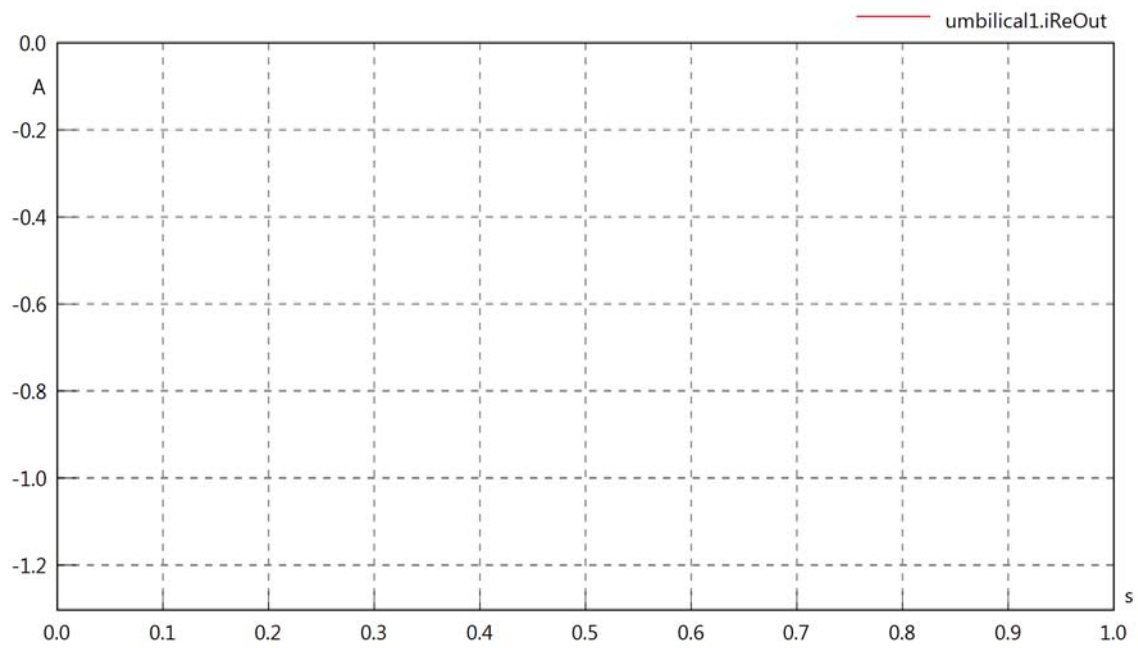

umbilical1.iImOut

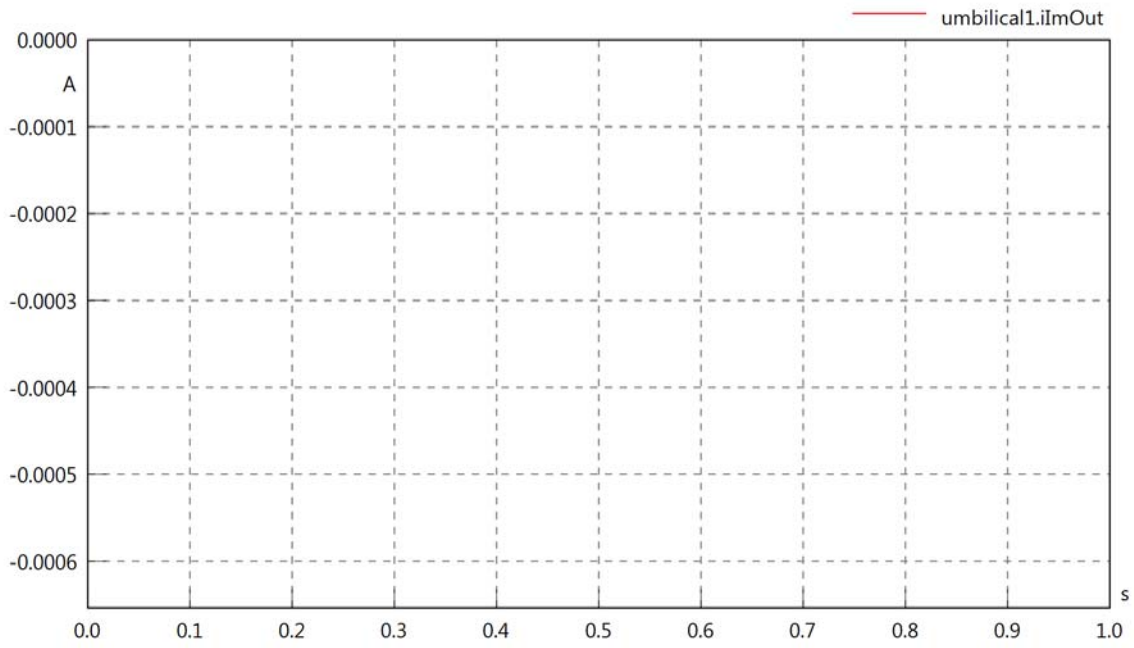

umbilical1.phiVIn

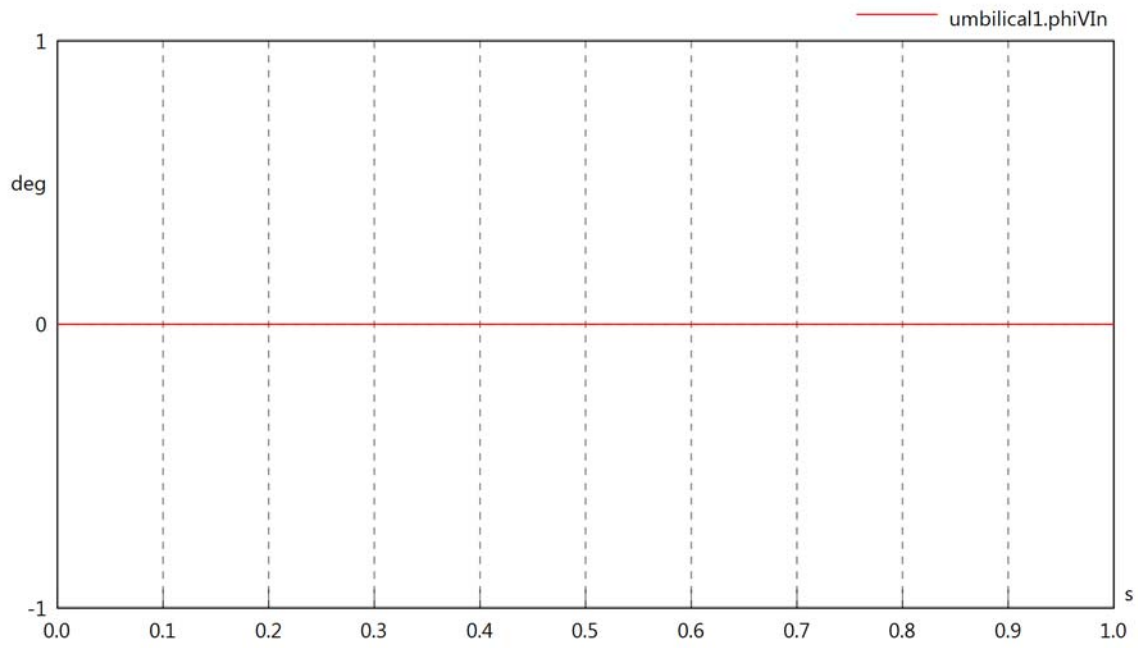

umbilical1.philIn

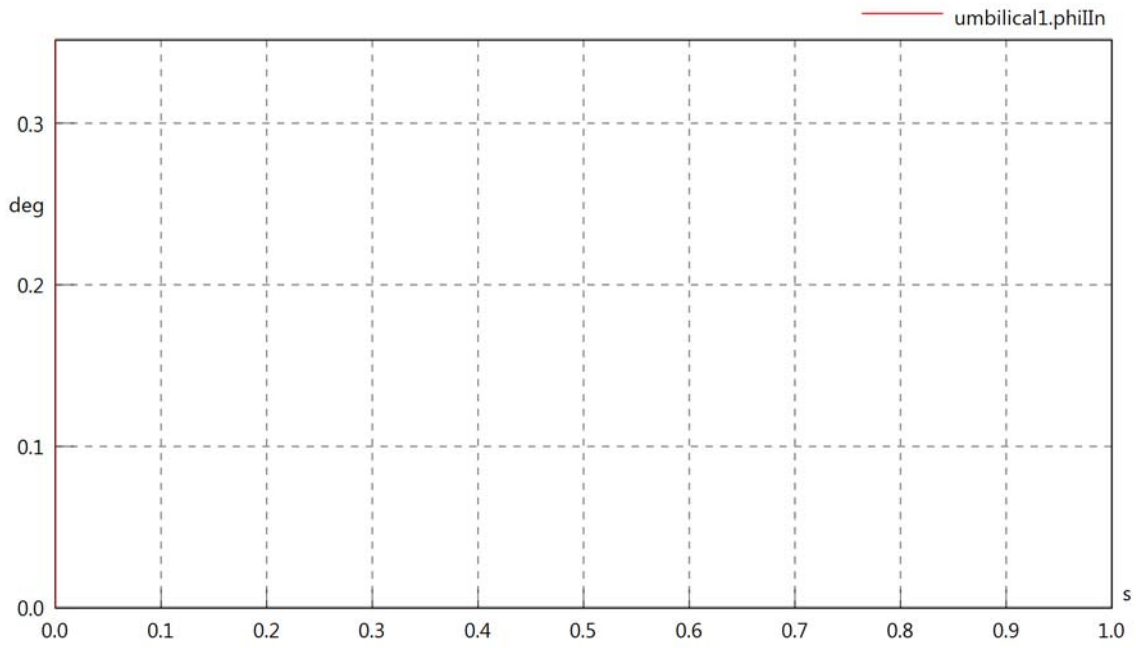

umbilical1.phiIVIn

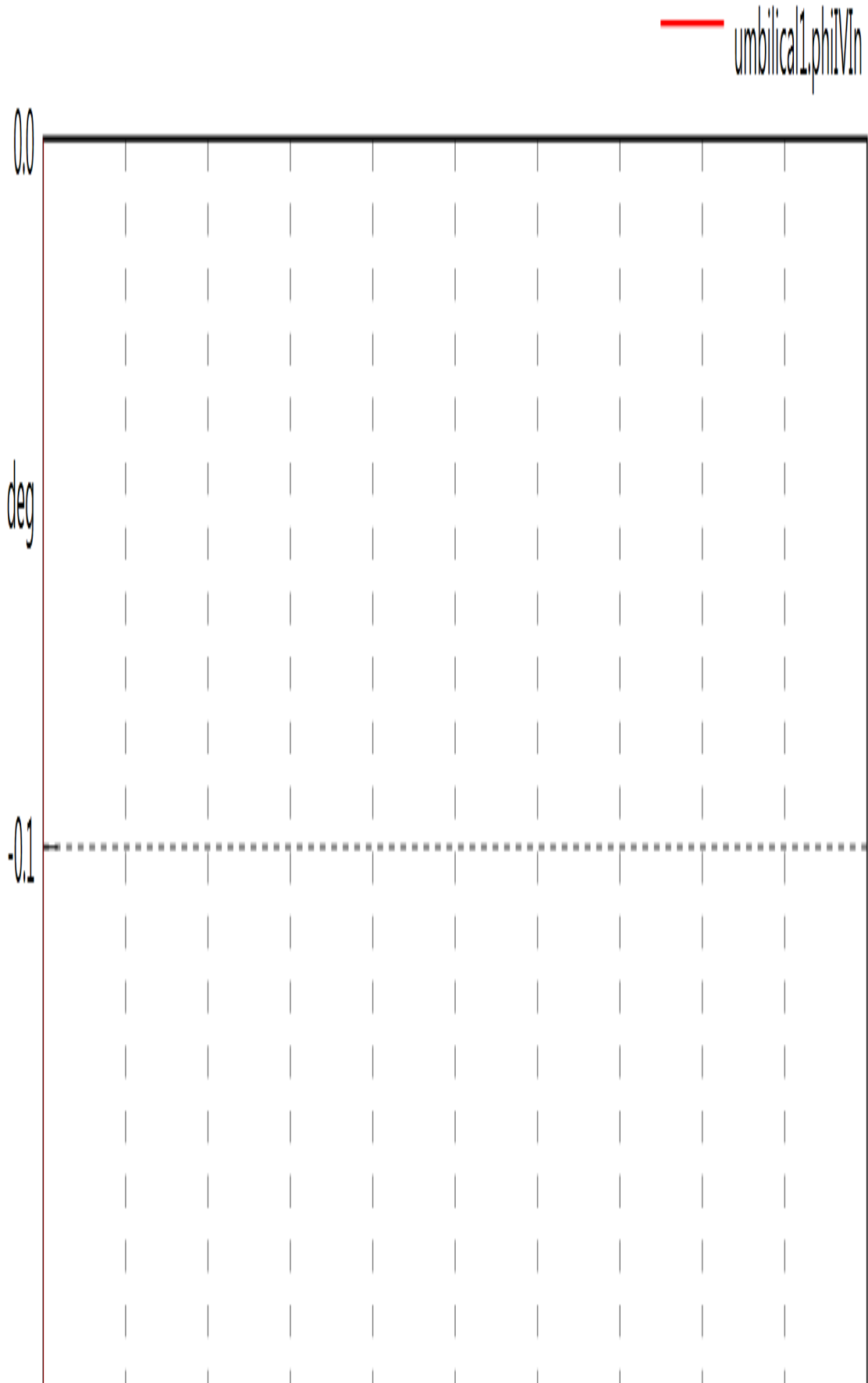

16/27
3.6.2.27707 x64
SimulationX

umbilical1.phiVOut



Supporting your visions

umbilical1.phiIOut

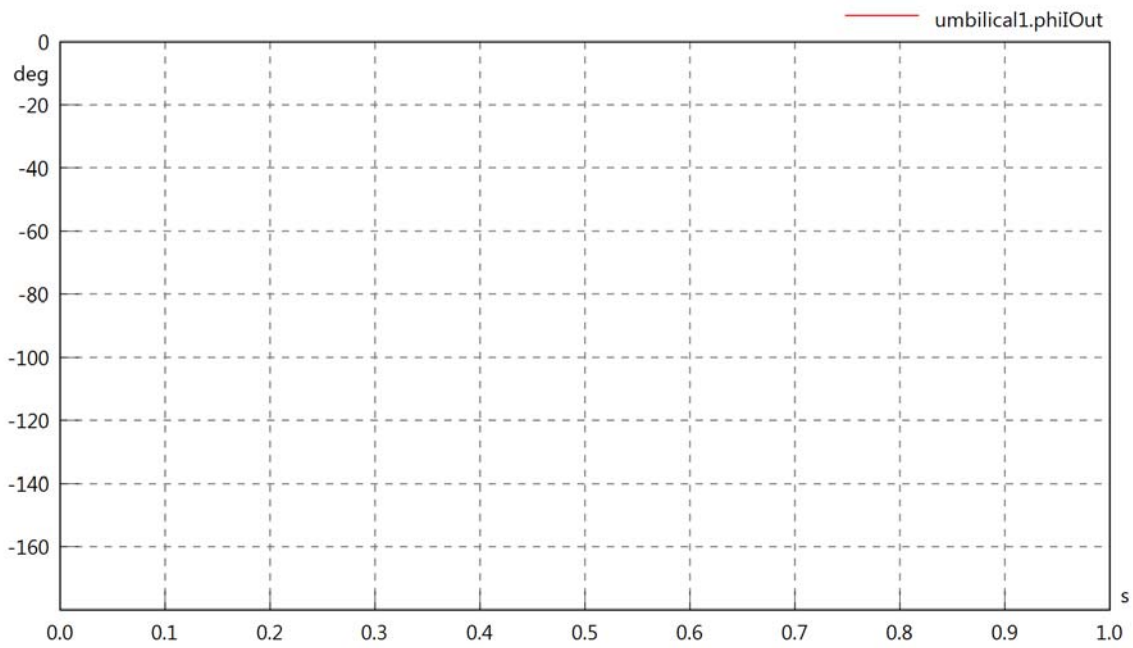

umbilical1.phiIVOut

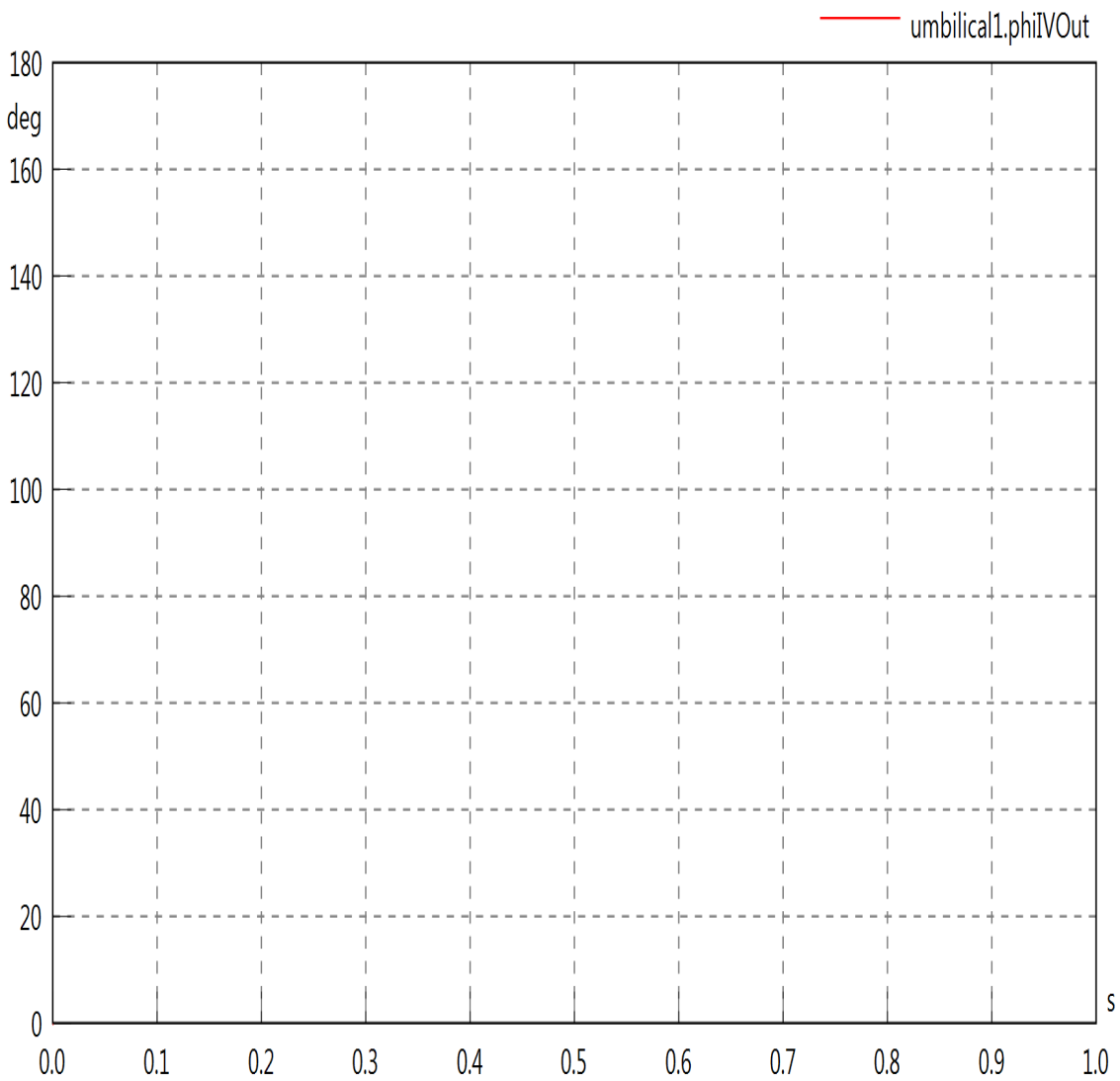

umbilical1.phiVL1

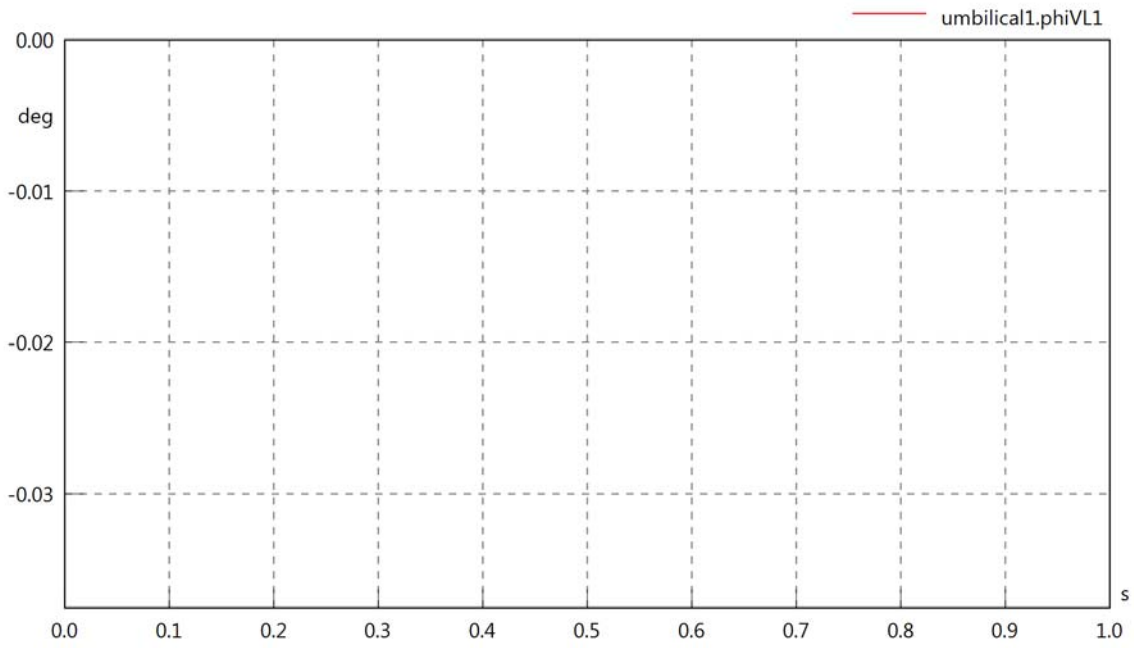

19/27
3.6.2.27707 x64
SimulationX

umbilical1.philL1



Supporting your visions

umbilical1.phiIVL1

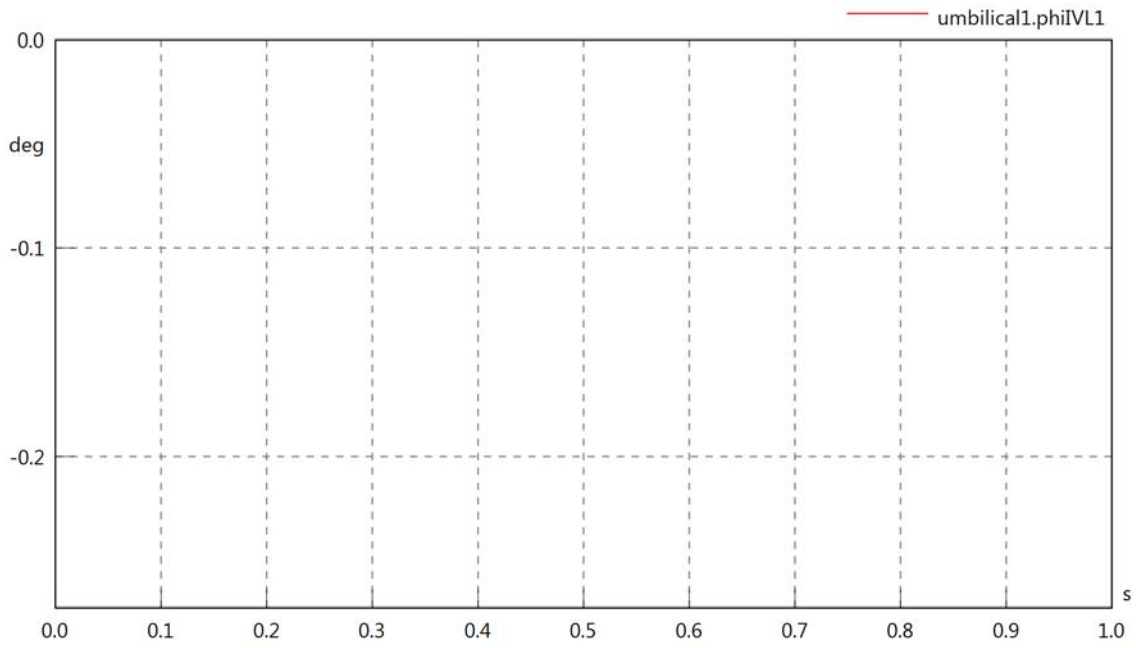

umbilical1.PReIn

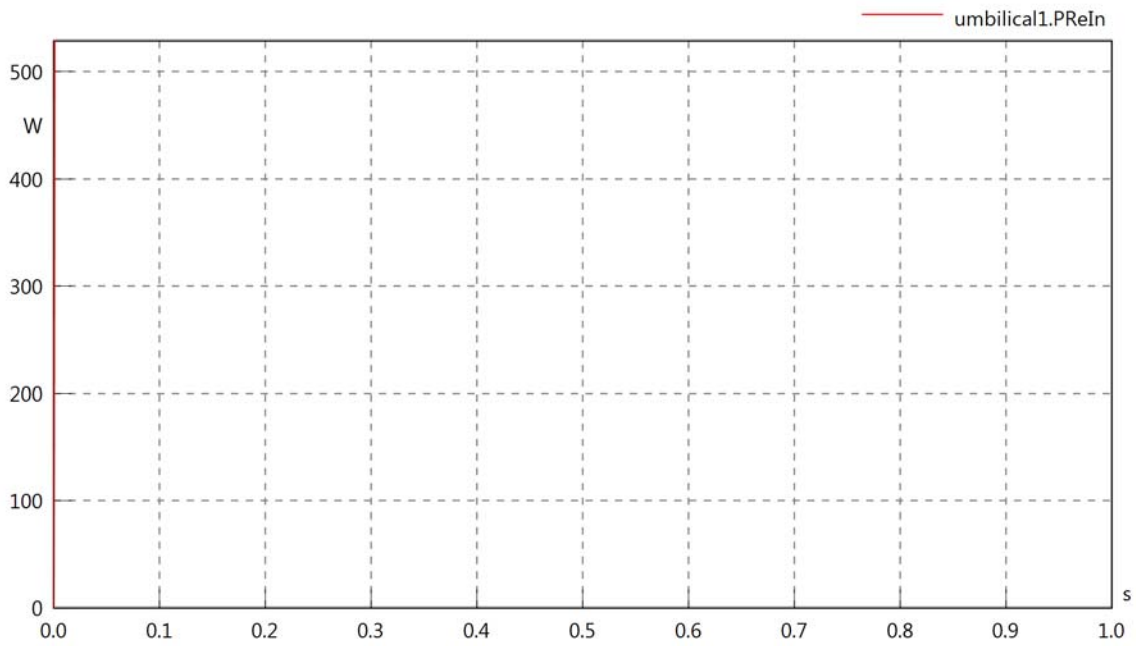

umbilical1.P1mIn

— umbilical1.P1mIn

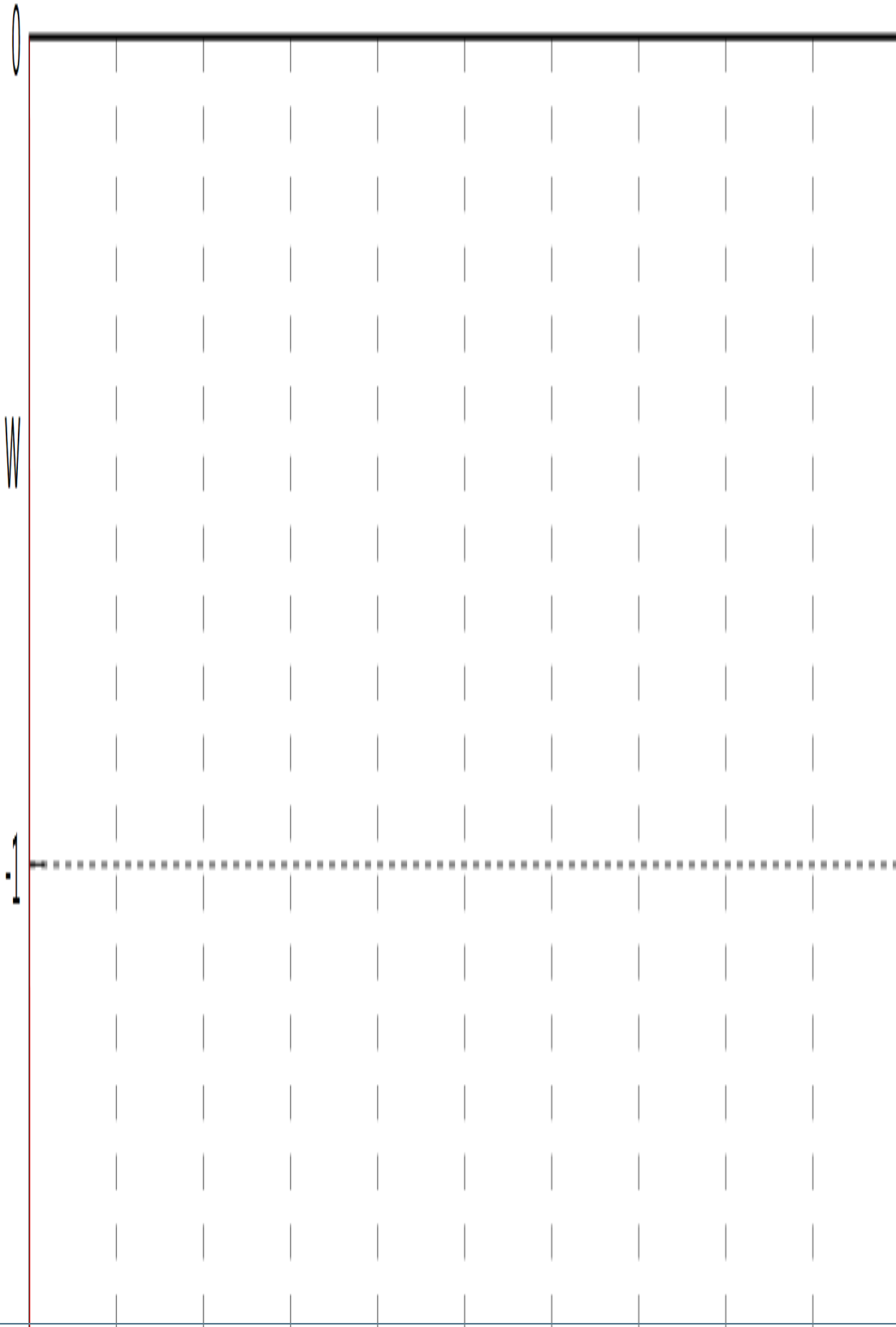

umbilical1.SIn

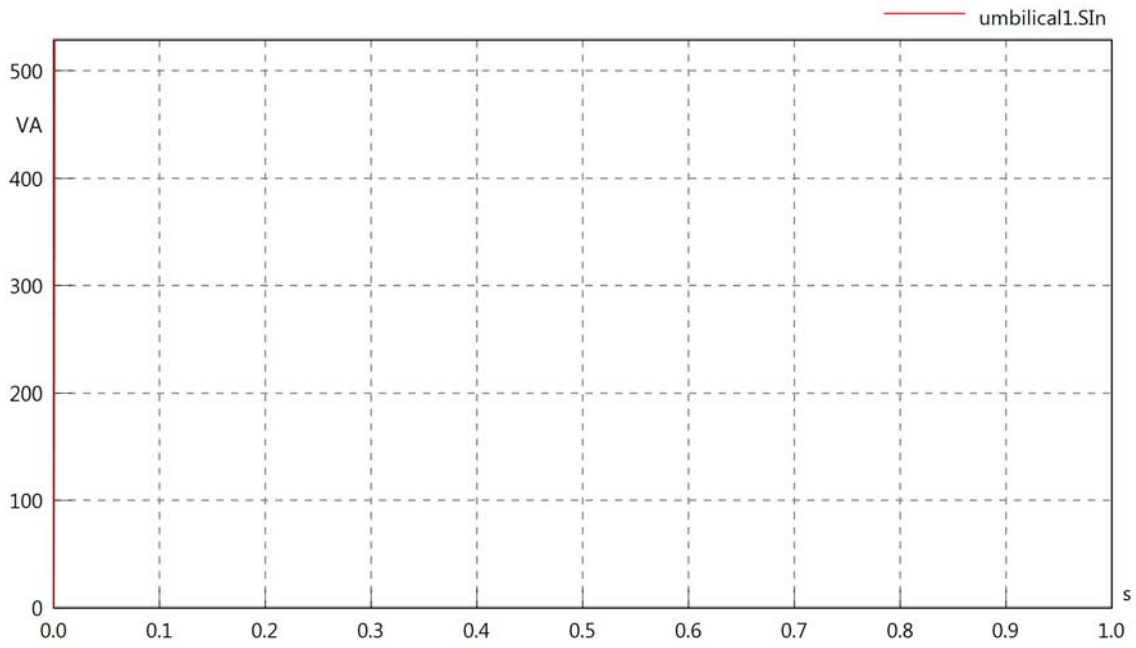

umbilical1.PReOut

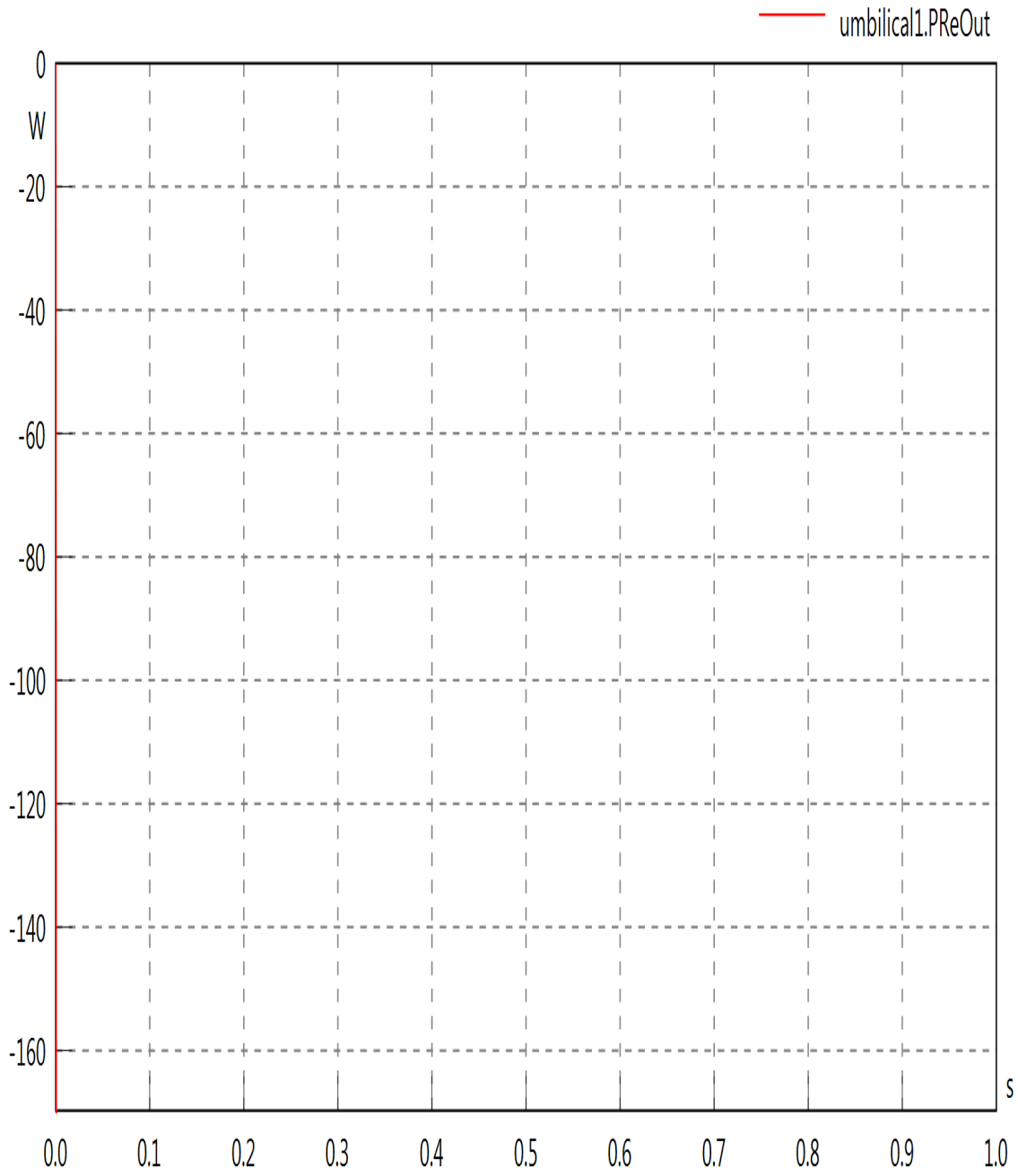

umbilical1.PImOut

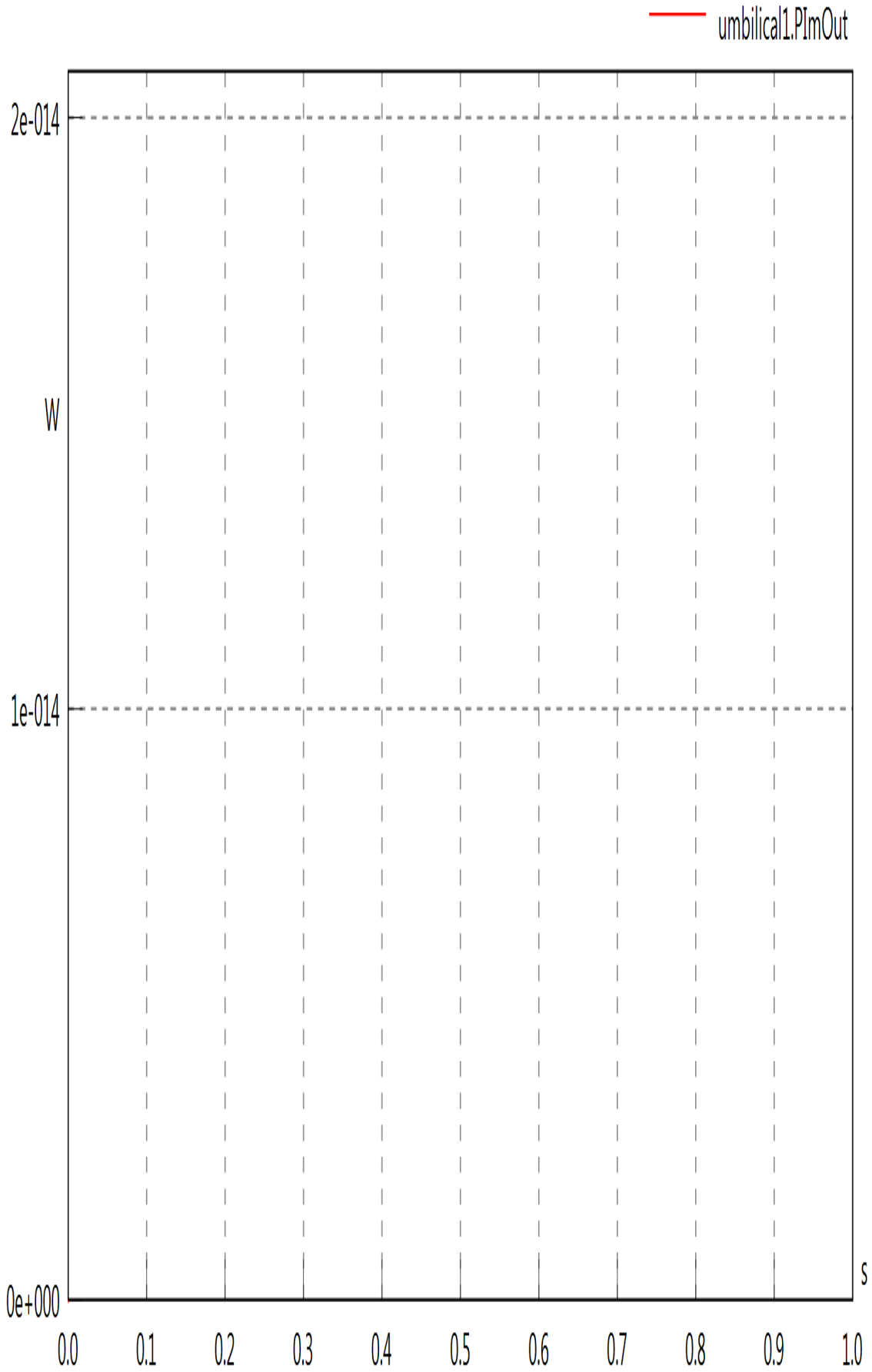

umbilical1.SOut

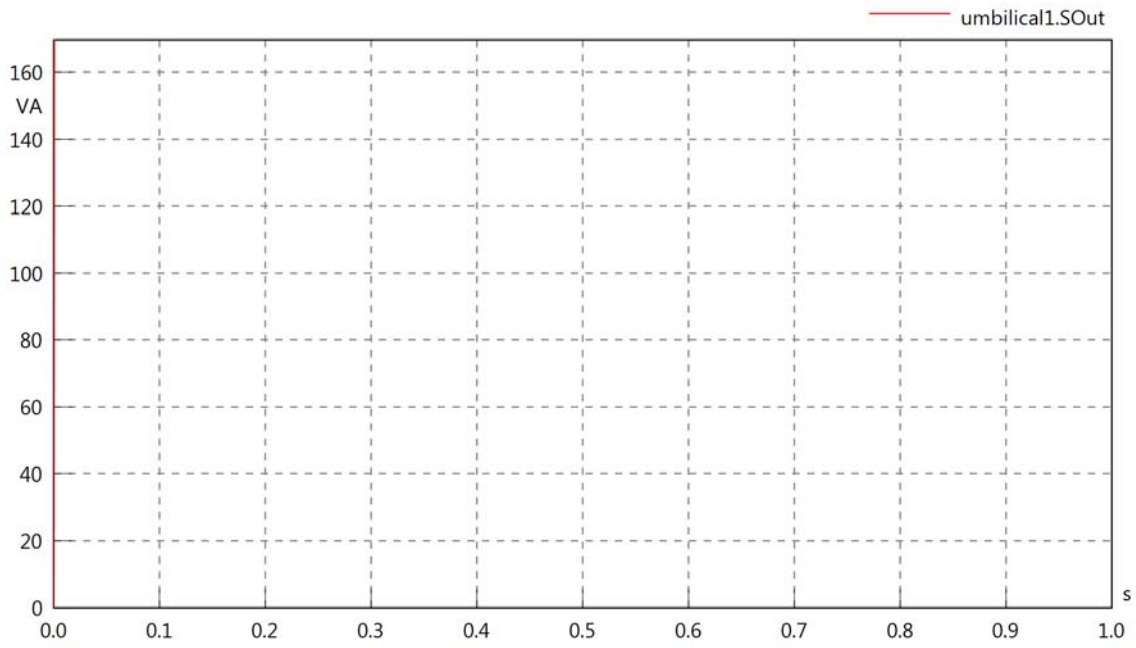

umbilical1.PRe

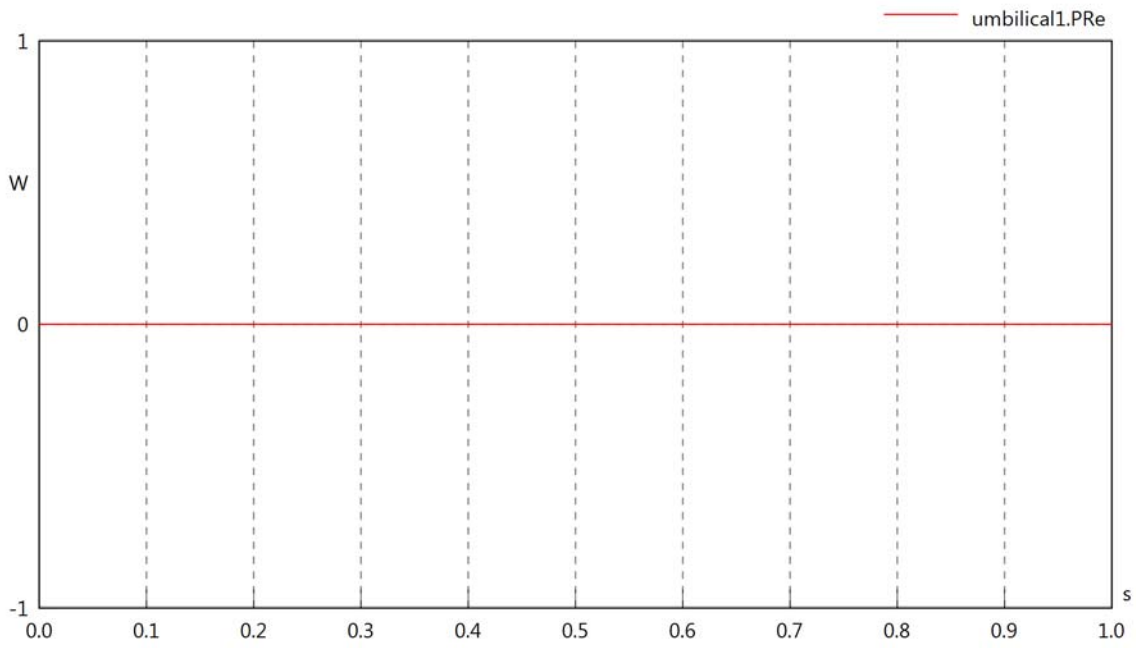

umbilical1.PIm

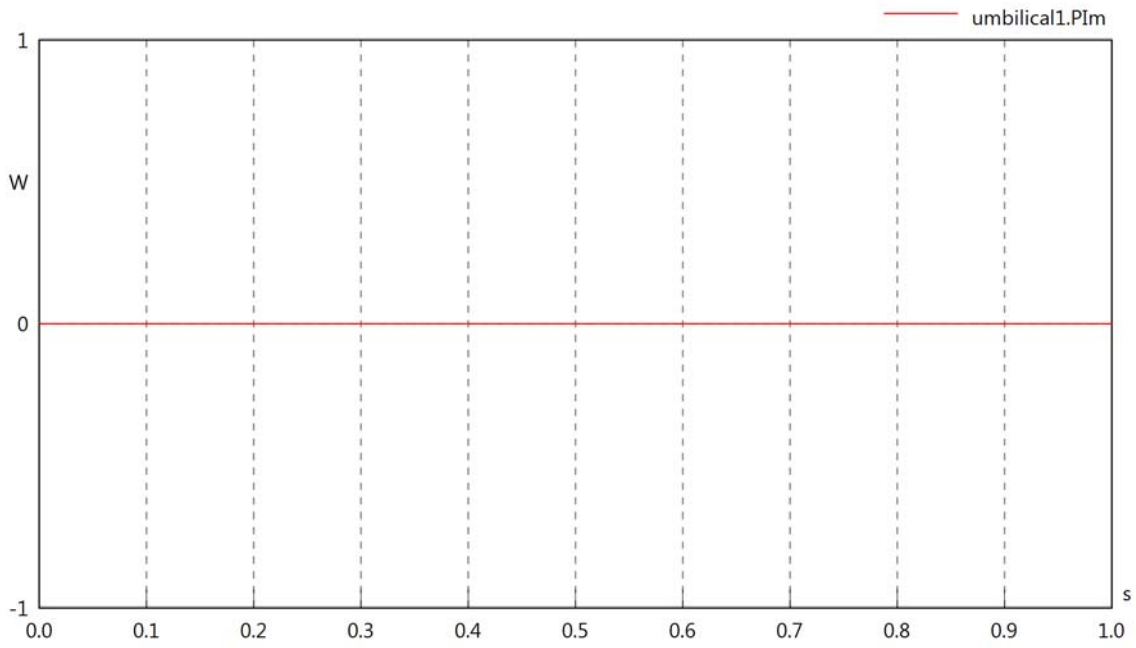

umbilical1.S

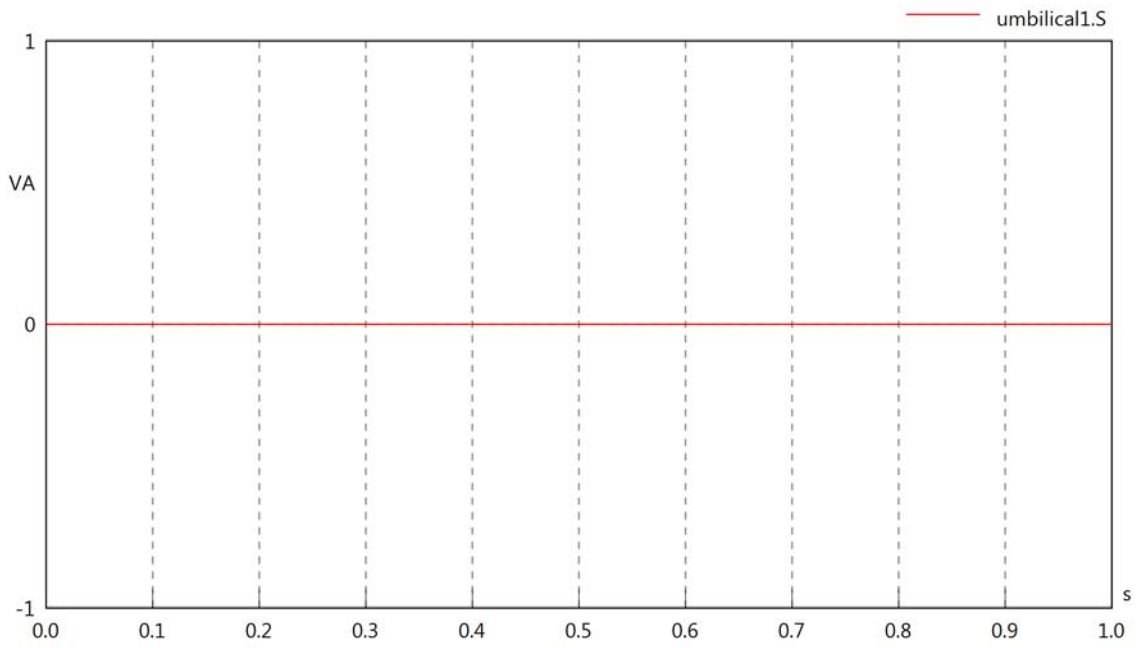

umbilical1.dB

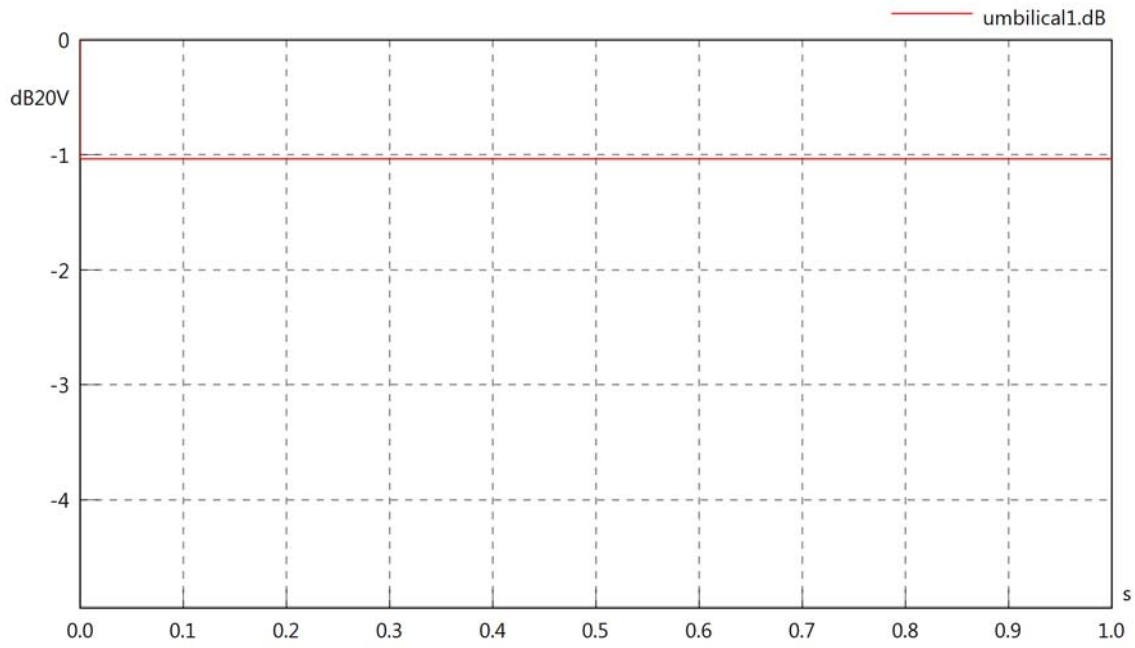
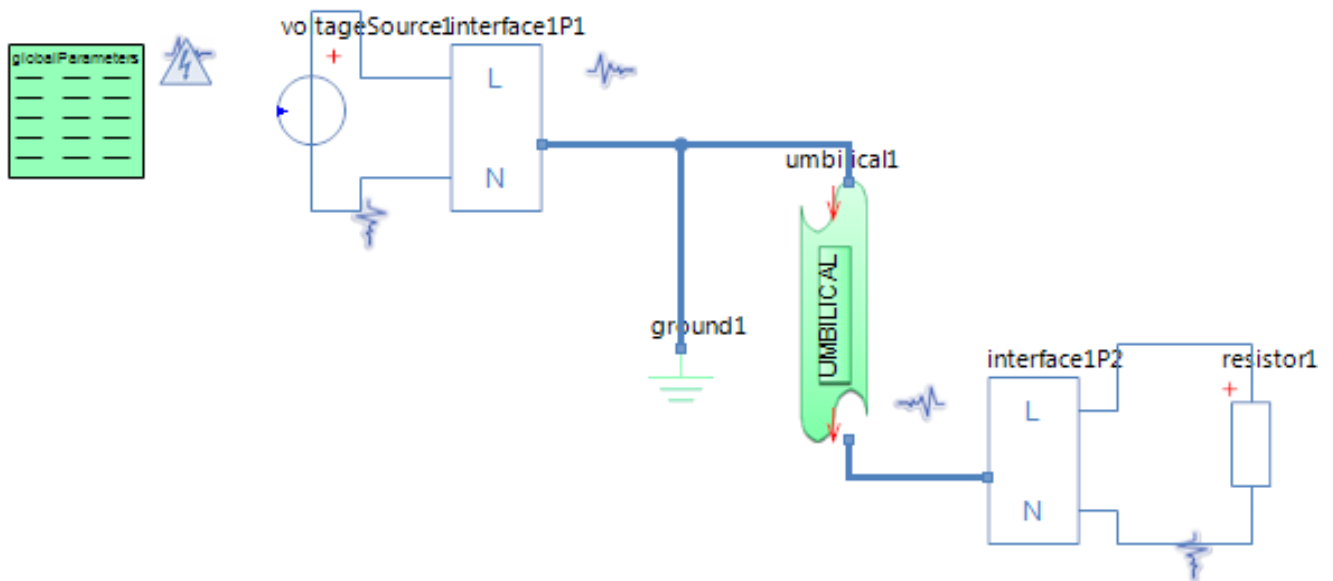

Diagram View



GlobalParameters globalParameters
Parameters

Comment	Name	Current Value	Unit
Type of Calculation	eCalculationKind	Signal Calculation	
Description of Frequency	eFrequencyKind	Linear	
Minimum Frequency	fMin	100	[kHz]
Maximum Frequency	fMax	100	[kHz]

Voltage Source voltageSource1
Parameters

Comment	Name	Current Value	Unit
Voltage RMS	VrmsSrc	$\min(230, 230000 \cdot t)$	[V]
Phase	phi	0	[deg]

Resistor resistor1
Parameters

Comment	Name	Current Value	Unit
Resistance	R	100	[Ohm]

Umbilical umbilical1
Parameters

Comment	Name	Current Value	Unit
Resistance per length for each Line at 20 °C (68 °F)	r	1	[Ohm/km]
Inductance per length for each Line	l	0.5	[mH/km]
Conductance per length between Lines	g	1e-10	[1/(Ohm·m)]
Capacitance per length between Lines	c	0.1	[µF/km]
Length of Umbilical for each Line	length	10	[km]
Temperature of the conductor	temp	5	[°C]
Skin effect	skinEff	Round, stranded or solid copper conductor	
Conductor area	area	6	[mm²]

umbilical1.rTemp

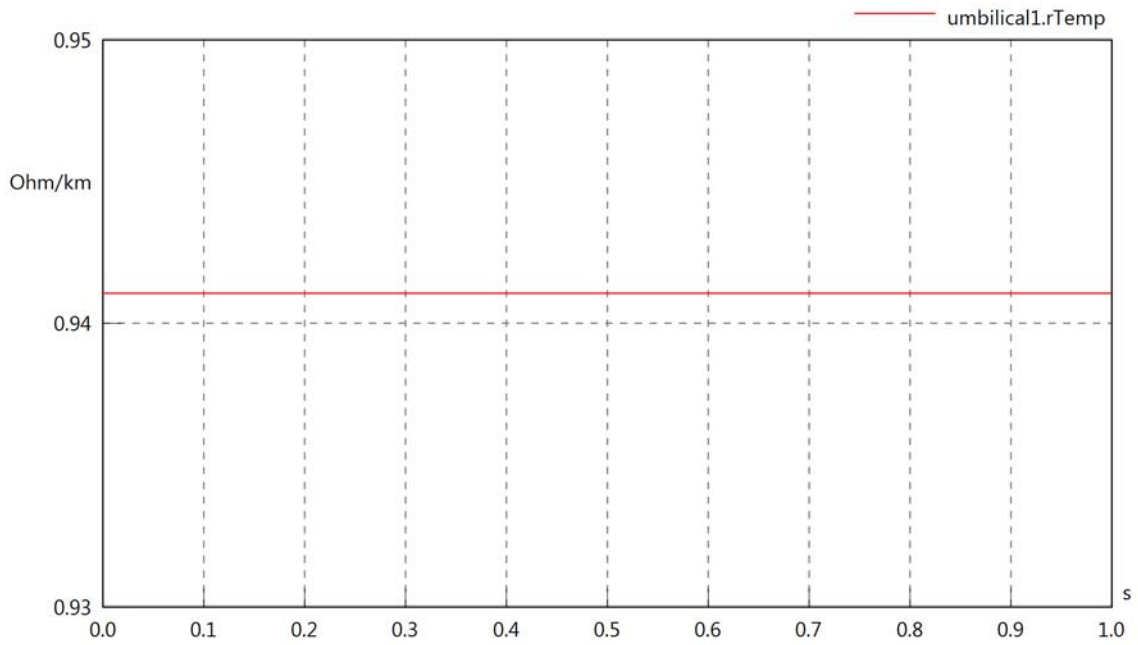

umbilical1.skinDepth

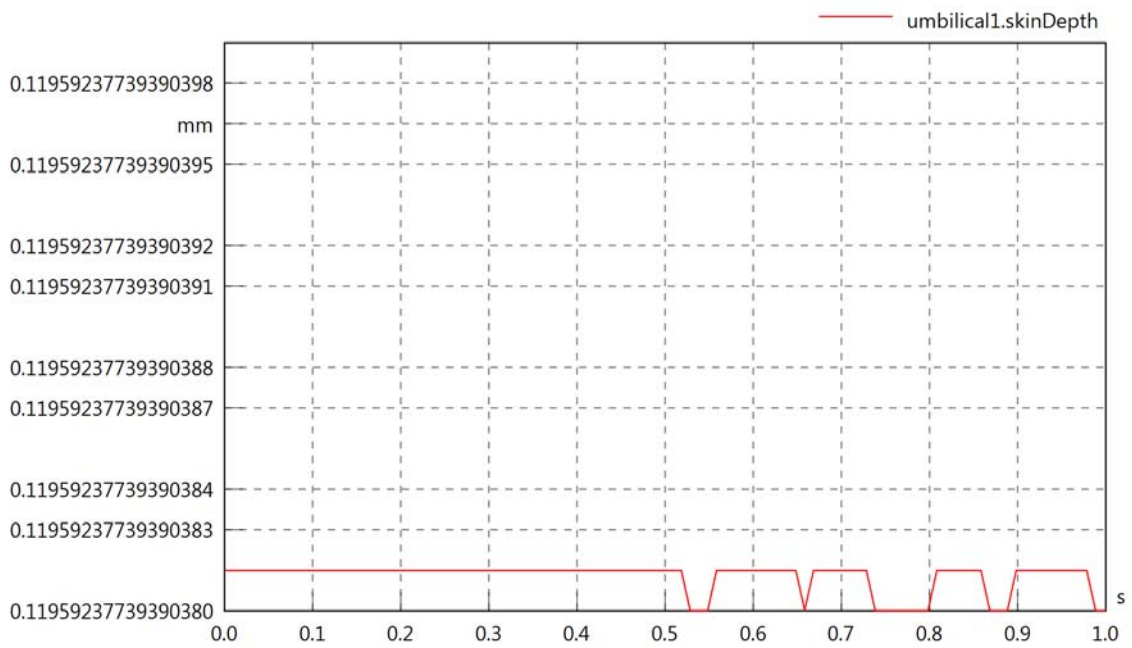

umbilical1.diameter

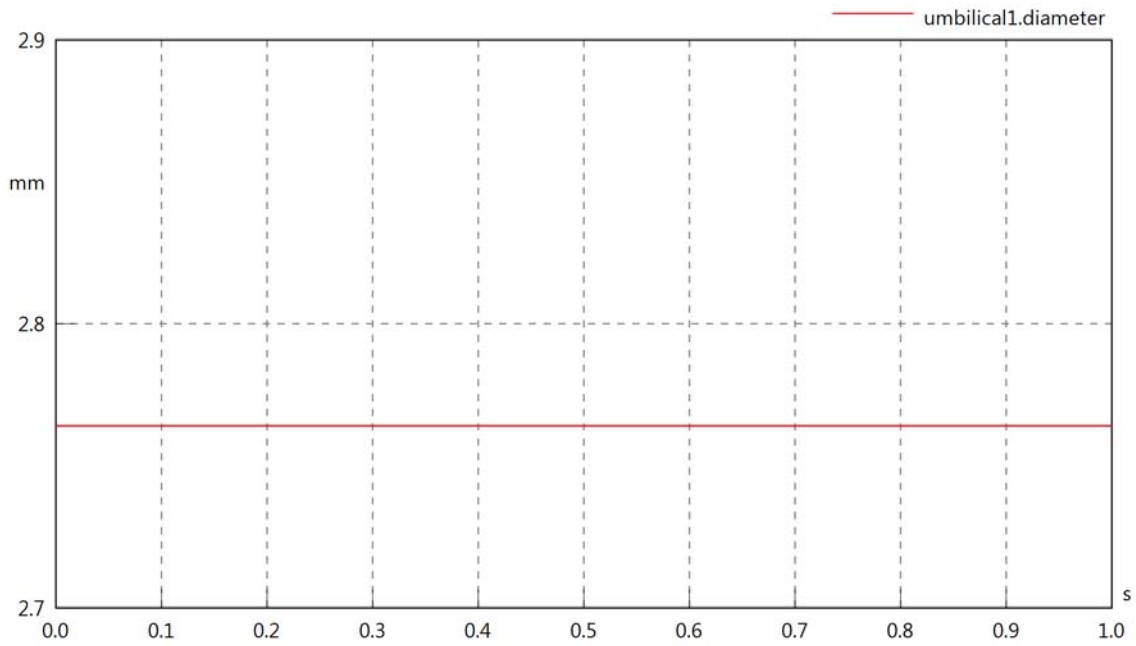

umbilical1.resistivity

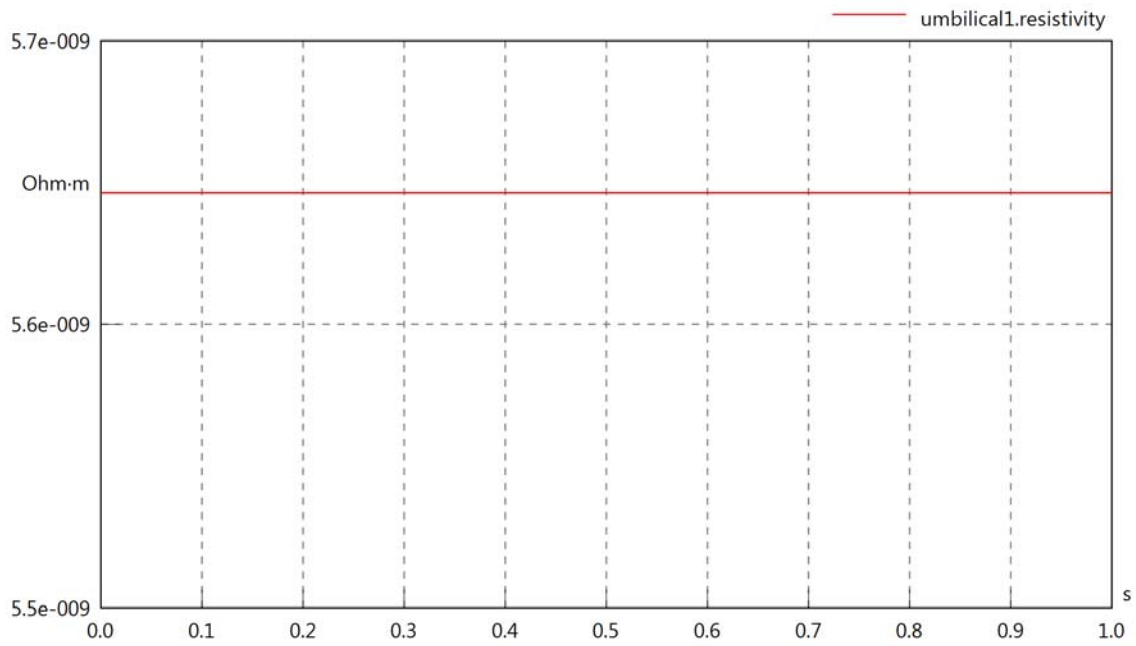

umbilical1.rInternal

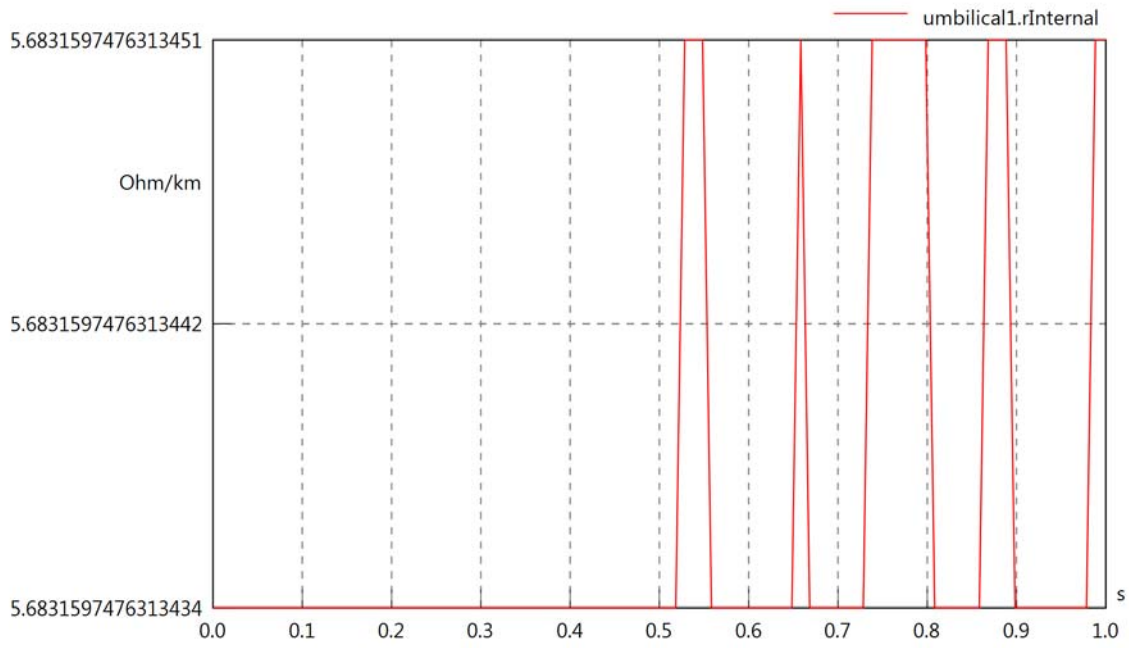

umbilical1.VrmsIn

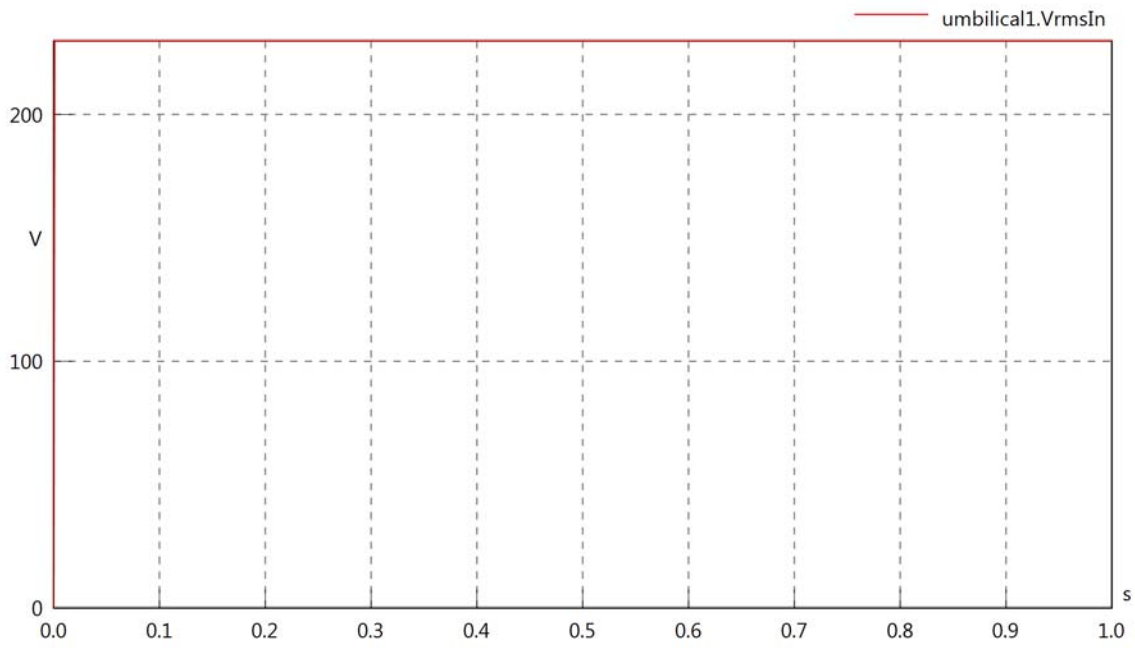

umbilical1.vReIn

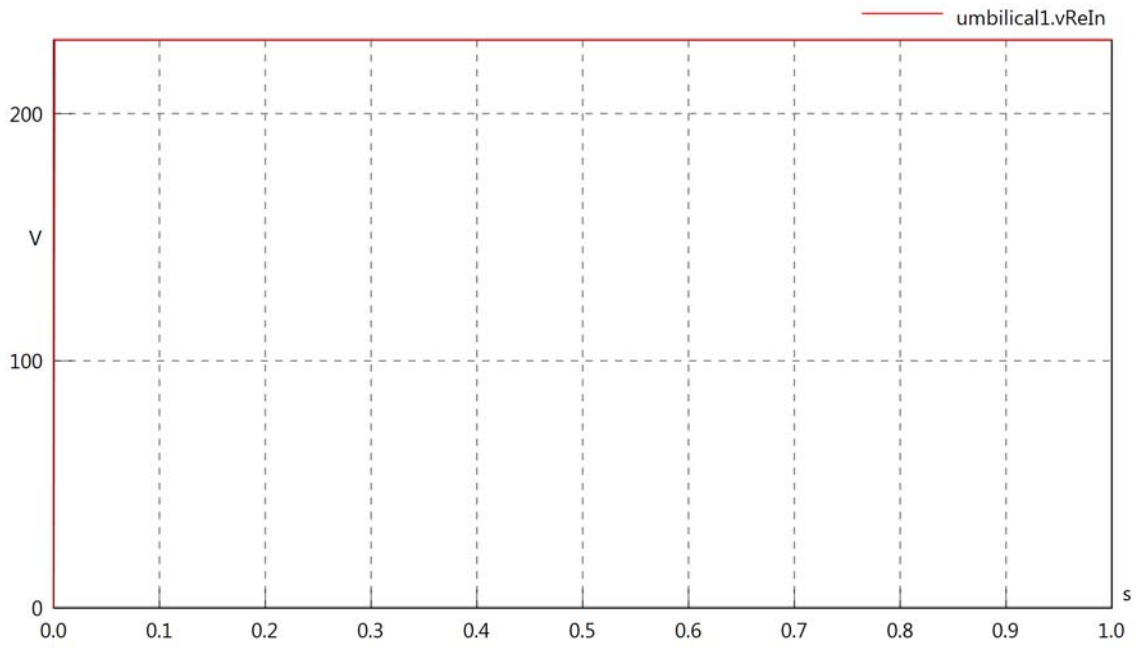

umbilical1.vImIn

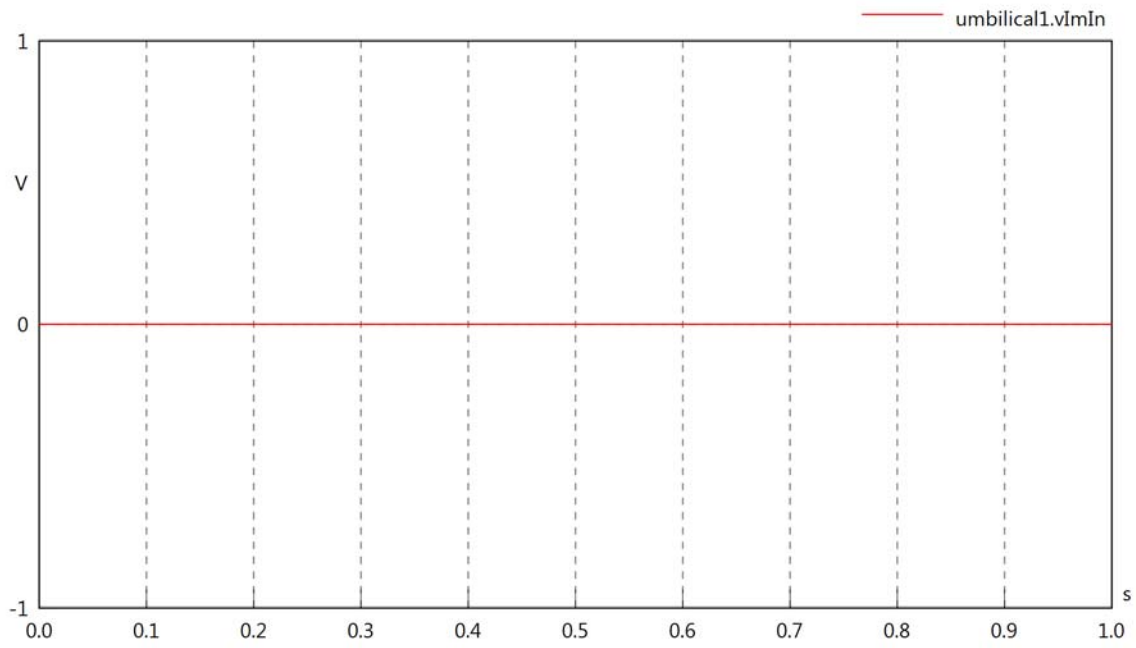

umbilical1.VrmsOut

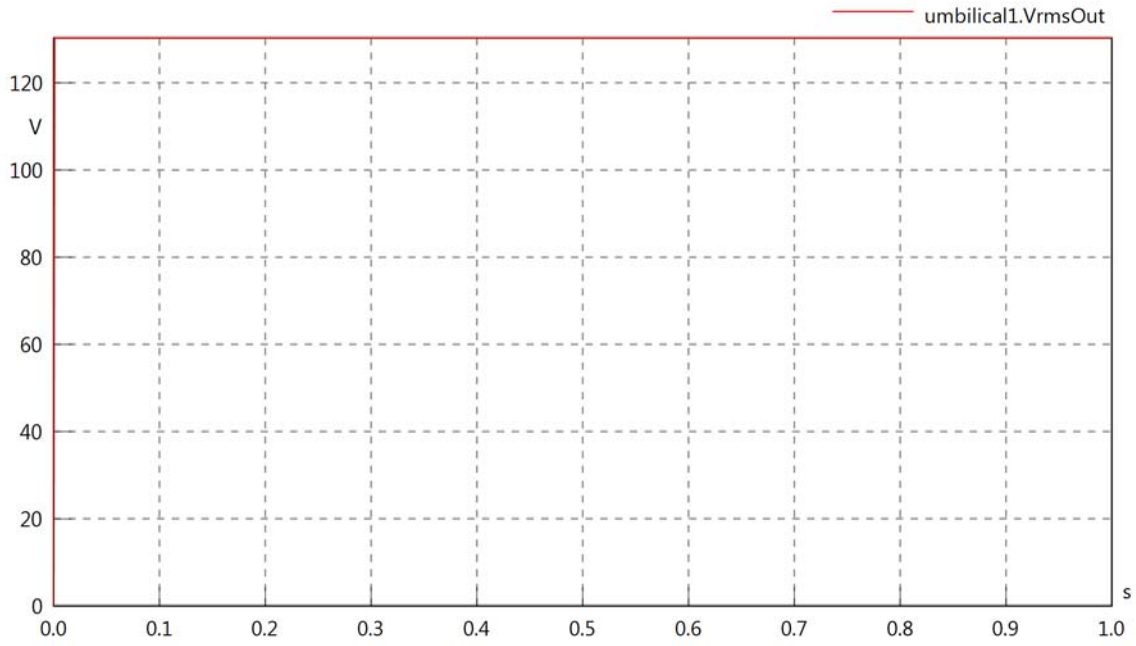

umbilical1.vReOut

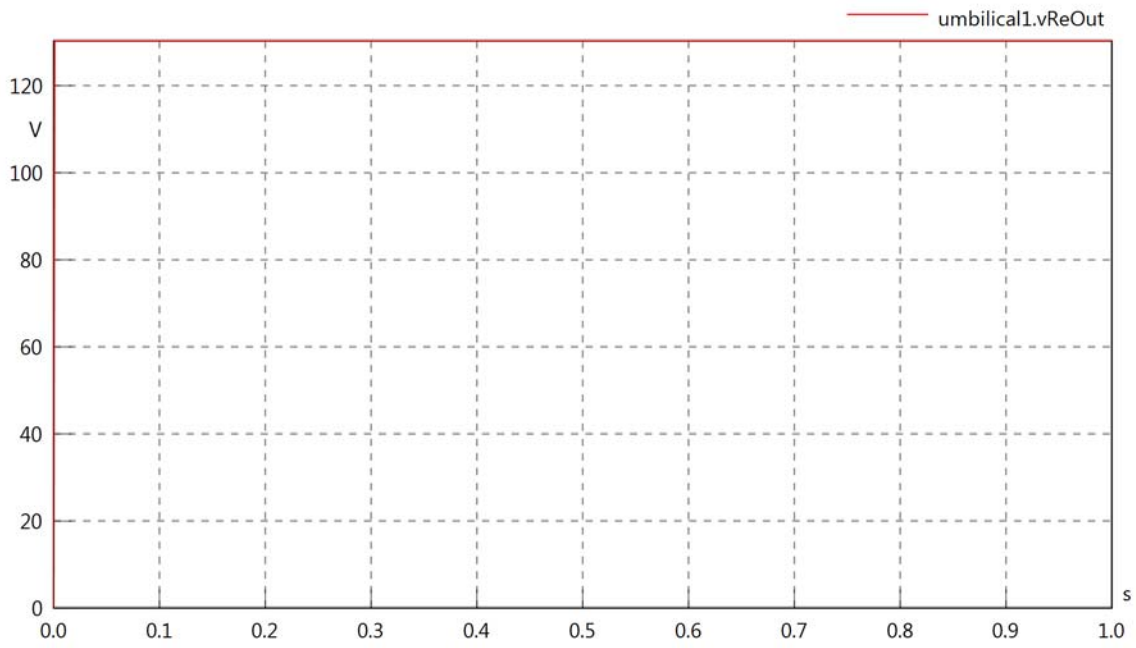

umbilical1.vImOut

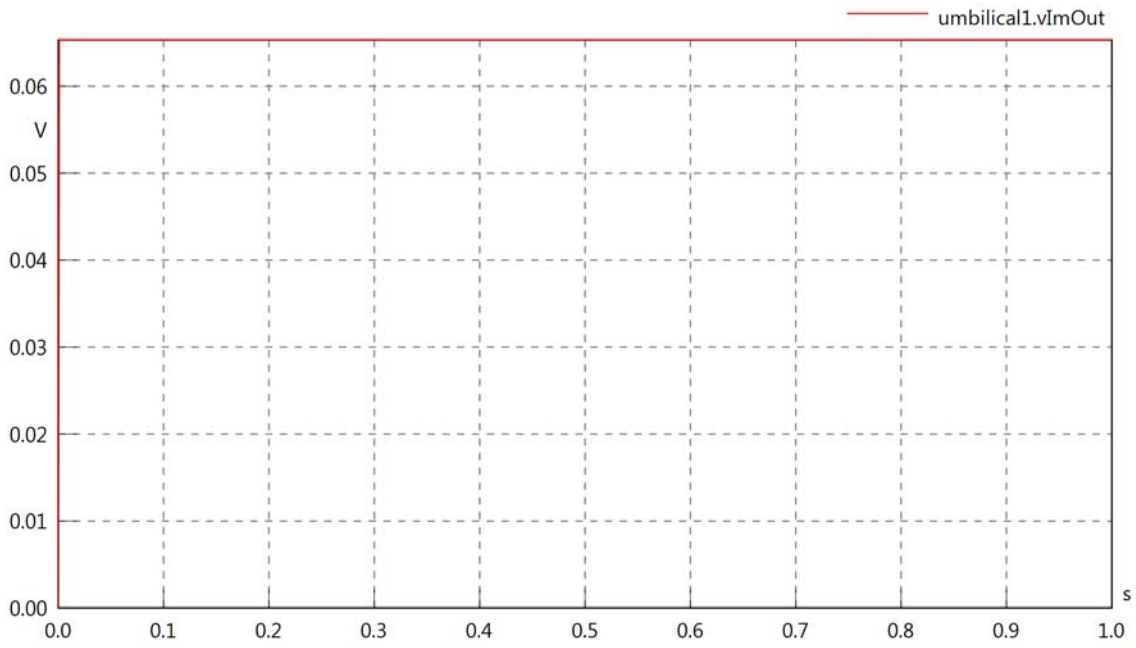

umbilical1.Vrms

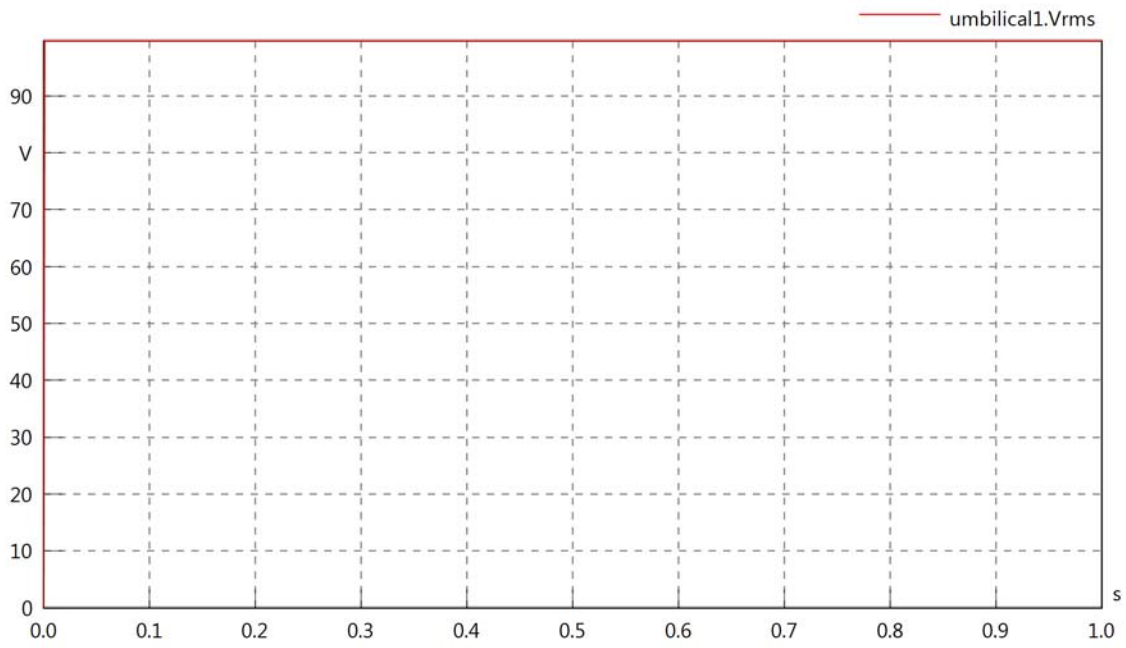

umbilical1.vRe

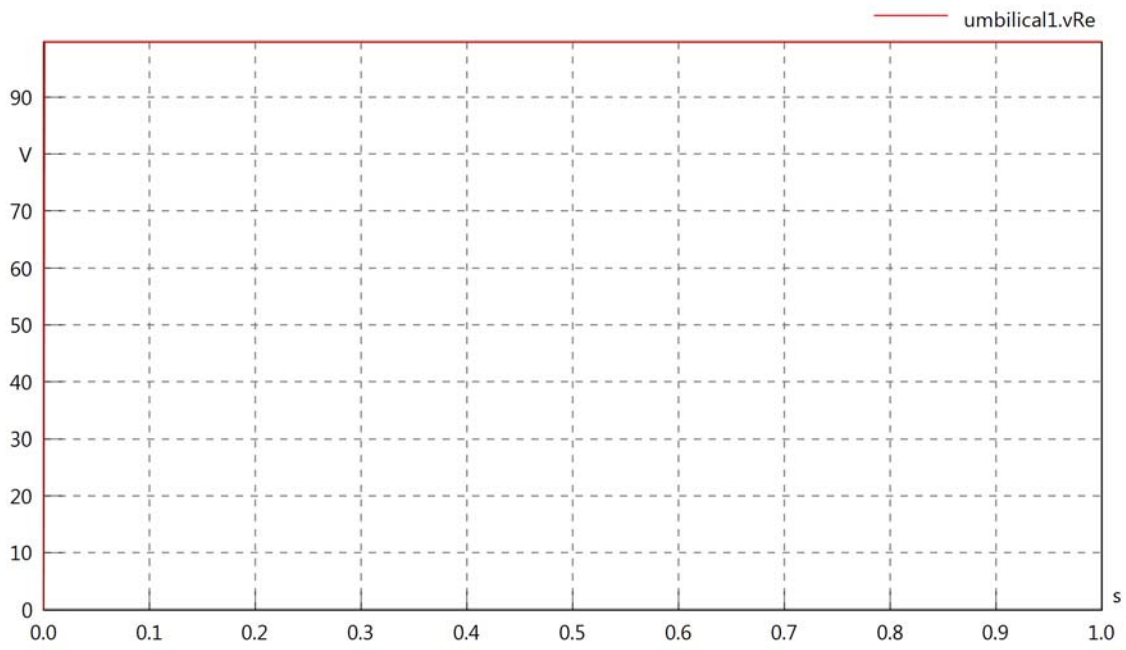

umbilical1.vIm

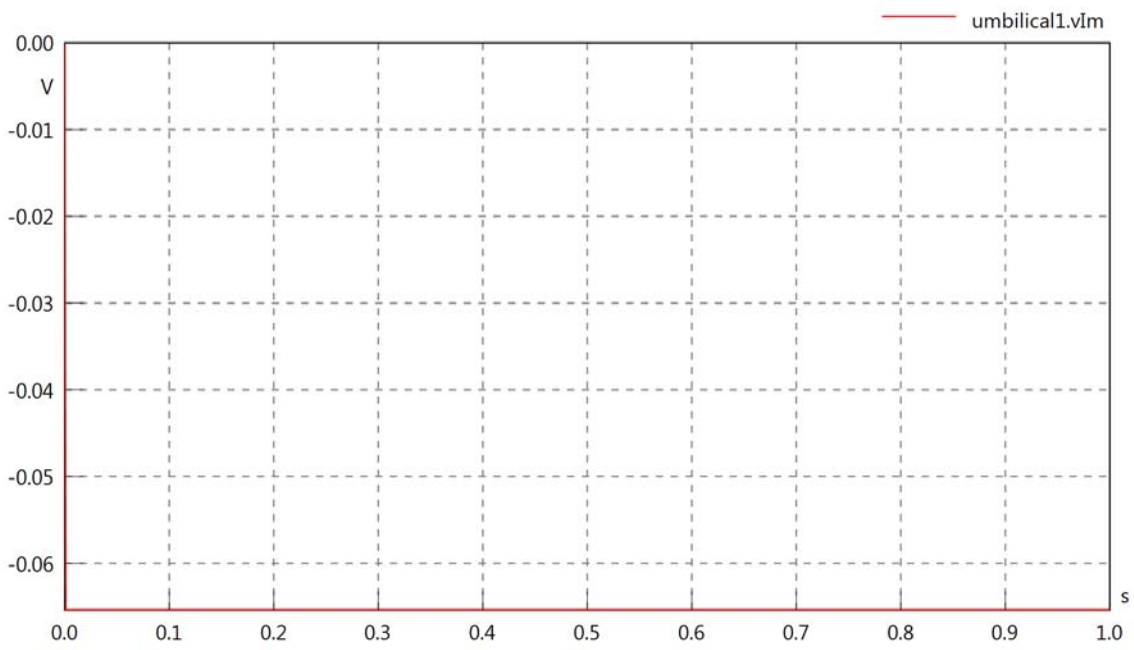

umbilical1.IrmsIn

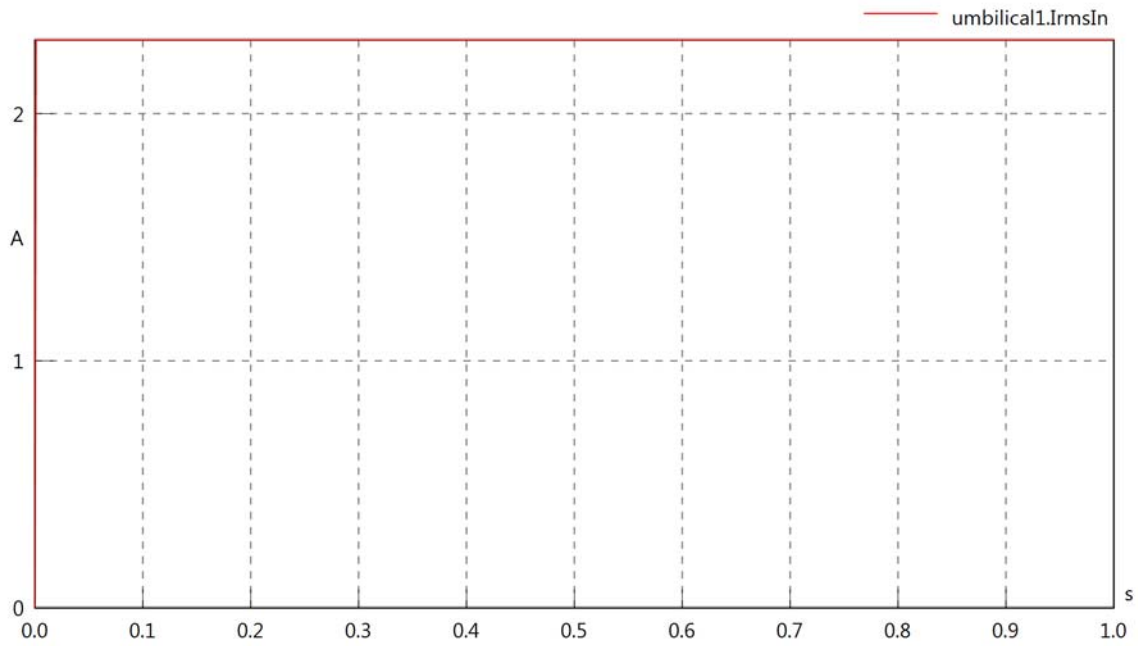

umbilical1.iReIn

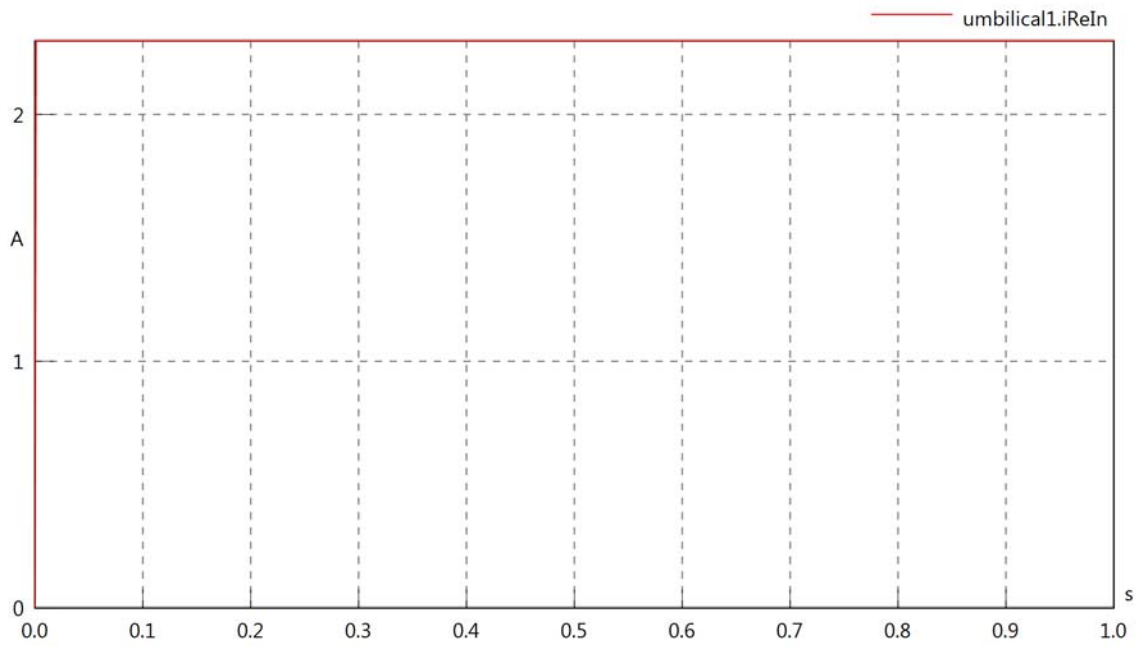

umbilical1.iImIn

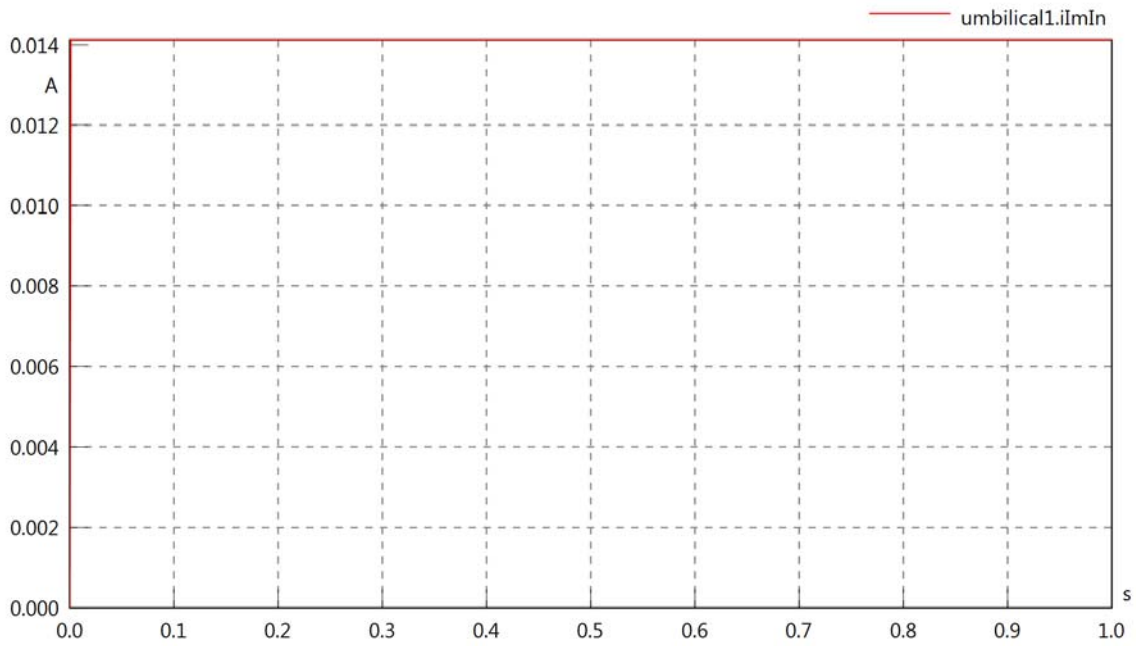

umbilical1.IrmsOut

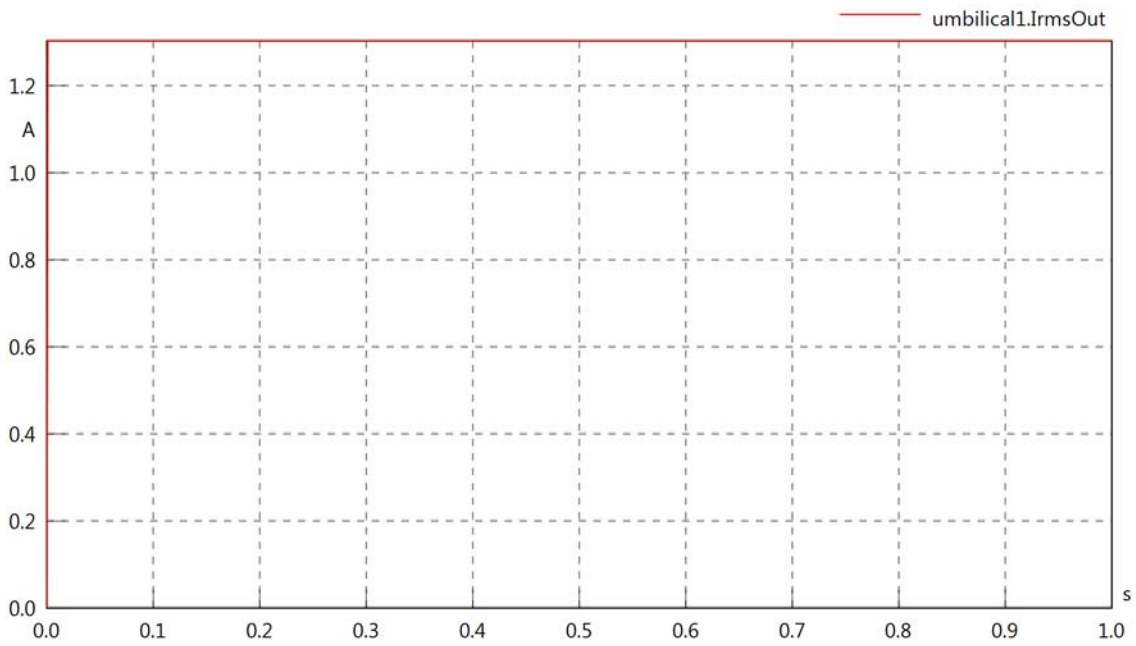

umbilical1.iReOut

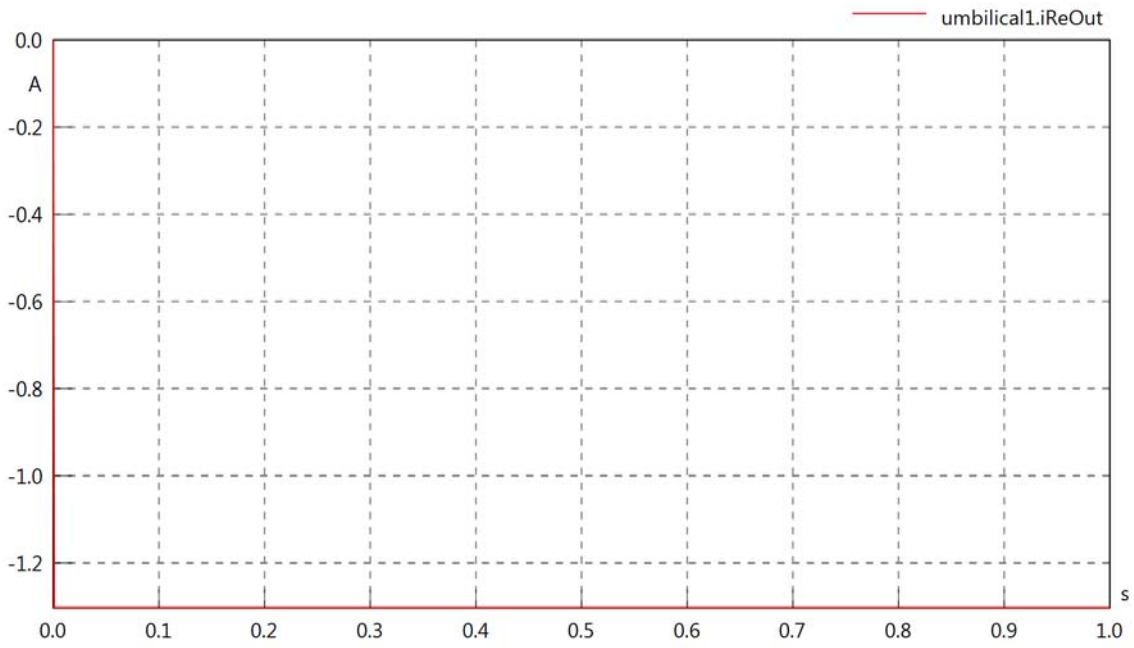

umbilical1.iImOut

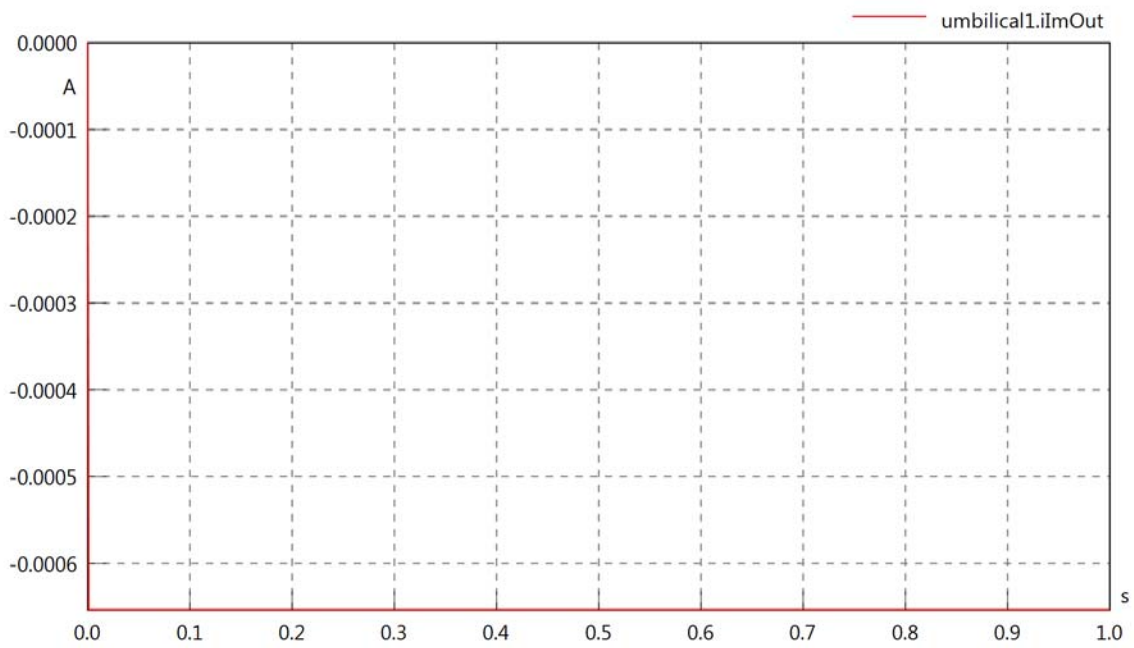

umbilical1.phiVIn

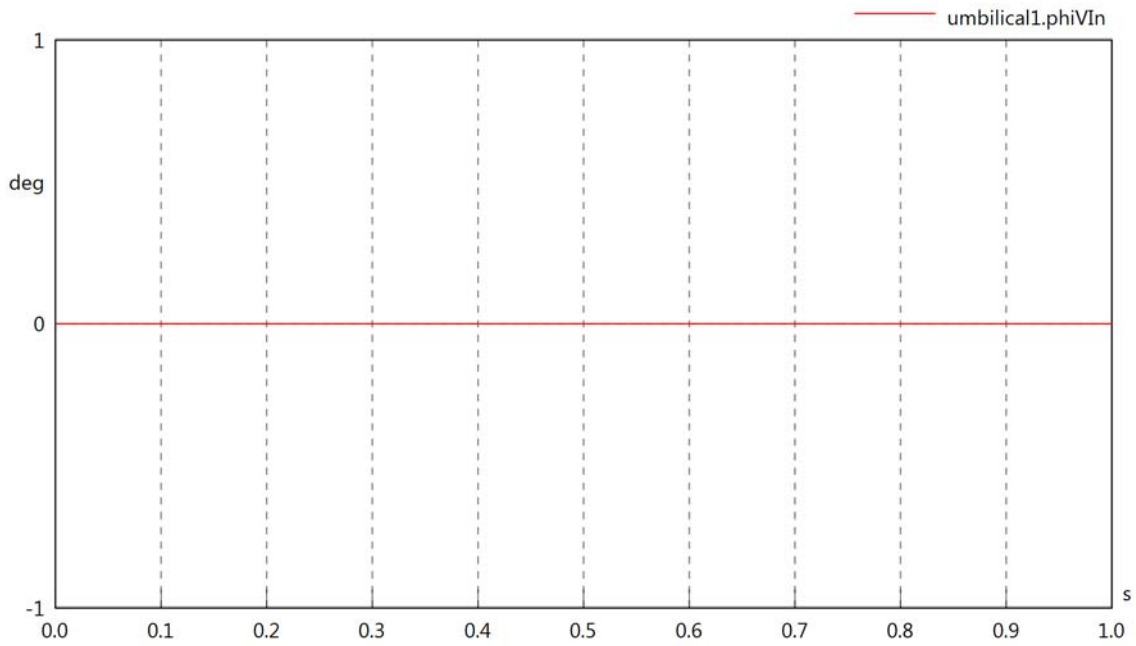

umbilical1.phiIIIn

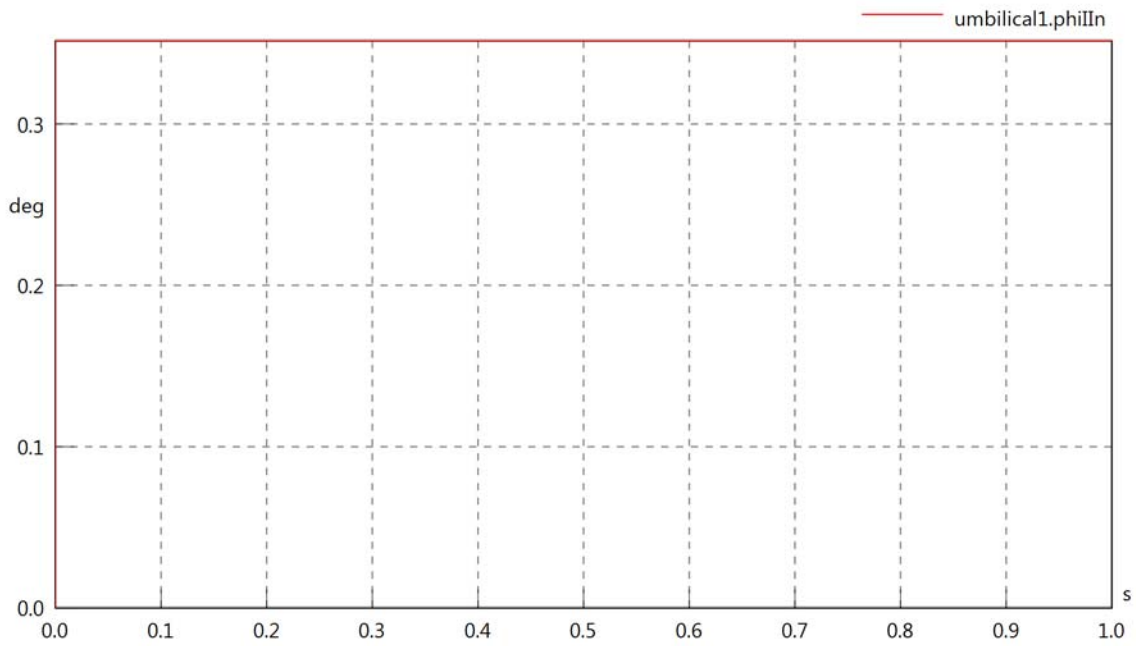

umbilical1.phiIVIn

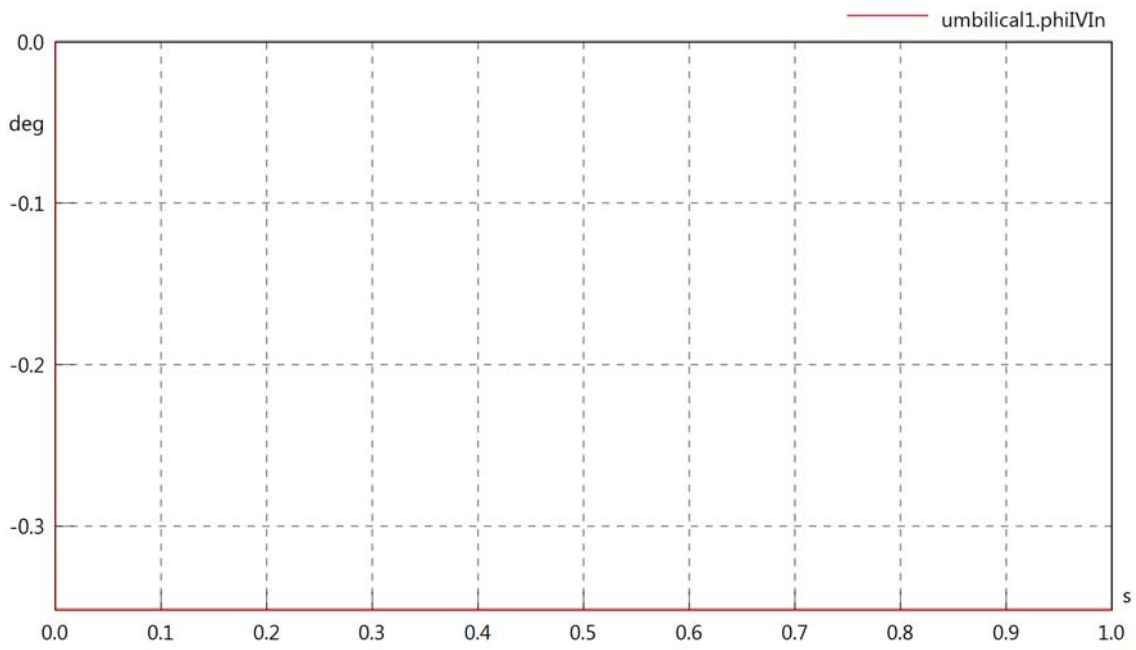

umbilical1.phiVOut

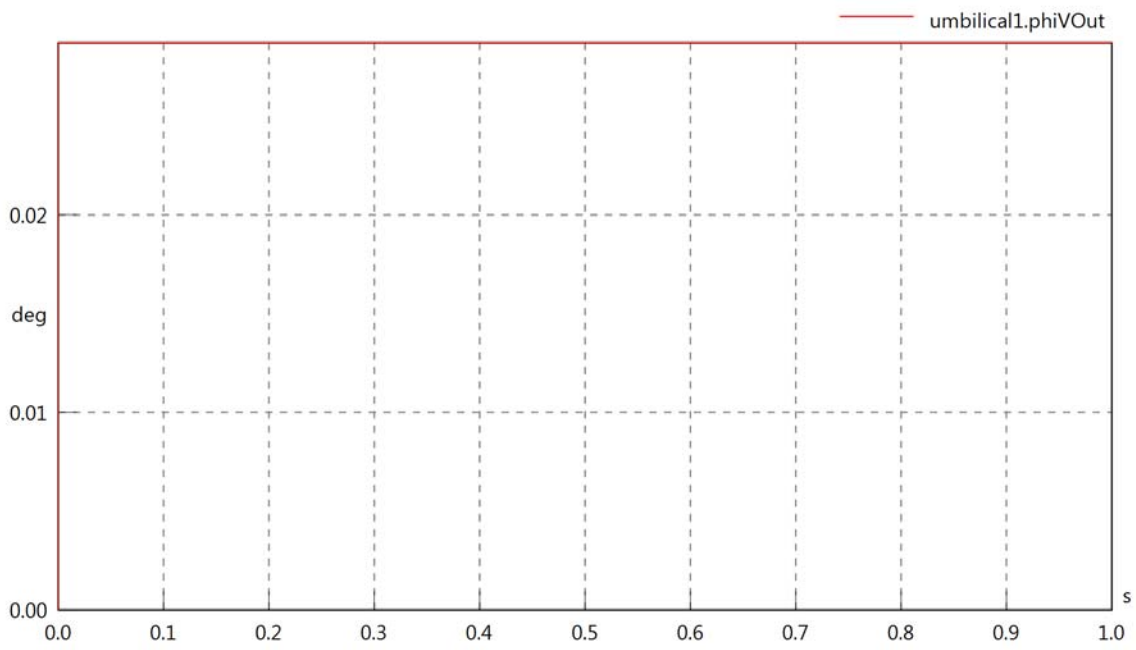

umbilical1.phiIOut

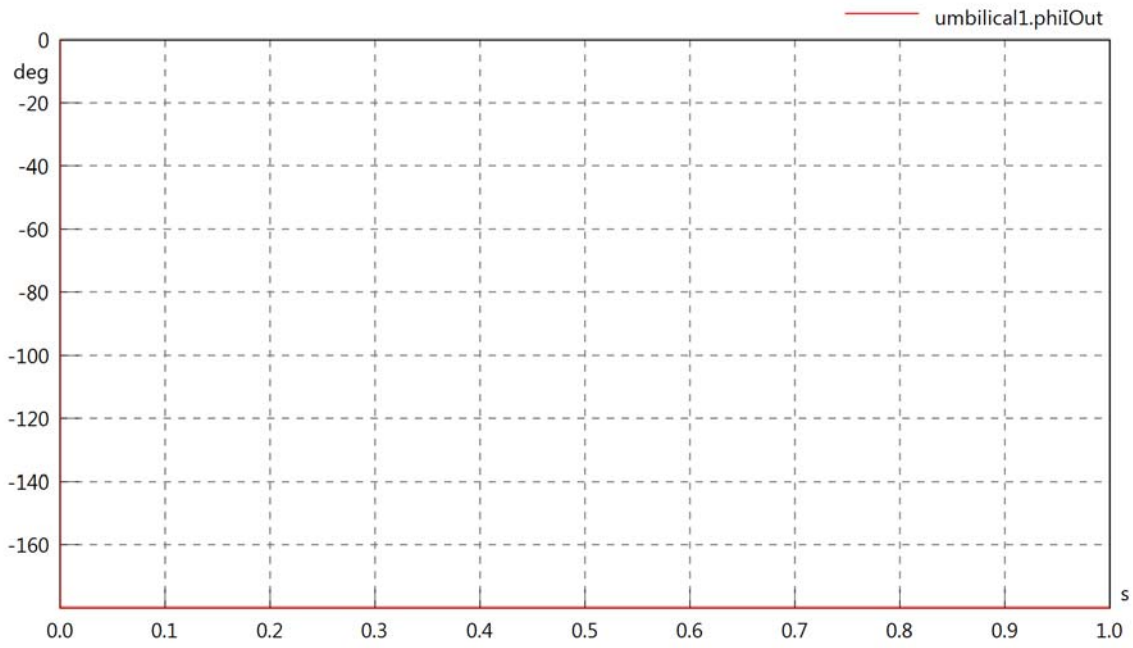

umbilical1.phiIVOut

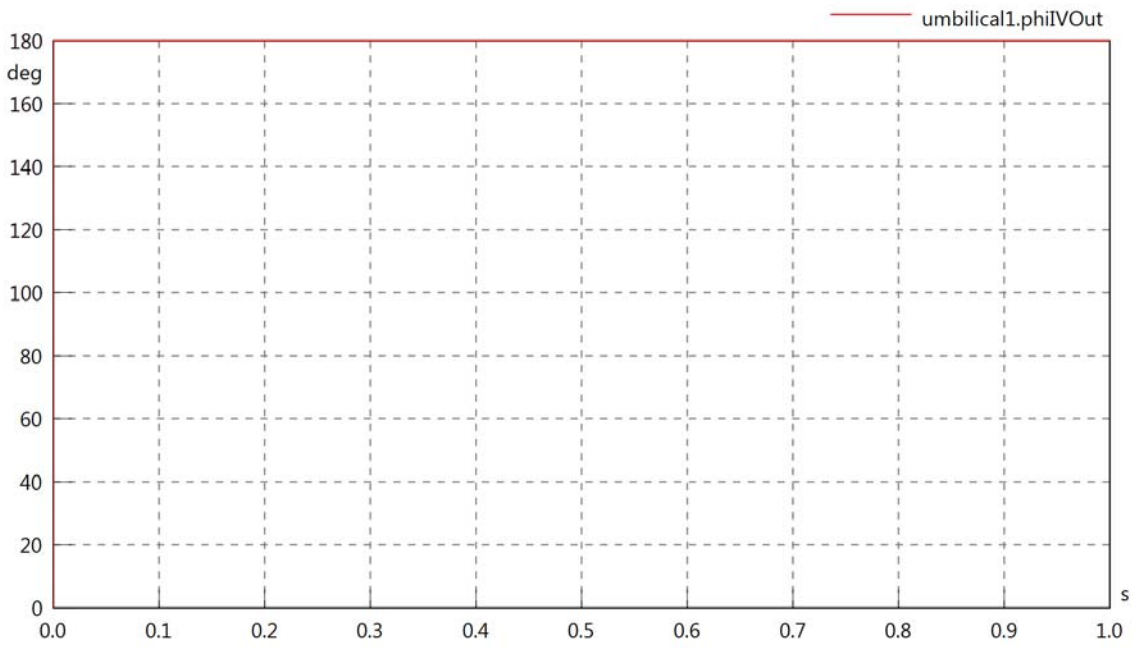

umbilical1.phiVL1

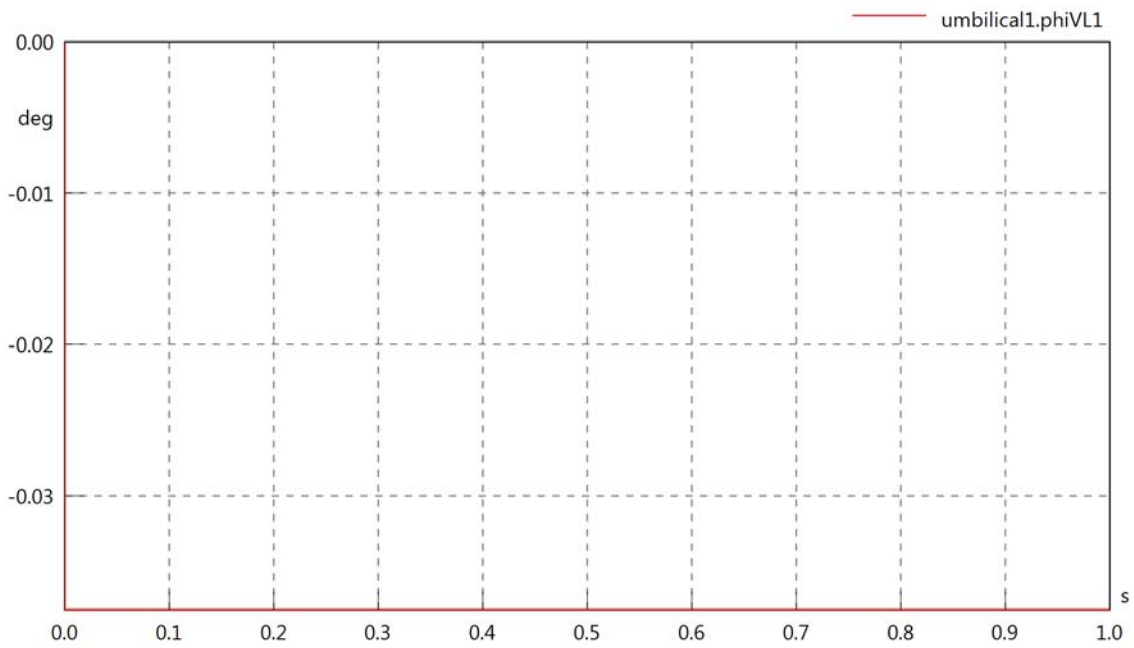

umbilical1.phiIL1

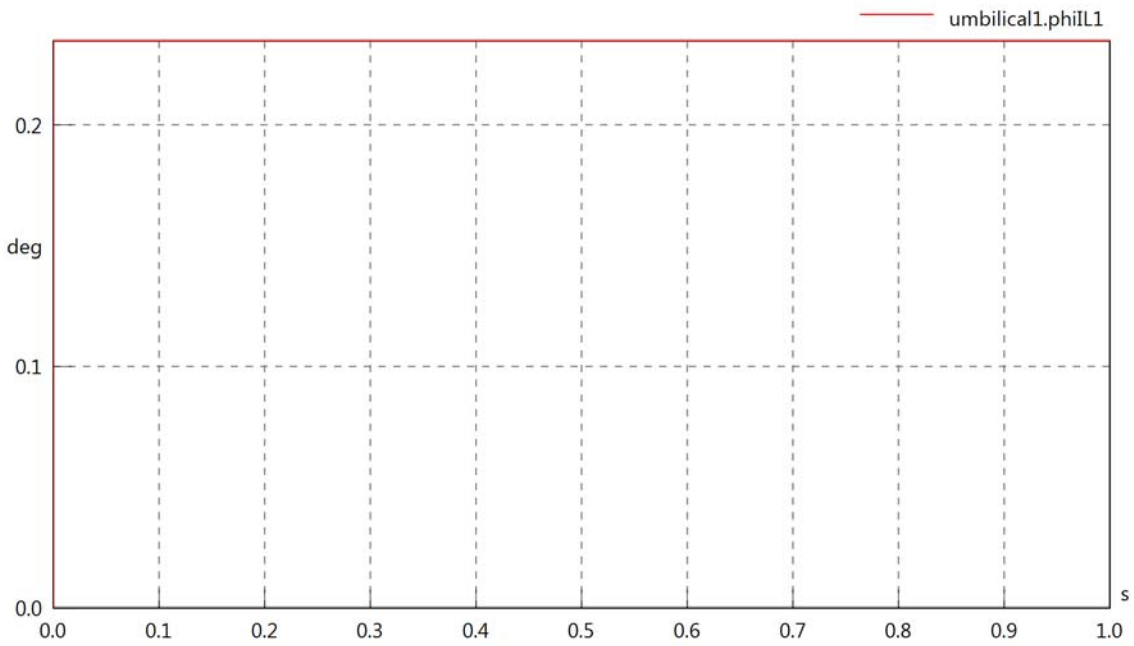

umbilical1.phiIVL1

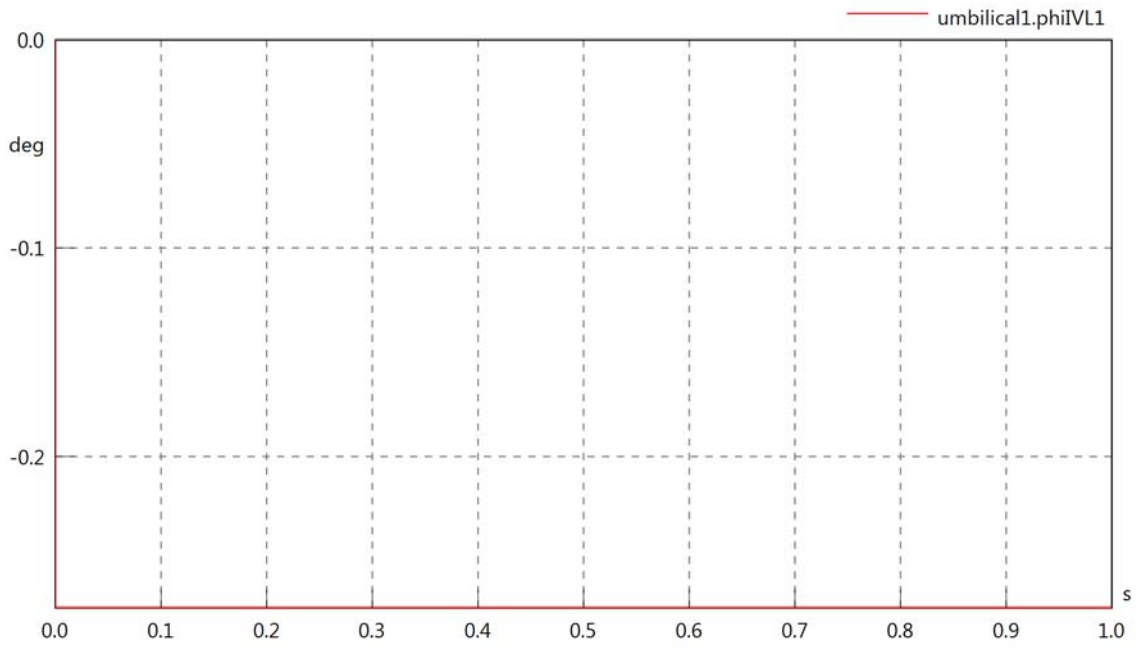

umbilical1.PReIn

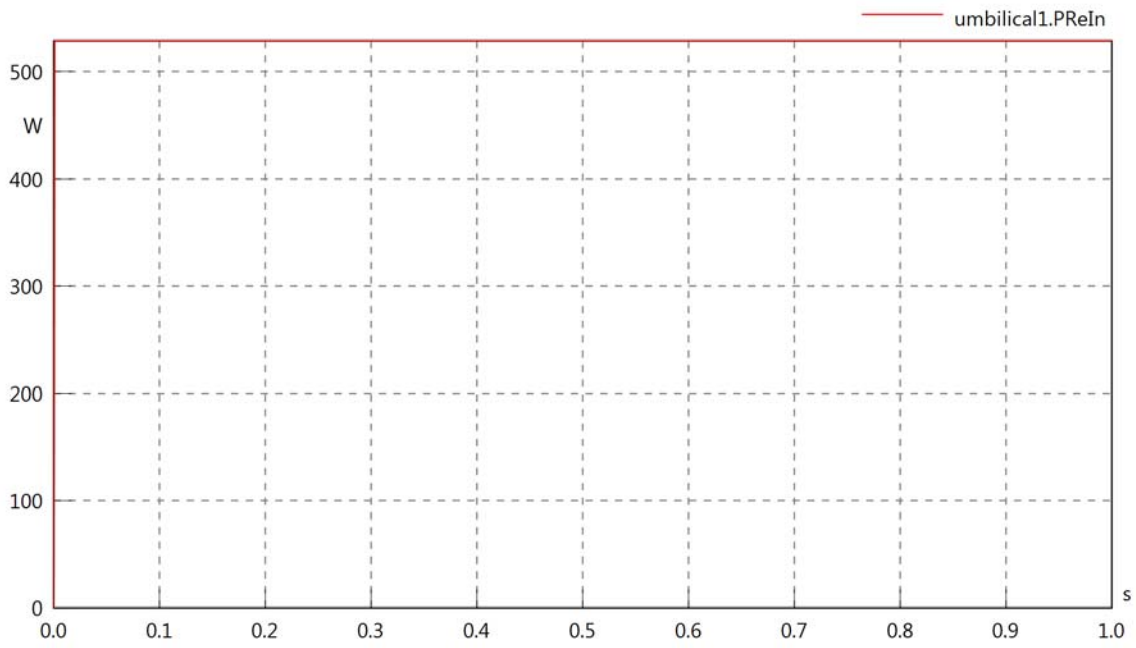

umbilical1.PImIn

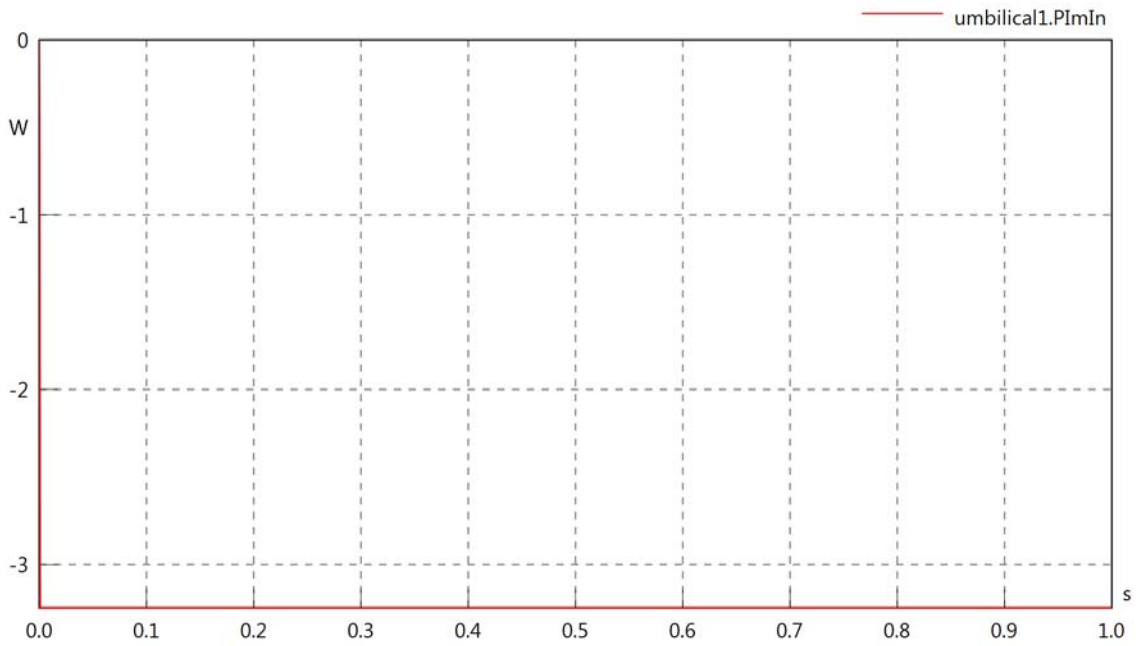

umbilical1.SIn

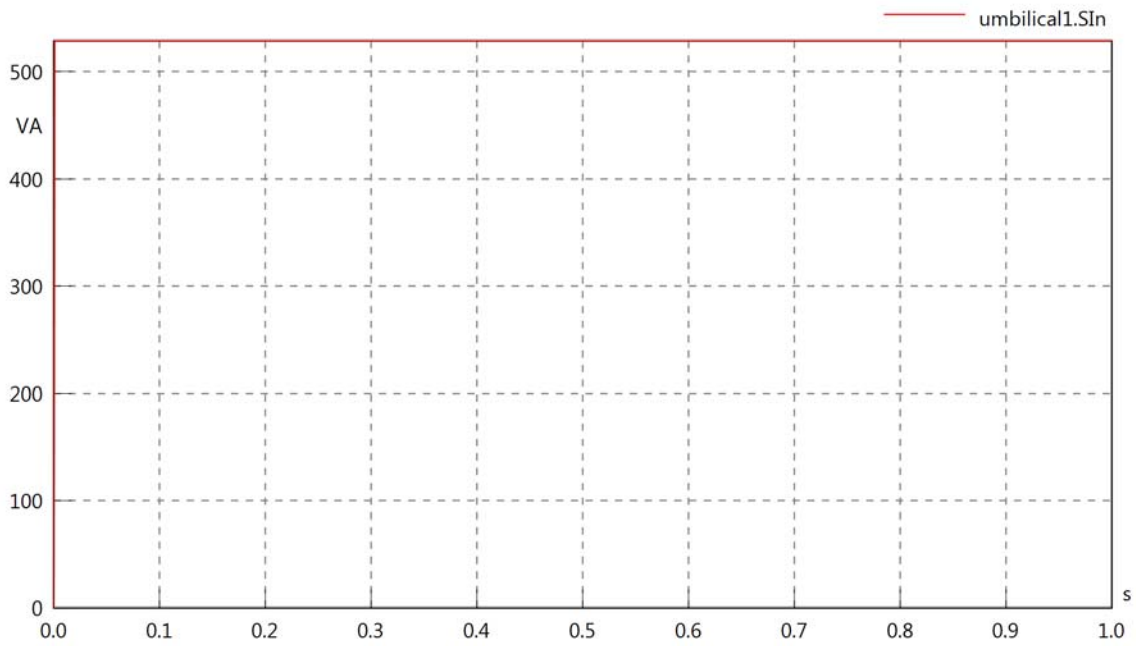

umbilical1.PReOut

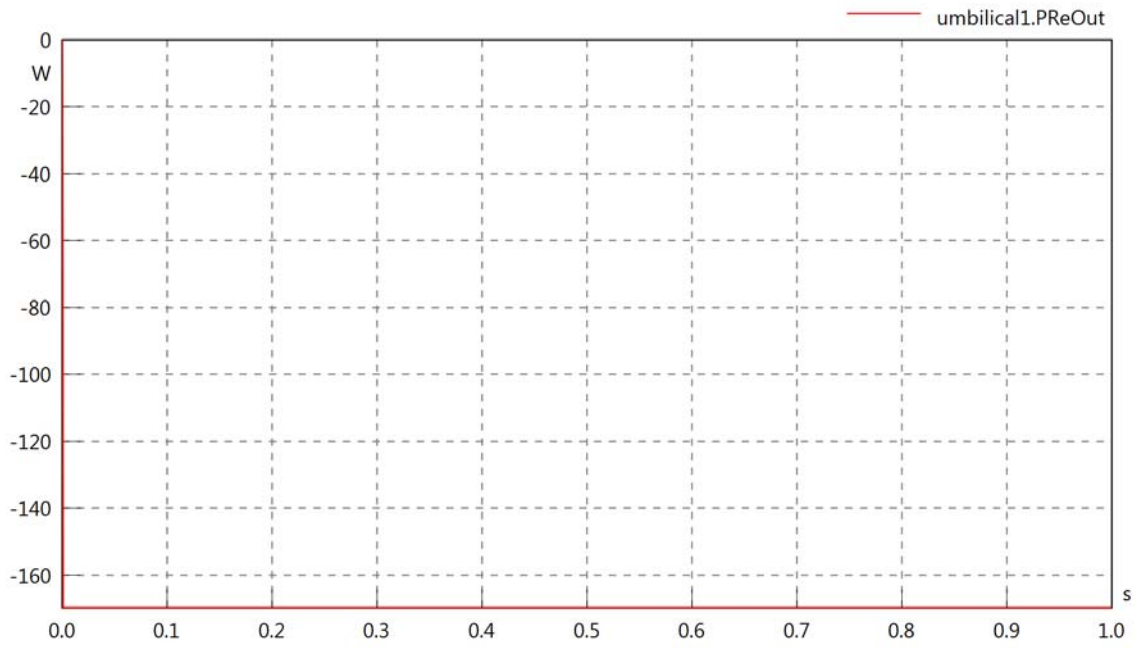

umbilical1.PImOut

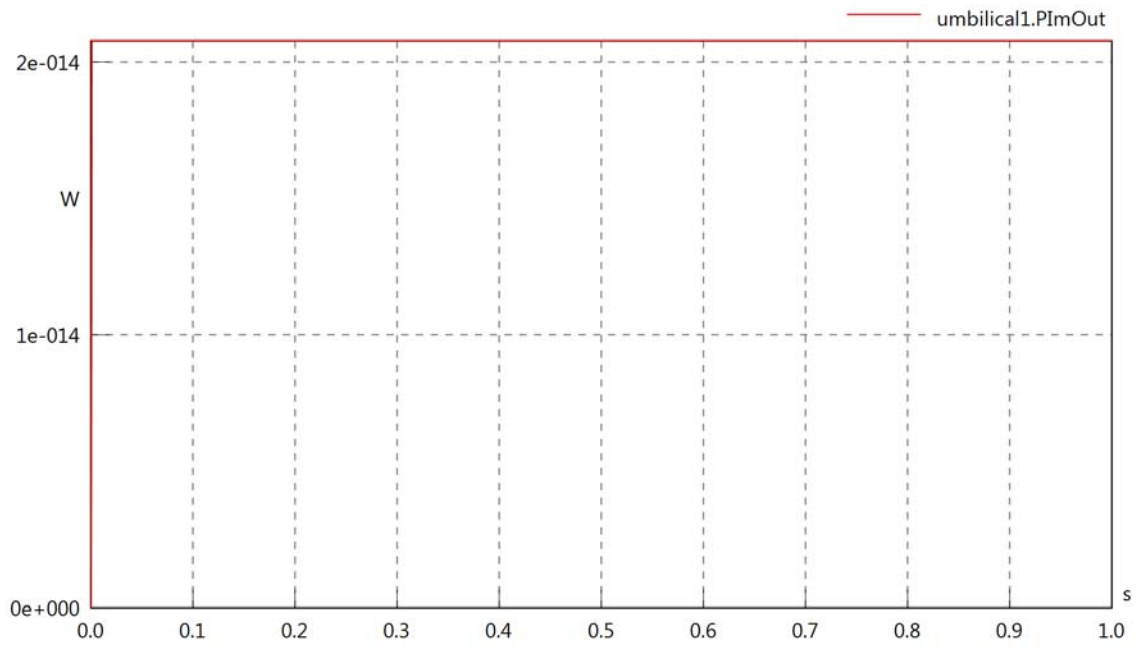

umbilical1.SOut

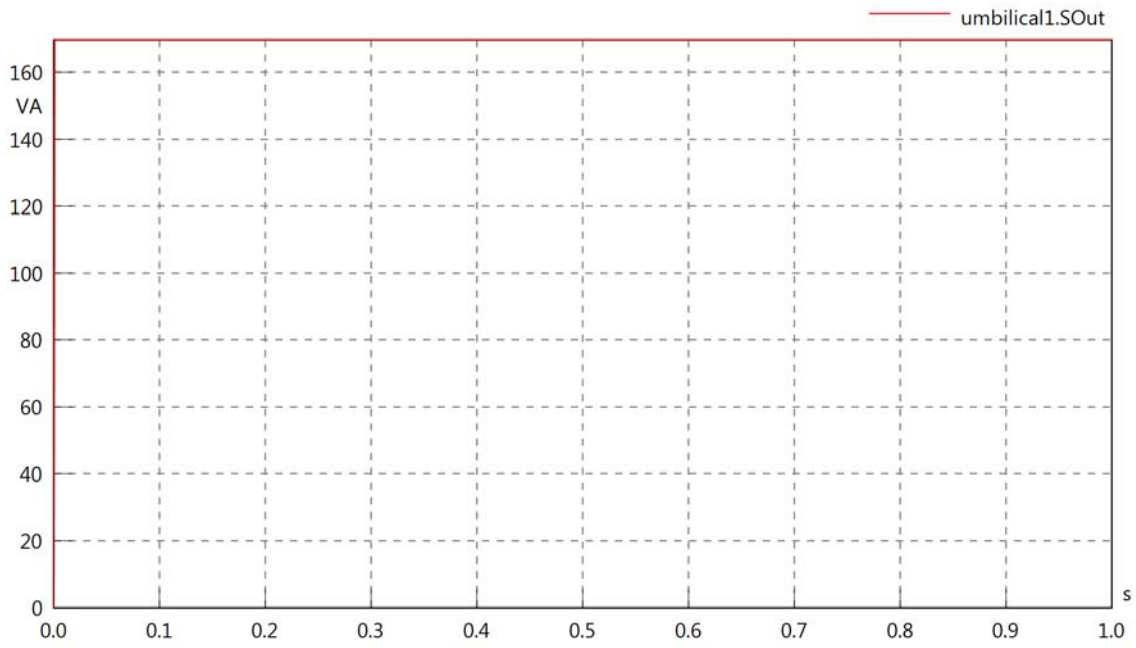

umbilical1.PRe

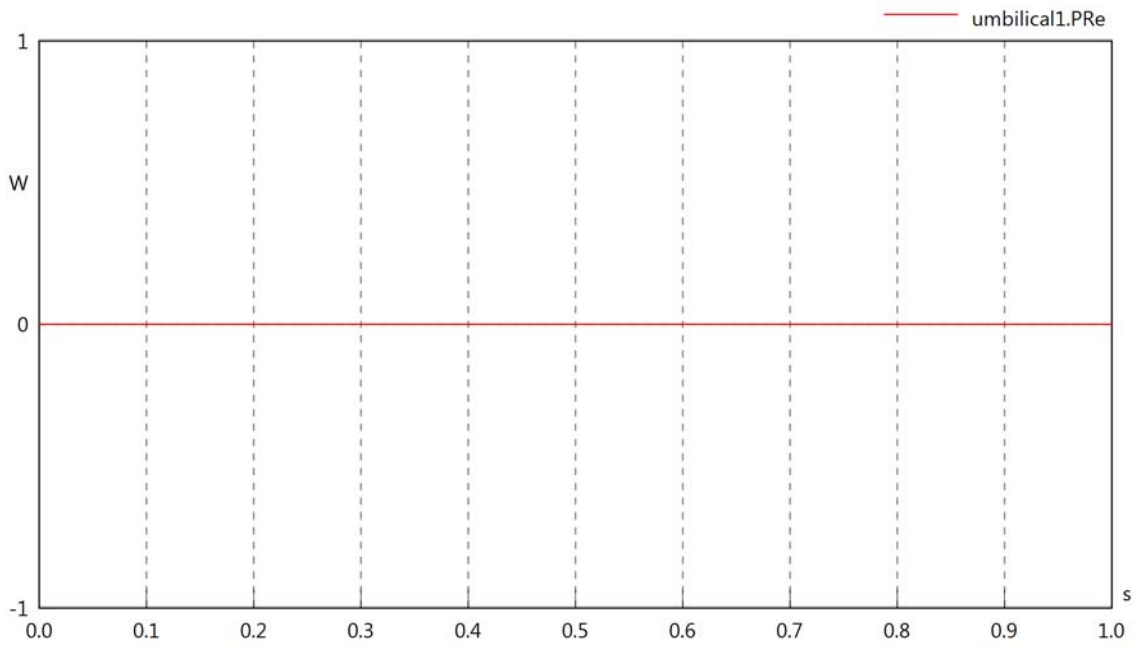

umbilical1.PIm

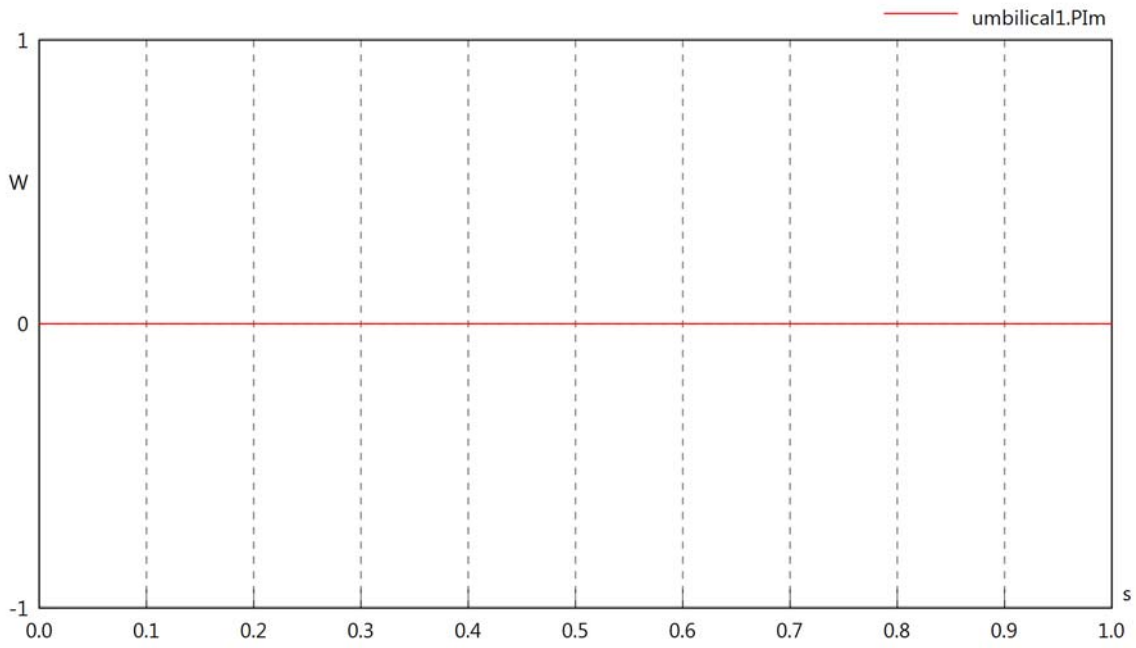

umbilical1.S

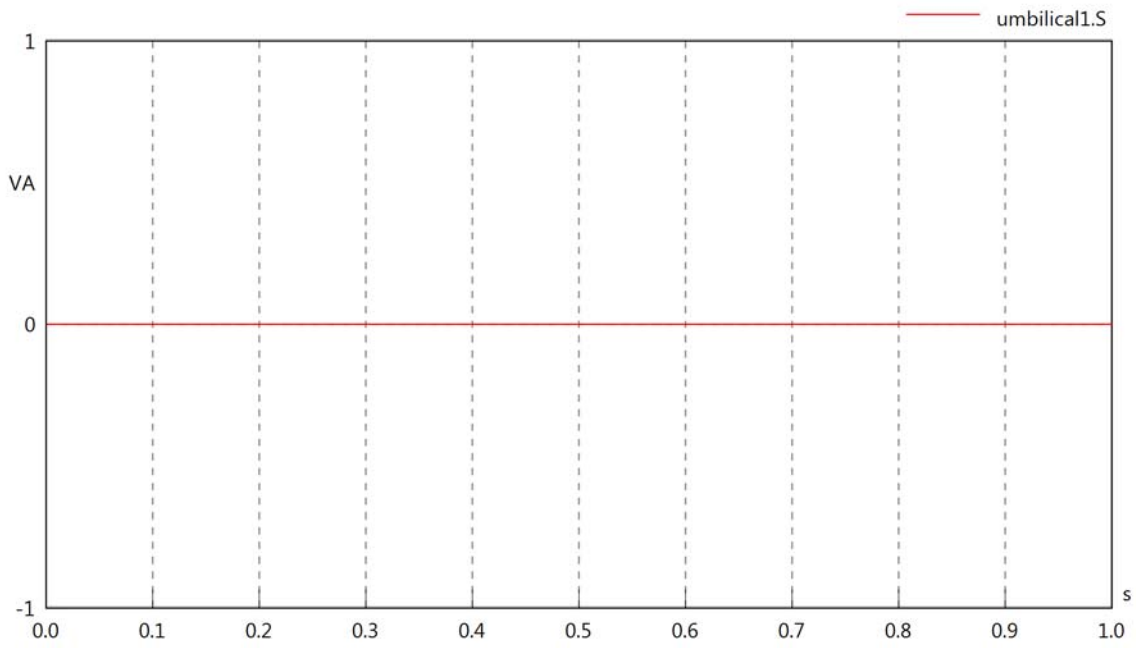

umbilical1.dB

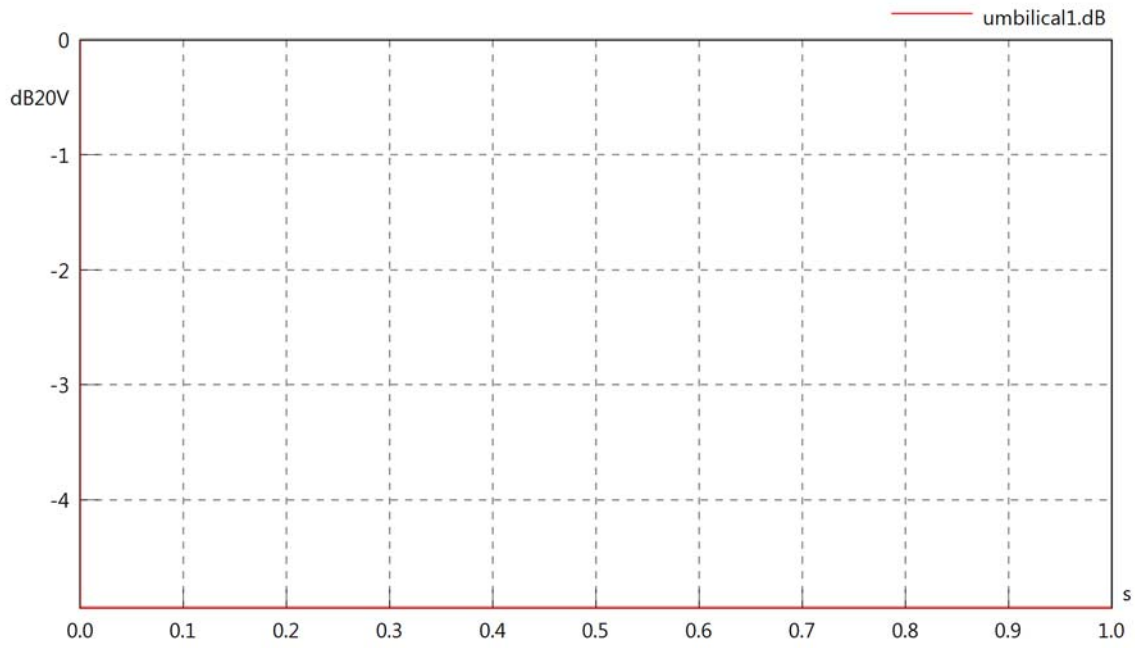
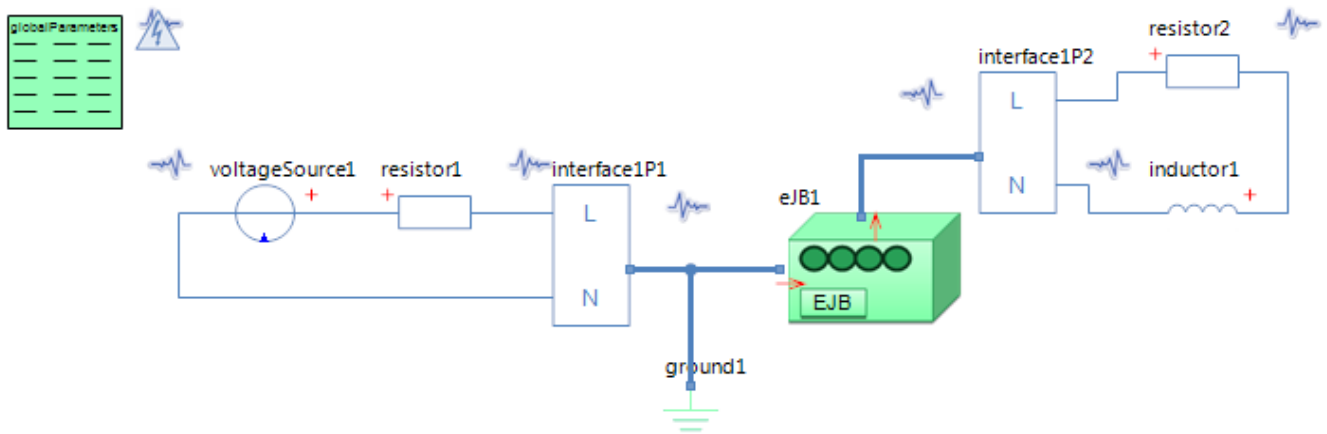

Diagram View



GlobalParameters globalParameters
Parameters

Comment	Name	Current Value	Unit
Type of Calculation	eCalculationKind	Signal Calculation	
Description of Frequency	eFrequencyKind	Linear	
Minimum Frequency	fMin	60	[Hz]
Maximum Frequency	fMax	60	[Hz]

Voltage Source voltageSource1
Parameters

Comment	Name	Current Value	Unit
Voltage RMS	VrmsSrc	230	[V]
Phase	phi	0	[deg]

Resistor resistor1
Parameters

Comment	Name	Current Value	Unit
Resistance	R	100	[Ohm]

Resistor resistor2
Parameters

Comment	Name	Current Value	Unit
Resistance	R	100	[Ohm]

Electrical Junction Box eJB1
Parameters

Comment	Name	Current Value	Unit
Poor or failing L1 connection	bL1	false	

Inductor inductor1
Parameters

Comment	Name	Current Value	Unit
Inductance	L	5	[mH]

eJB1.VrmsIn

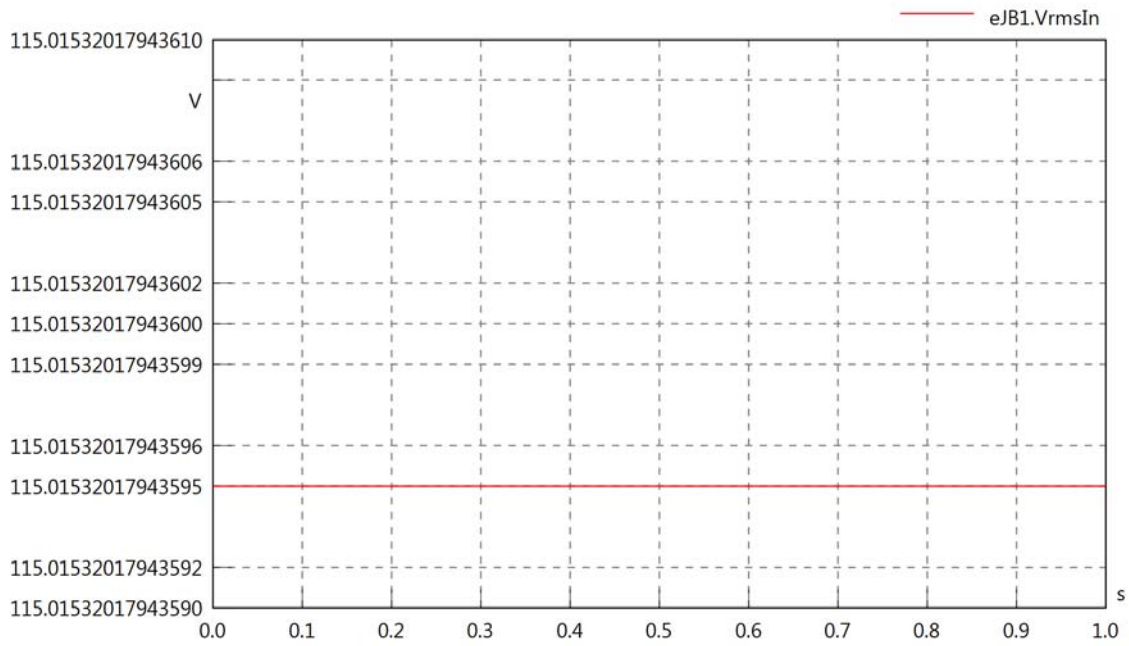

eJB1.vReIn

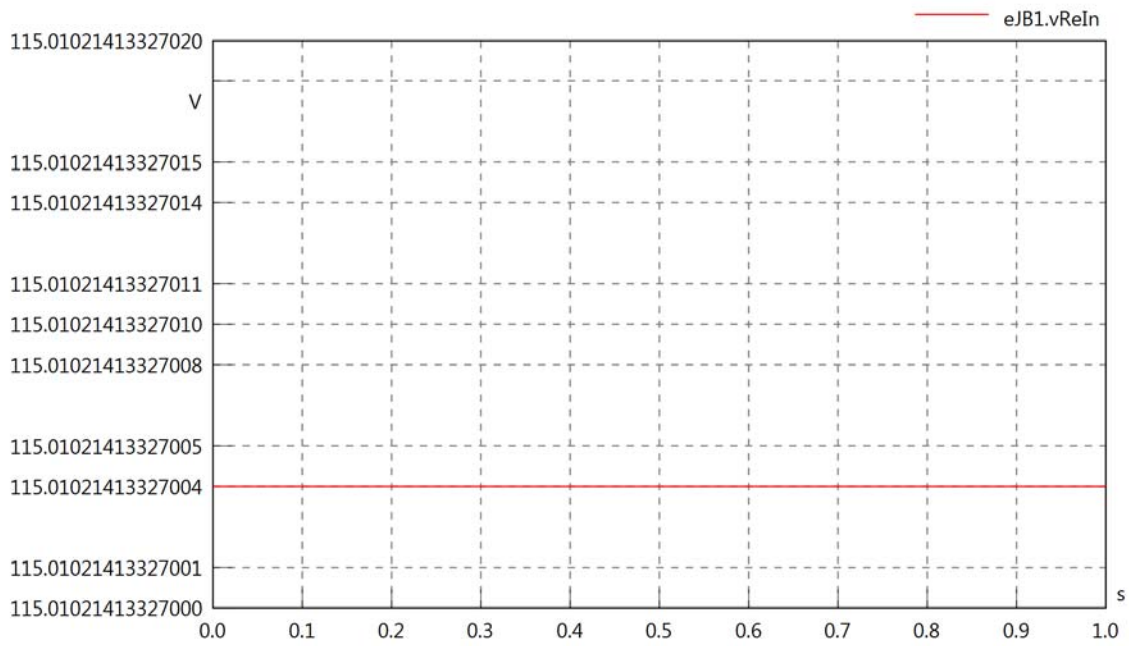

eJB1.vImIn

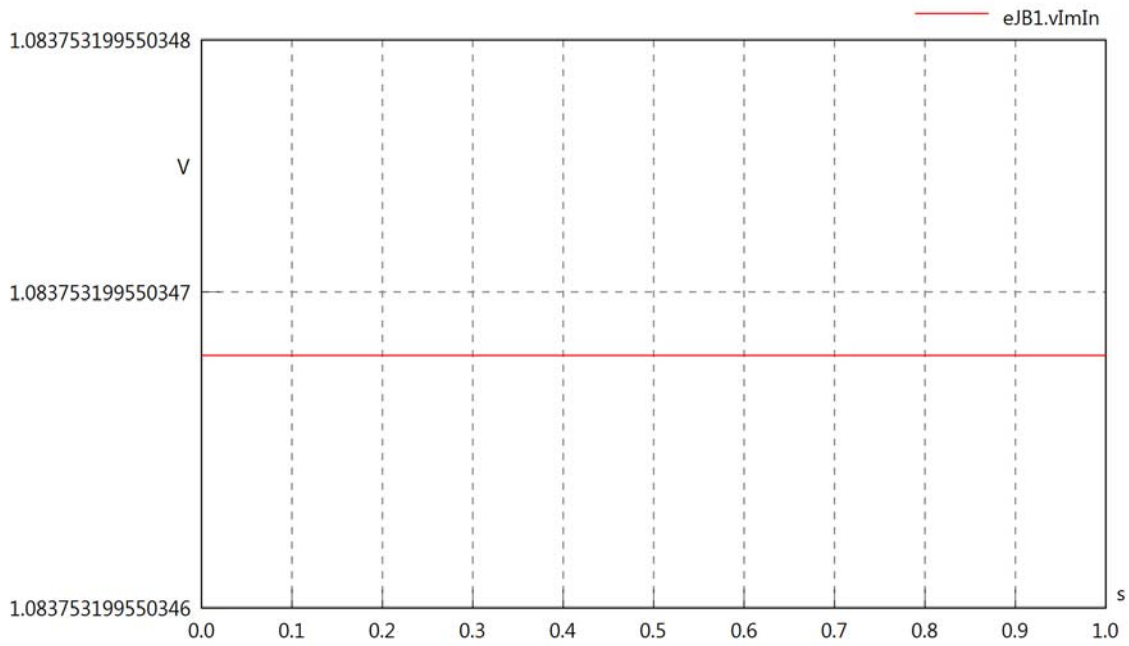

eJB1.VrmsOut

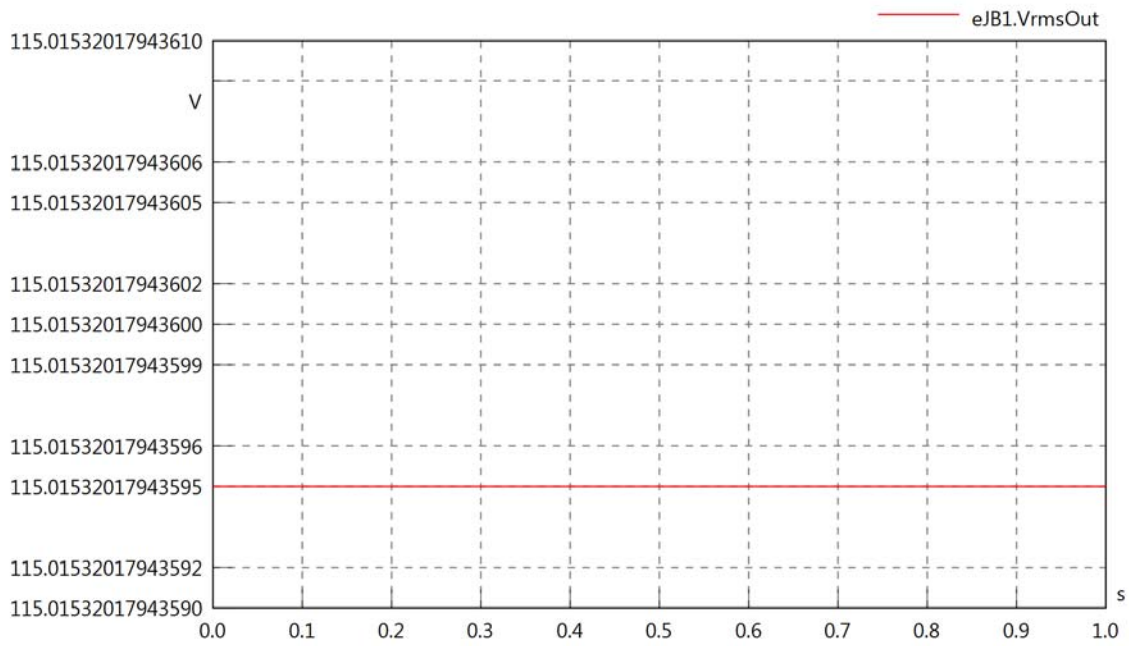

eJB1.vReOut

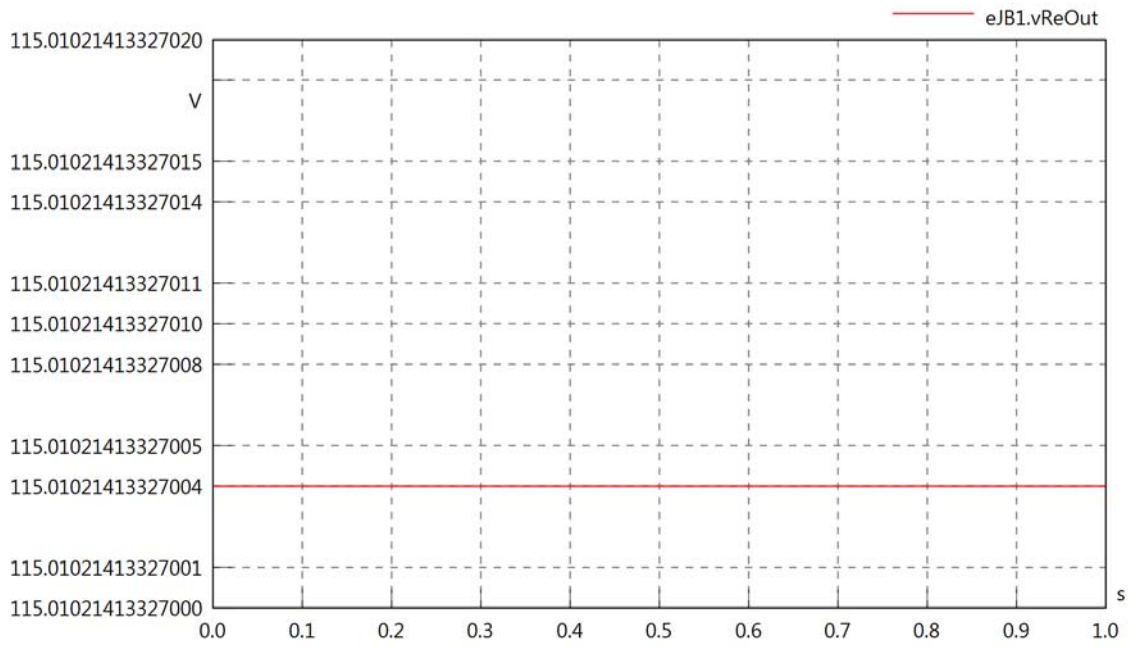

eJB1.vImOut

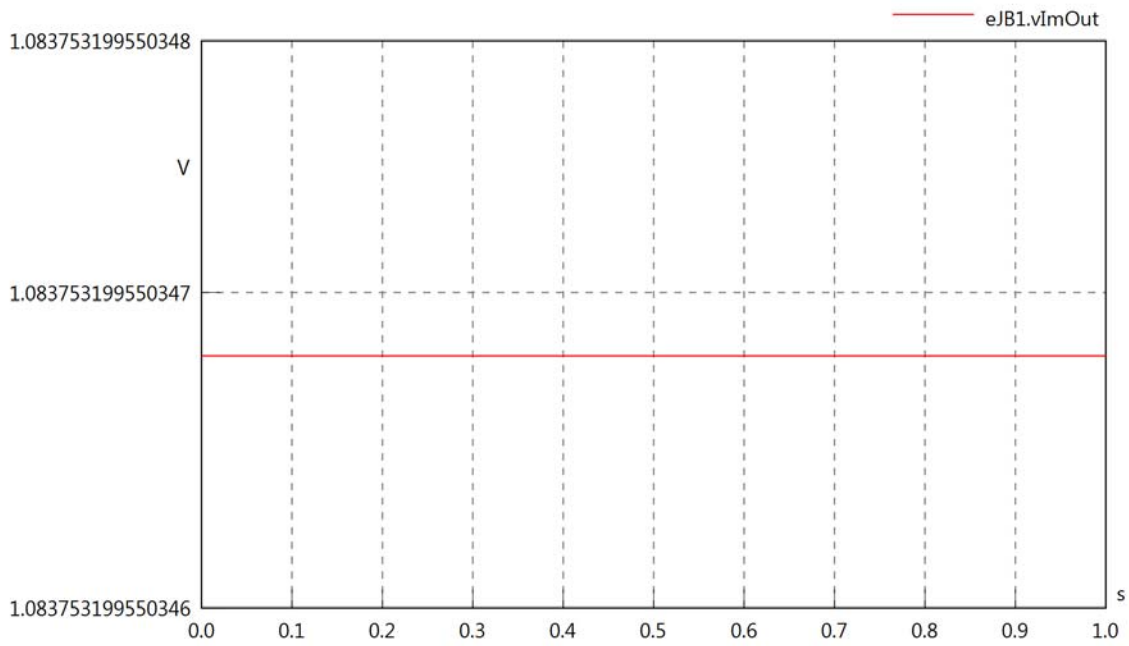

eJB1.Vrms

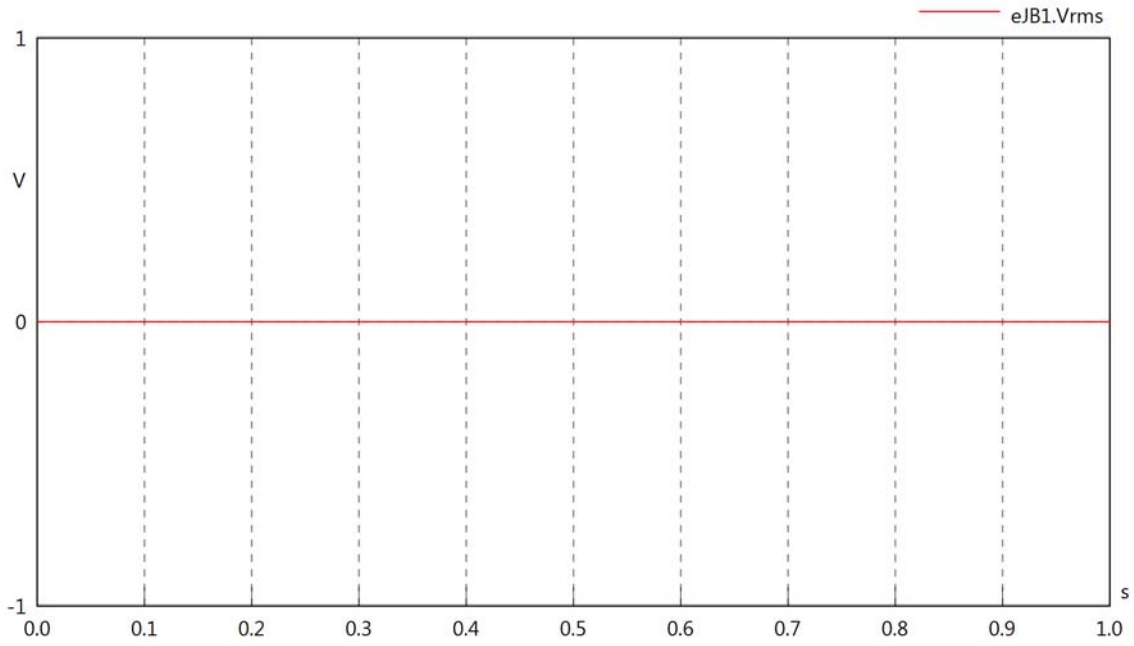

eJB1.vRe

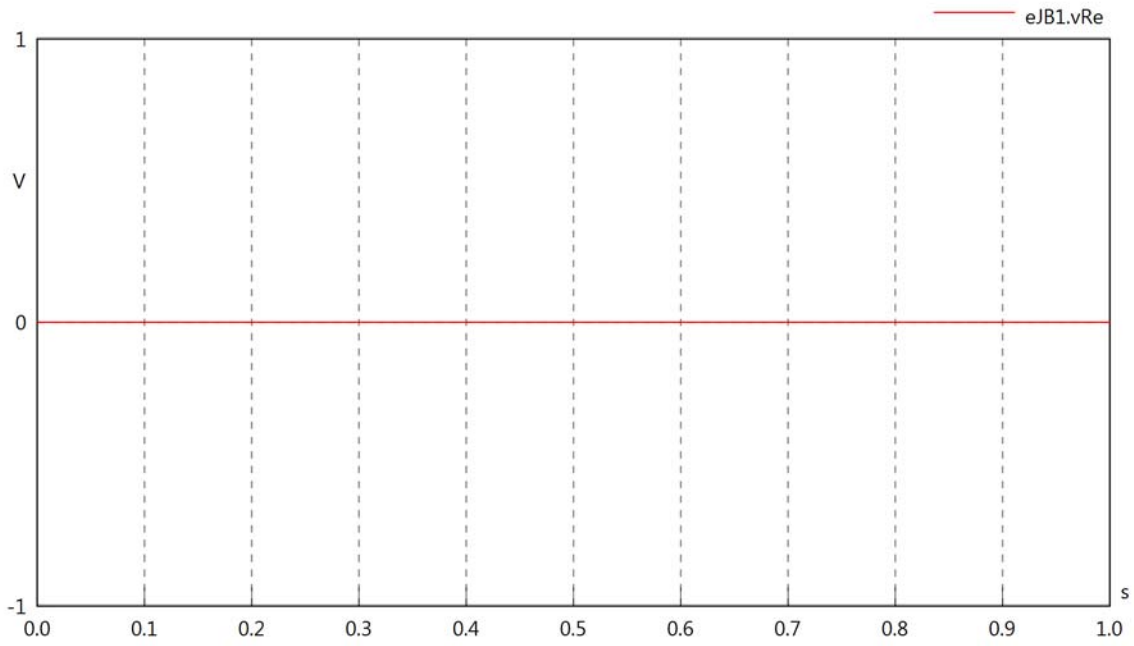

eJB1.vIm

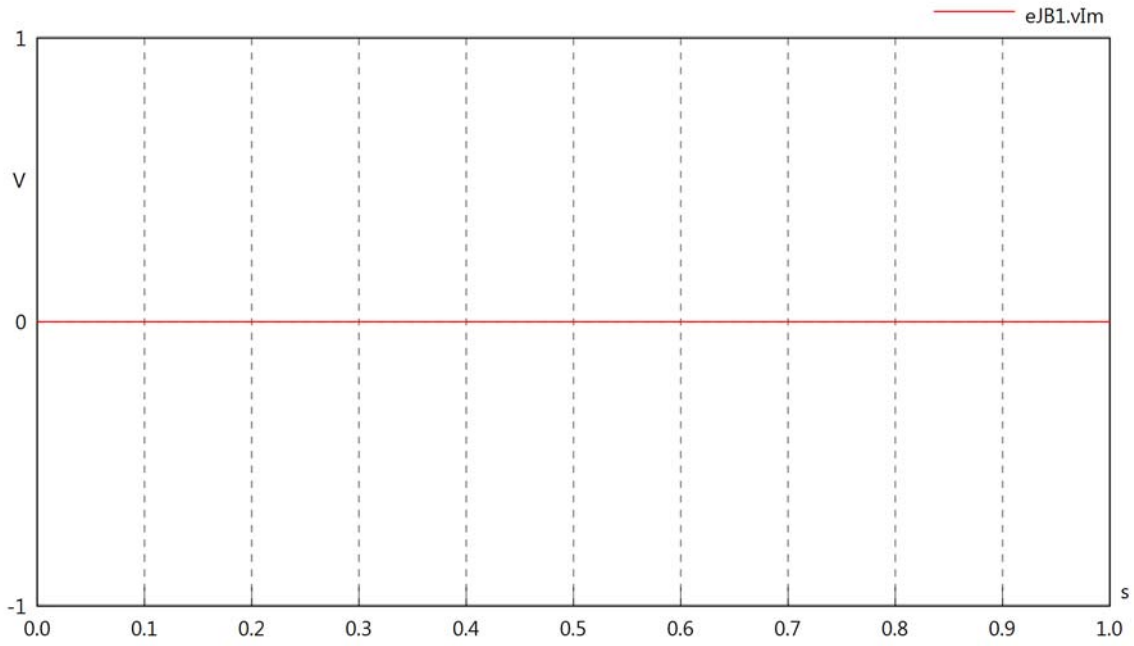

eJB1.IrmsIn

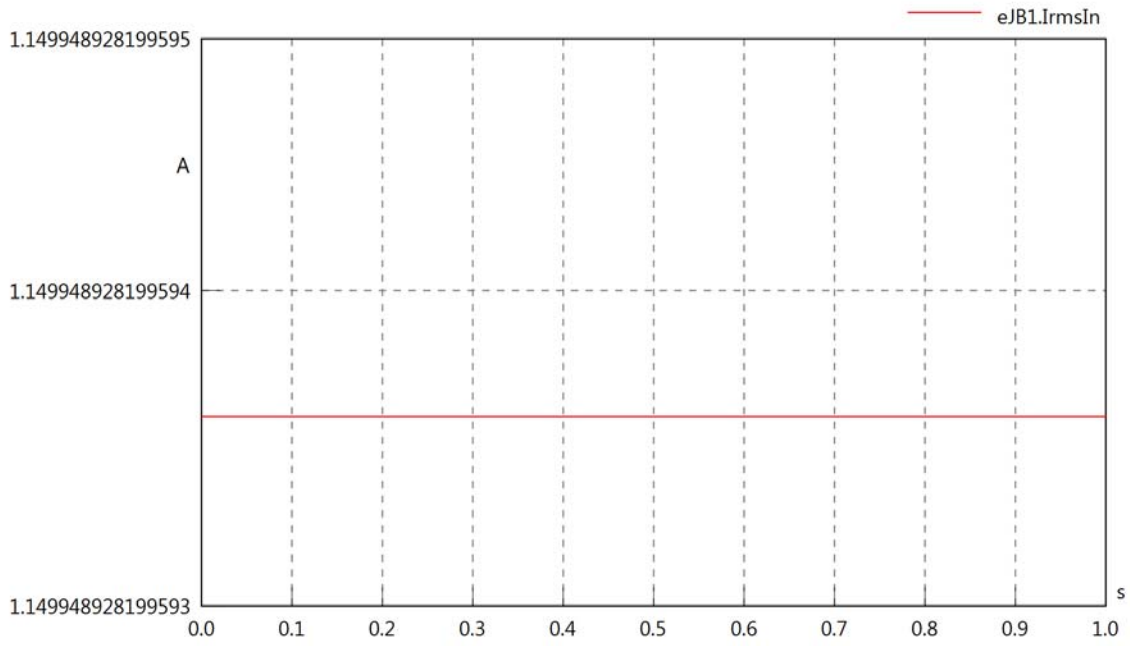

eJB1.iReIn

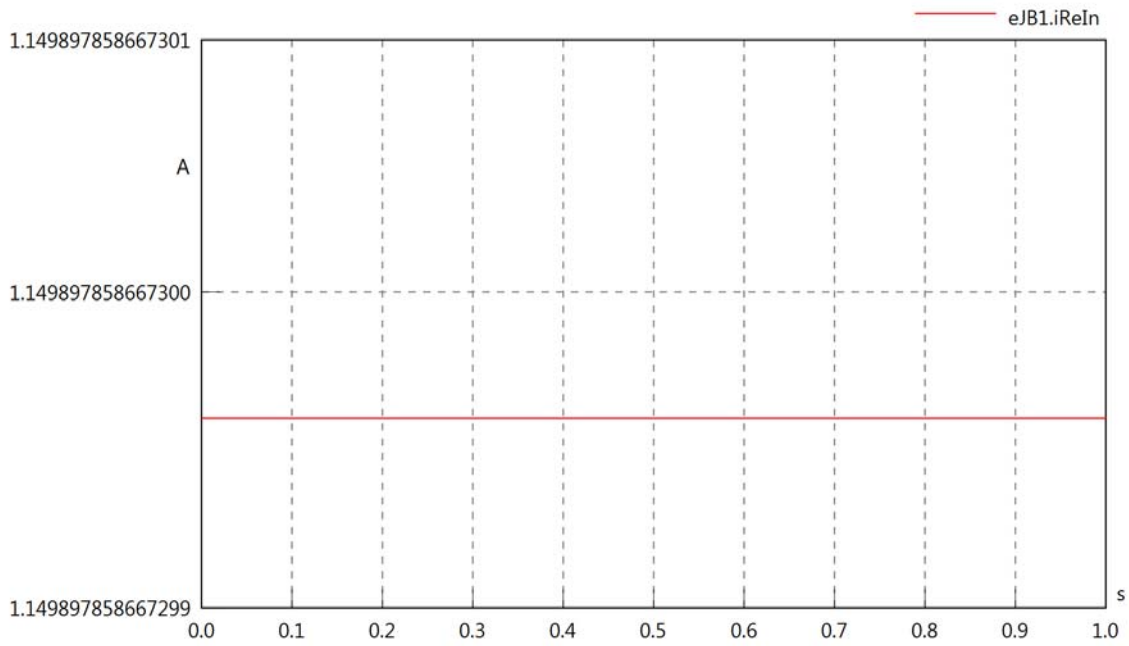

eJB1.iImIn

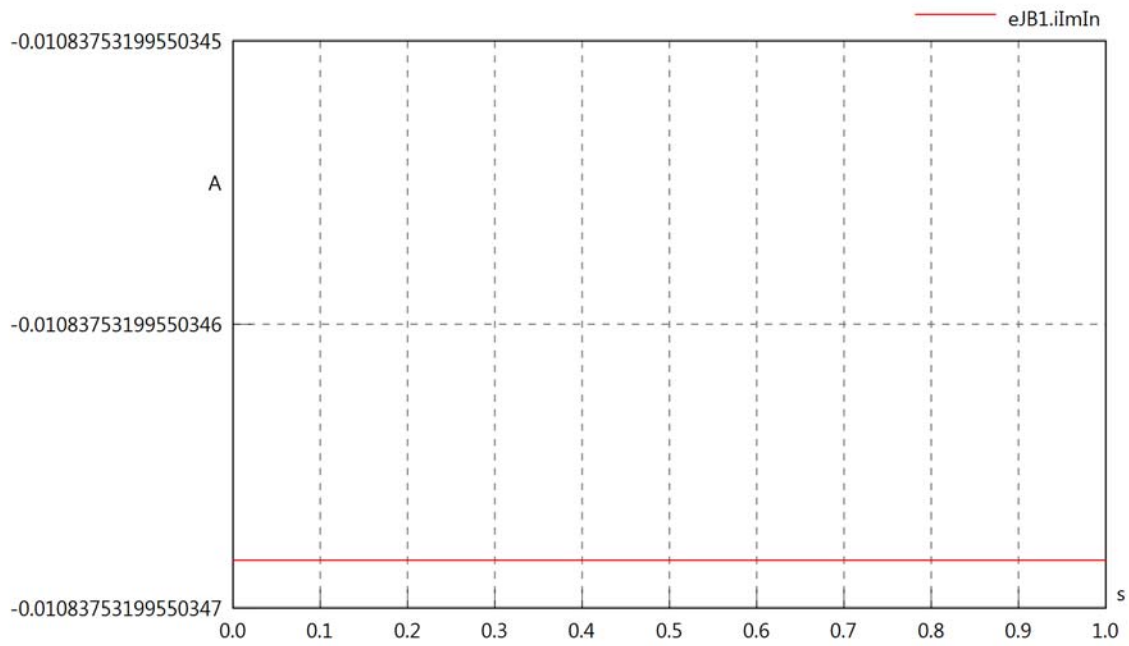

eJB1.IrmsOut

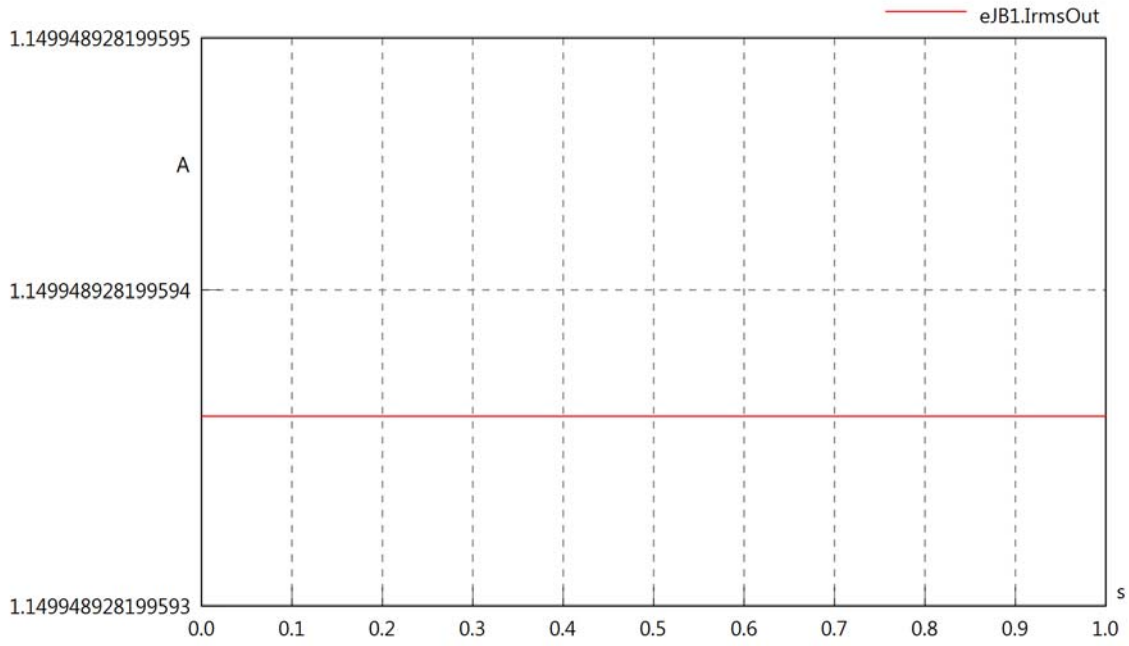

eJB1.iReOut

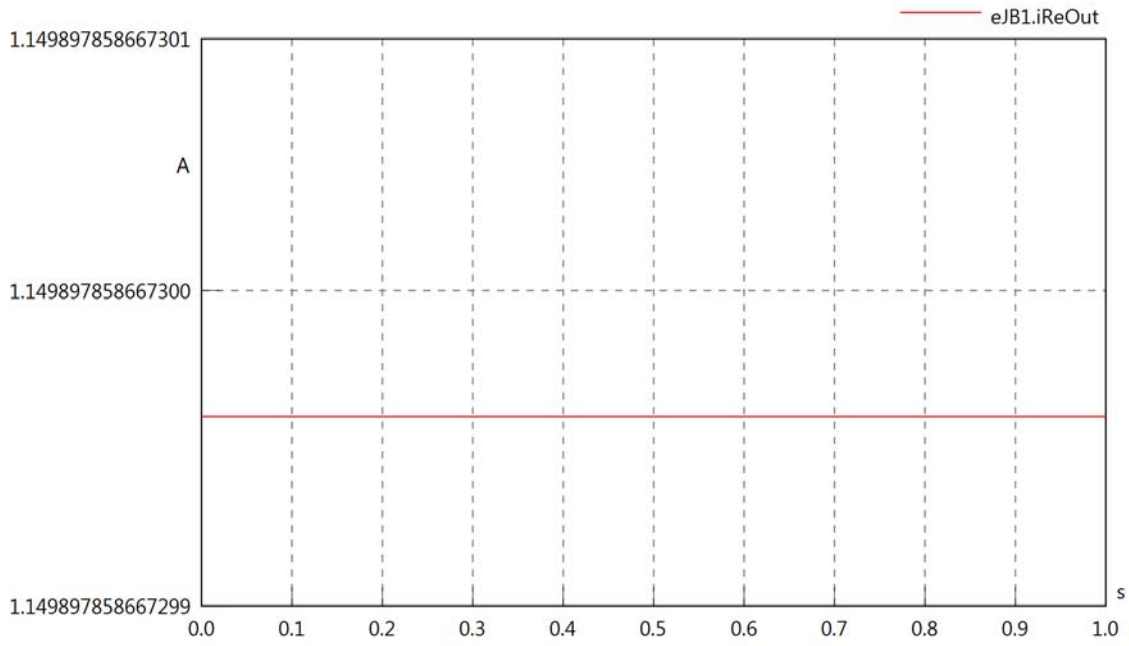

eJB1.iImOut

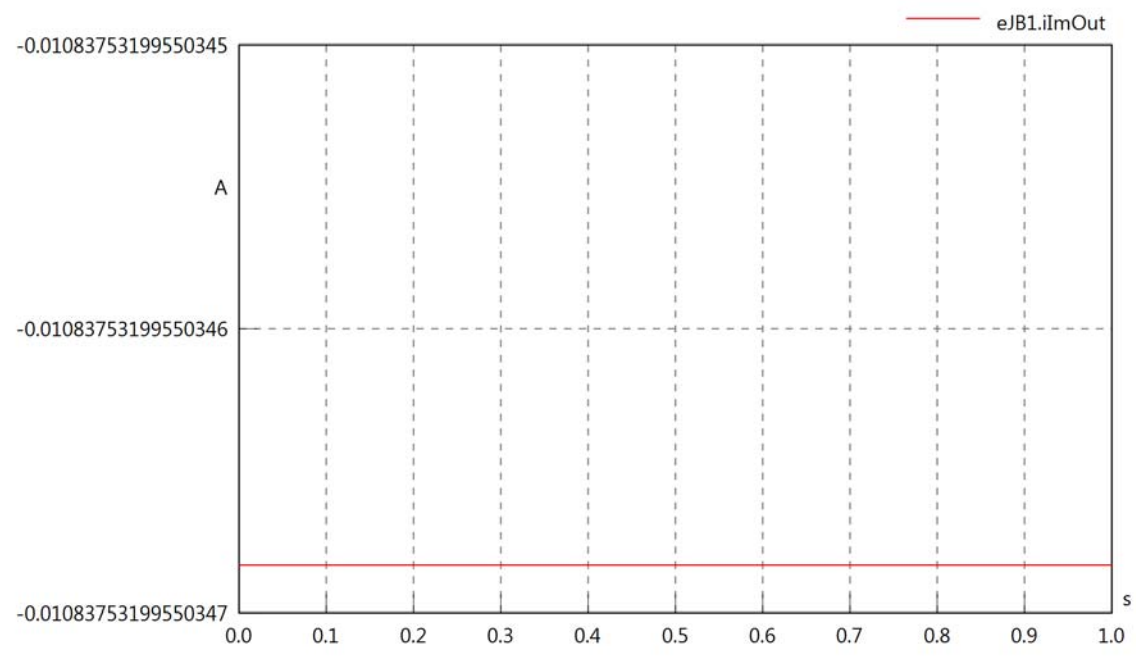

eJB1.phiVIn

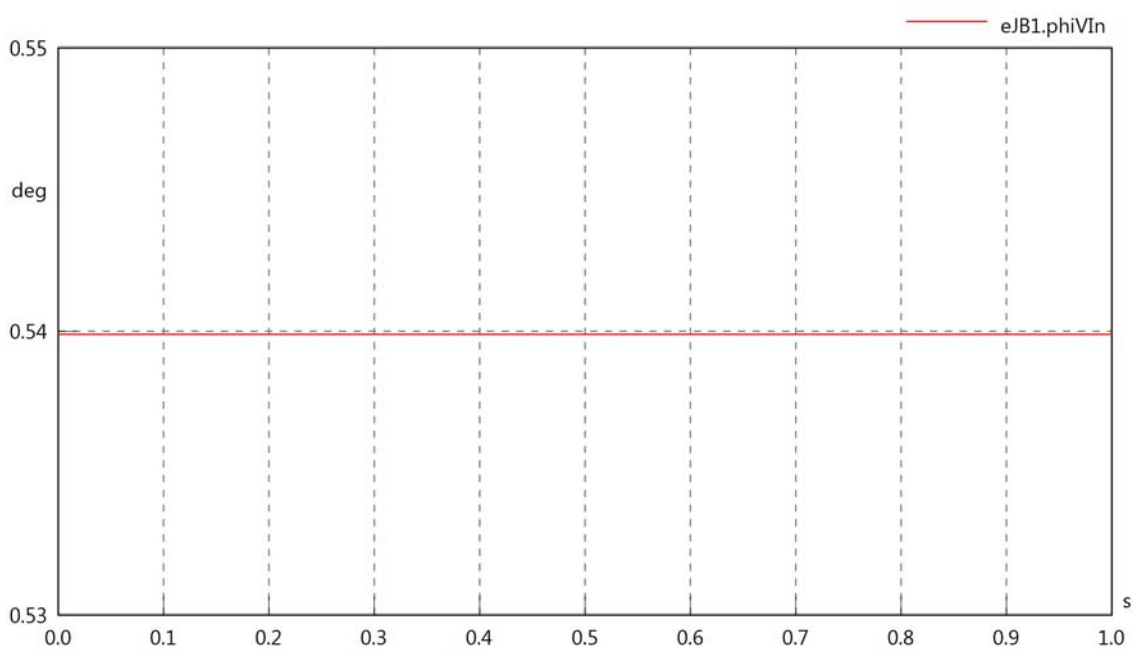

eJB1.phiIn

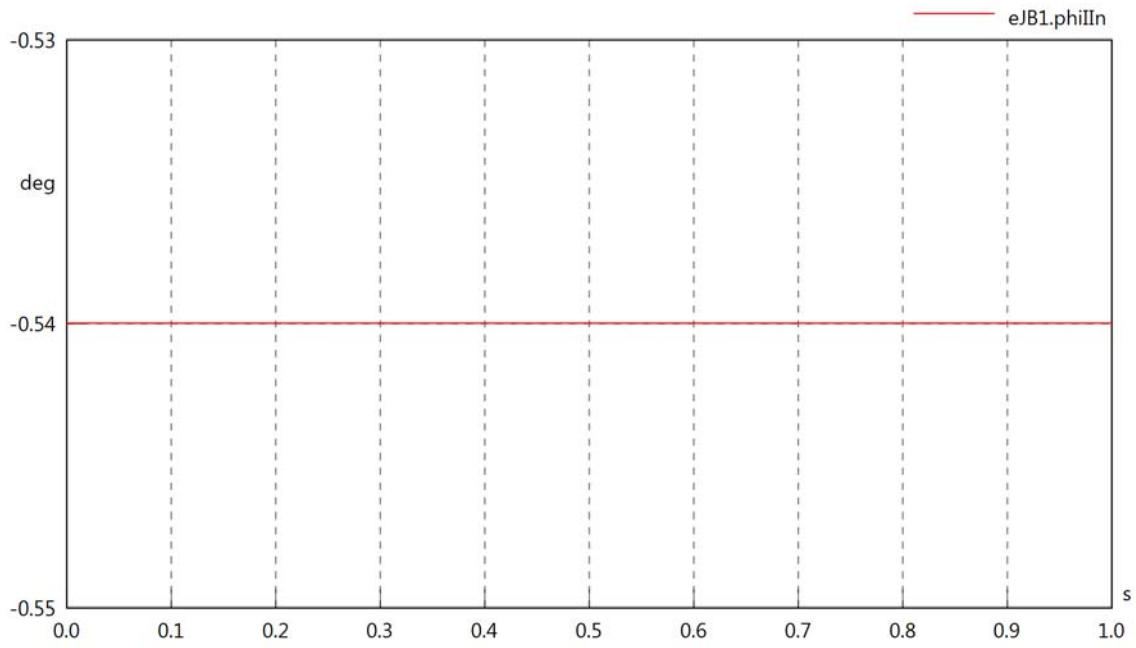

eJB1.phiIVIn

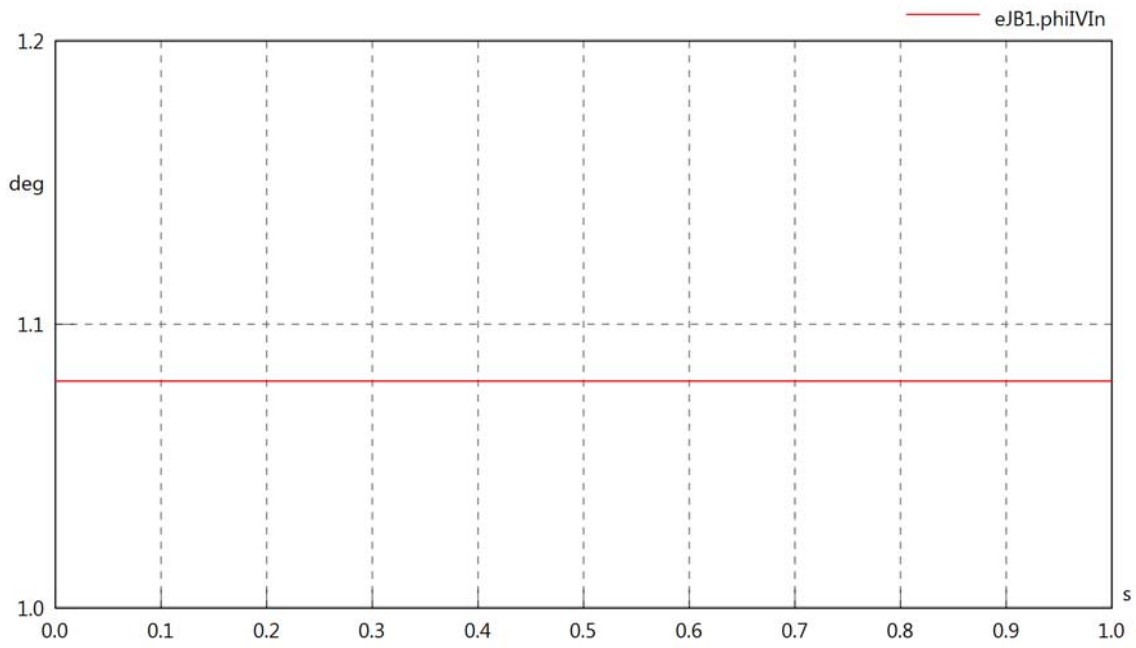

eJB1.phiVOut

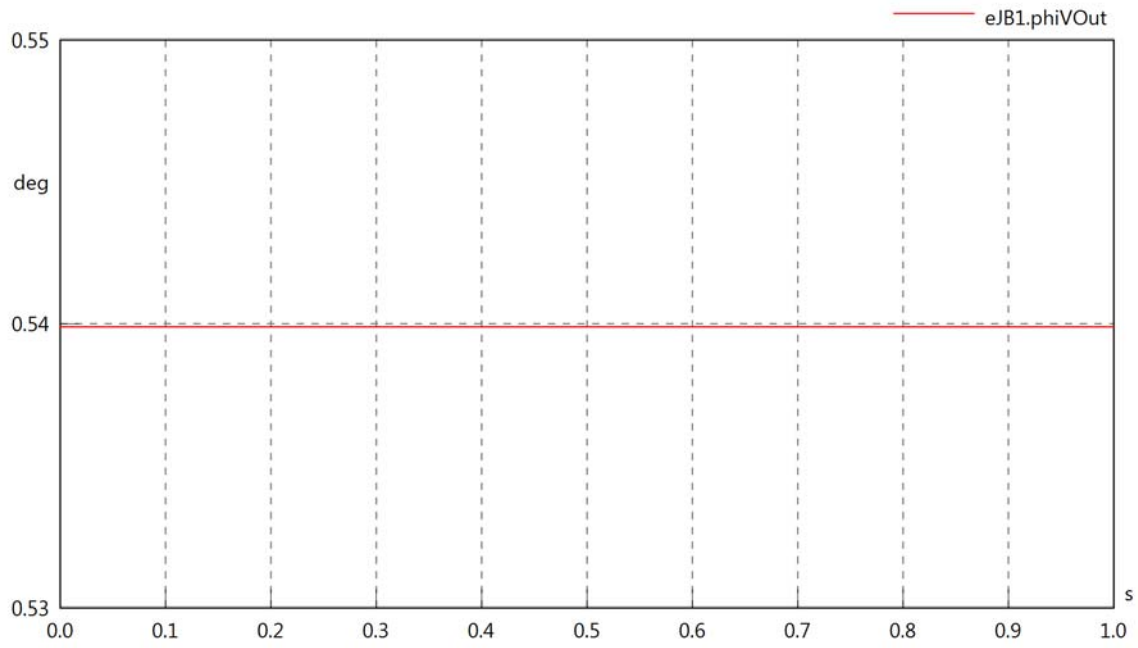

eJB1.phiIOut

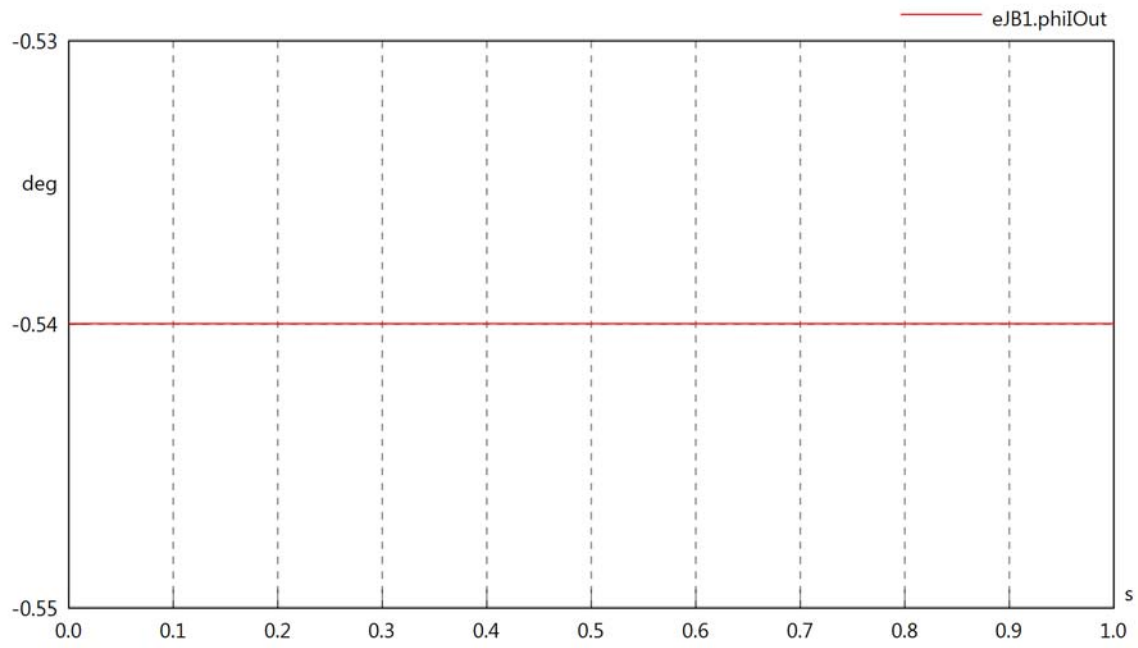

eJB1.phiIVOut

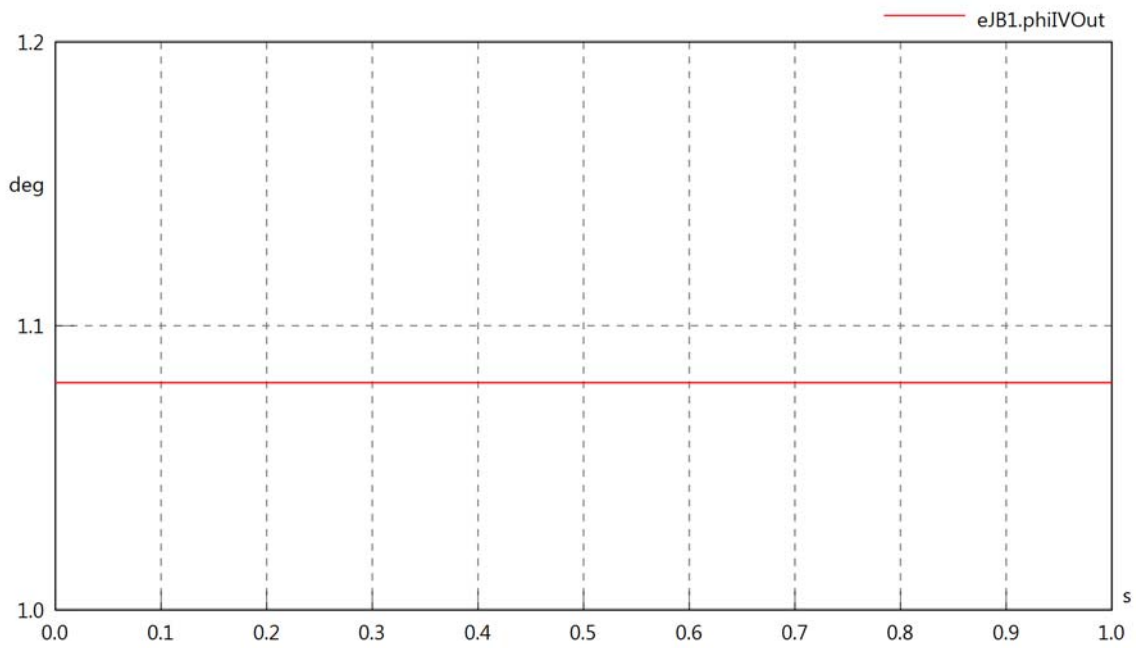

eJB1.PReIn

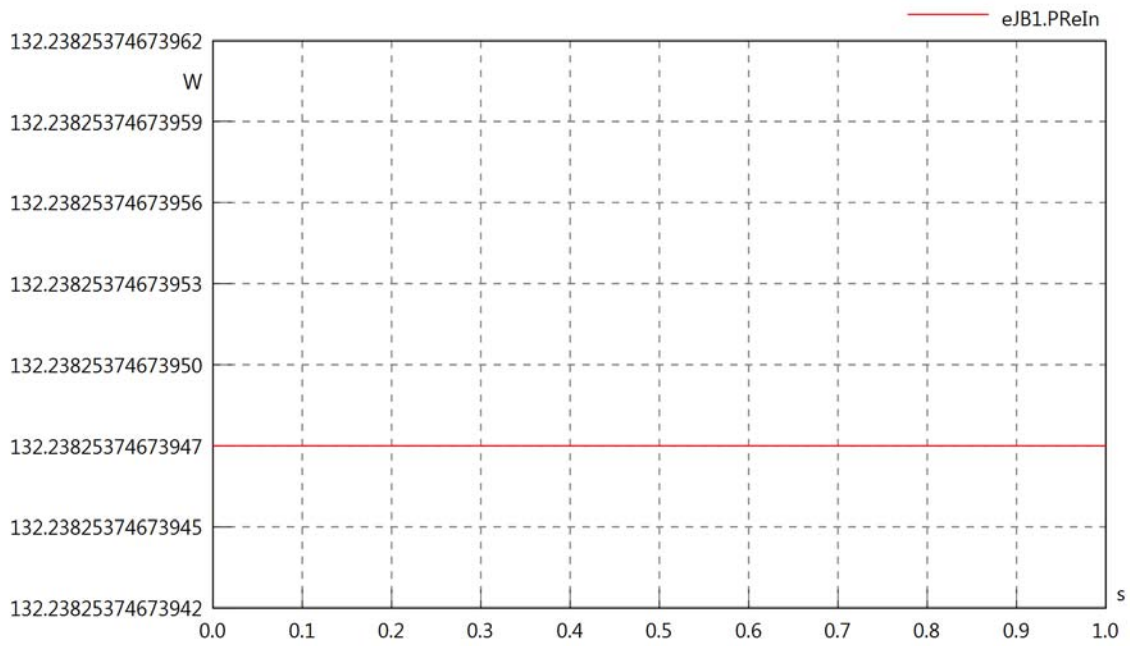

eJB1.PImIn

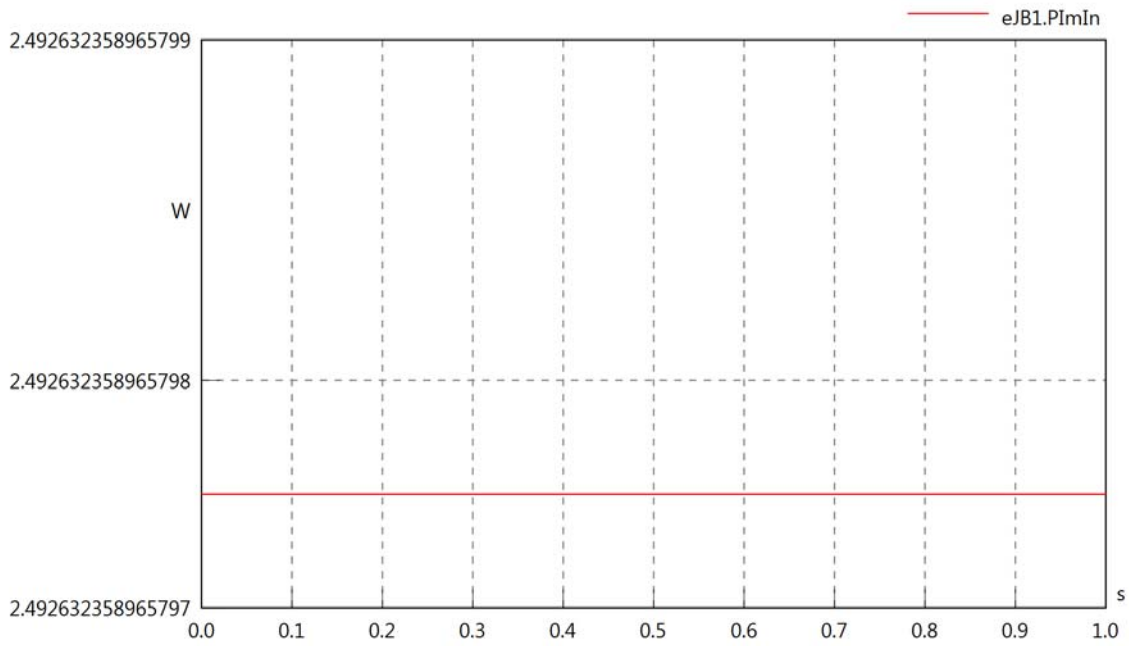

eJB1.SIn

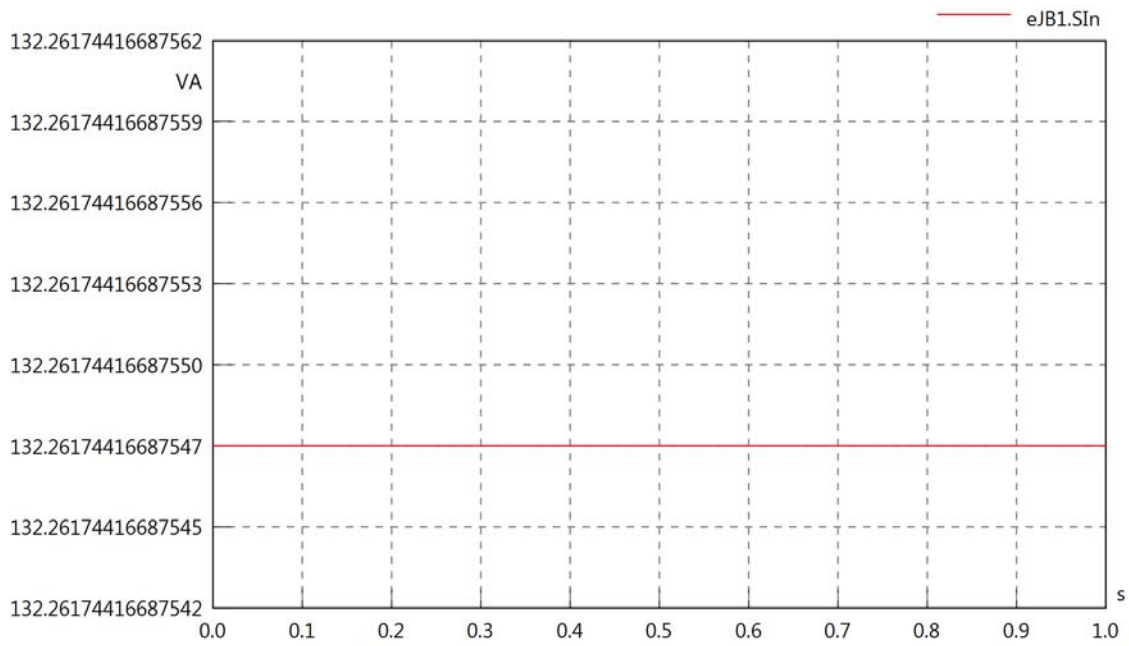

eJB1.PReOut

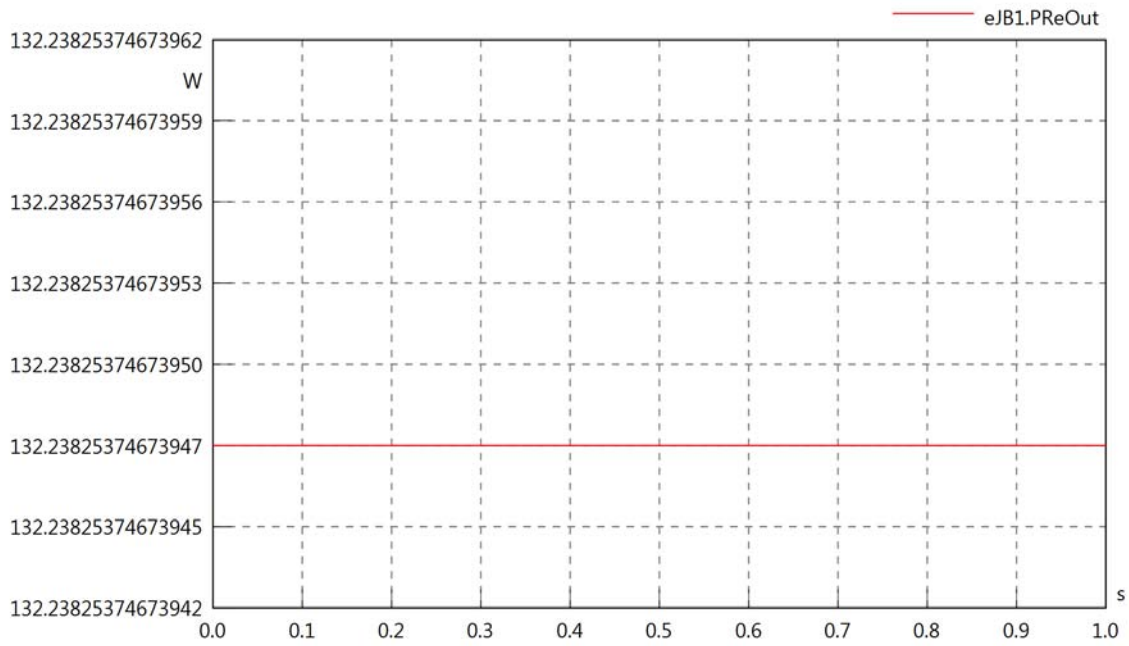

eJB1.PImOut

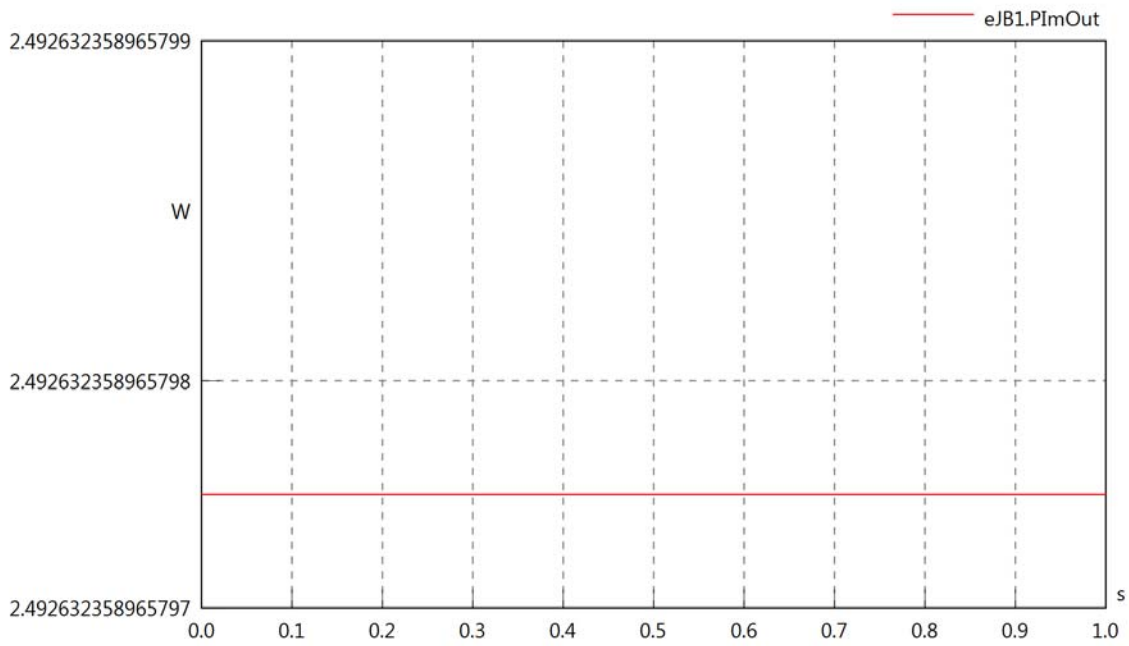

eJB1.SOut

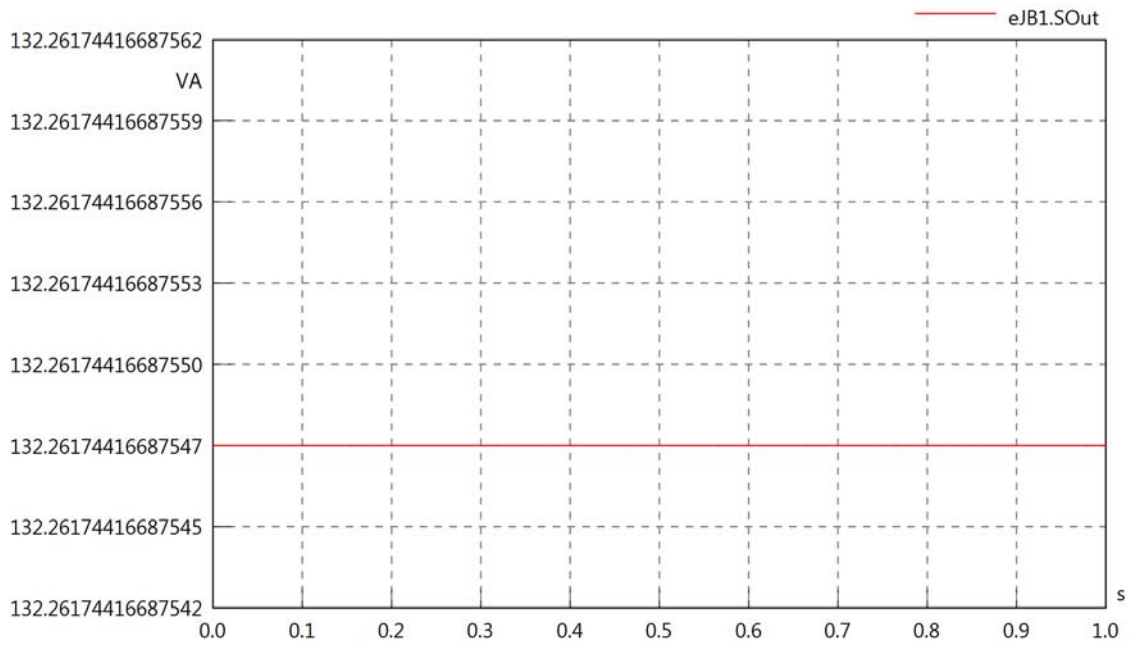
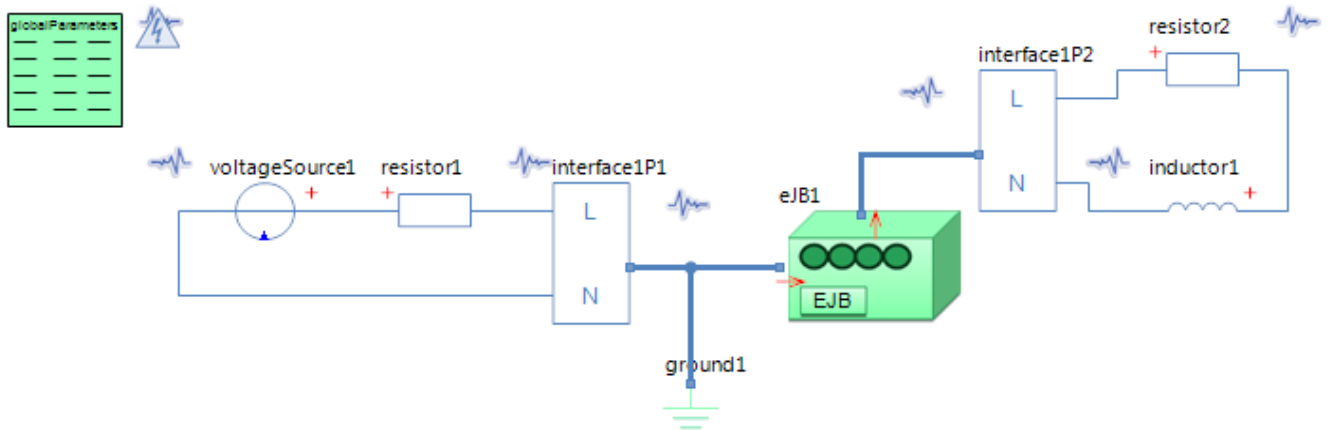

Diagram View



GlobalParameters globalParameters
Parameters

Comment	Name	Current Value	Unit
Type of Calculation	eCalculationKind	Signal Calculation	
Description of Frequency	eFrequencyKind	Linear	
Minimum Frequency	fMin	4000	[Hz]
Maximum Frequency	fMax	4000	[Hz]

Voltage Source voltageSource1
Parameters

Comment	Name	Current Value	Unit
Voltage RMS	VrmsSrc	230	[V]
Phase	phi	0	[deg]

Resistor resistor1
Parameters

Comment	Name	Current Value	Unit
Resistance	R	100	[Ohm]

Resistor resistor2
Parameters

Comment	Name	Current Value	Unit
Resistance	R	100	[Ohm]

Electrical Junction Box eJB1
Parameters

Comment	Name	Current Value	Unit
Poor or failing L1 connection	bL1	false	

Inductor inductor1
Parameters

Comment	Name	Current Value	Unit
Inductance	L	5	[mH]

eJB1.VrmsIn

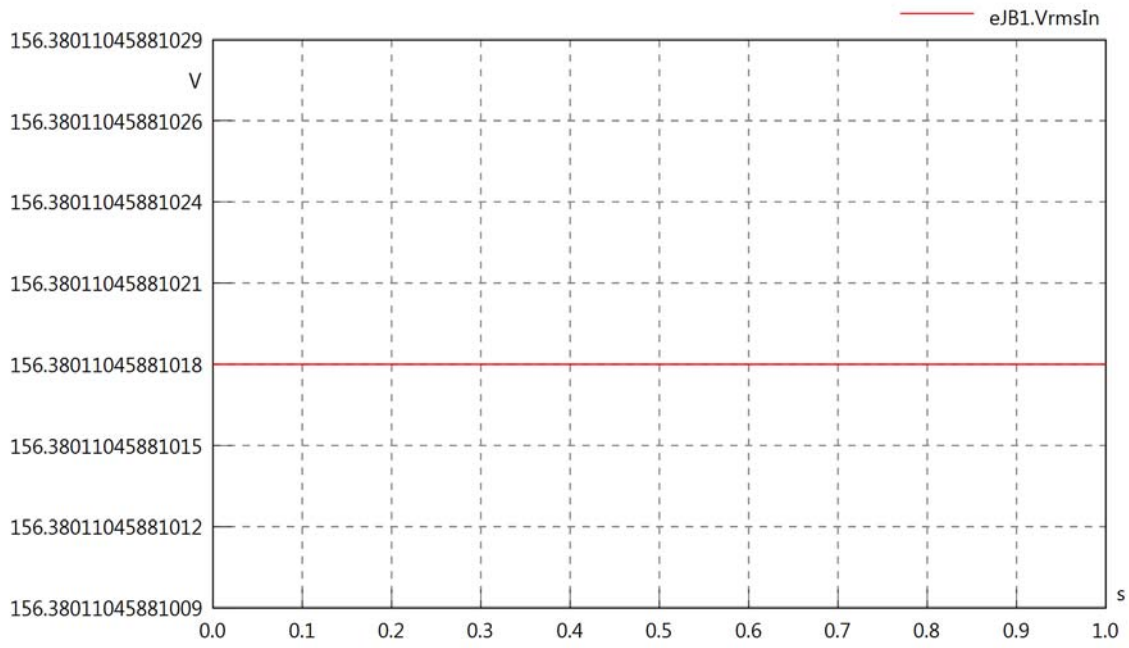

eJB1.vReIn

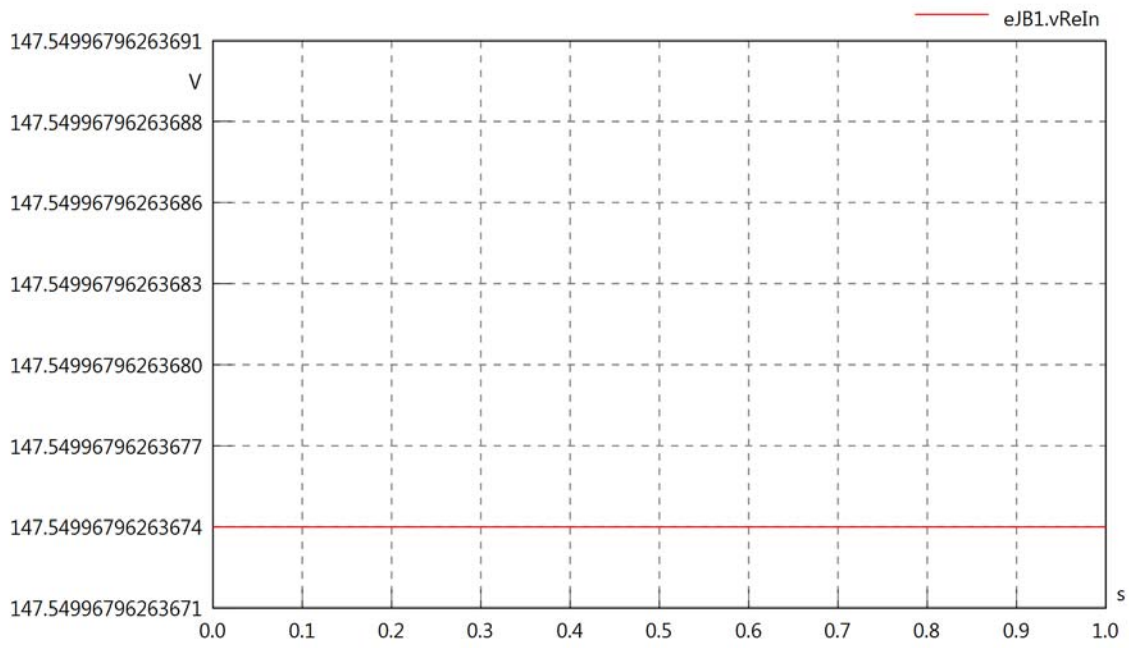

eJB1.vImIn

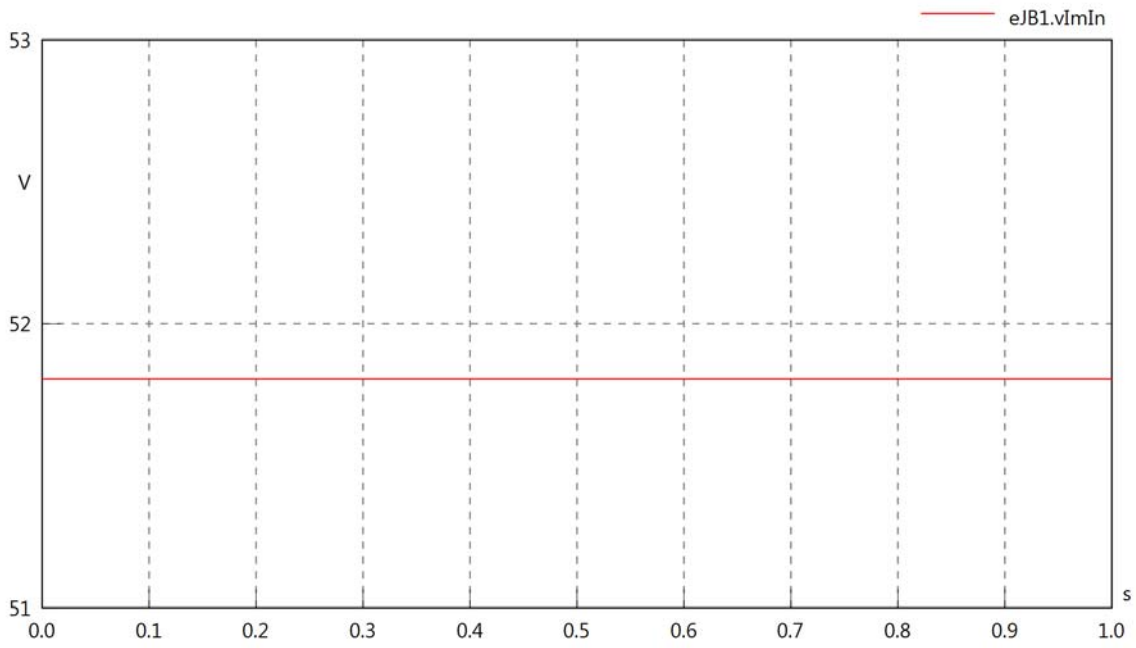

eJB1.VrmsOut

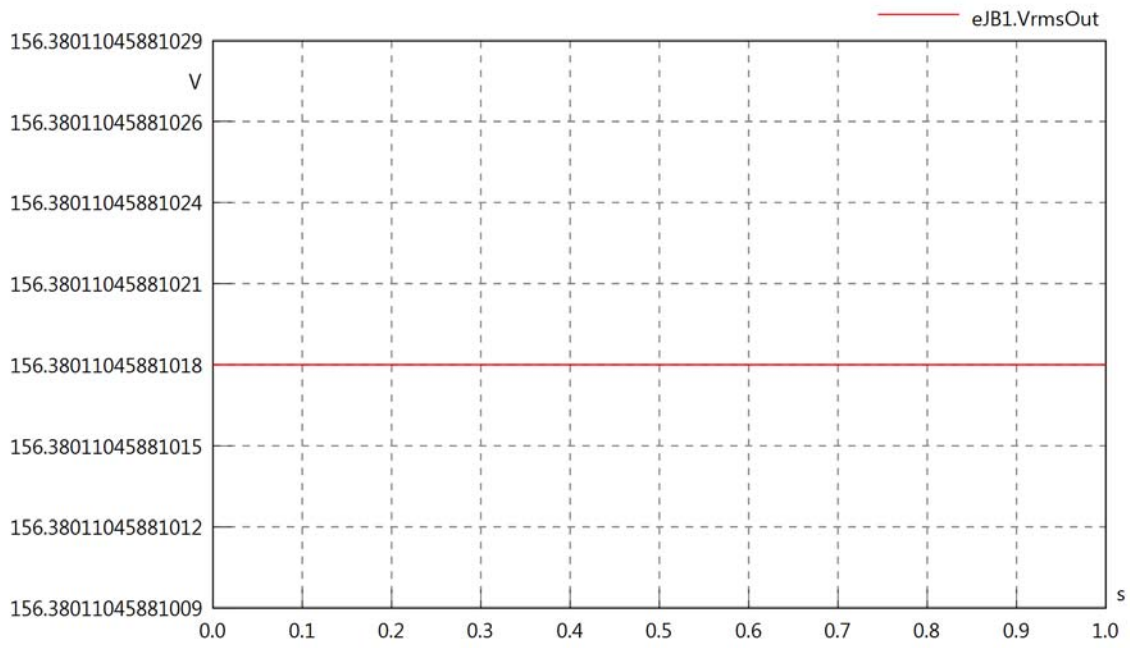

eJB1.vReOut

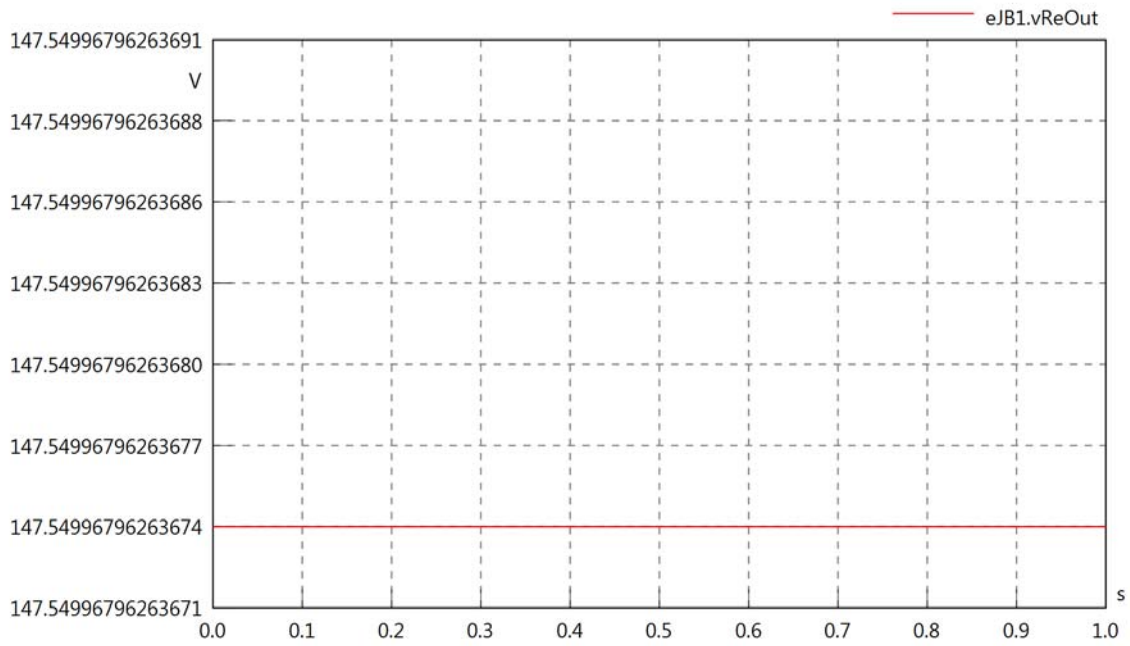

eJB1.vImOut

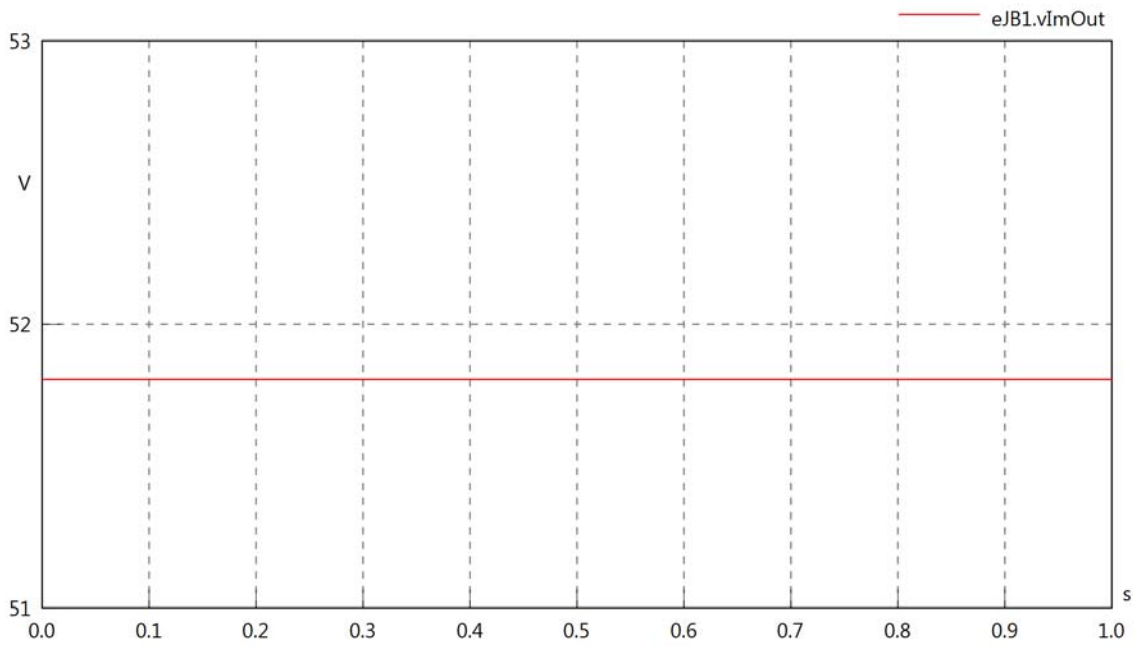

eJB1.Vrms

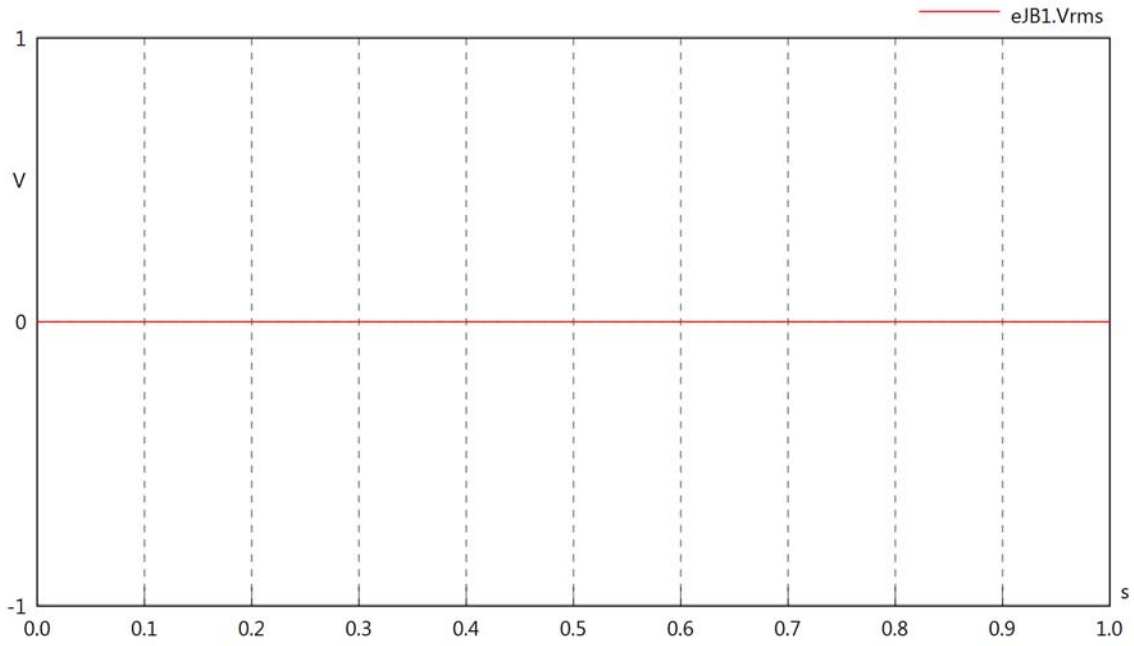

eJB1.vRe

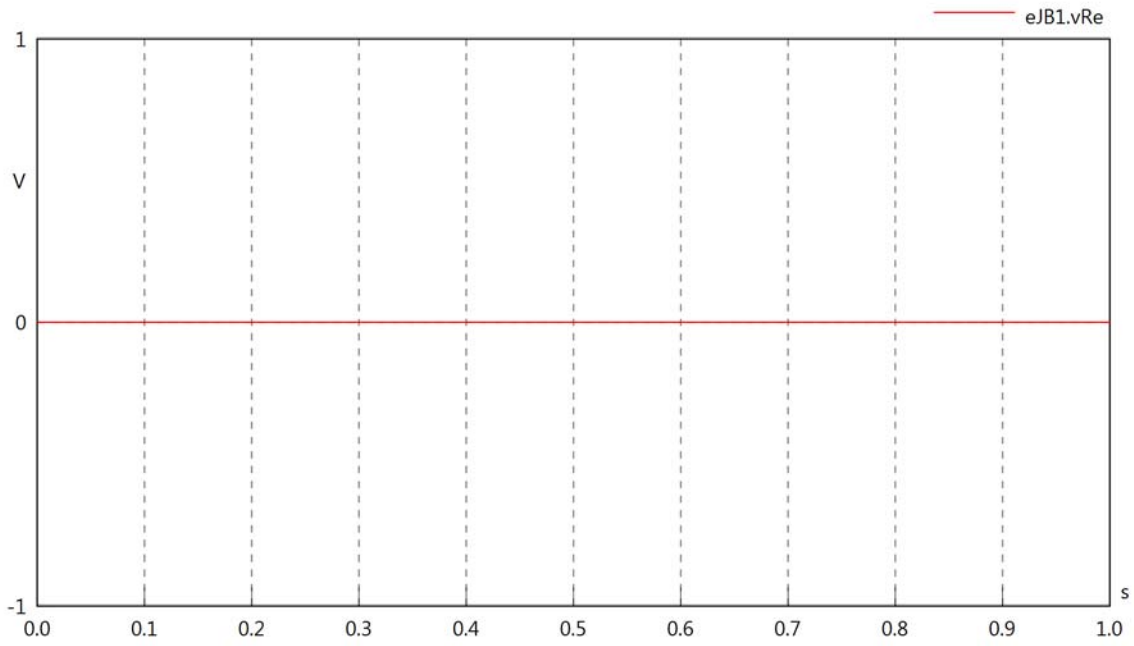

eJB1.vIm

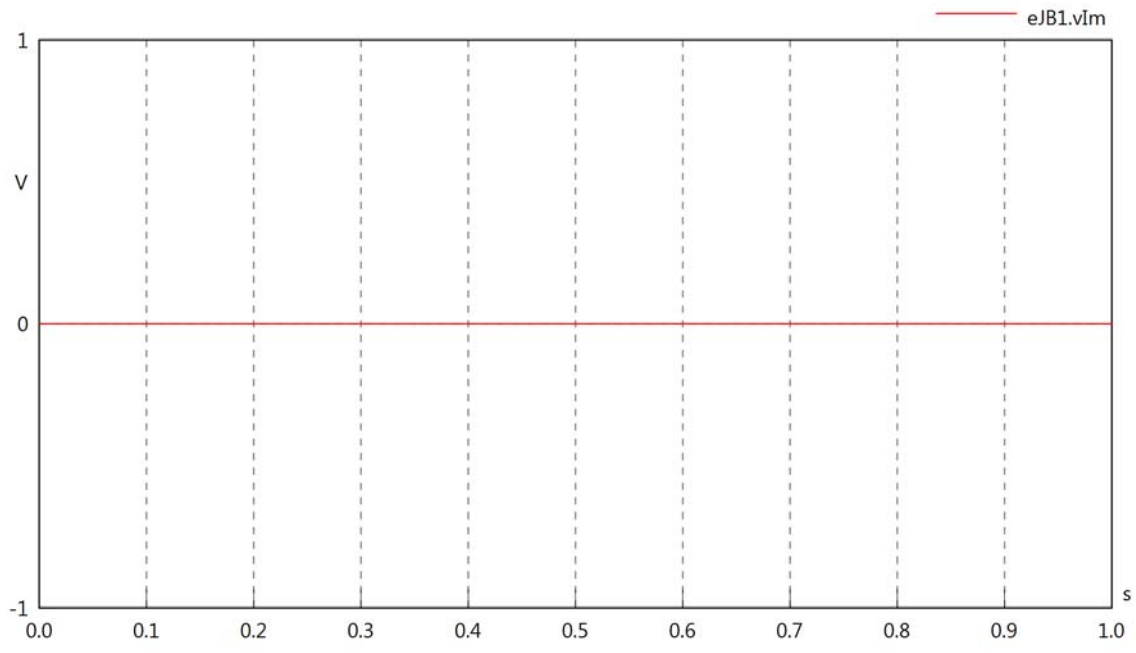

eJB1.IrmsIn

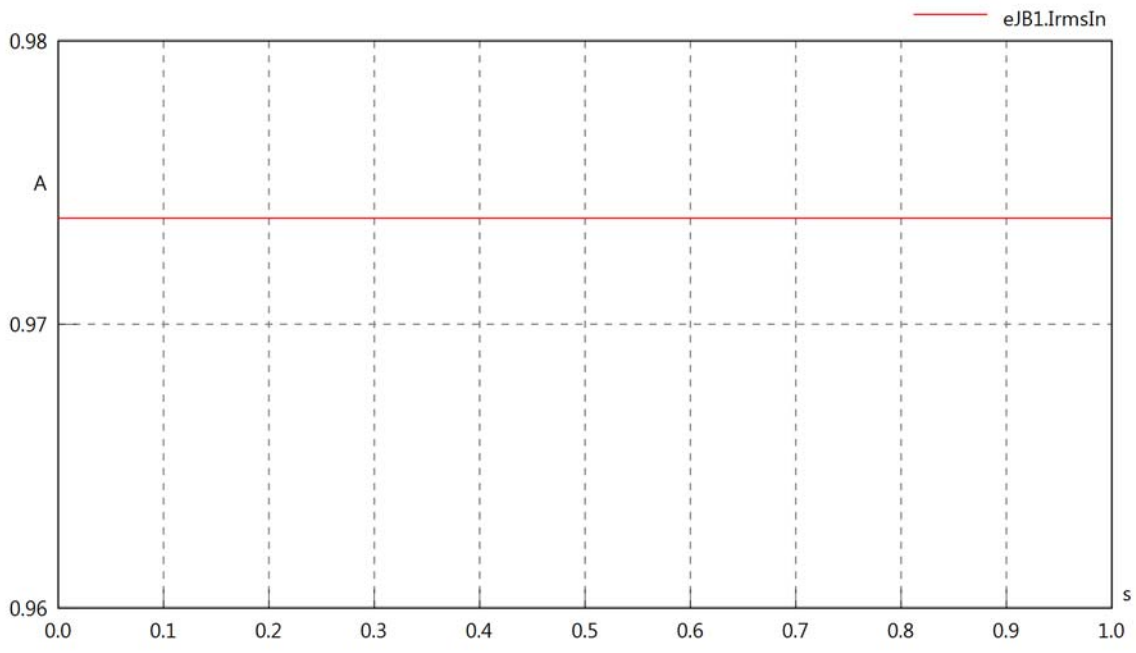

eJB1.iReIn

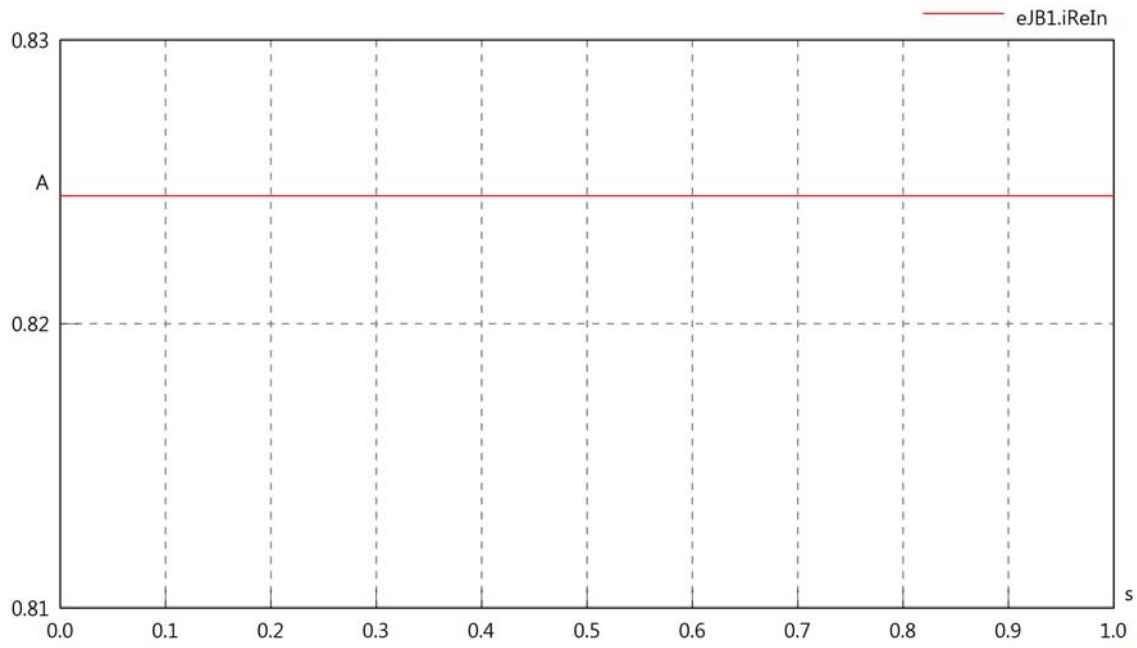

eJB1.iImIn

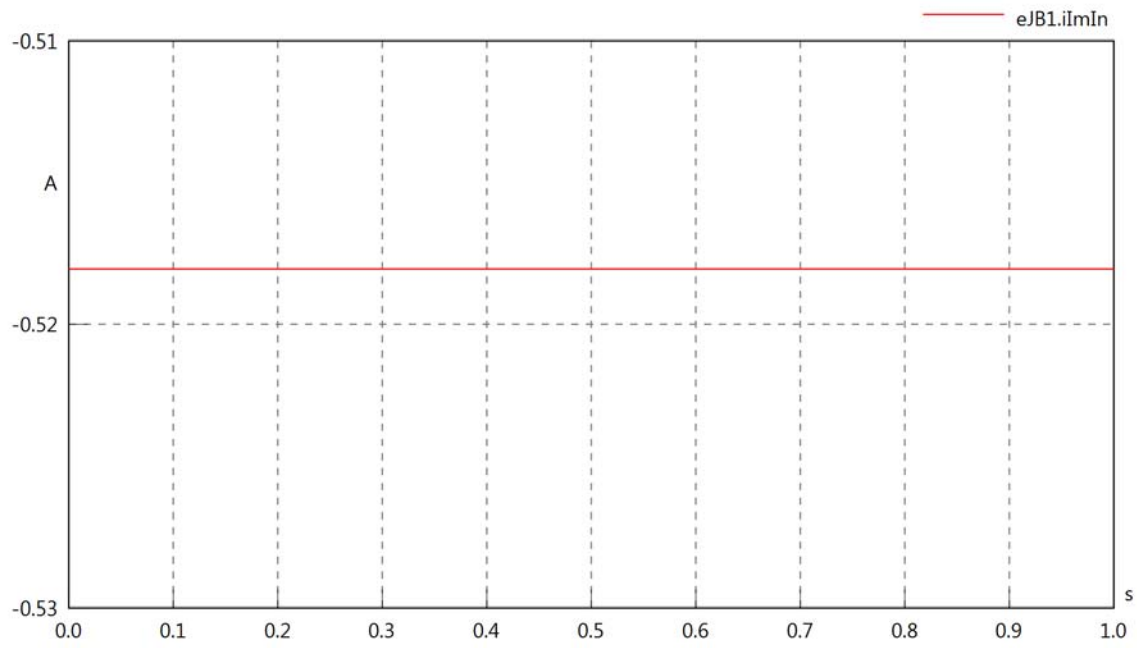

eJB1.IrmsOut

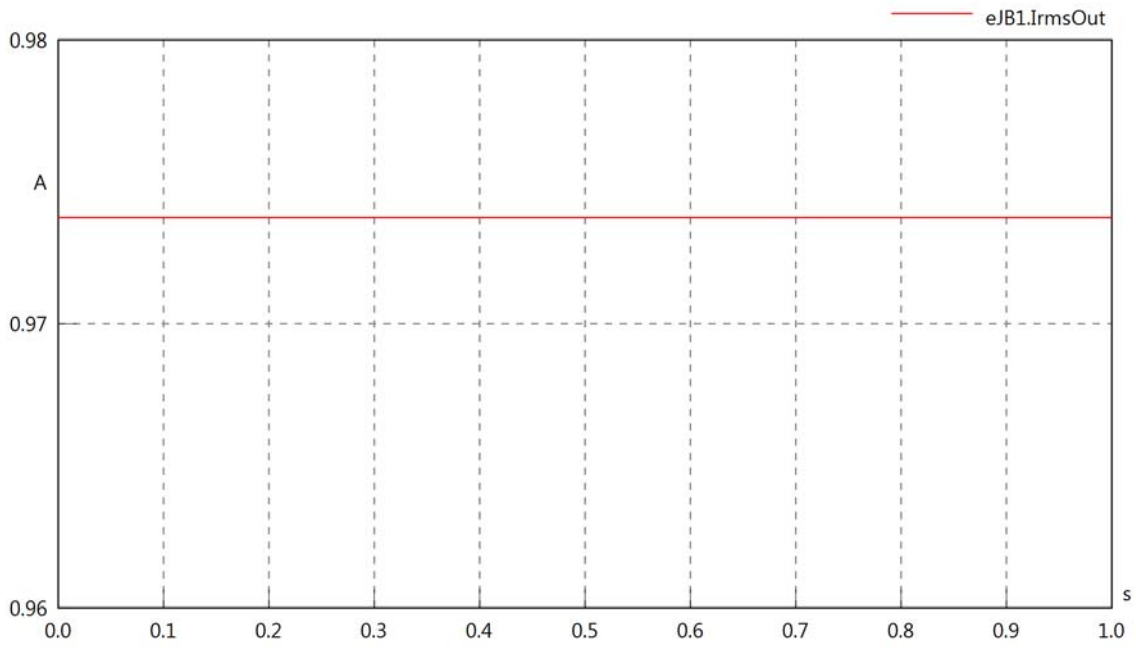

eJB1.iReOut

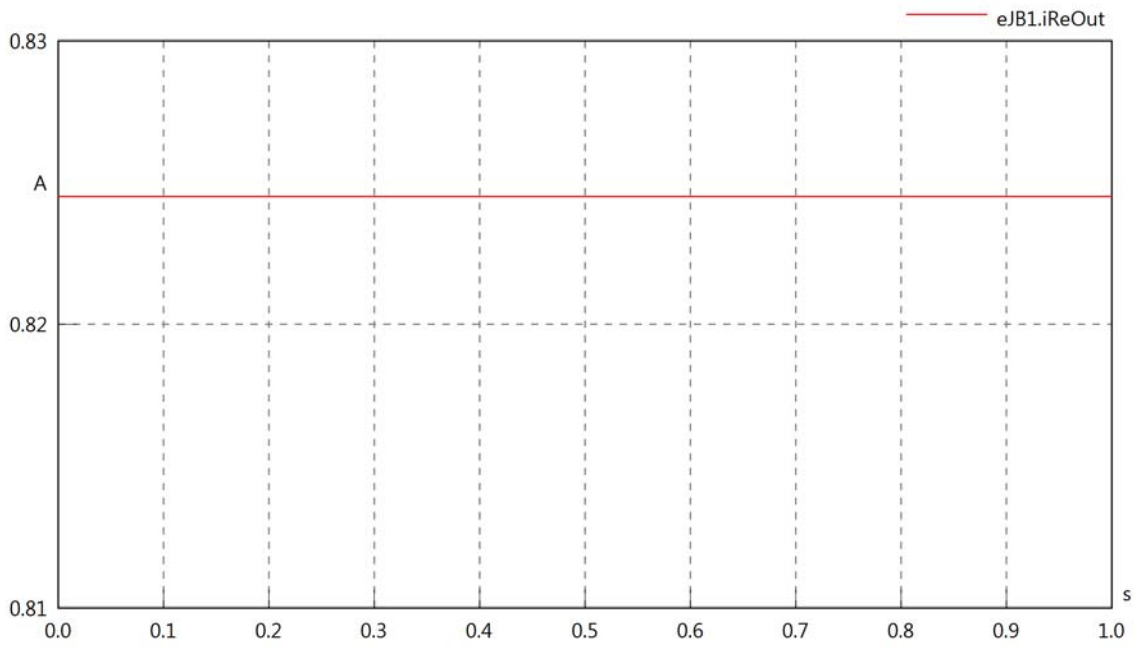

eJB1.iImOut

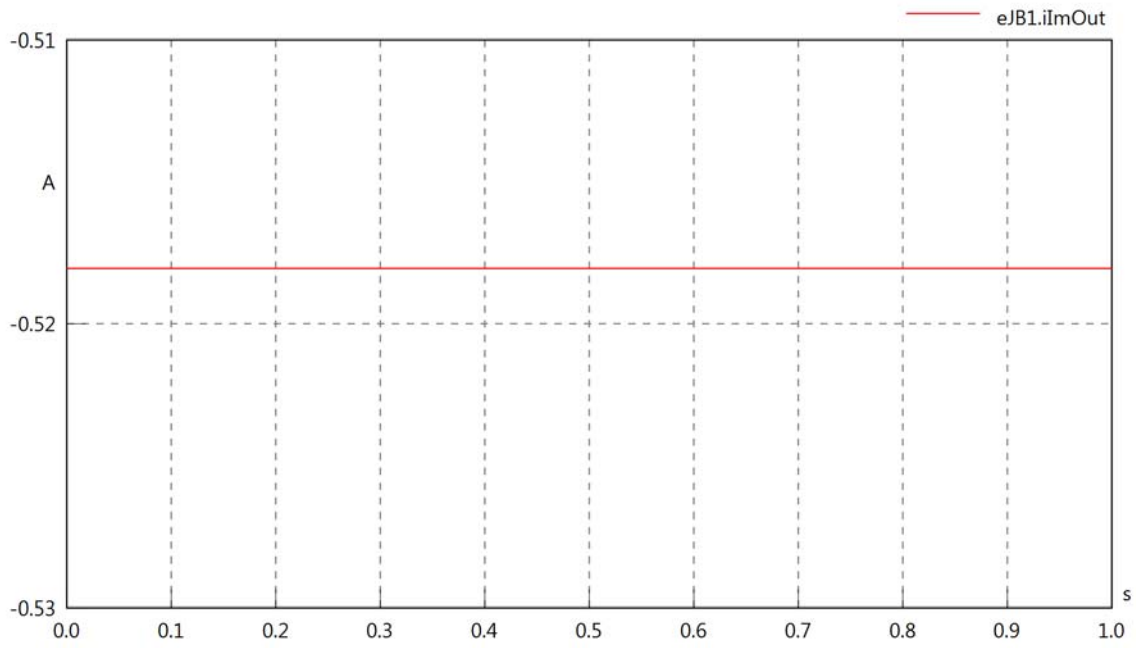

eJB1.phiVIn

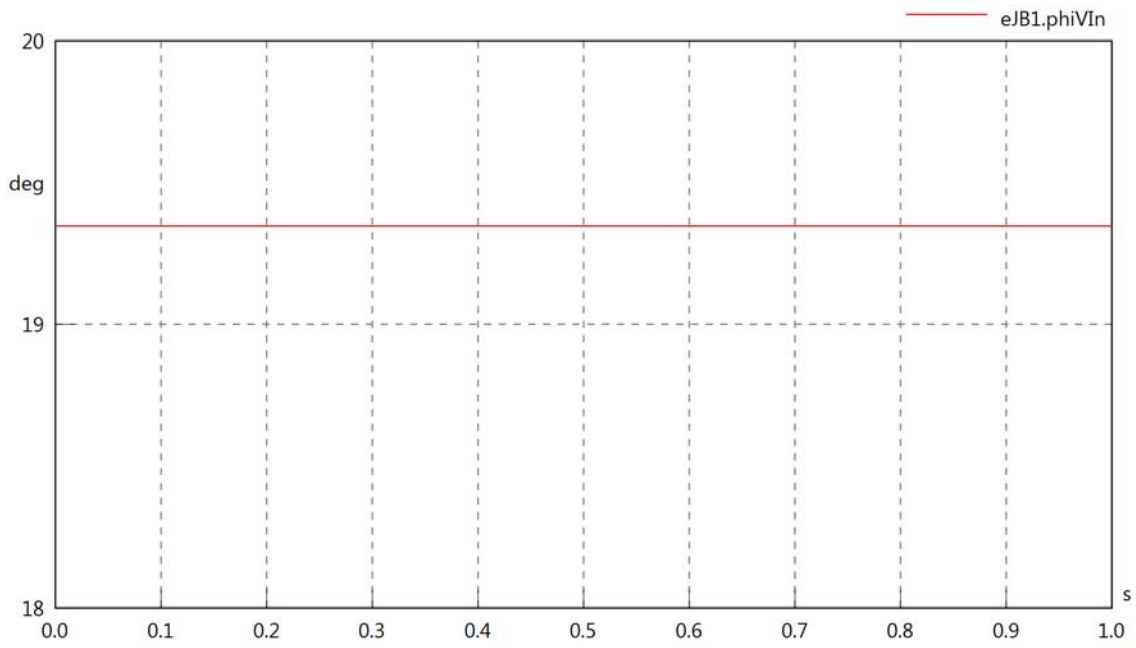

eJB1.phiIn

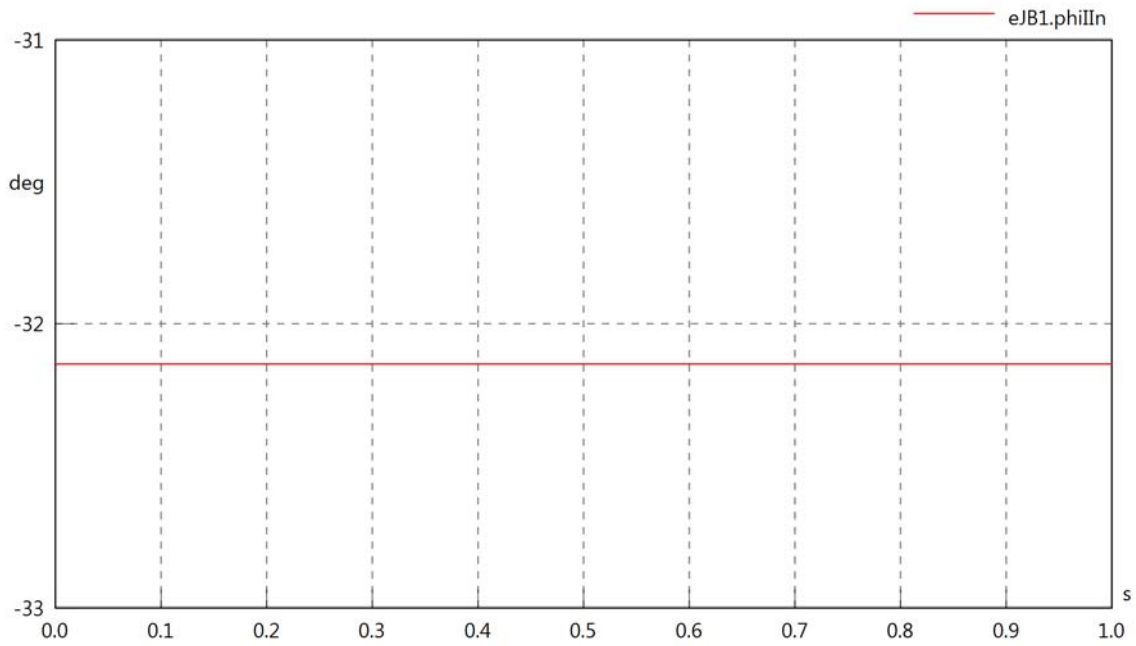

eJB1.phiIVIn

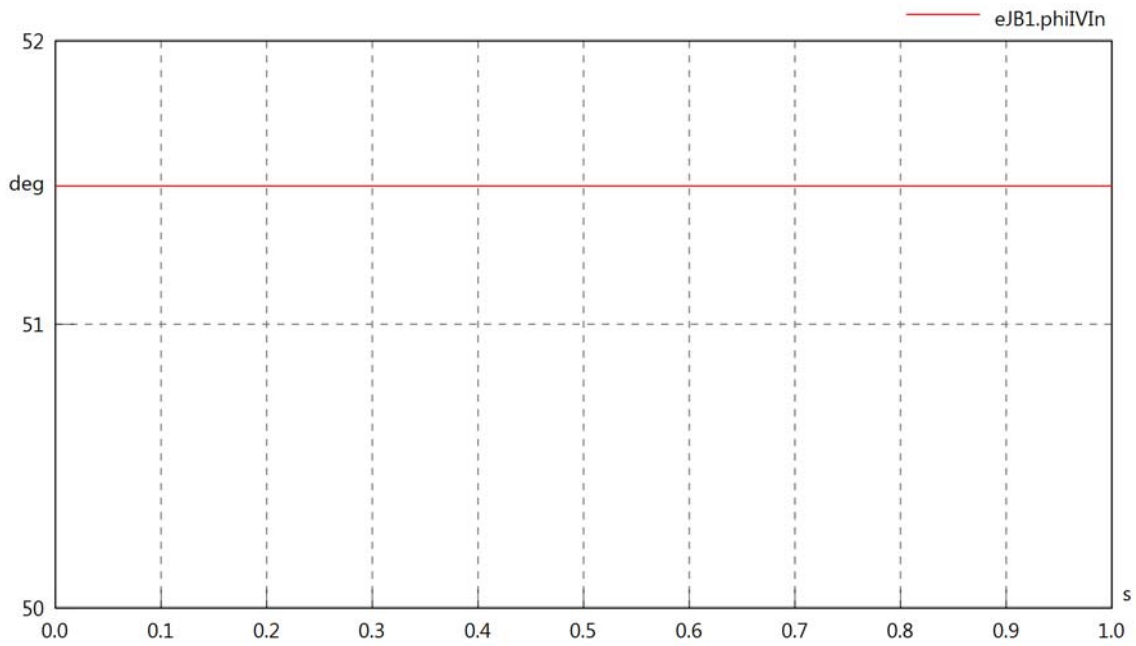

eJB1.phiVOut

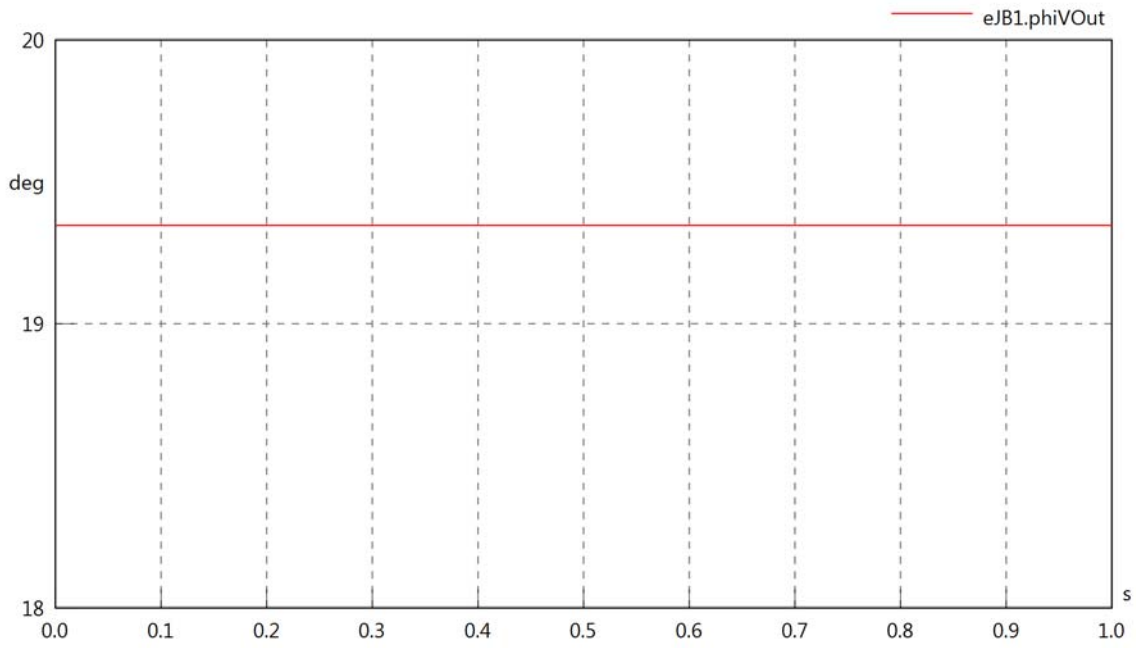

eJB1.phiIOut

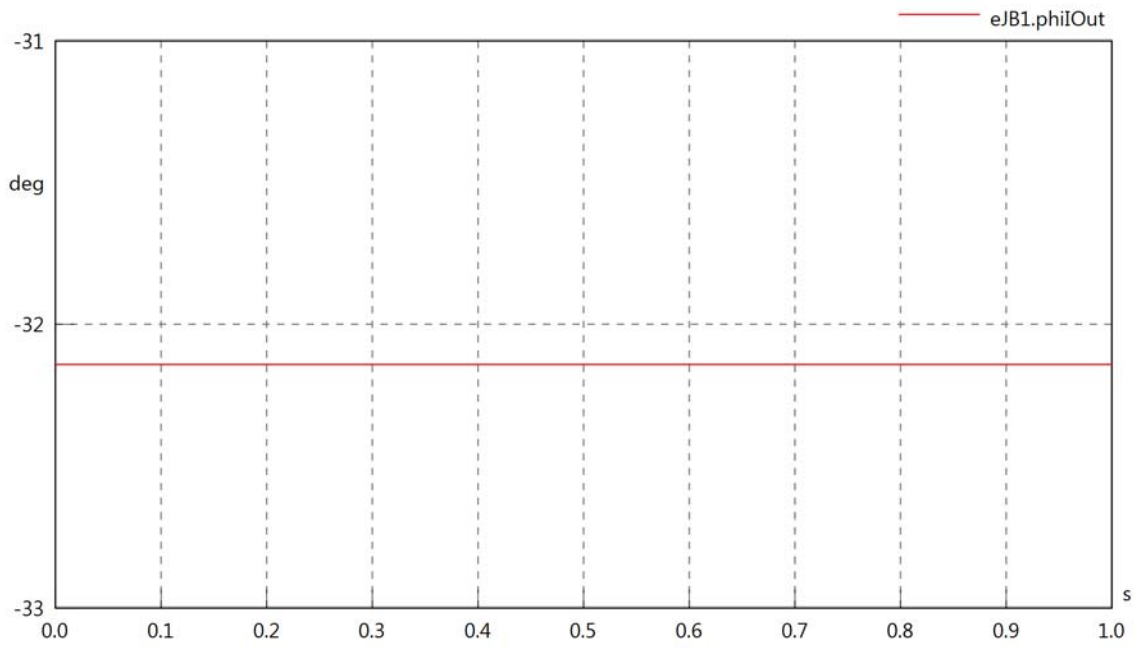

eJB1.phiIVOut

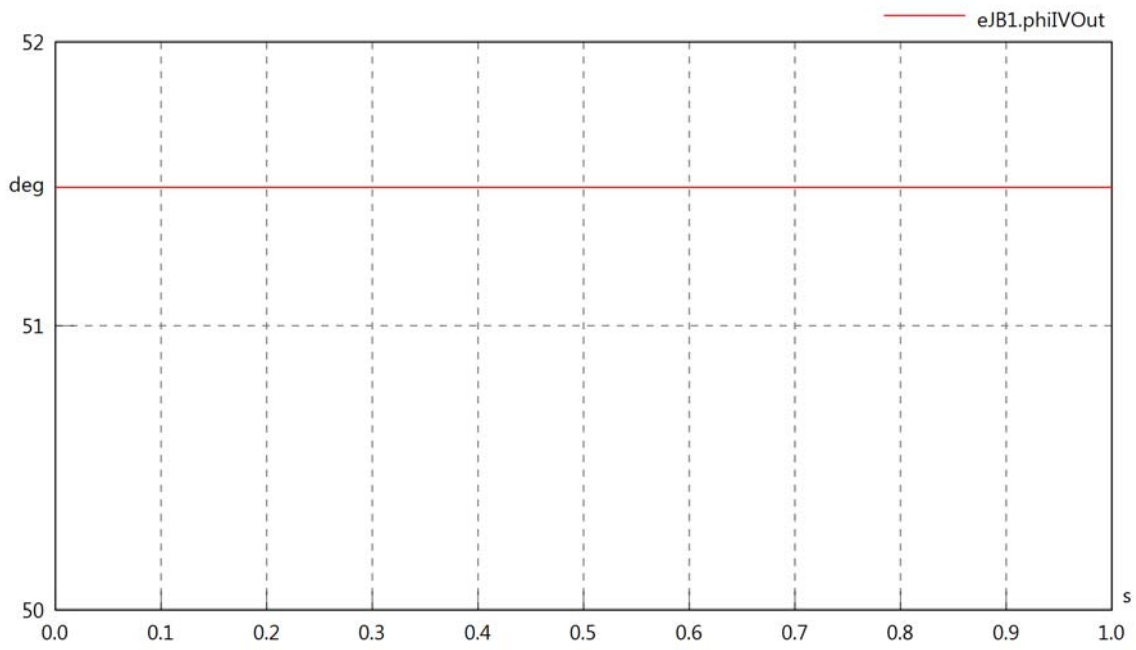

eJB1.PReIn

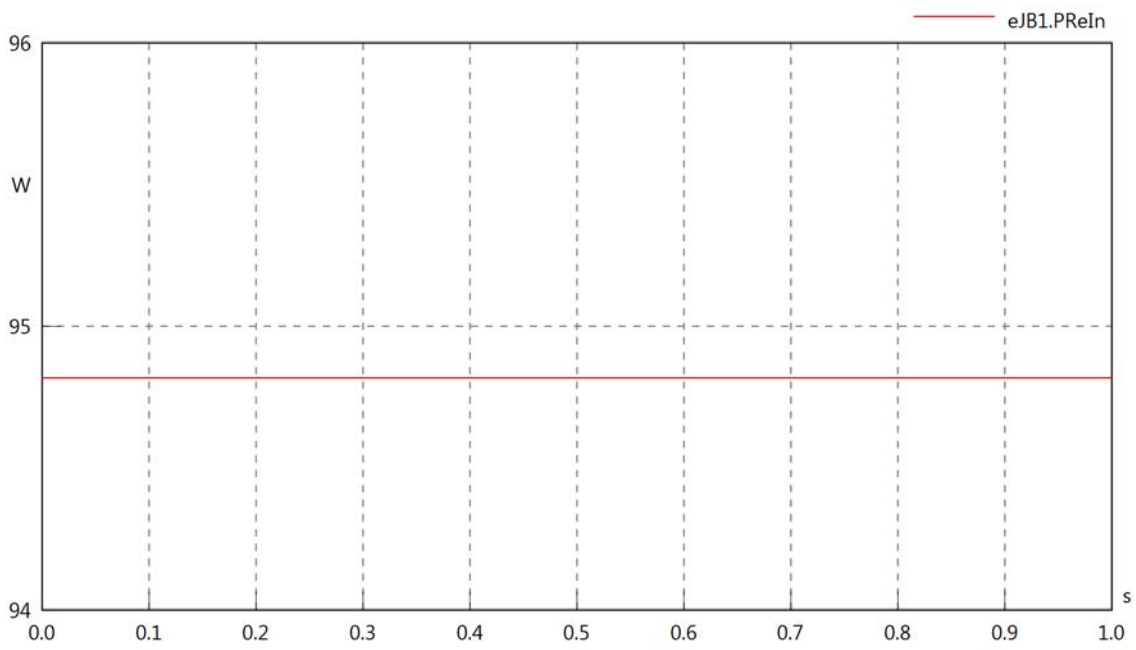

eJB1.PImIn

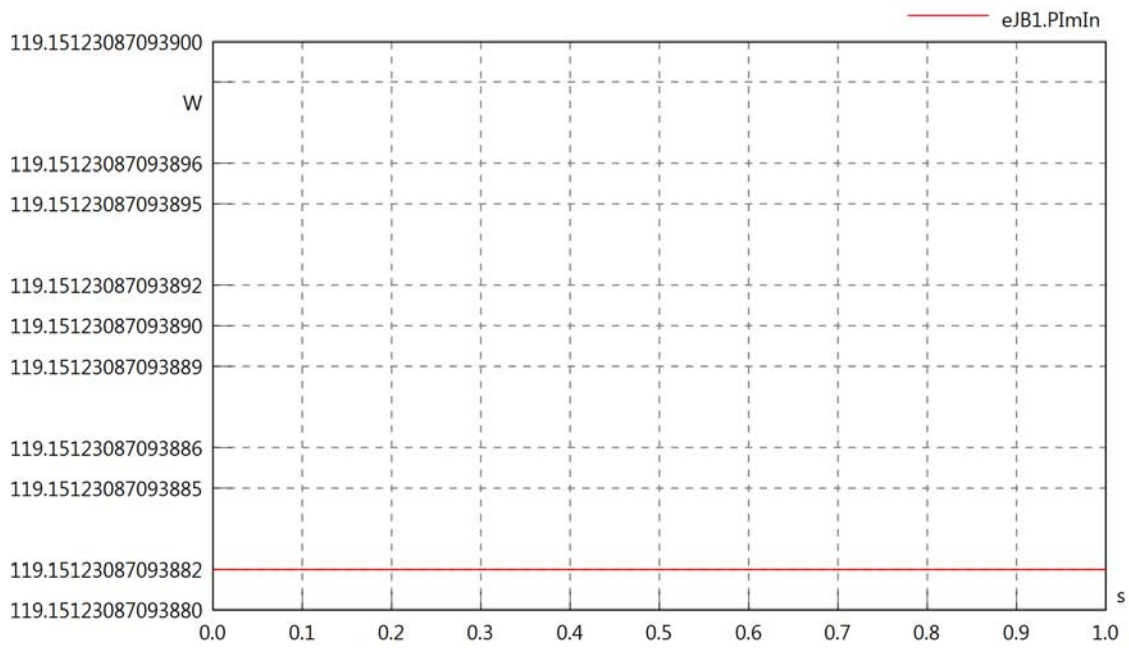

eJB1.SIn

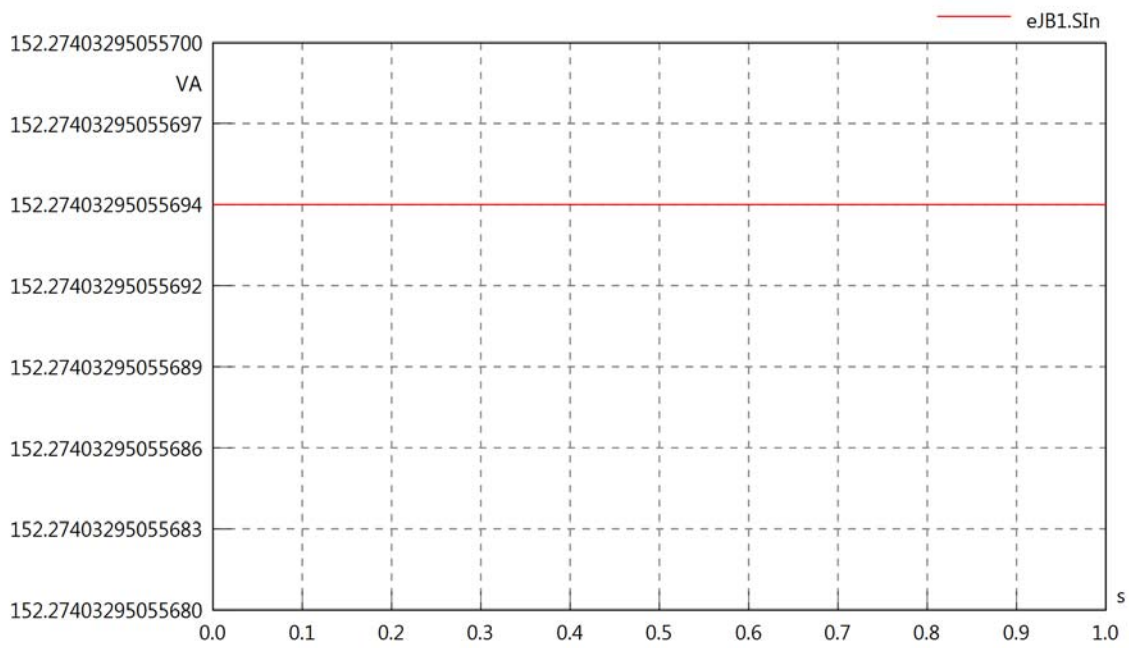

eJB1.PReOut

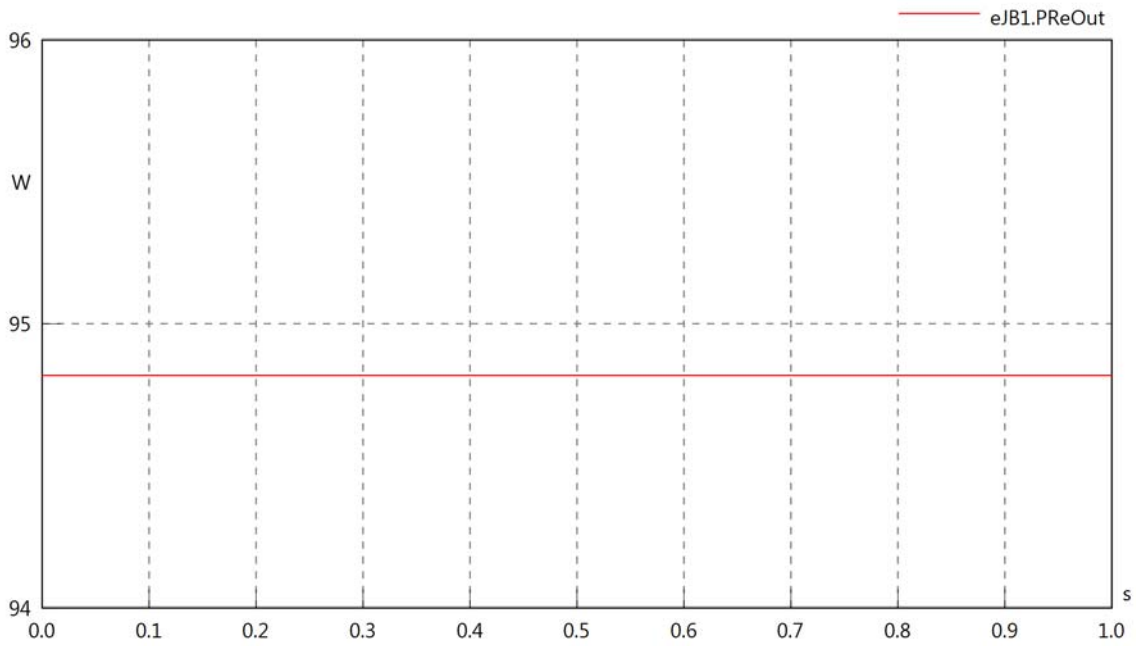

eJB1.PImOut

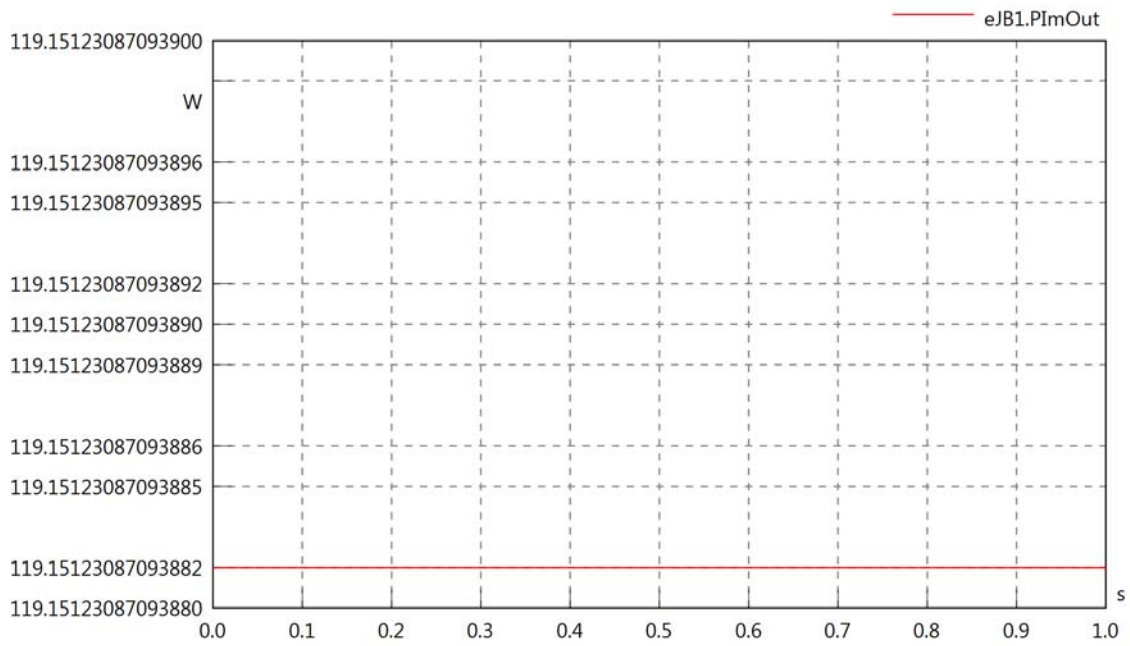

eJB1.SOut

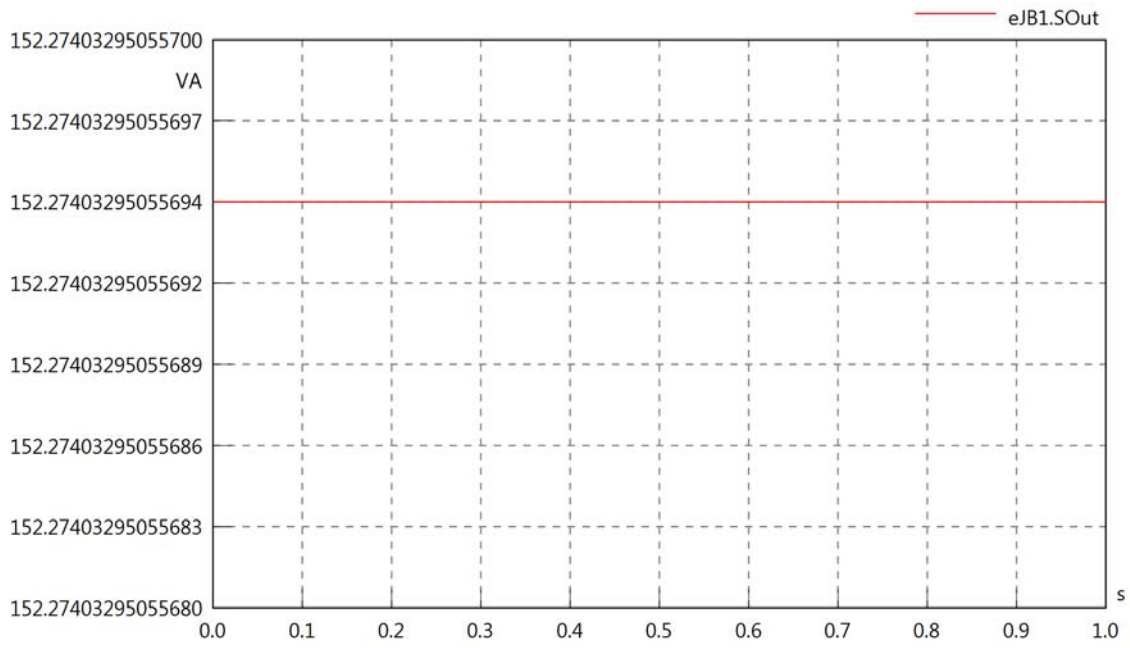
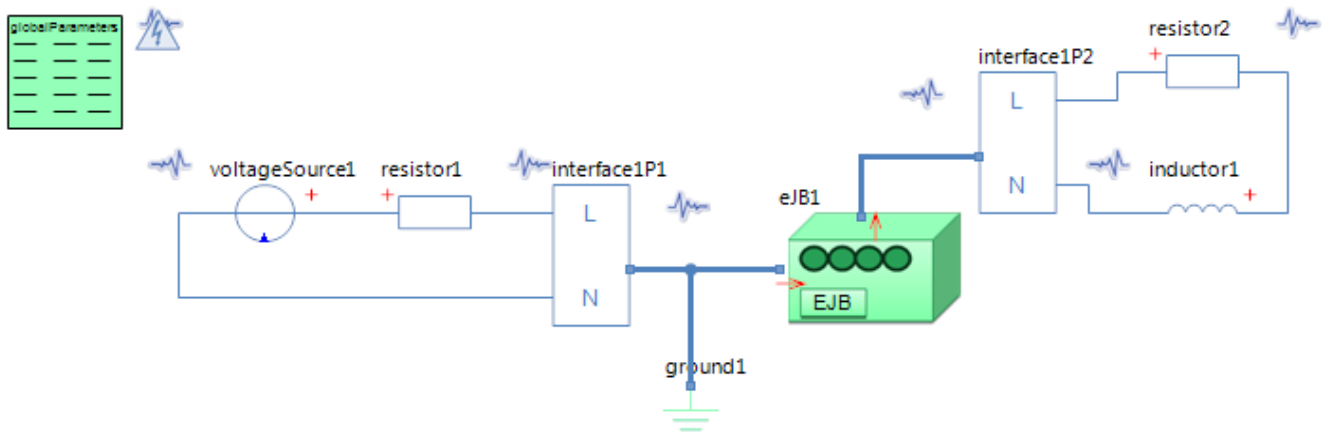

Diagram View



GlobalParameters globalParameters
Parameters

Comment	Name	Current Value	Unit
Type of Calculation	eCalculationKind	Signal Calculation	
Description of Frequency	eFrequencyKind	Linear	
Minimum Frequency	fMin	20000	[Hz]
Maximum Frequency	fMax	20000	[Hz]

Voltage Source voltageSource1
Parameters

Comment	Name	Current Value	Unit
Voltage RMS	VrmsSrc	230	[V]
Phase	phi	0	[deg]

Resistor resistor1
Parameters

Comment	Name	Current Value	Unit
Resistance	R	100	[Ohm]

Resistor resistor2
Parameters

Comment	Name	Current Value	Unit
Resistance	R	100	[Ohm]

Electrical Junction Box eJB1
Parameters

Comment	Name	Current Value	Unit
Poor or failing L1 connection	bL1	false	

Inductor inductor1
Parameters

Comment	Name	Current Value	Unit
Inductance	L	5	[mH]

eJB1.VrmsIn

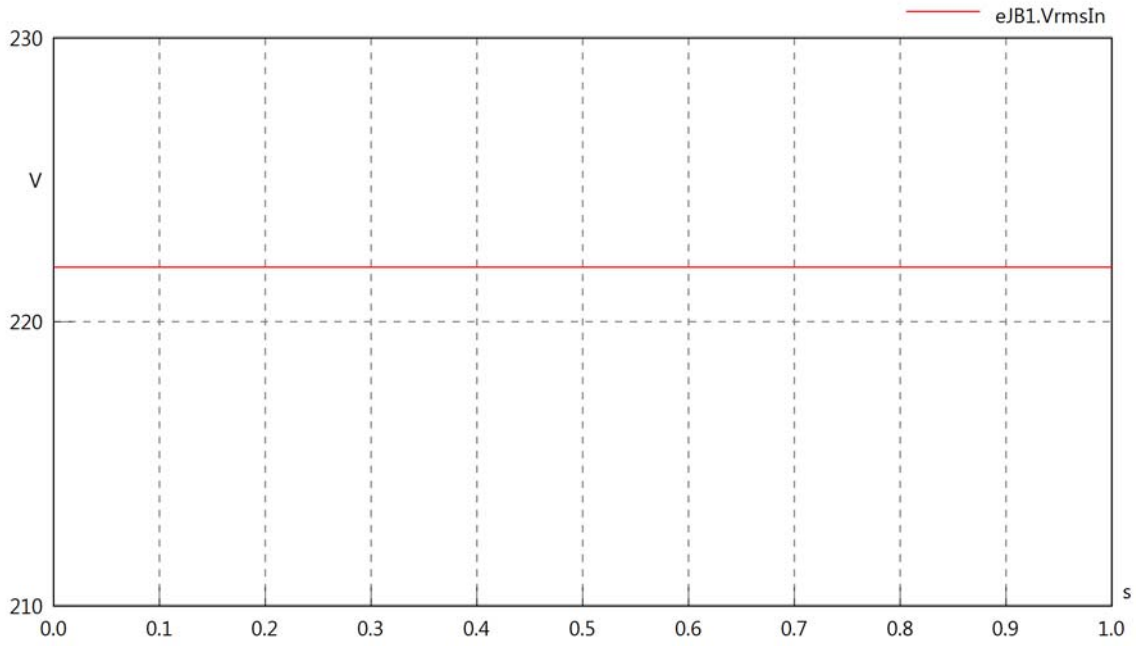

eJB1.vReIn

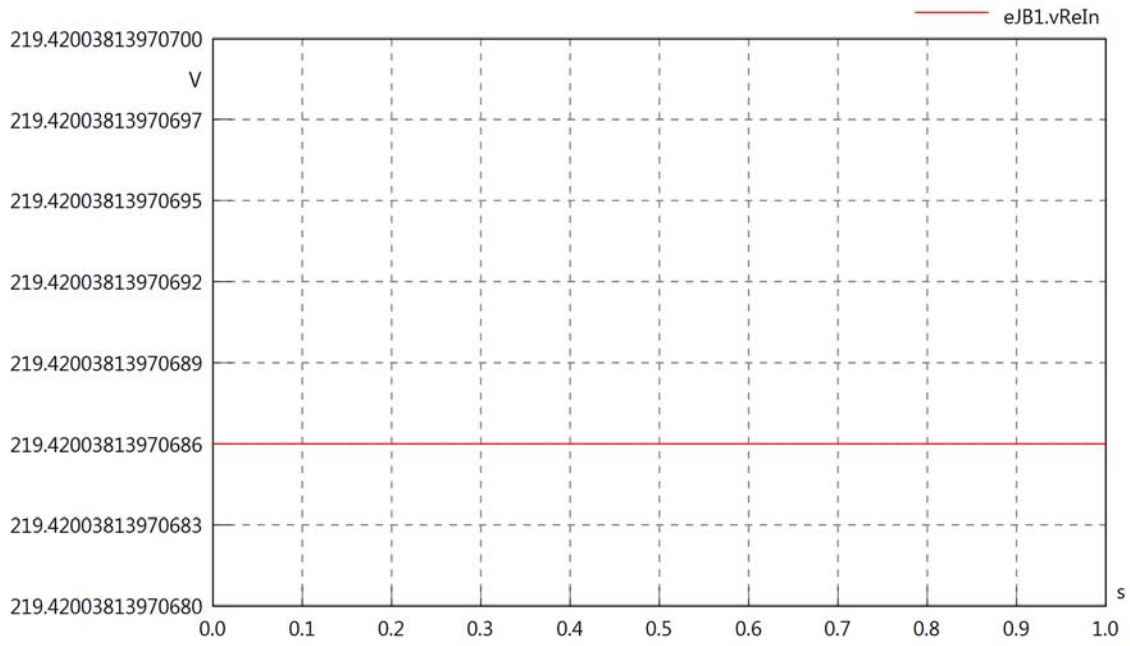

eJB1.vImIn

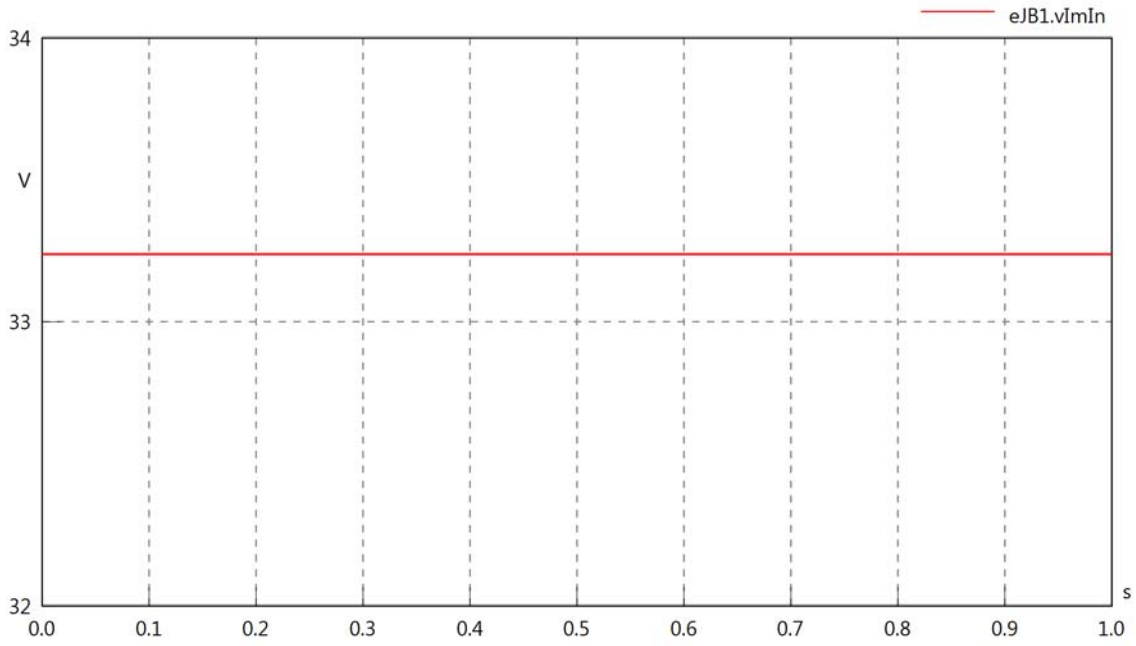

eJB1.VrmsOut

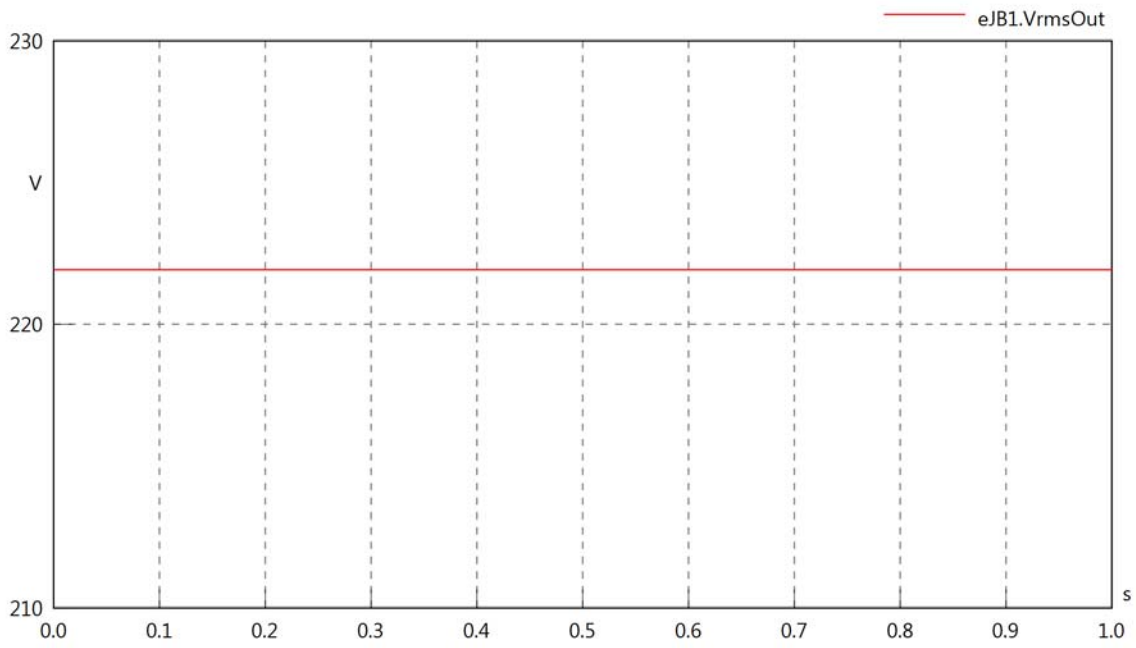

eJB1.vReOut

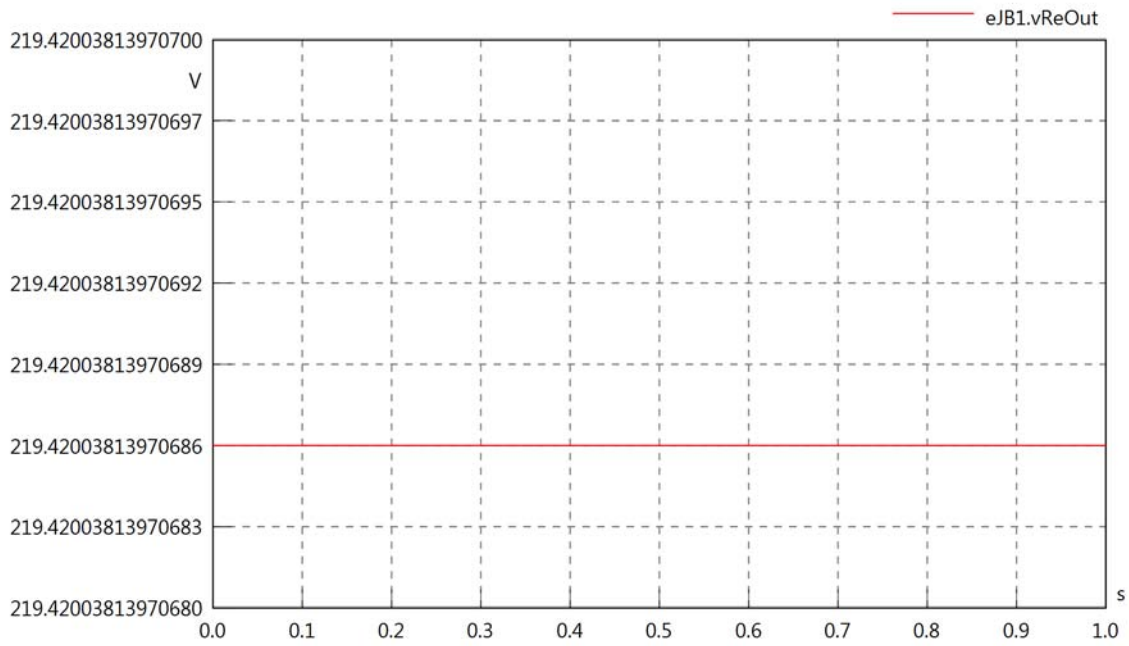

eJB1.vImOut

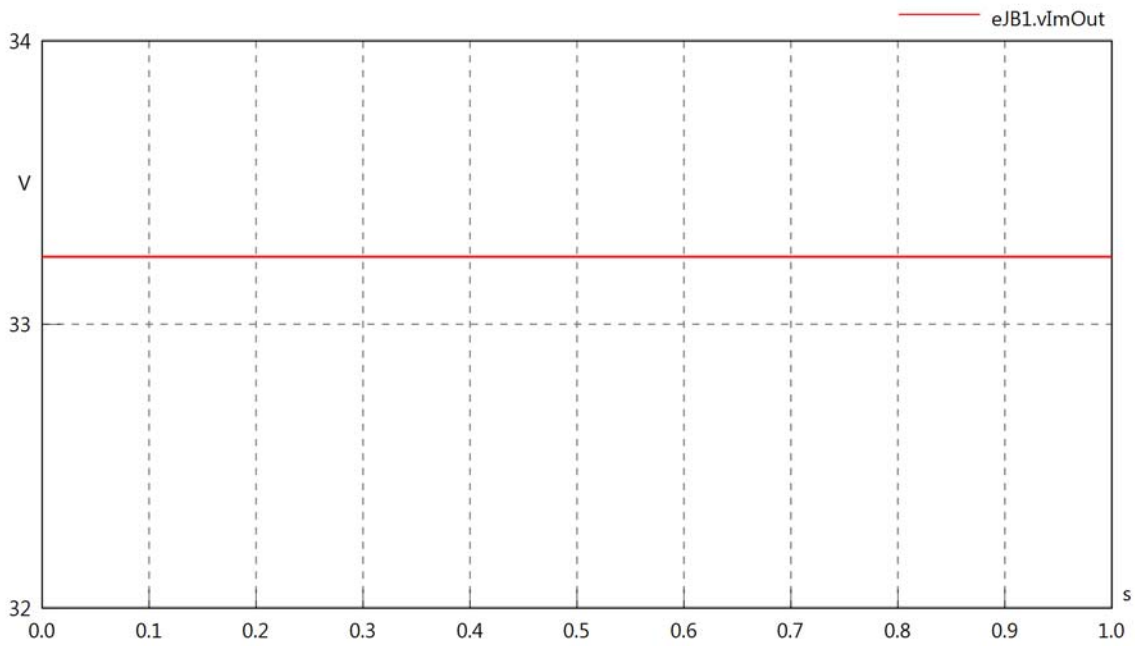

eJB1.Vrms

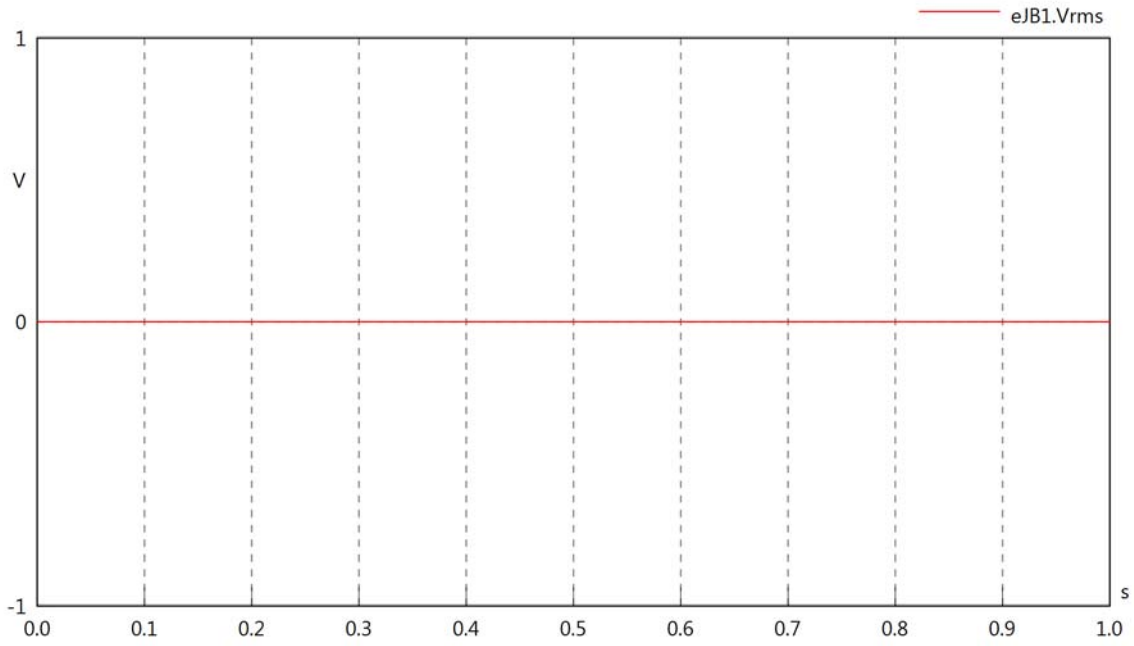

eJB1.vRe

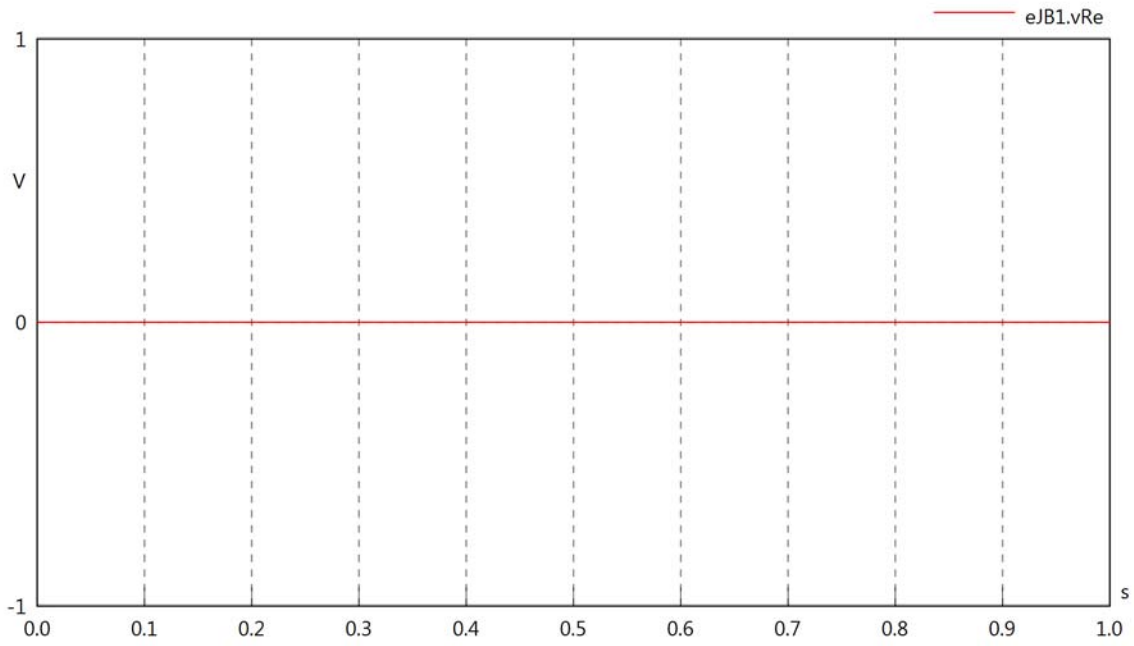

eJB1.vIm

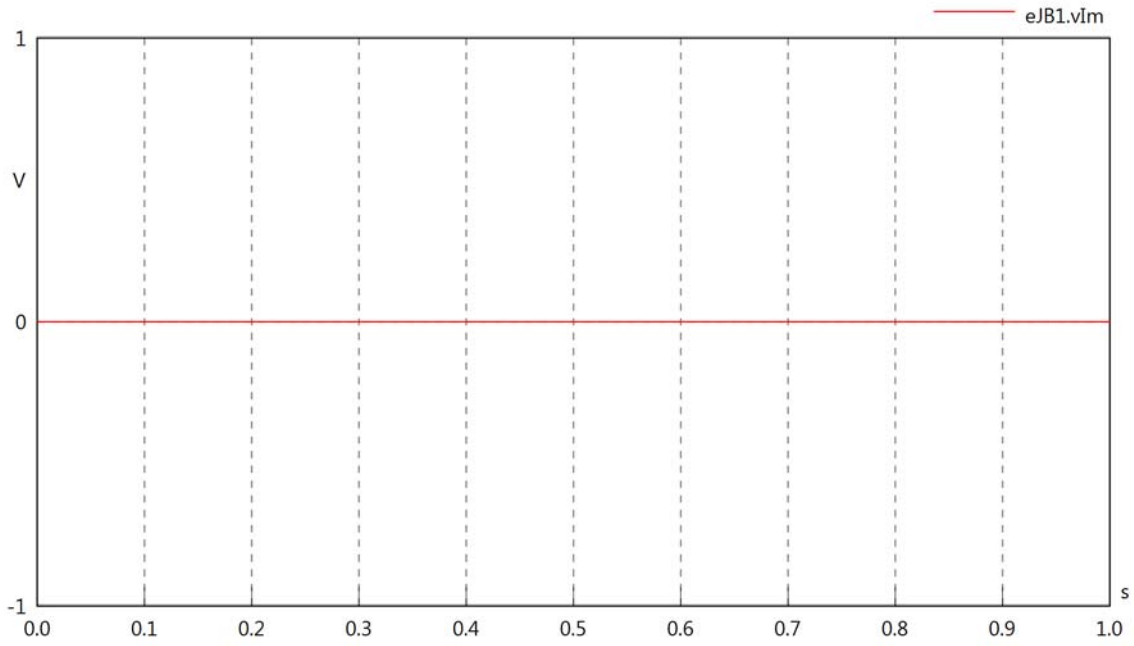

eJB1.IrmsIn

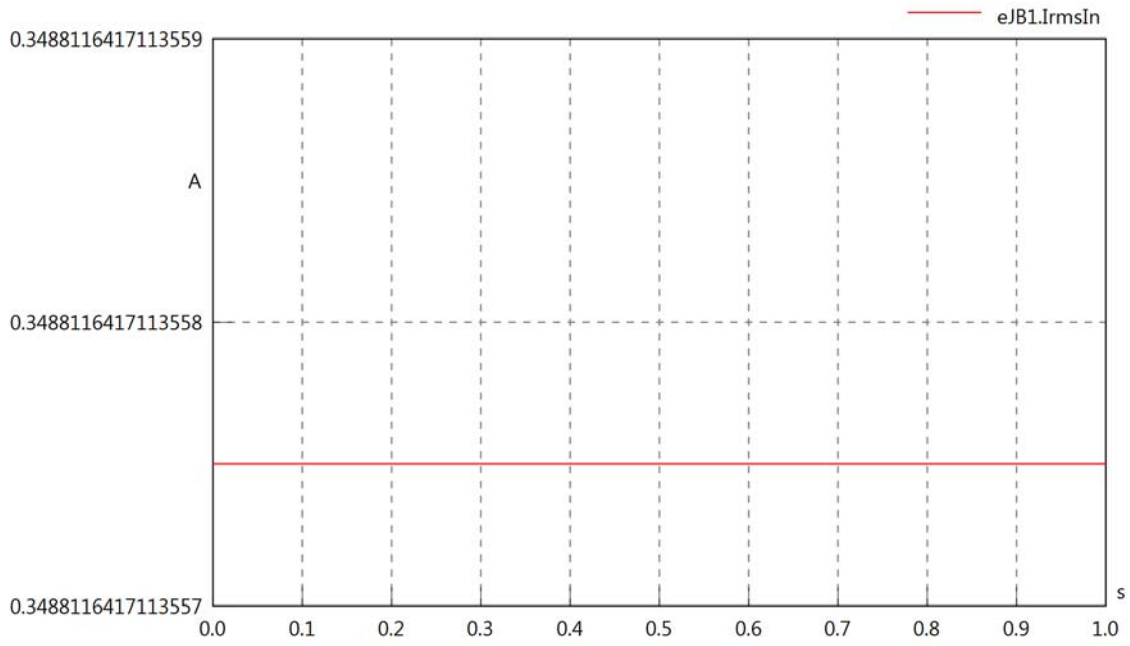

eJB1.iReIn

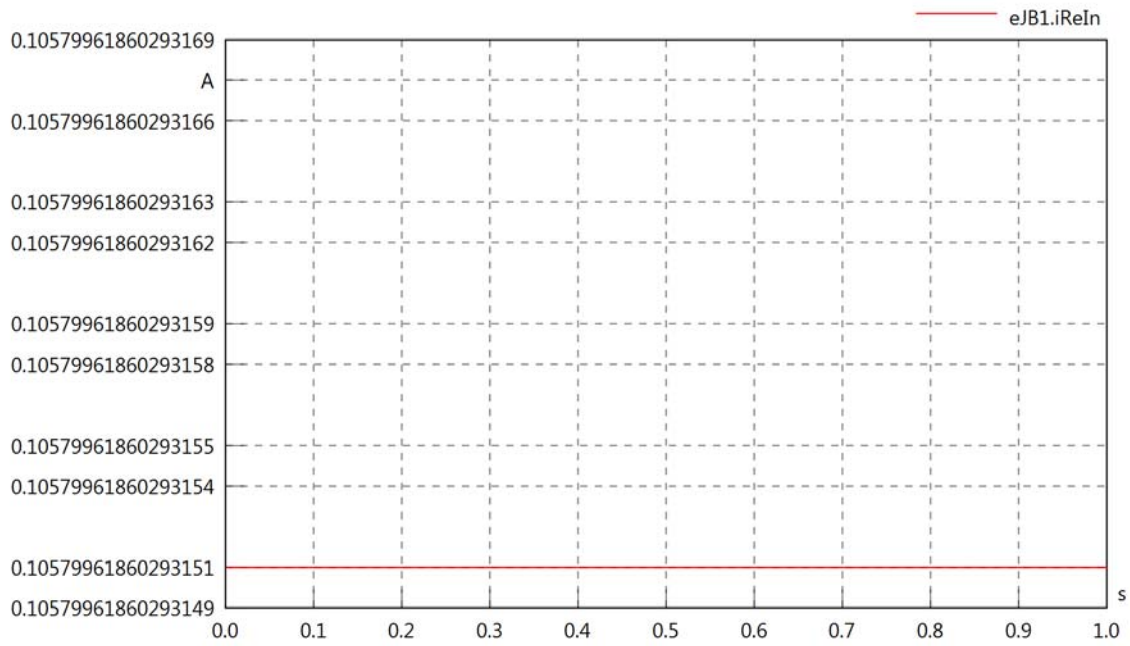

eJB1.iImIn

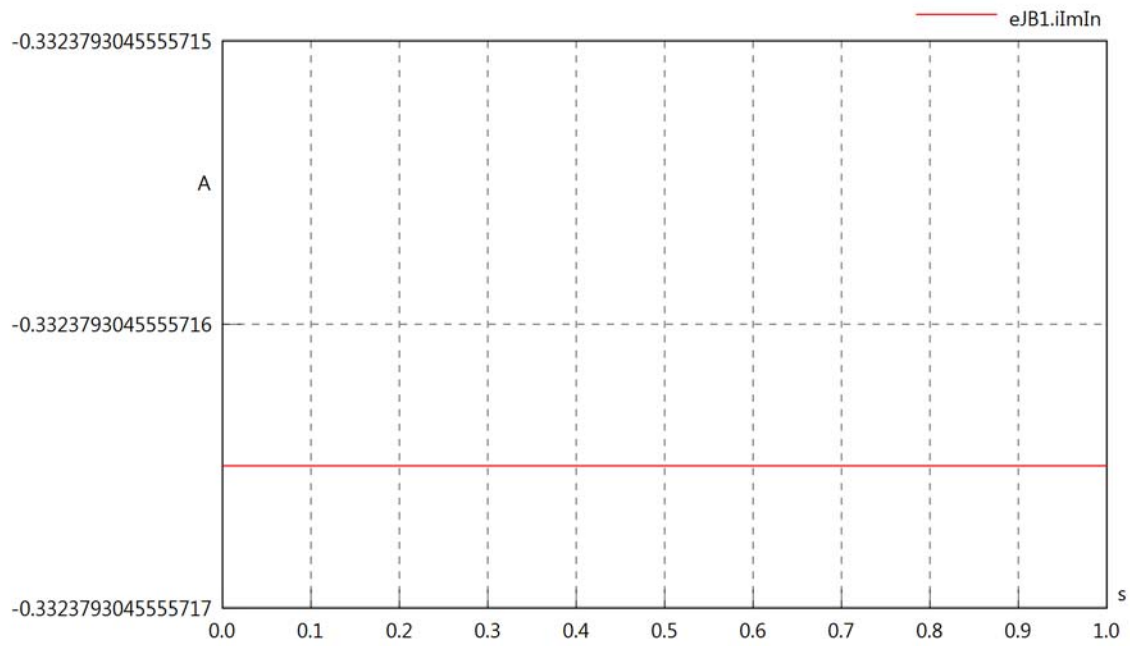

eJB1.IrmsOut

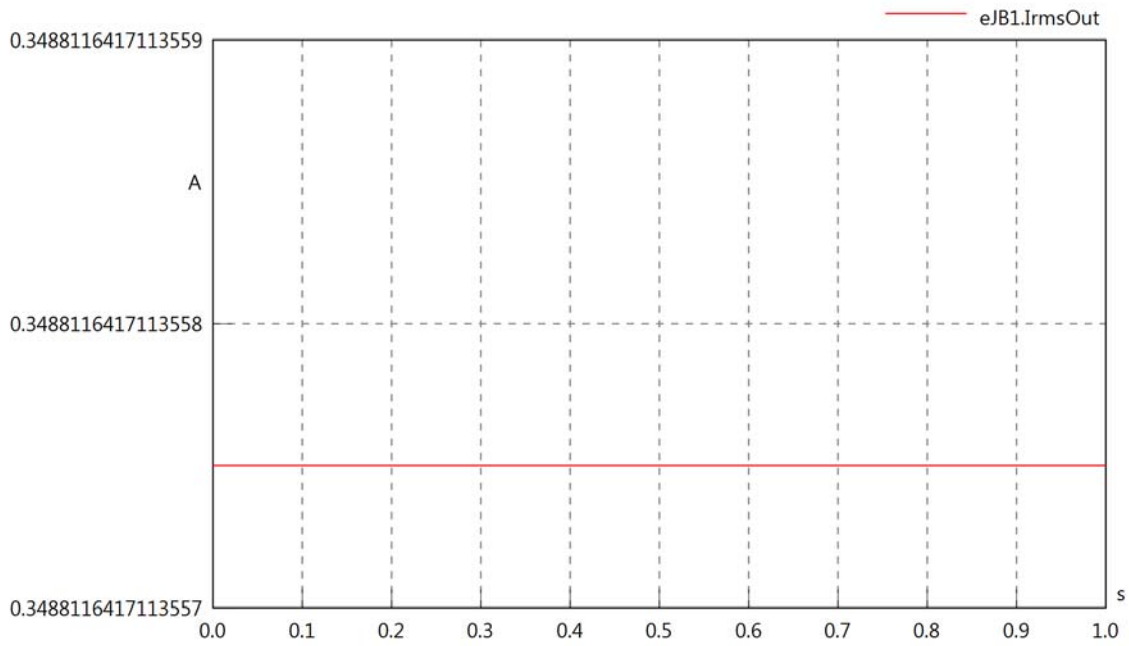

eJB1.iReOut

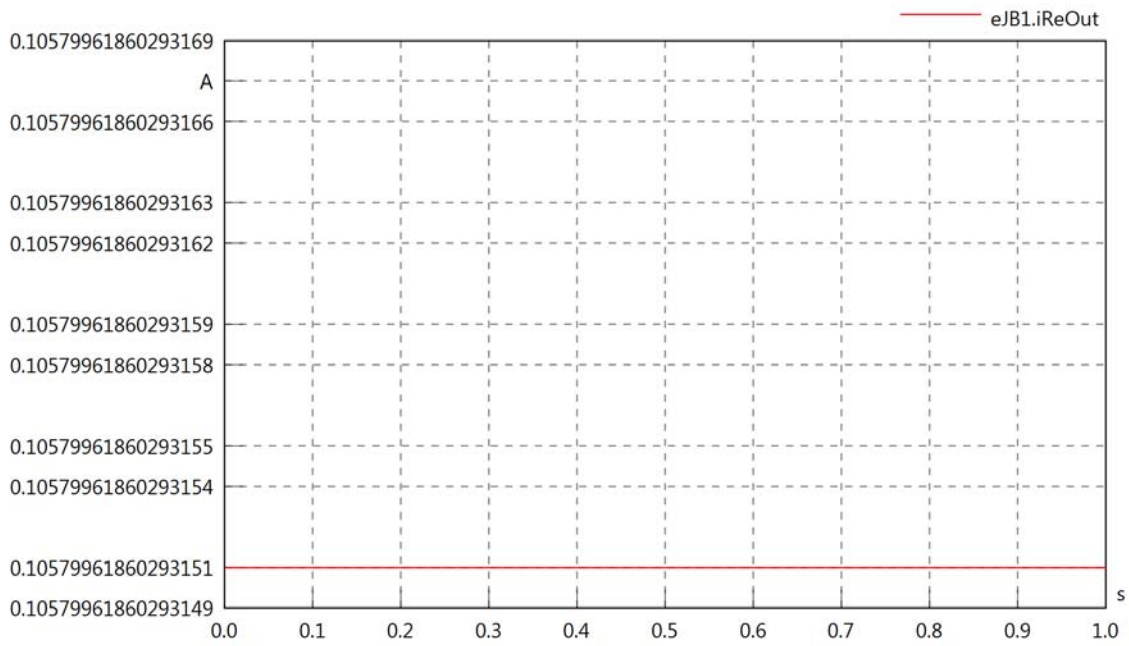

eJB1.iImOut

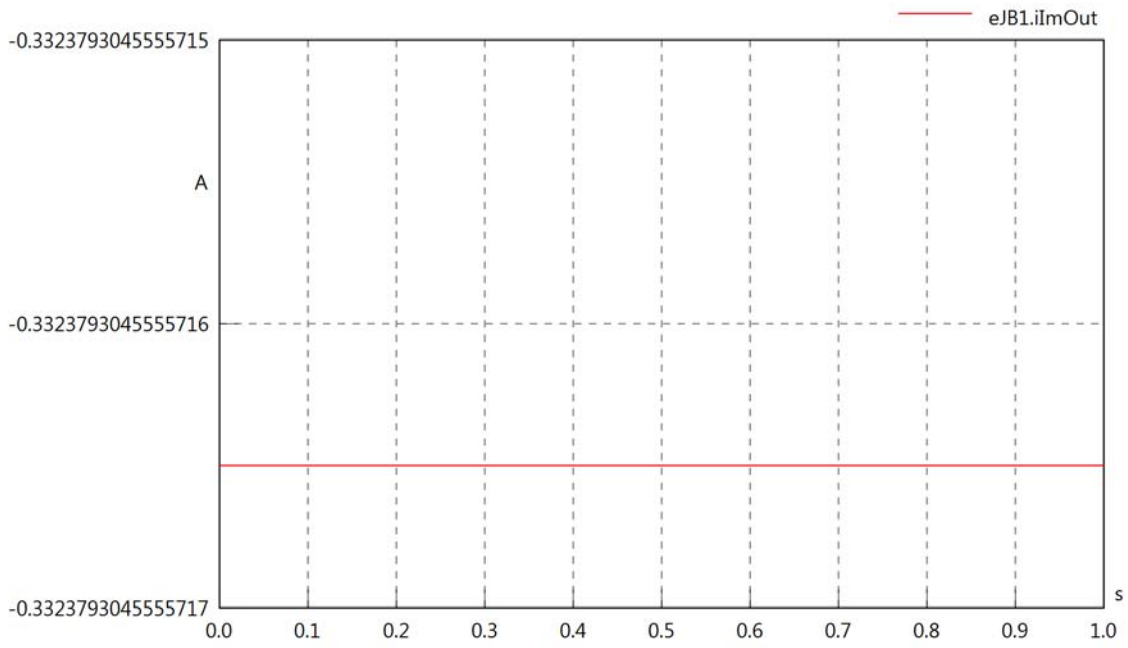

eJB1.phiVIn

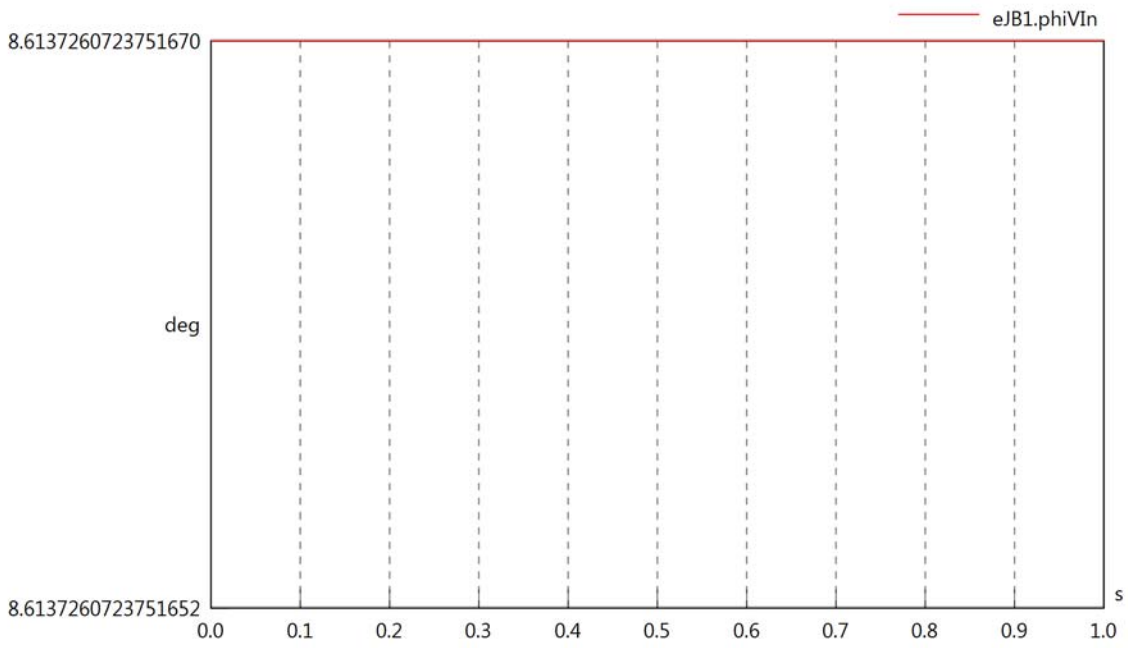

eJB1.phiIn

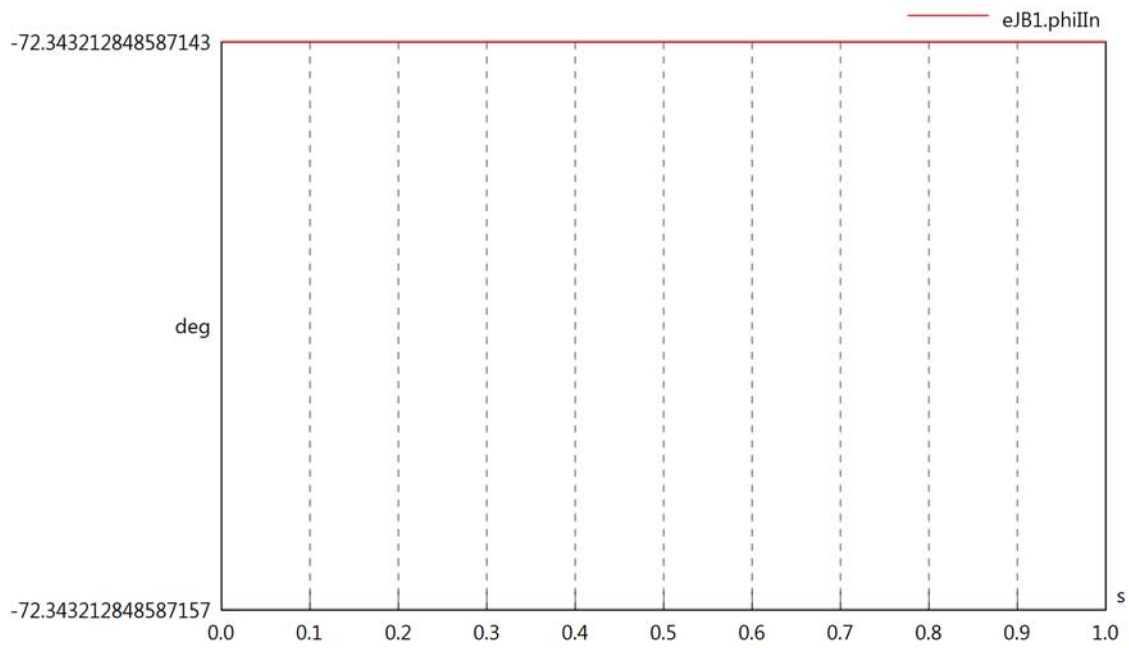

eJB1.phiIVIn

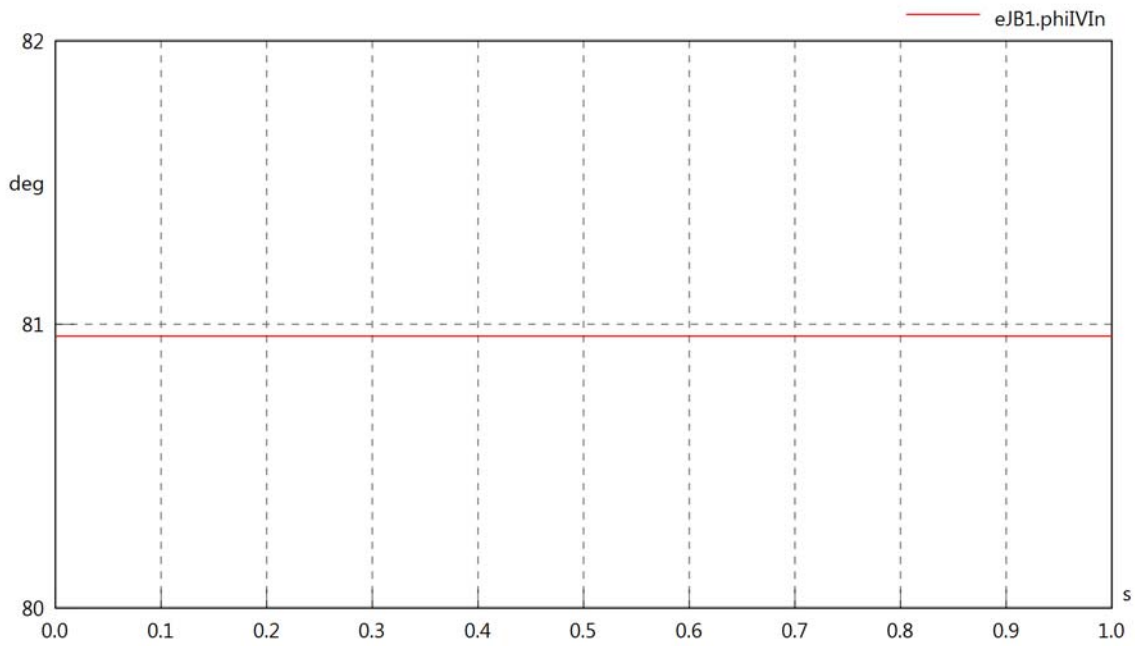

eJB1.phiVOut

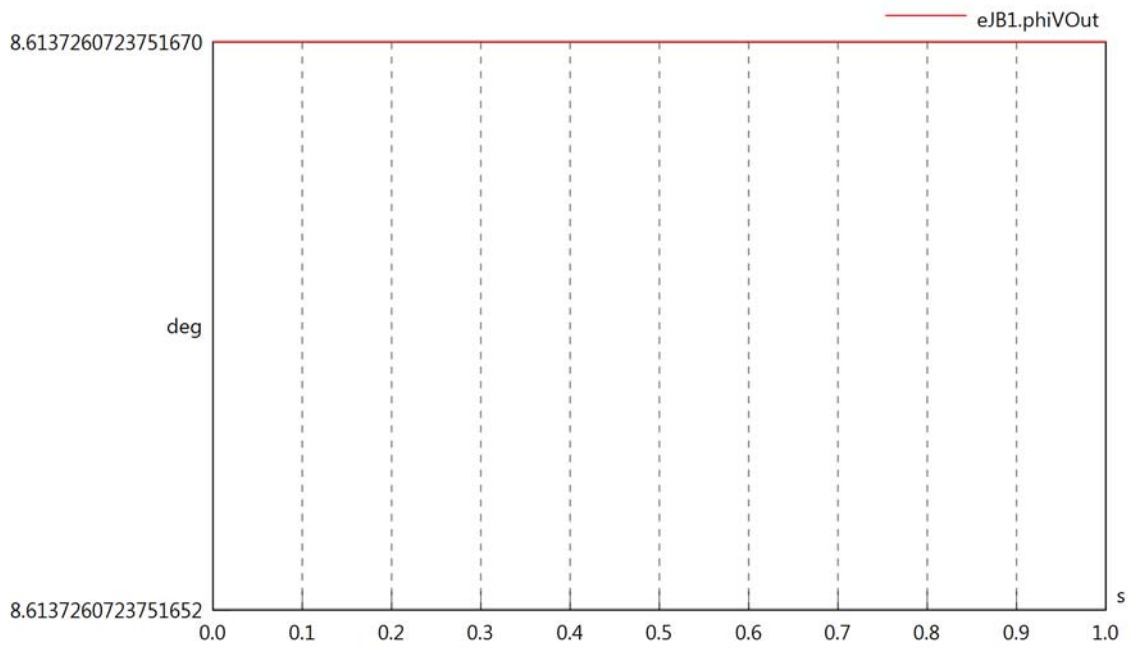

eJB1.phiIOut

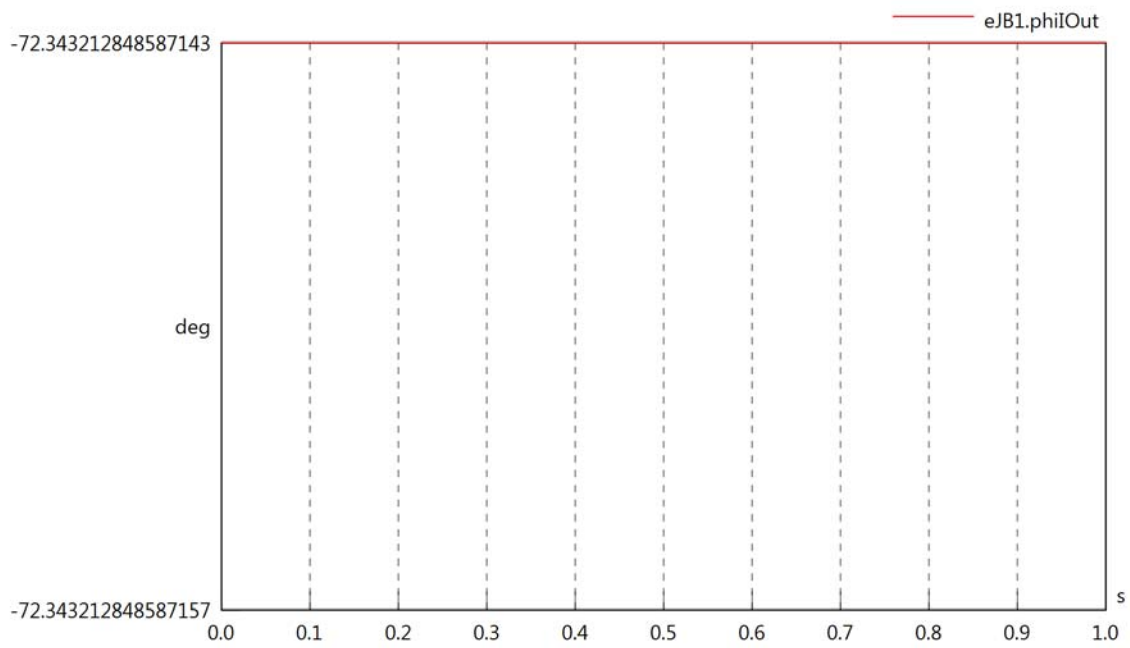

eJB1.phiIVOut

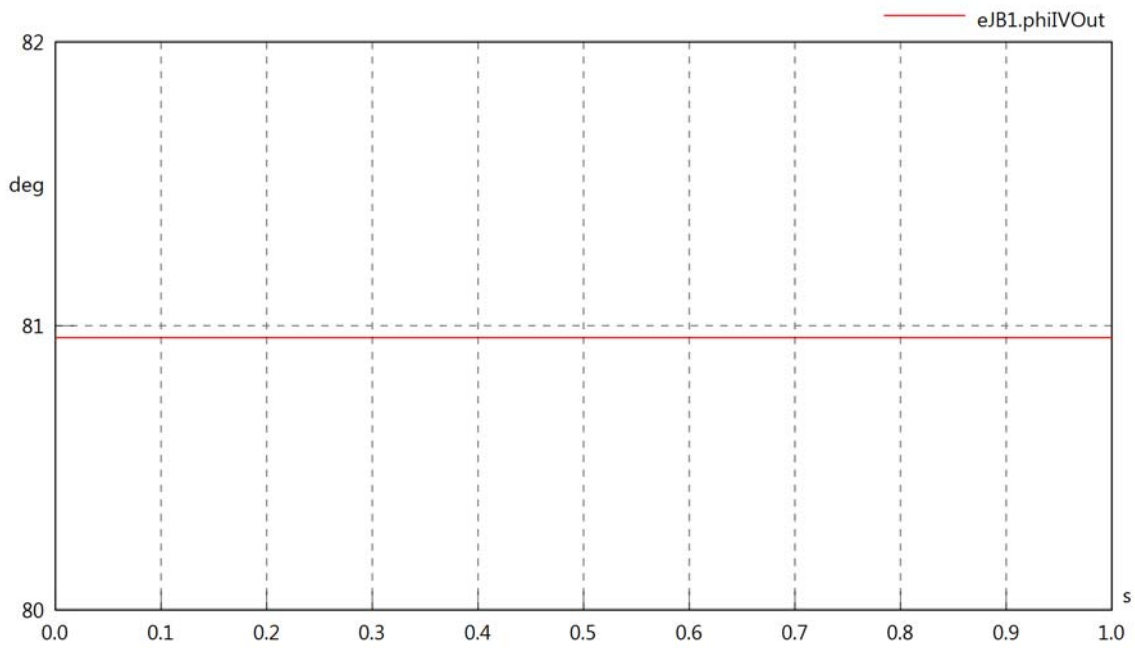

eJB1.PReIn

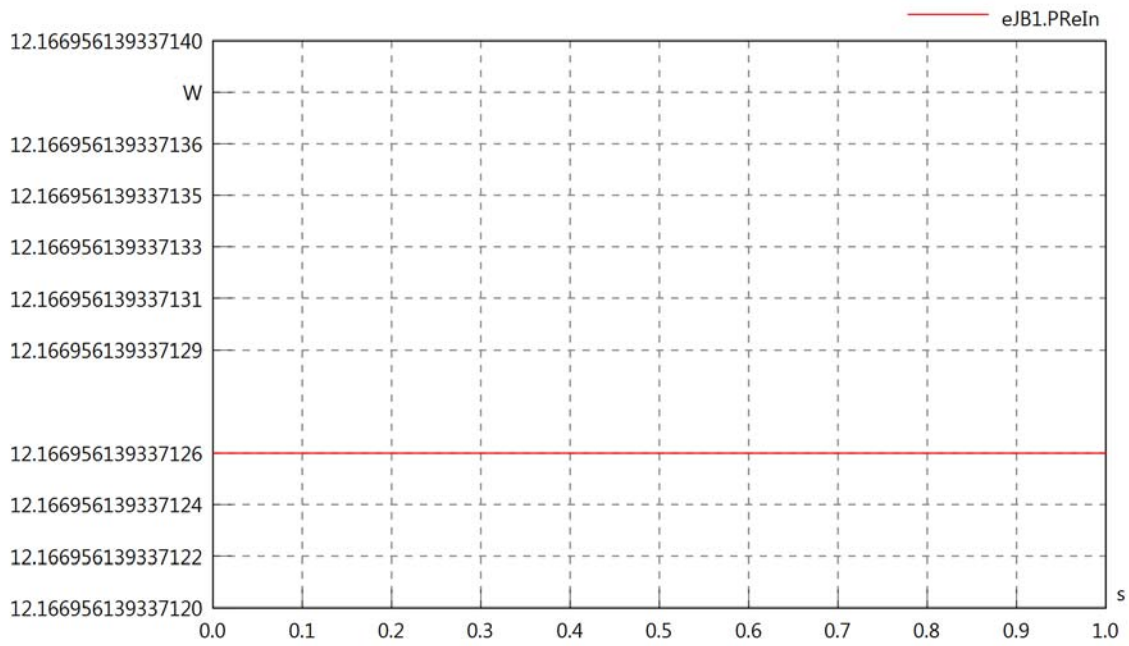

eJB1.PImIn

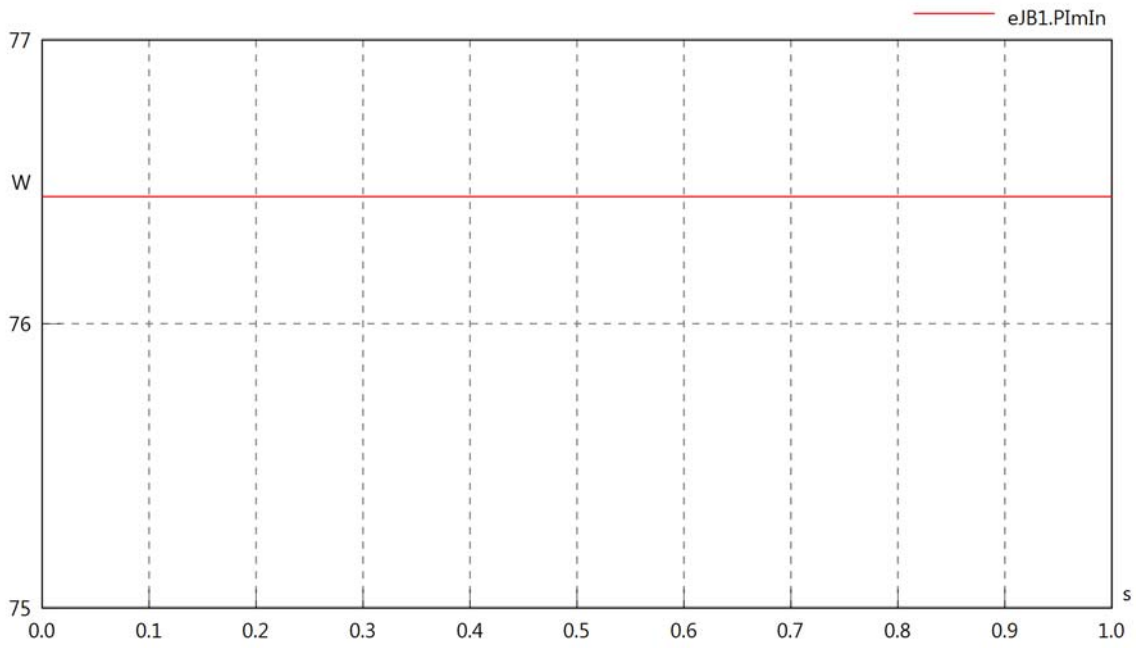

eJB1.SIn

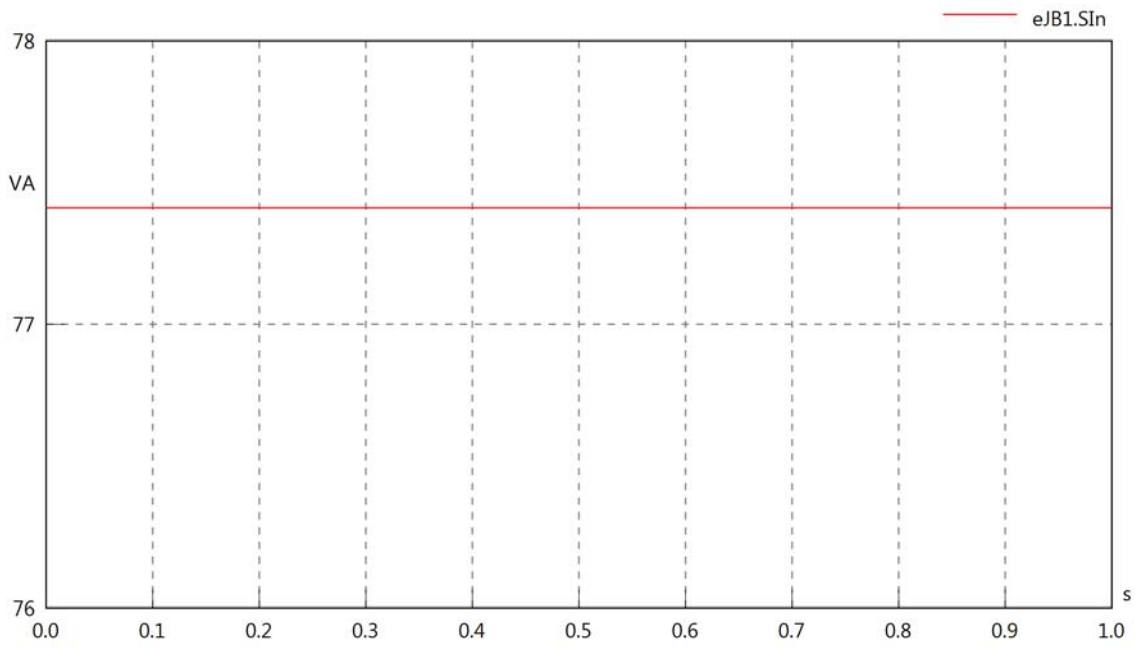

eJB1.PReOut

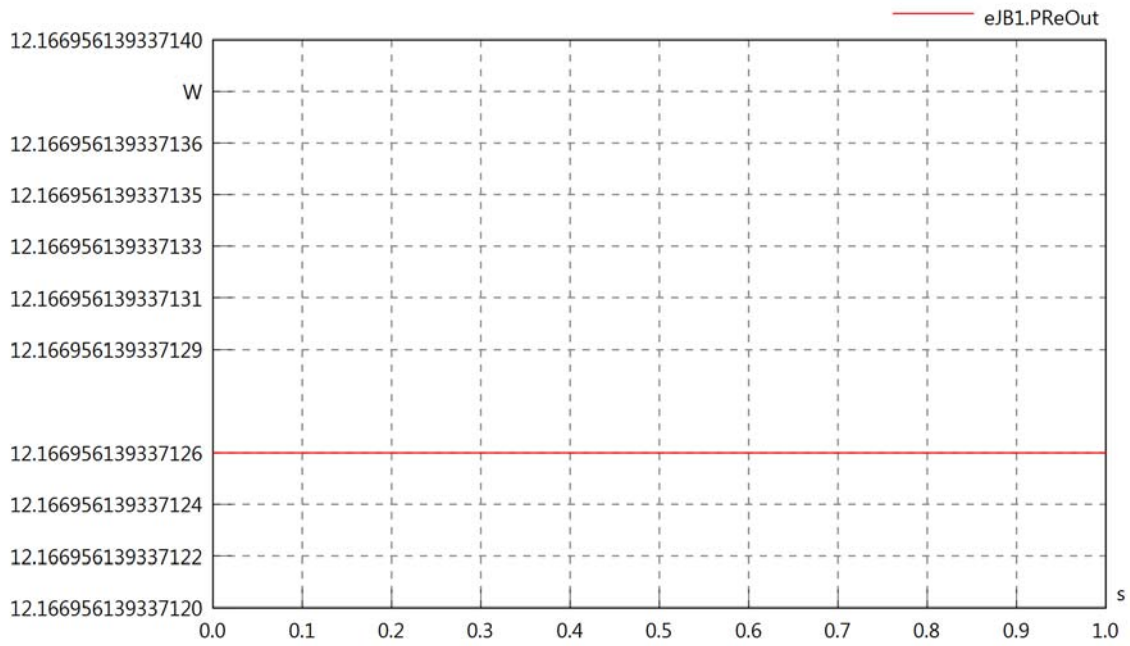

eJB1.PImOut

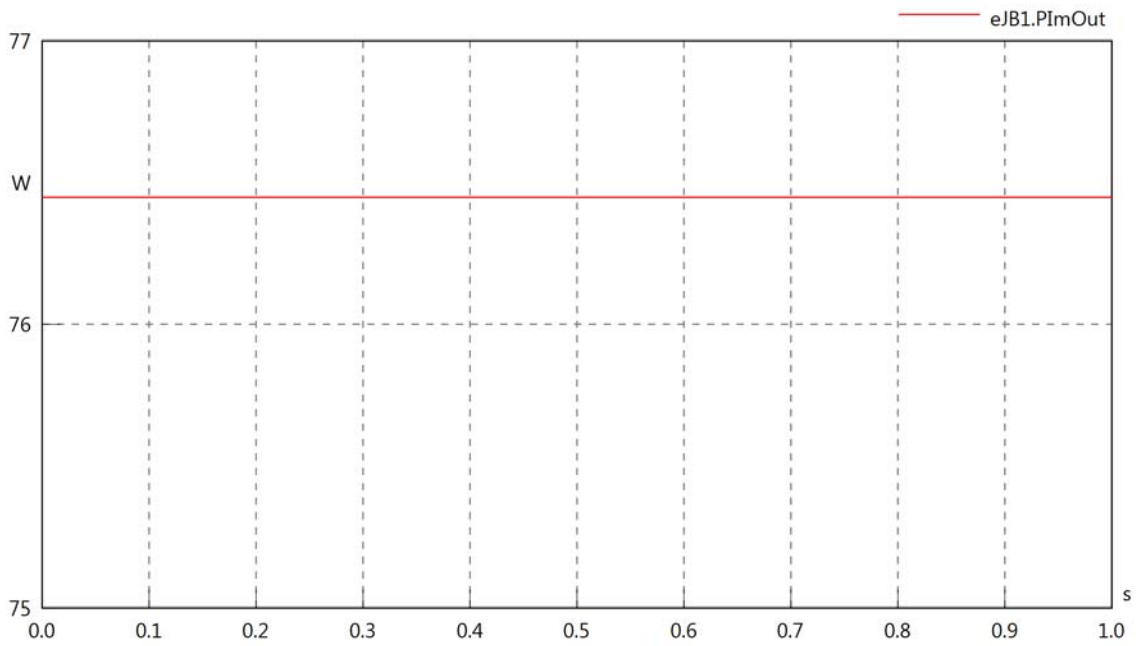



eJB1.SOut

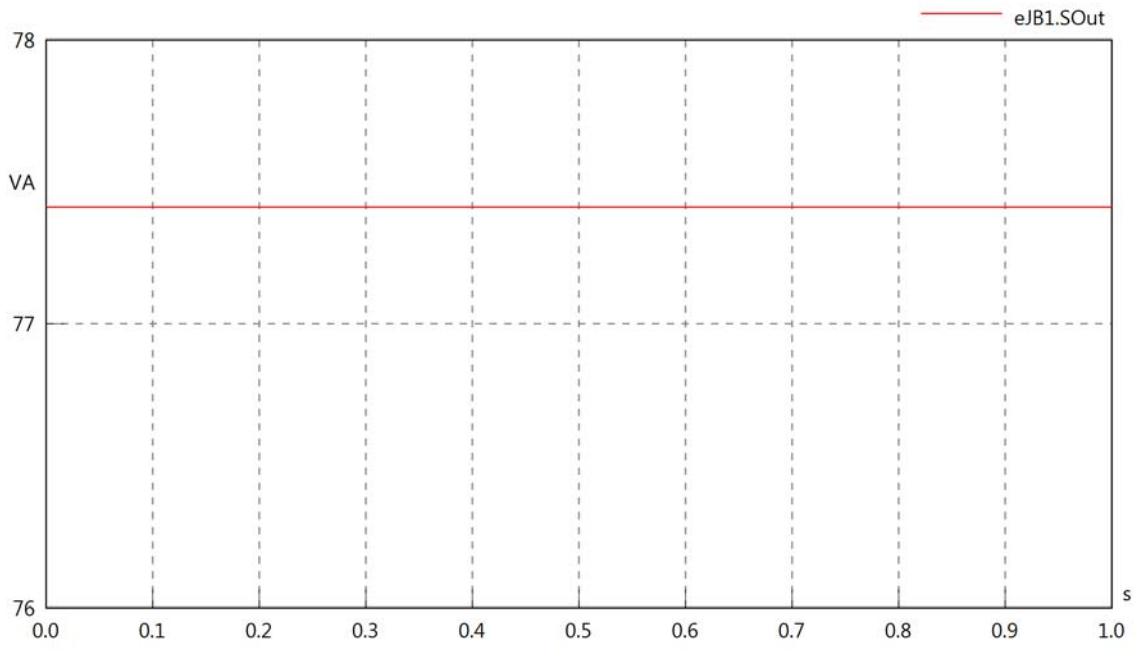
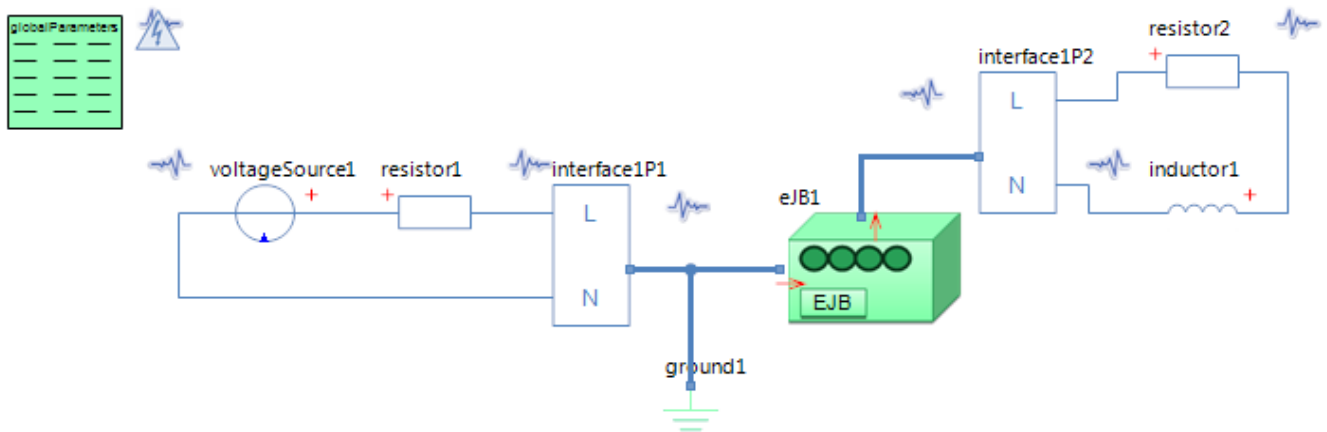

Diagram View



GlobalParameters globalParameters
Parameters

Comment	Name	Current Value	Unit
Type of Calculation	eCalculationKind	Signal Calculation	
Description of Frequency	eFrequencyKind	Linear	
Minimum Frequency	fMin	60	[Hz]
Maximum Frequency	fMax	60	[Hz]

Voltage Source voltageSource1
Parameters

Comment	Name	Current Value	Unit
Voltage RMS	VrmsSrc	230	[V]
Phase	phi	0	[deg]

Resistor resistor1
Parameters

Comment	Name	Current Value	Unit
Resistance	R	100	[Ohm]

Resistor resistor2
Parameters

Comment	Name	Current Value	Unit
Resistance	R	100	[Ohm]

Electrical Junction Box eJB1
Parameters

Comment	Name	Current Value	Unit
Poor or failing L1 connection	bL1	true	
Resistance in L1 connection	rL1	1	[kOhm]
Conductance between L1 and N	G	50	[1/Ohm]

Inductor inductor1
Parameters

Comment	Name	Current Value	Unit
Inductance	L	5	[mH]

eJB1.VrmsIn

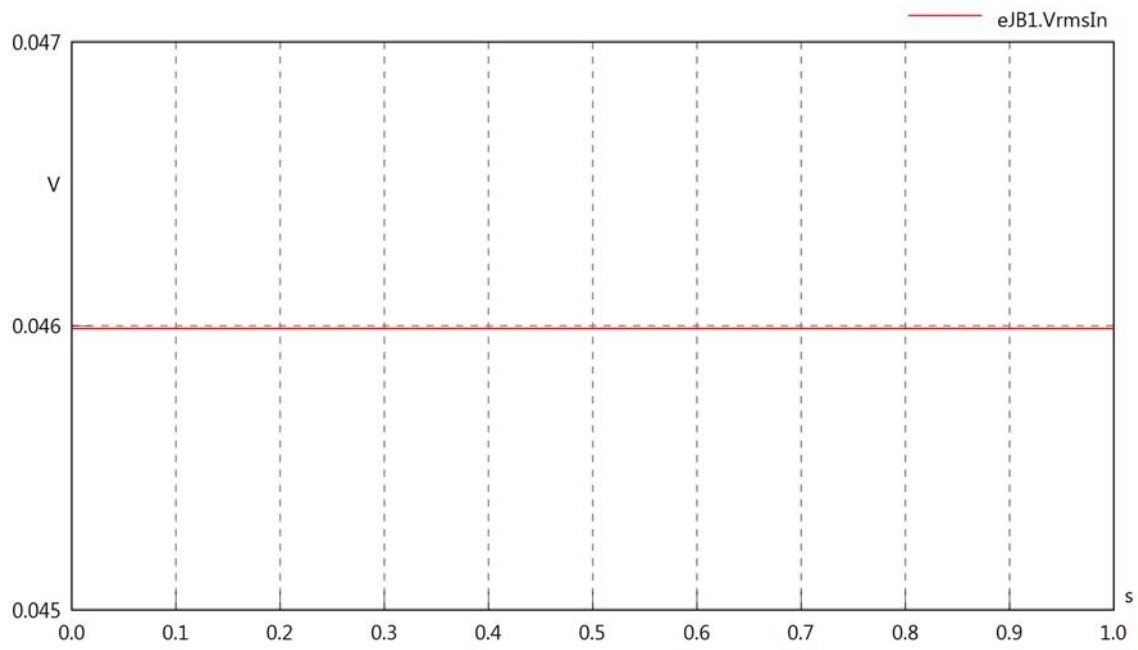

eJB1.vReIn

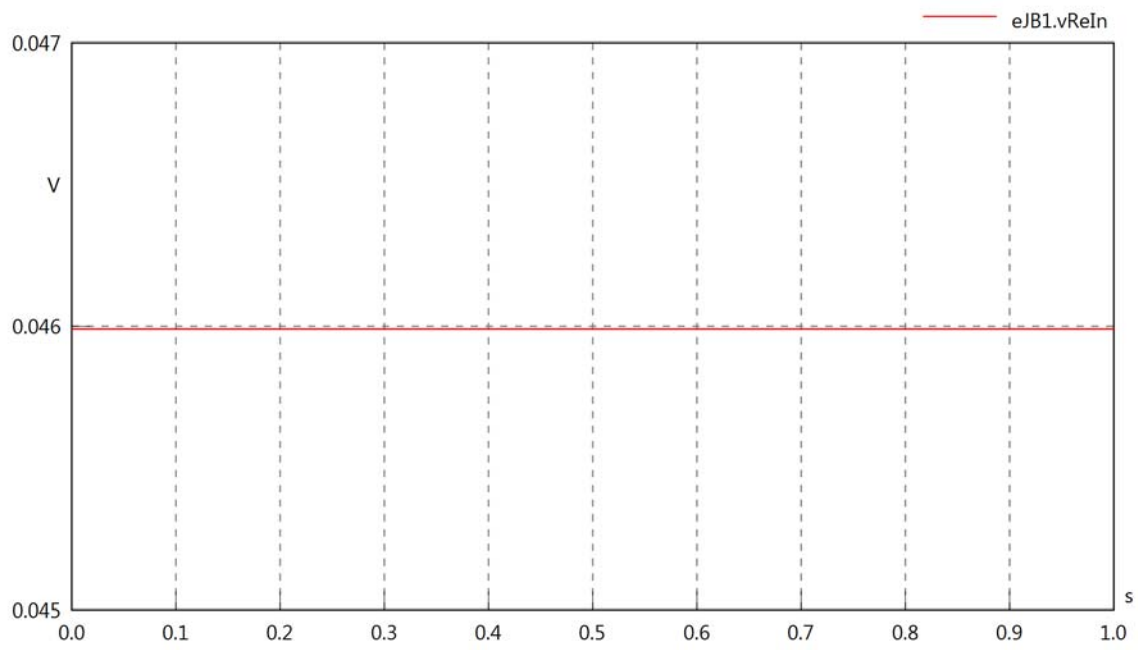

eJB1.vImIn

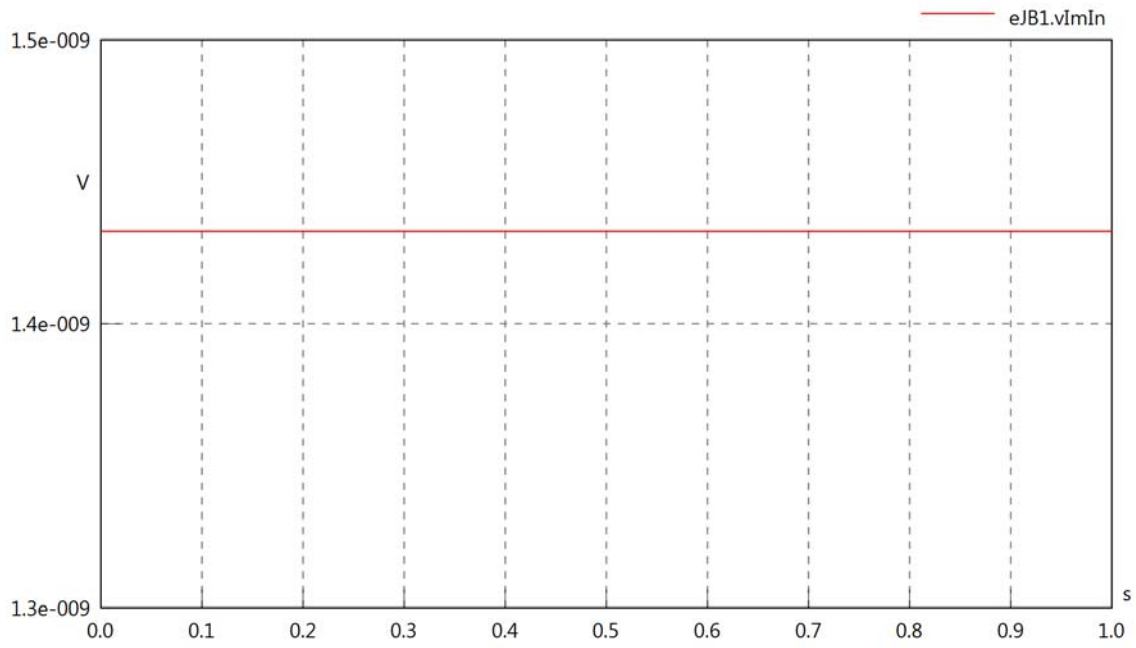

eJB1.VrmsOut

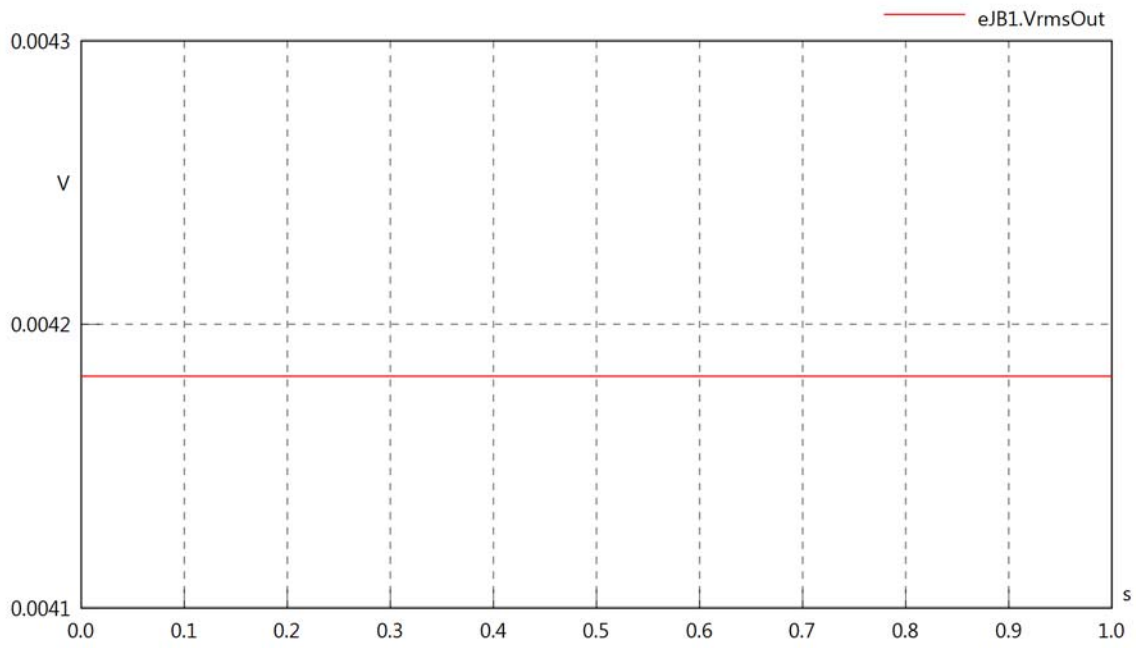

eJB1.vReOut

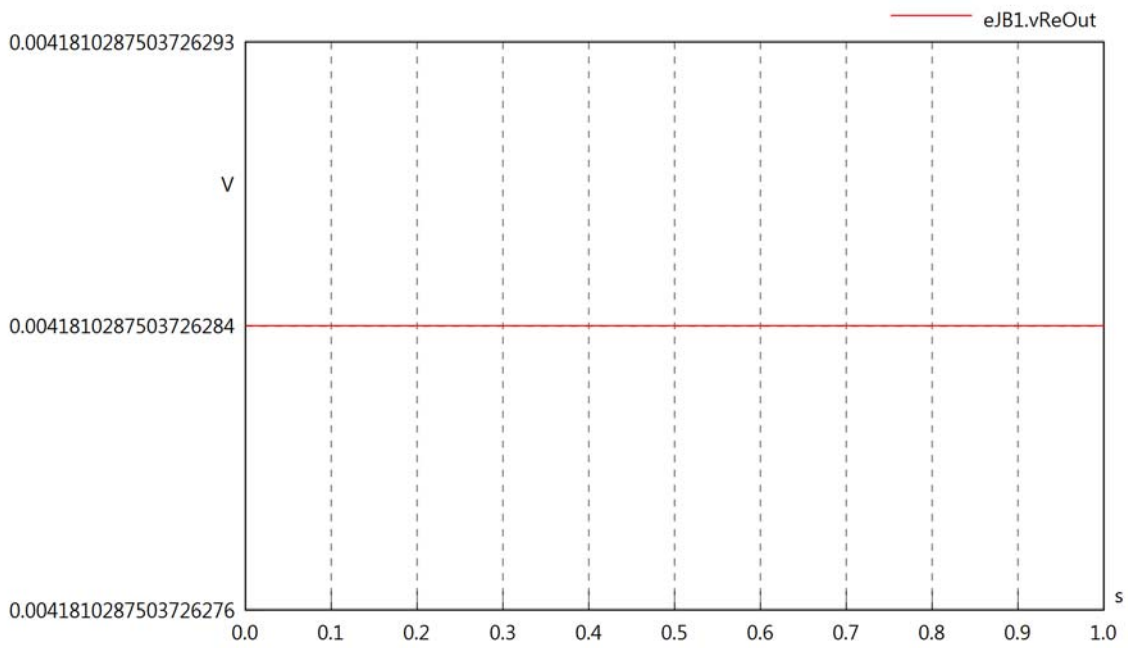

eJB1.vImOut

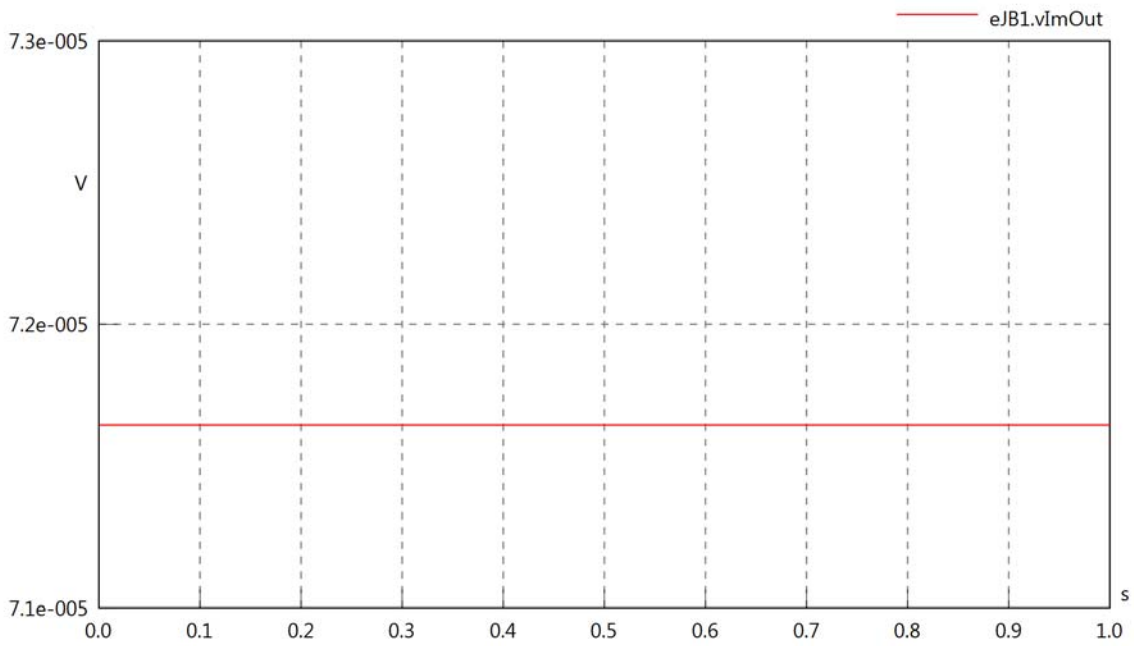

eJB1.Vrms

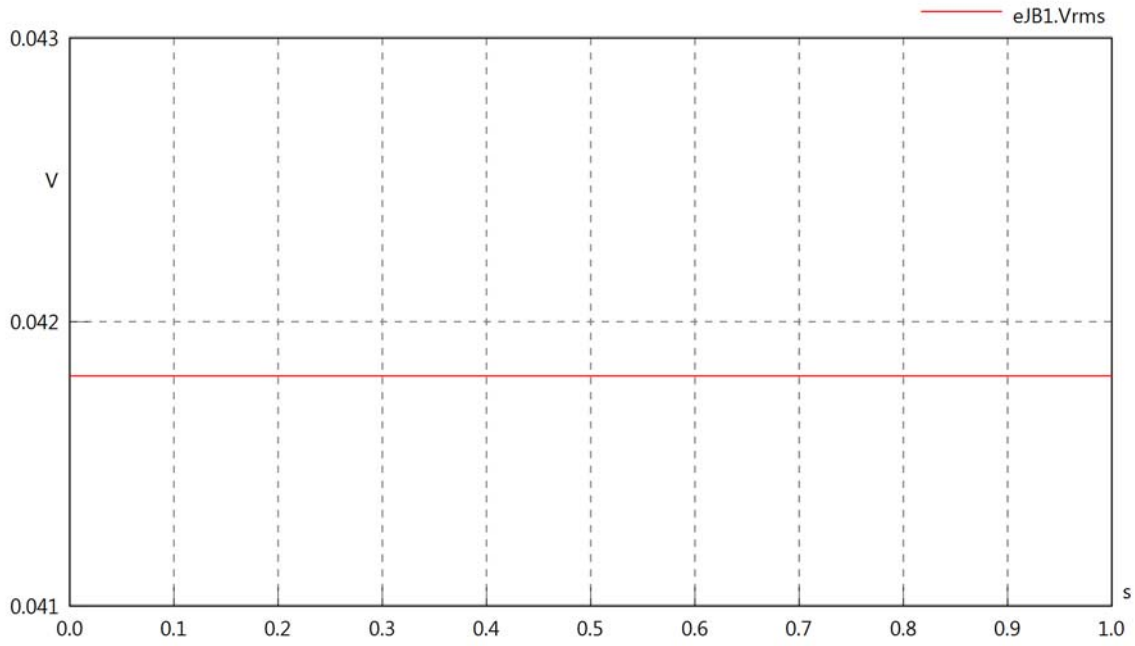

eJB1.vRe

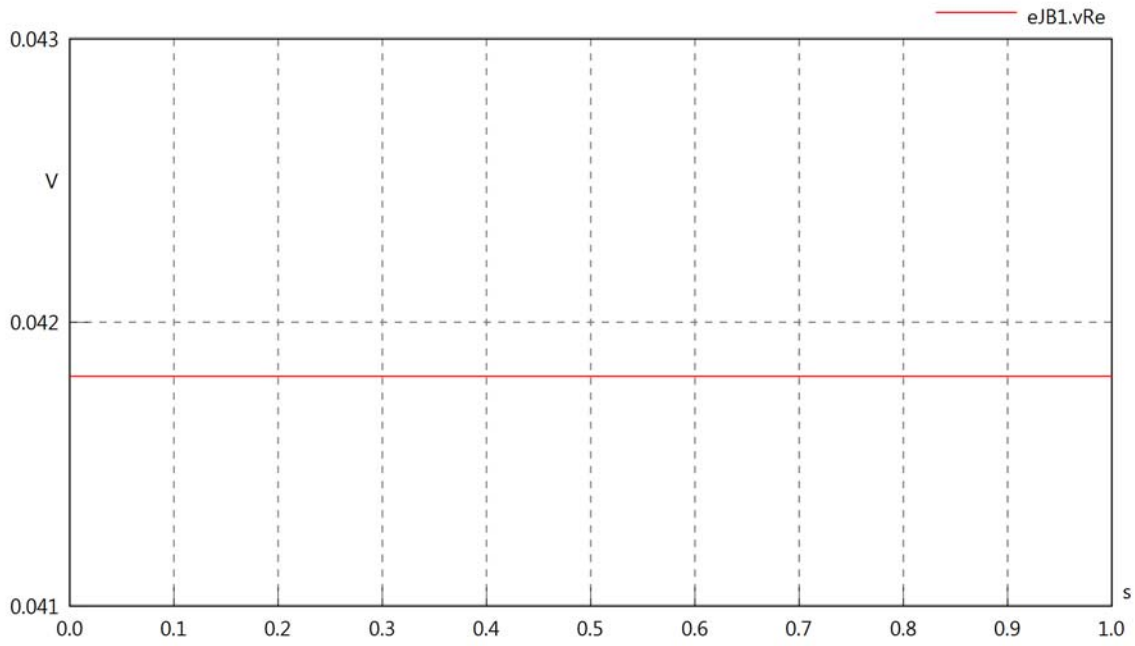

eJB1.vIm

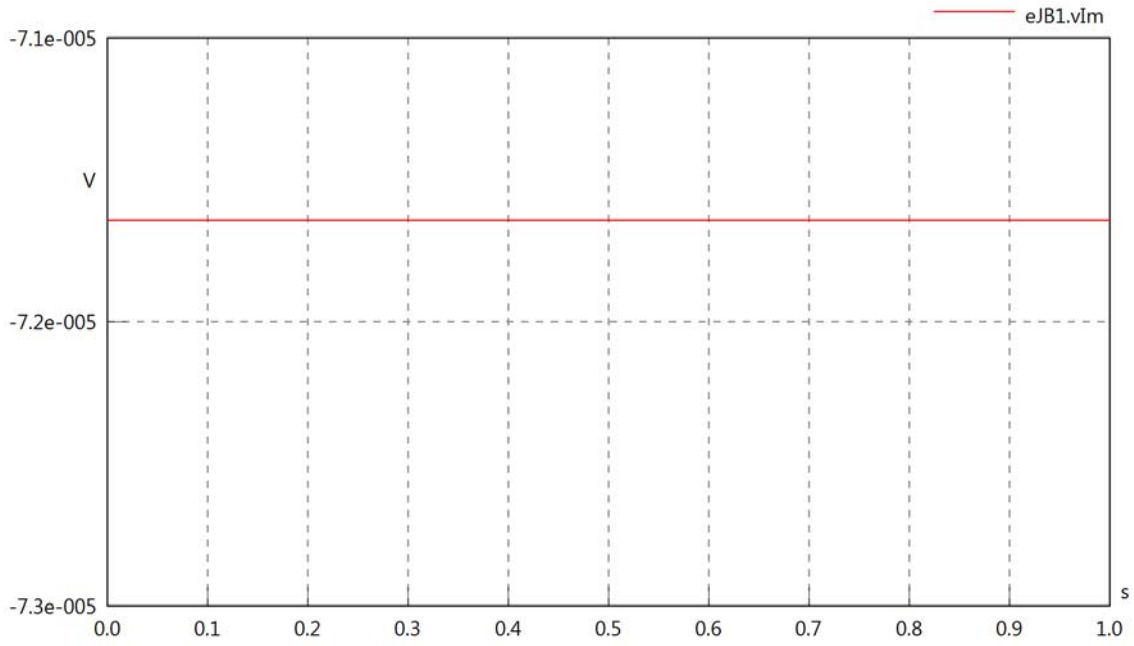

eJB1.IrmsIn

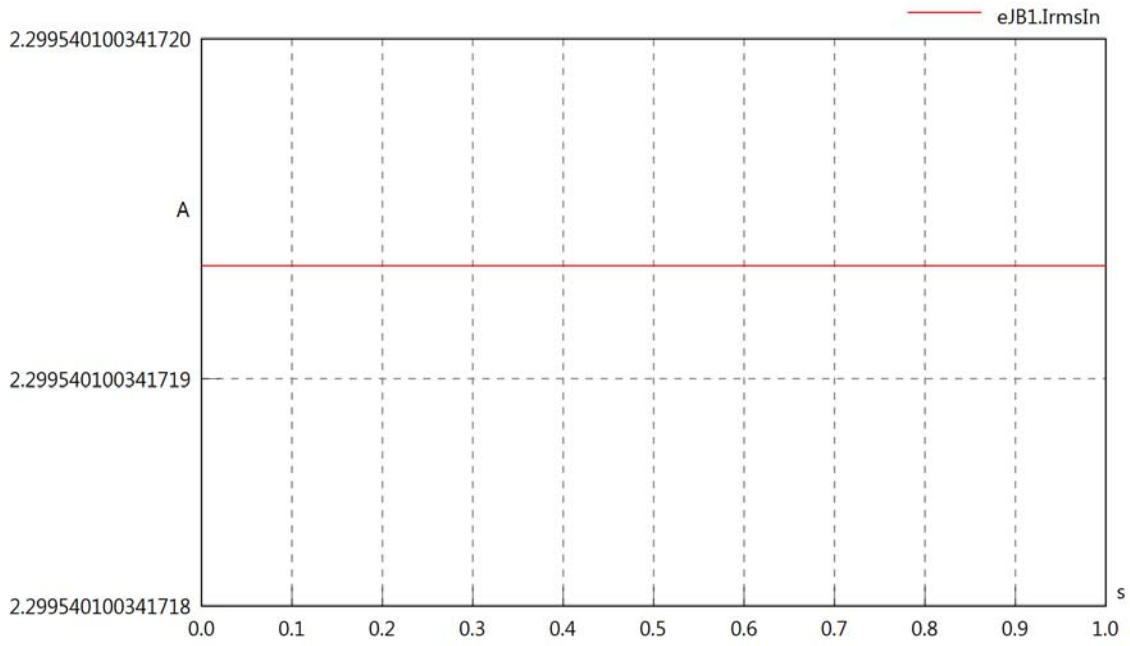

eJB1.iReIn

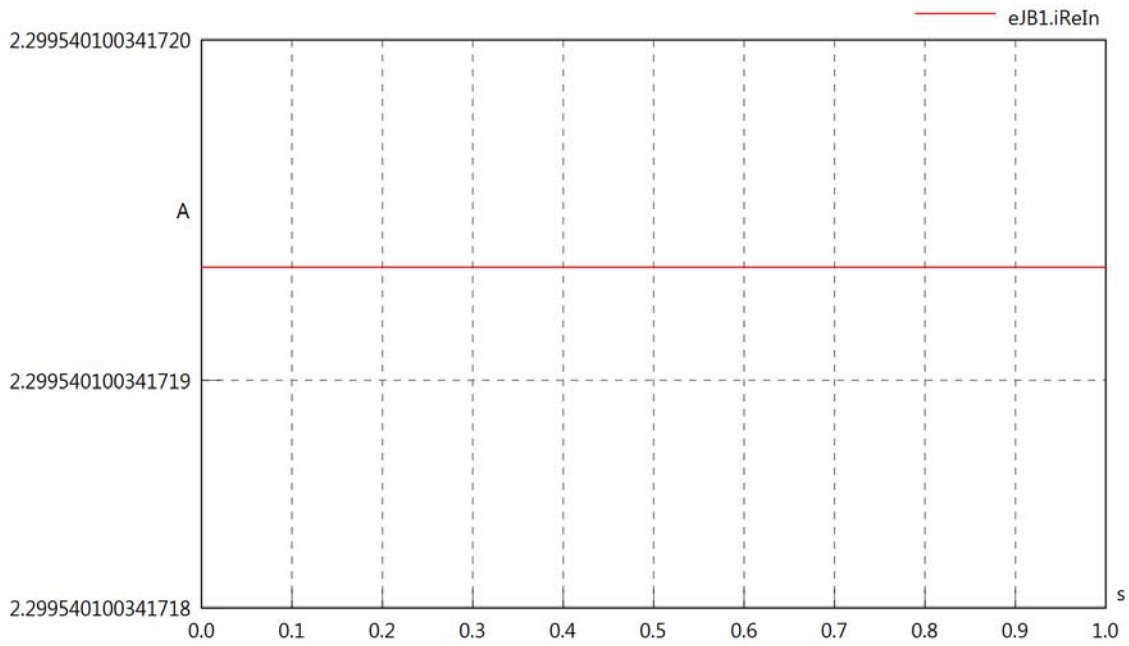

eJB1.iImIn

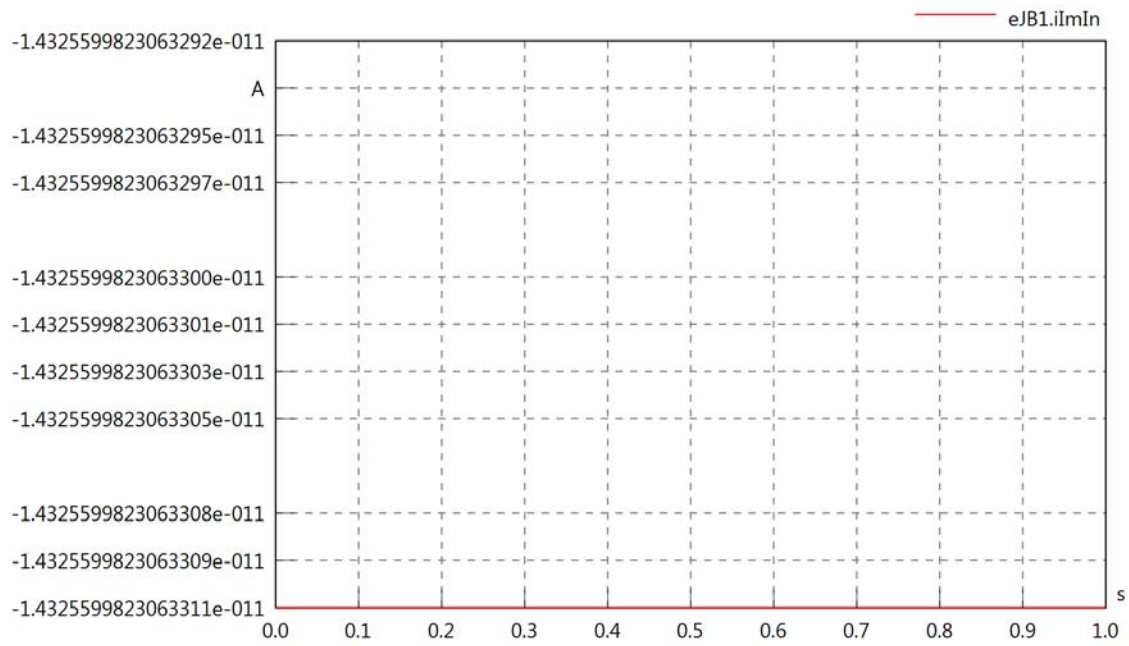

eJB1.IrmsOut

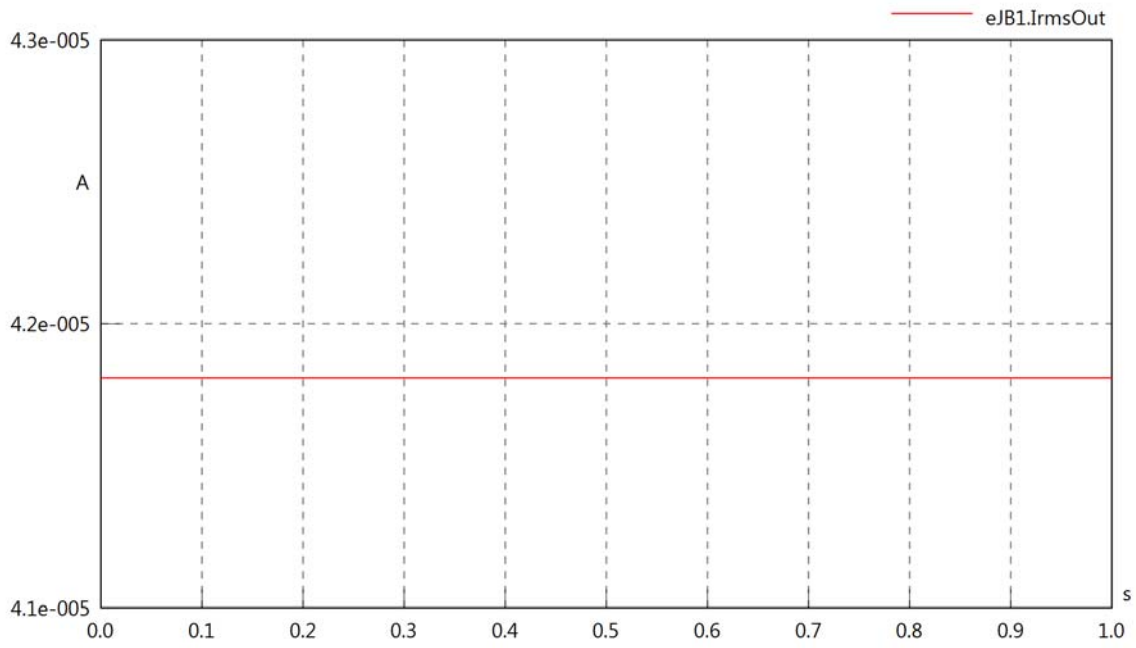

eJB1.iReOut

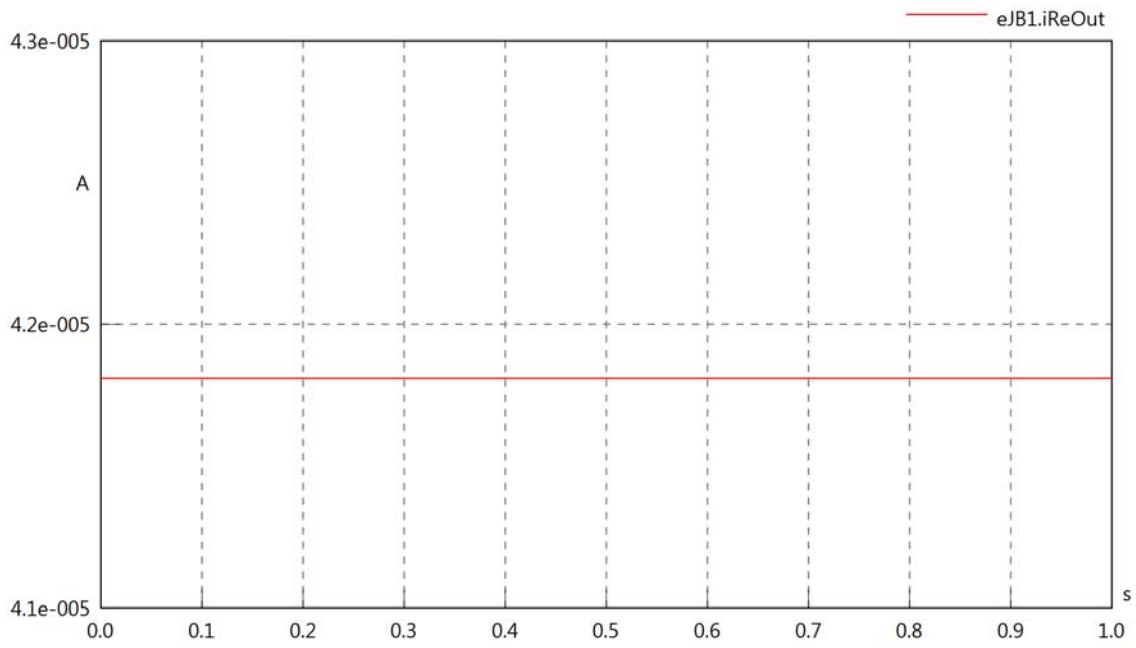

eJB1.iImOut

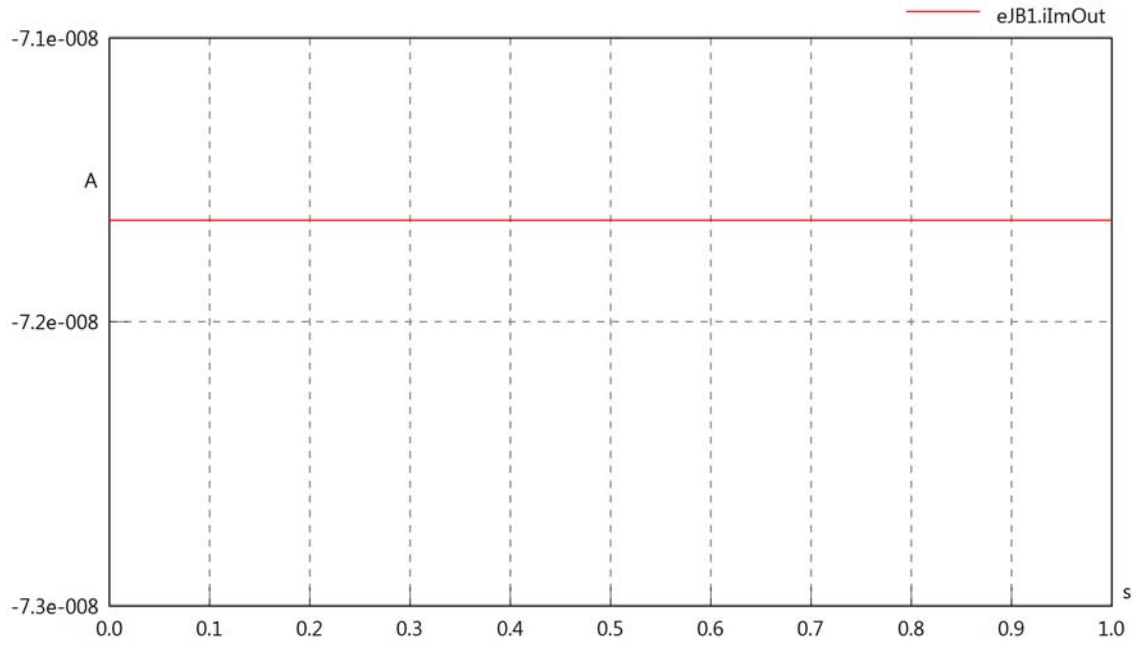

eJB1.phiVIn

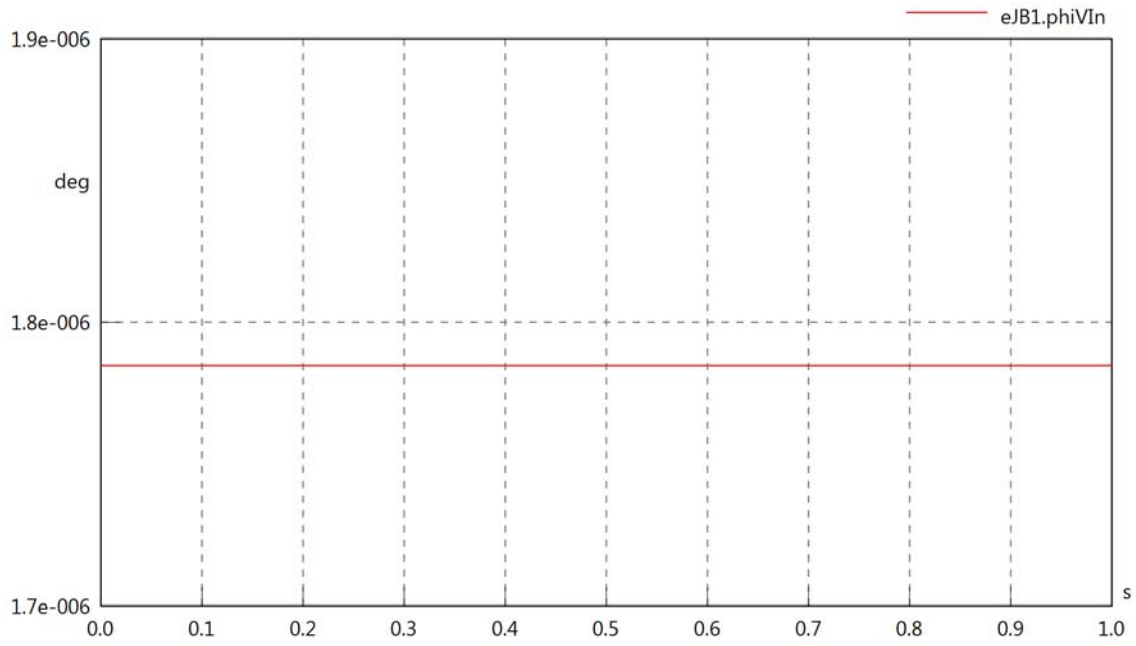

eJB1.phiIn

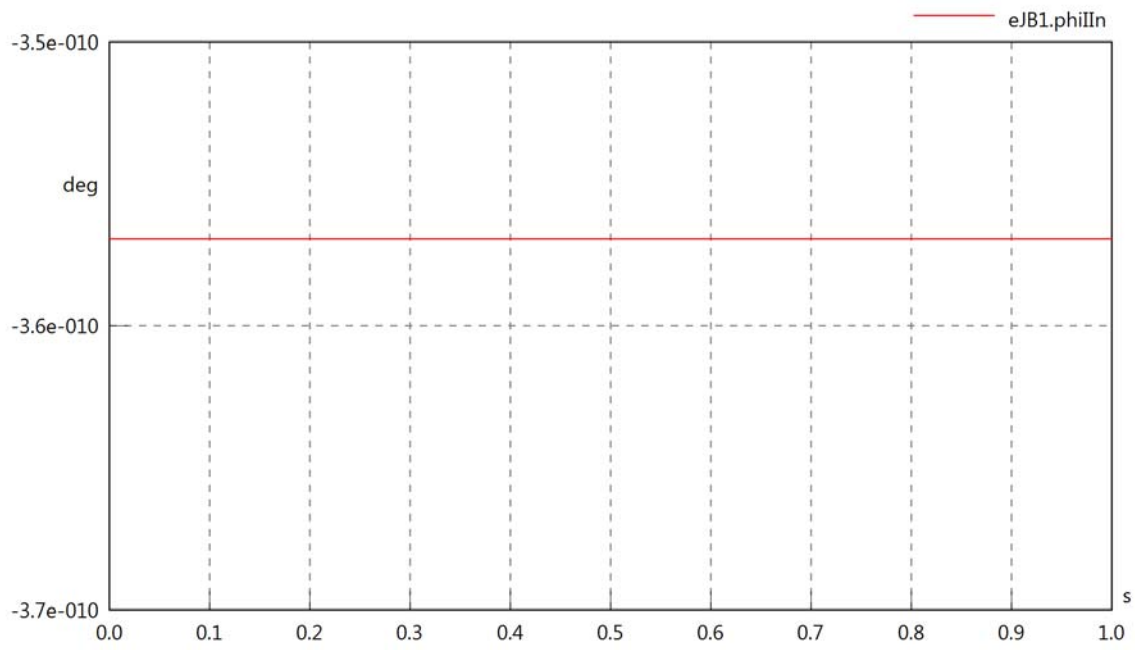

eJB1.phiIVIn

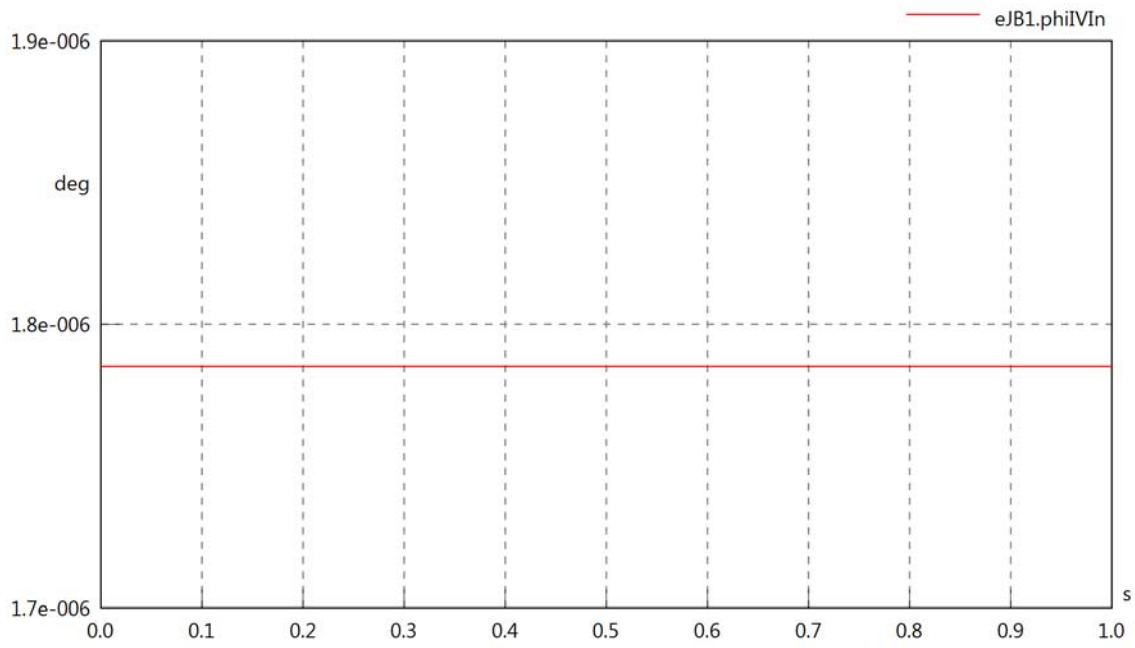

eJB1.phiVOut

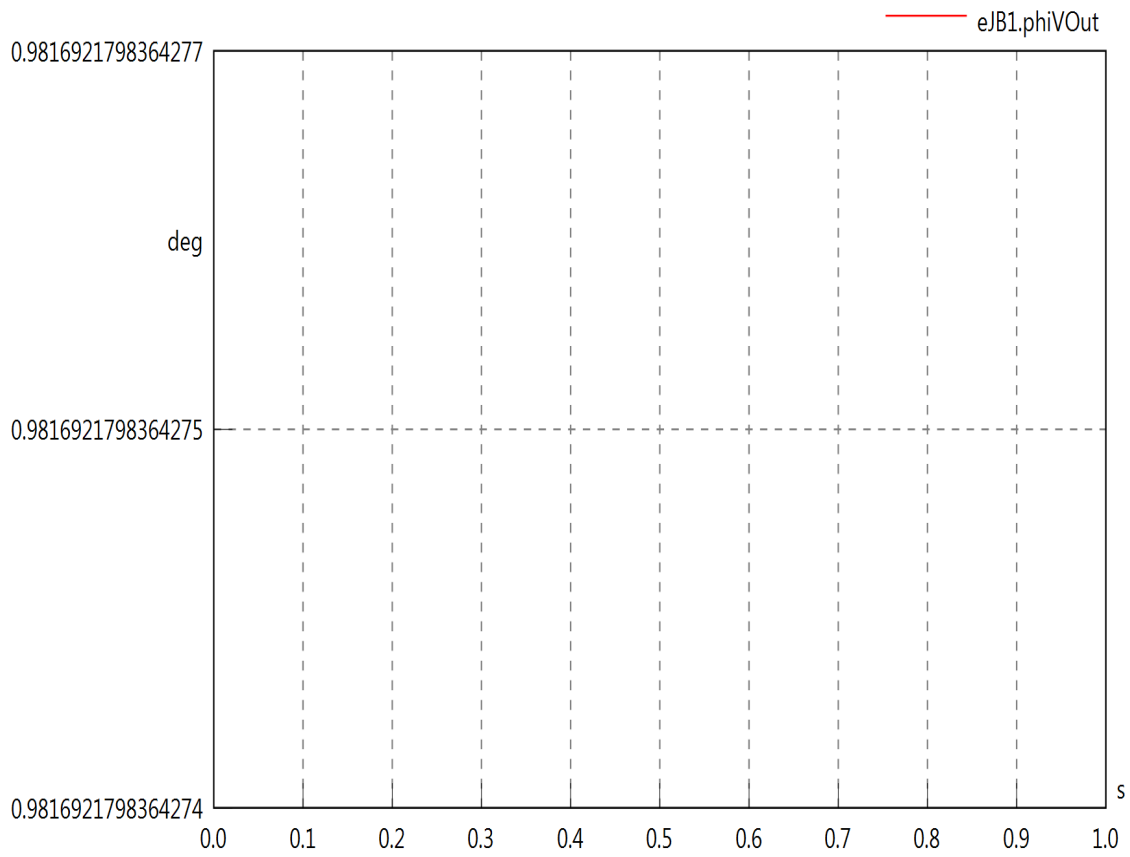

eJB1.phiIOut

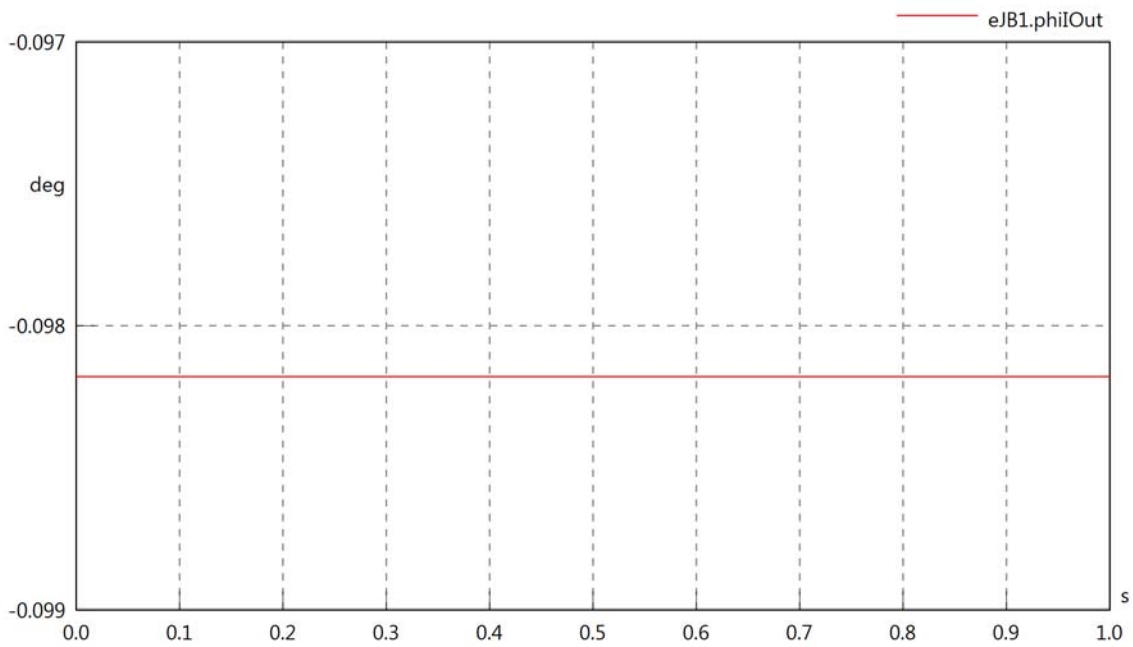

eJB1.phiIVOut

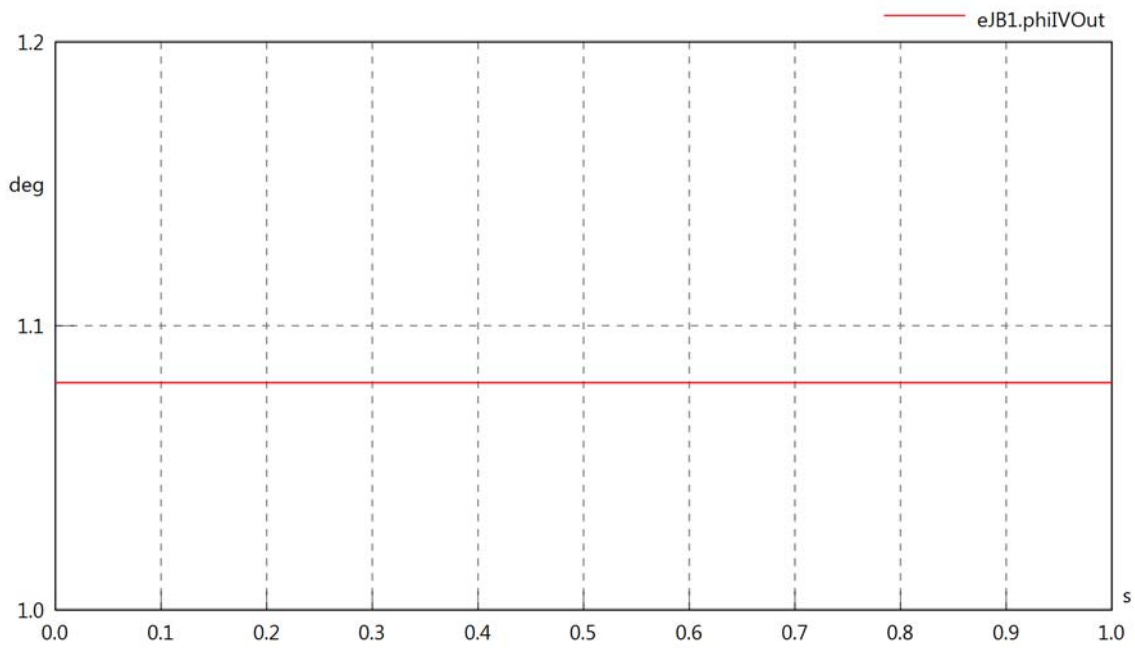

eJB1.PReIn

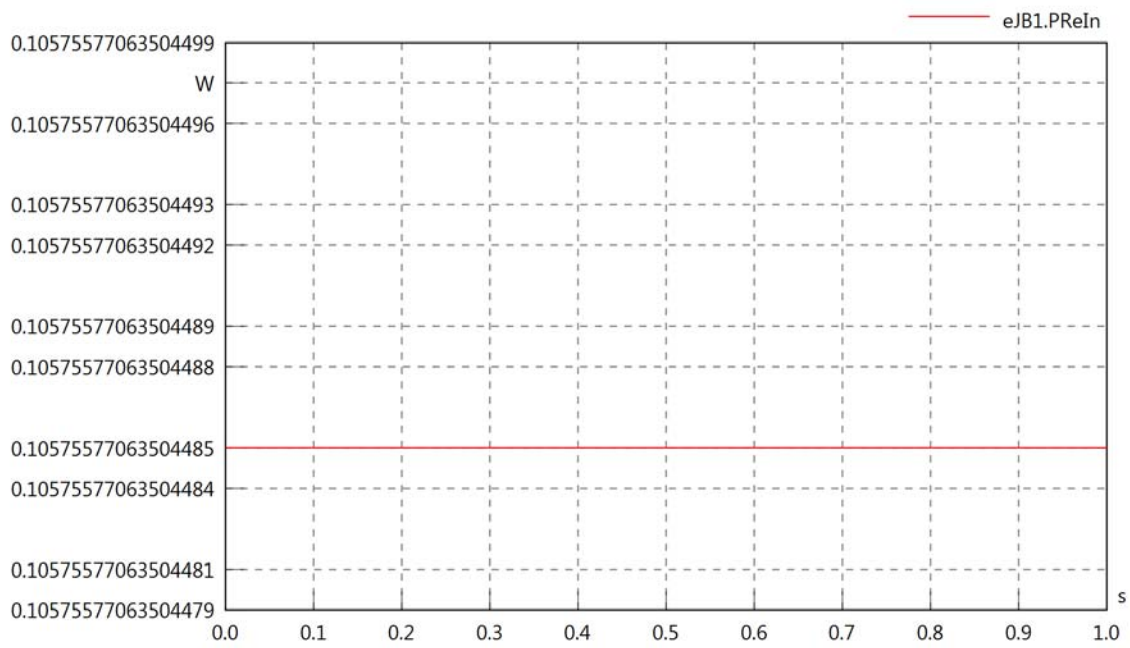

eJB1.PImIn

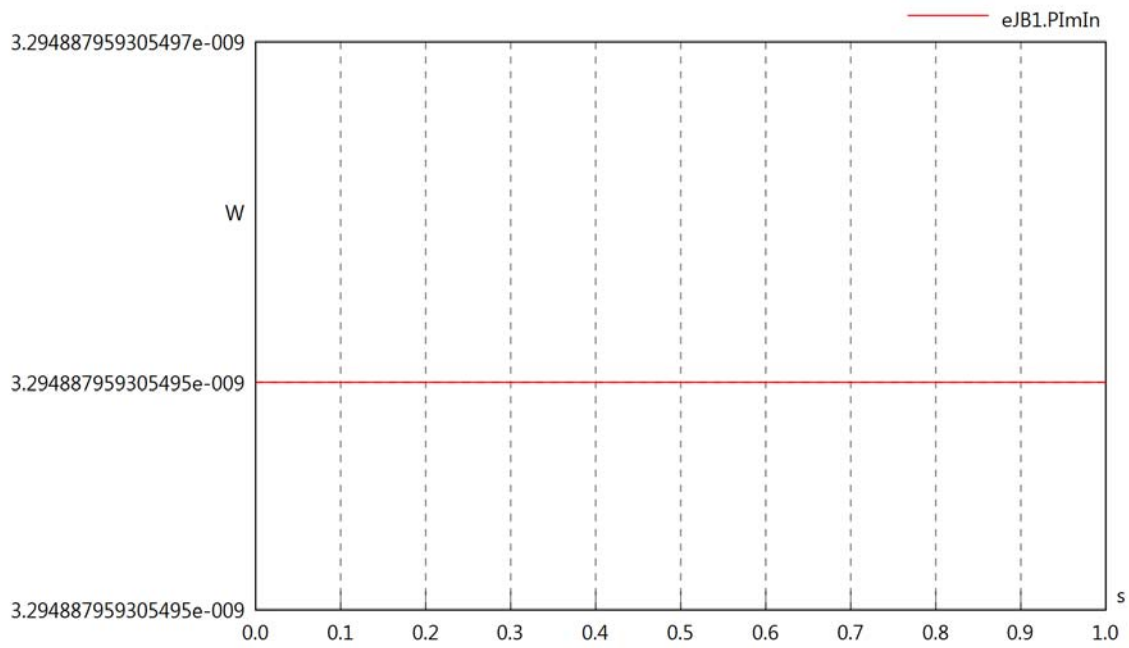

eJB1.SIn

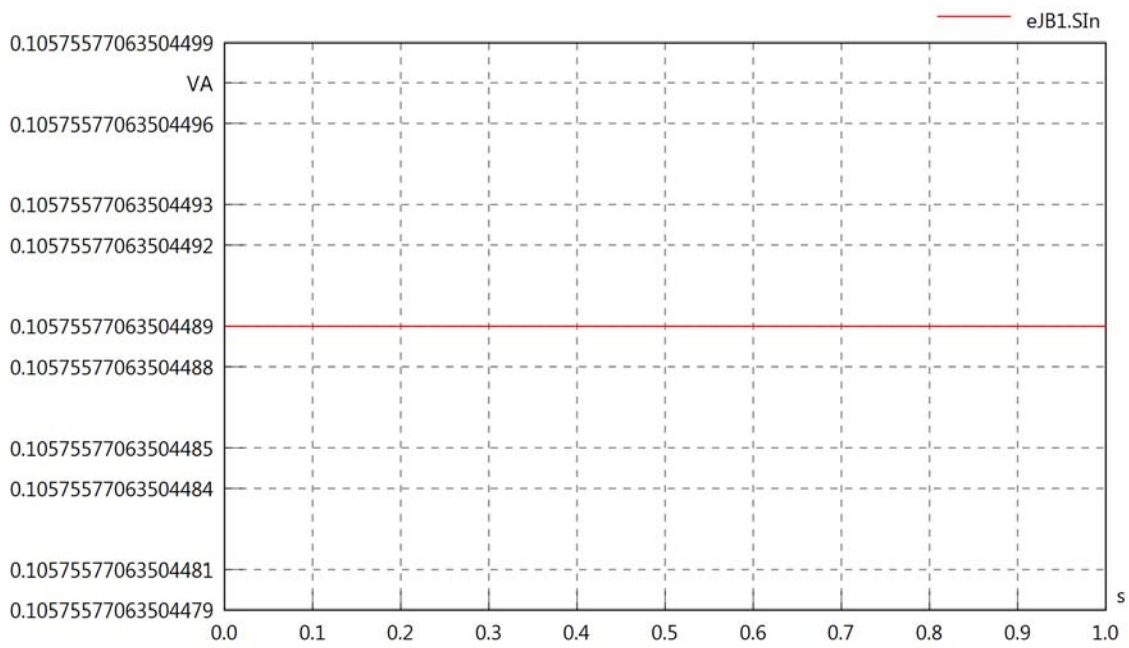

eJB1.PReOut

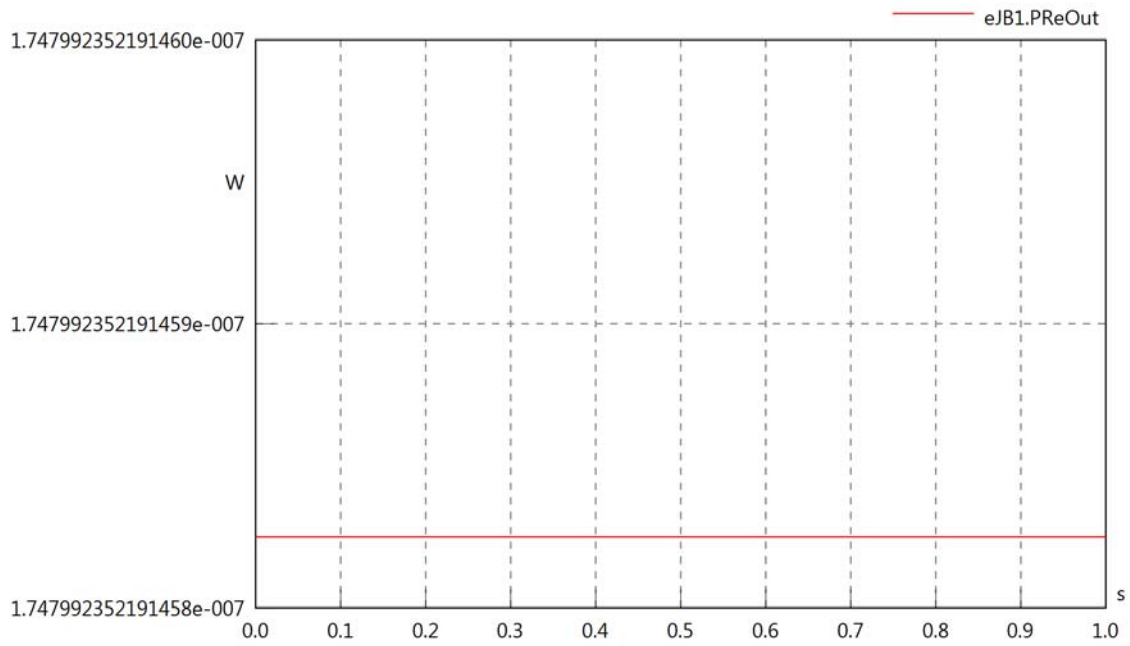

eJB1.PImOut

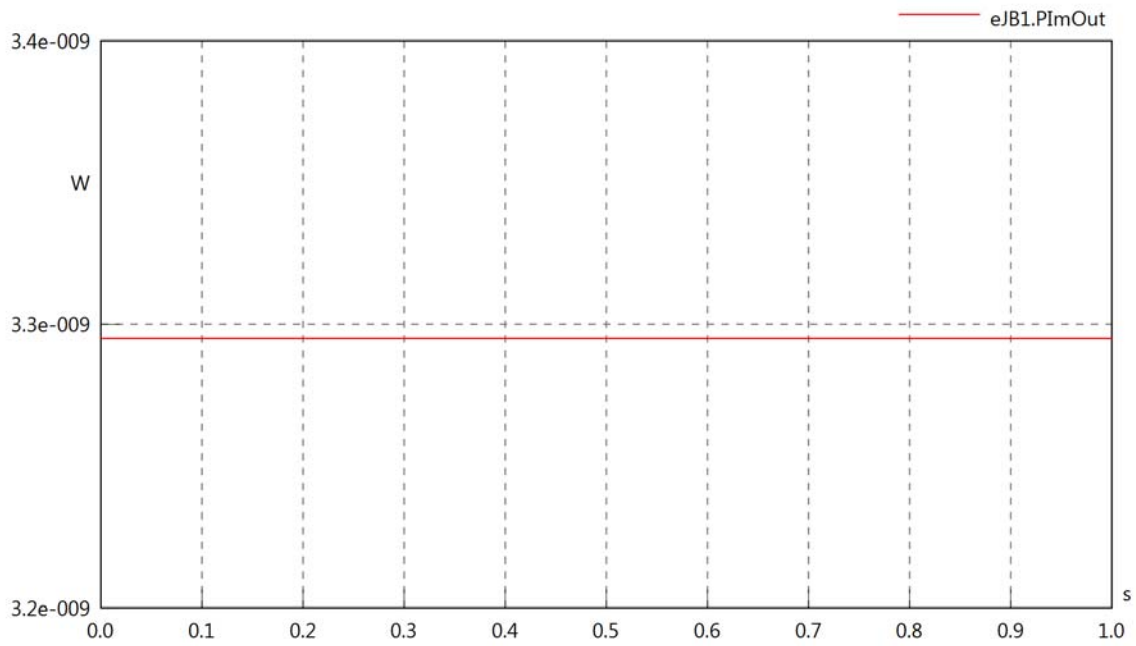

eJB1.SOut

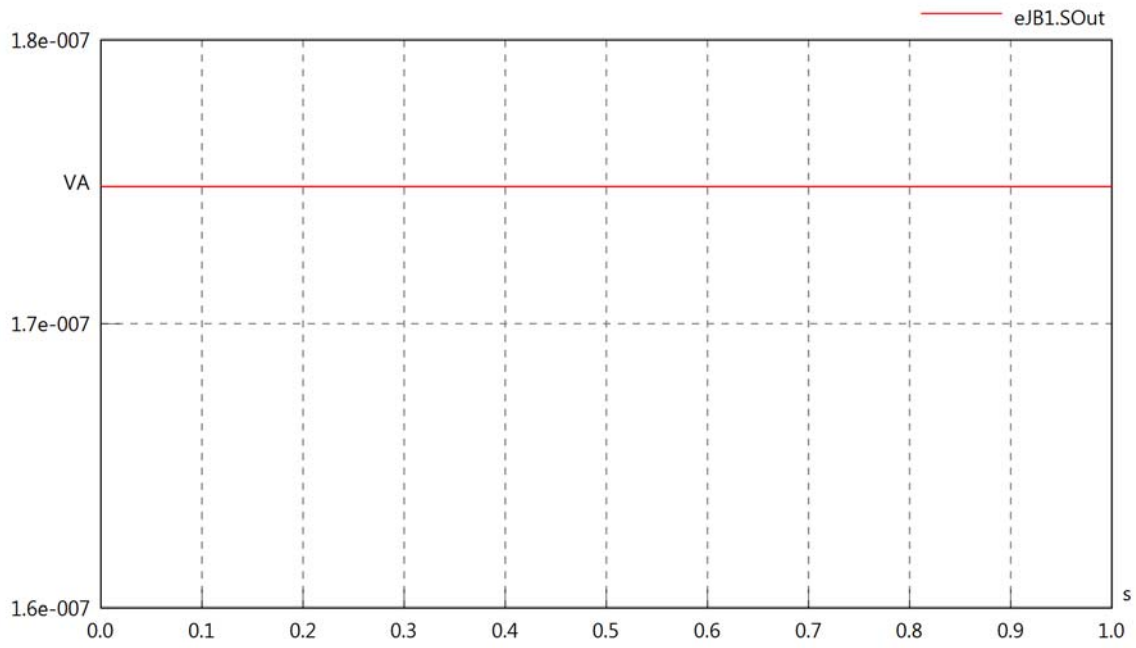
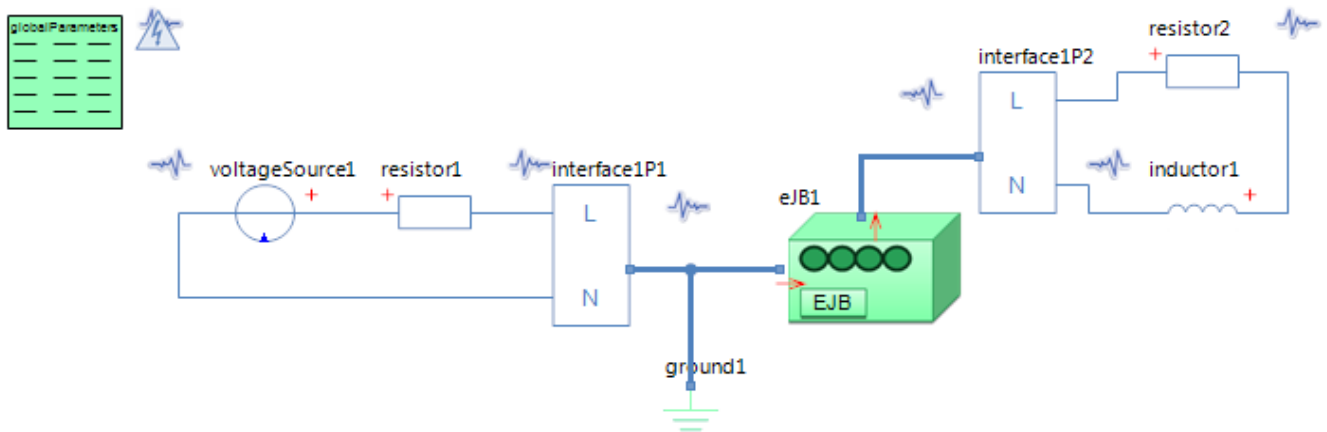

Diagram View



GlobalParameters globalParameters
Parameters

Comment	Name	Current Value	Unit
Type of Calculation	eCalculationKind	Signal Calculation	
Description of Frequency	eFrequencyKind	Linear	
Minimum Frequency	fMin	4000	[Hz]
Maximum Frequency	fMax	4000	[Hz]

Voltage Source voltageSource1
Parameters

Comment	Name	Current Value	Unit
Voltage RMS	VrmsSrc	230	[V]
Phase	phi	0	[deg]

Resistor resistor1
Parameters

Comment	Name	Current Value	Unit
Resistance	R	100	[Ohm]

Resistor resistor2
Parameters

Comment	Name	Current Value	Unit
Resistance	R	100	[Ohm]

Electrical Junction Box eJB1
Parameters

Comment	Name	Current Value	Unit
Poor or failing L1 connection	bL1	true	
Resistance in L1 connection	rL1	1	[kOhm]
Conductance between L1 and N	G	50	[1/Ohm]

Inductor inductor1
Parameters

Comment	Name	Current Value	Unit
Inductance	L	5	[mH]

eJB1.VrmsIn

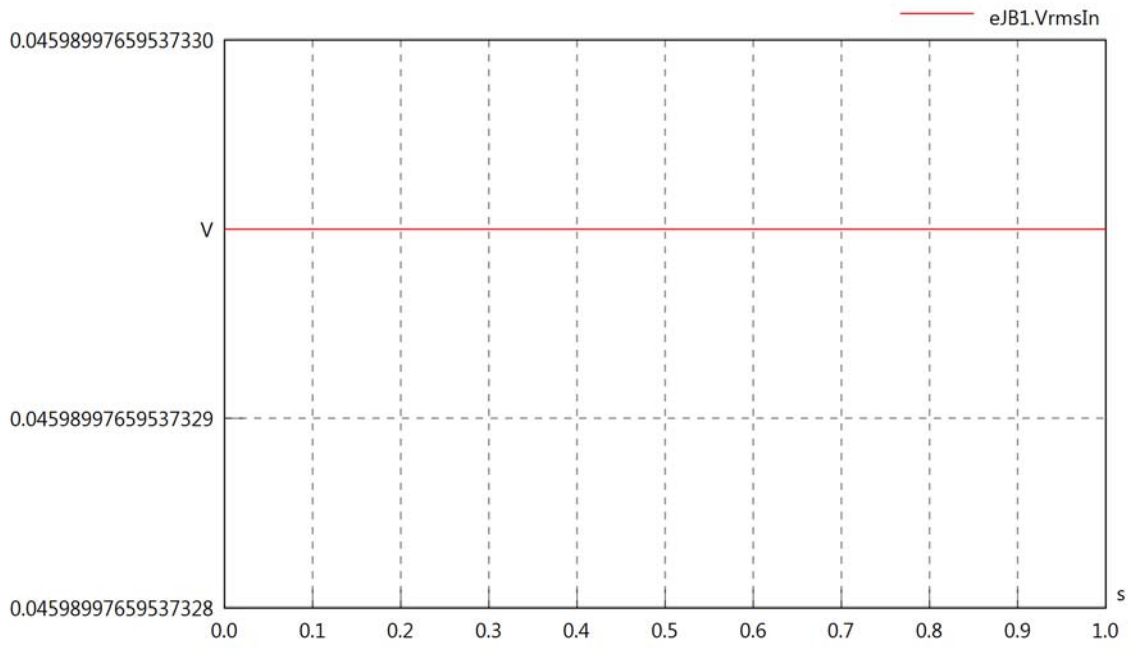

eJB1.vReIn

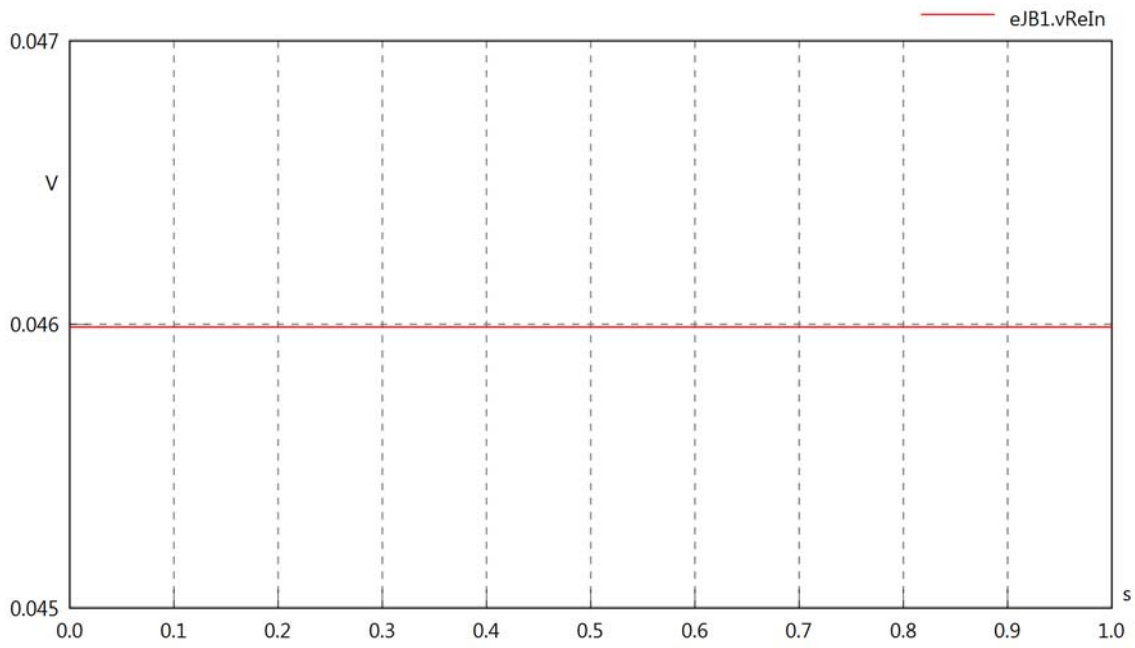

eJB1.vImIn

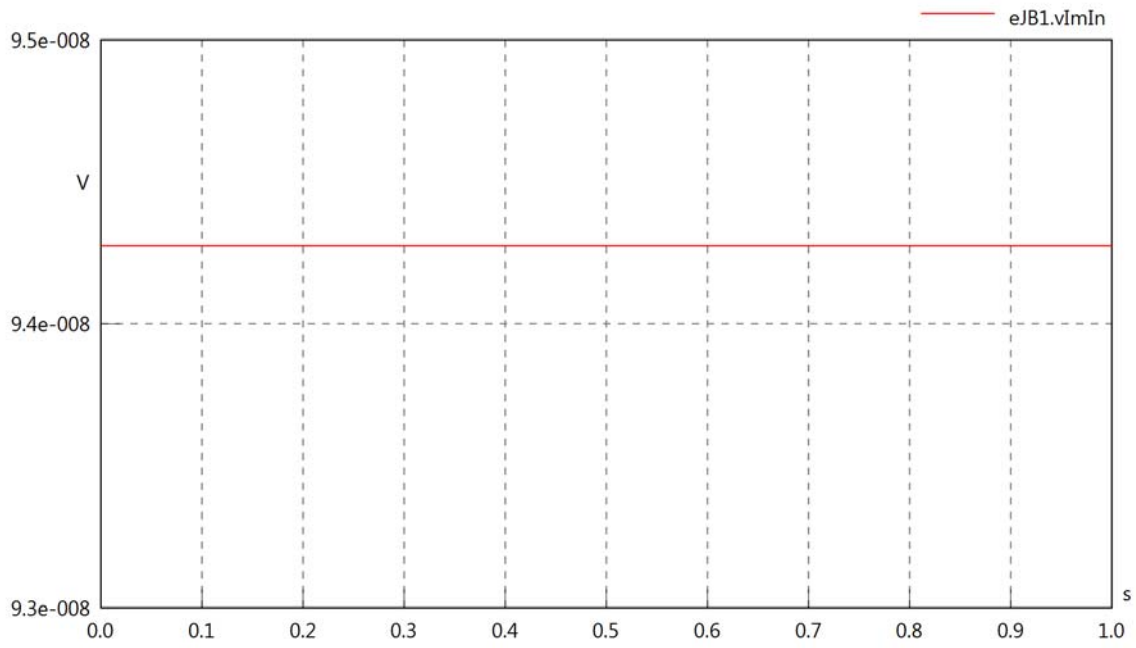

eJB1.VrmsOut

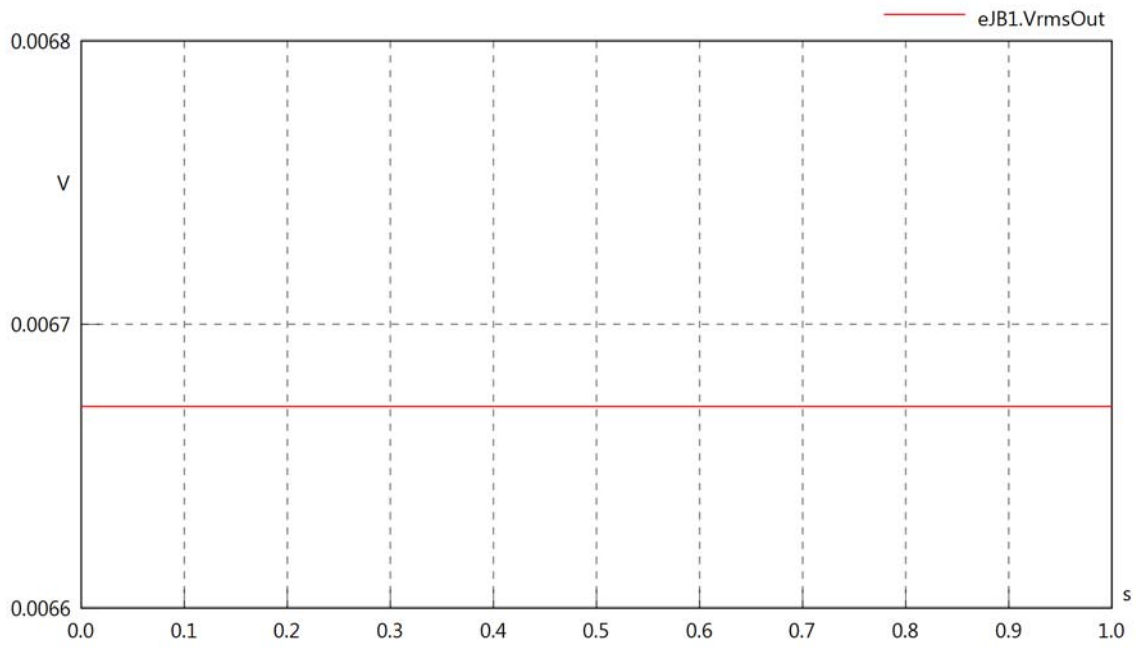

eJB1.vReOut

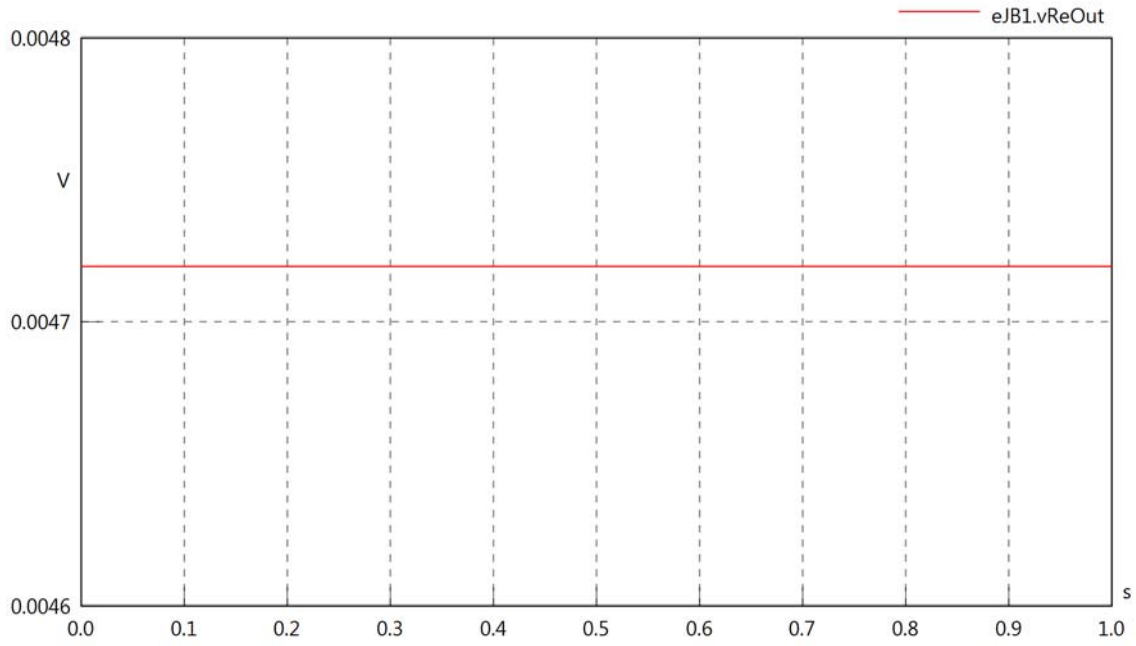

eJB1.vImOut

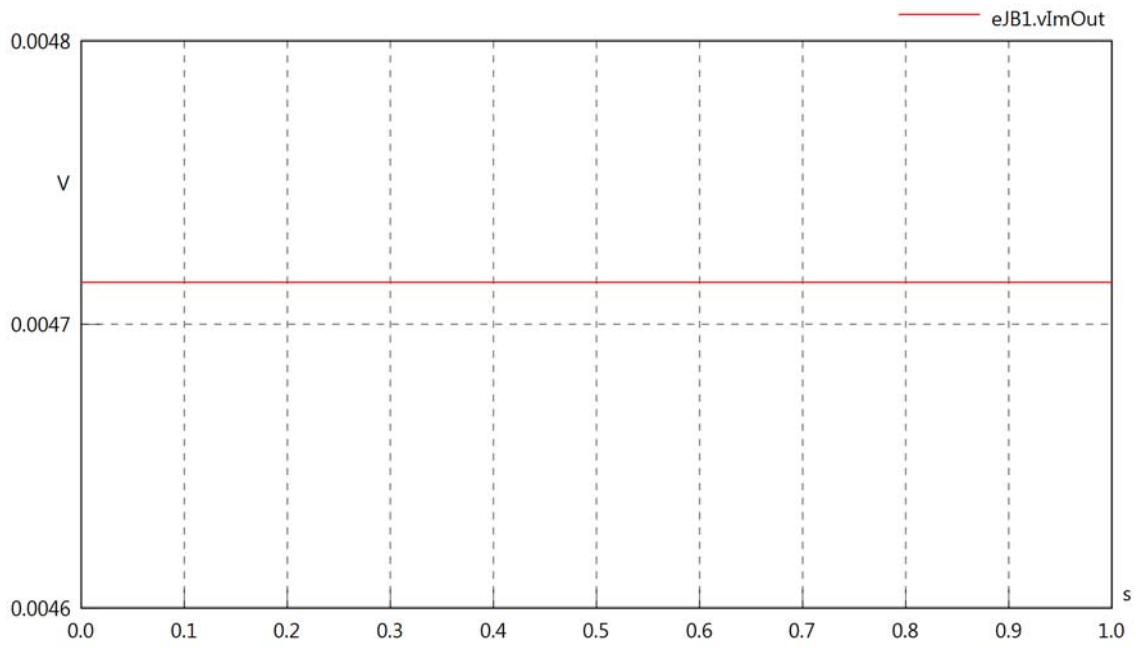

eJB1.Vrms

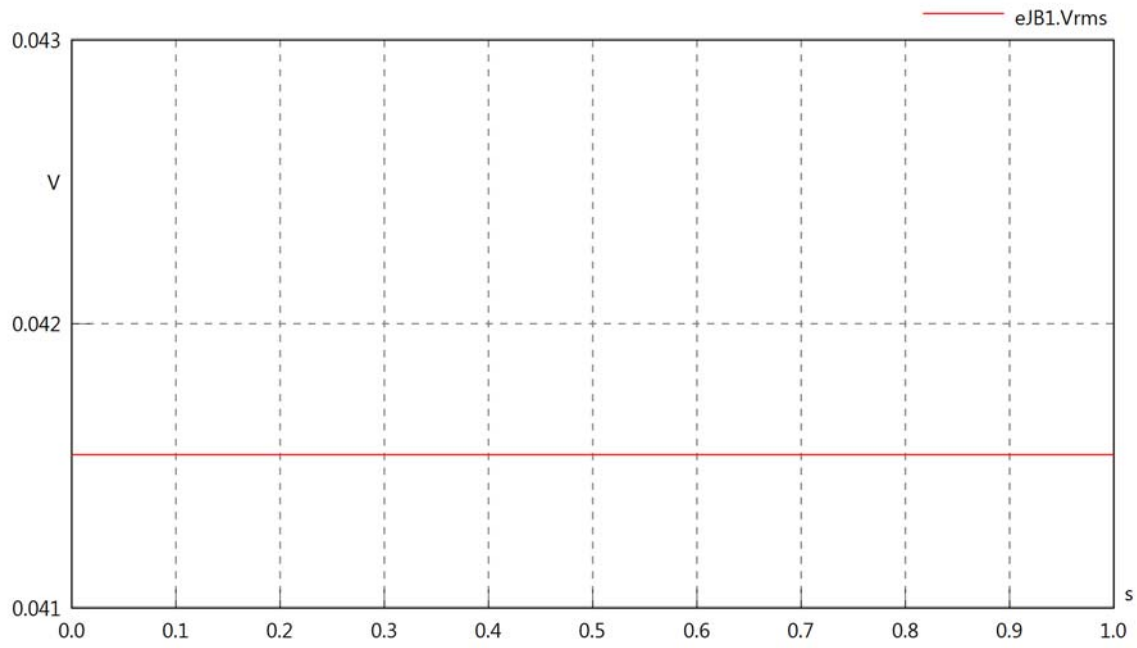

eJB1.vRe

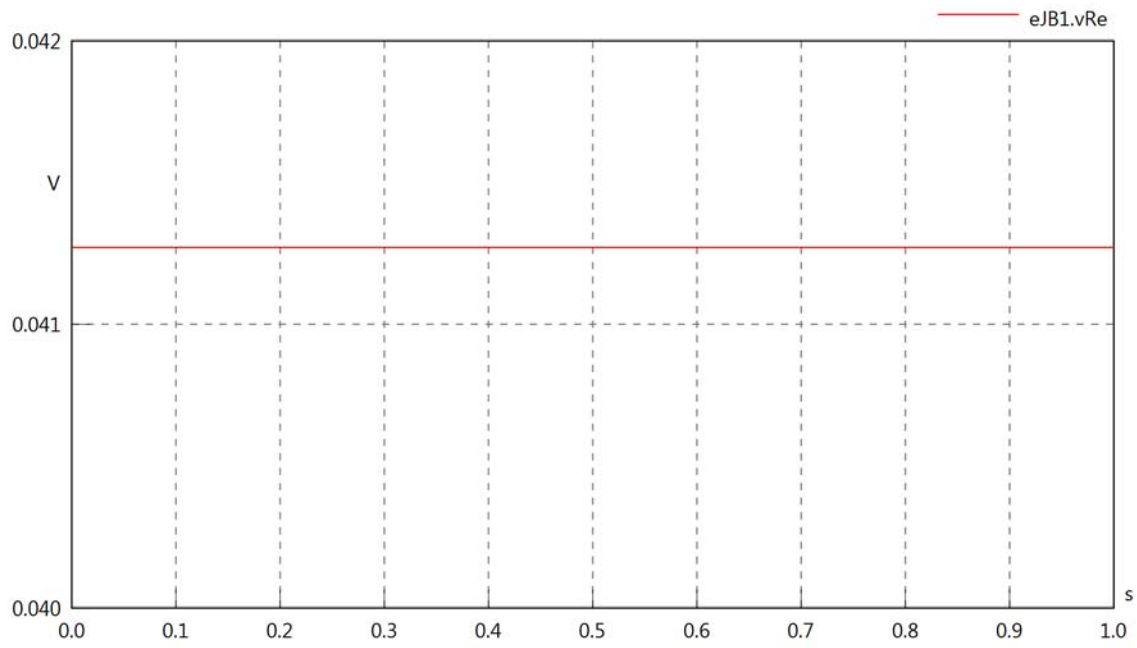

eJB1.vIm

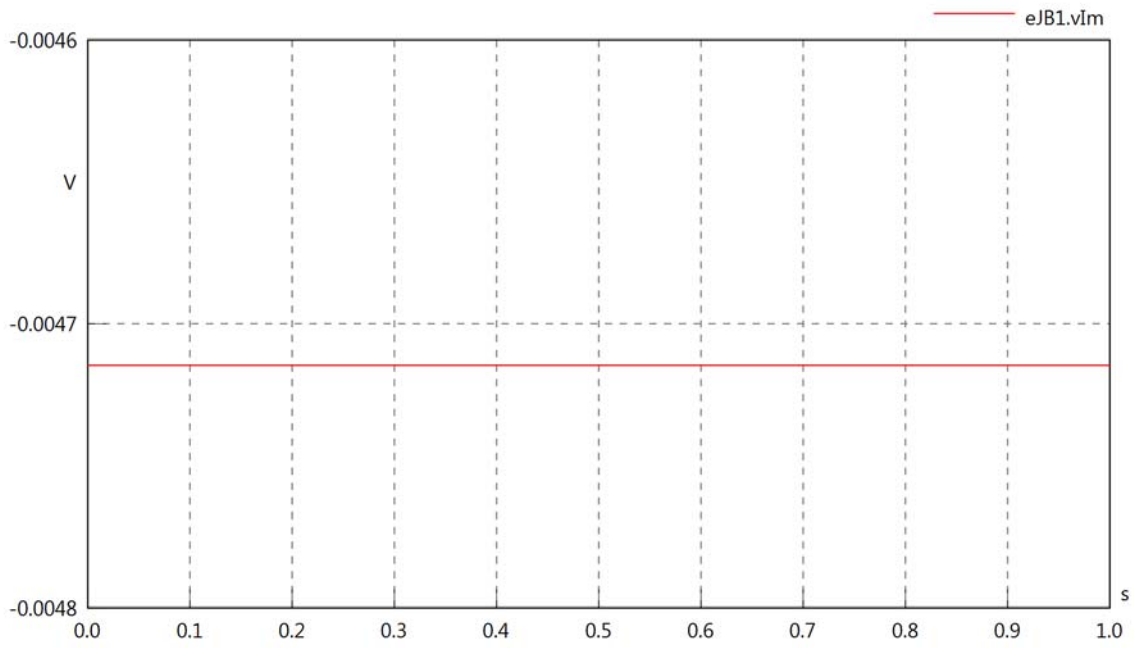

eJB1.IrmsIn

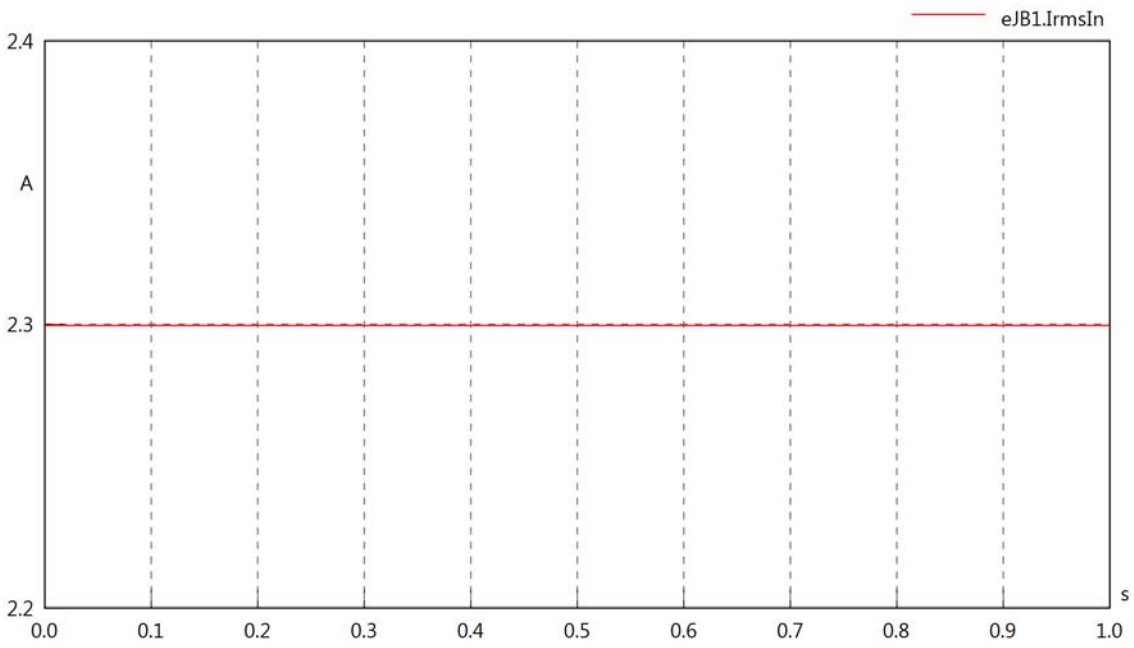

eJB1.iReIn

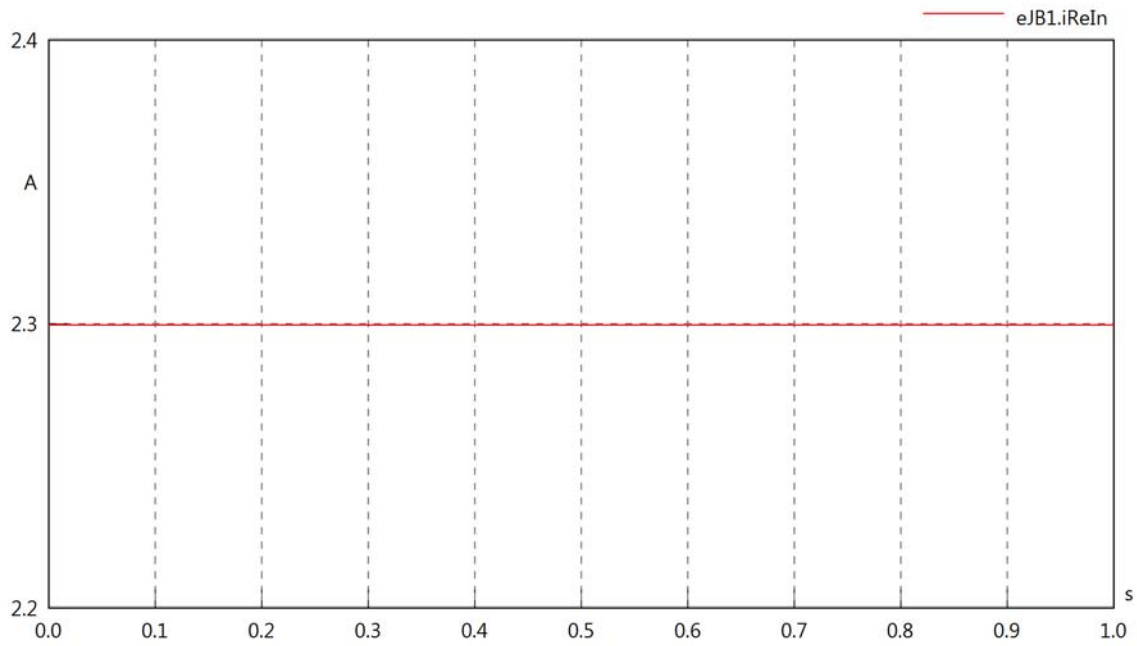

eJB1.iImIn

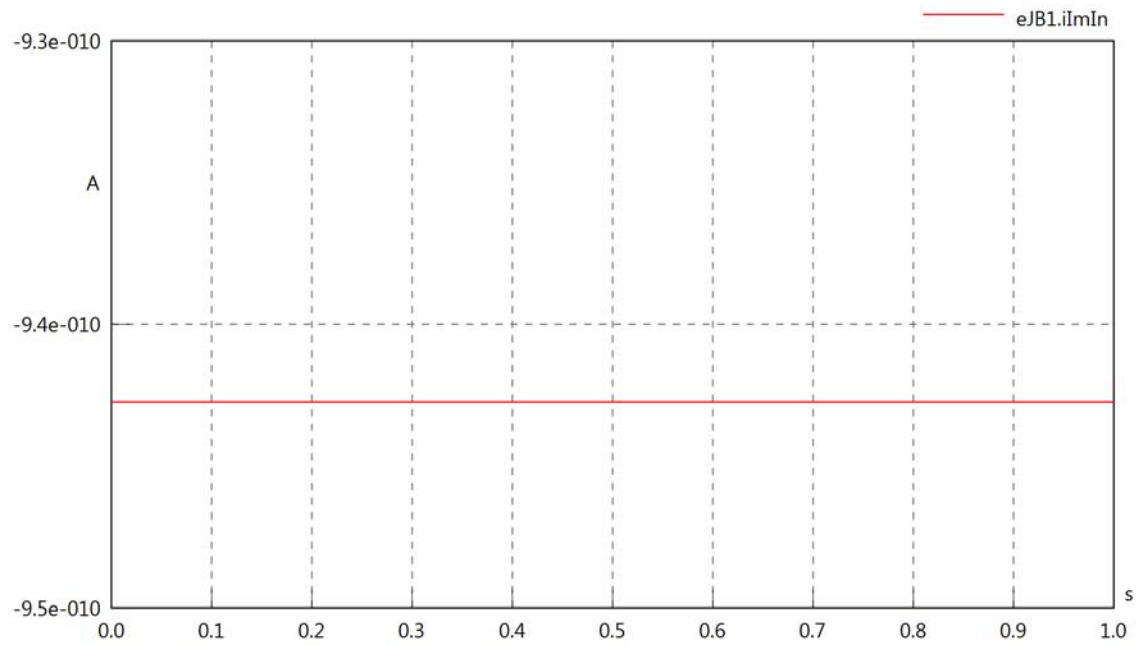

eJB1.IrmsOut

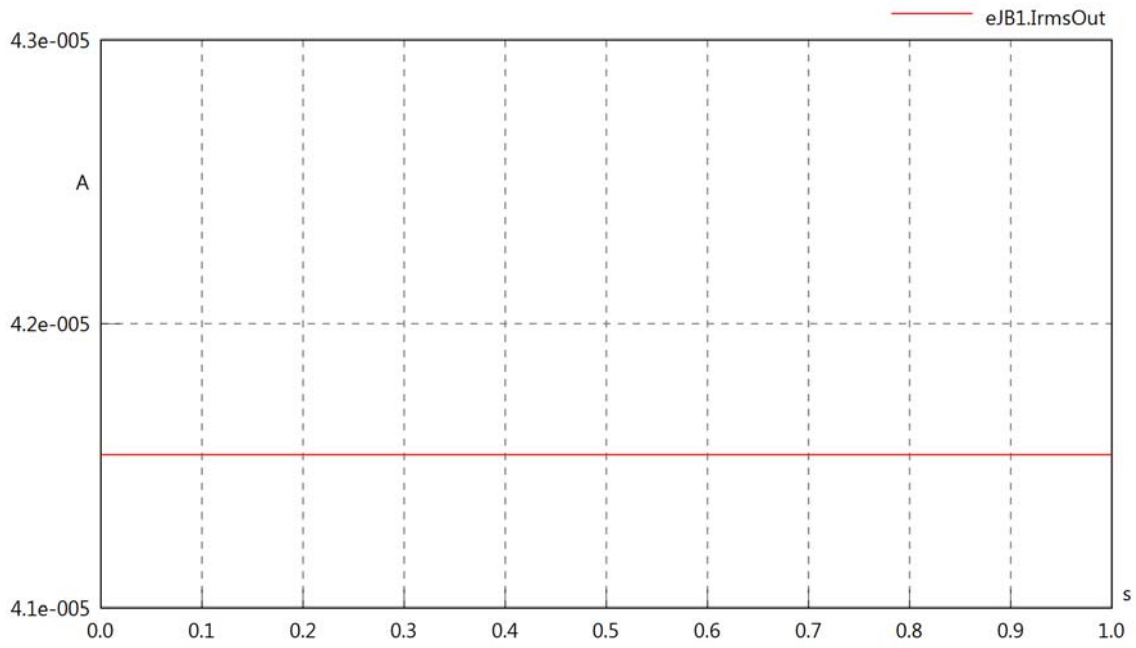

eJB1.iReOut

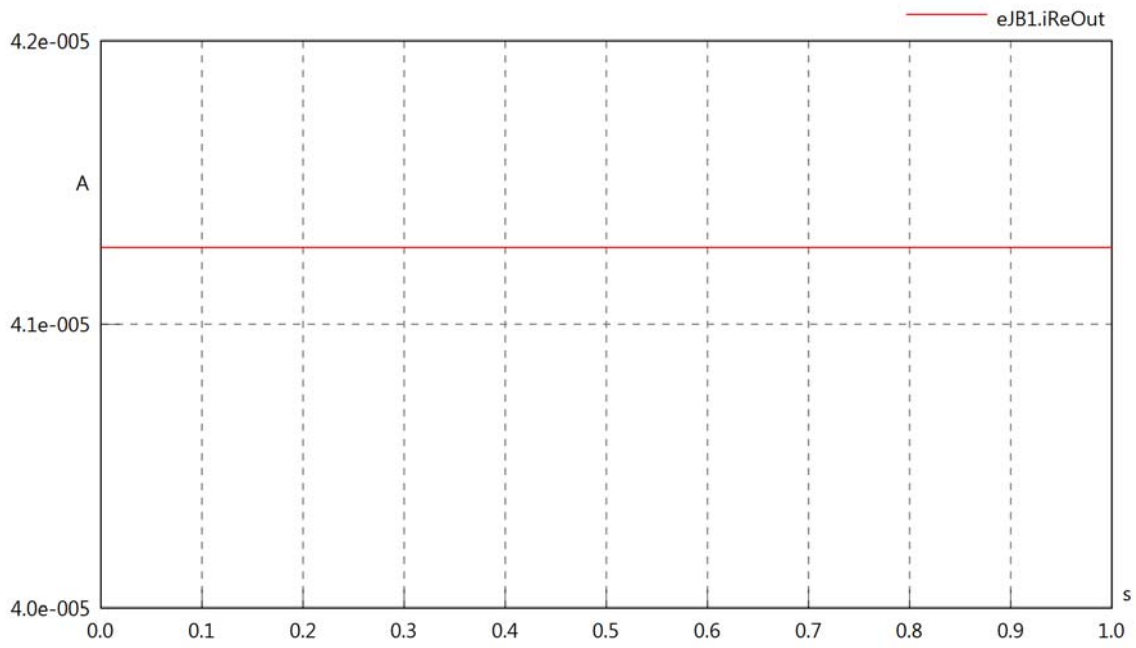

eJB1.iImOut

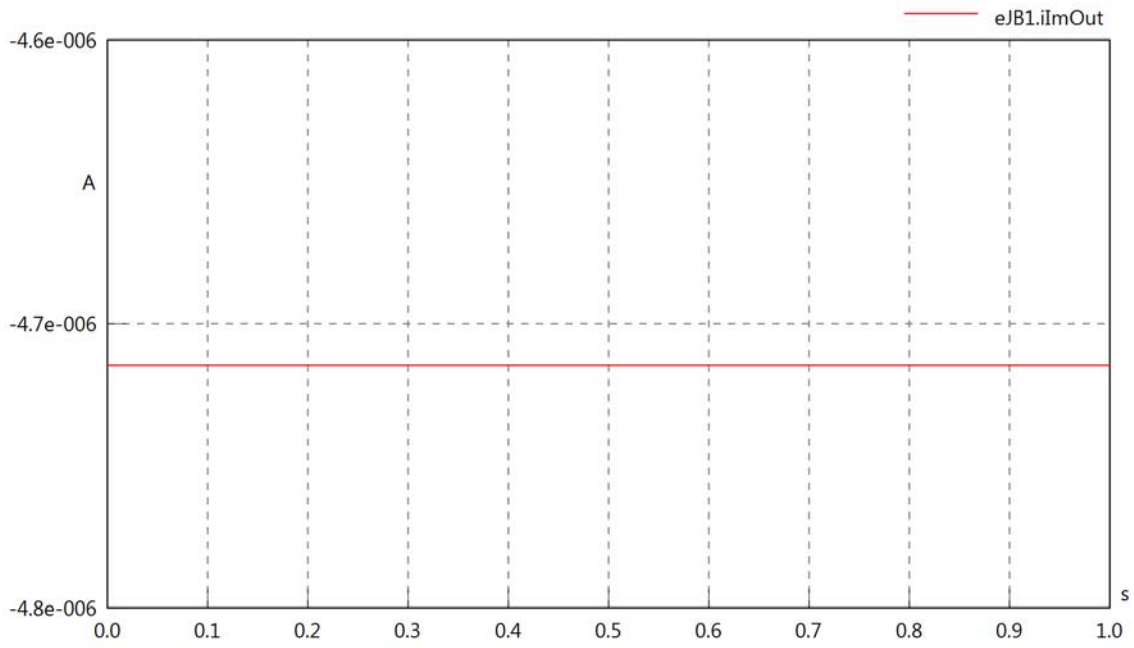

eJB1.phiVIn

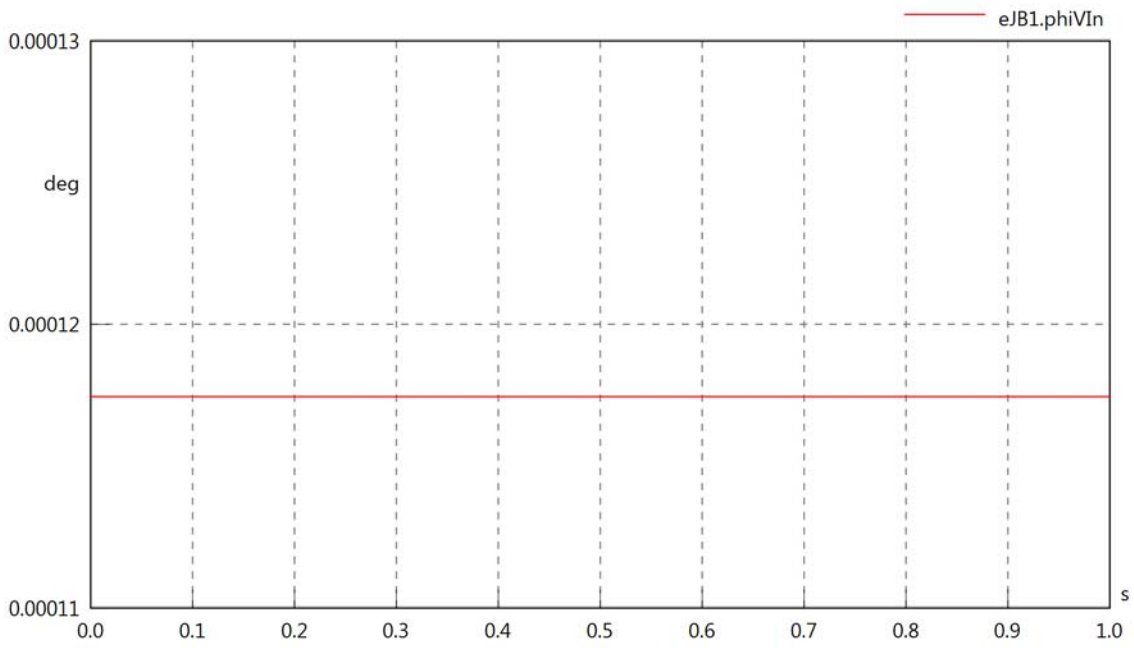

eJB1.phiIn

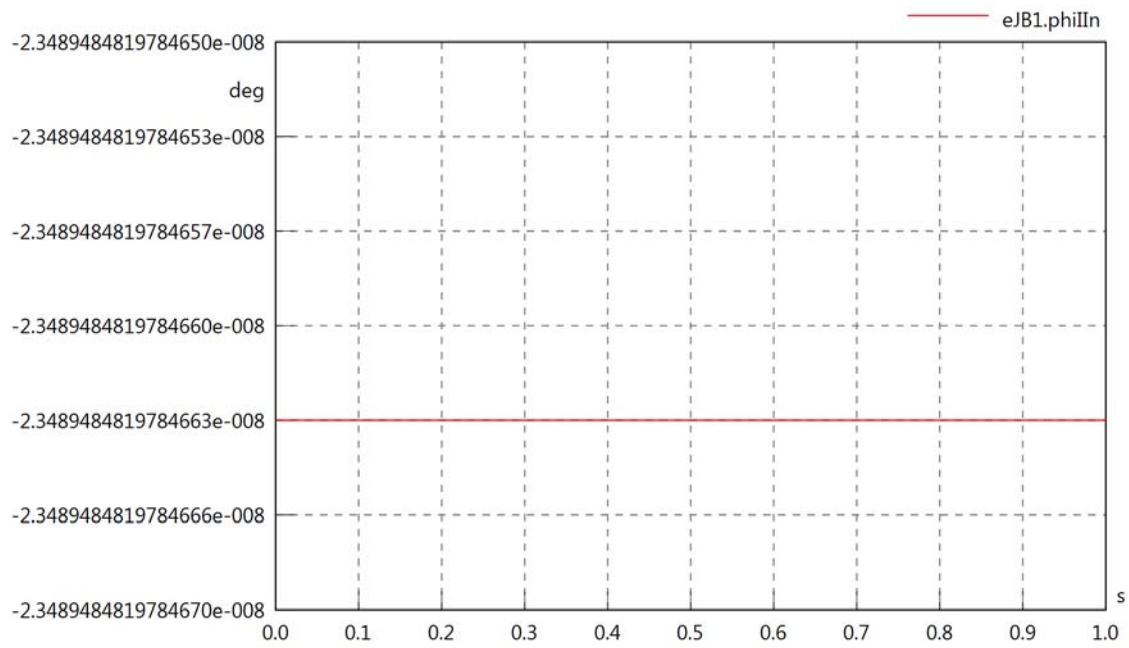

eJB1.phiIVIn

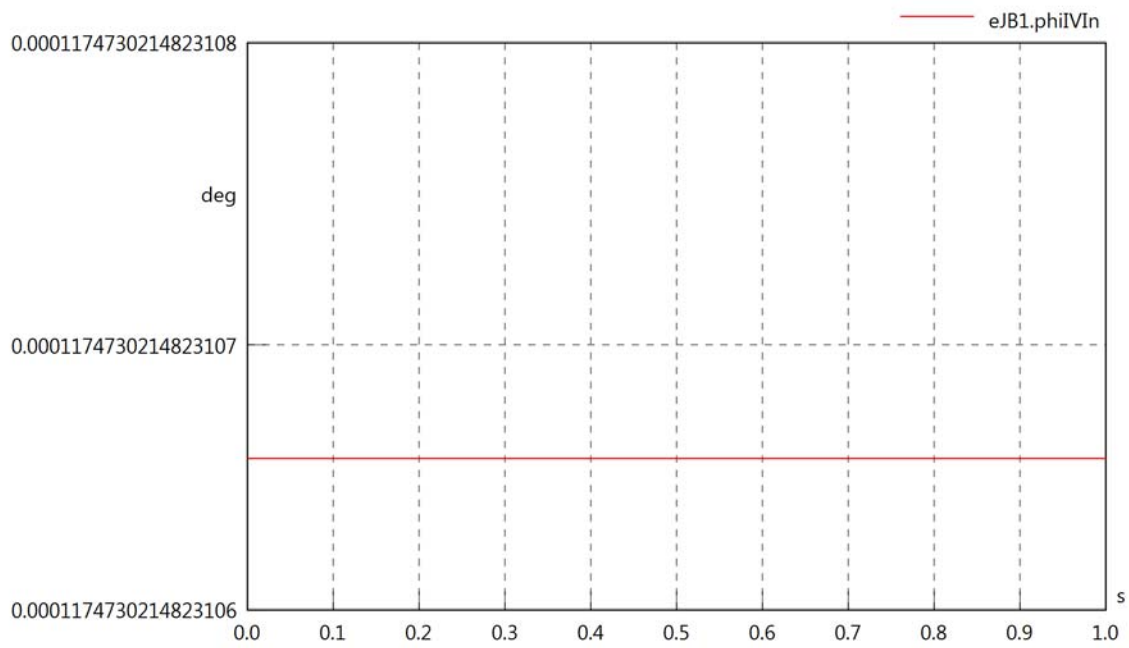

eJB1.phiVOut

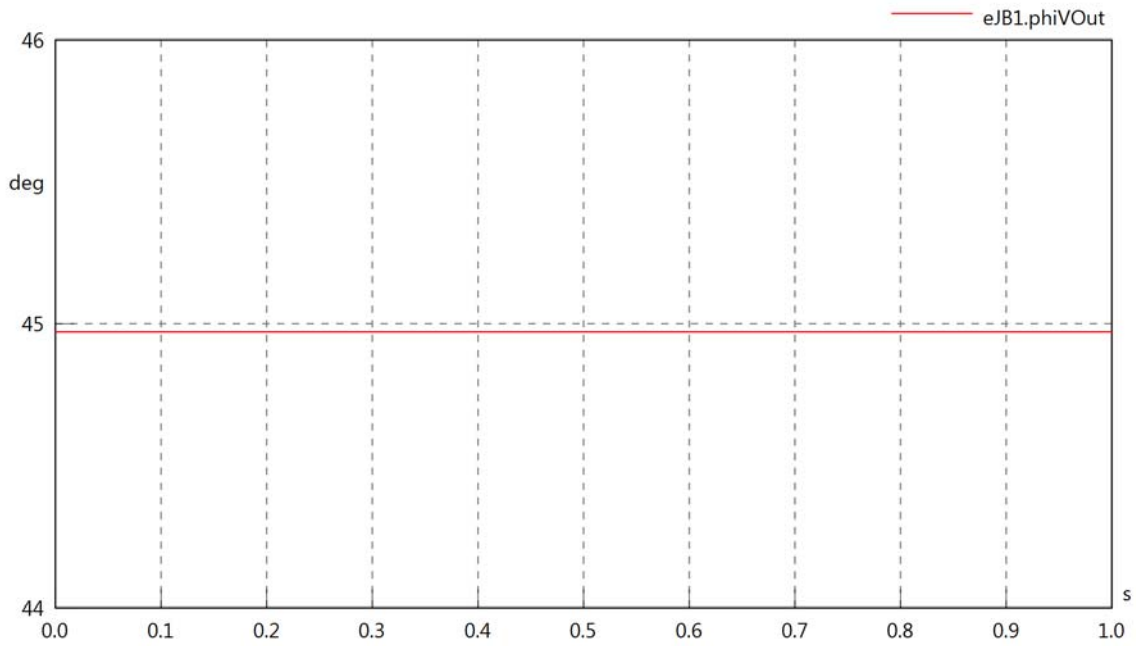

eJB1.phiIOut

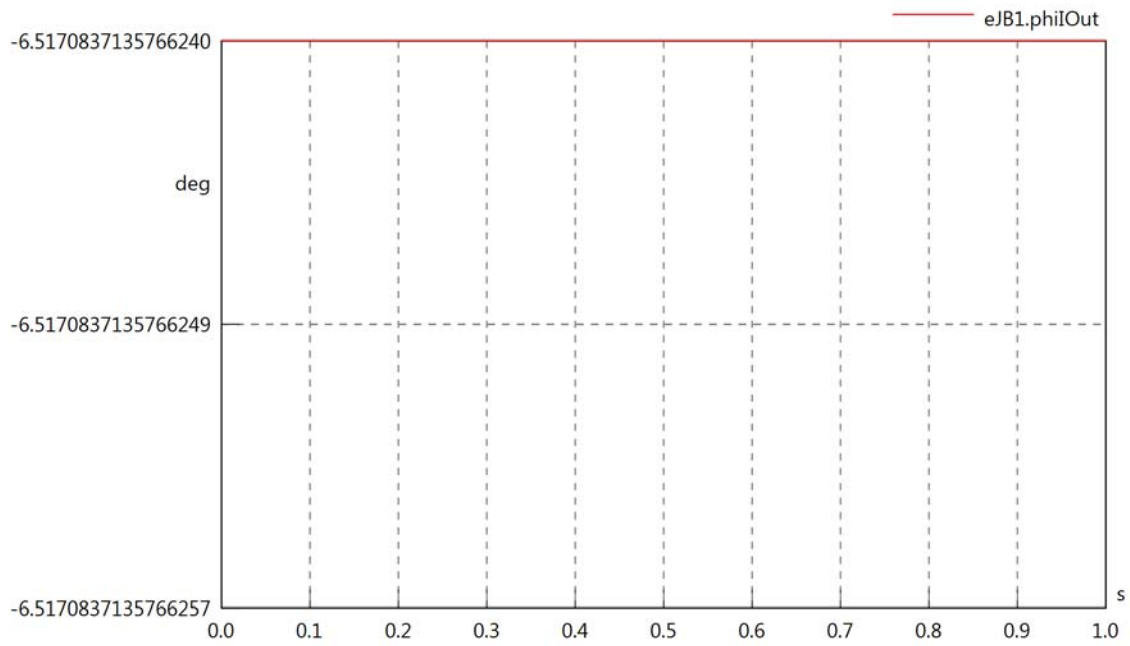

eJB1.phiIVOut

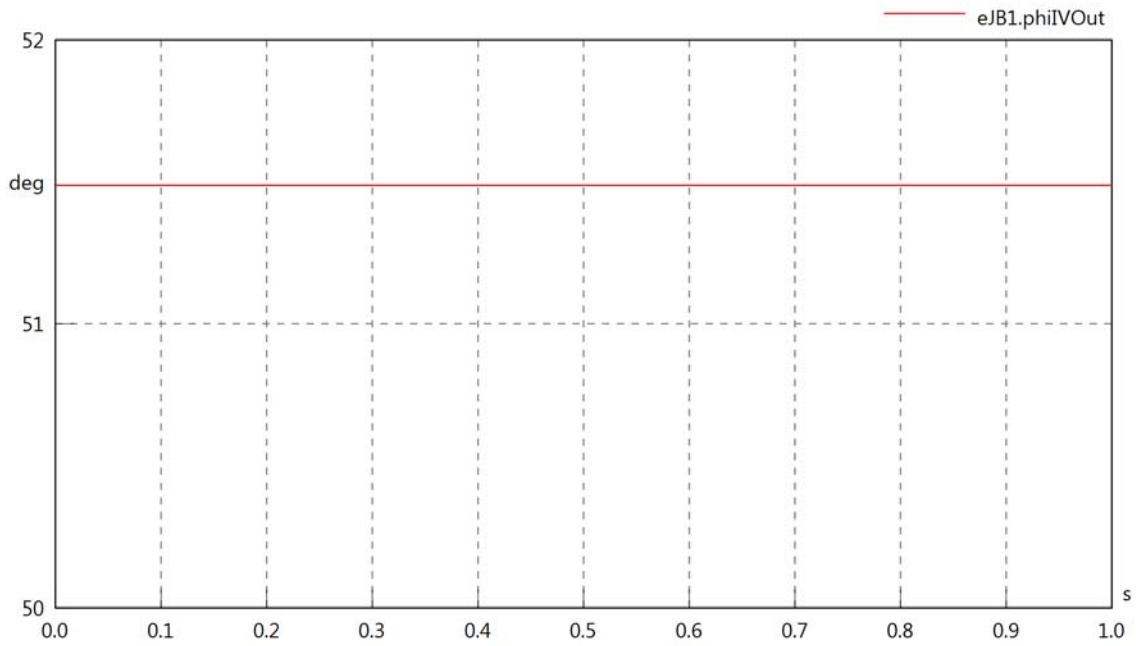

eJB1.PReIn

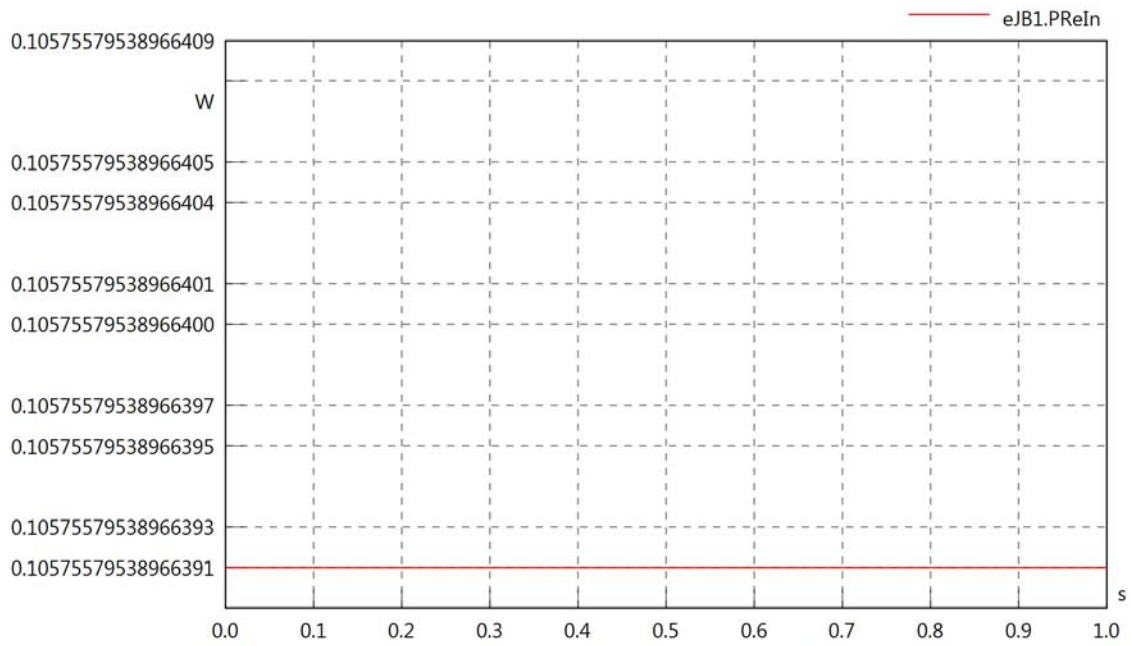

eJB1.PImIn

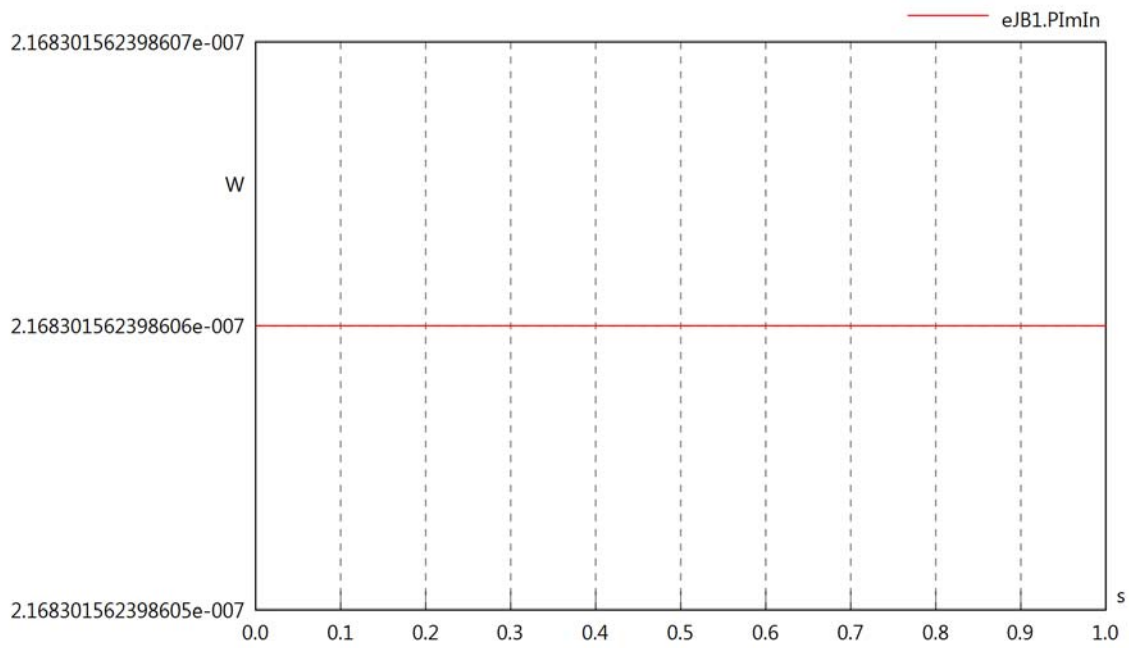

eJB1.SIn

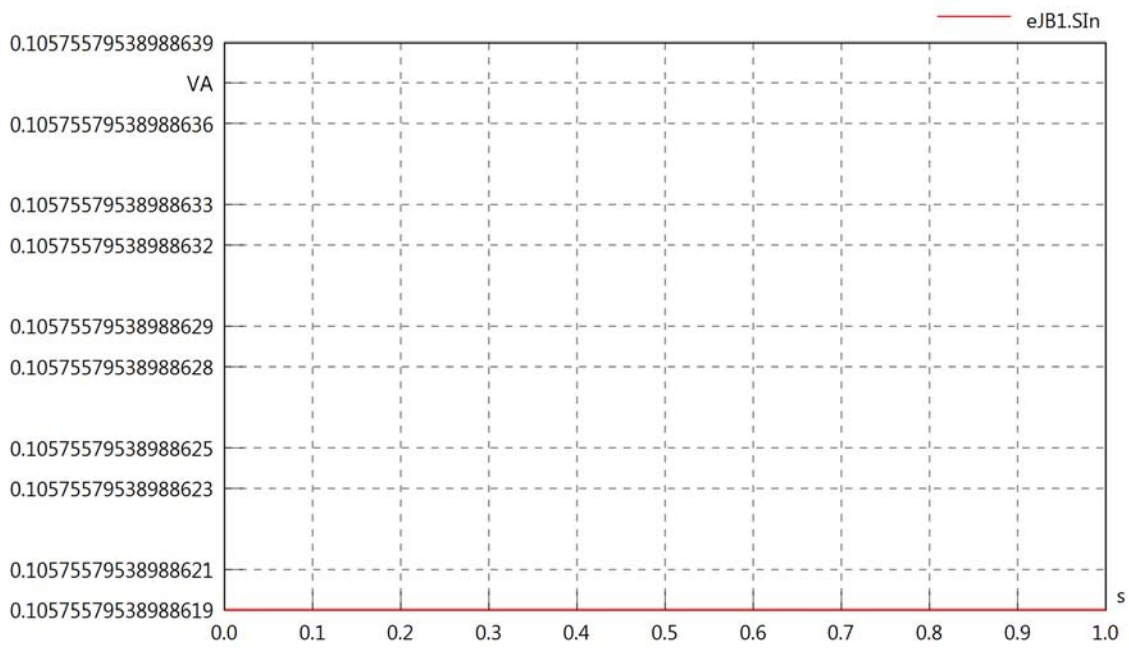

eJB1.PReOut

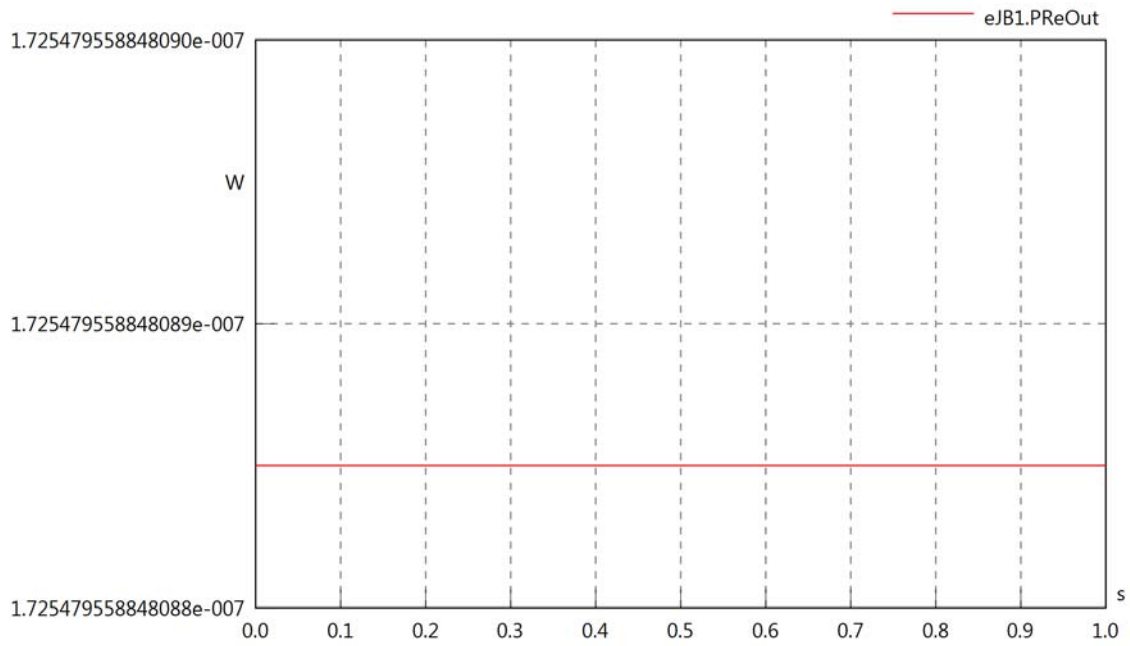

eJB1.PImOut

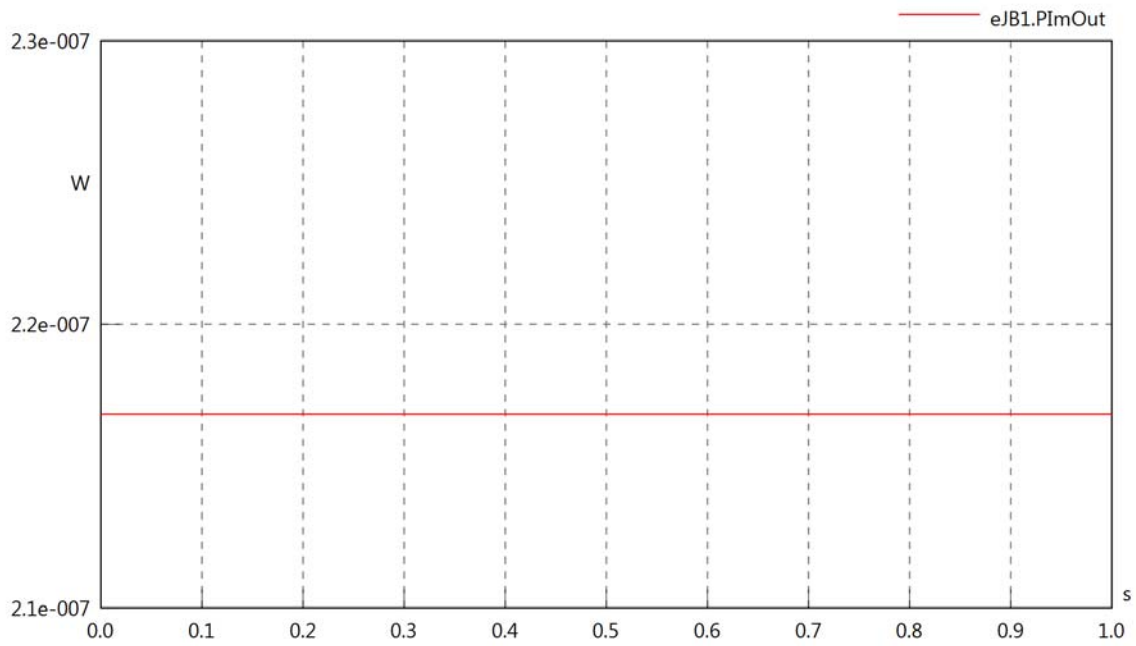

eJB1.SOut

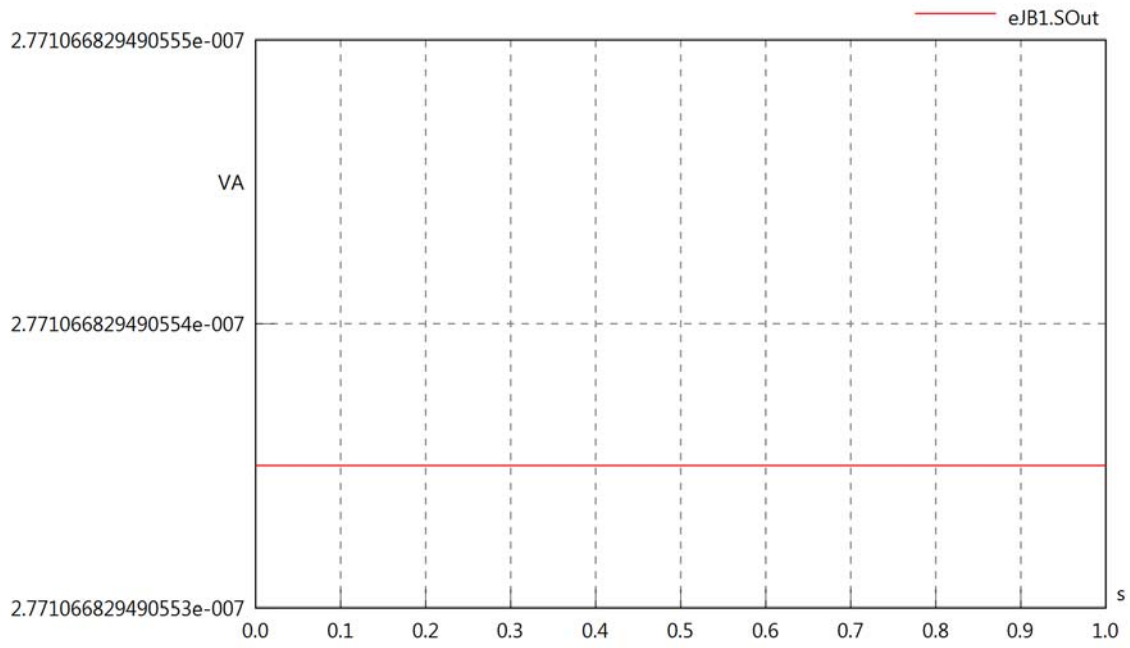
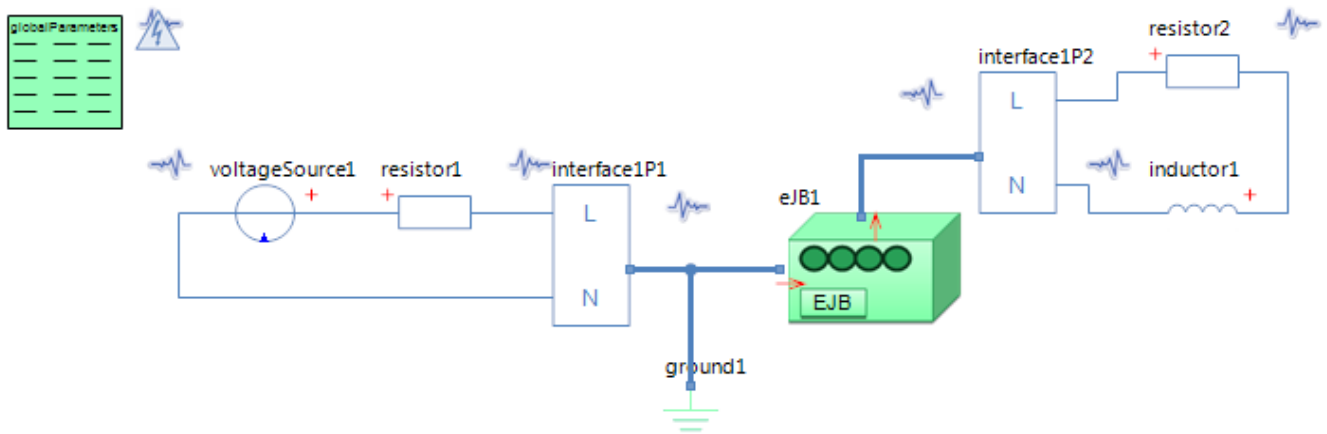

Diagram View



GlobalParameters globalParameters
Parameters

Comment	Name	Current Value	Unit
Type of Calculation	eCalculationKind	Signal Calculation	
Description of Frequency	eFrequencyKind	Linear	
Minimum Frequency	fMin	20000	[Hz]
Maximum Frequency	fMax	20000	[Hz]

Voltage Source voltageSource1
Parameters

Comment	Name	Current Value	Unit
Voltage RMS	VrmsSrc	230	[V]
Phase	phi	0	[deg]

Resistor resistor1
Parameters

Comment	Name	Current Value	Unit
Resistance	R	100	[Ohm]

Resistor resistor2
Parameters

Comment	Name	Current Value	Unit
Resistance	R	100	[Ohm]

Electrical Junction Box eJB1
Parameters

Comment	Name	Current Value	Unit
Poor or failing L1 connection	bL1	true	
Resistance in L1 connection	rL1	1	[kOhm]
Conductance between L1 and N	G	50	[1/Ohm]

Inductor inductor1
Parameters

Comment	Name	Current Value	Unit
Inductance	L	5	[mH]

eJB1.VrmsIn

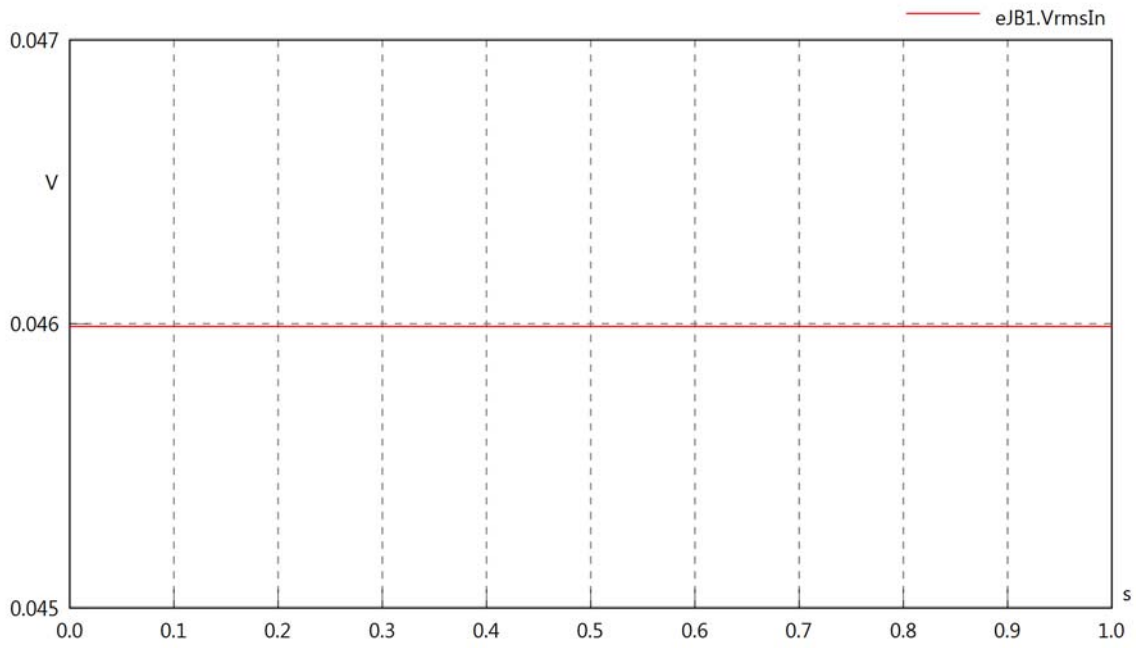

eJB1.vReIn

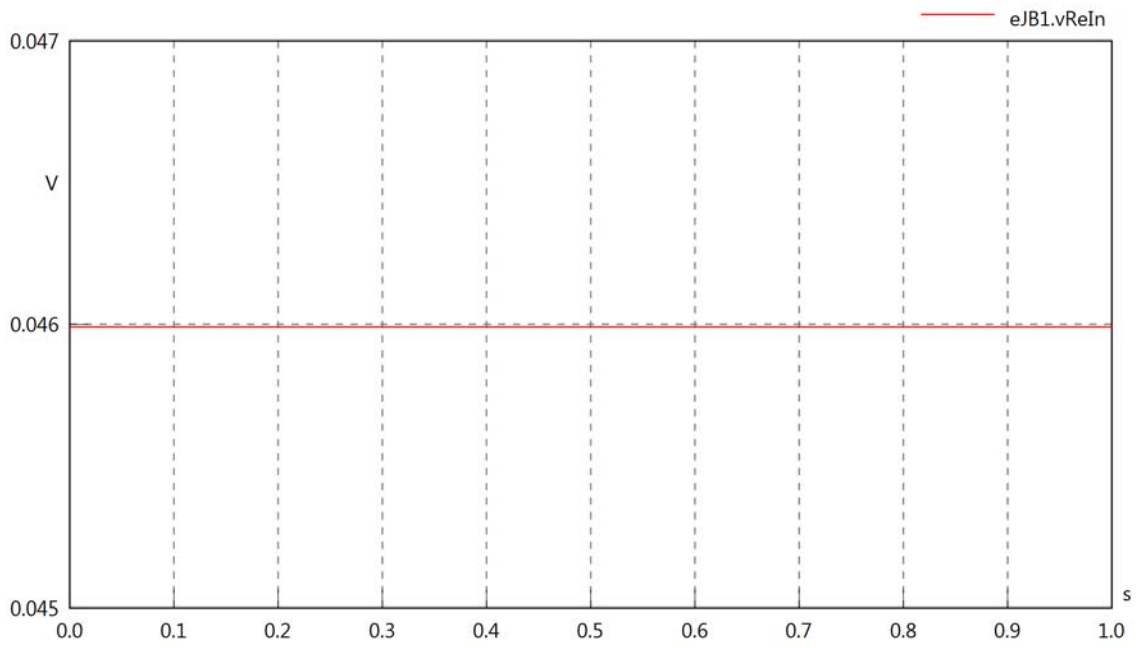

eJB1.vImIn

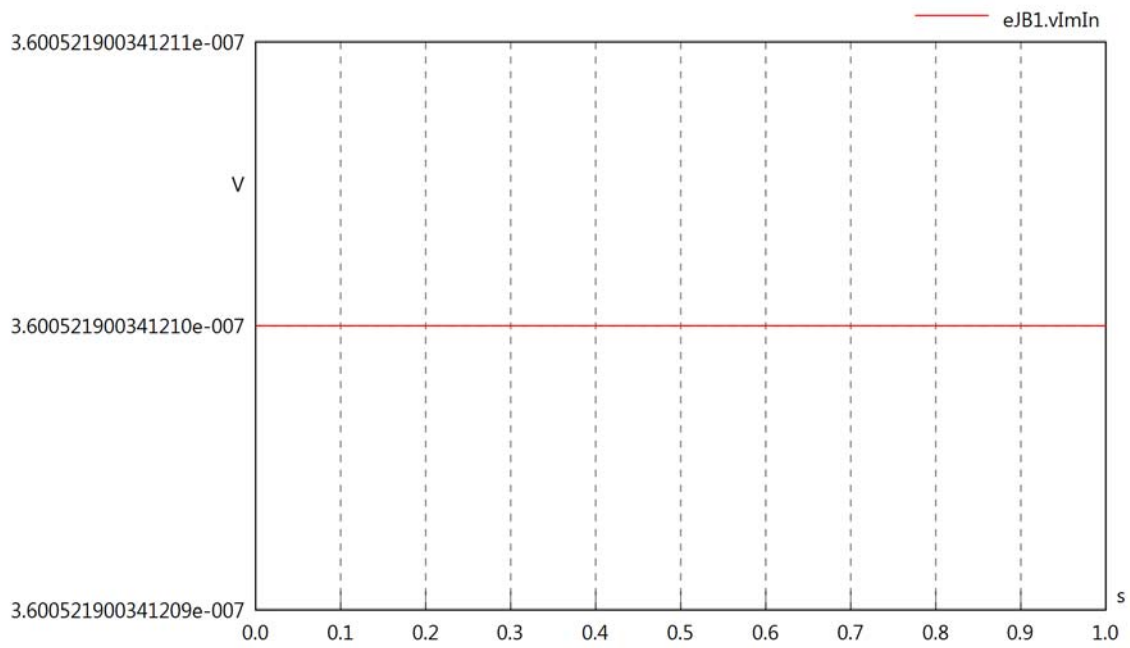

eJB1.VrmsOut

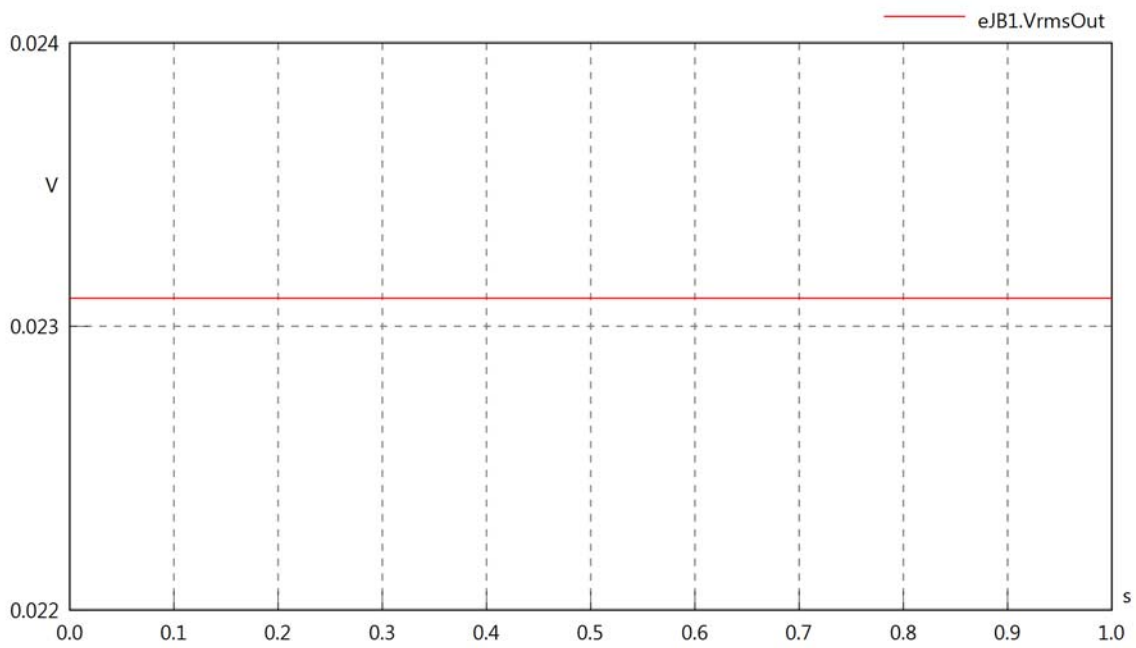

eJB1.vReOut

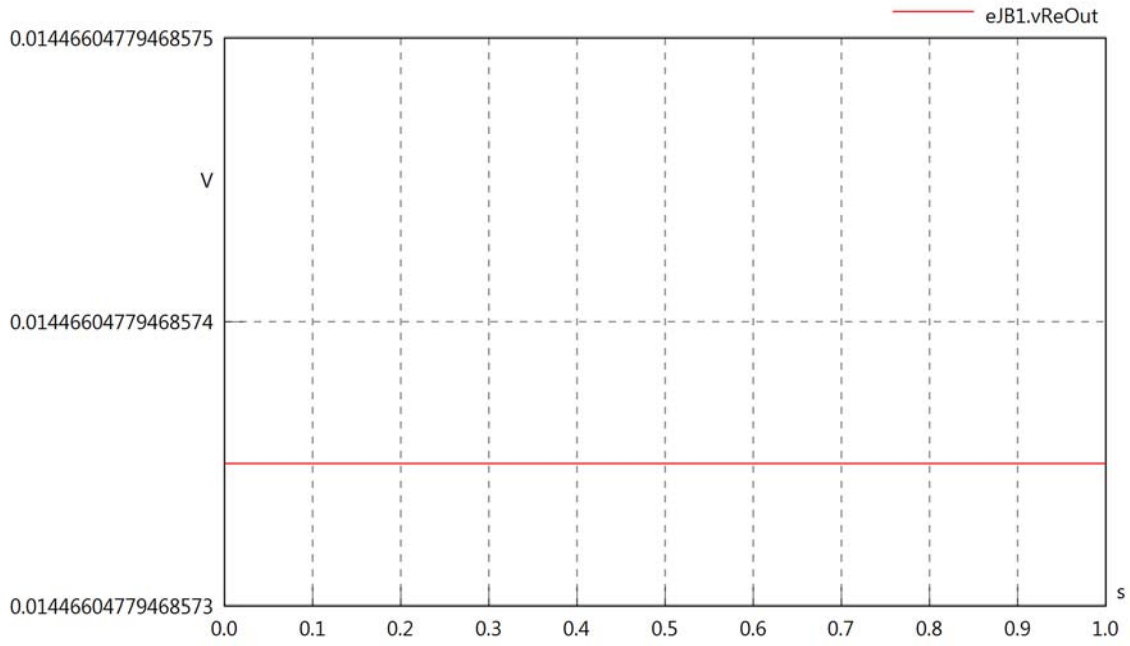

eJB1.vImOut

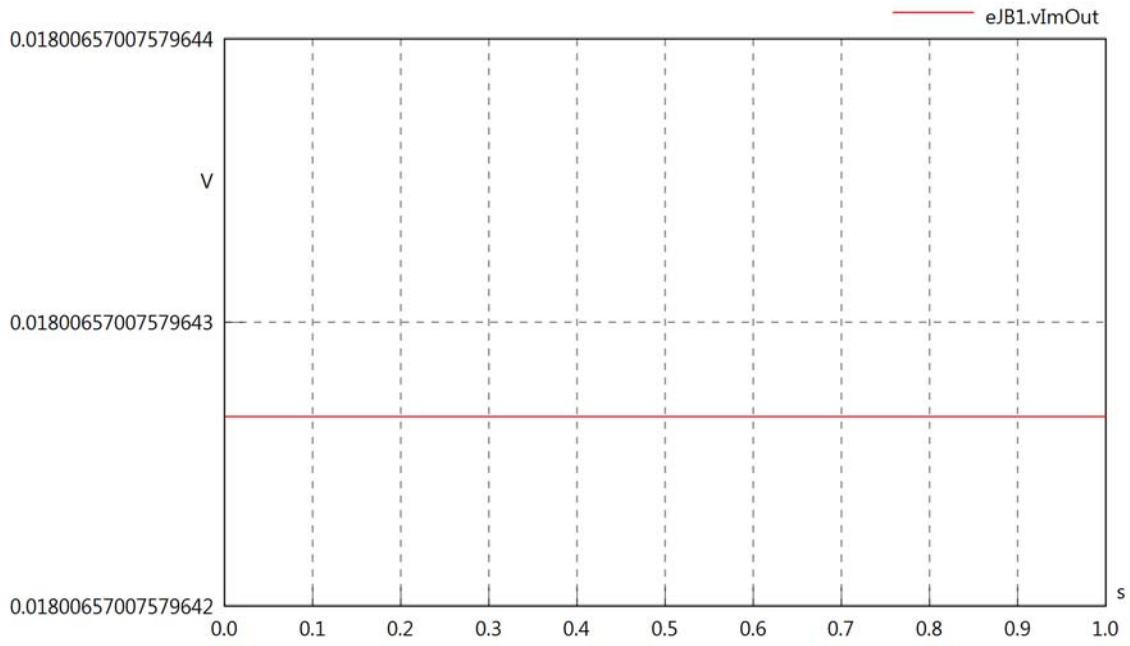

eJB1.Vrms

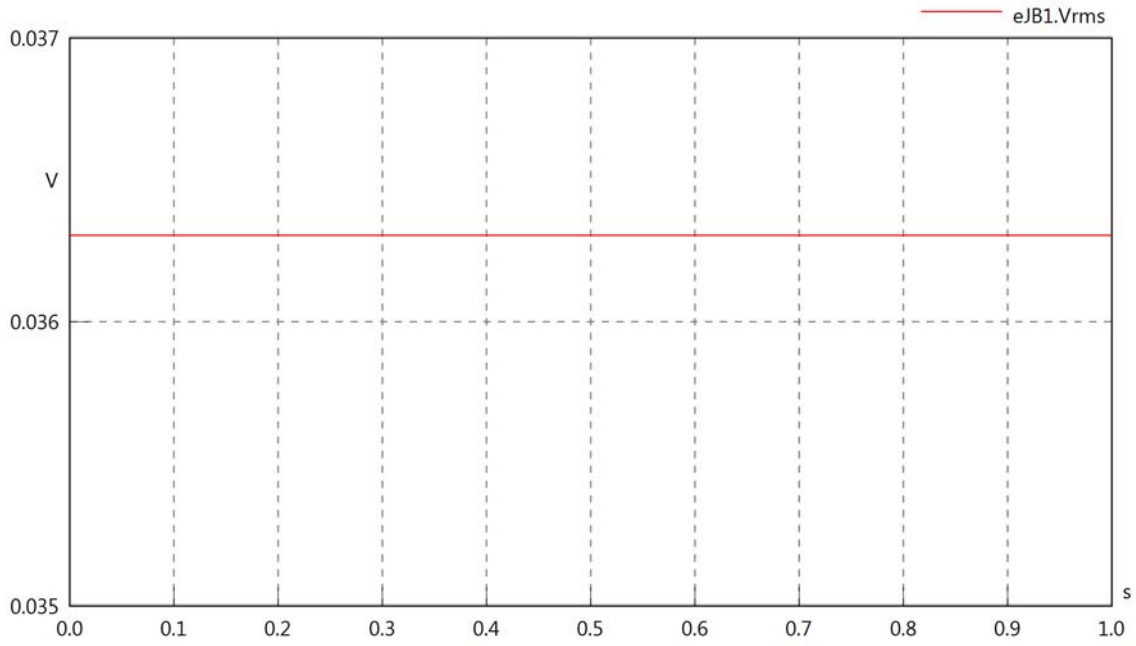

eJB1.vRe

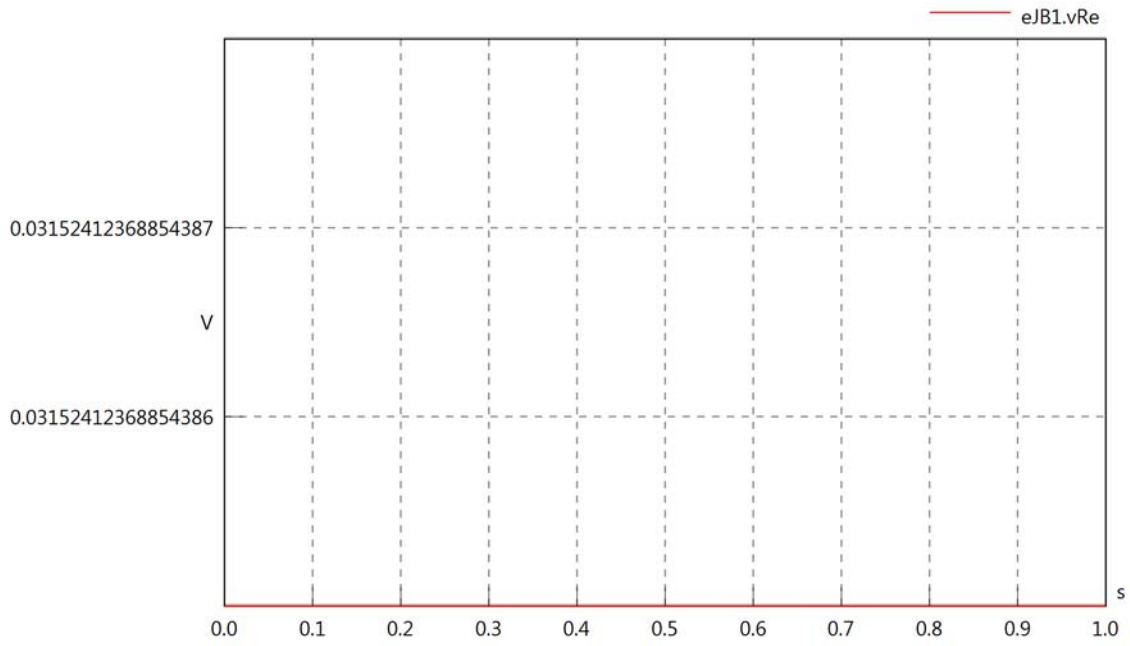

eJB1.vIm

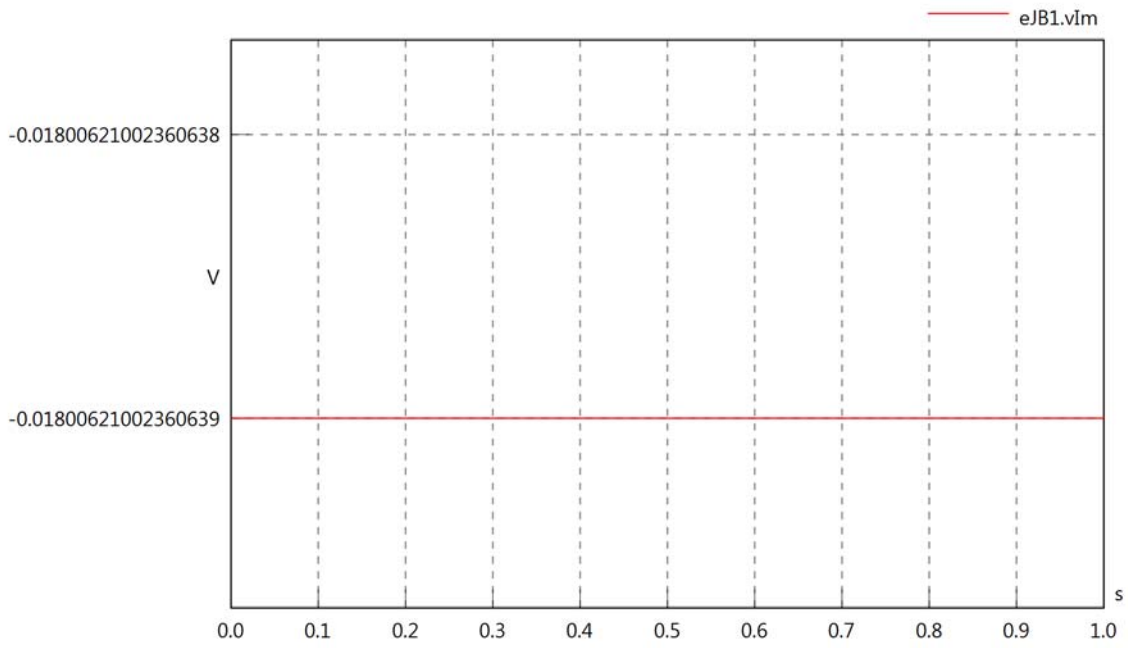

eJB1.IrmsIn

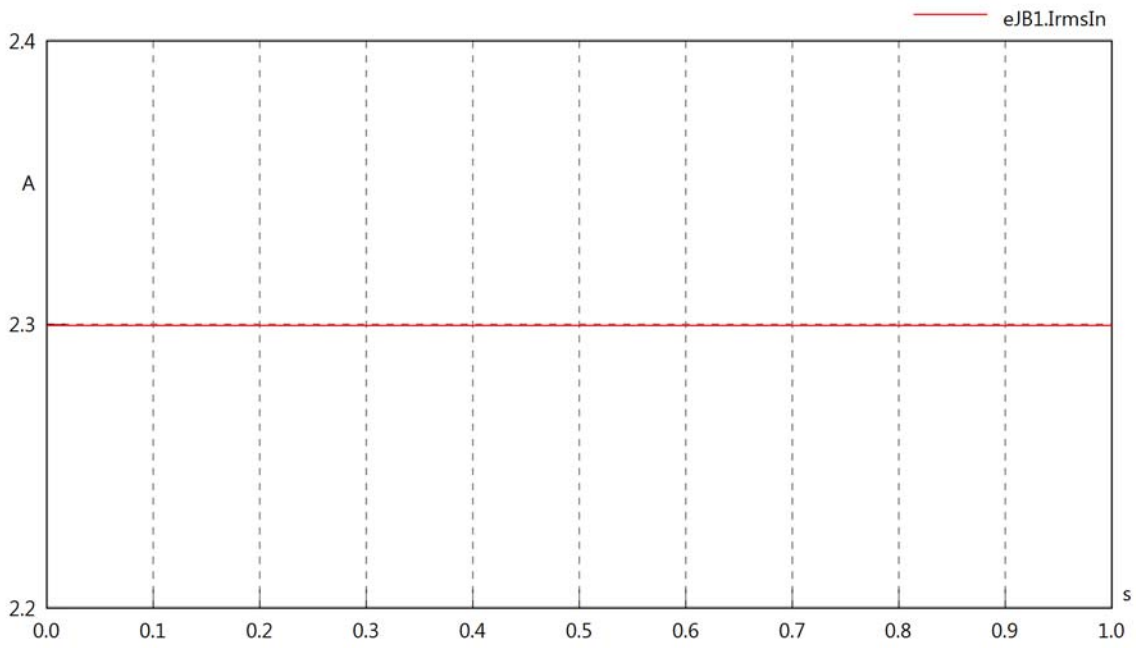

eJB1.iReIn

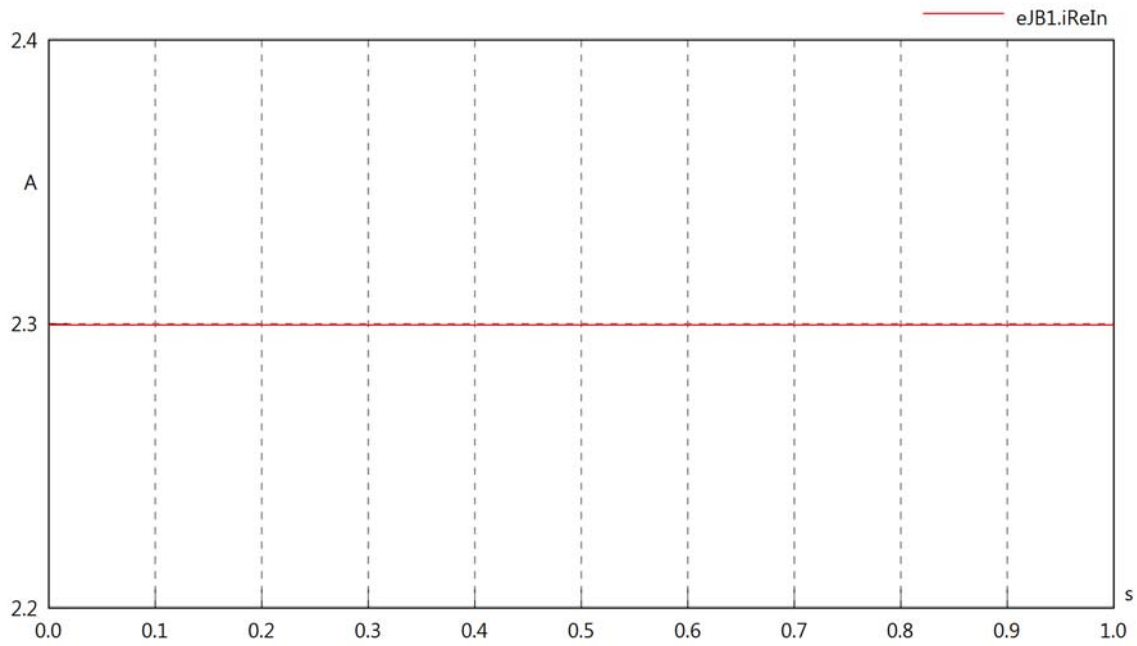

eJB1.iImIn

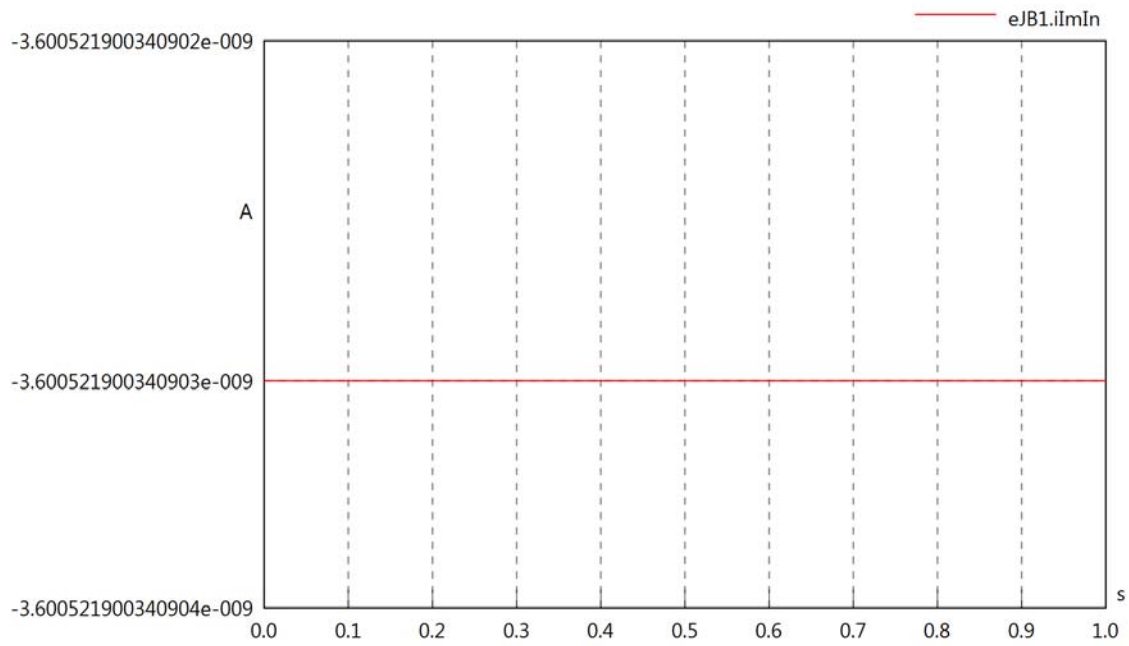

eJB1.IrmsOut

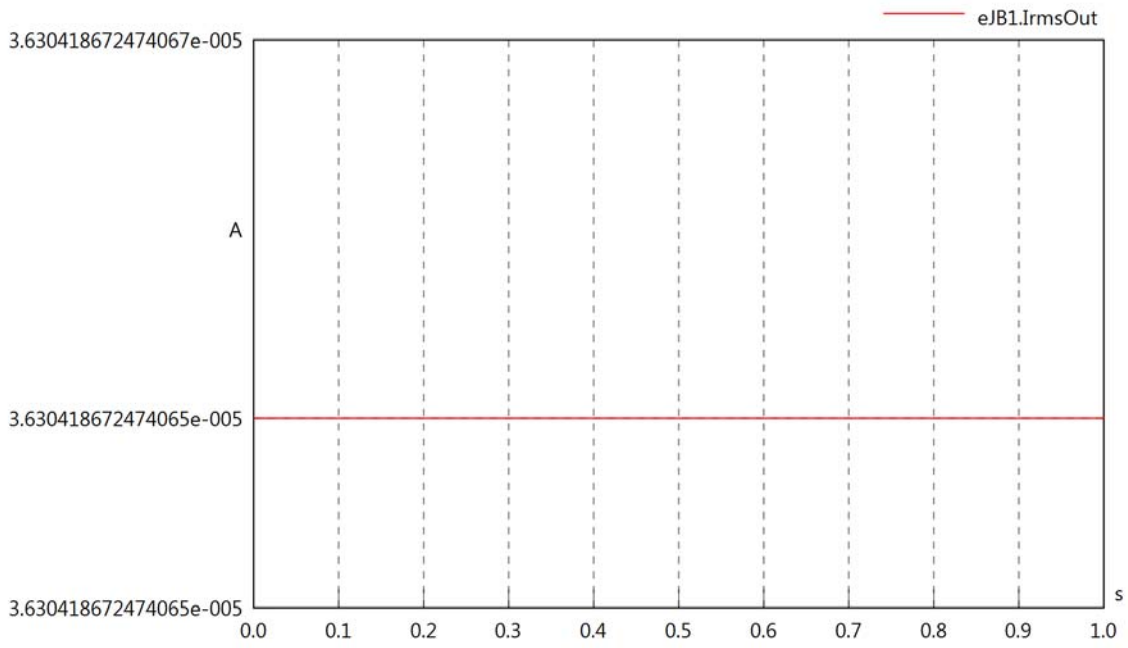

eJB1.iReOut

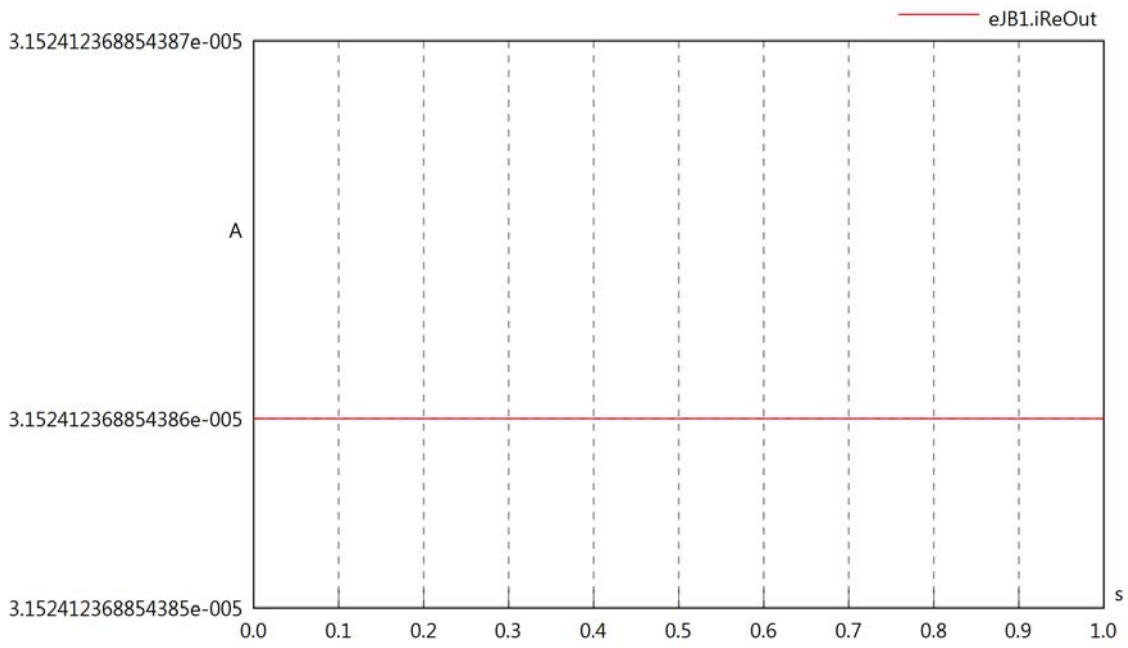

eJB1.iImOut

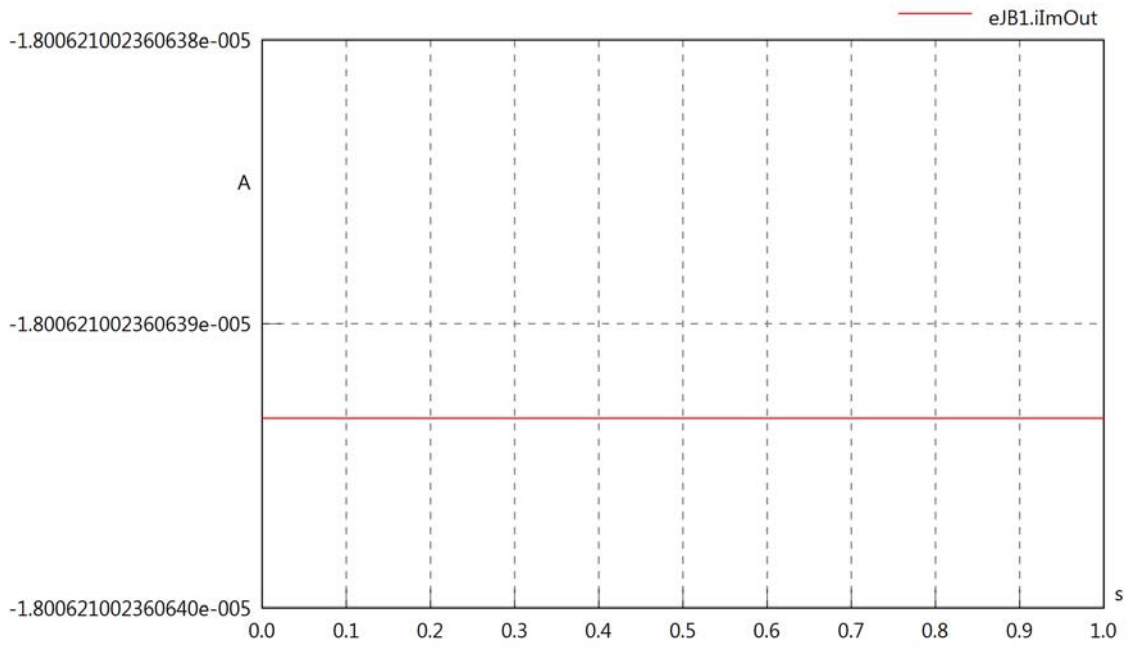

eJB1.phiVIn

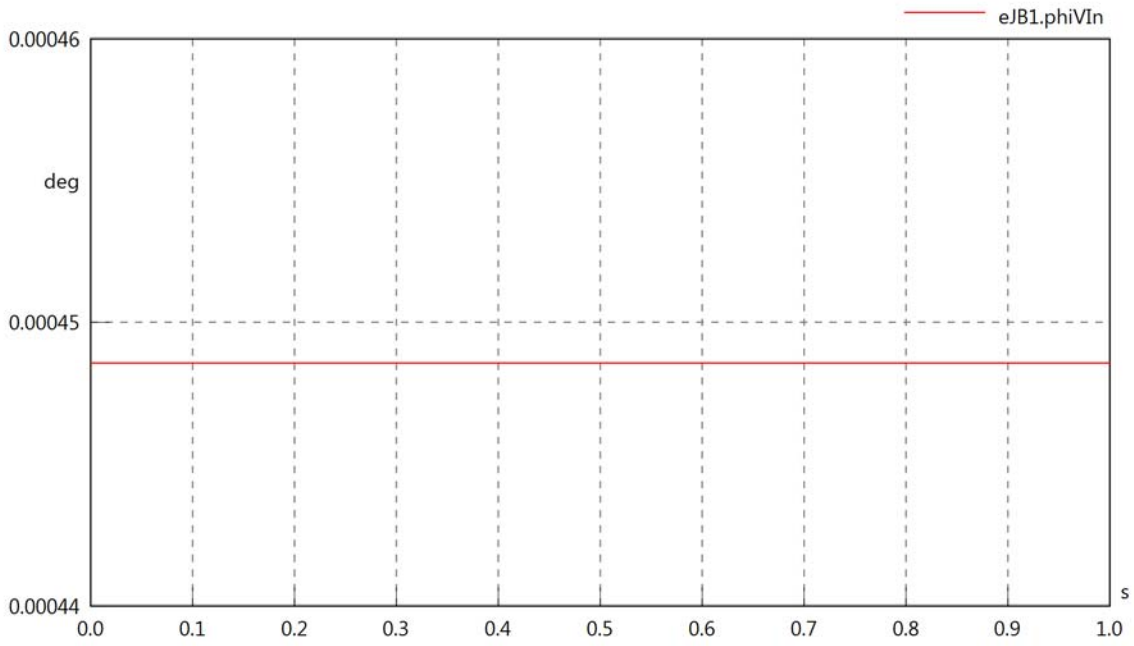

eJB1.phiIn

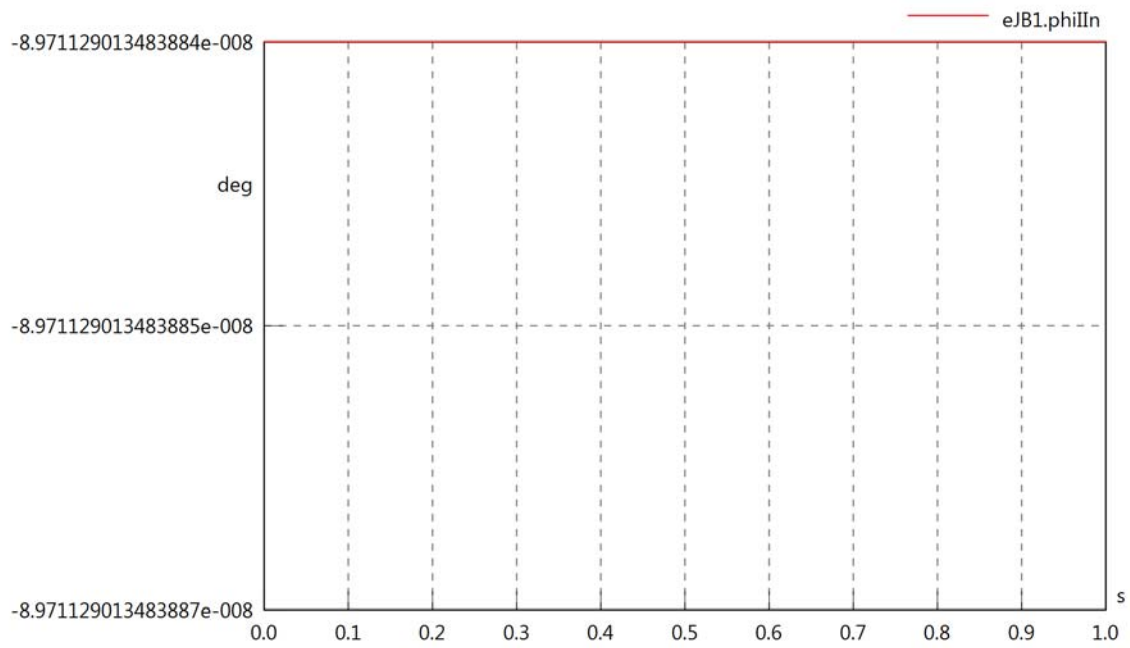

eJB1.phiIVIn

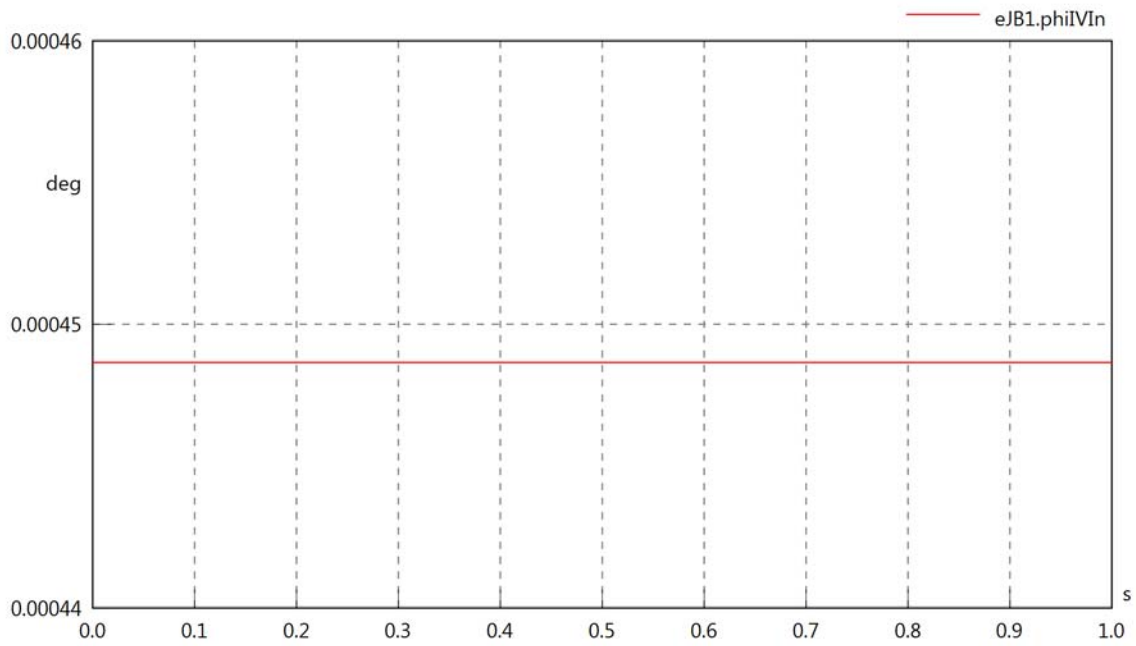

eJB1.phiVOut

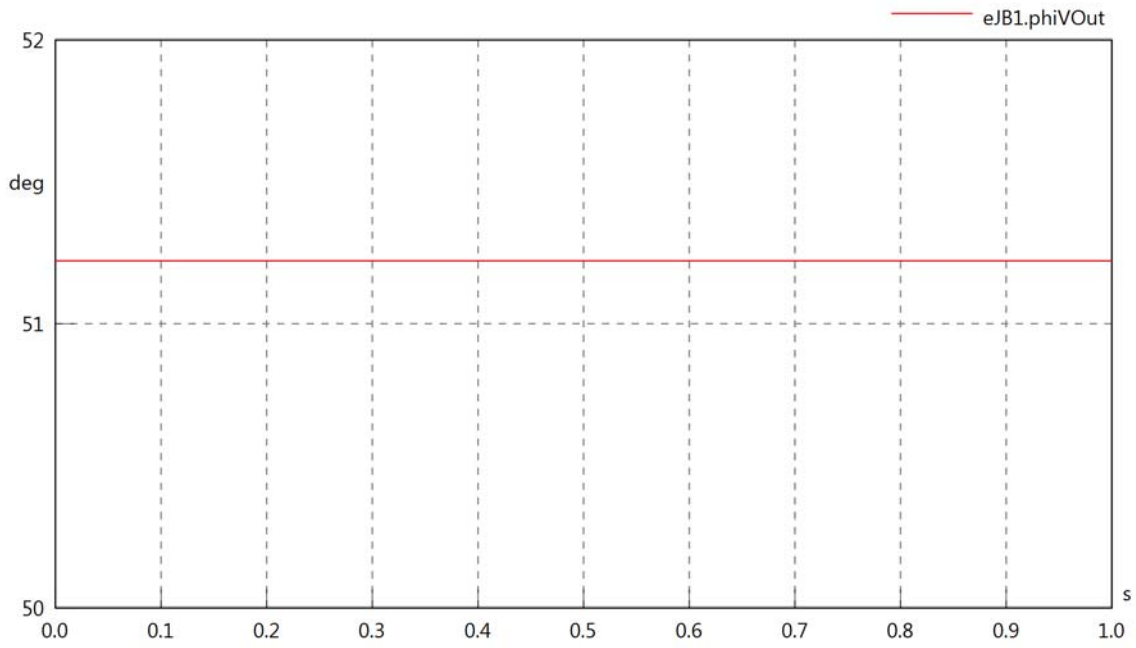

eJB1.phiIOut

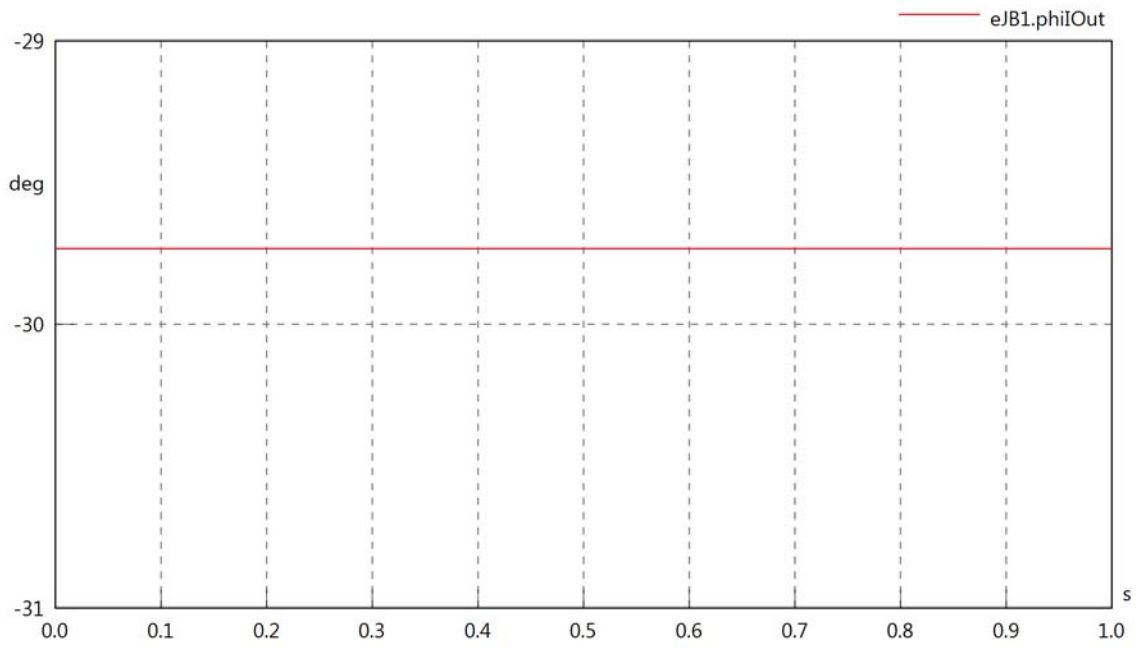

eJB1.phiIVOut

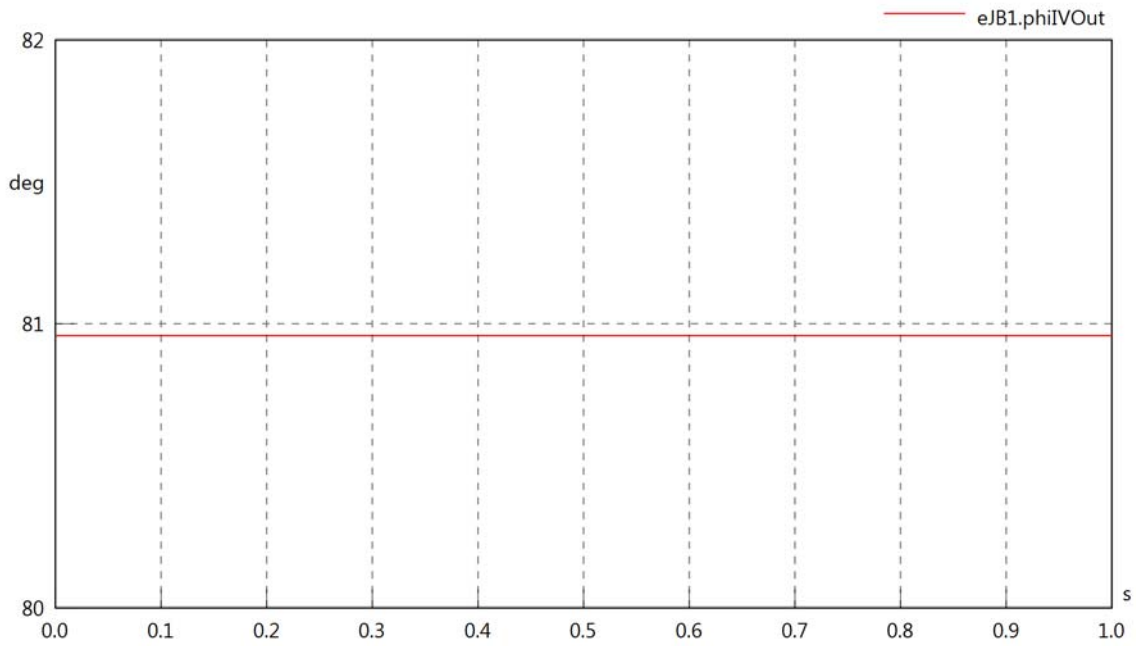

eJB1.PReIn

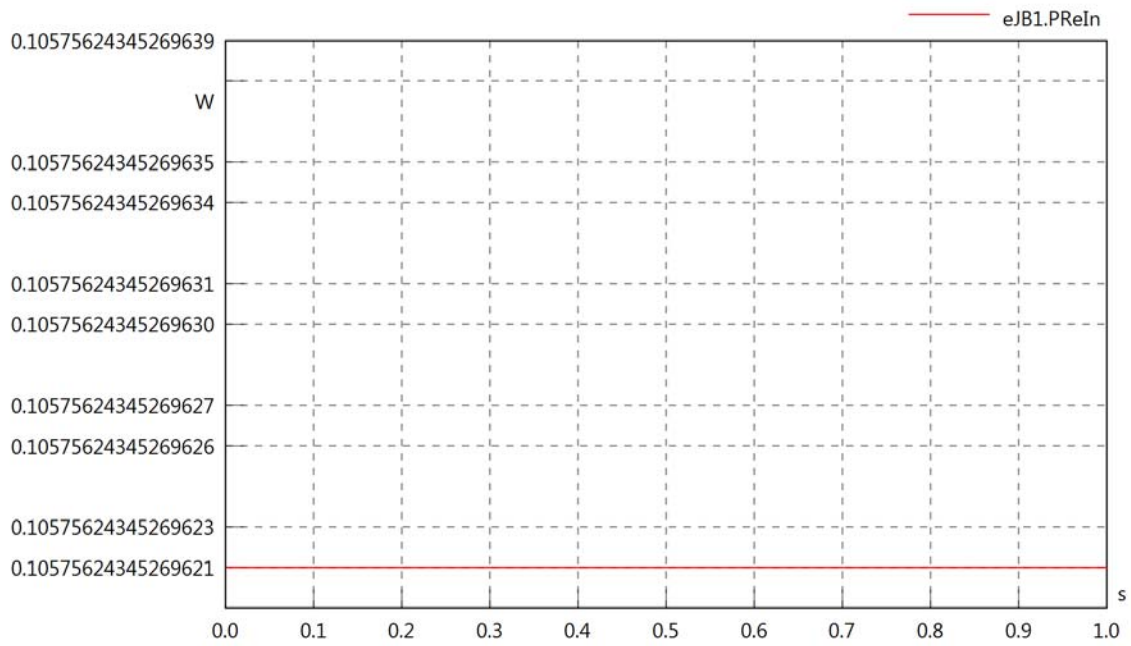

eJB1.PImIn

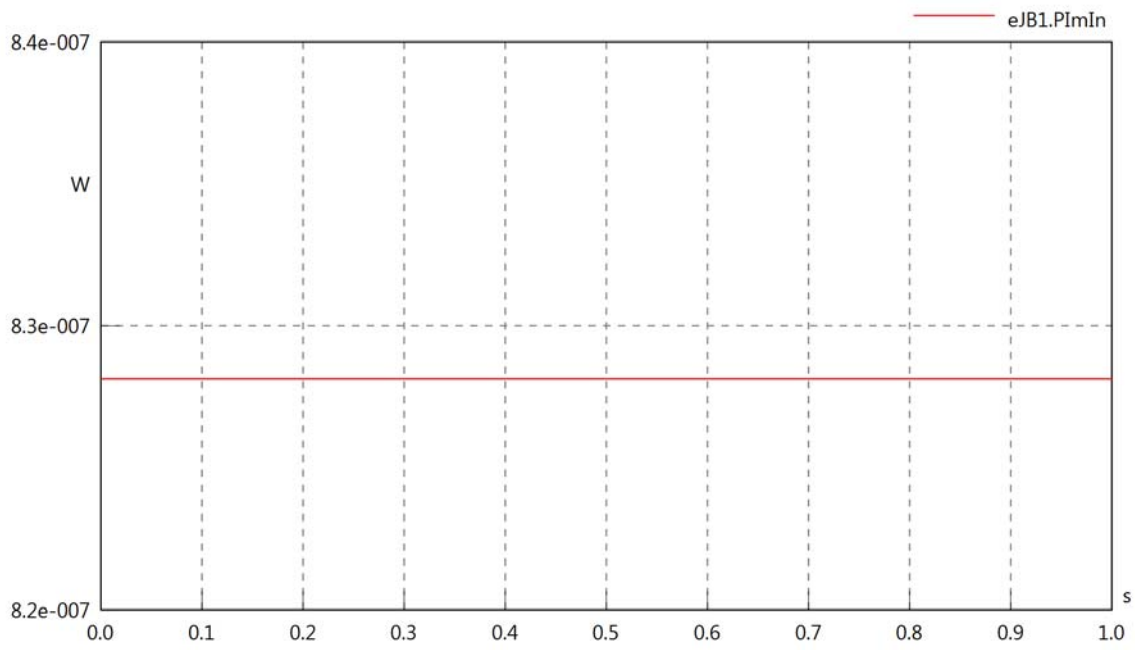

eJB1.SIn

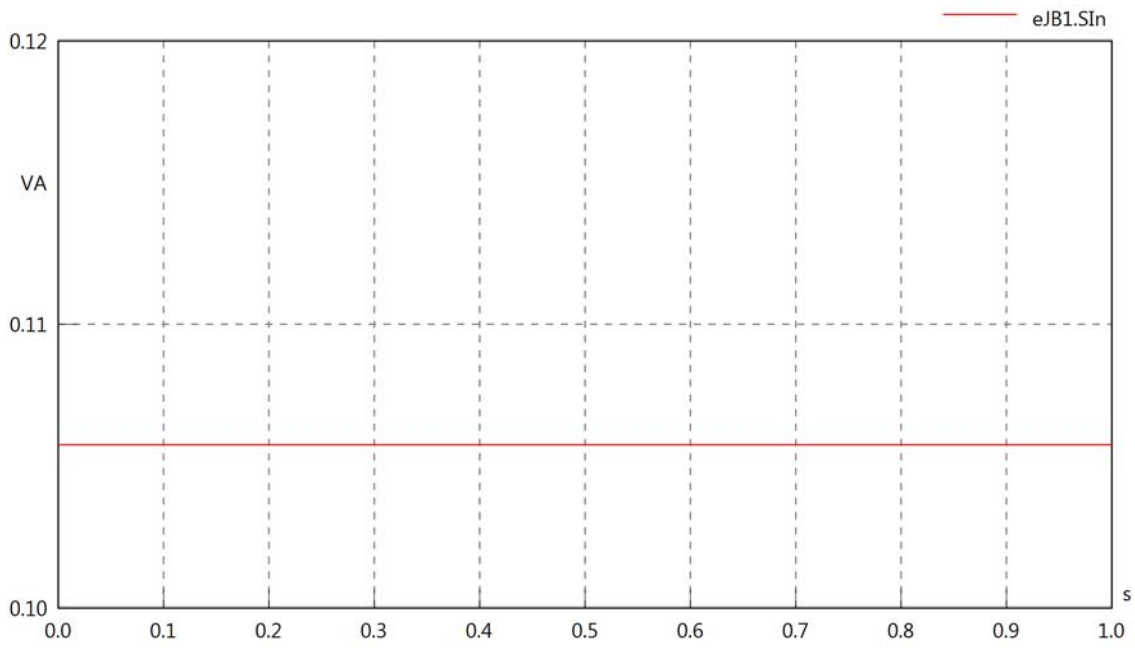

eJB1.PReOut

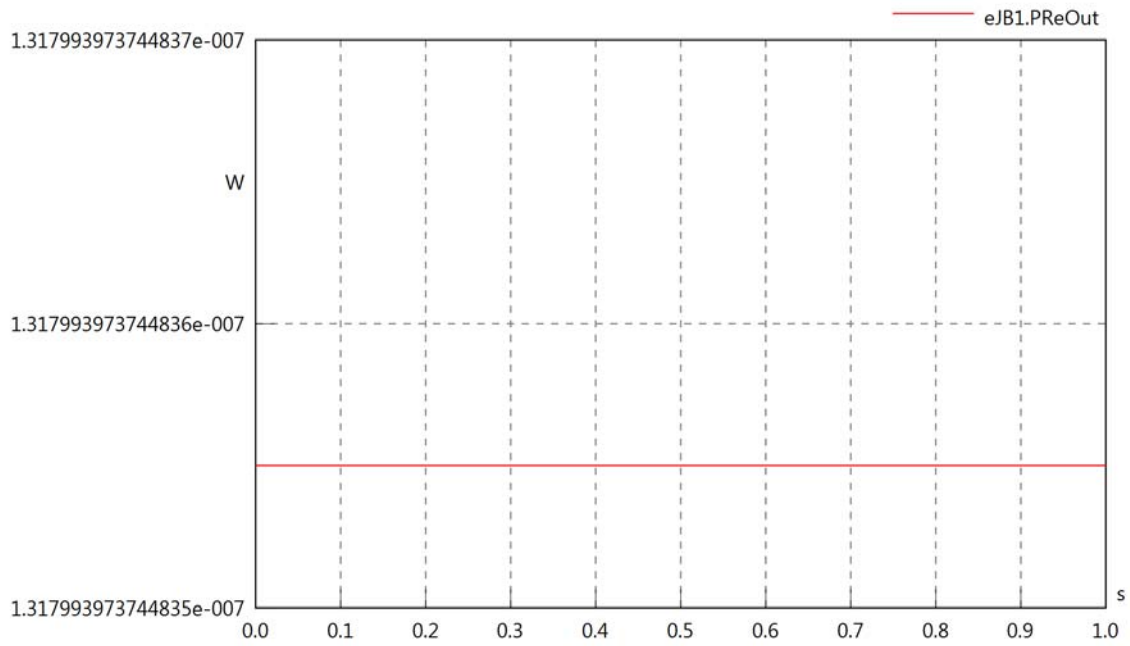

eJB1.PImOut

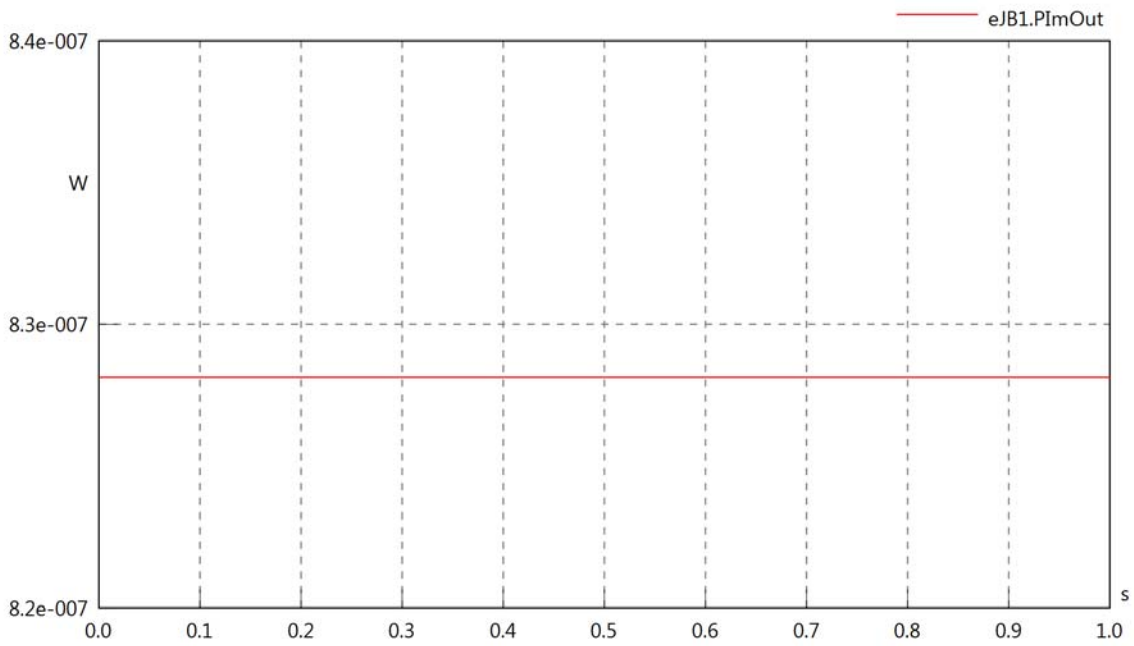

eJB1.SOut

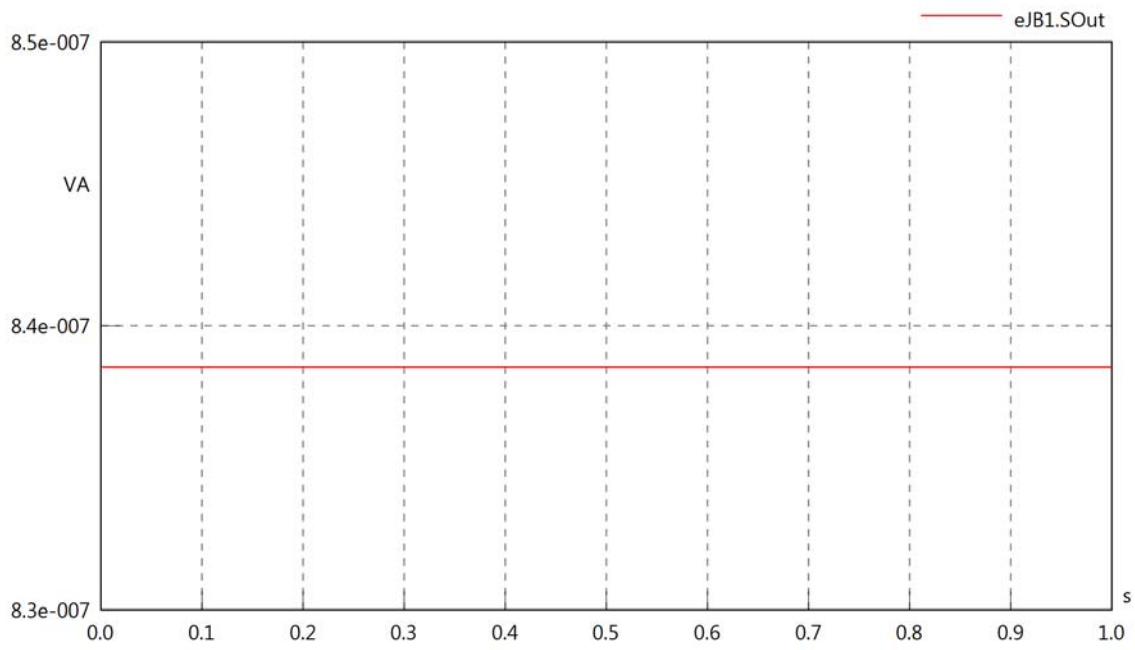
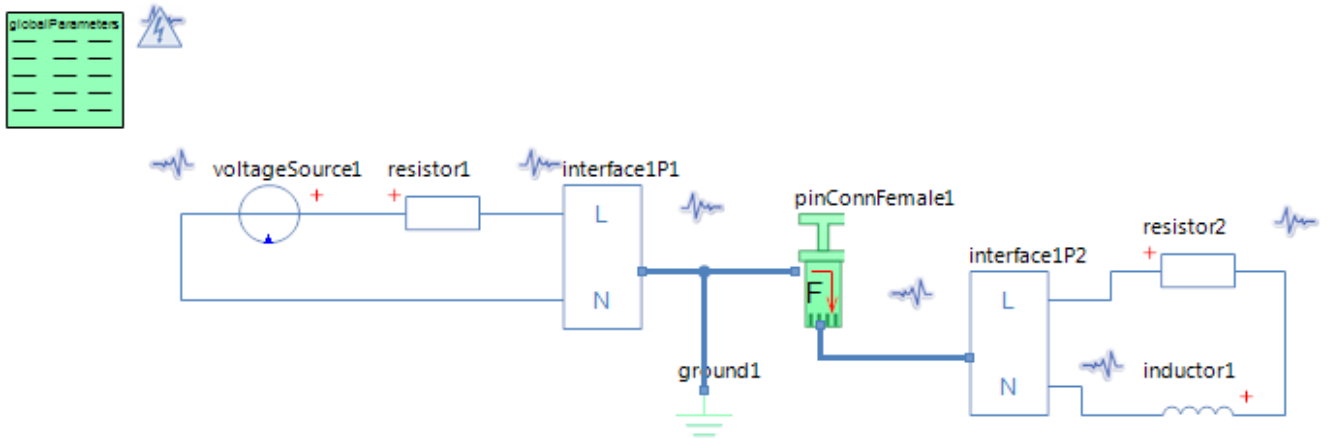

Diagram View



GlobalParameters globalParameters
Parameters

Comment	Name	Current Value	Unit
Type of Calculation	eCalculationKind	Signal Calculation	
Description of Frequency	eFrequencyKind	Linear	
Minimum Frequency	fMin	60	[Hz]
Maximum Frequency	fMax	60	[Hz]

Voltage Source voltageSource1
Parameters

Comment	Name	Current Value	Unit
Voltage RMS	VrmsSrc	230	[V]
Phase	phi	0	[deg]

Resistor resistor1
Parameters

Comment	Name	Current Value	Unit
Resistance	R	100	[Ohm]

Resistor resistor2
Parameters

Comment	Name	Current Value	Unit
Resistance	R	100	[Ohm]

Inductor inductor1
Parameters

Comment	Name	Current Value	Unit
Inductance	L	5	[mH]

Pin Connector Female pinConnFemale1
Parameters

Comment	Name	Current Value	Unit
Poor or failing L1 connection	bL1	false	

pinConnFemale1.VrmsIn

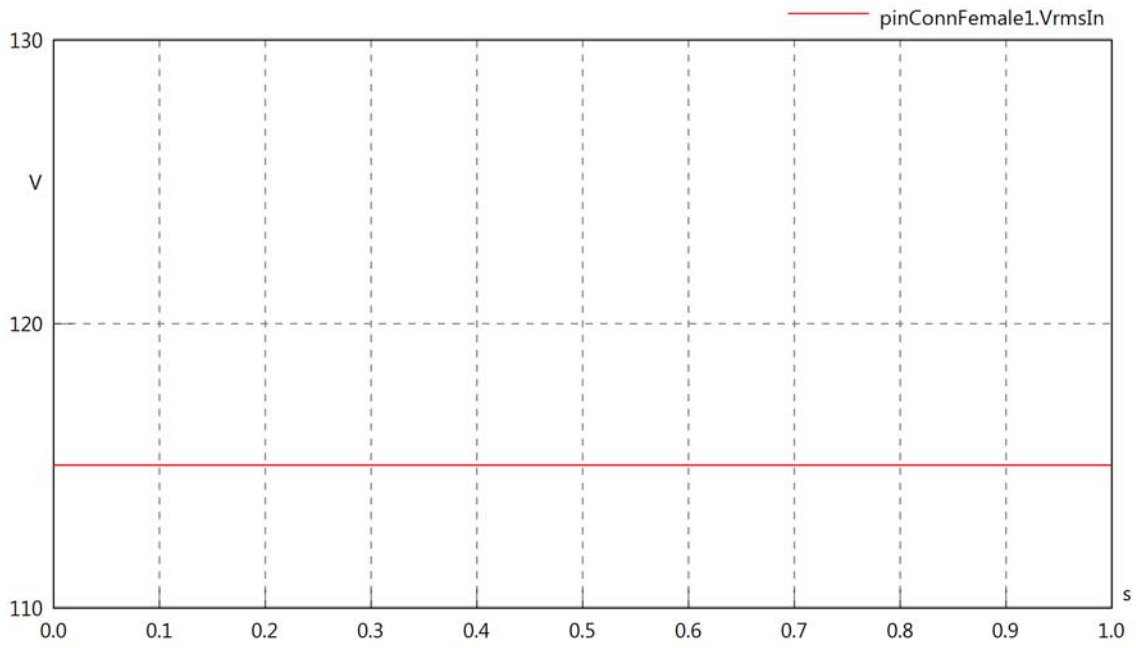

pinConnFemale1.vReIn

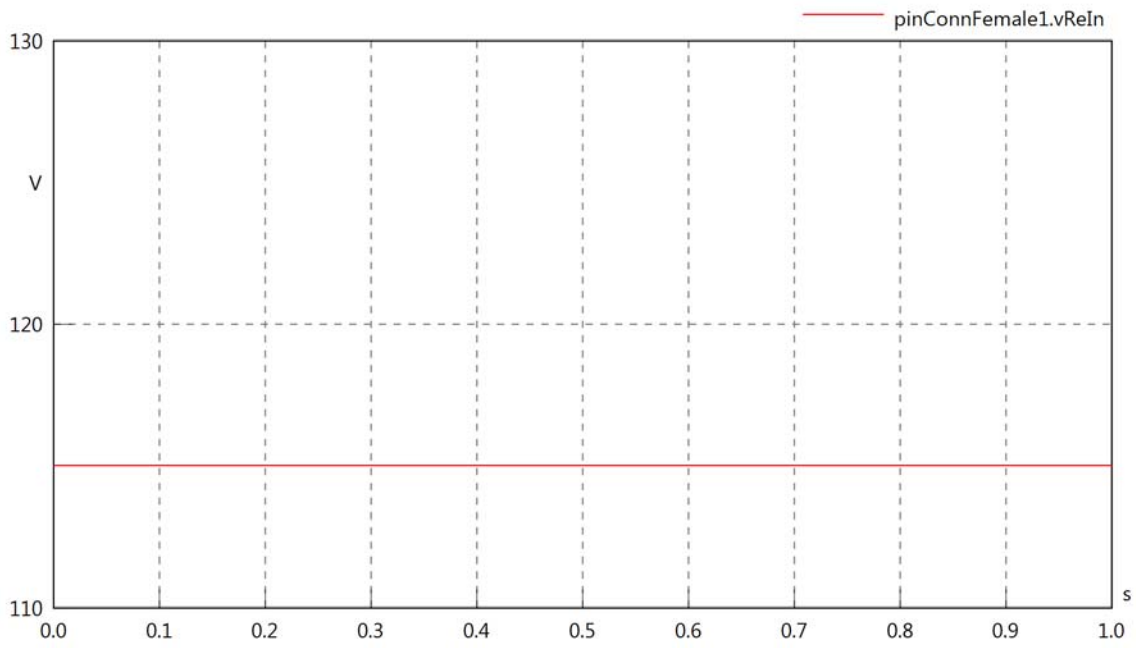

pinConnFemale1.vImIn

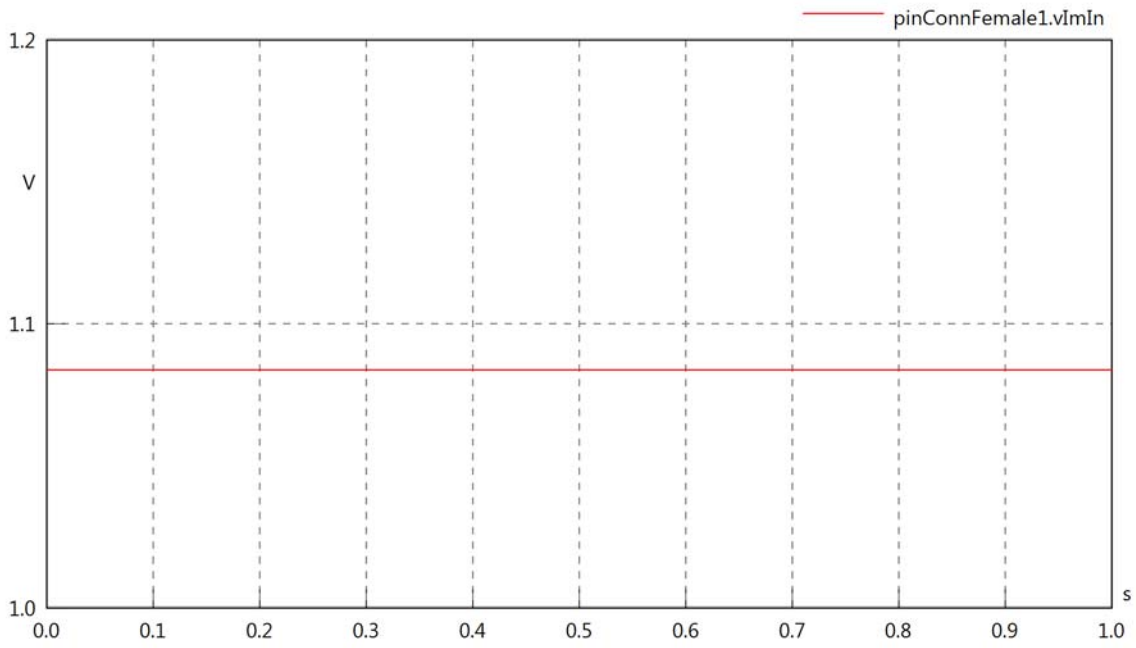

pinConnFemale1.VrmsOut

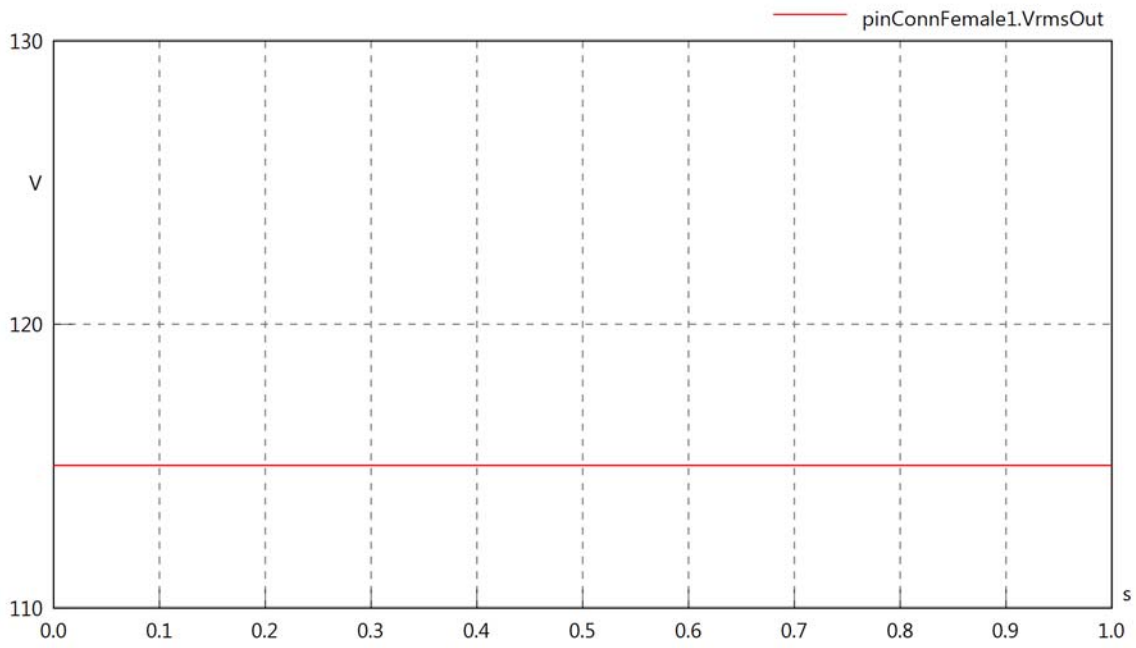

pinConnFemale1.vReOut

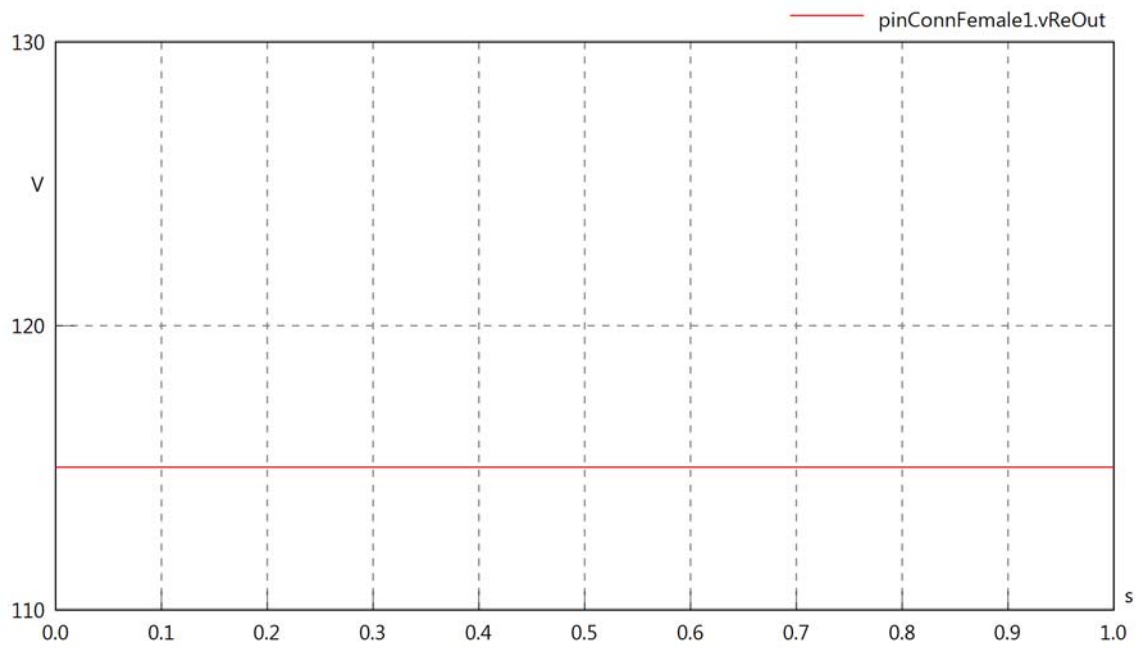

pinConnFemale1.vImOut

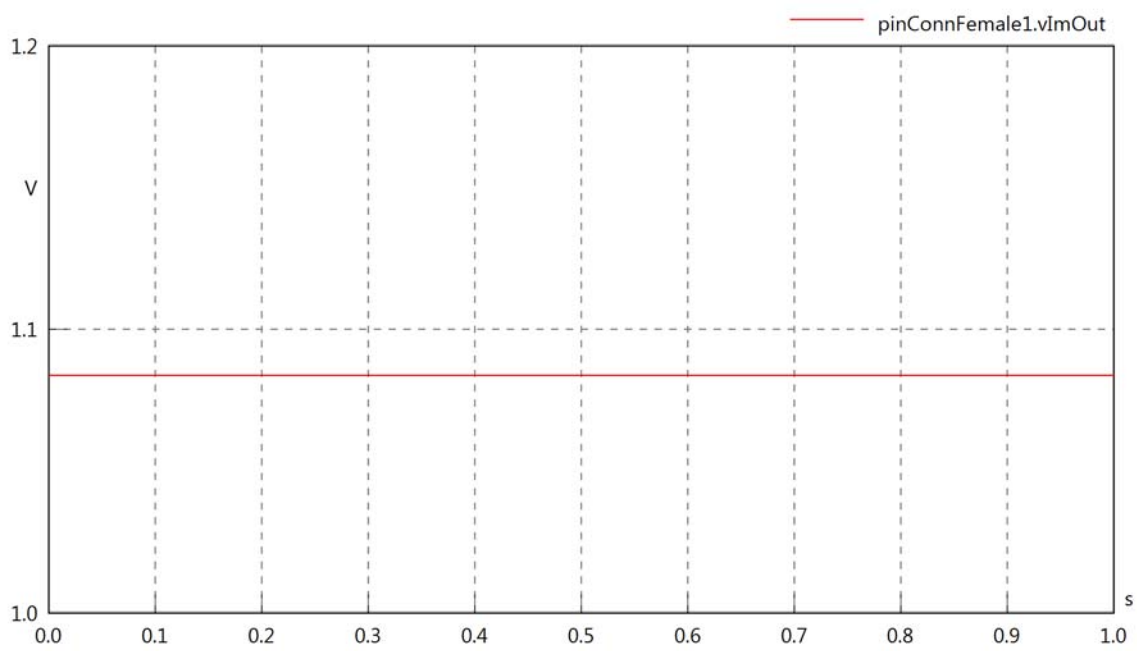

pinConnFemale1.Vrms

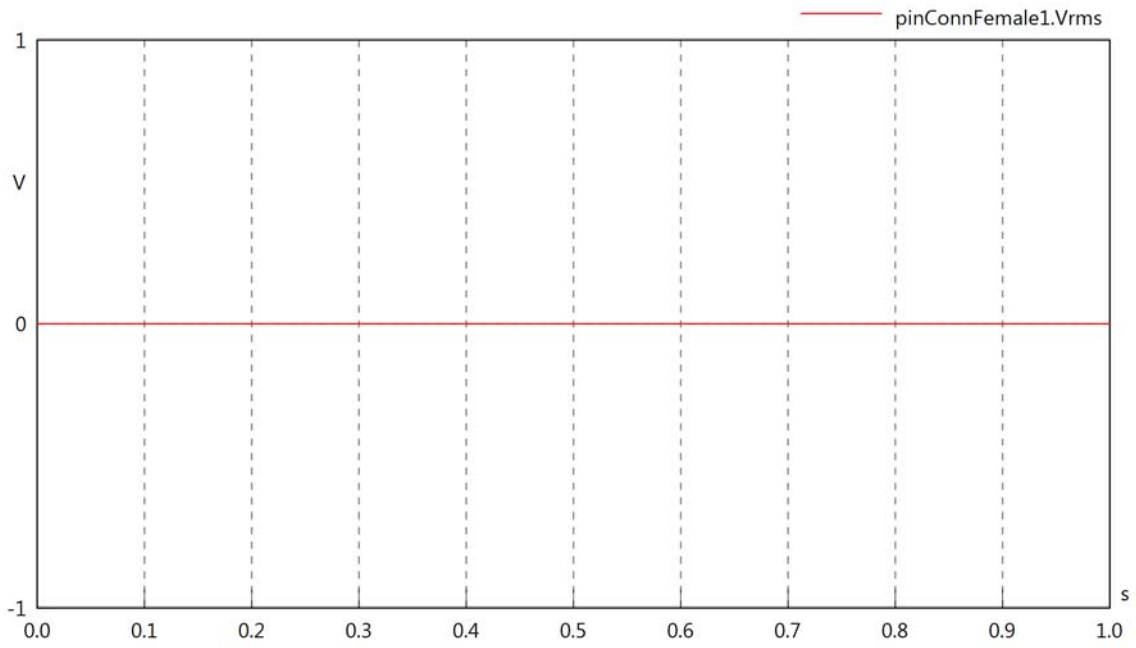

pinConnFemale1.vRe

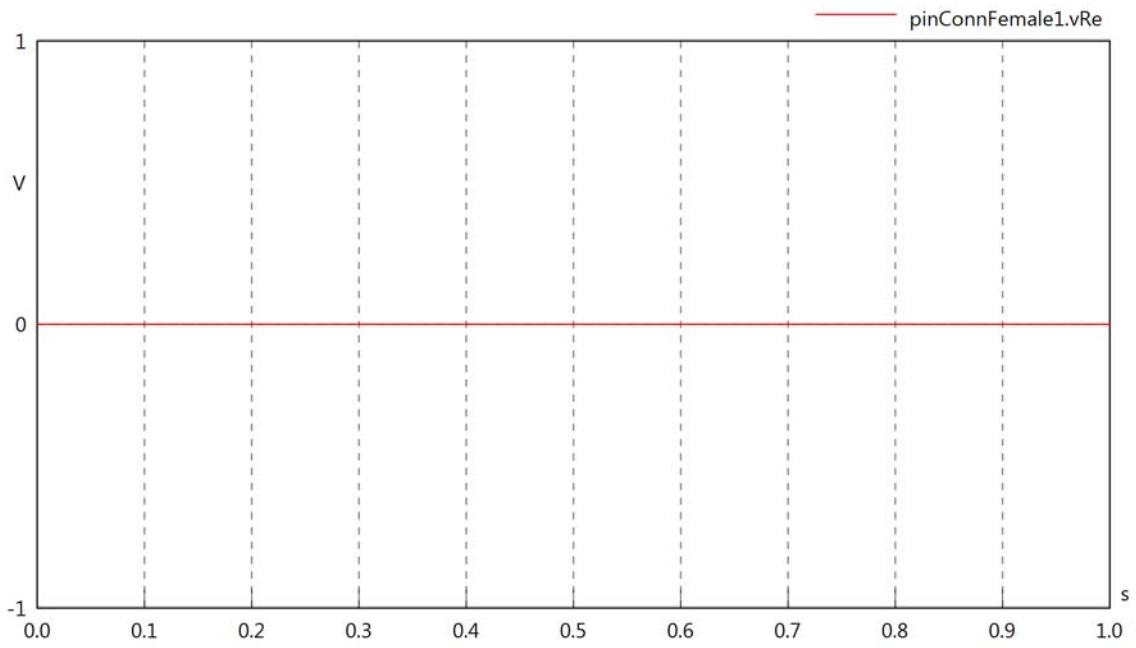

pinConnFemale1.vIm

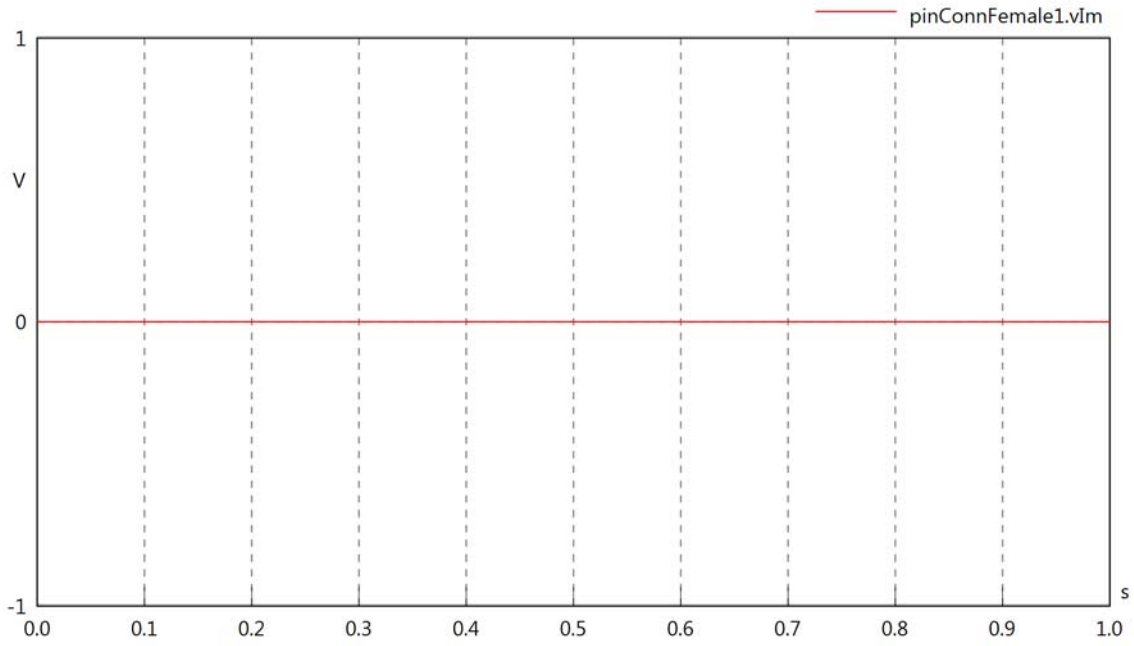

pinConnFemale1.IrmsIn

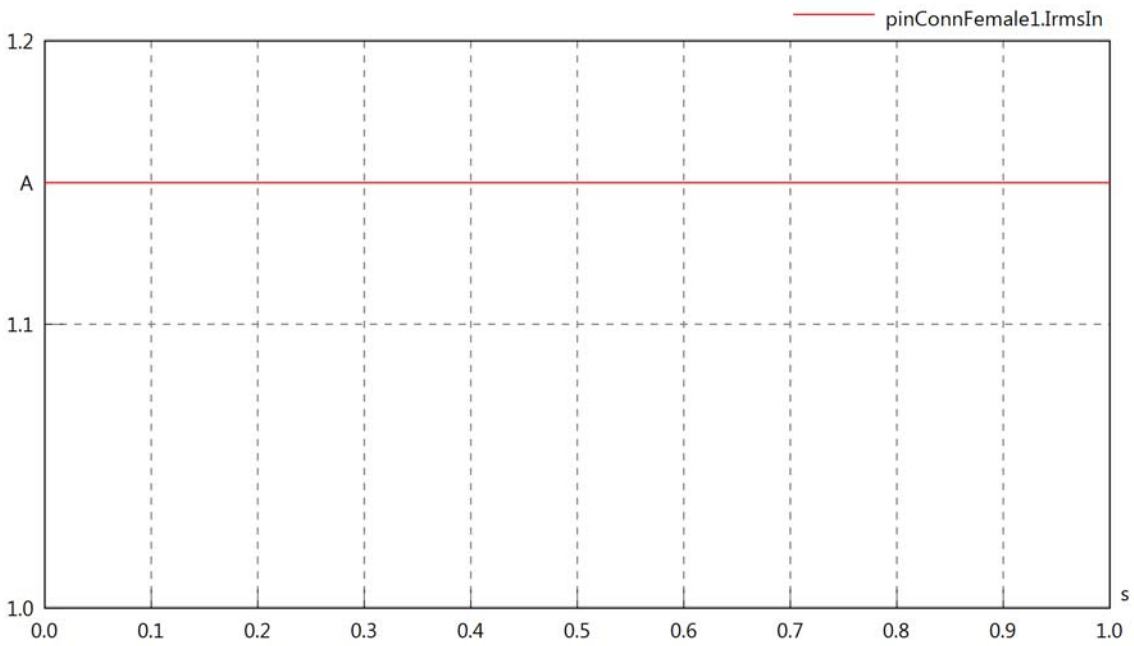

pinConnFemale1.iReIn

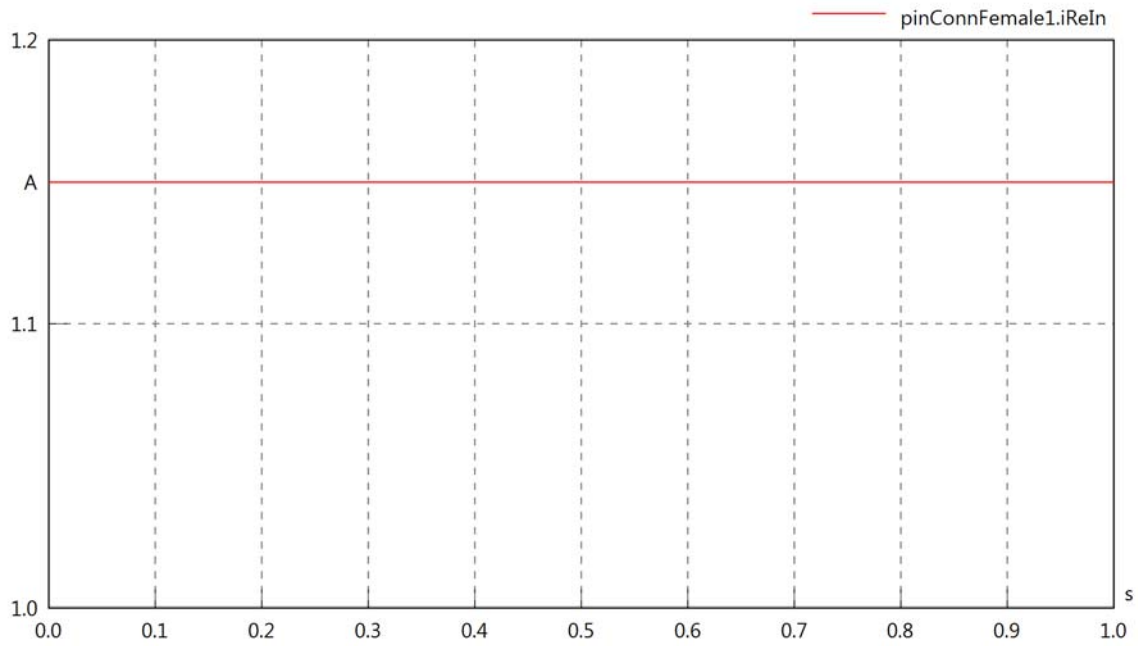

pinConnFemale1.iImIn

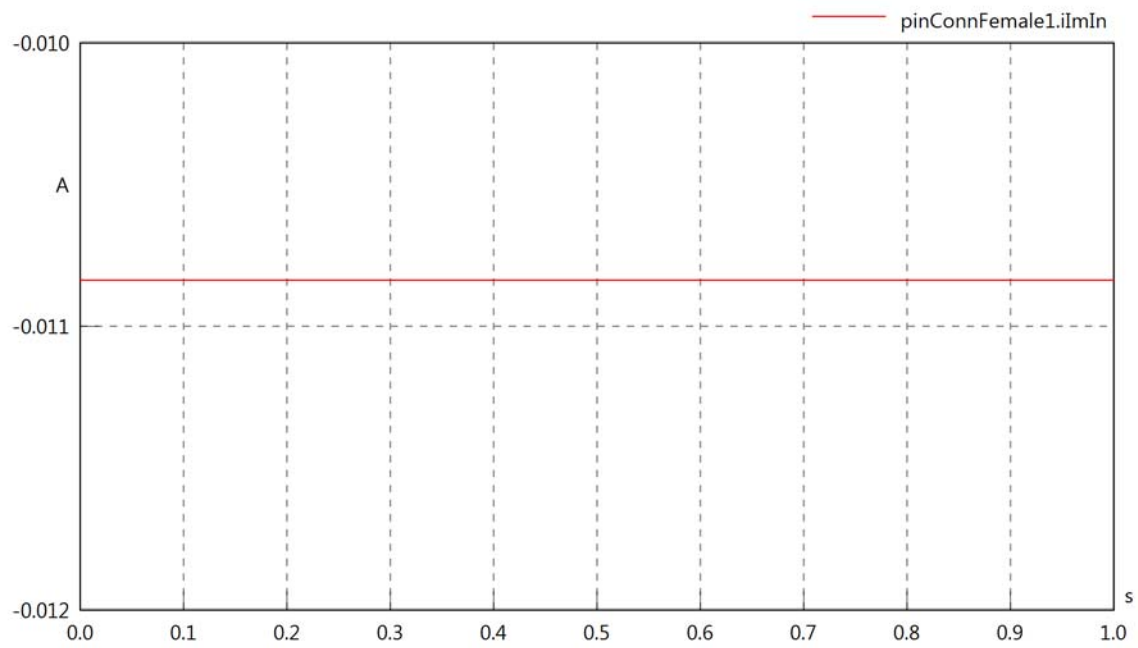

pinConnFemale1.IrmsOut

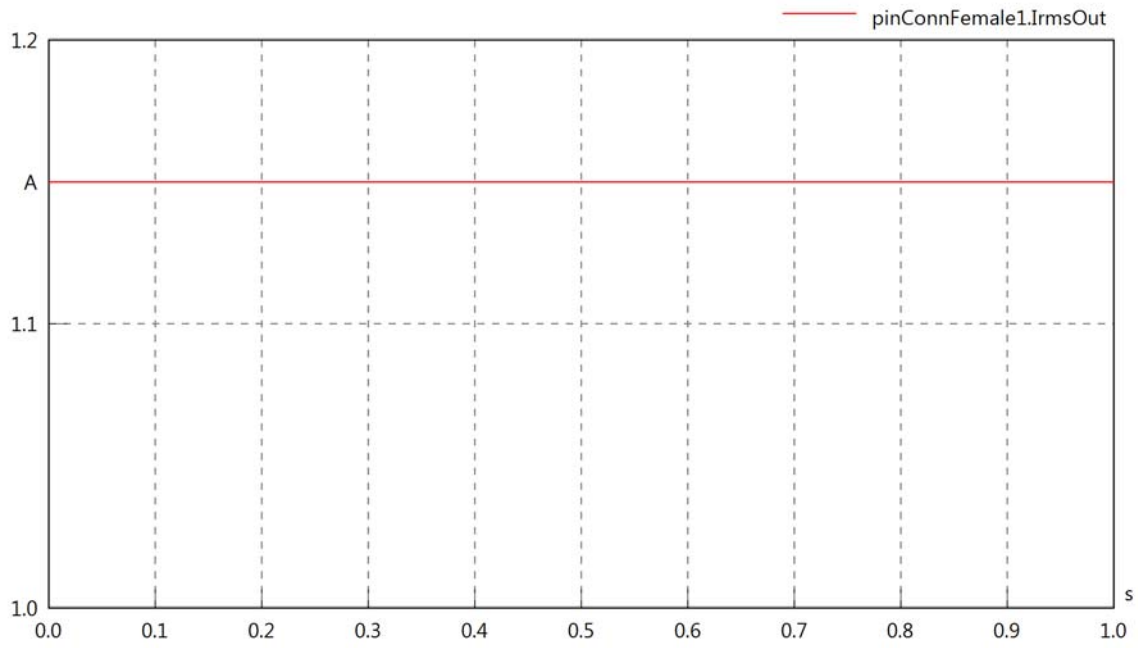

pinConnFemale1.iReOut

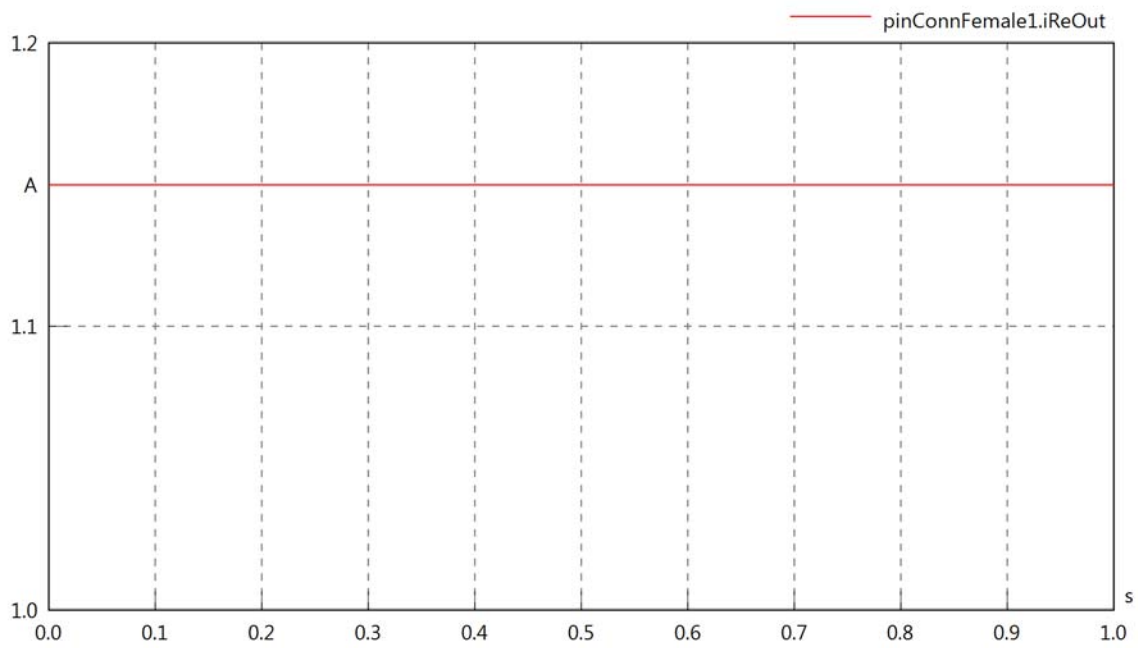

pinConnFemale1.iImOut

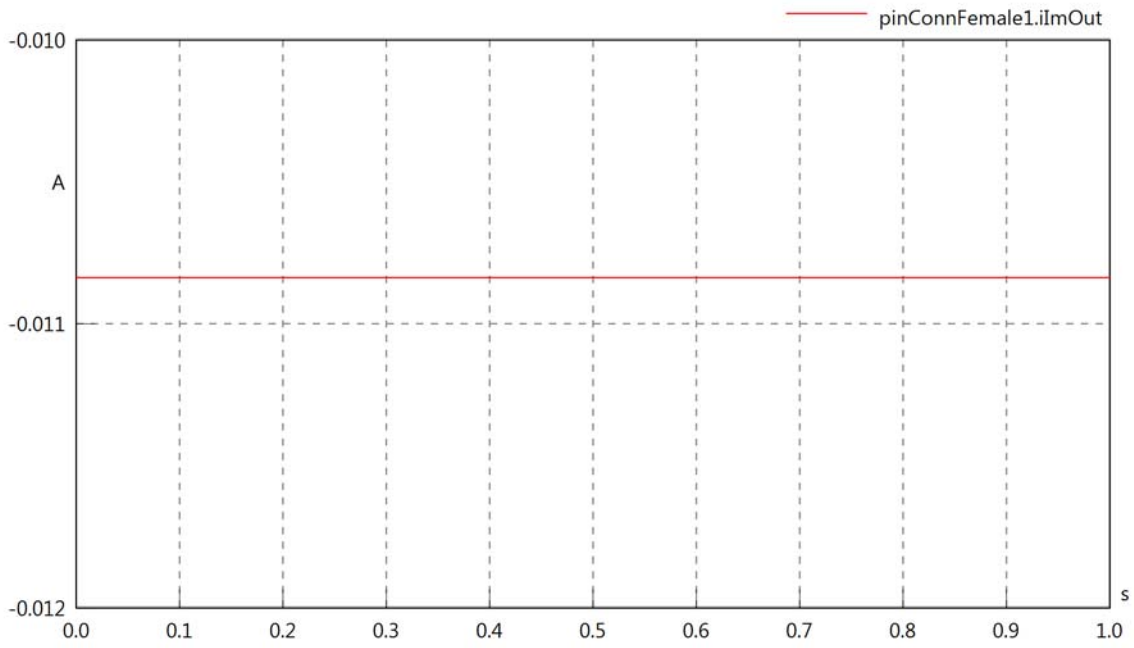

pinConnFemale1.phiVIn

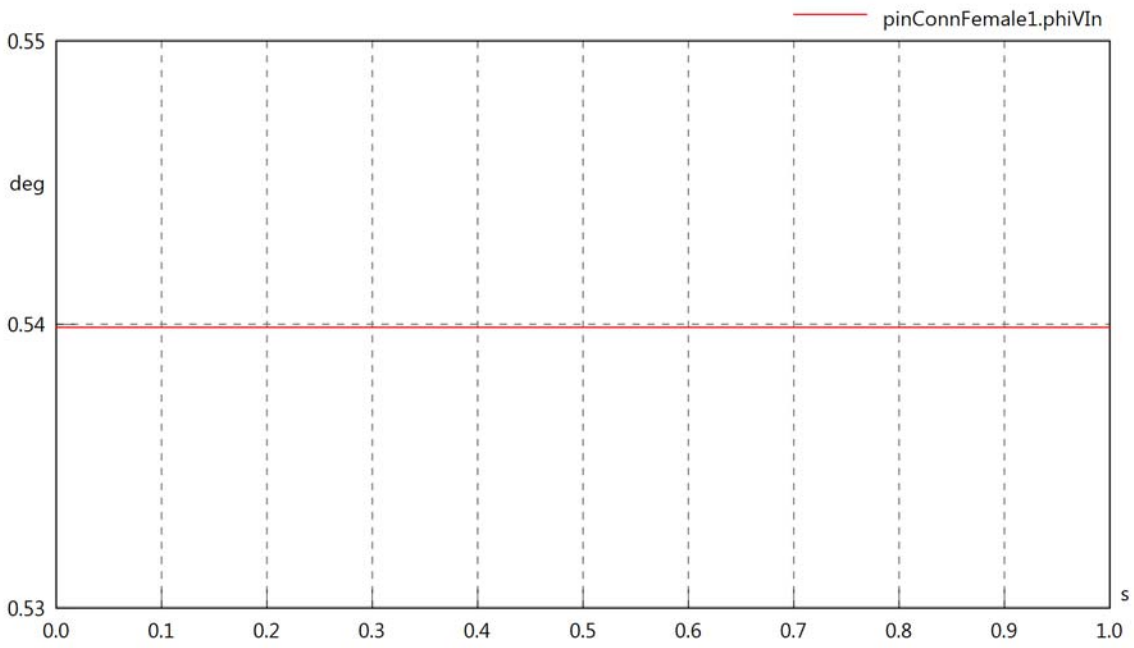

pinConnFemale1.phiIIn

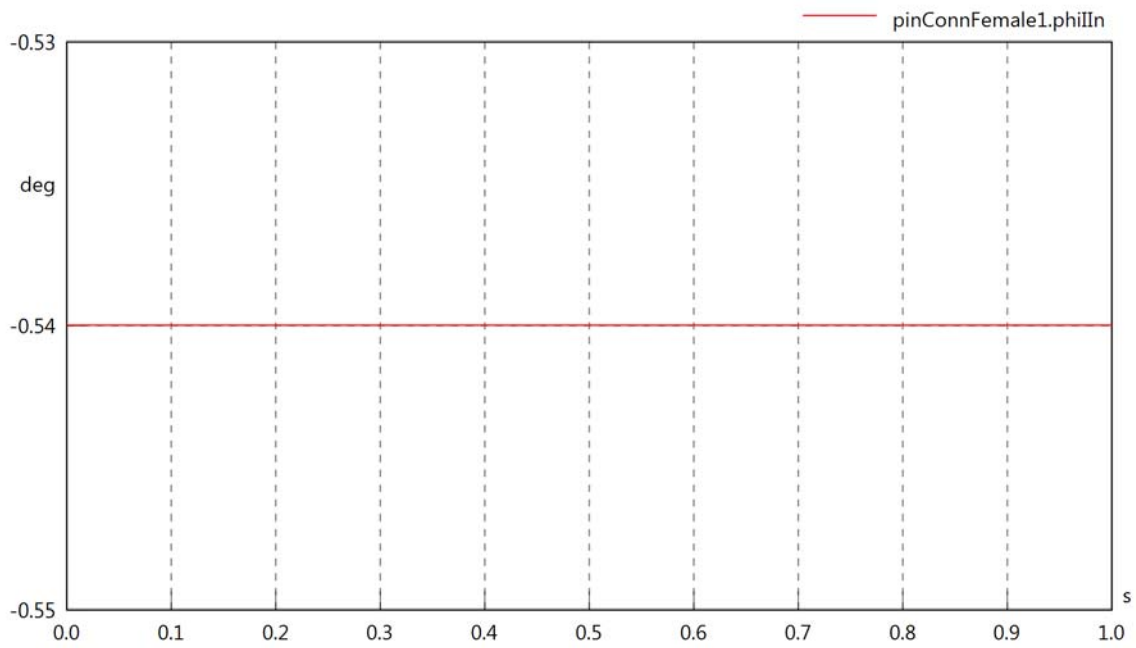

pinConnFemale1.phiIVIn

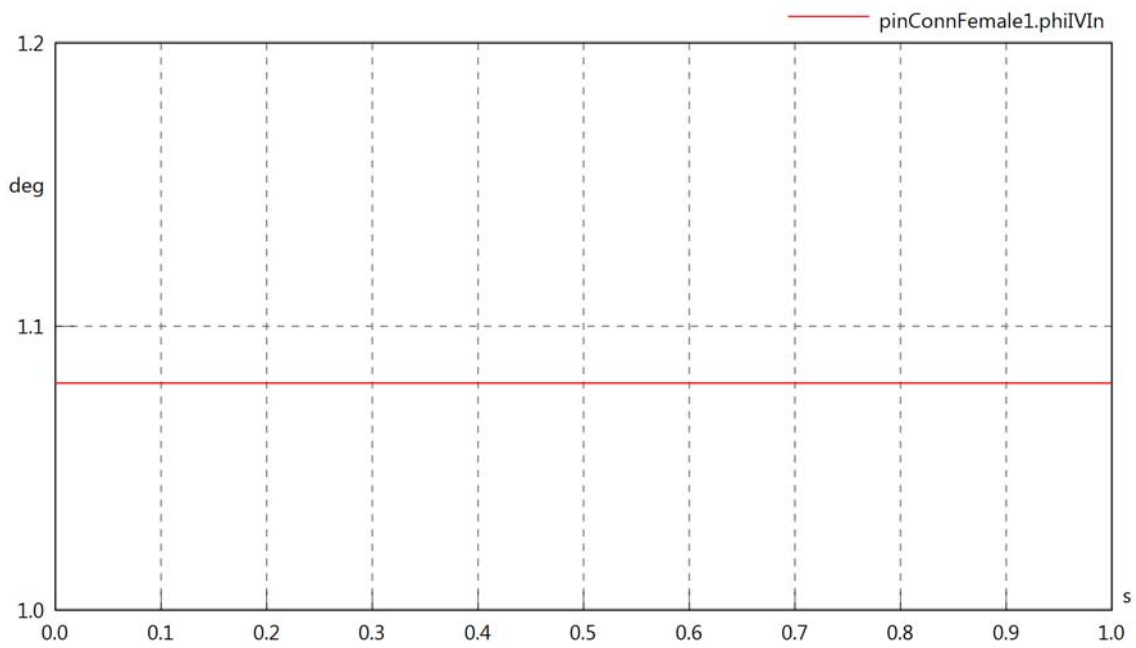

pinConnFemale1.phiVOut

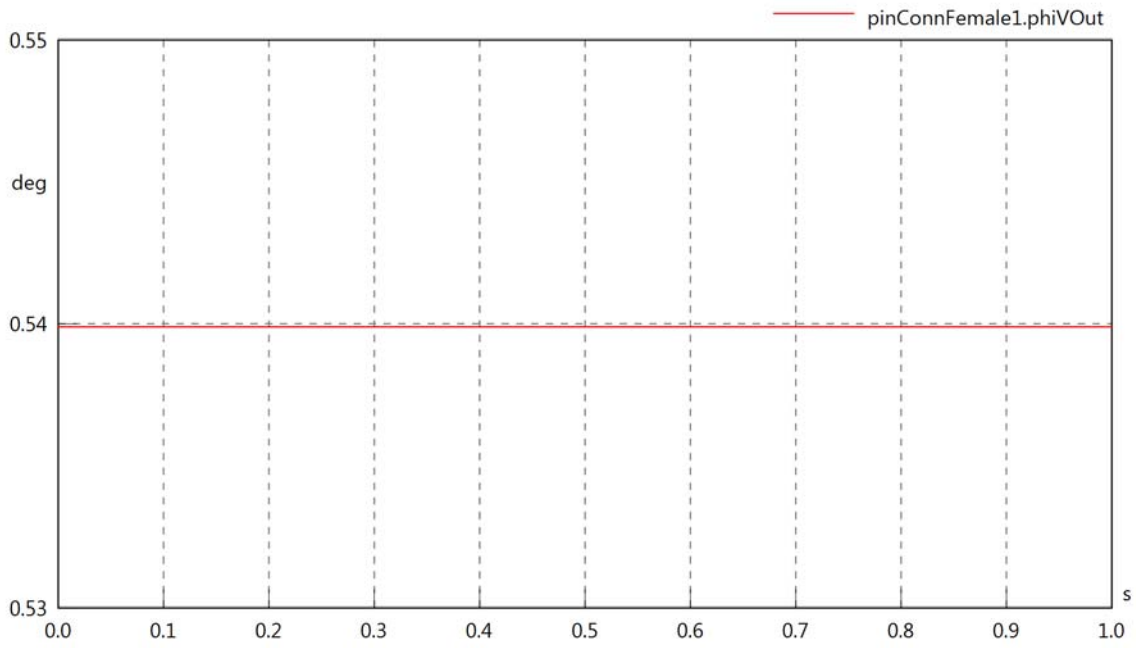

pinConnFemale1.phiIOut

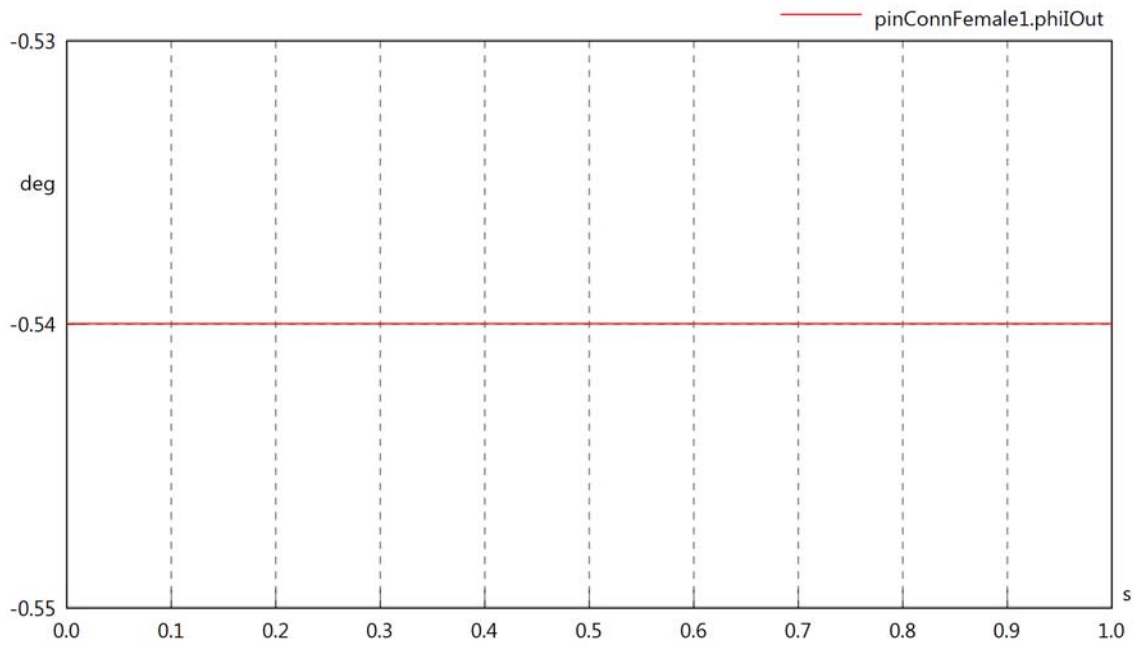

pinConnFemale1.phiIVOut

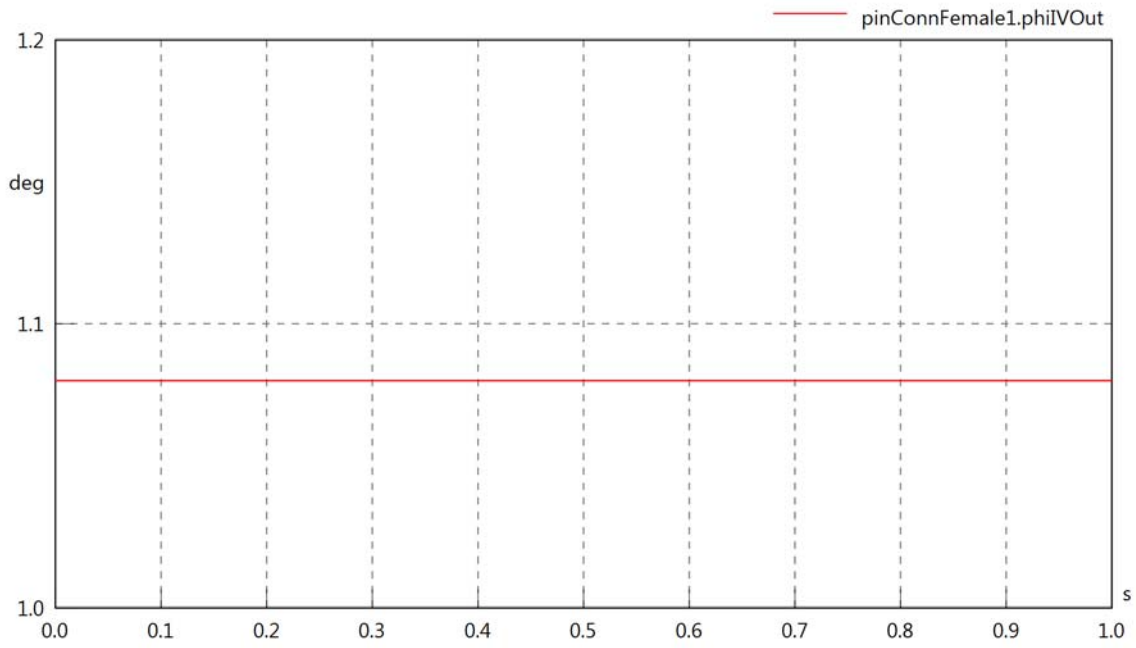

pinConnFemale1.PReIn

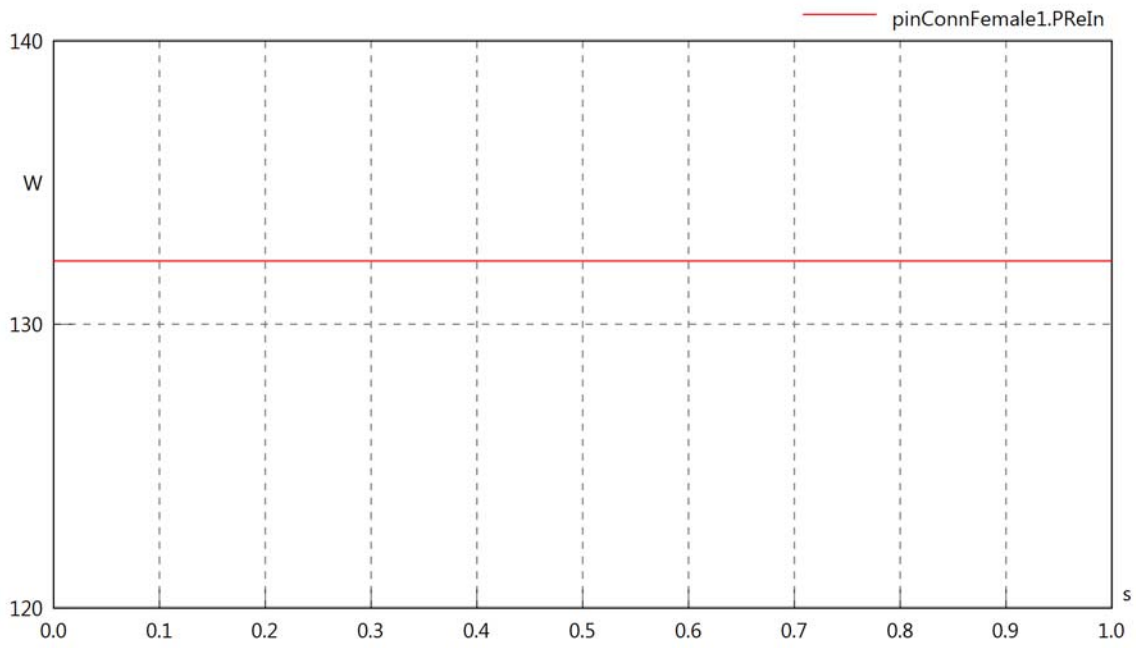

pinConnFemale1.PImIn

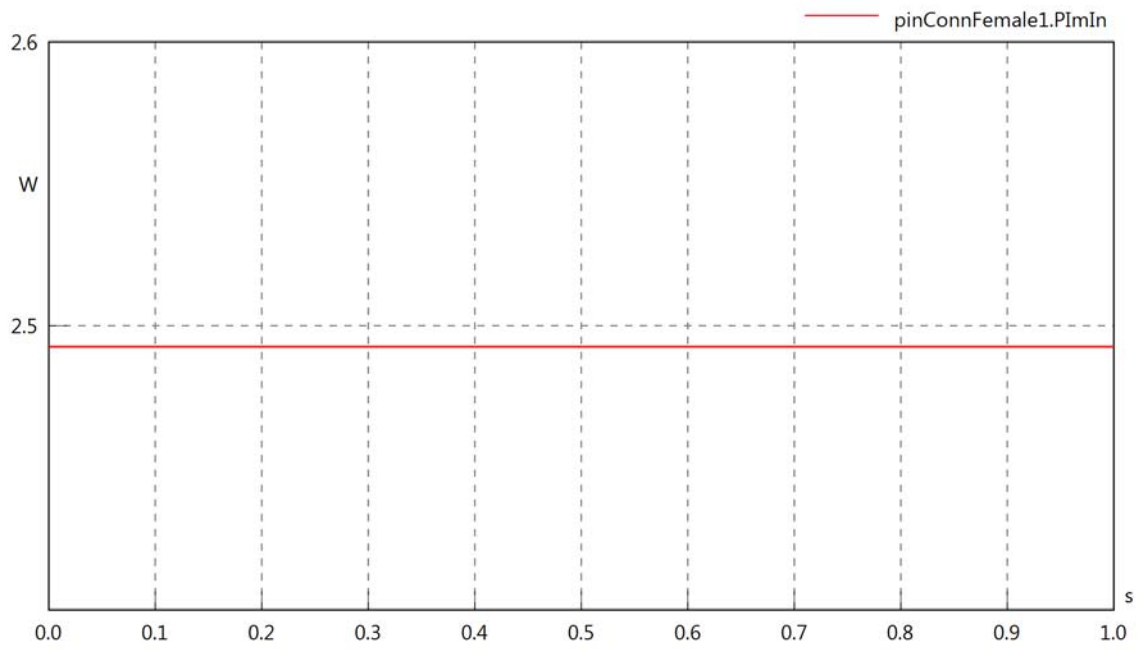

pinConnFemale1.SIn

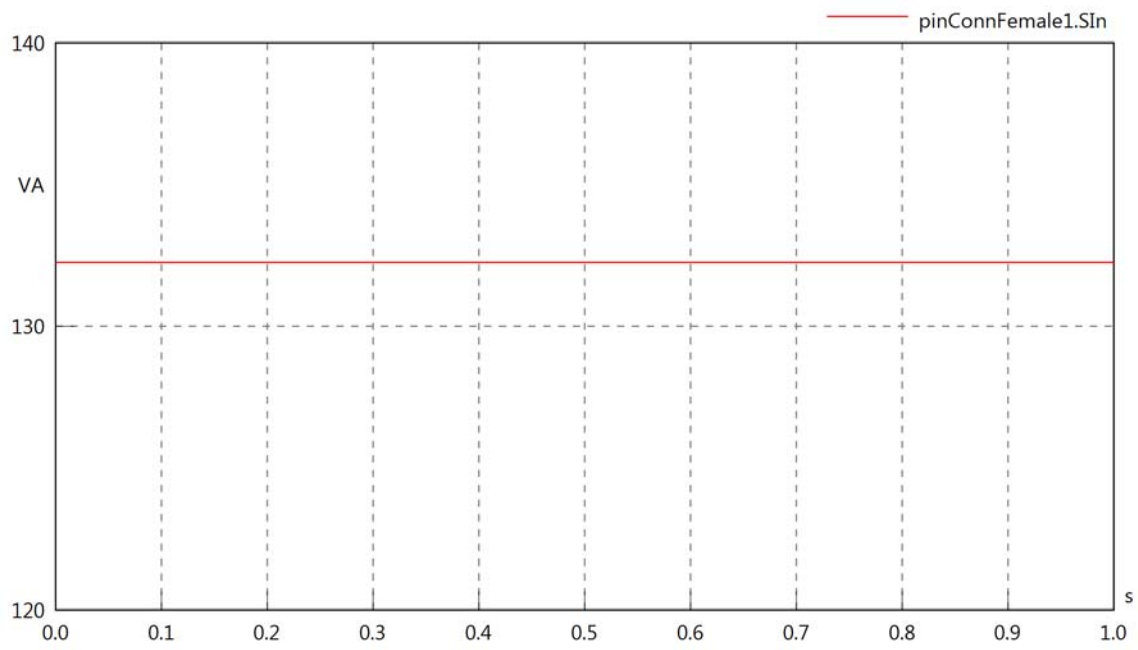

pinConnFemale1.PReOut

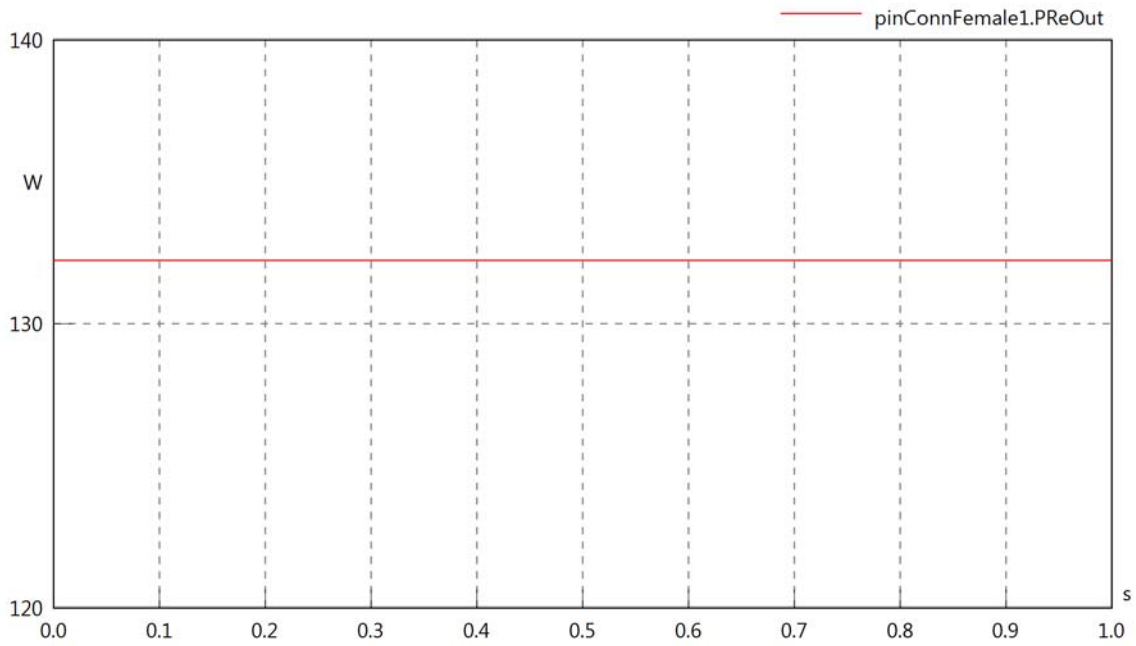

pinConnFemale1.PImOut

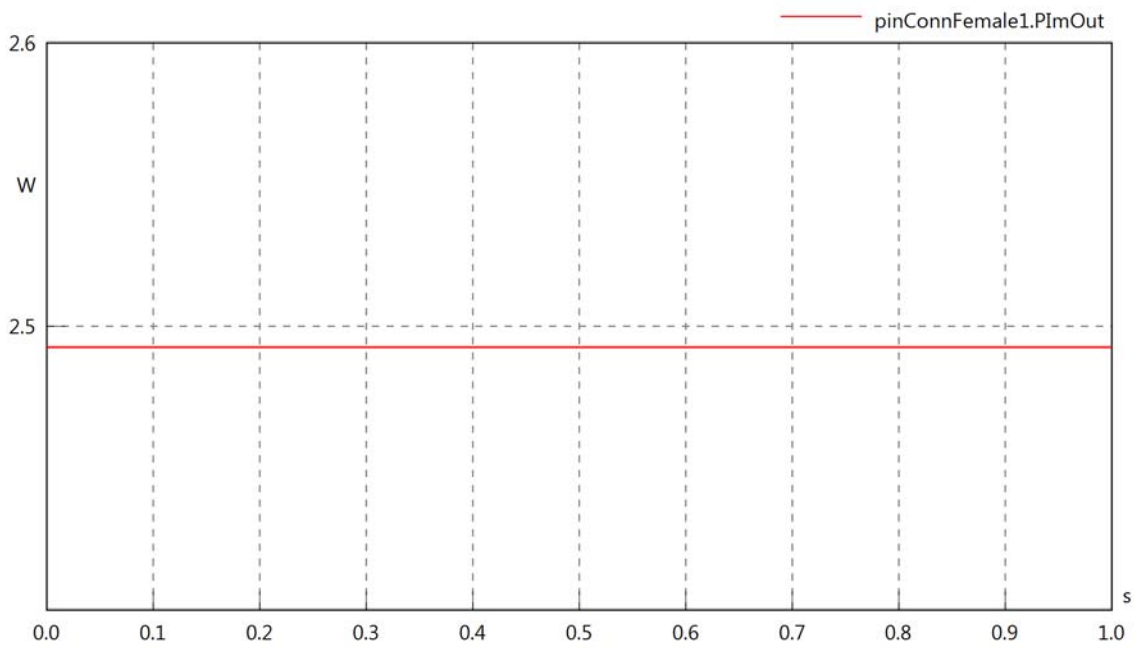

pinConnFemale1.SOut

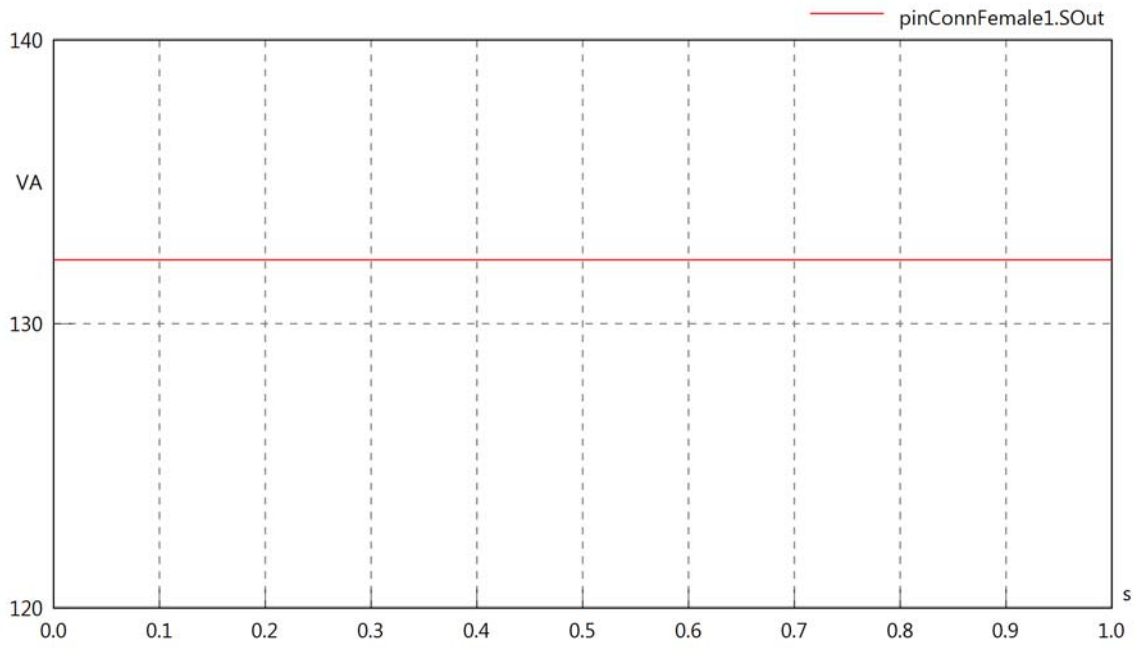
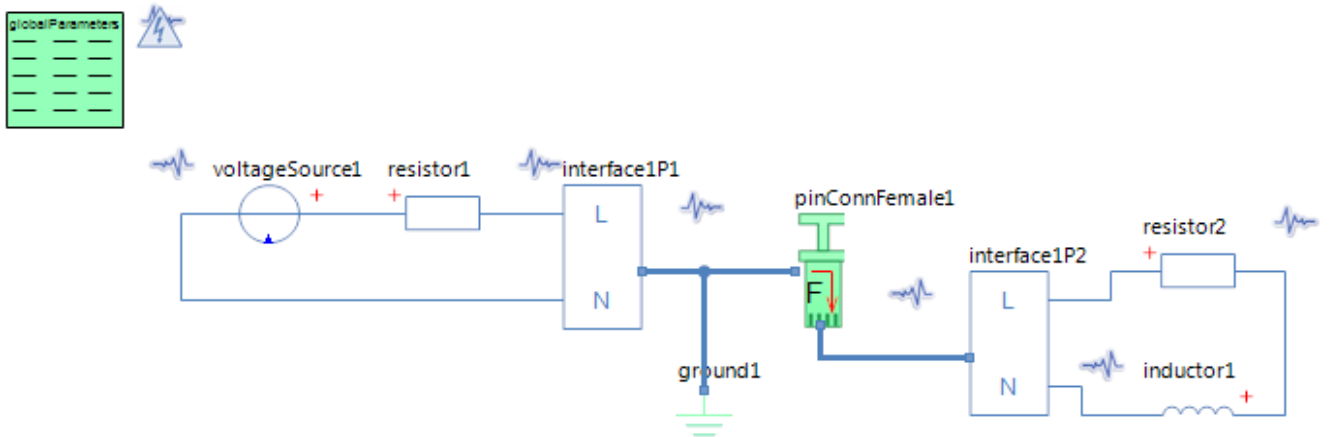

Diagram View



GlobalParameters globalParameters
Parameters

Comment	Name	Current Value	Unit
Type of Calculation	eCalculationKind	Signal Calculation	
Description of Frequency	eFrequencyKind	Linear	
Minimum Frequency	fMin	4000	[Hz]
Maximum Frequency	fMax	4000	[Hz]

Voltage Source voltageSource1
Parameters

Comment	Name	Current Value	Unit
Voltage RMS	VrmsSrc	230	[V]
Phase	phi	0	[deg]

Resistor resistor1
Parameters

Comment	Name	Current Value	Unit
Resistance	R	100	[Ohm]

Resistor resistor2
Parameters

Comment	Name	Current Value	Unit
Resistance	R	100	[Ohm]

Inductor inductor1
Parameters

Comment	Name	Current Value	Unit
Inductance	L	5	[mH]

Pin Connector Female pinConnFemale1
Parameters

Comment	Name	Current Value	Unit
Poor or failing L1 connection	bL1	false	

pinConnFemale1.VrmsIn

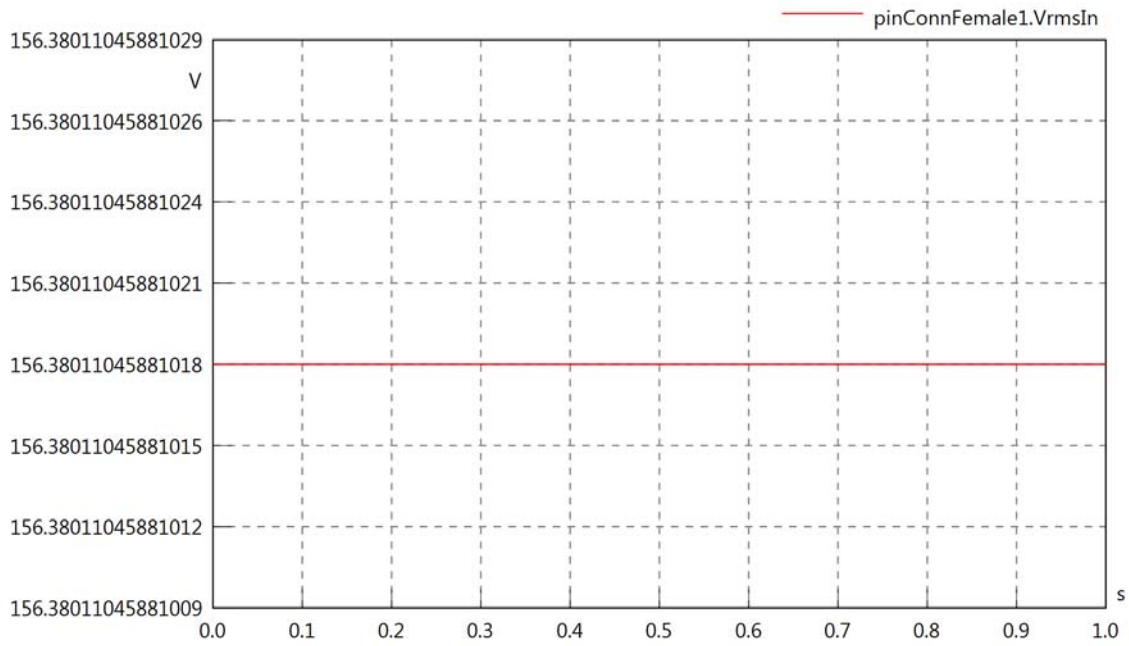

pinConnFemale1.vReIn

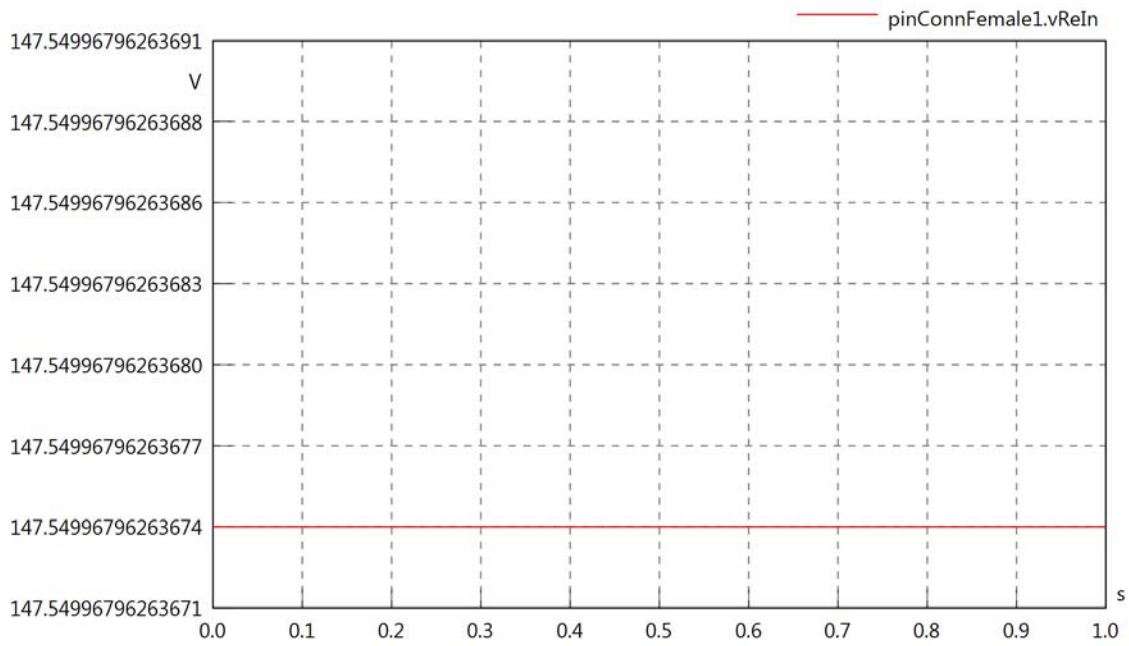

pinConnFemale1.vImIn

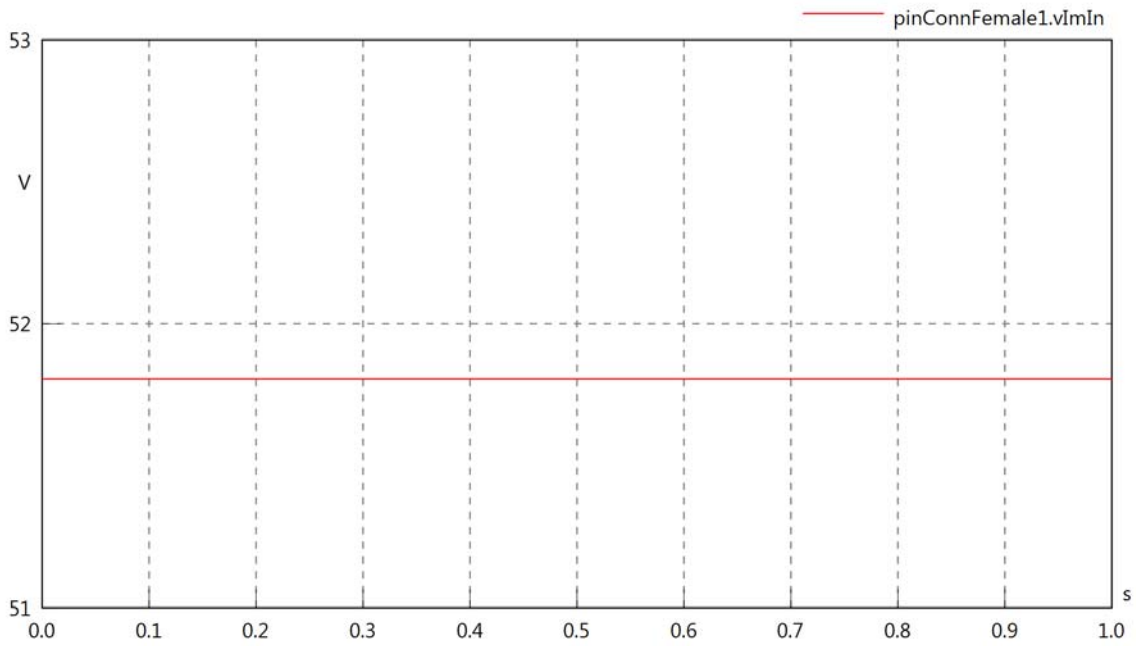

pinConnFemale1.VrmsOut

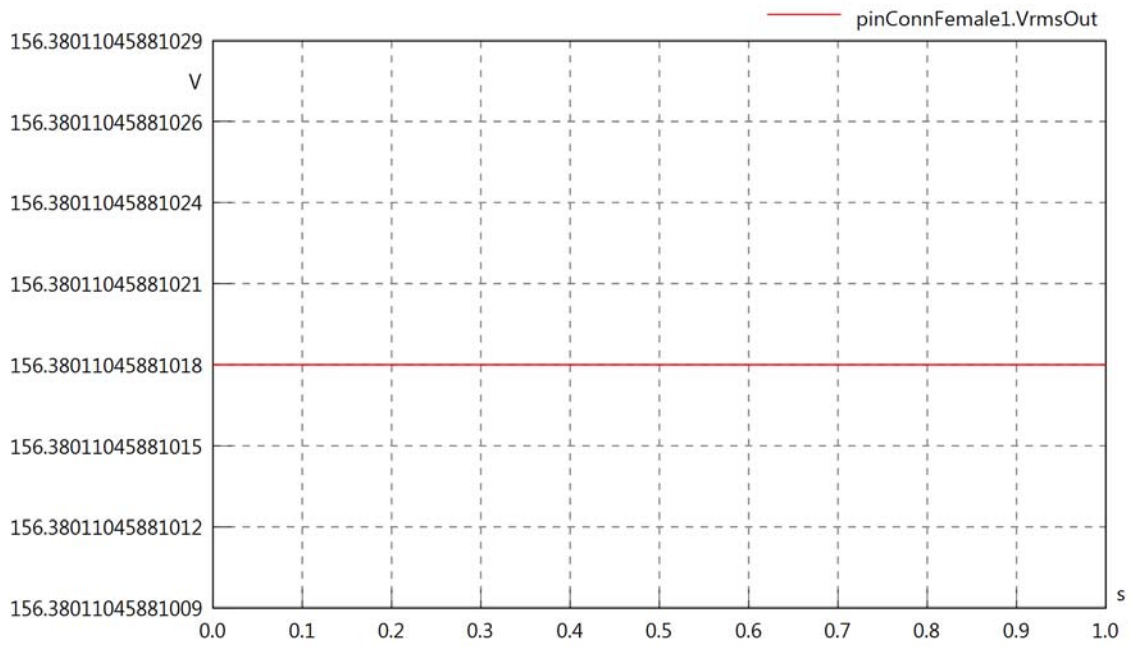

pinConnFemale1.vReOut

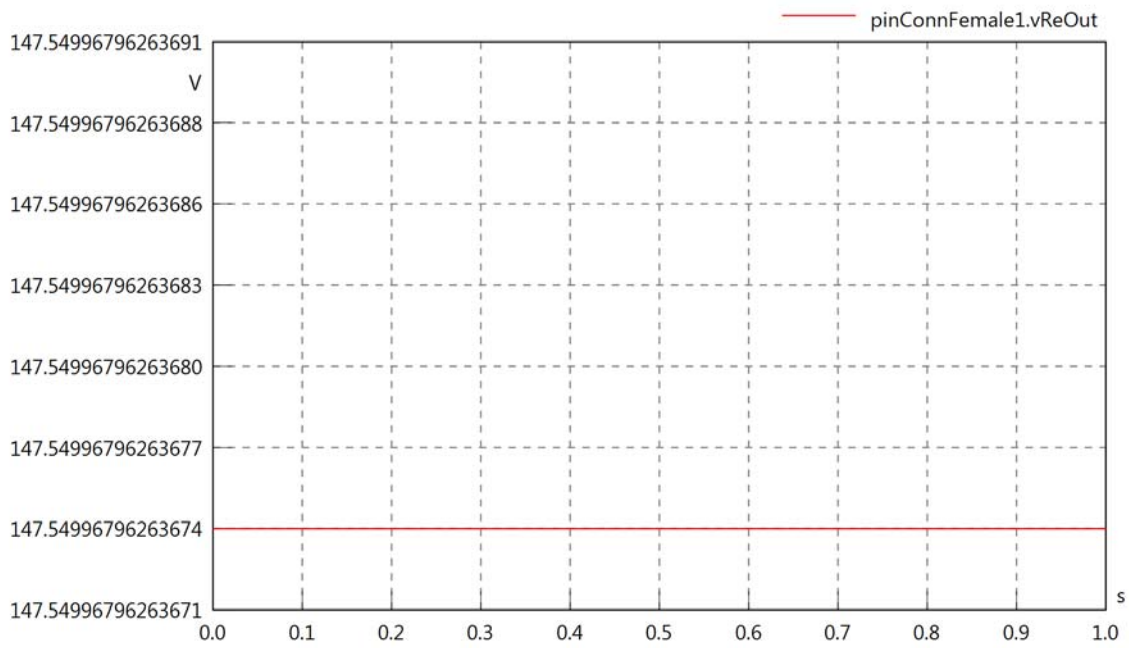

pinConnFemale1.vImOut

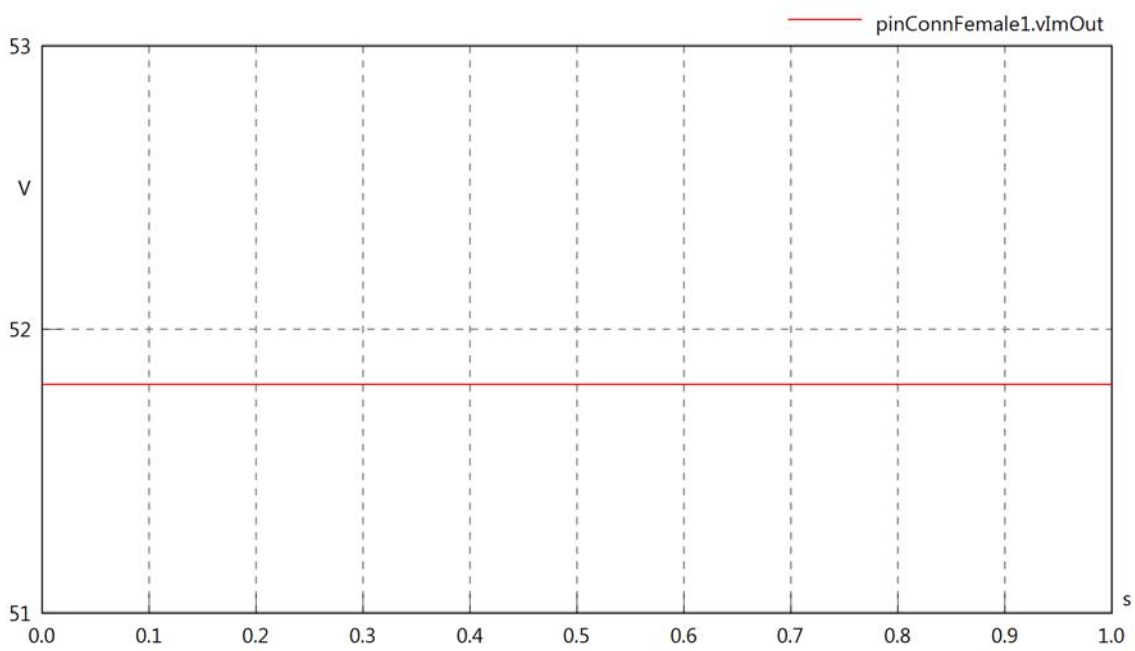

pinConnFemale1.Vrms

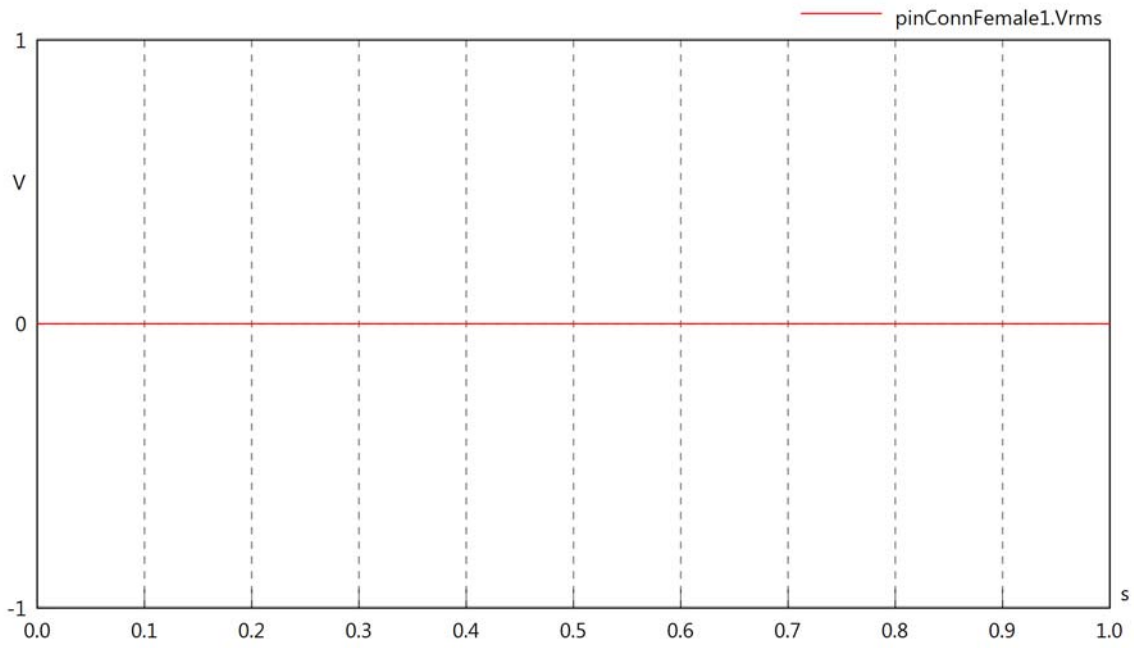

pinConnFemale1.vRe

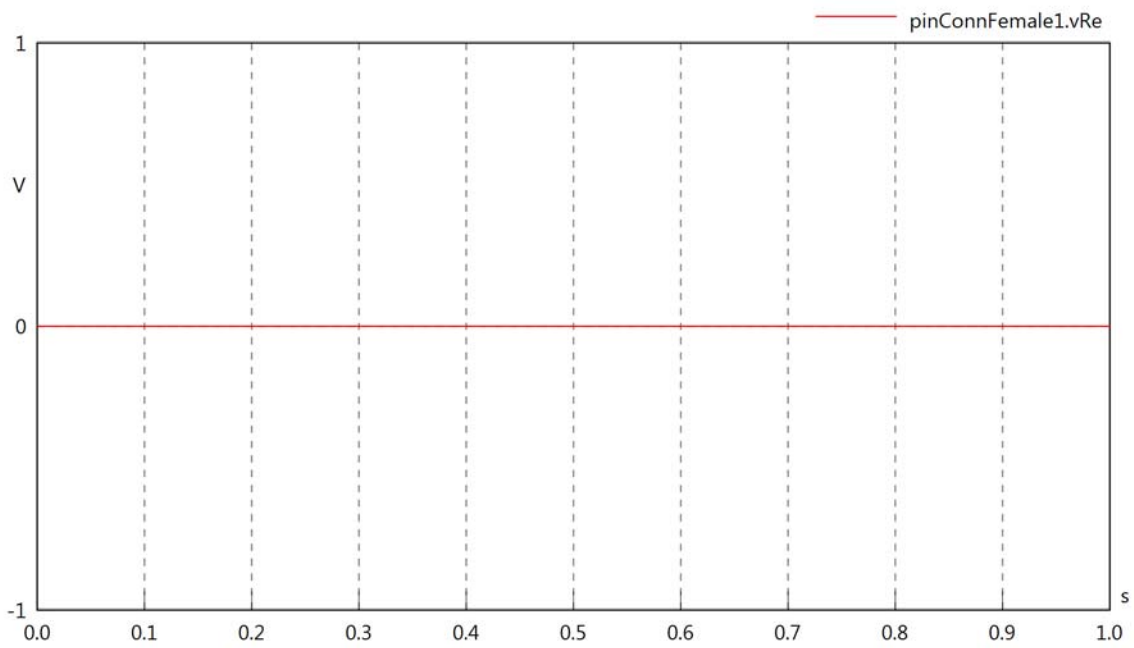

pinConnFemale1.vIm

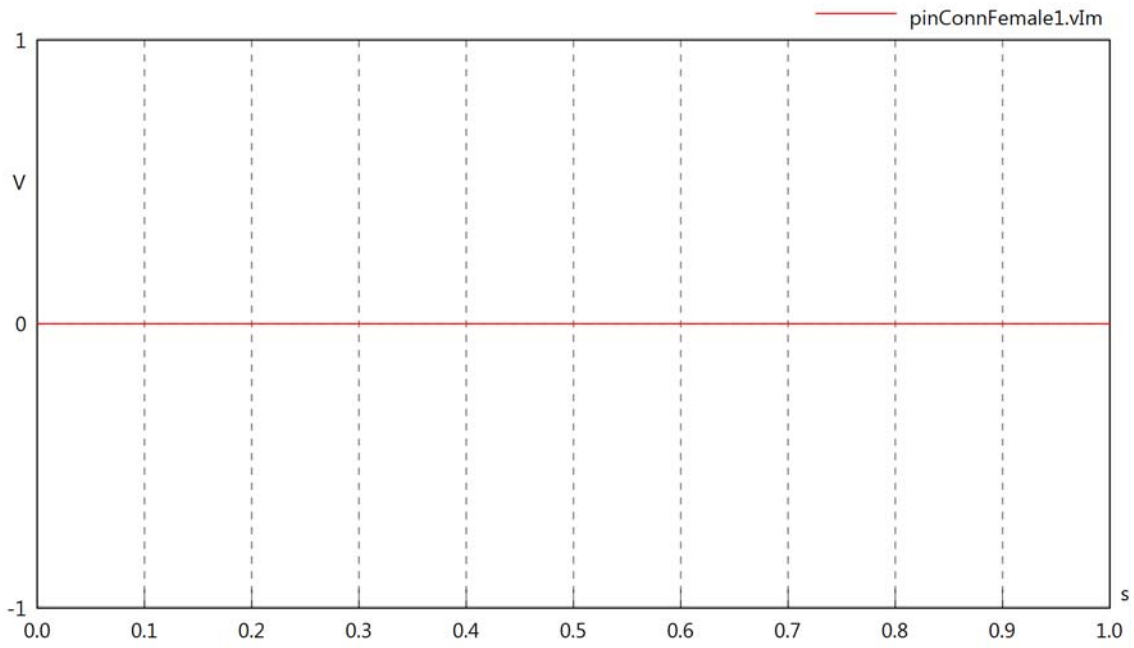

pinConnFemale1.IrmsIn

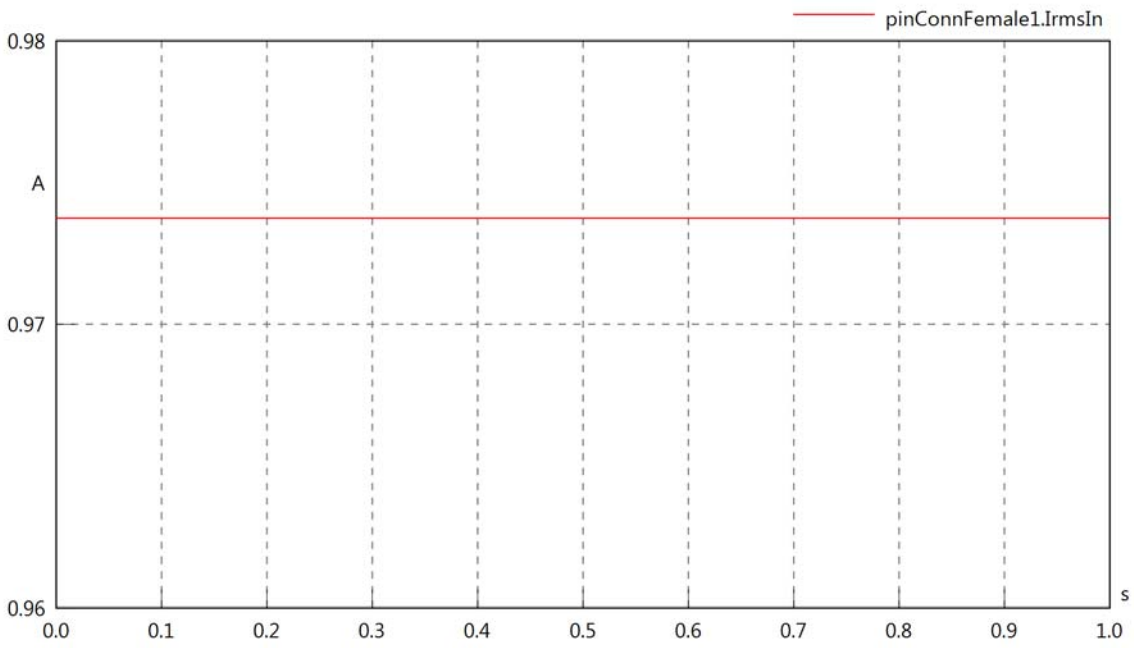

pinConnFemale1.iReIn

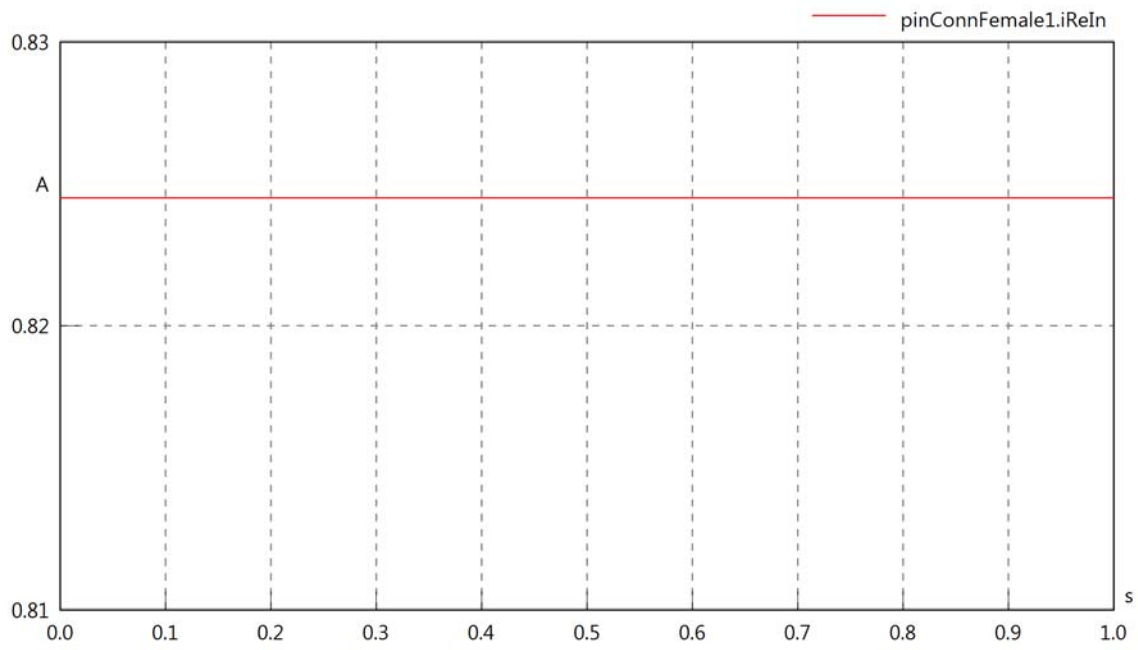

pinConnFemale1.iImIn

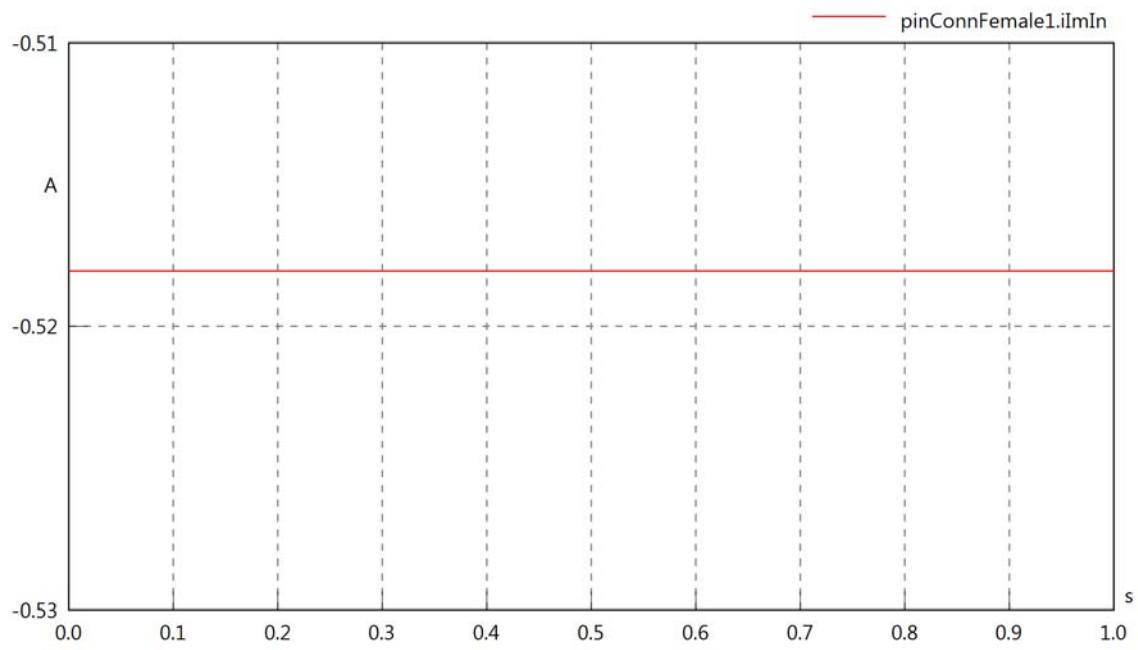

pinConnFemale1.IrmsOut

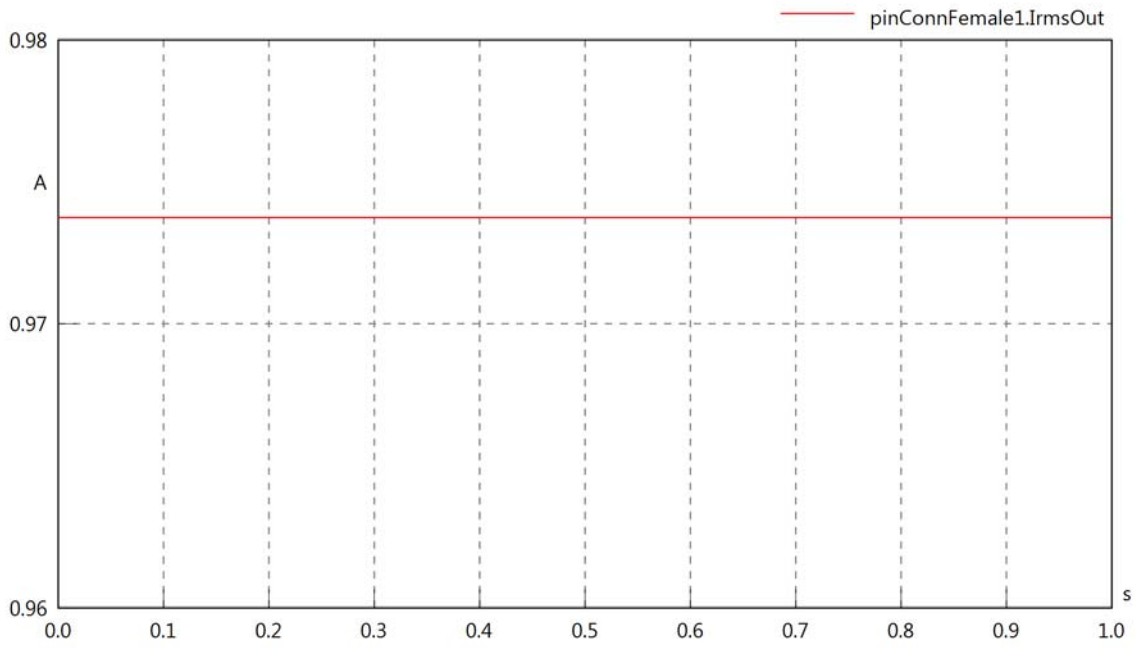

pinConnFemale1.iReOut

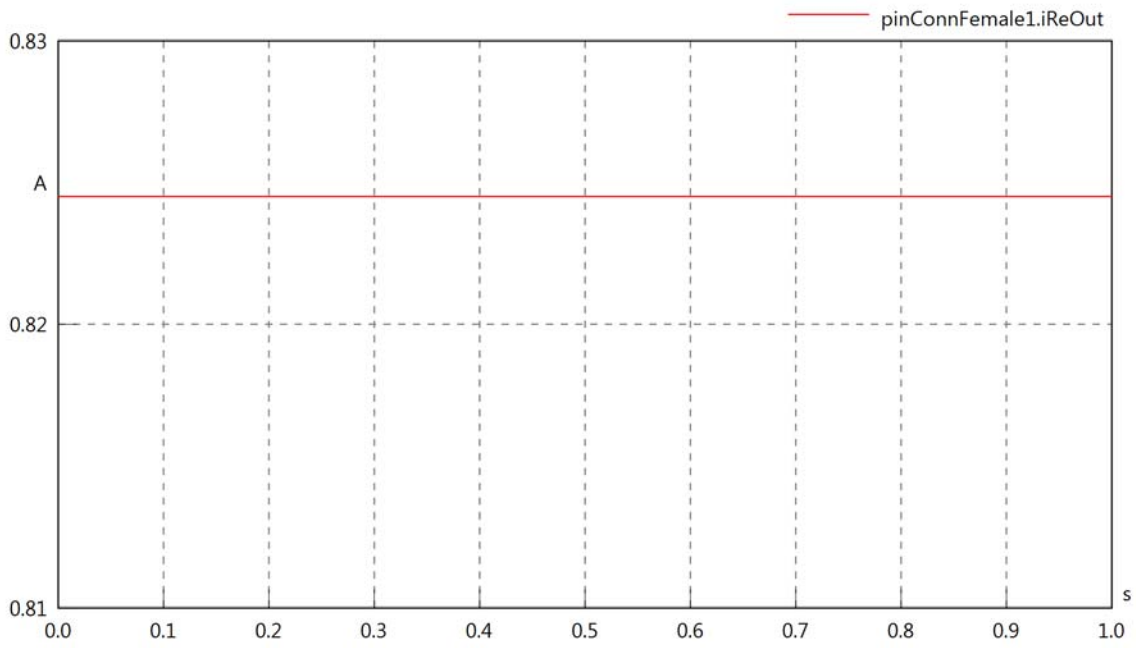

pinConnFemale1.iImOut

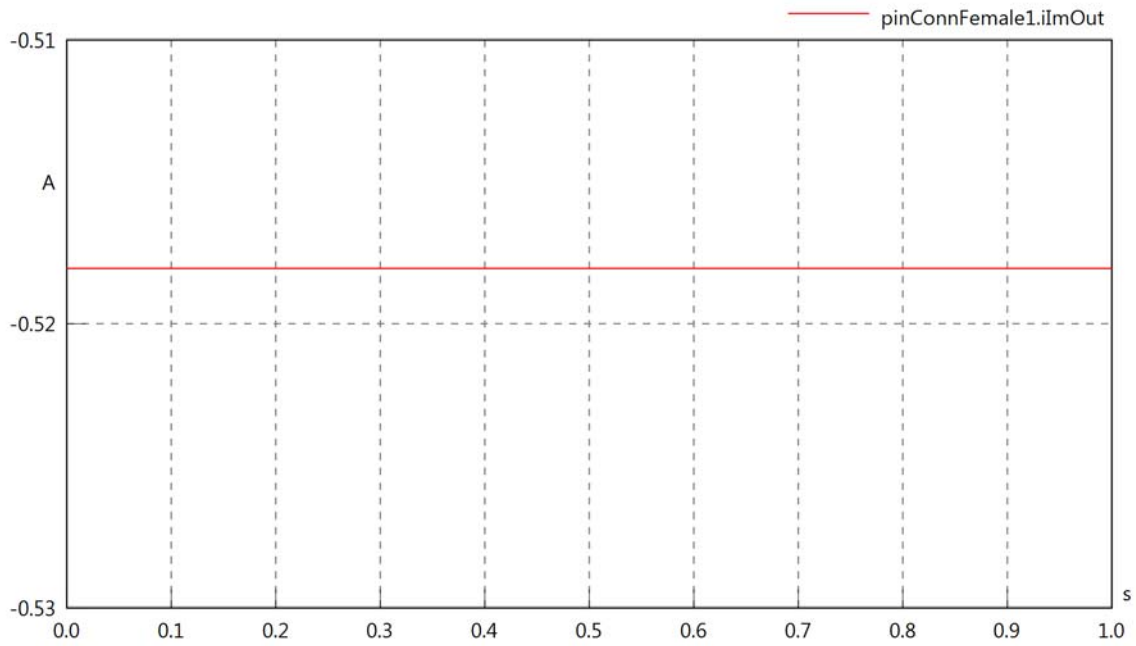

pinConnFemale1.phiVIn

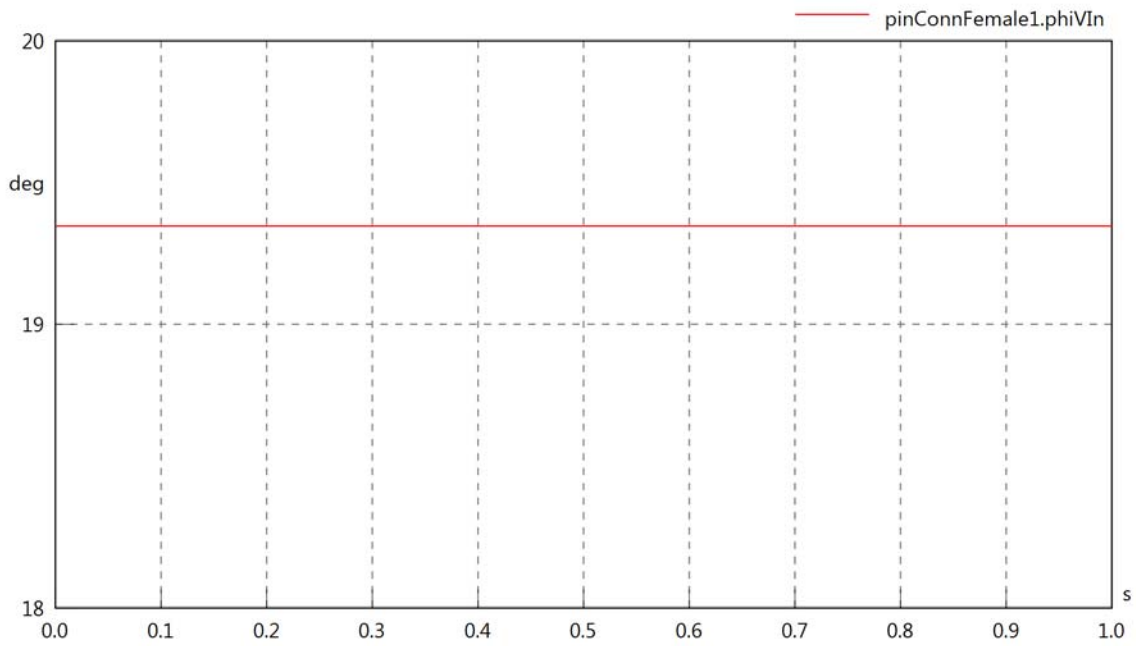

pinConnFemale1.phiIIn

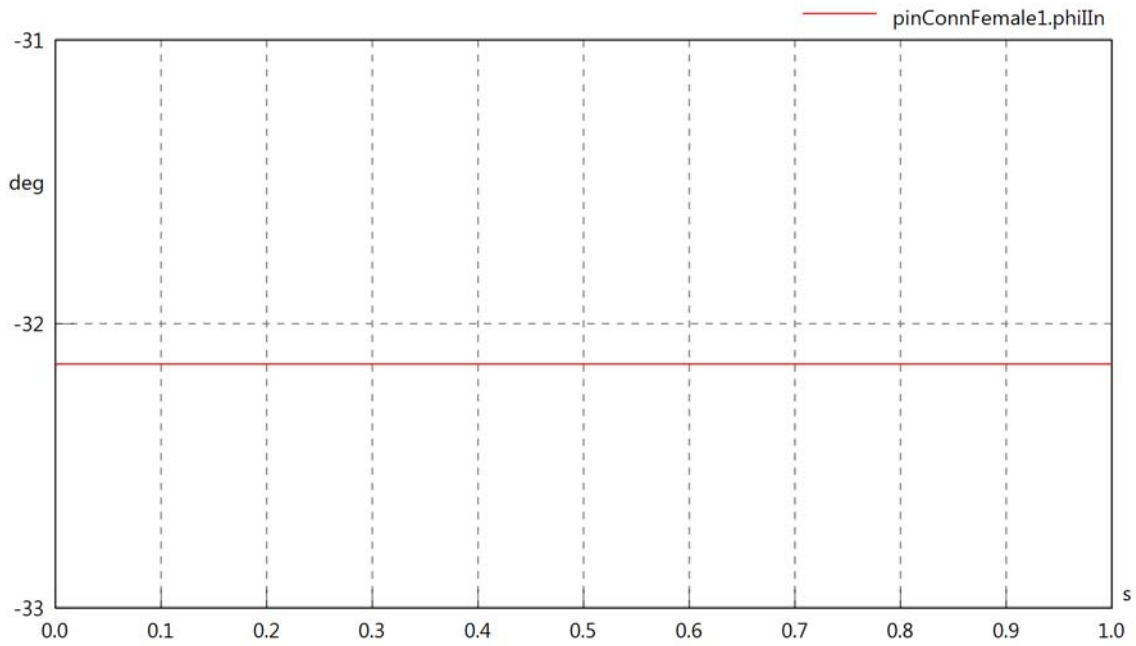

pinConnFemale1.phiIVIn

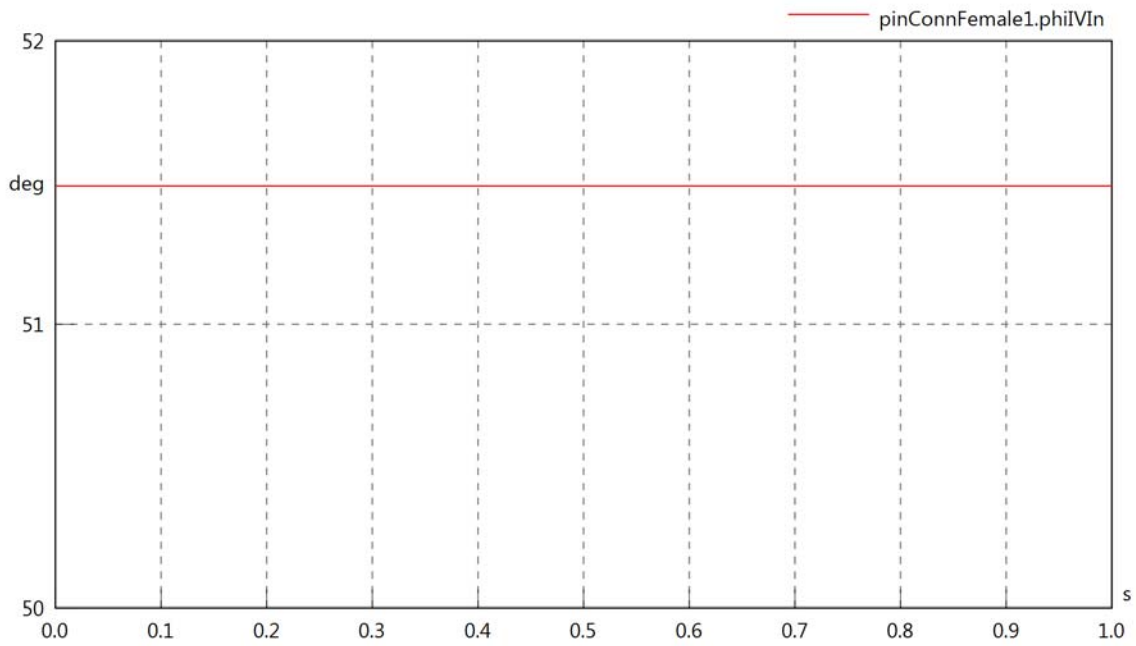

pinConnFemale1.phiVOut

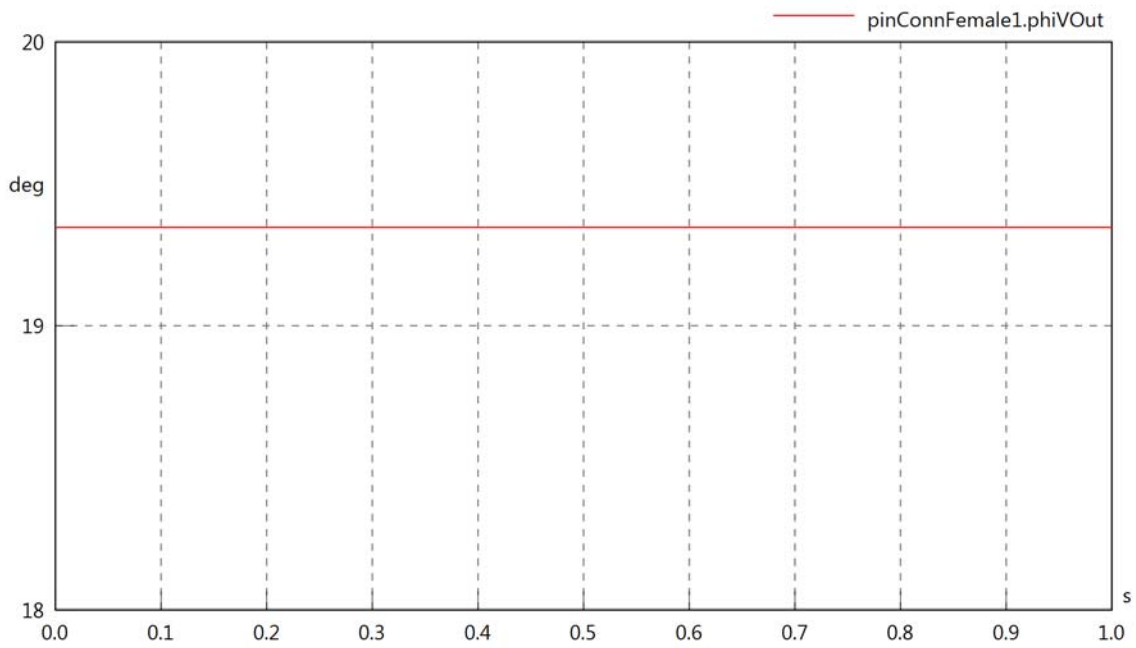

pinConnFemale1.phiIOut

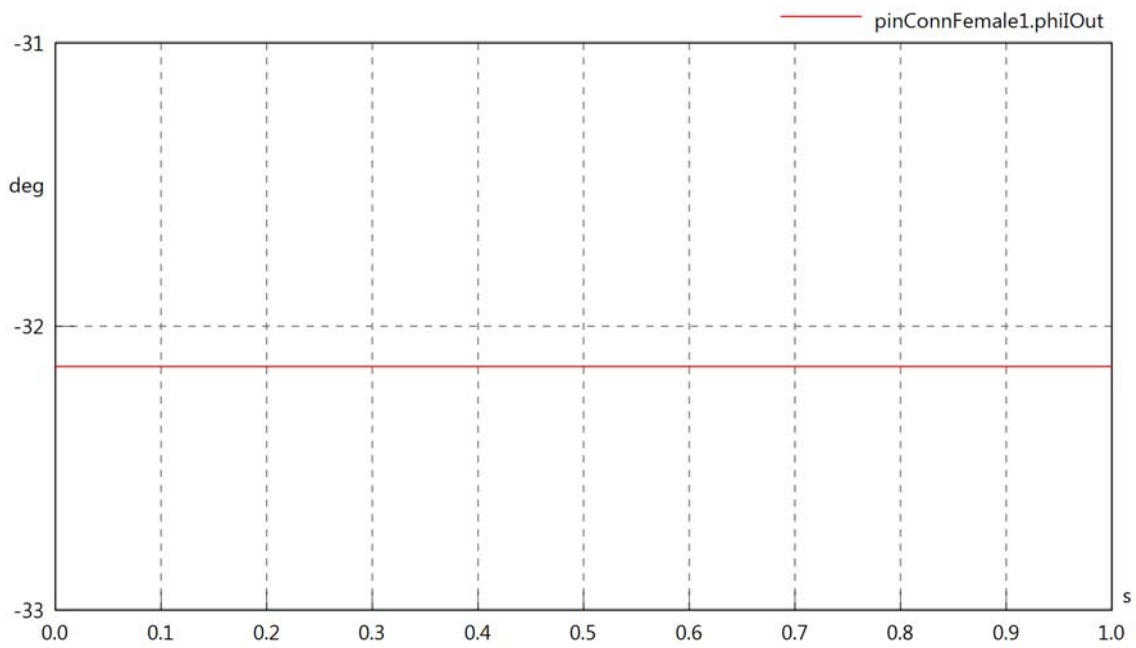

pinConnFemale1.phiIVOut

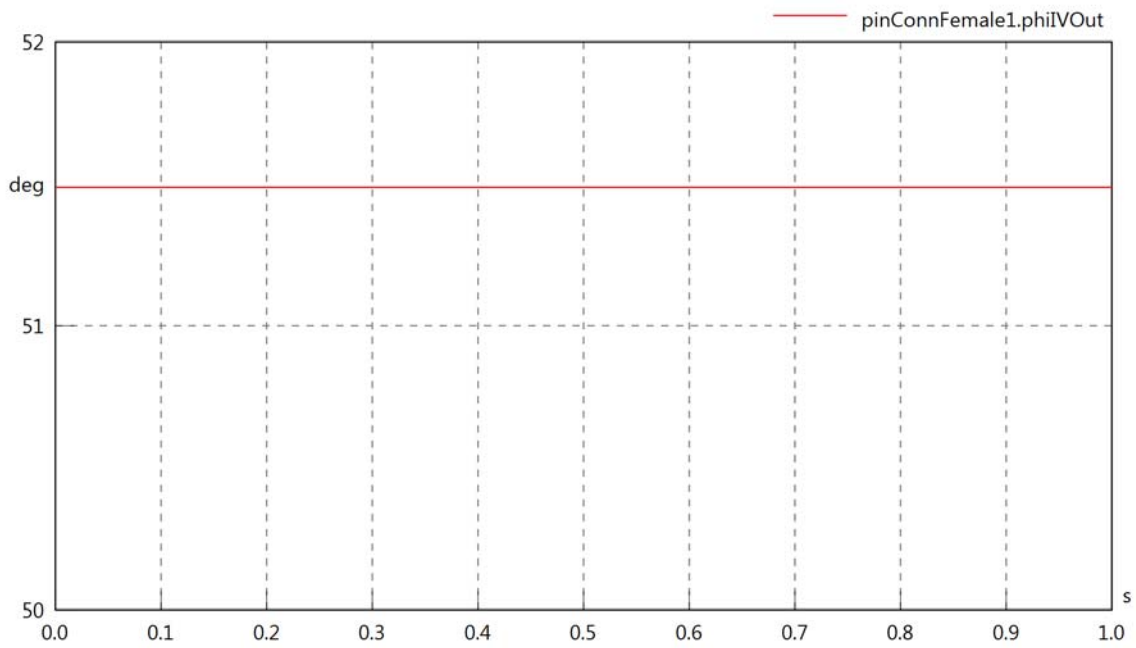

pinConnFemale1.PReIn

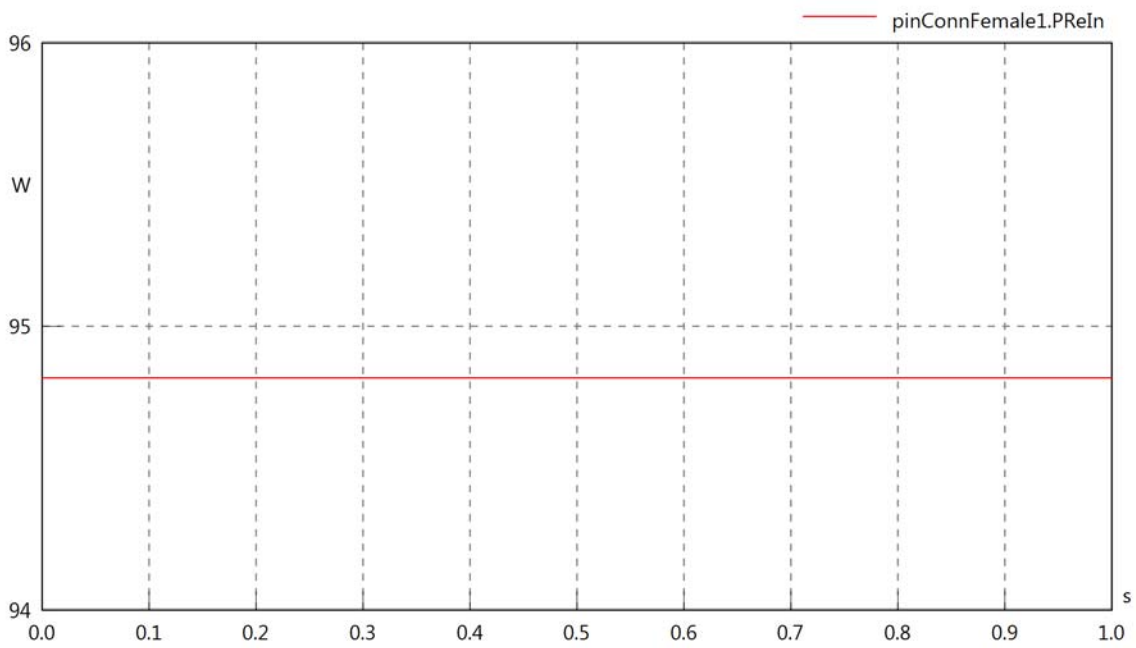

pinConnFemale1.PImIn

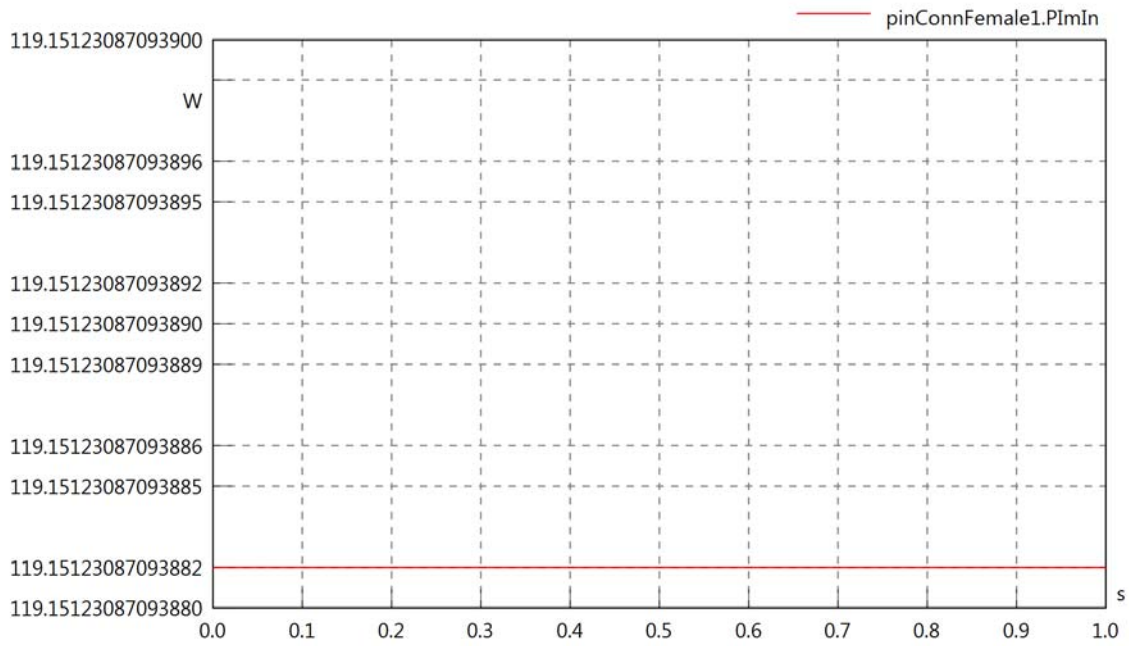

pinConnFemale1.SIn

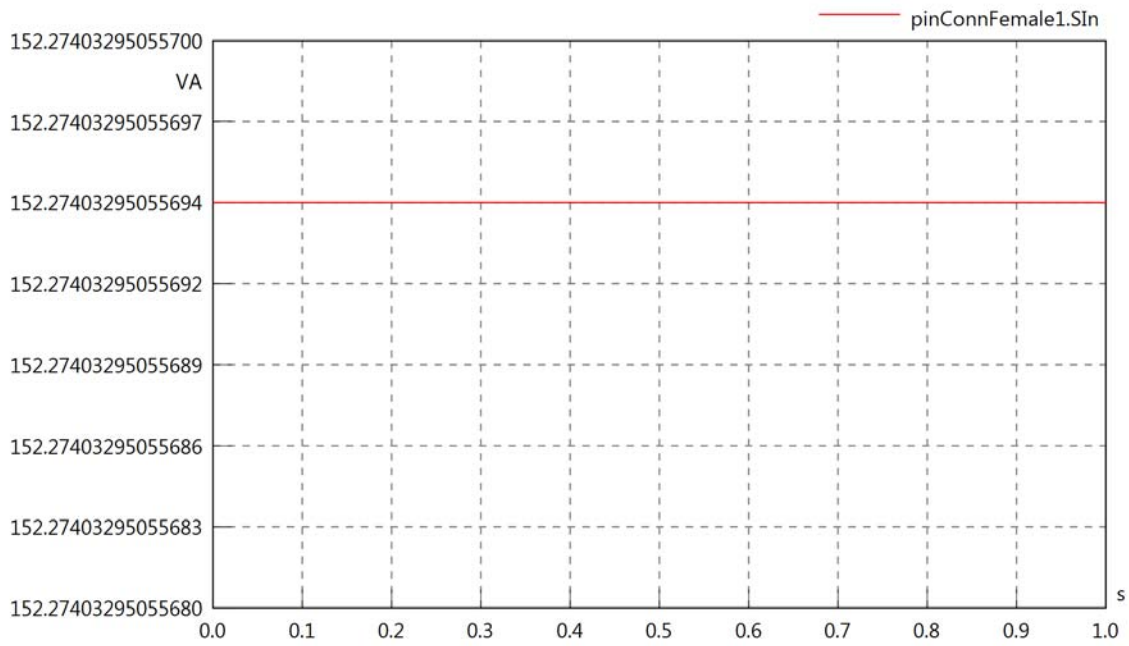

pinConnFemale1.PReOut

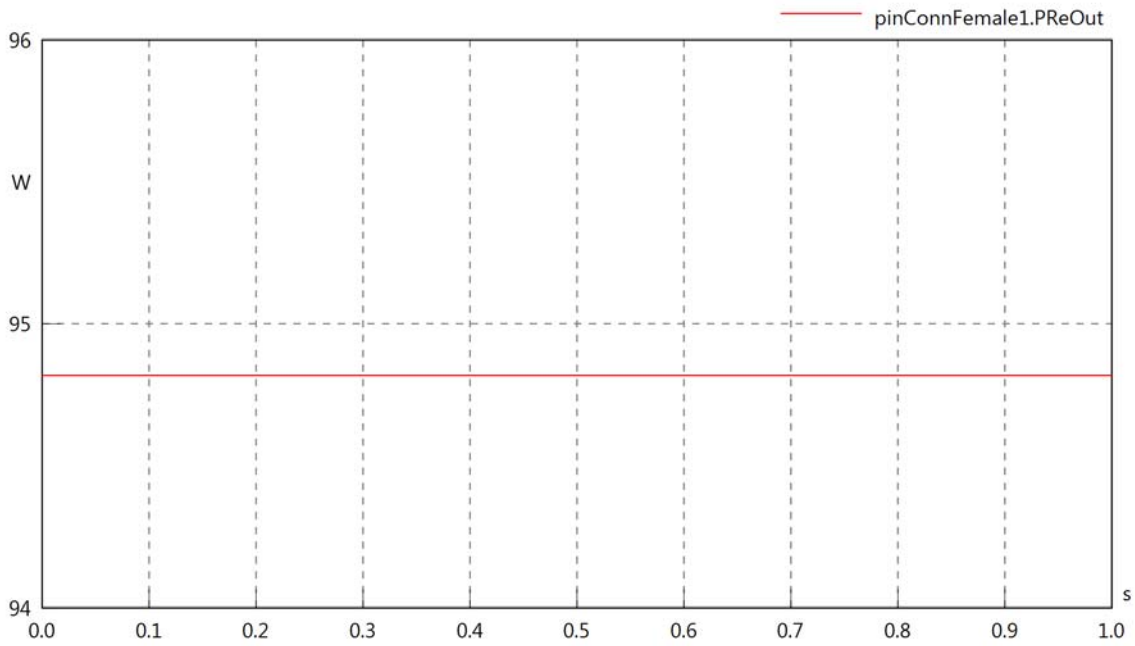

pinConnFemale1.PImOut

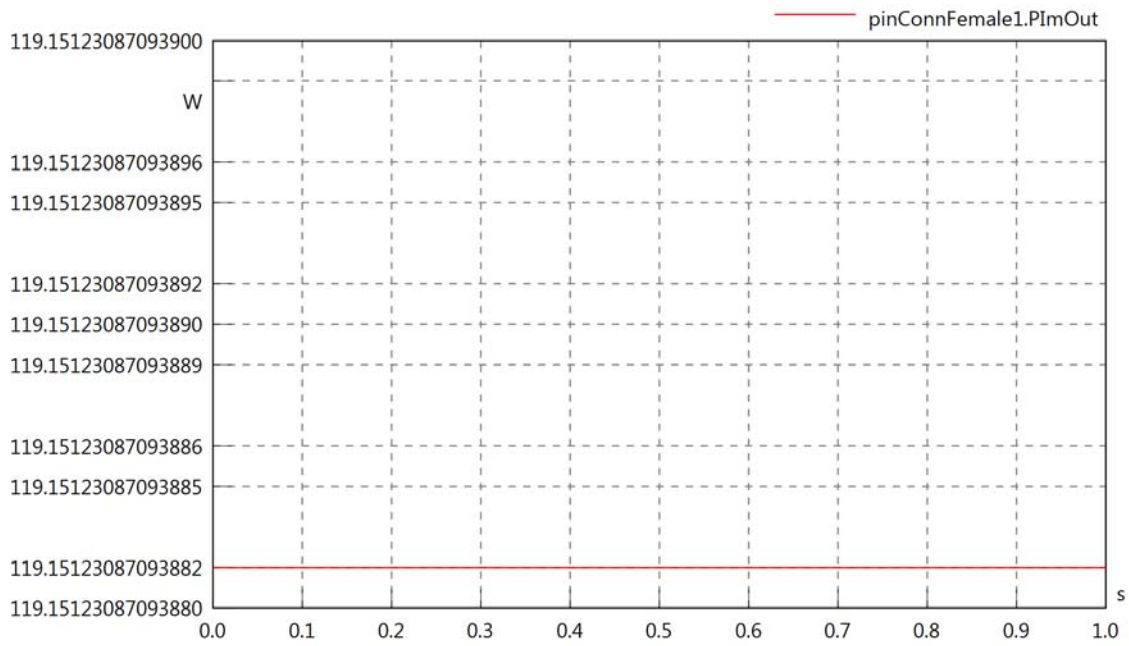

pinConnFemale1.SOut

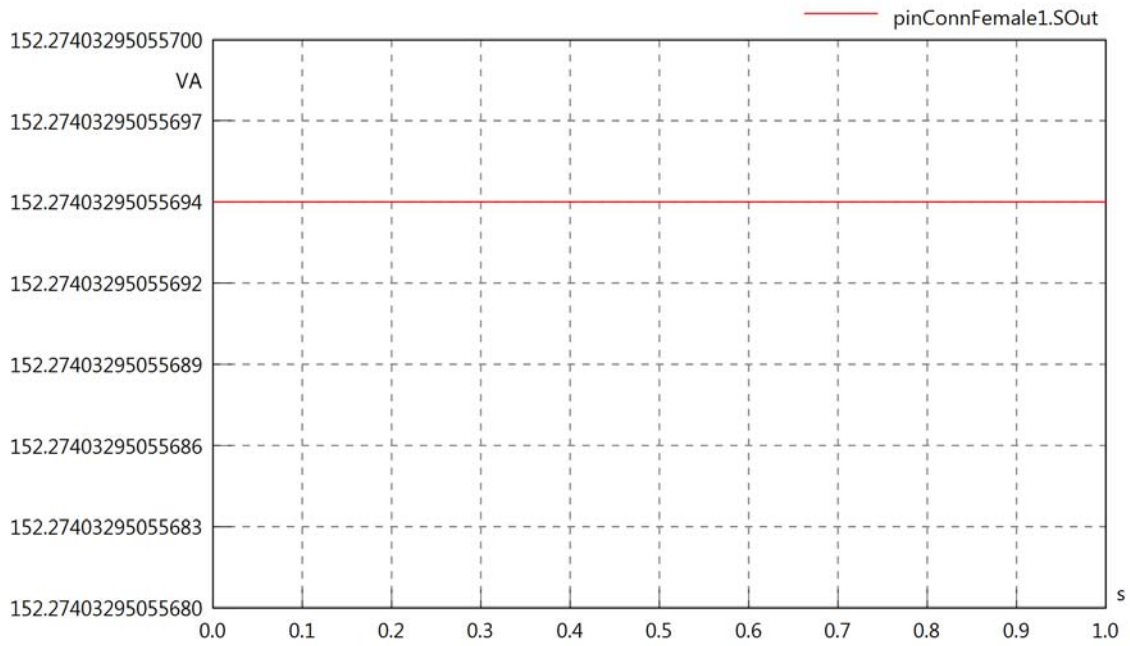
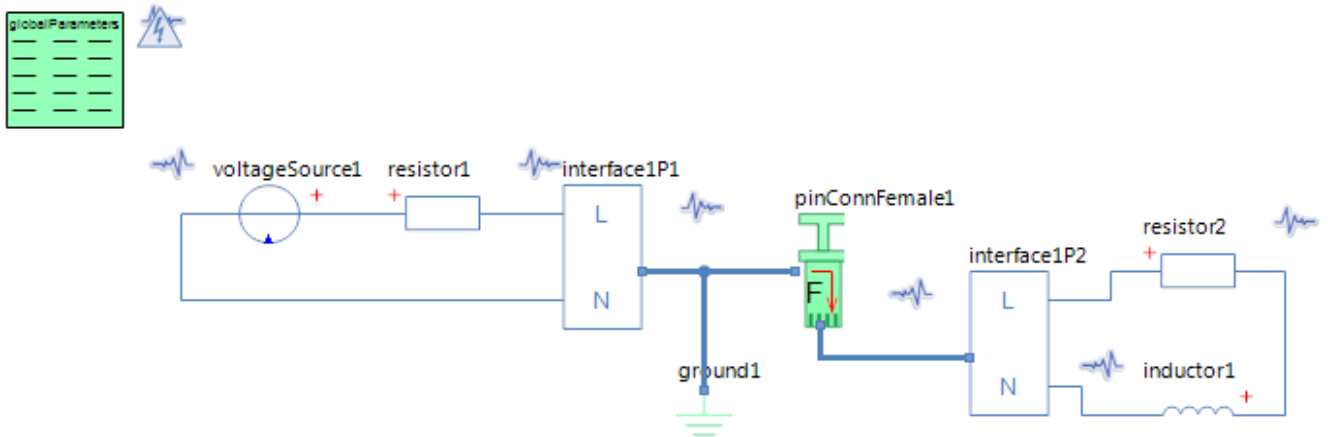

Diagram View



GlobalParameters globalParameters
Parameters

Comment	Name	Current Value	Unit
Type of Calculation	eCalculationKind	Signal Calculation	
Description of Frequency	eFrequencyKind	Linear	
Minimum Frequency	fMin	20000	[Hz]
Maximum Frequency	fMax	20000	[Hz]

Voltage Source voltageSource1
Parameters

Comment	Name	Current Value	Unit
Voltage RMS	VrmsSrc	230	[V]
Phase	phi	0	[deg]

Resistor resistor1
Parameters

Comment	Name	Current Value	Unit
Resistance	R	100	[Ohm]

Resistor resistor2
Parameters

Comment	Name	Current Value	Unit
Resistance	R	100	[Ohm]

Inductor inductor1
Parameters

Comment	Name	Current Value	Unit
Inductance	L	5	[mH]

Pin Connector Female pinConnFemale1
Parameters

Comment	Name	Current Value	Unit
Poor or failing L1 connection	bL1	false	

pinConnFemale1.VrmsIn

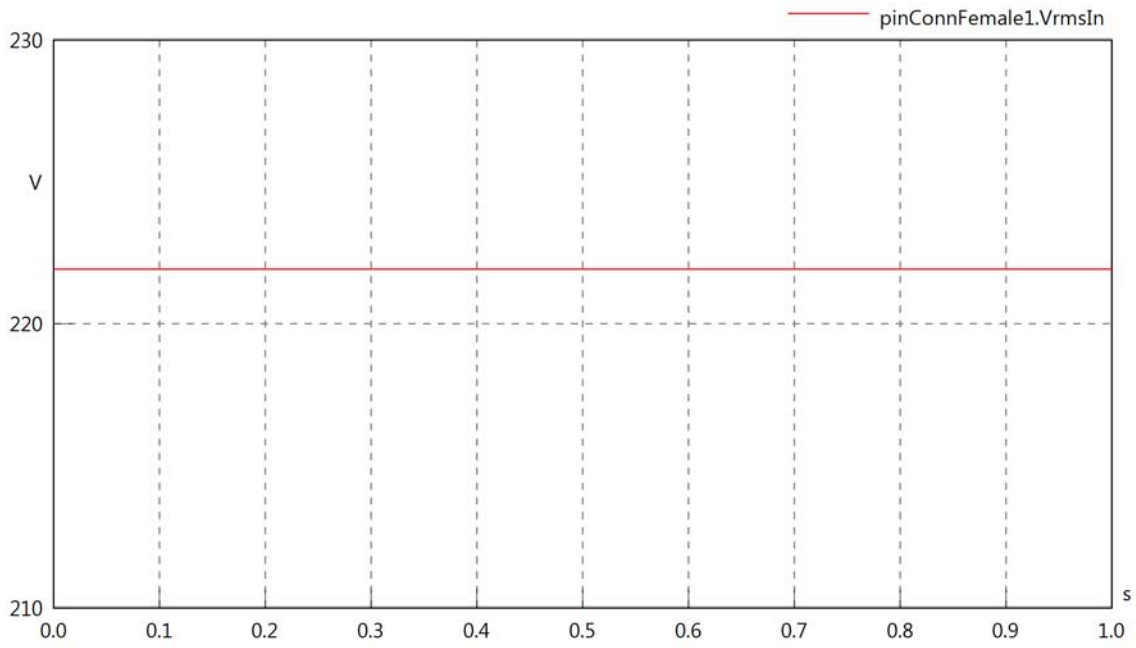

pinConnFemale1.vReIn

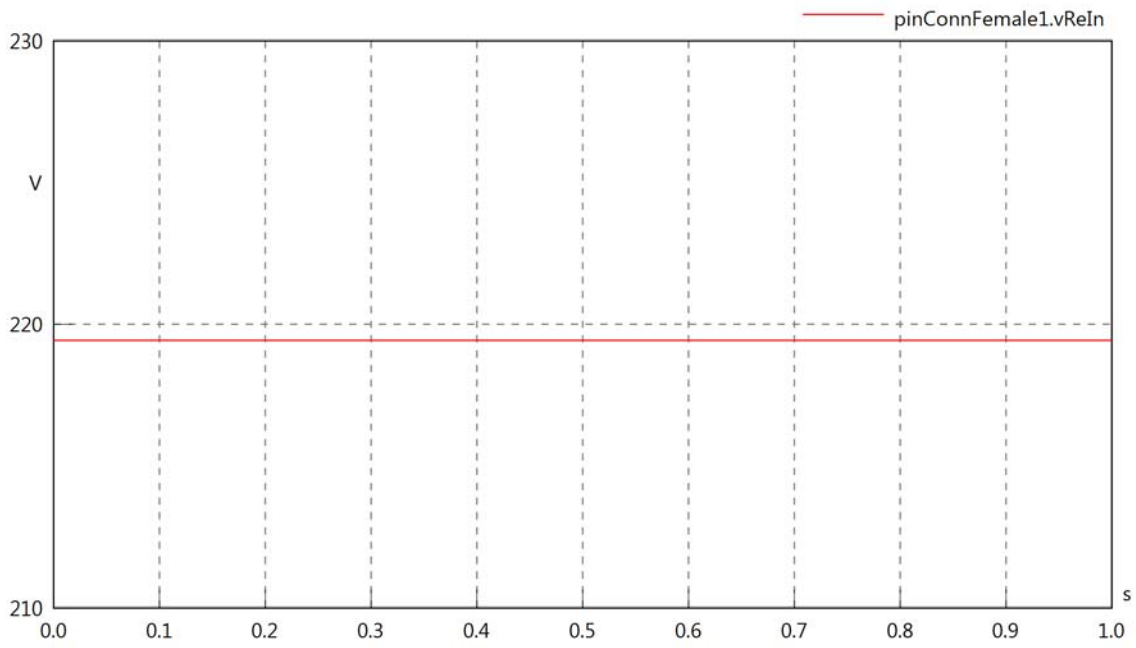

pinConnFemale1.vImIn

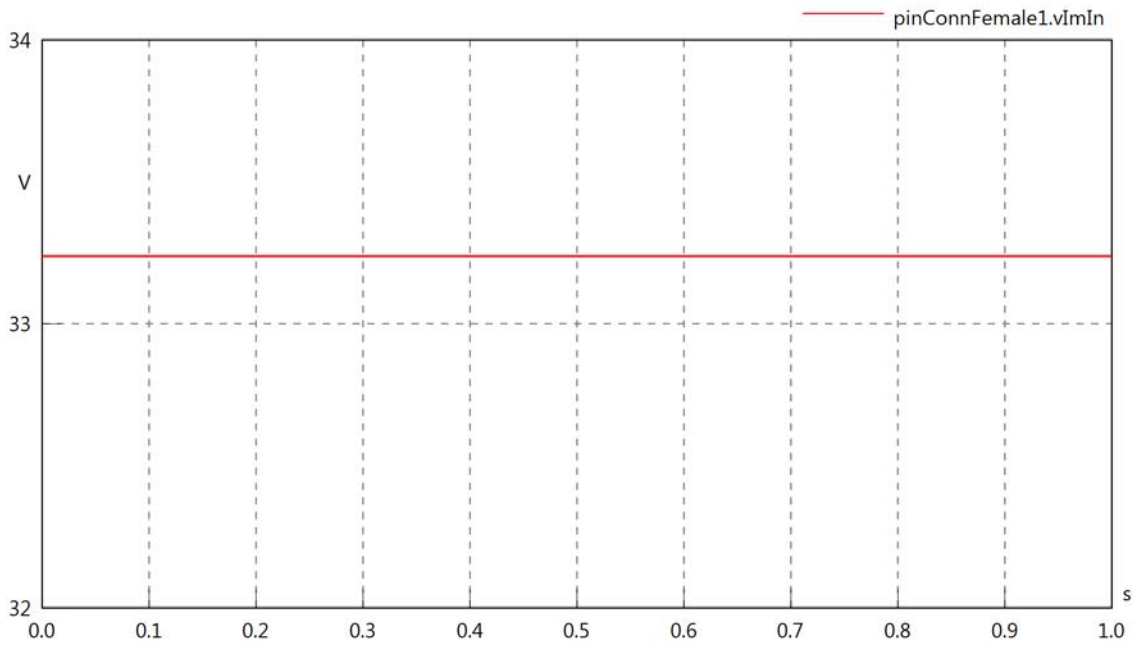

pinConnFemale1.VrmsOut

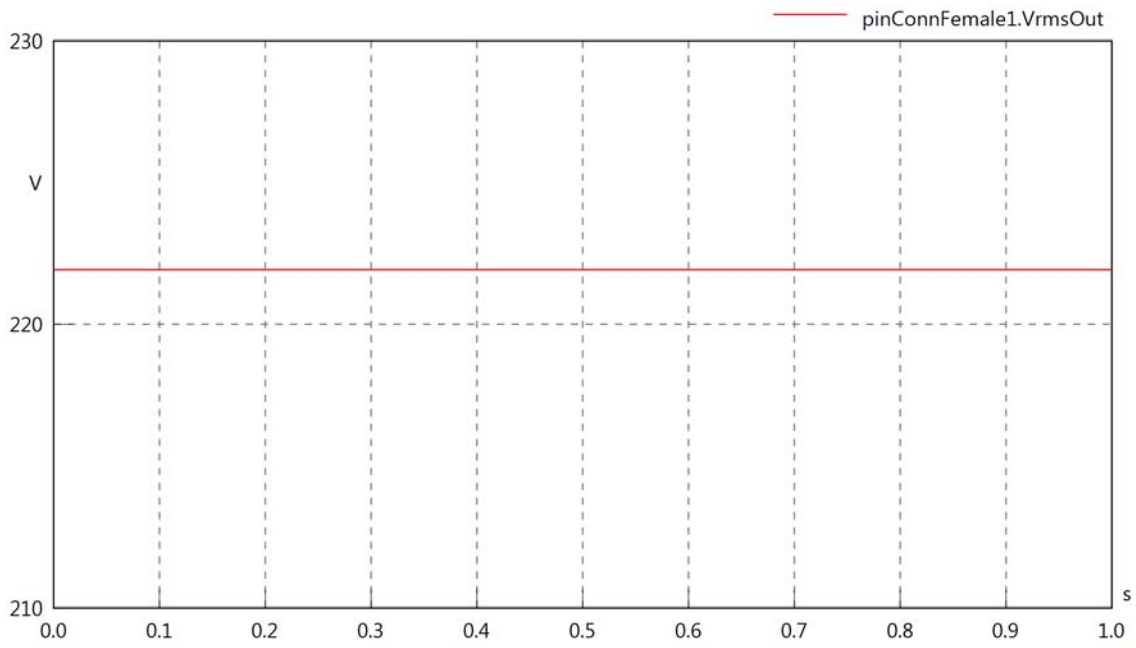

pinConnFemale1.vReOut

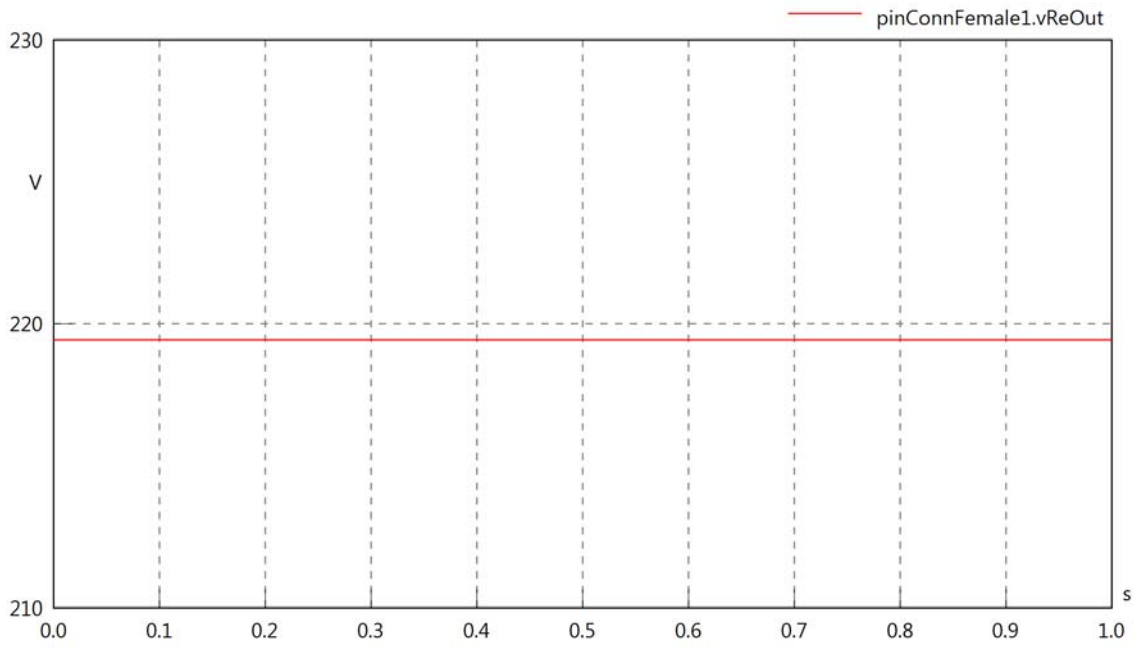

pinConnFemale1.vImOut

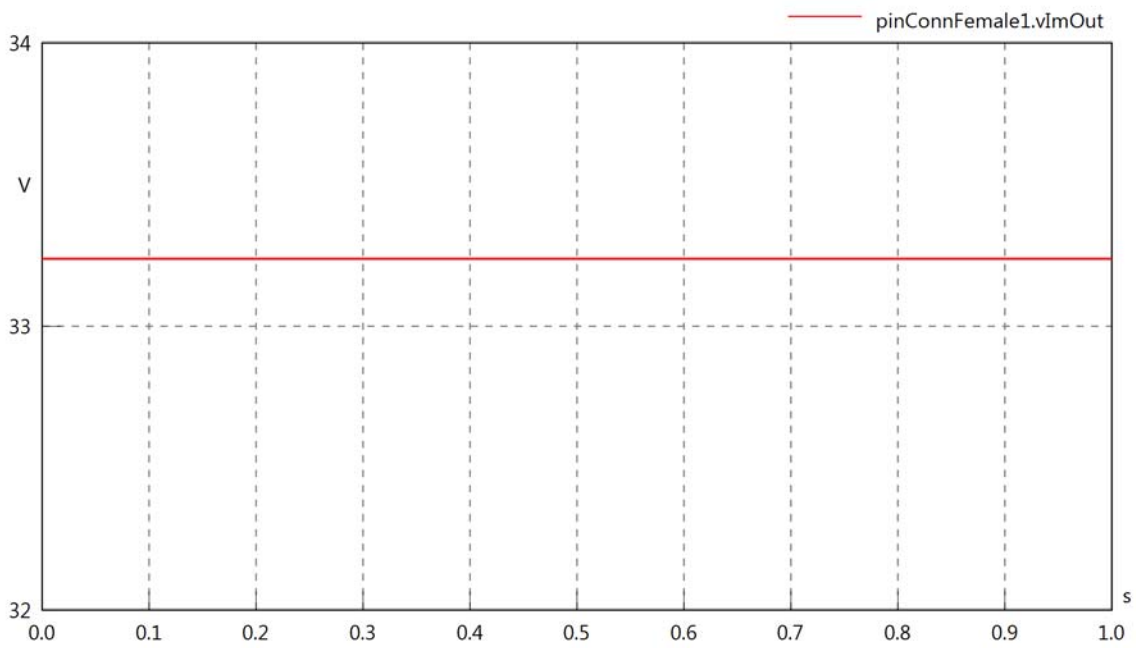

pinConnFemale1.Vrms

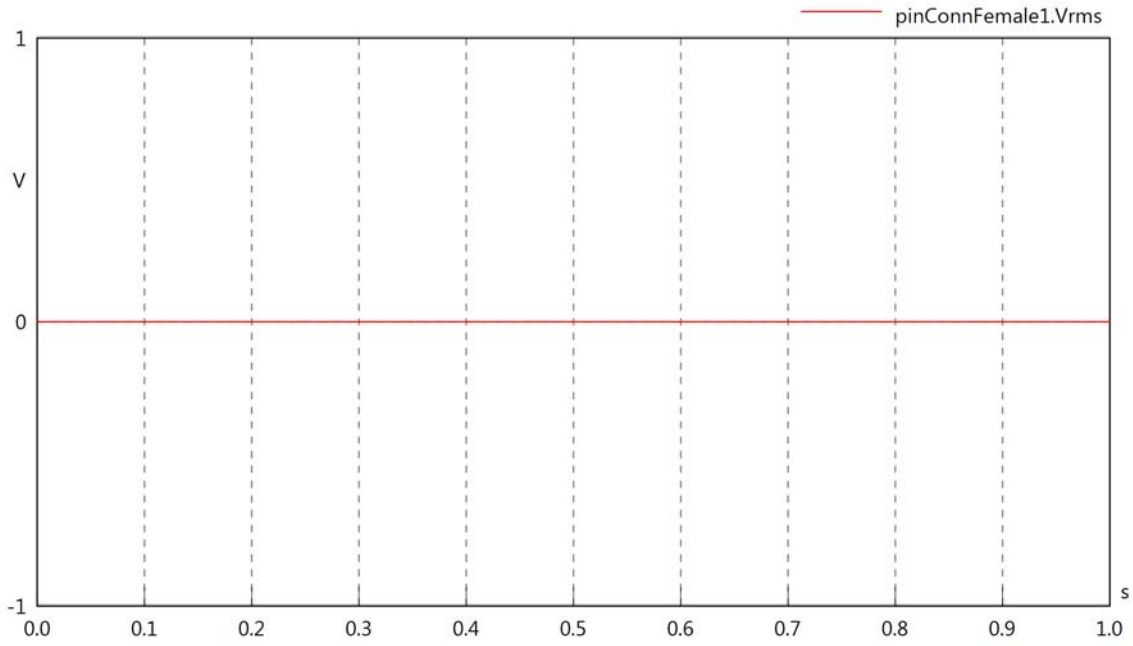

pinConnFemale1.vRe

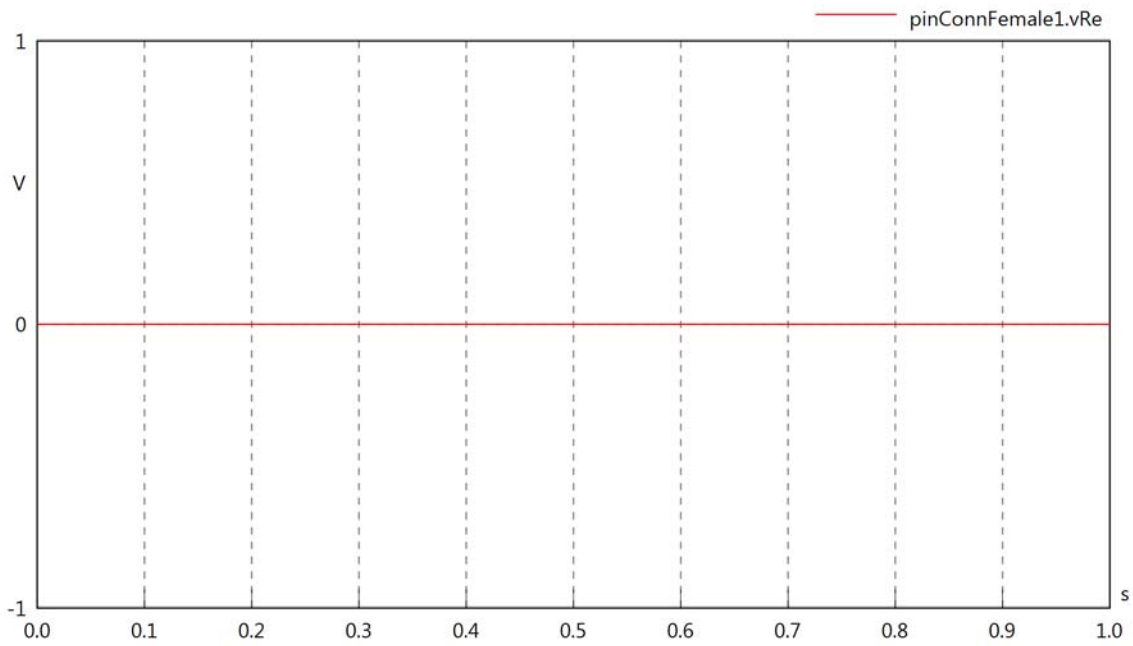

pinConnFemale1.vIm

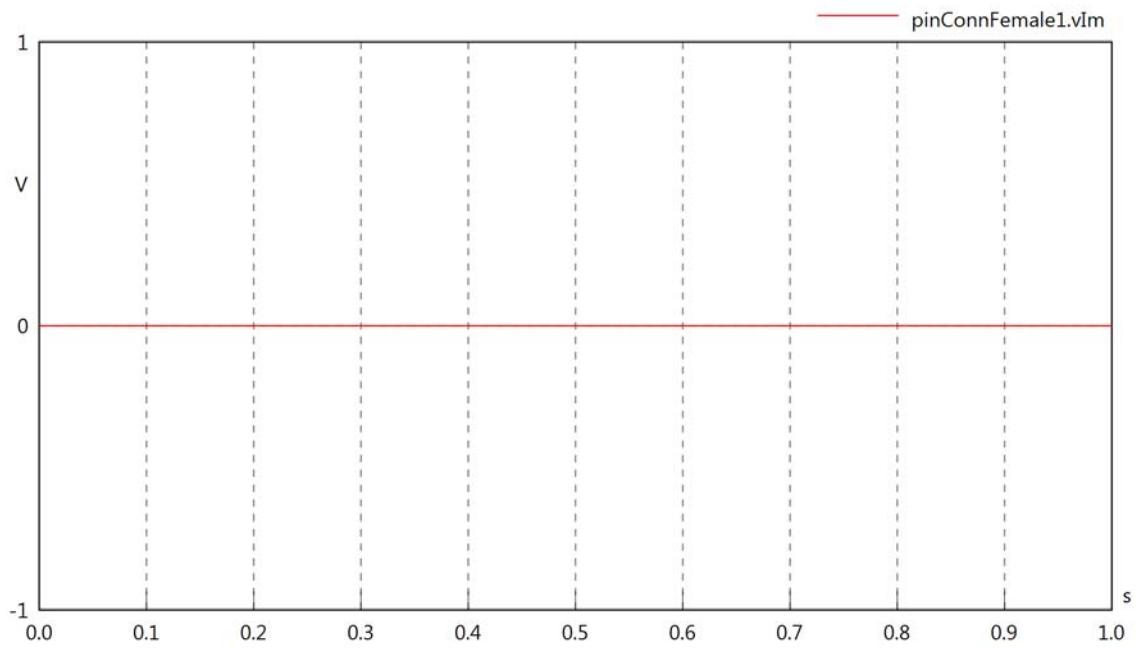

pinConnFemale1.IrmsIn

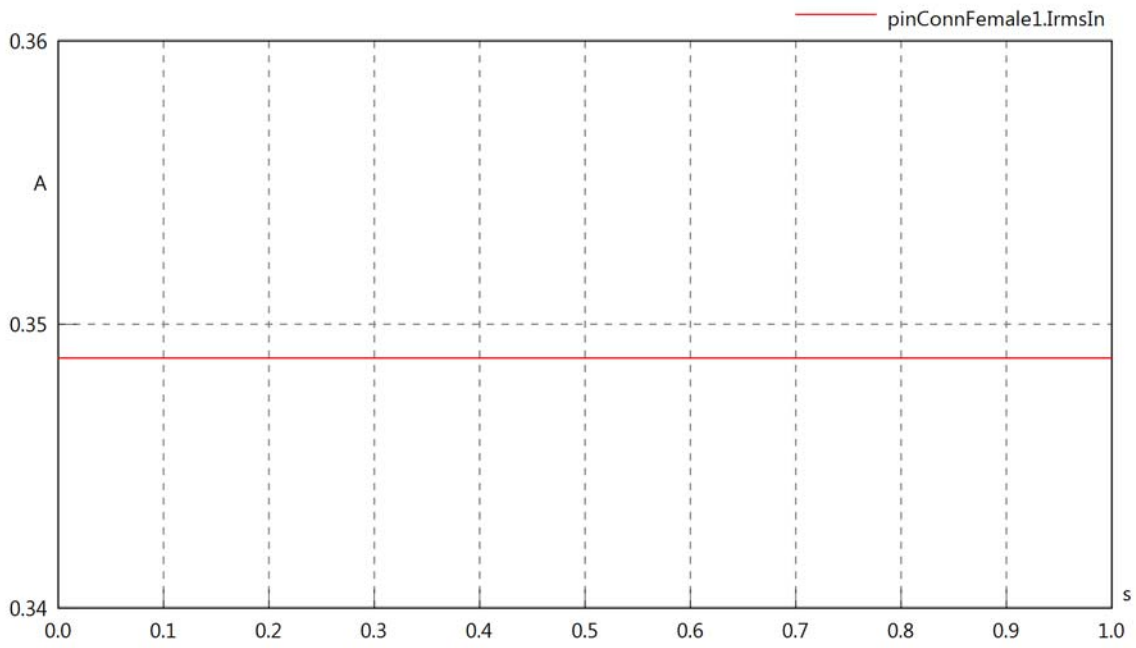

pinConnFemale1.iReIn

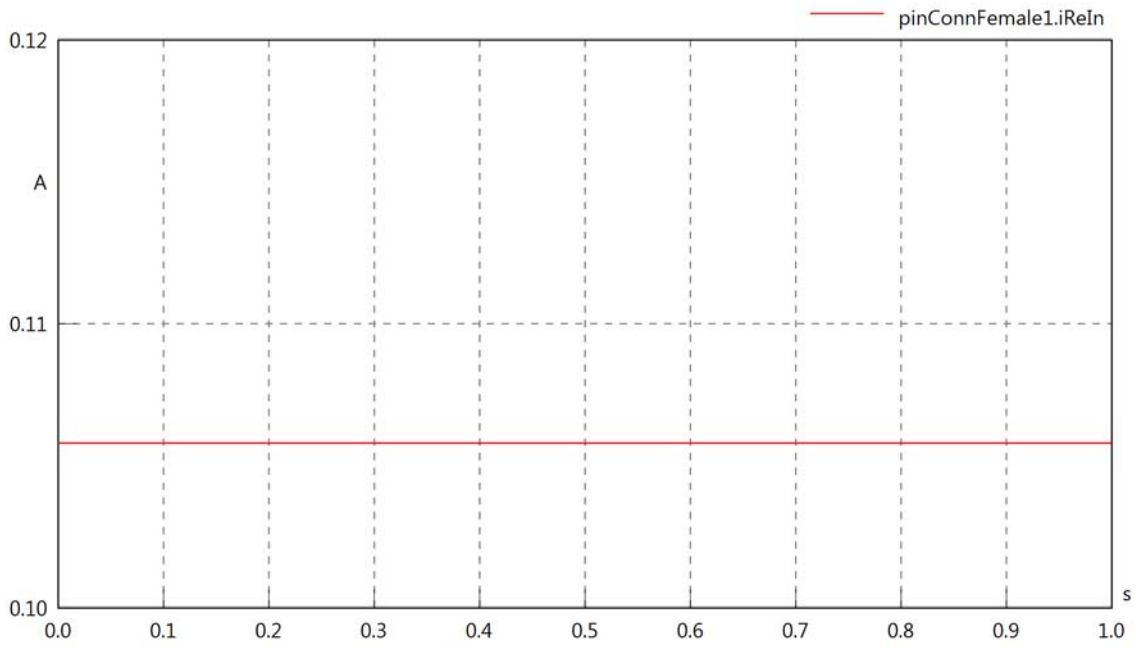

pinConnFemale1.iImIn

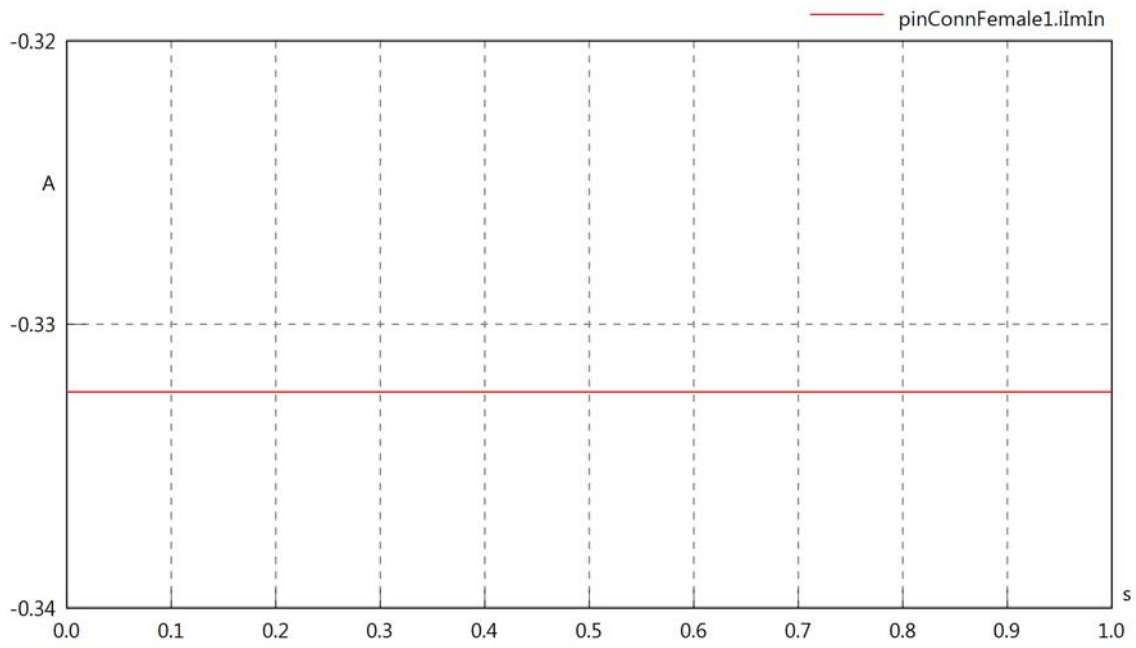

pinConnFemale1.IrmsOut

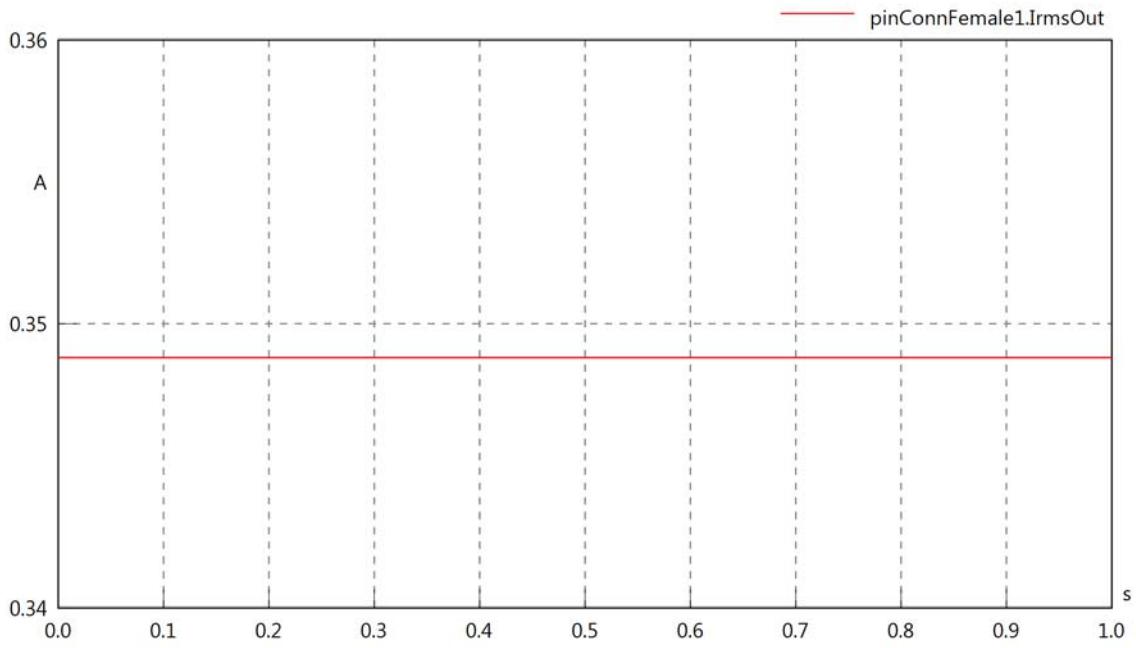

pinConnFemale1.iReOut

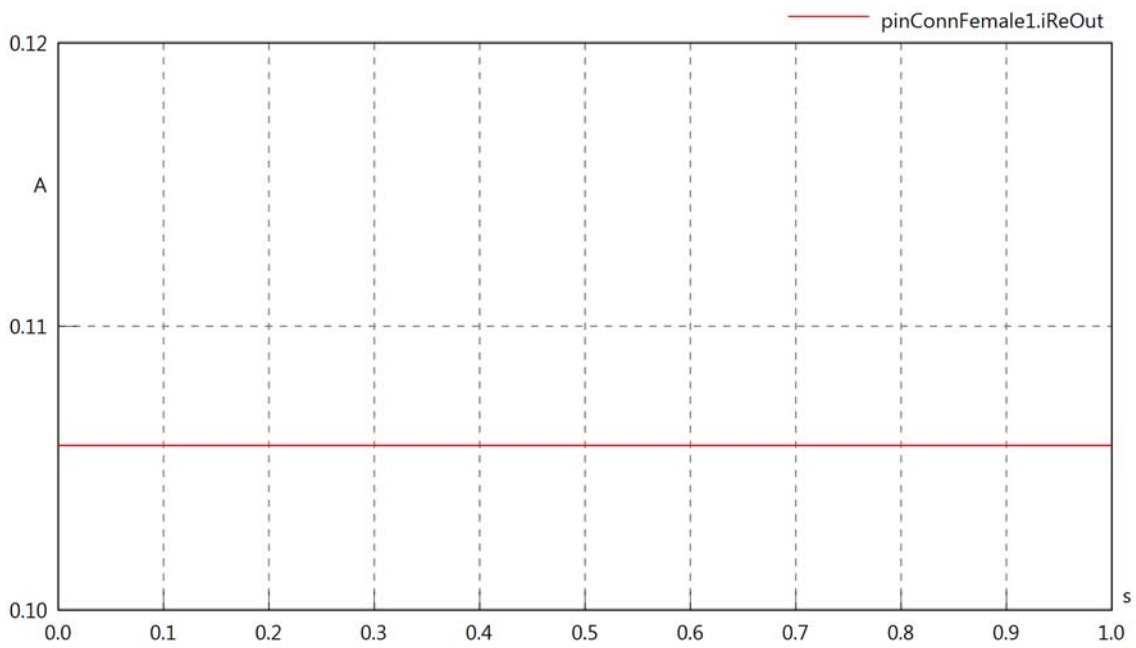

pinConnFemale1.iImOut

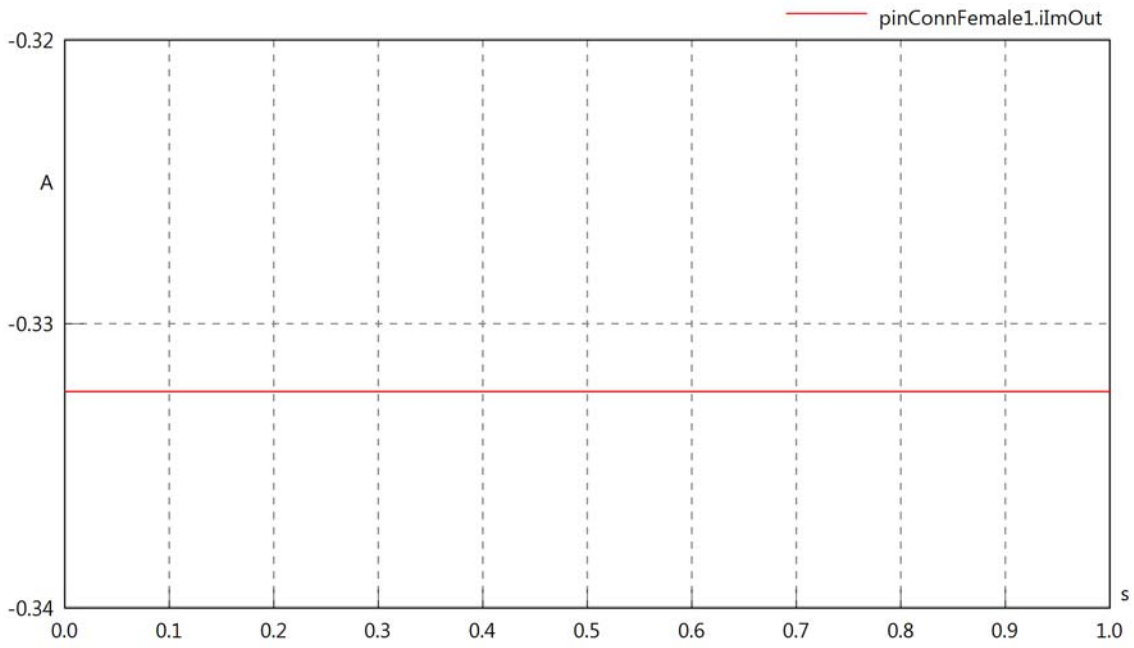

pinConnFemale1.phiVIn

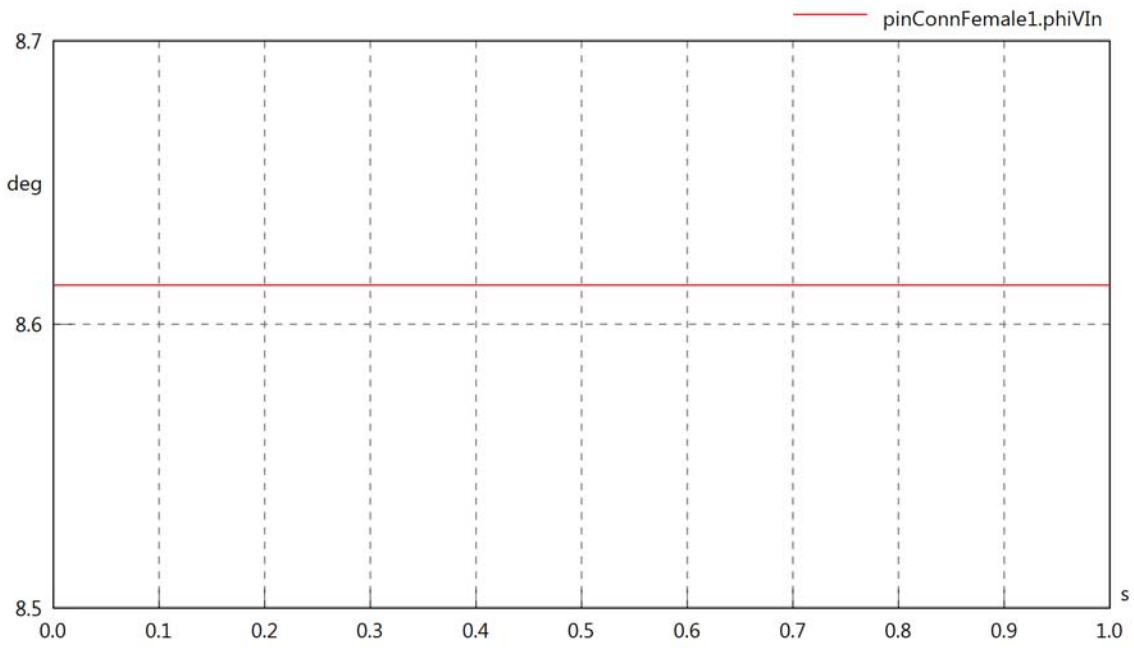

pinConnFemale1.phiIIn

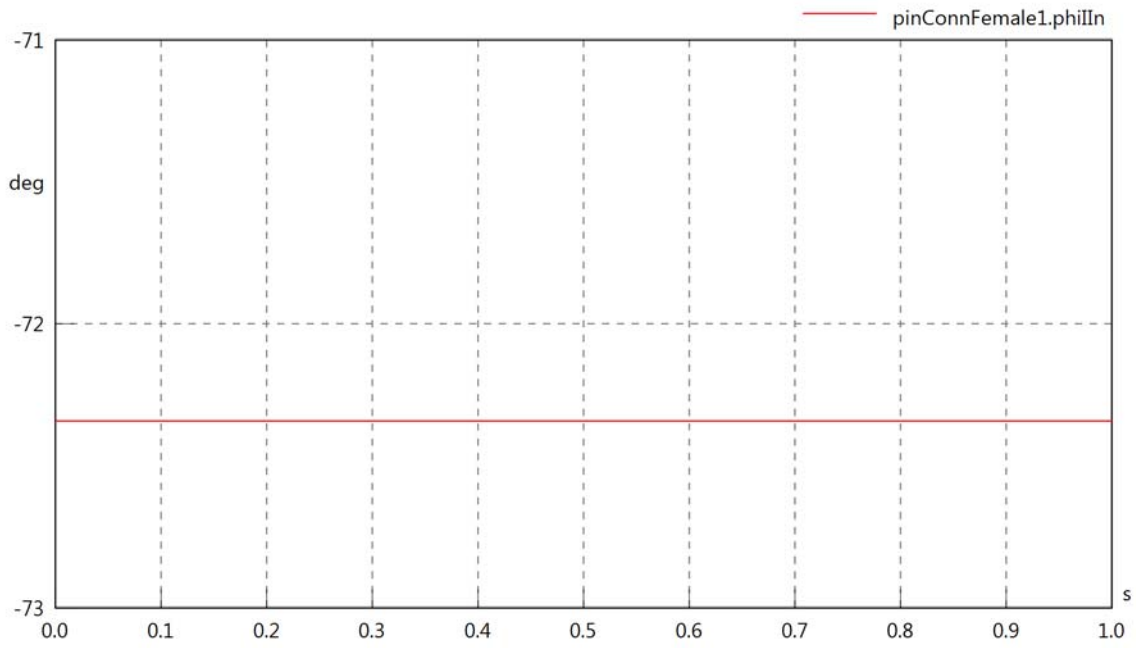

pinConnFemale1.phiIVIn

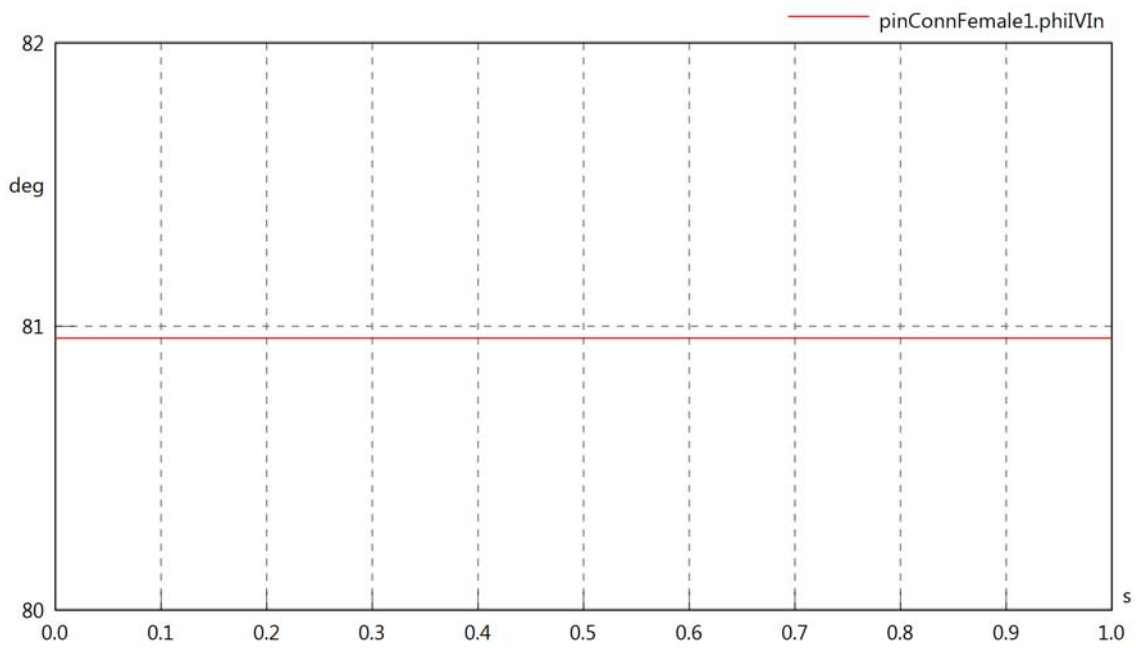

pinConnFemale1.phiVOut

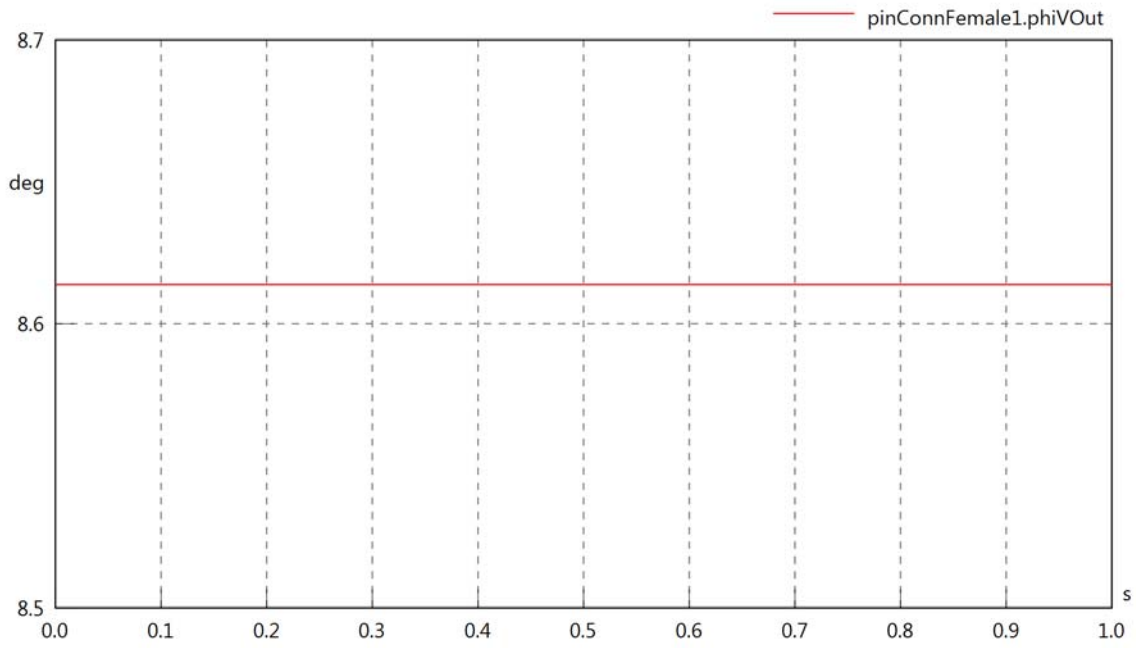

pinConnFemale1.phiIOut

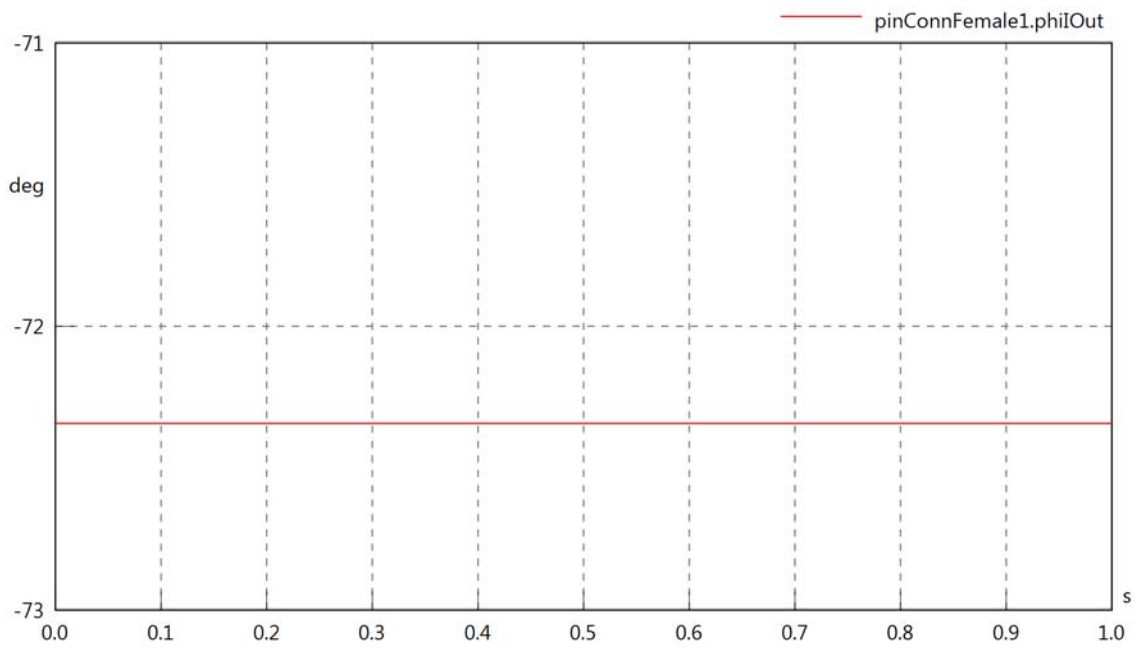

pinConnFemale1.phiIVOut

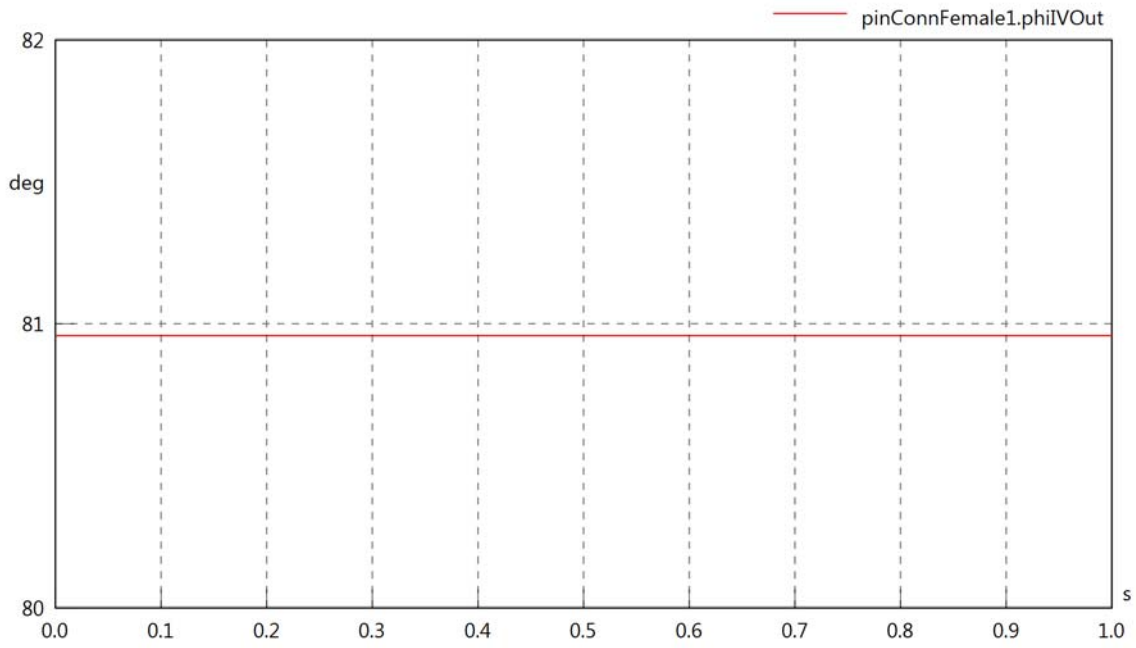

pinConnFemale1.PReIn

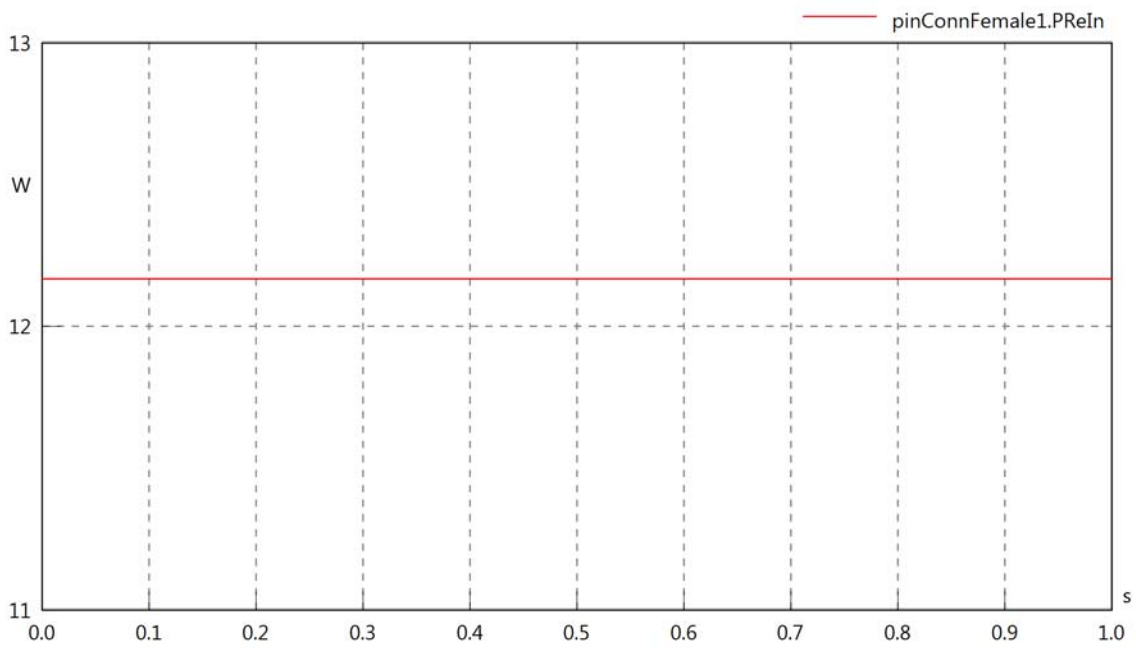

pinConnFemale1.PImIn

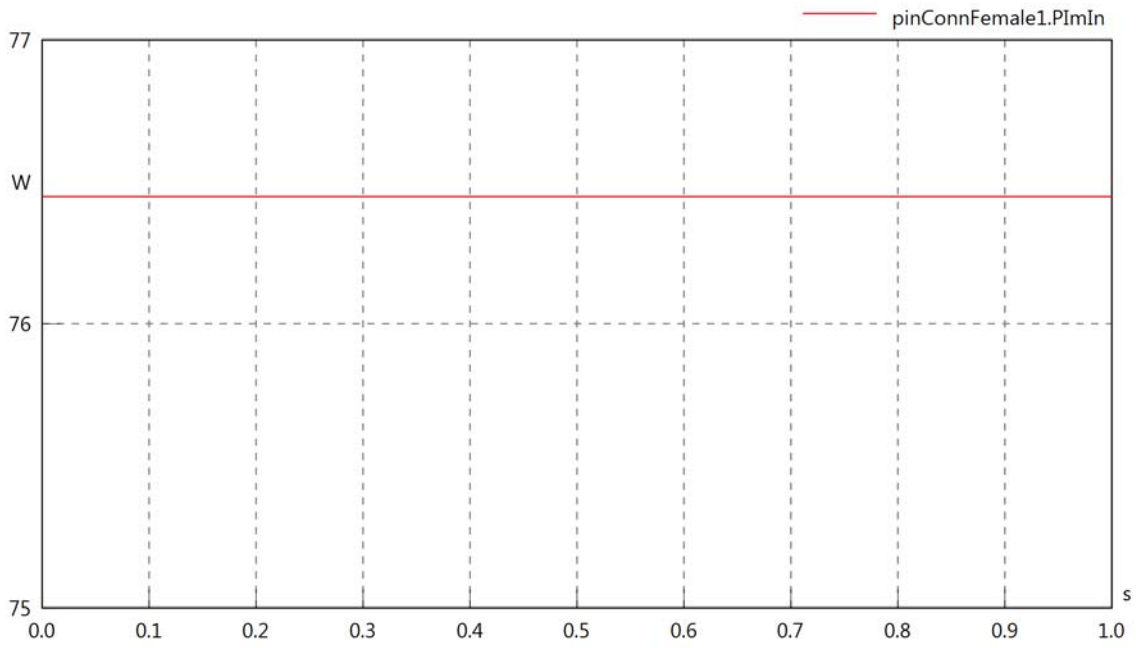

pinConnFemale1.SIn

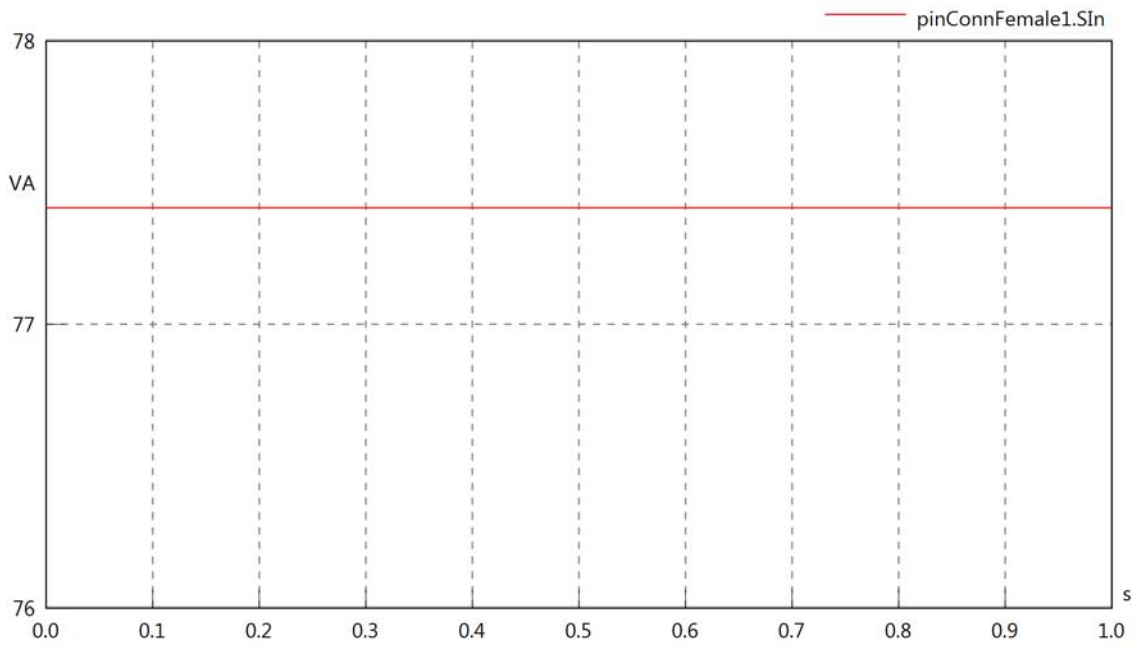

pinConnFemale1.PReOut

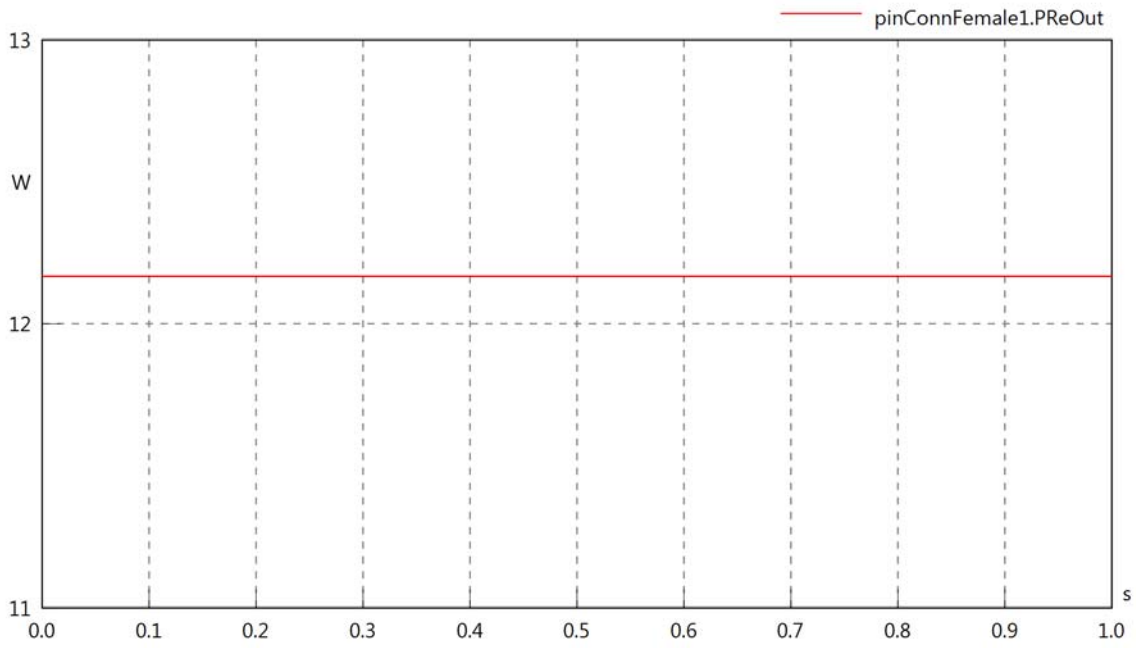

pinConnFemale1.PImOut

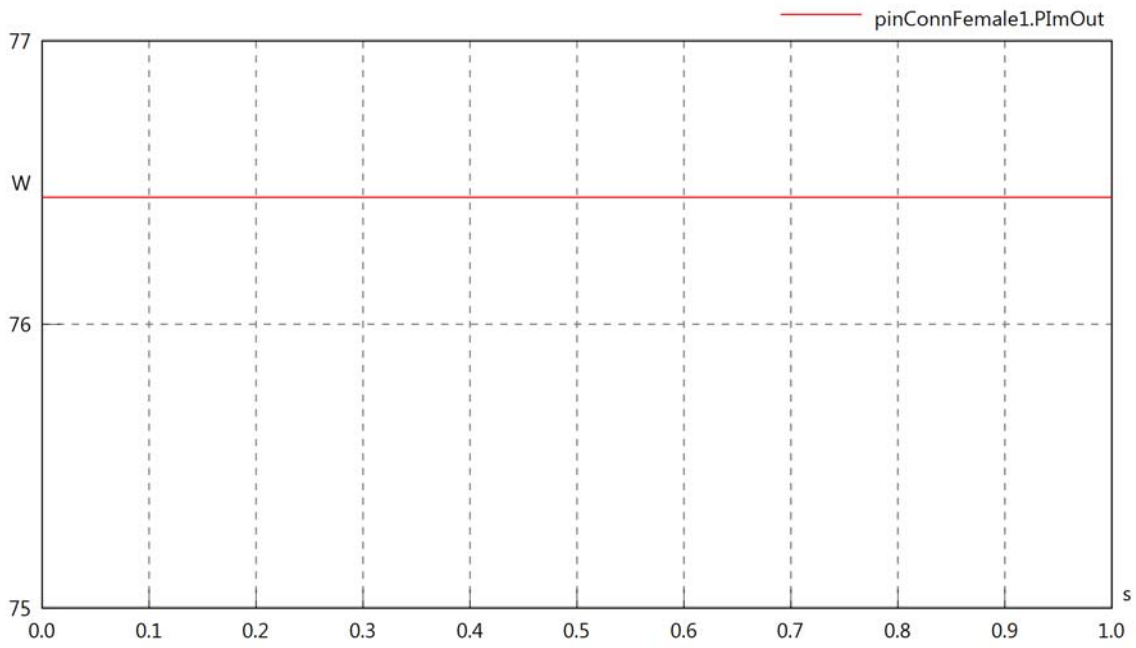

pinConnFemale1.SOut

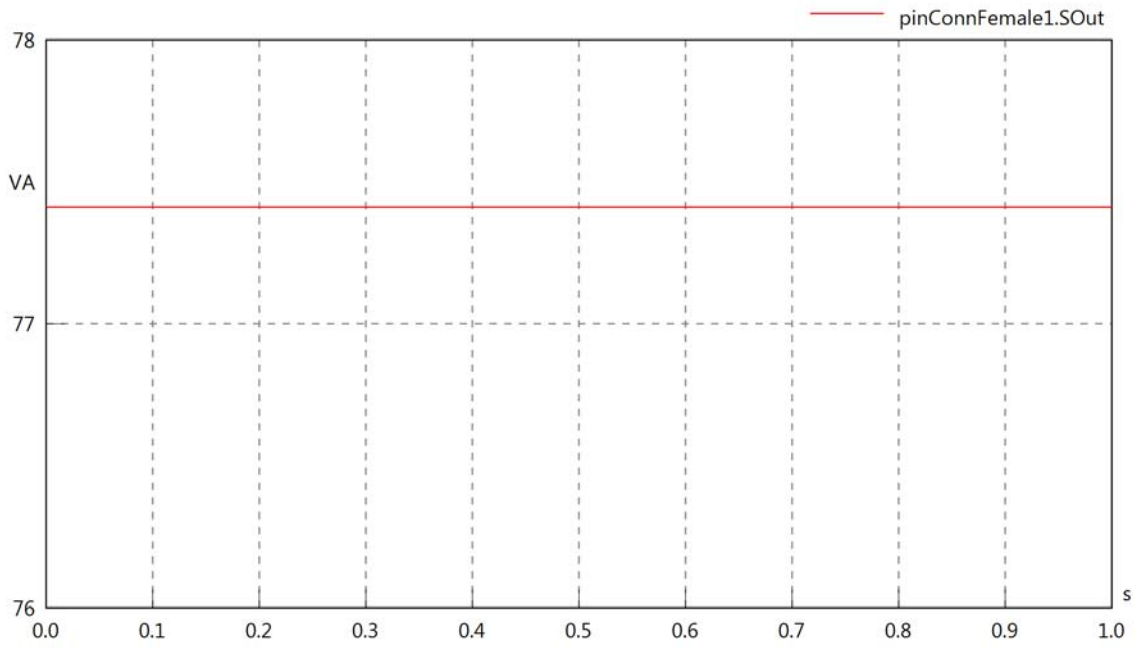
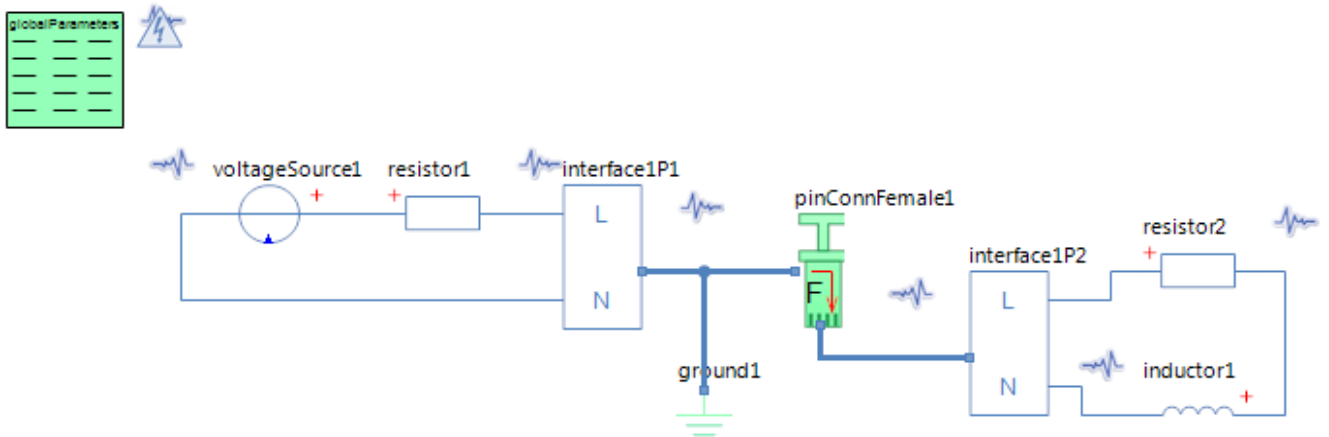

Diagram View



GlobalParameters globalParameters
Parameters

Comment	Name	Current Value	Unit
Type of Calculation	eCalculationKind	Signal Calculation	
Description of Frequency	eFrequencyKind	Linear	
Minimum Frequency	fMin	60	[Hz]
Maximum Frequency	fMax	60	[Hz]

Voltage Source voltageSource1
Parameters

Comment	Name	Current Value	Unit
Voltage RMS	VrmsSrc	230	[V]
Phase	phi	0	[deg]

Resistor resistor1
Parameters

Comment	Name	Current Value	Unit
Resistance	R	100	[Ohm]

Resistor resistor2
Parameters

Comment	Name	Current Value	Unit
Resistance	R	100	[Ohm]

Inductor inductor1
Parameters

Comment	Name	Current Value	Unit
Inductance	L	5	[mH]

Pin Connector Female pinConnFemale1
Parameters

Comment	Name	Current Value	Unit
Poor or failing L1 connection	bL1	true	
Resistance in L1 connection	rL1	1	[kOhm]
Conductance between L1 and N	G	50	[1/Ohm]

pinConnFemale1.VrmsIn

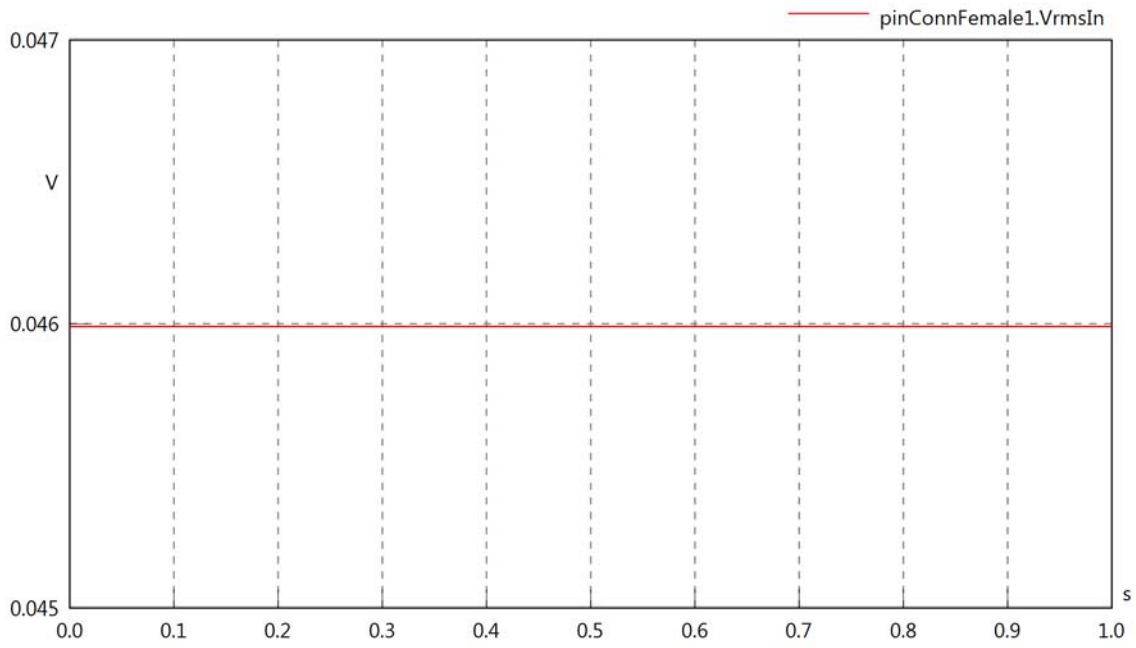

pinConnFemale1.vReIn

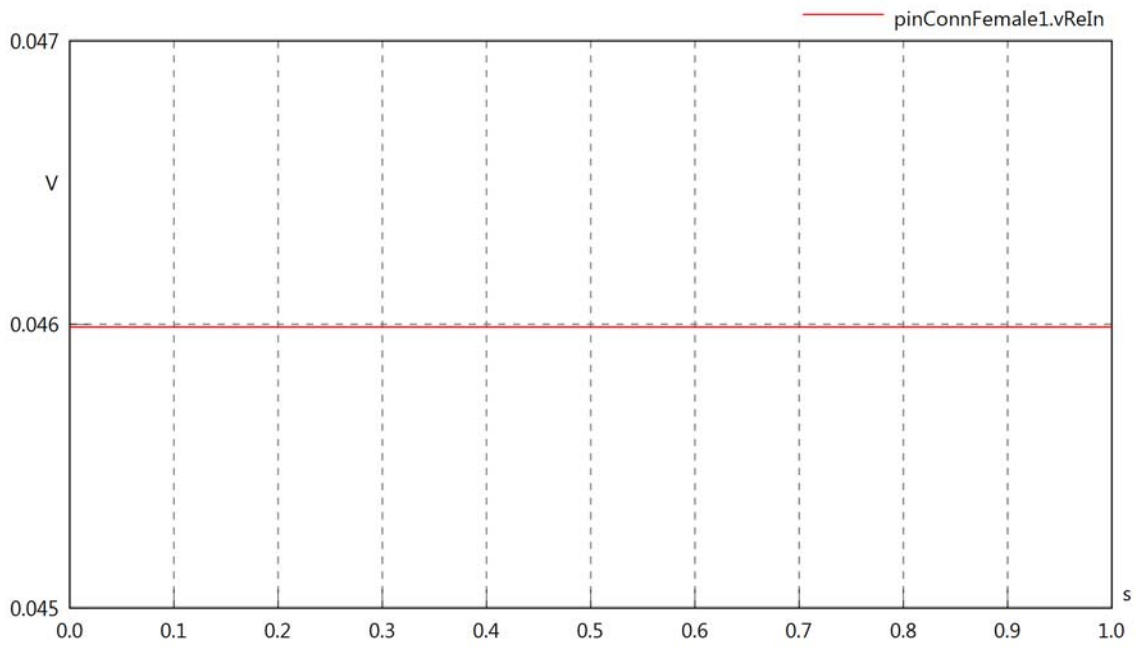

pinConnFemale1.vImIn

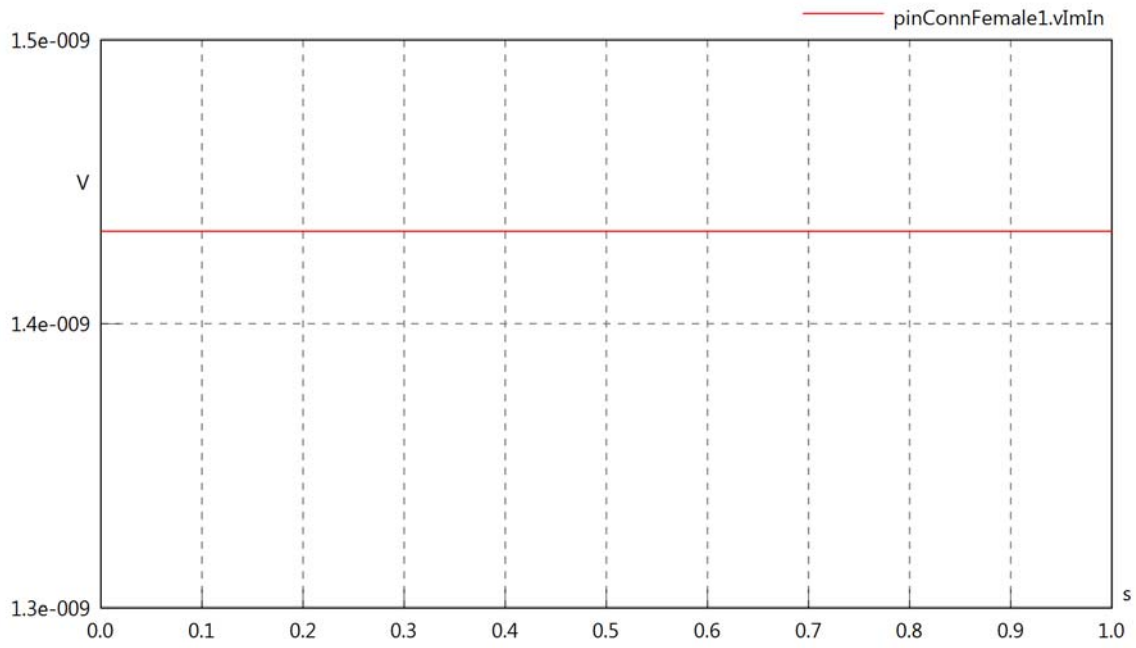

pinConnFemale1.VrmsOut

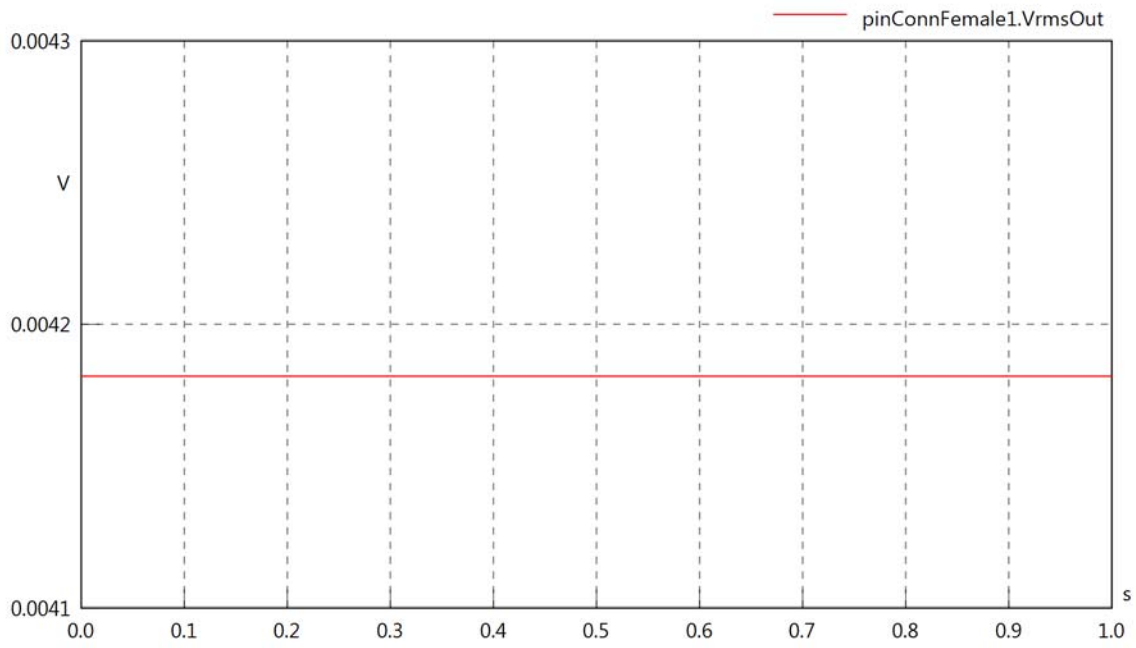

pinConnFemale1.vReOut

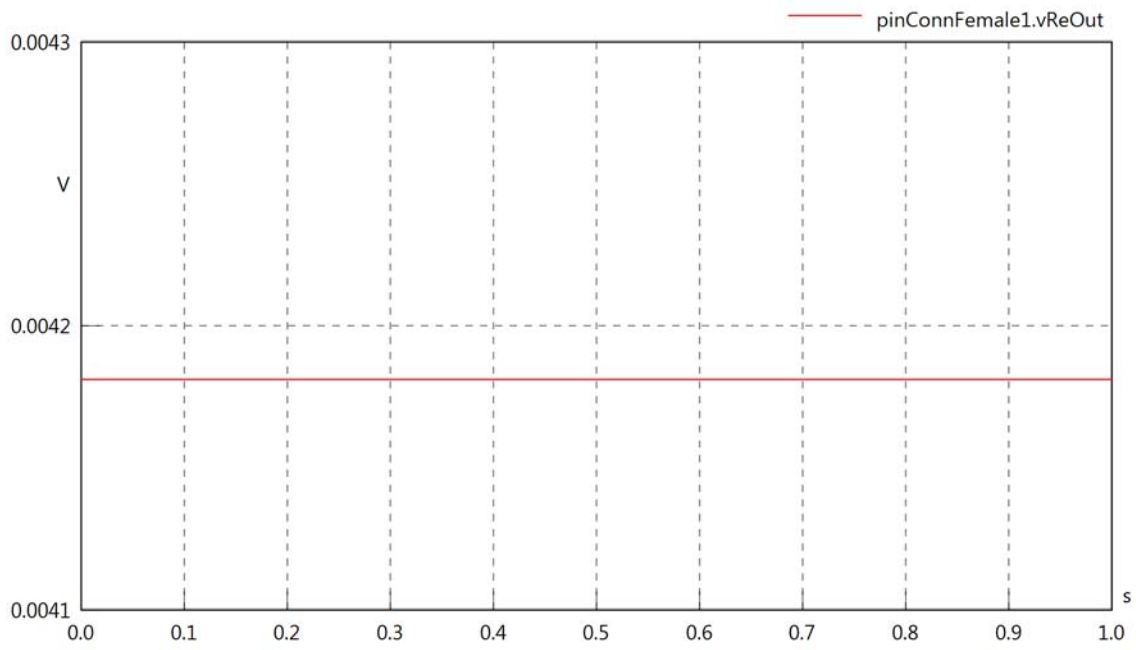

pinConnFemale1.vImOut

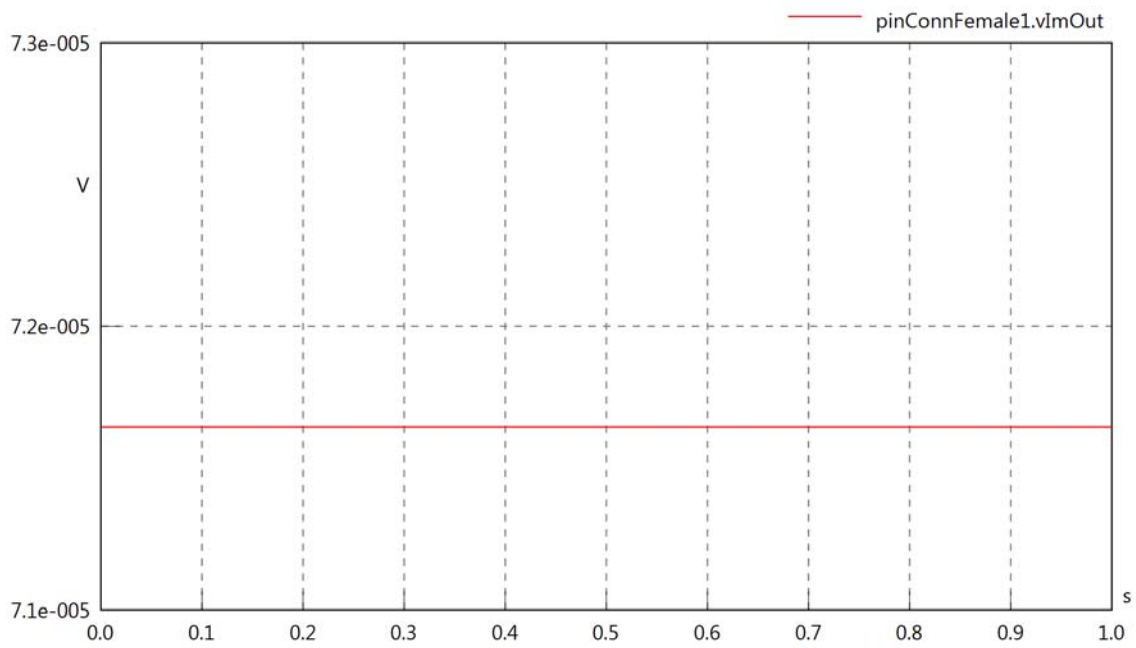

pinConnFemale1.Vrms

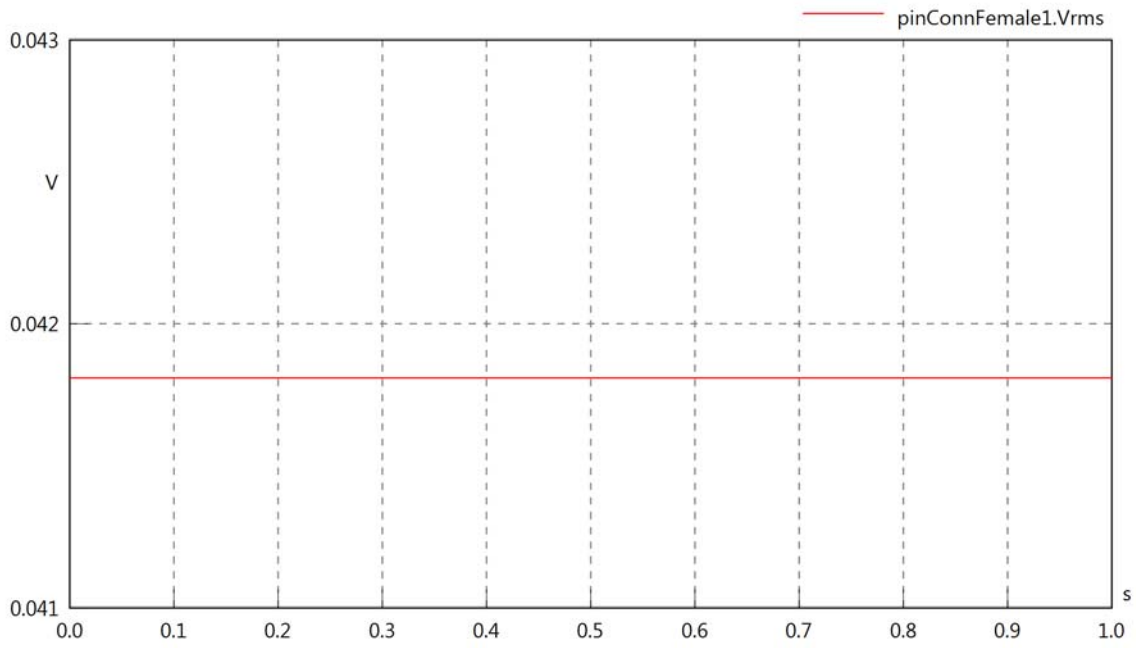

pinConnFemale1.vRe

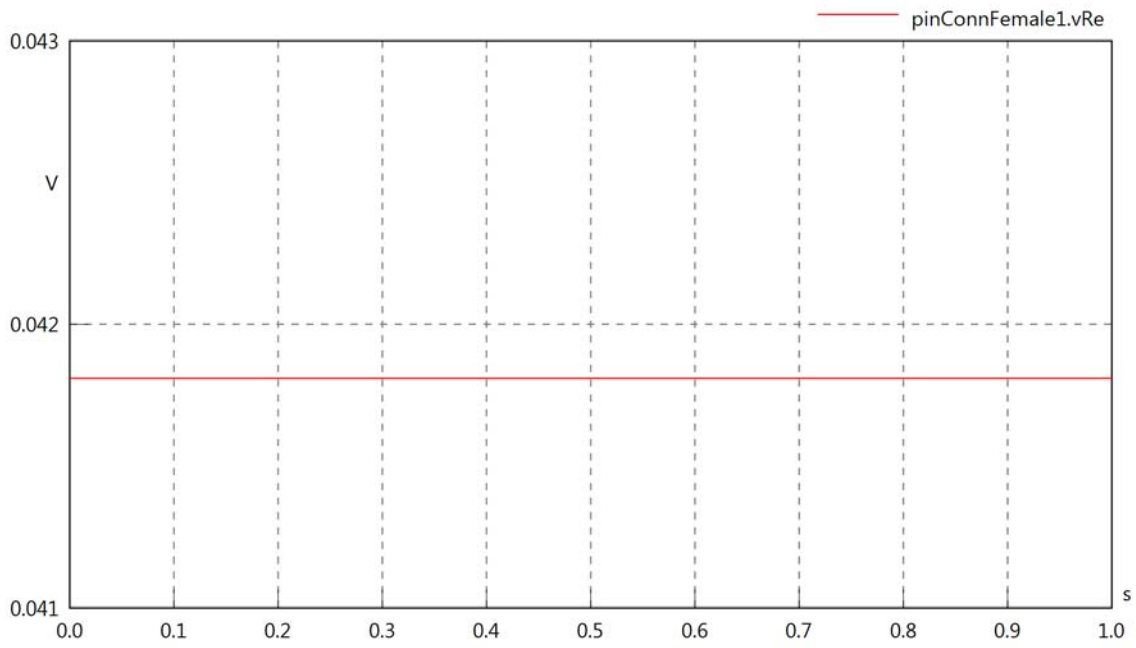

pinConnFemale1.vIm

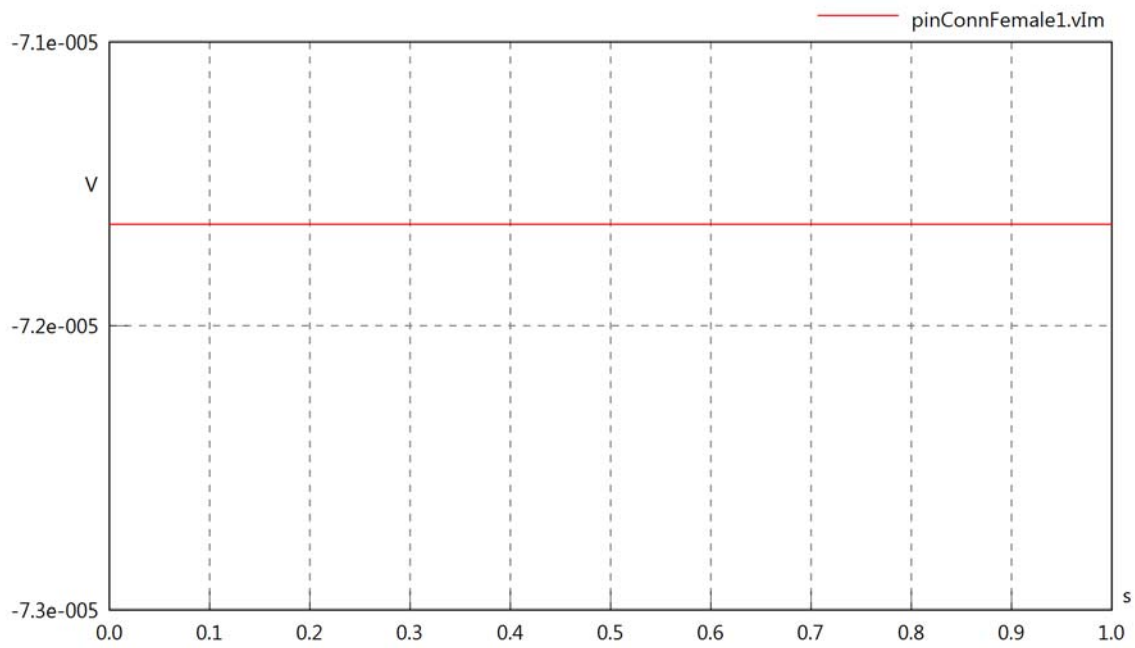

pinConnFemale1.IrmsIn

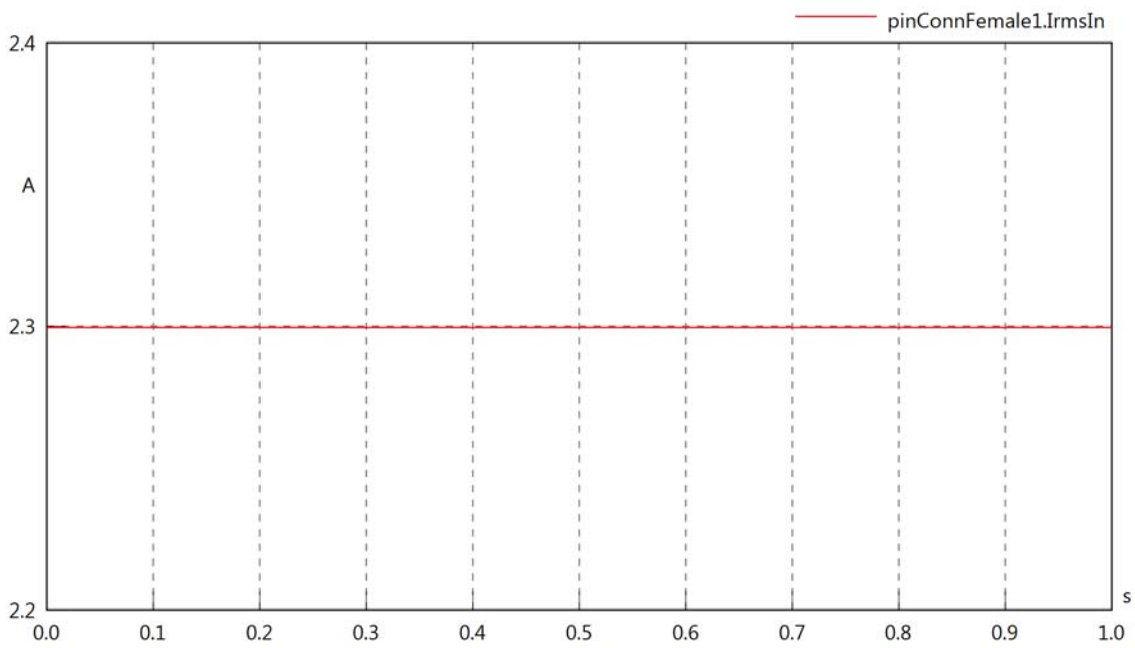

pinConnFemale1.iReIn

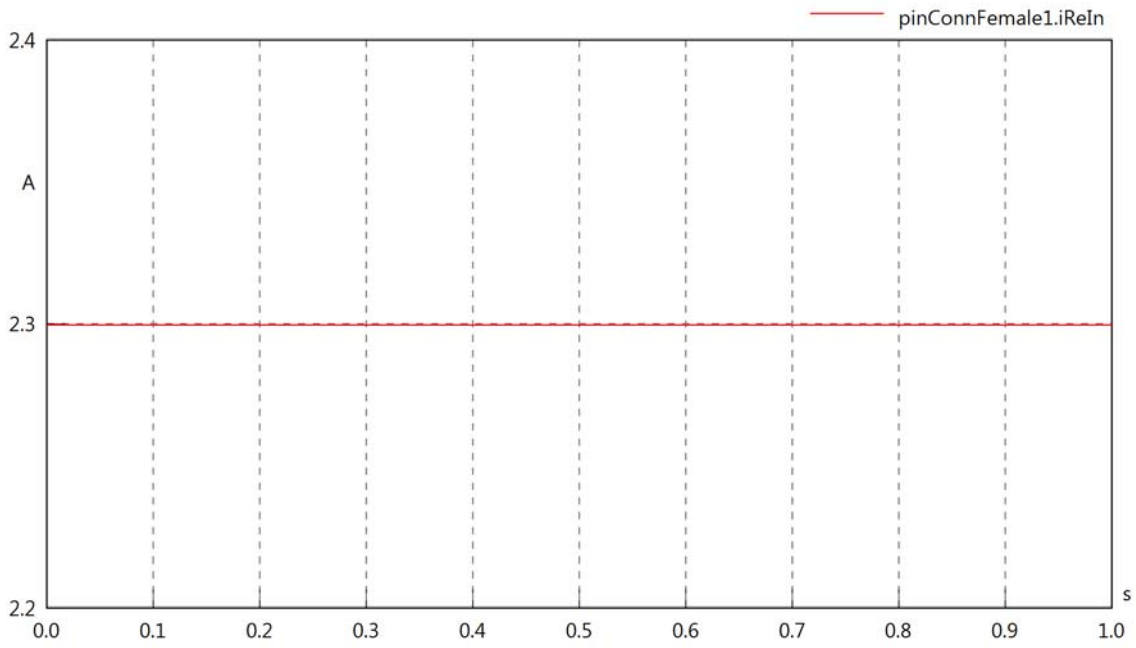

pinConnFemale1.iImIn

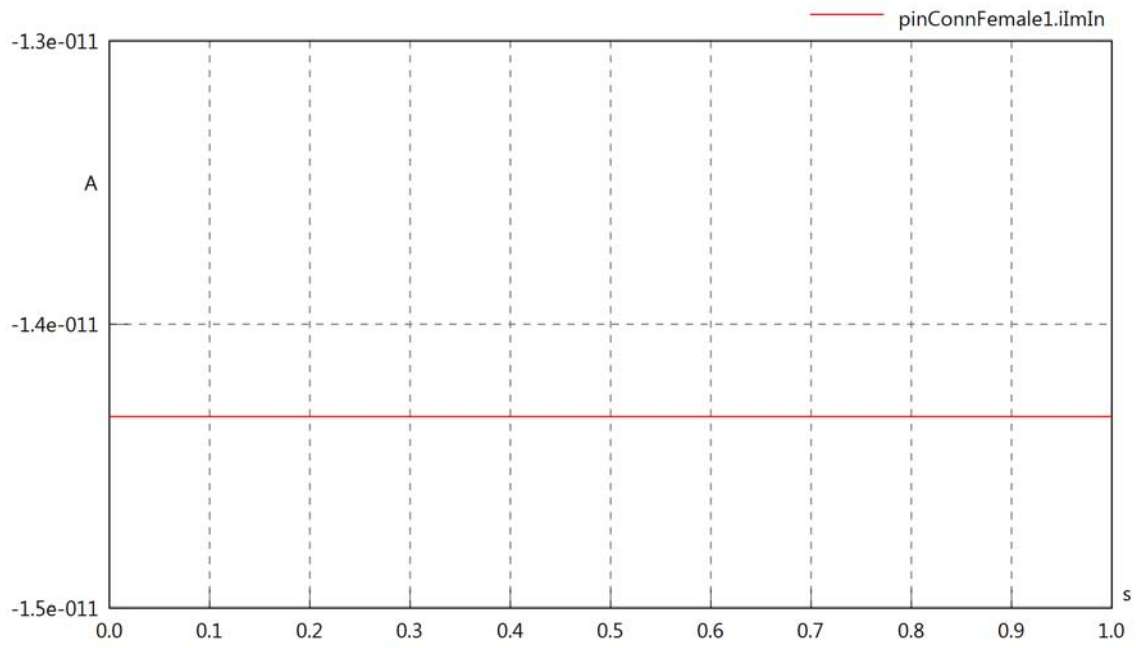

pinConnFemale1.IrmsOut

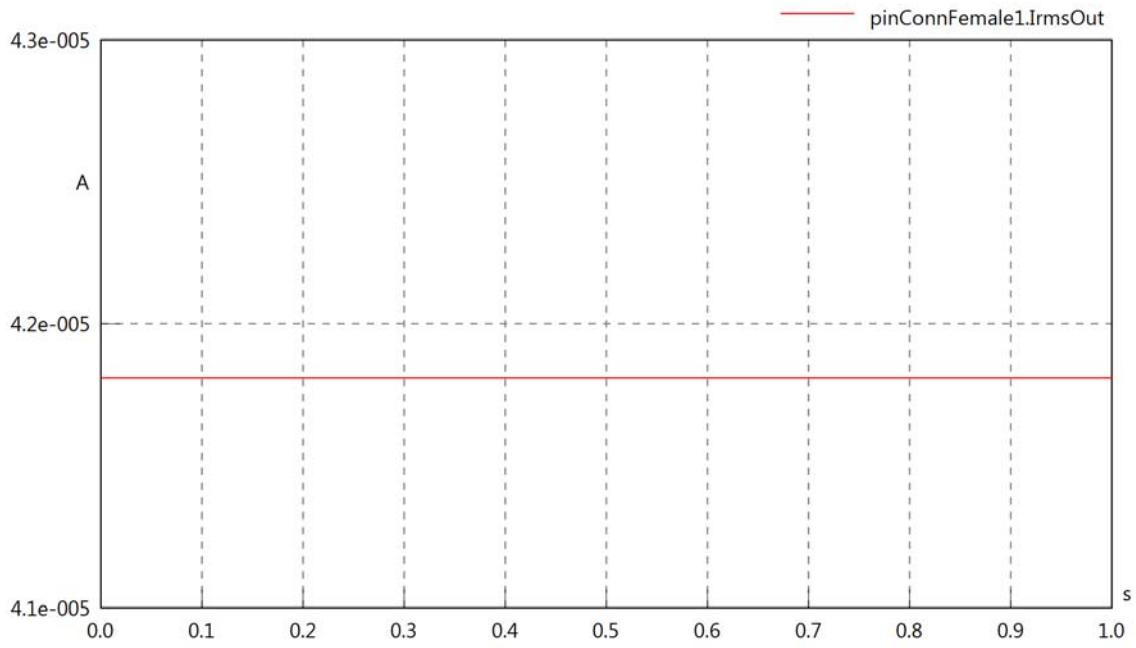

pinConnFemale1.iReOut

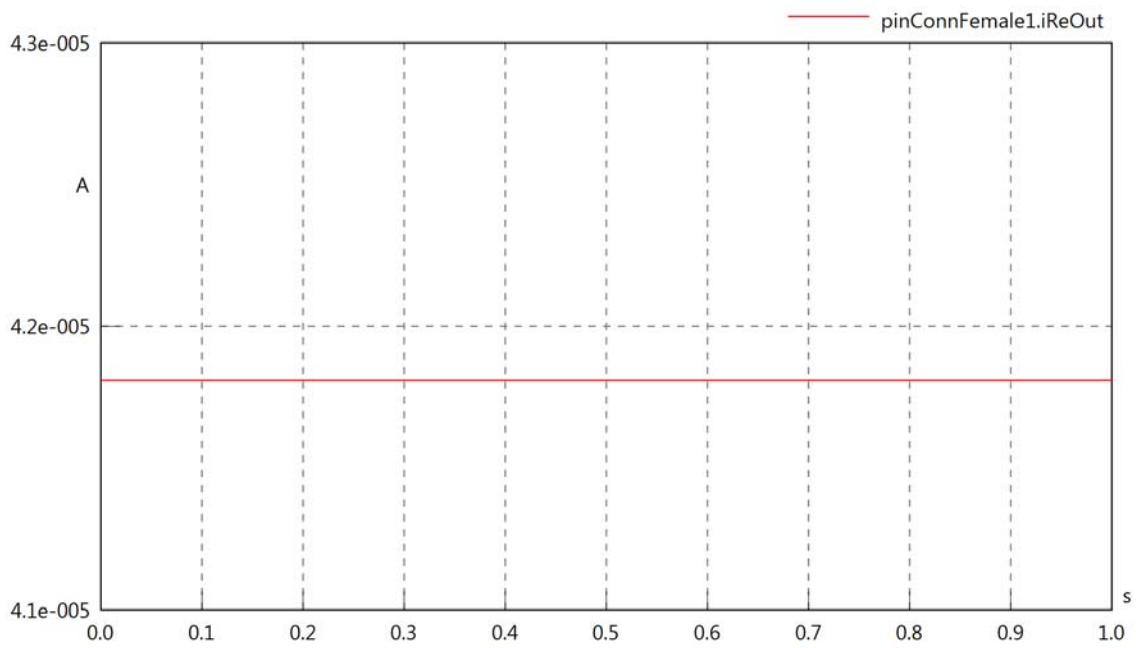

pinConnFemale1.iImOut

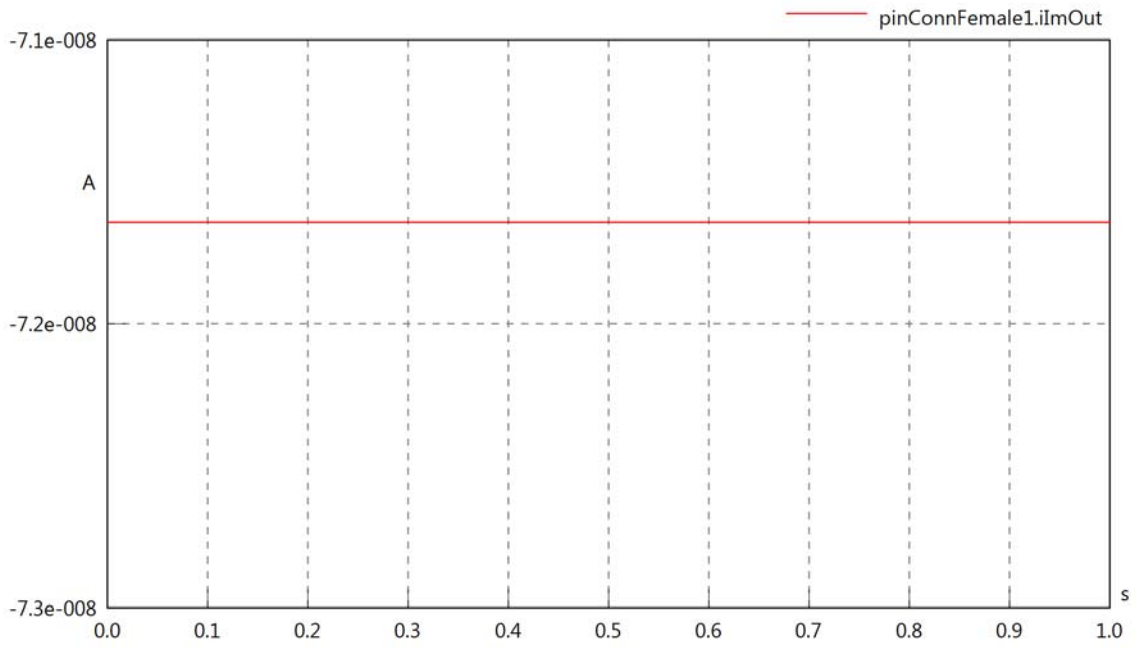

pinConnFemale1.phiVIn

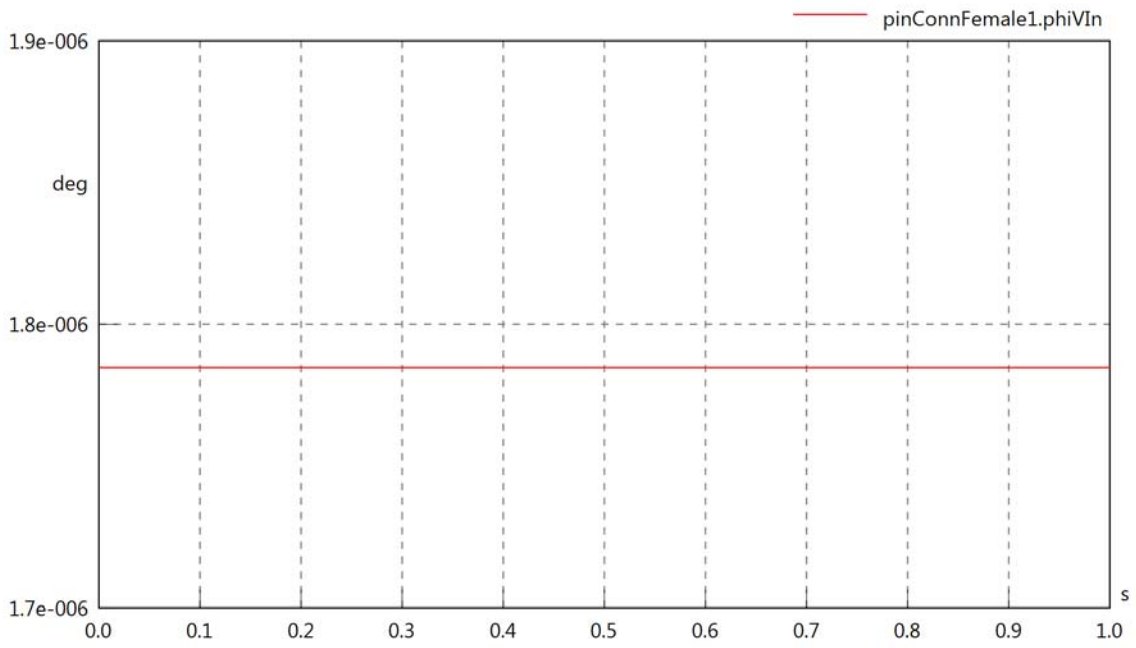

pinConnFemale1.phiIIIn

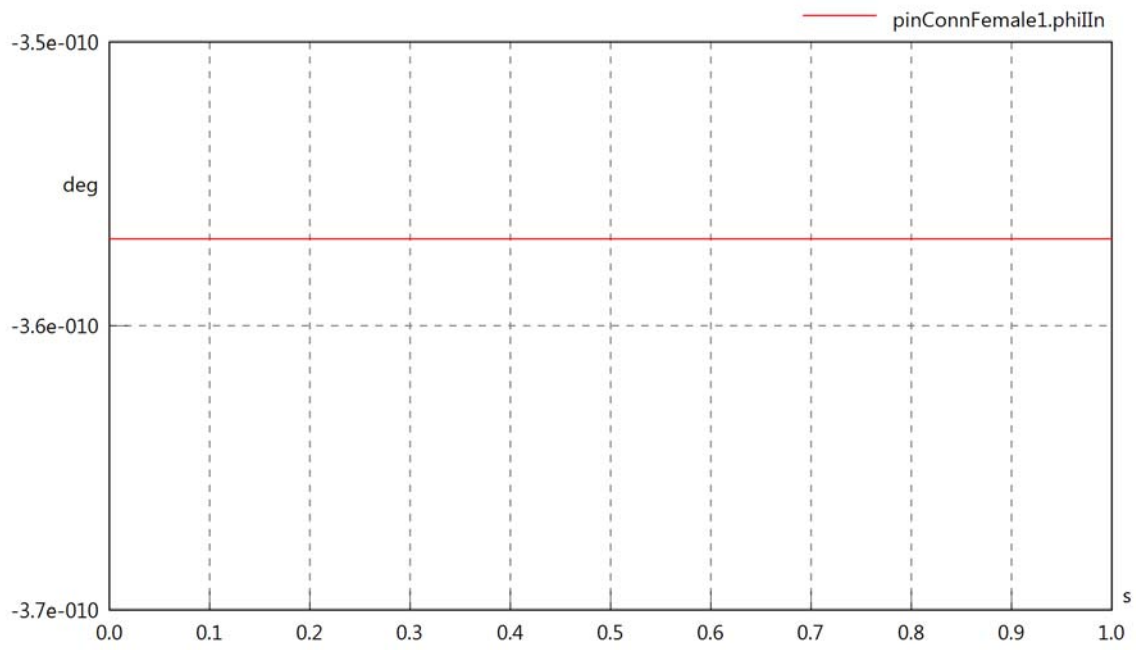

pinConnFemale1.phiIVIn

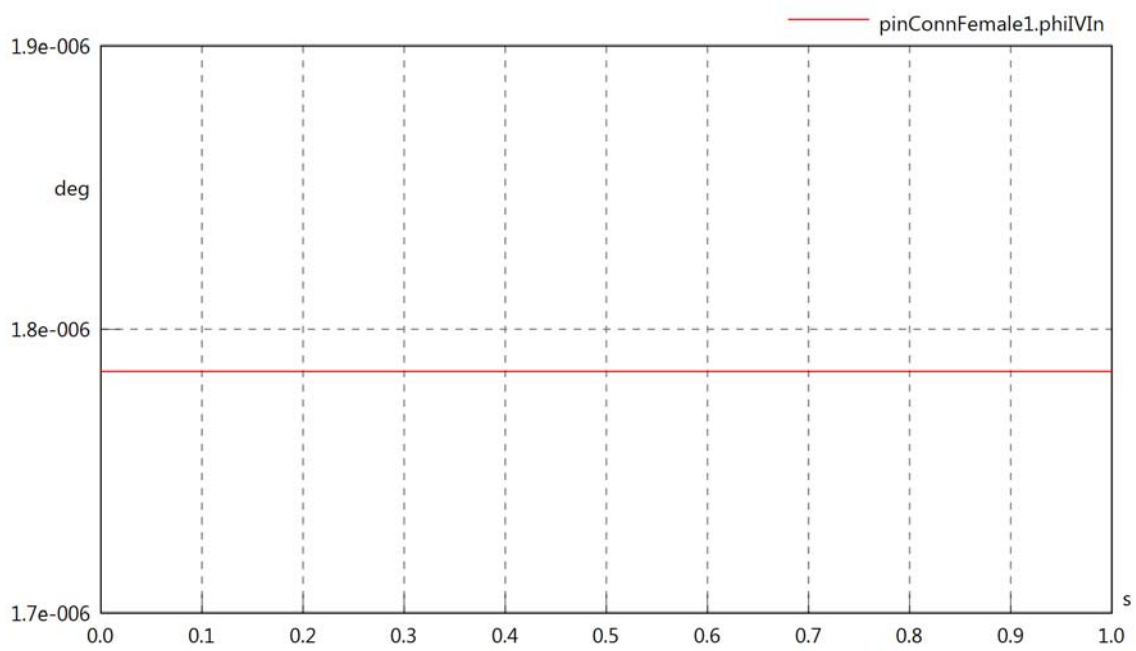

pinConnFemale1.phiVOut

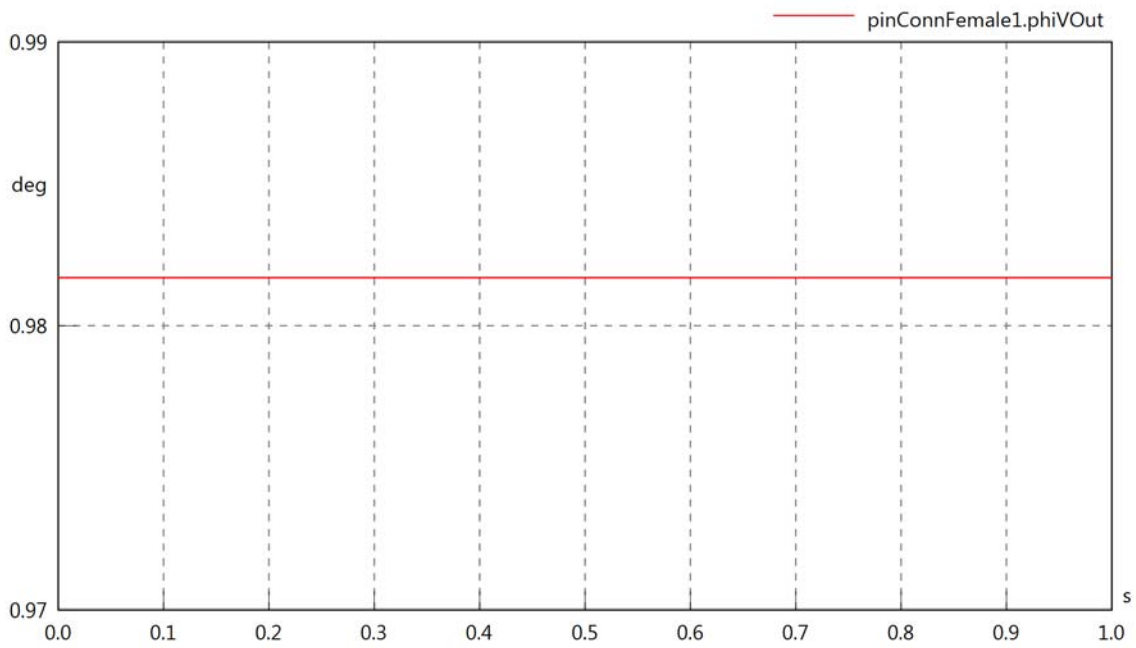

pinConnFemale1.phiIOut

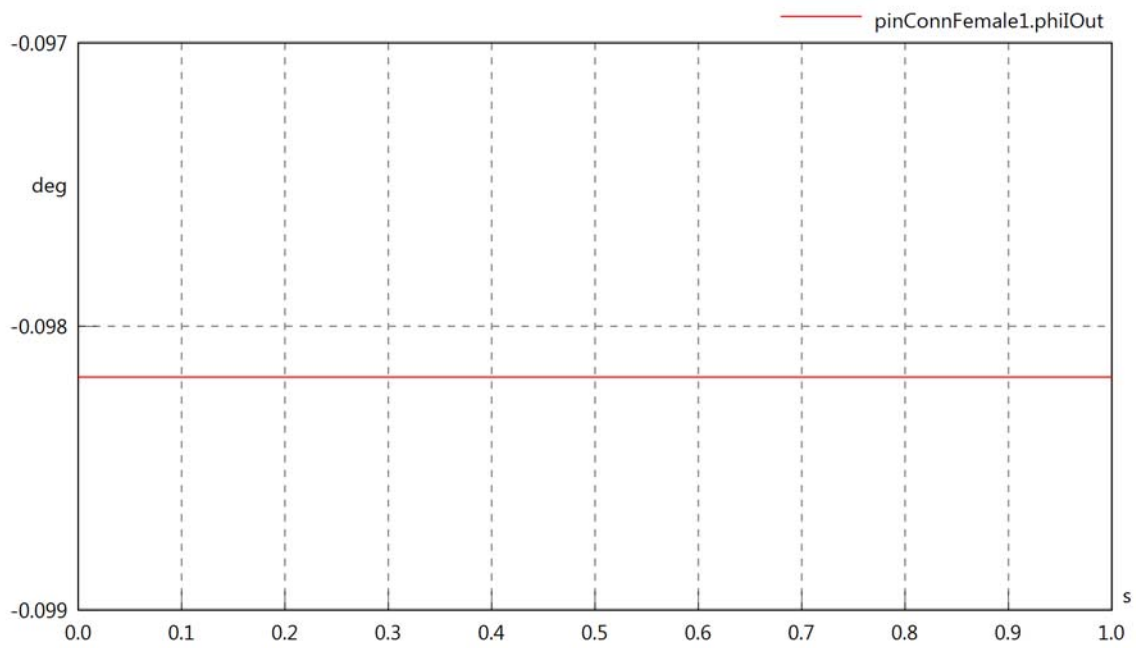

pinConnFemale1.phiIVOut

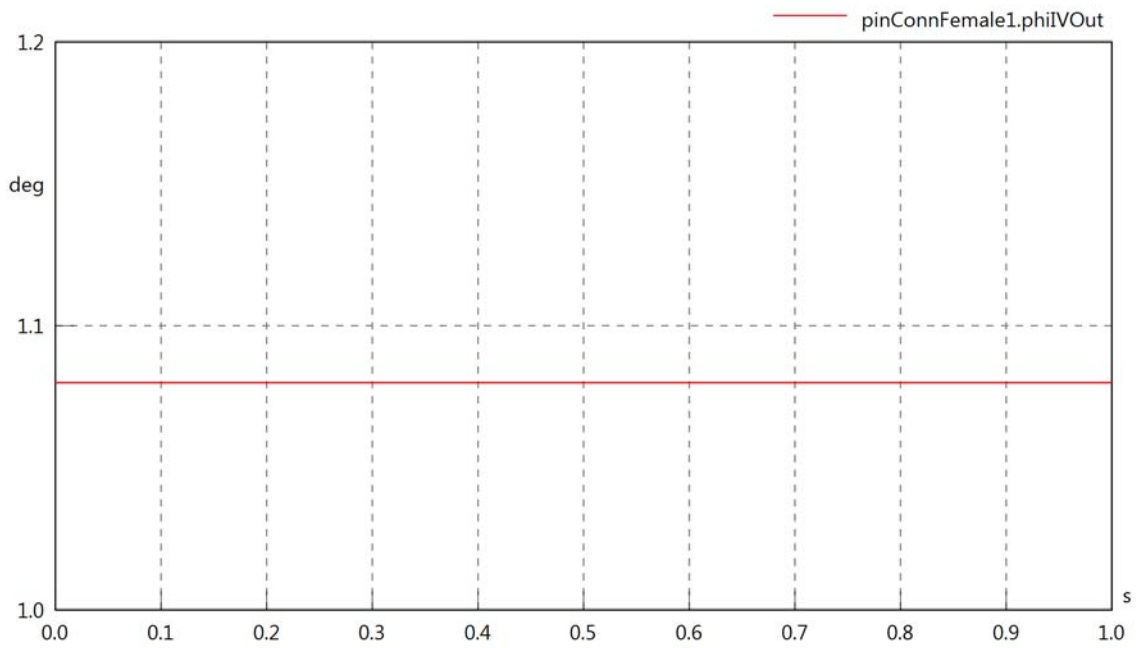

pinConnFemale1.PReIn

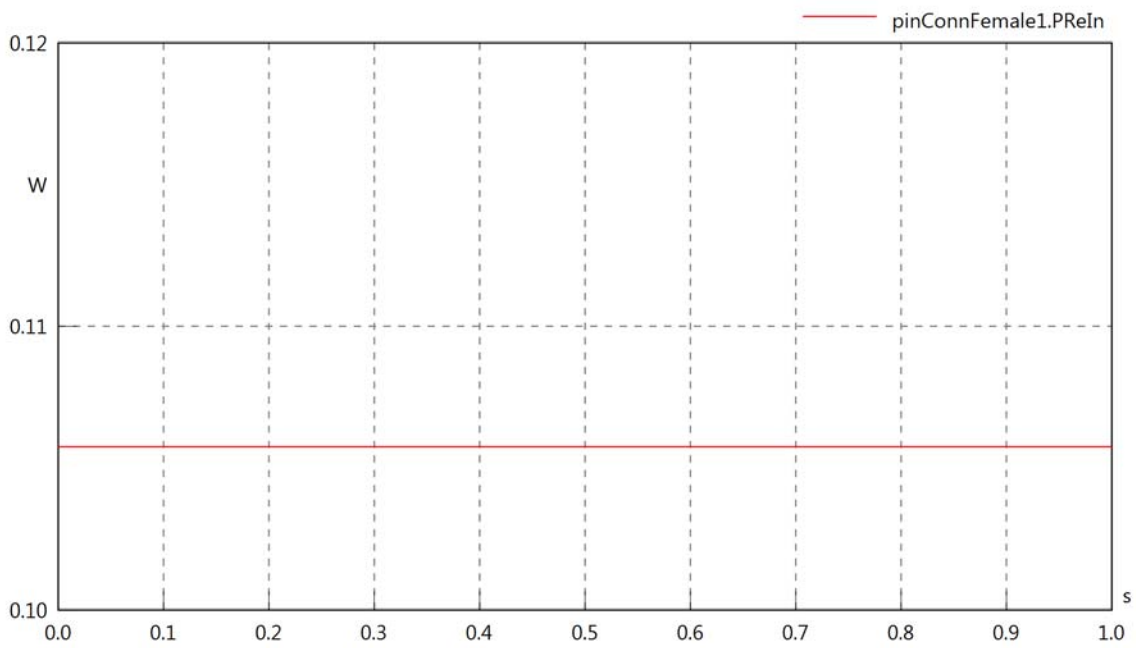

pinConnFemale1.PImIn

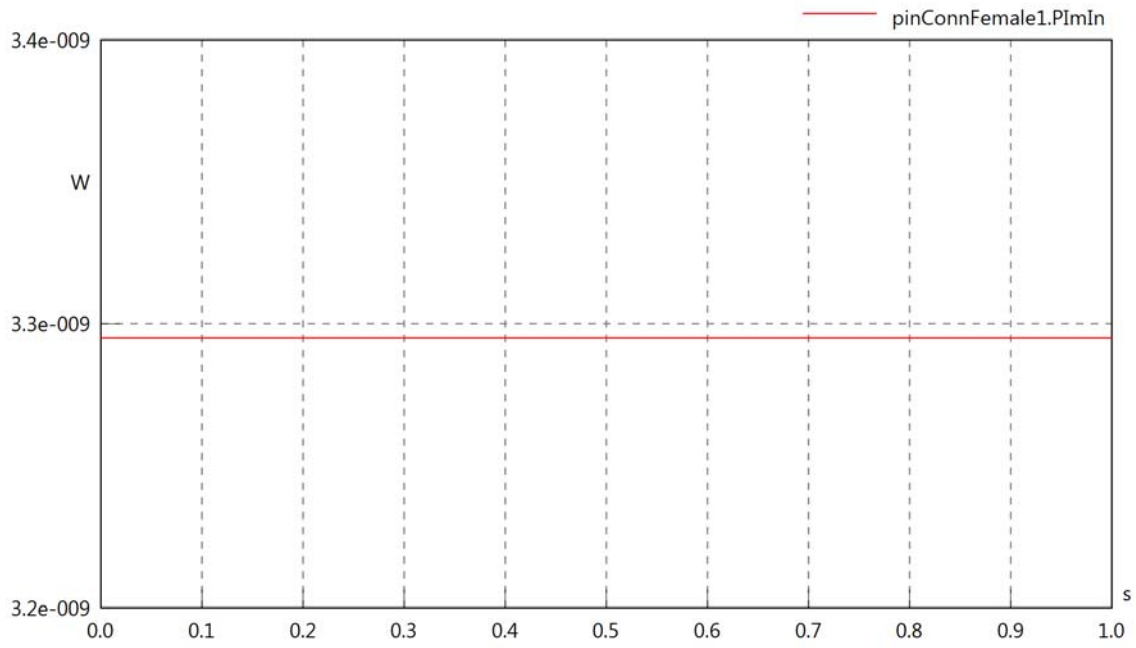

pinConnFemale1.SIn

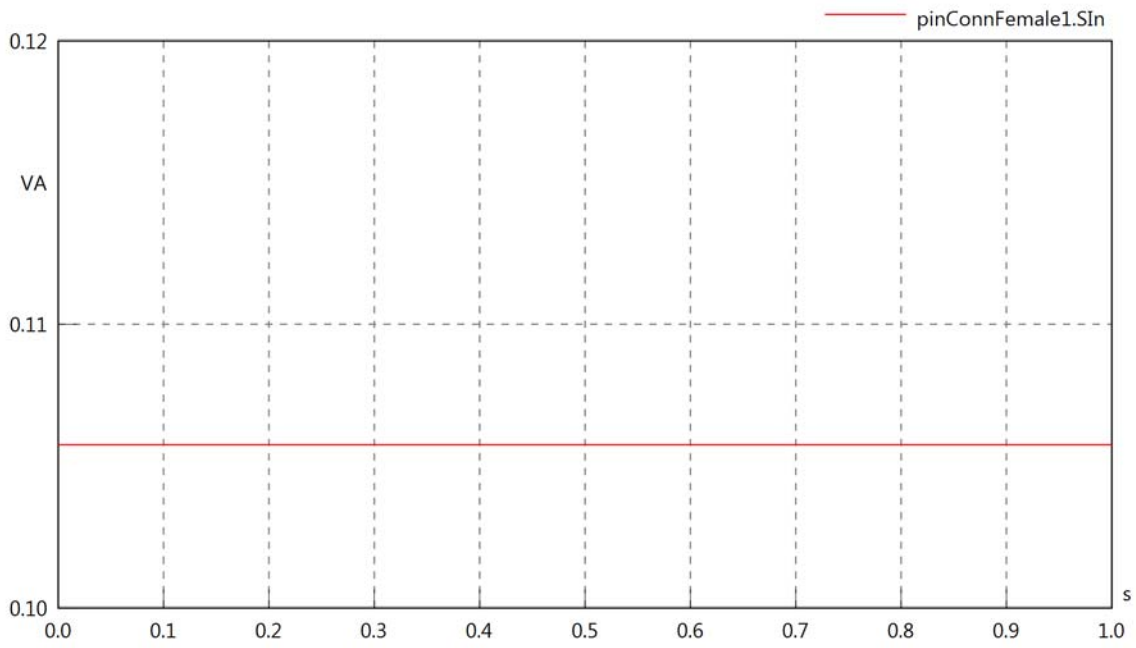

pinConnFemale1.PReOut

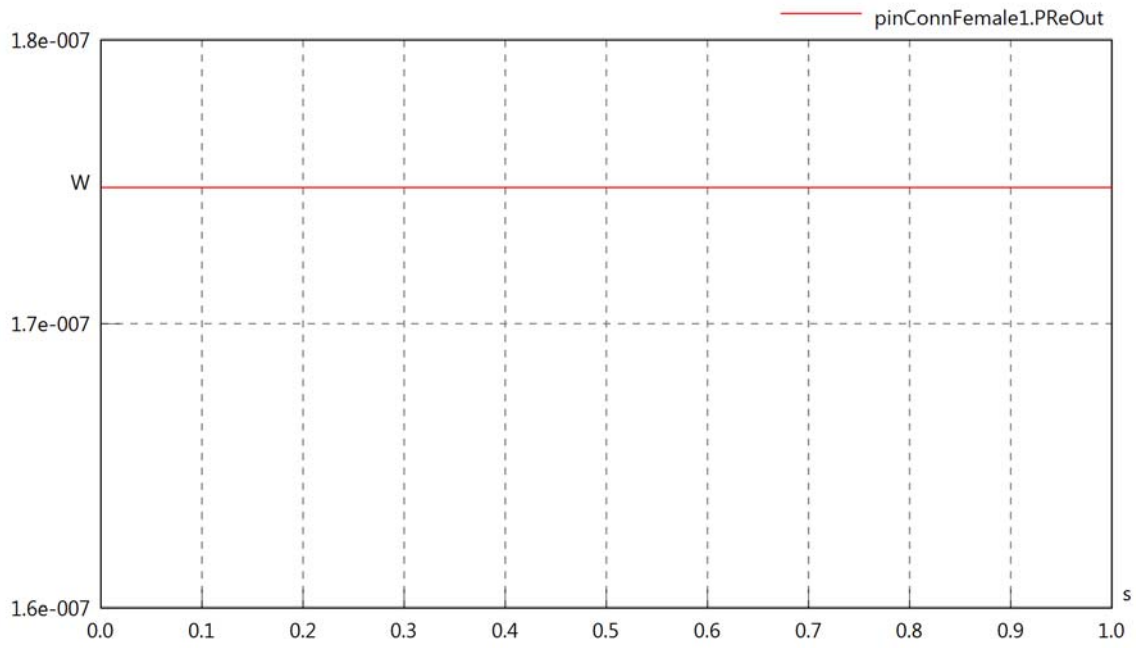

pinConnFemale1.PImOut

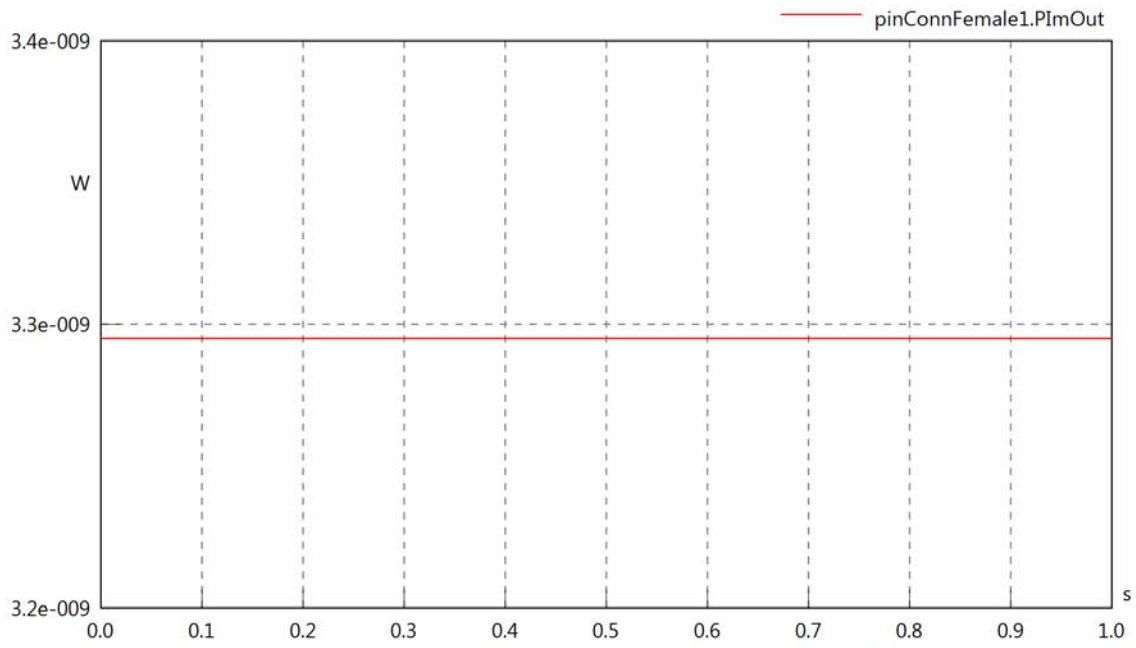

pinConnFemale1.SOut

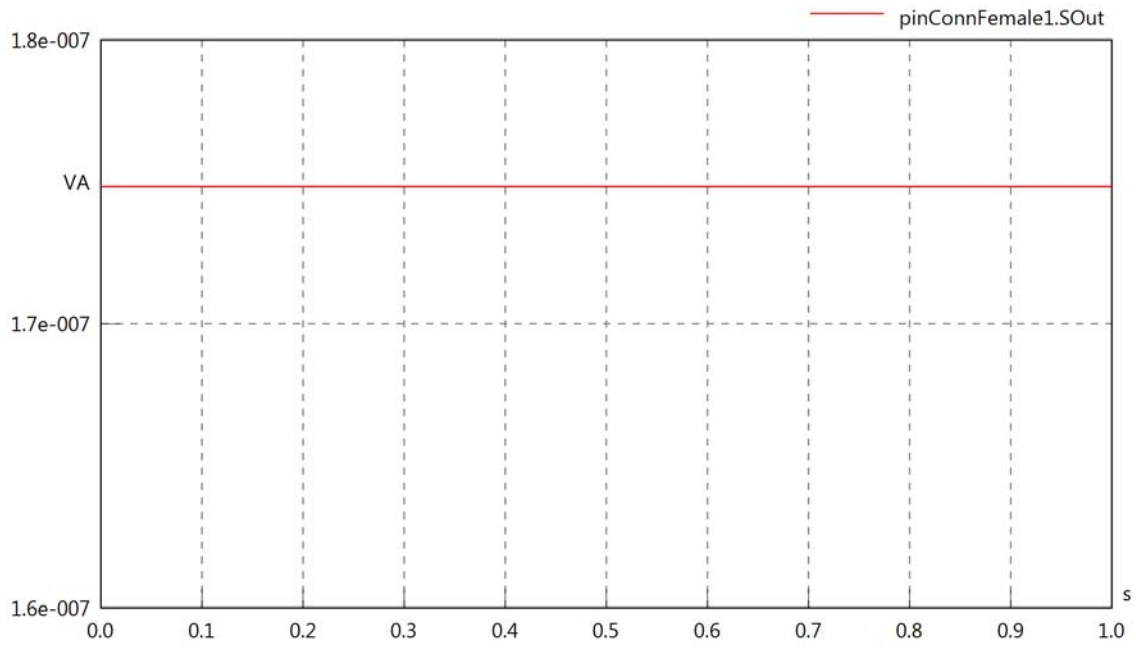
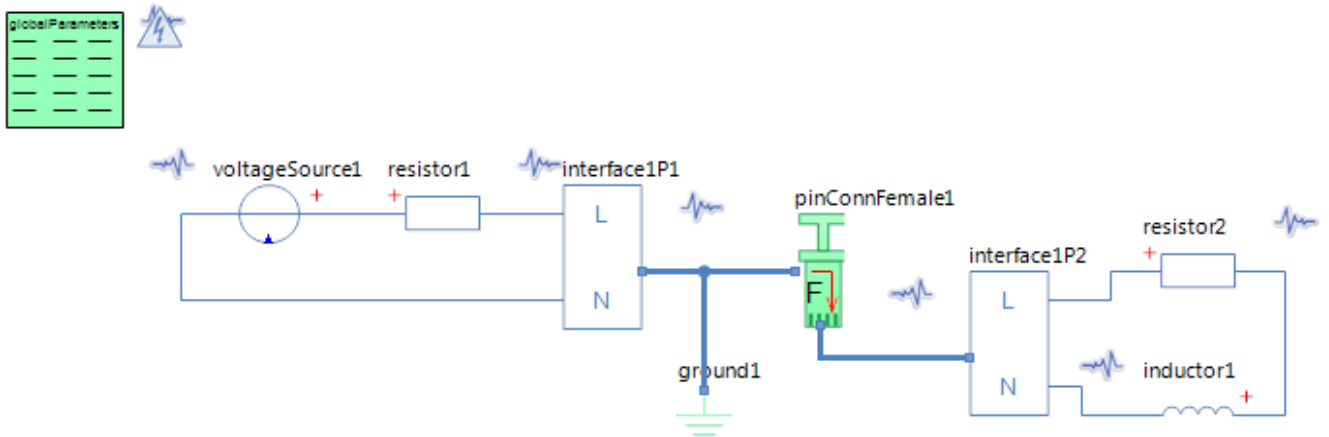

Diagram View



GlobalParameters globalParameters
Parameters

Comment	Name	Current Value	Unit
Type of Calculation	eCalculationKind	Signal Calculation	
Description of Frequency	eFrequencyKind	Linear	
Minimum Frequency	fMin	4000	[Hz]
Maximum Frequency	fMax	4000	[Hz]

Voltage Source voltageSource1
Parameters

Comment	Name	Current Value	Unit
Voltage RMS	VrmsSrc	230	[V]
Phase	phi	0	[deg]

Resistor resistor1
Parameters

Comment	Name	Current Value	Unit
Resistance	R	100	[Ohm]

Resistor resistor2
Parameters

Comment	Name	Current Value	Unit
Resistance	R	100	[Ohm]

Inductor inductor1
Parameters

Comment	Name	Current Value	Unit
Inductance	L	5	[mH]

Pin Connector Female pinConnFemale1
Parameters

Comment	Name	Current Value	Unit
Poor or failing L1 connection	bL1	true	
Resistance in L1 connection	rL1	1	[kOhm]
Conductance between L1 and N	G	50	[1/Ohm]

pinConnFemale1.VrmsIn

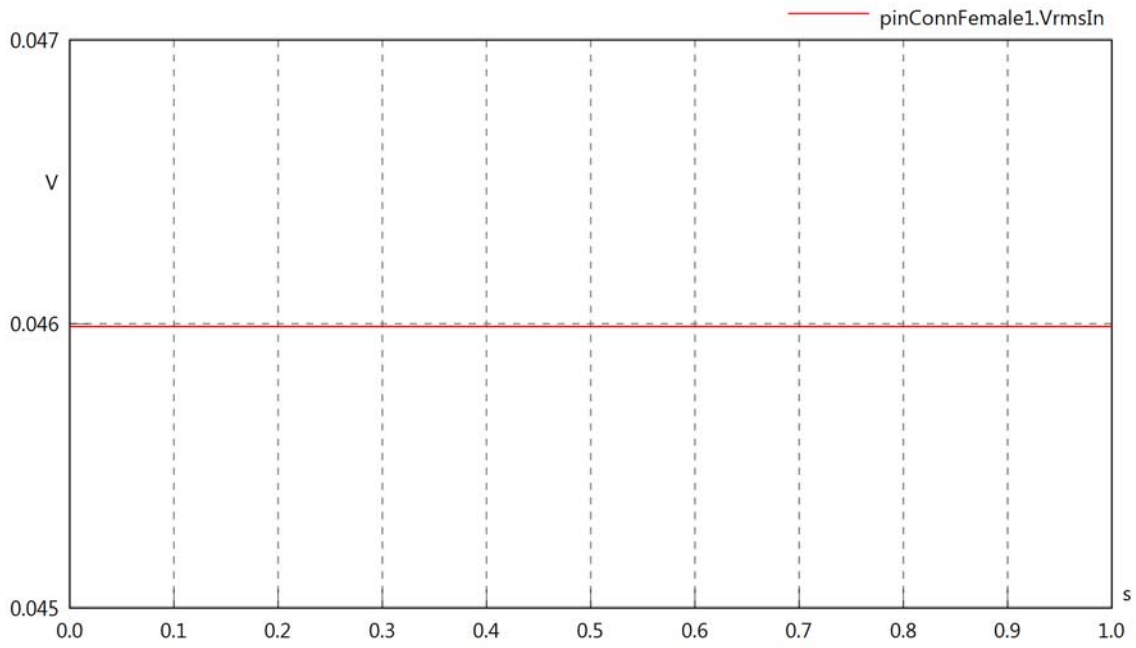

pinConnFemale1.vReIn

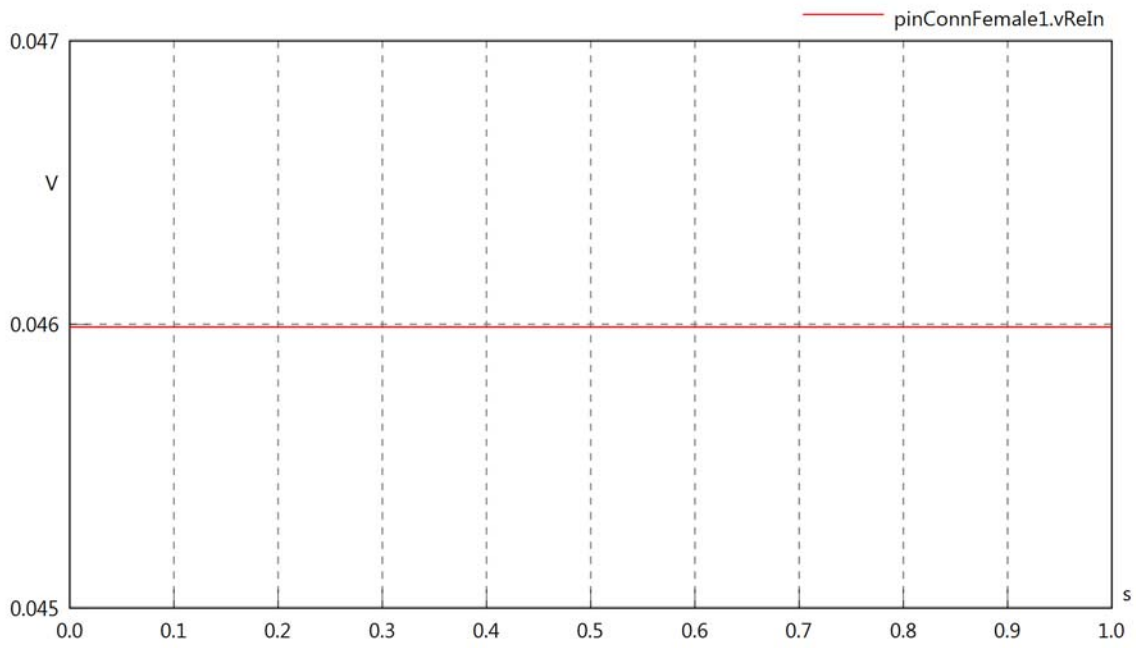

pinConnFemale1.vImIn

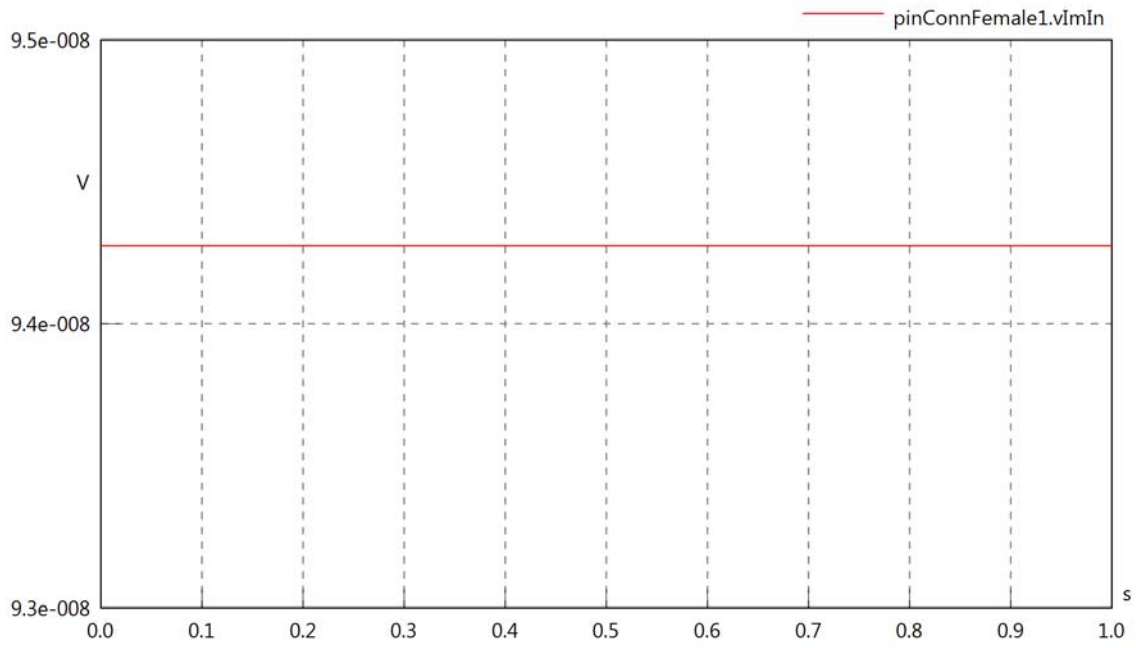

pinConnFemale1.VrmsOut

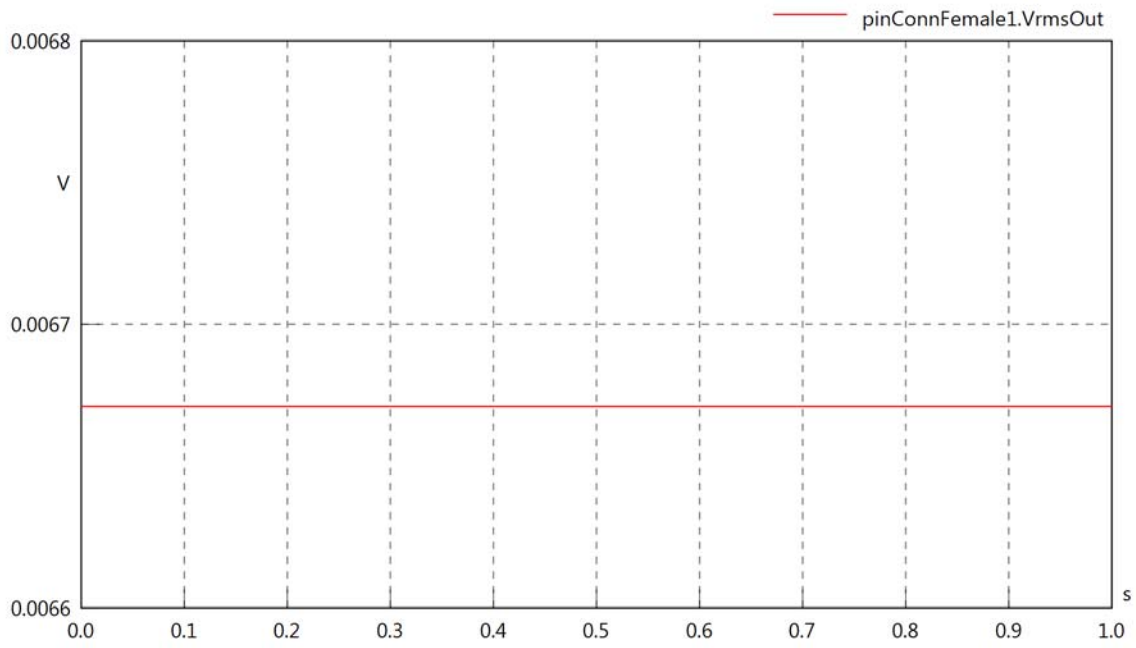

pinConnFemale1.vReOut

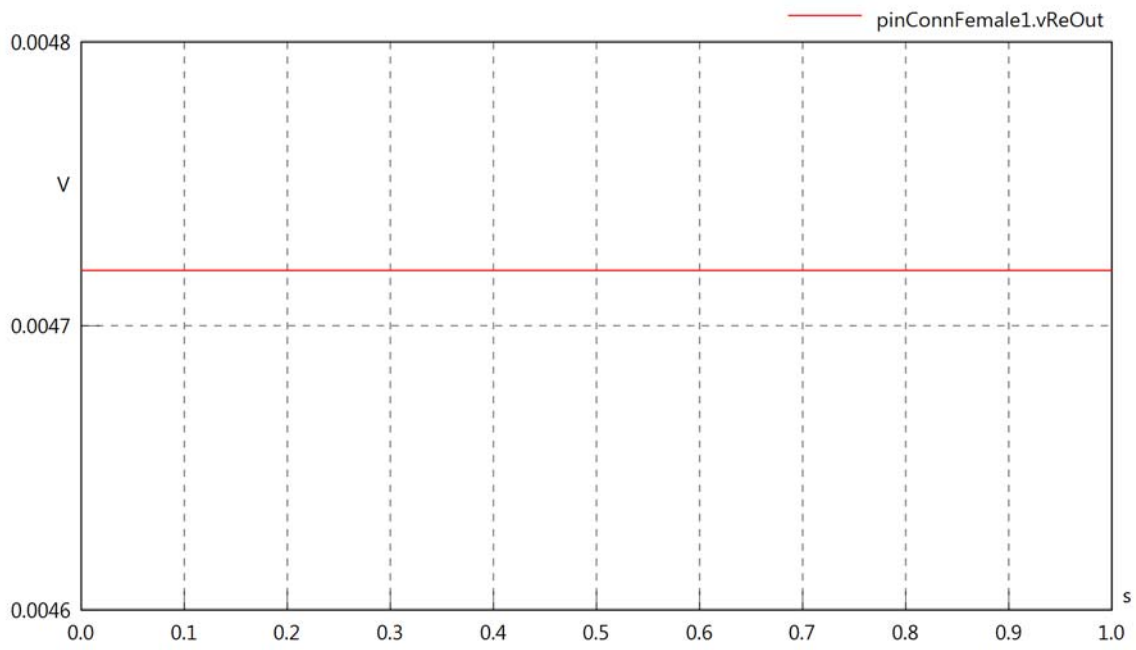

pinConnFemale1.vImOut

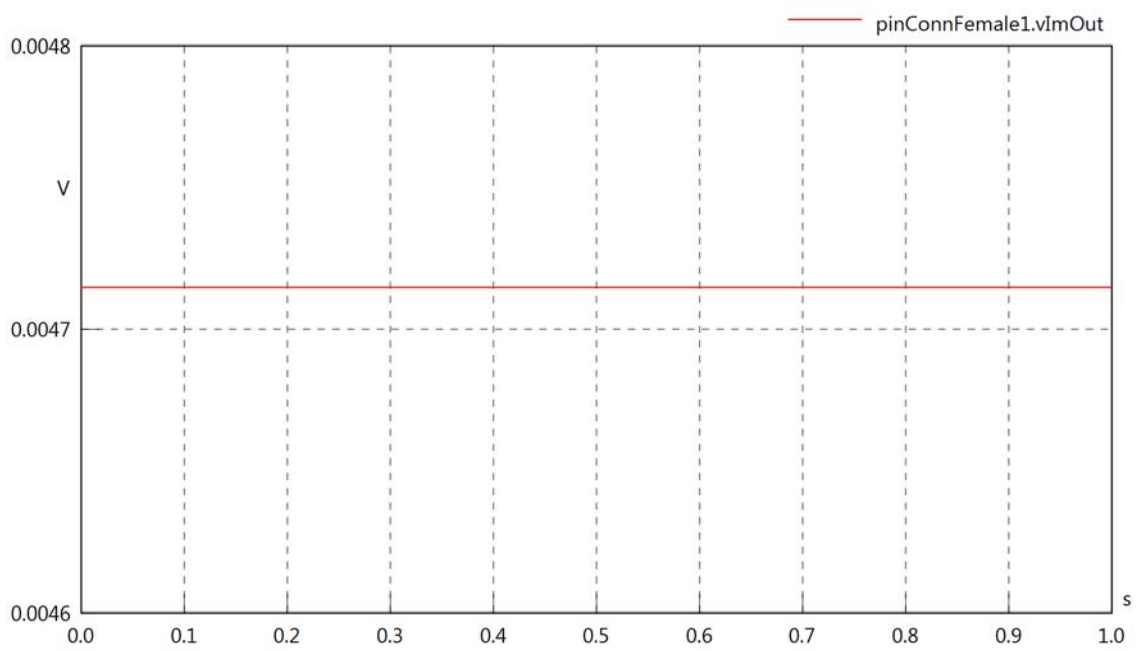

pinConnFemale1.Vrms

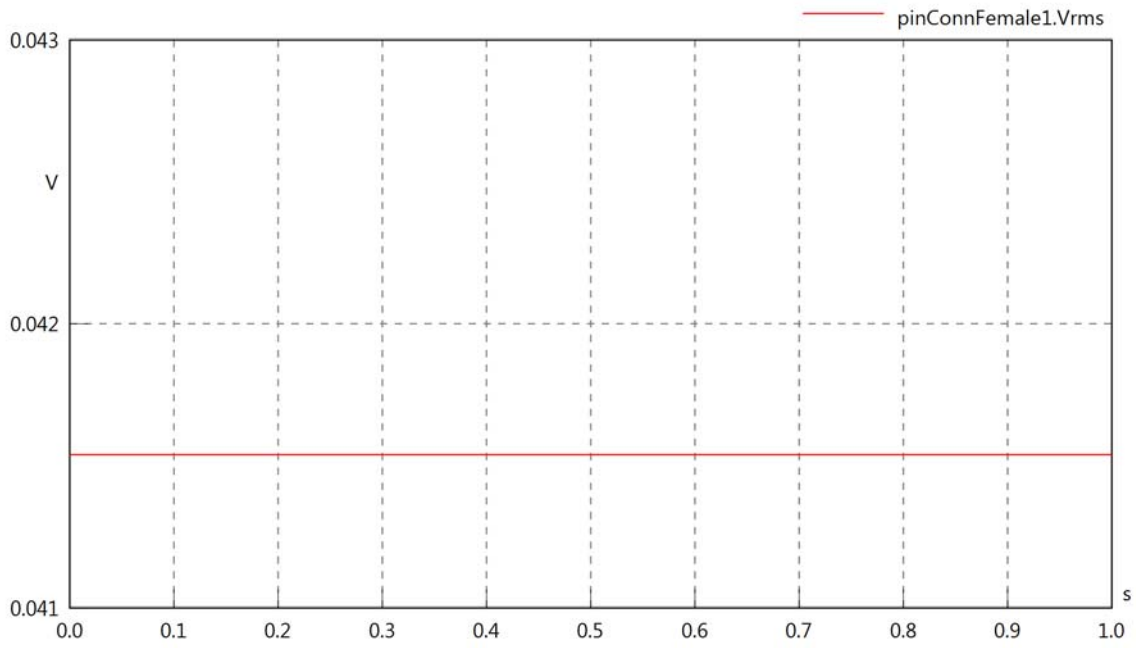

pinConnFemale1.vRe

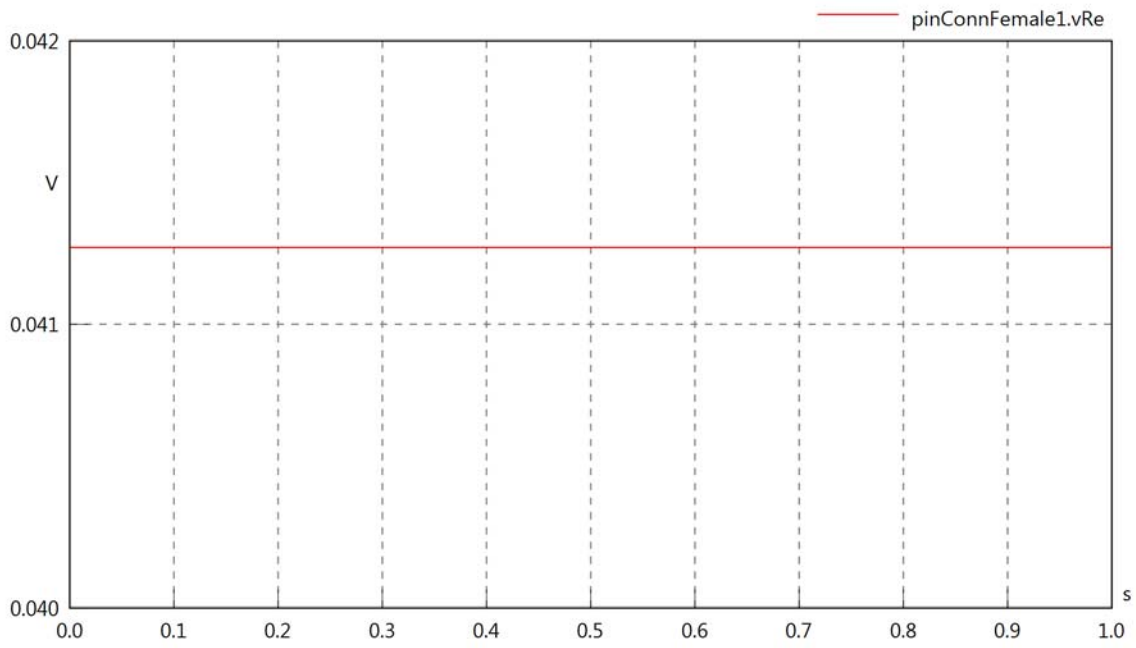

pinConnFemale1.vIm

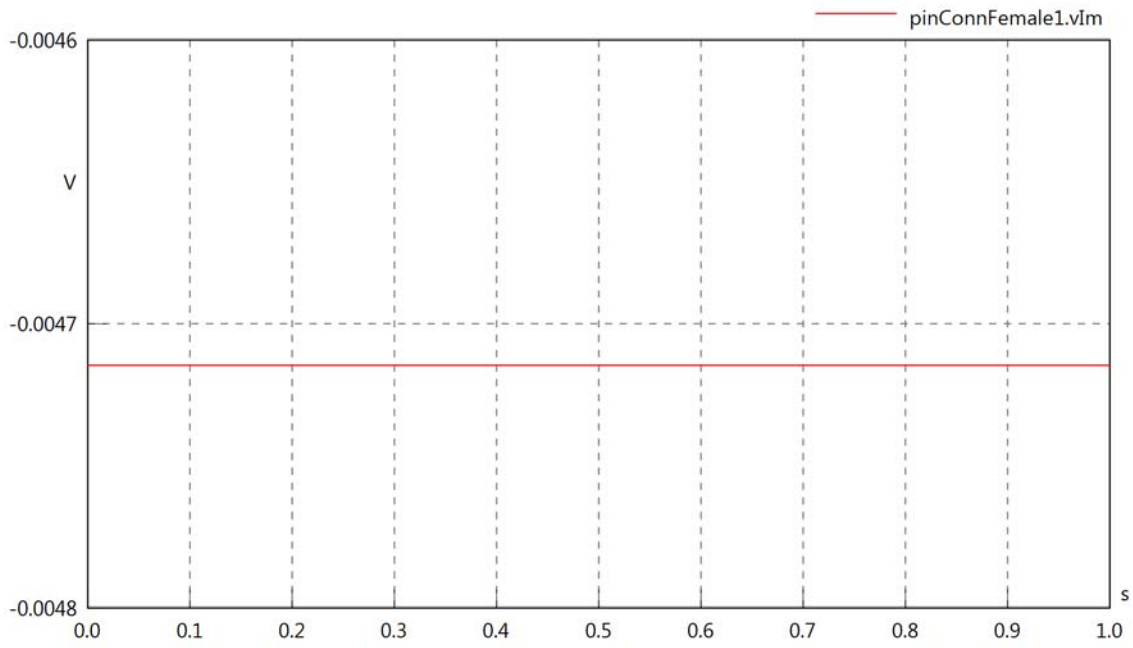

pinConnFemale1.IrmsIn

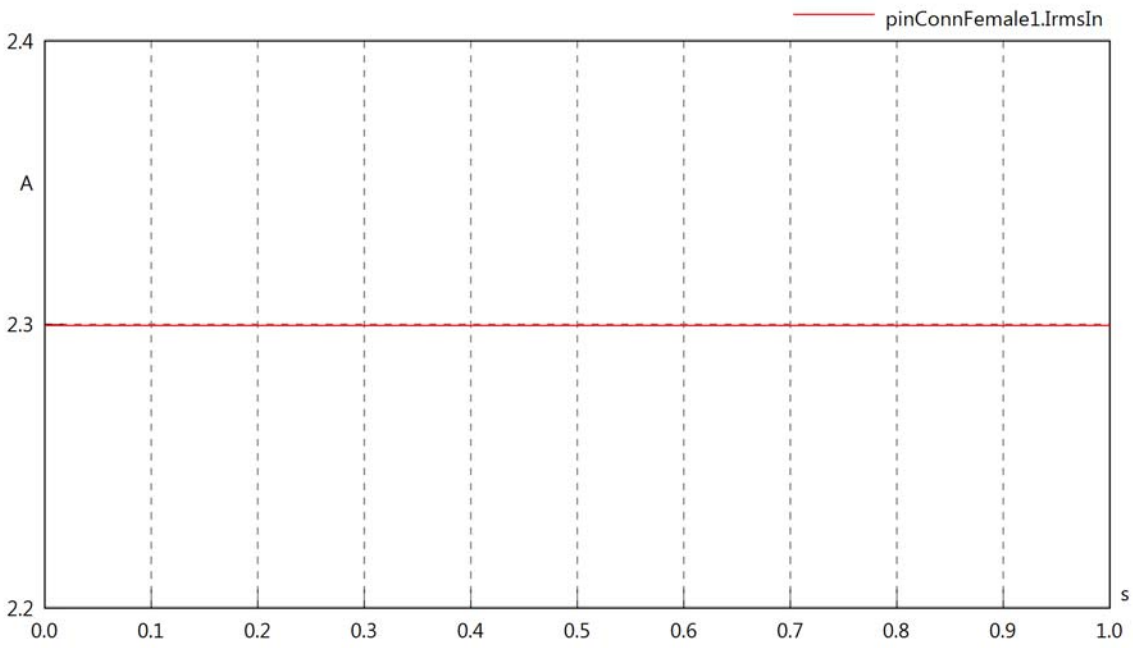

pinConnFemale1.iReIn

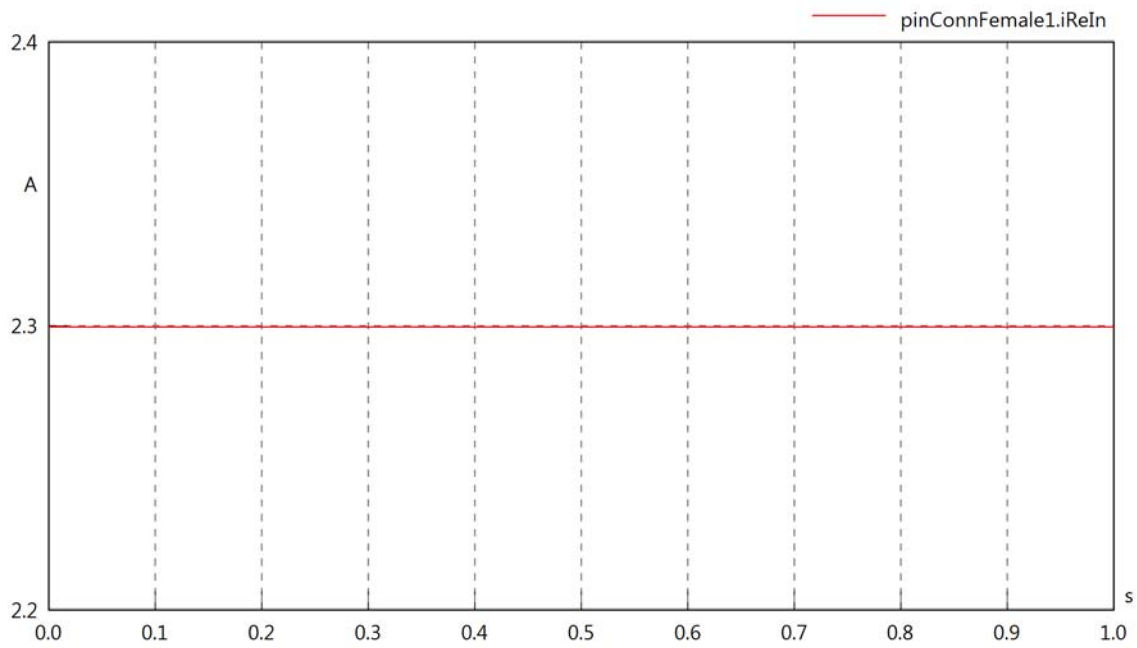

pinConnFemale1.iImIn

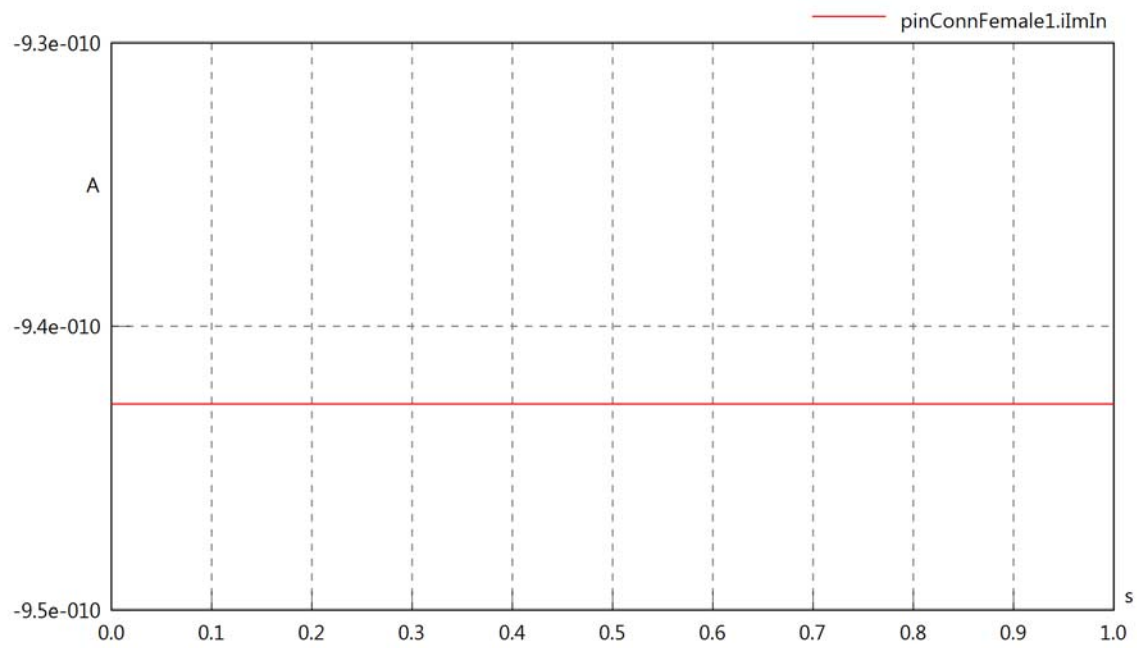

pinConnFemale1.IrmsOut

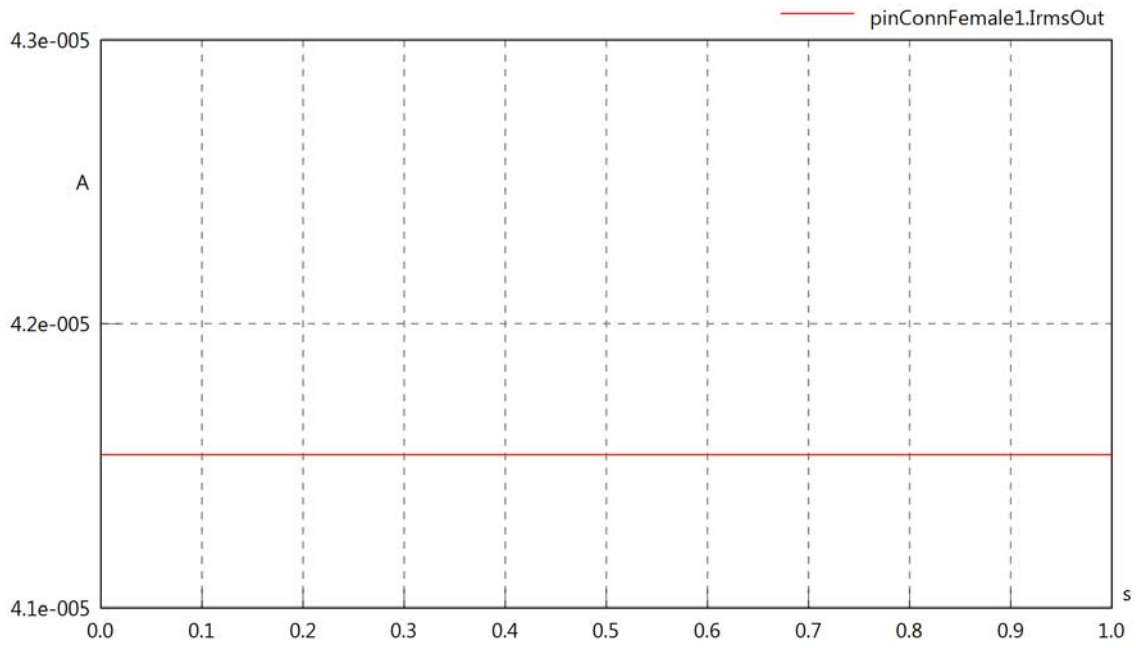

pinConnFemale1.iReOut

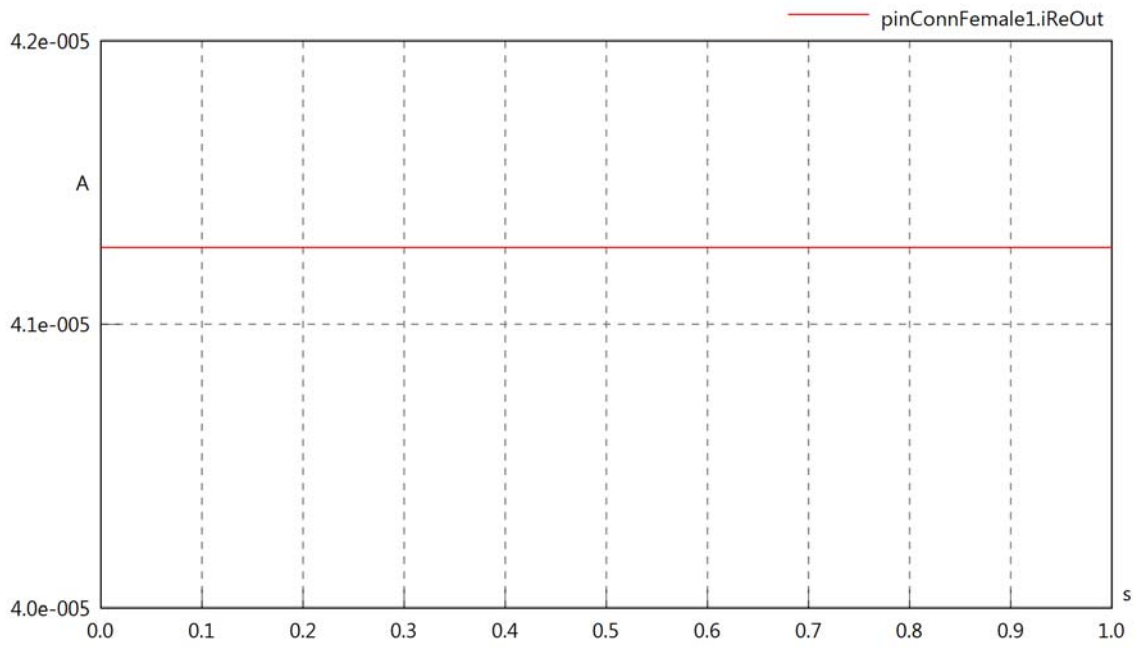

pinConnFemale1.iImOut

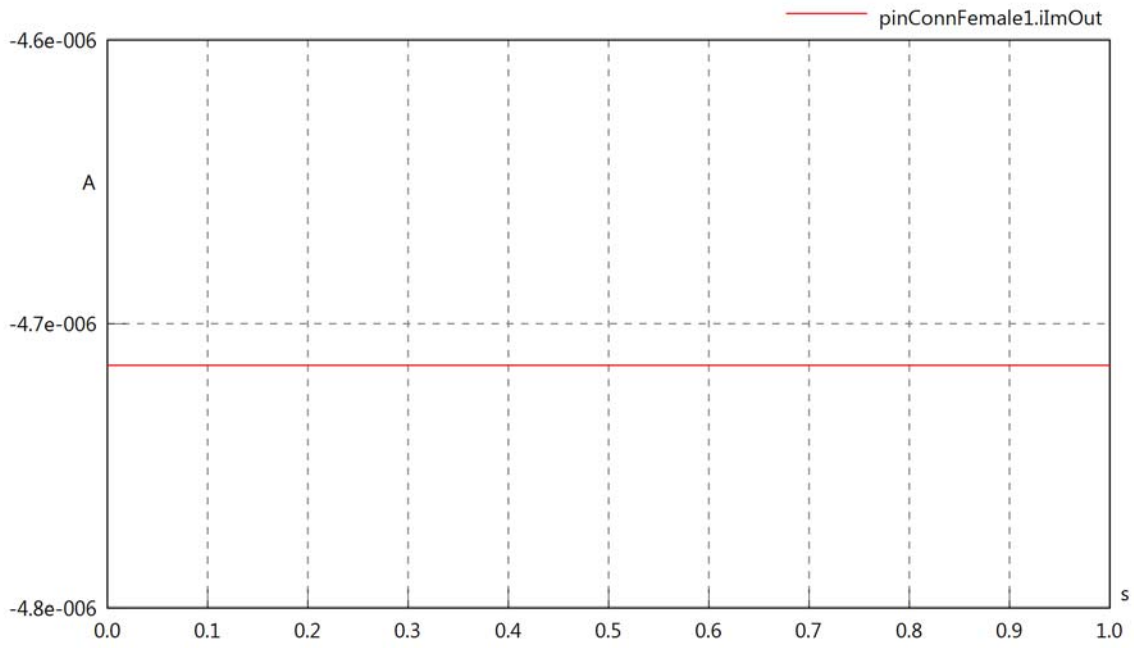

pinConnFemale1.phiVIn

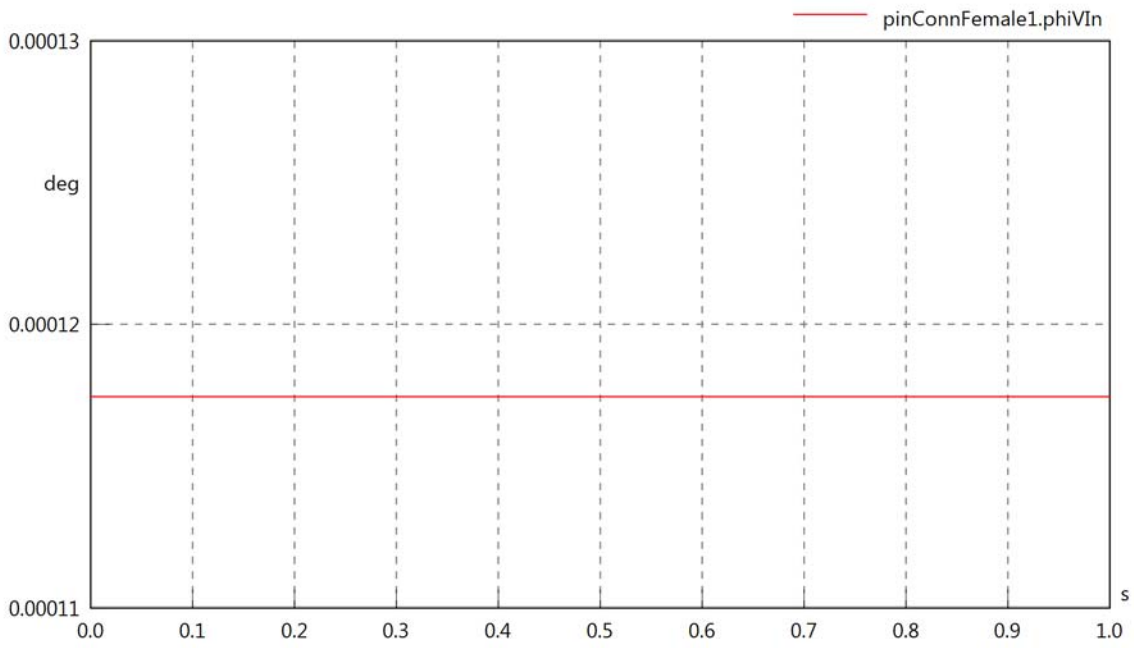

pinConnFemale1.phiIIIn

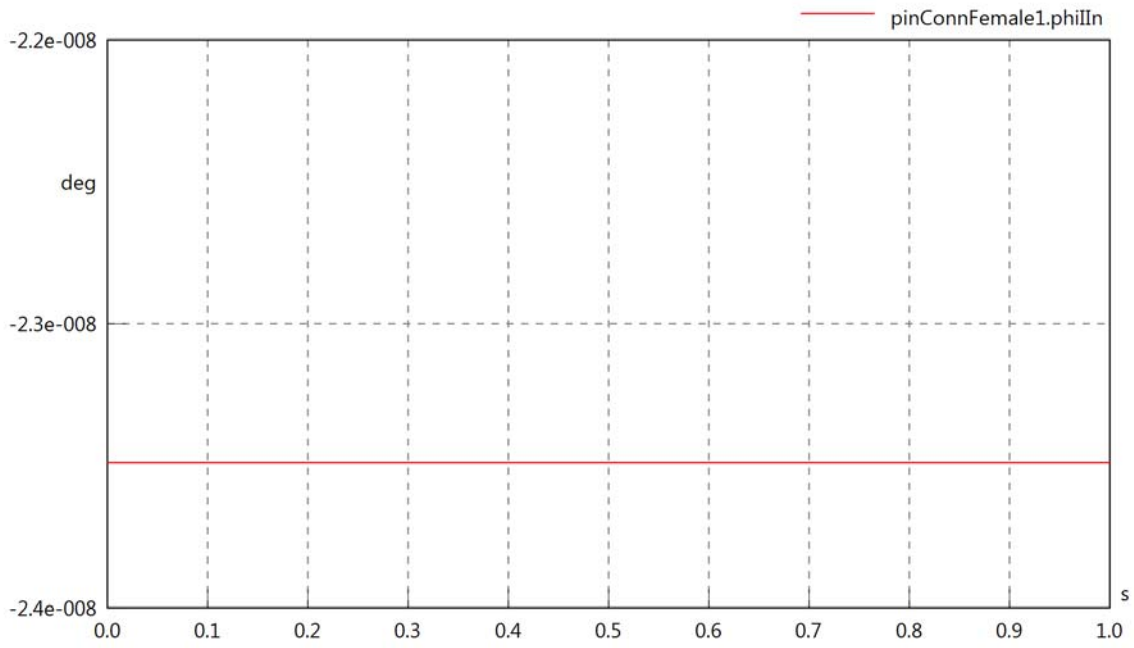

pinConnFemale1.phiIVIn

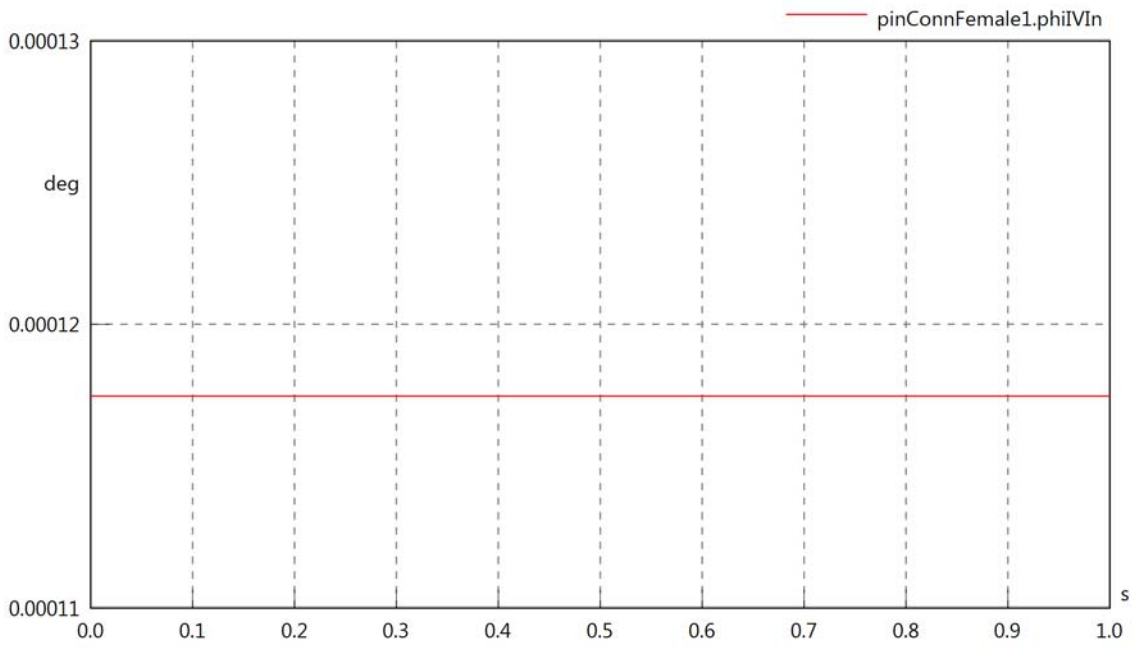

pinConnFemale1.phiVOut

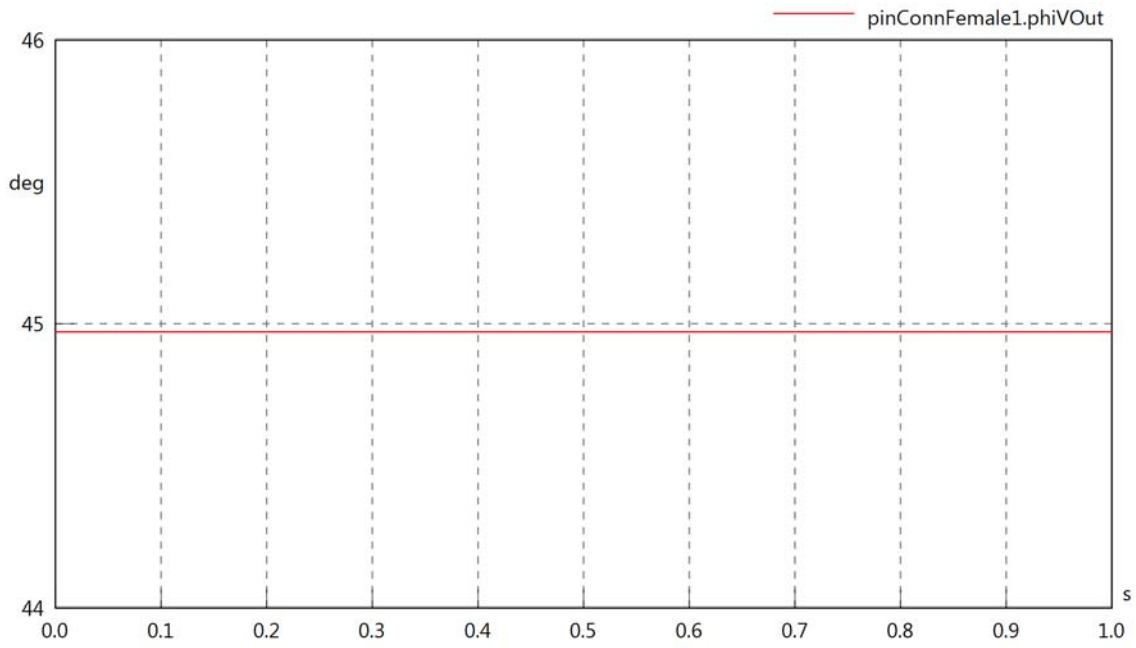

pinConnFemale1.phiIOut

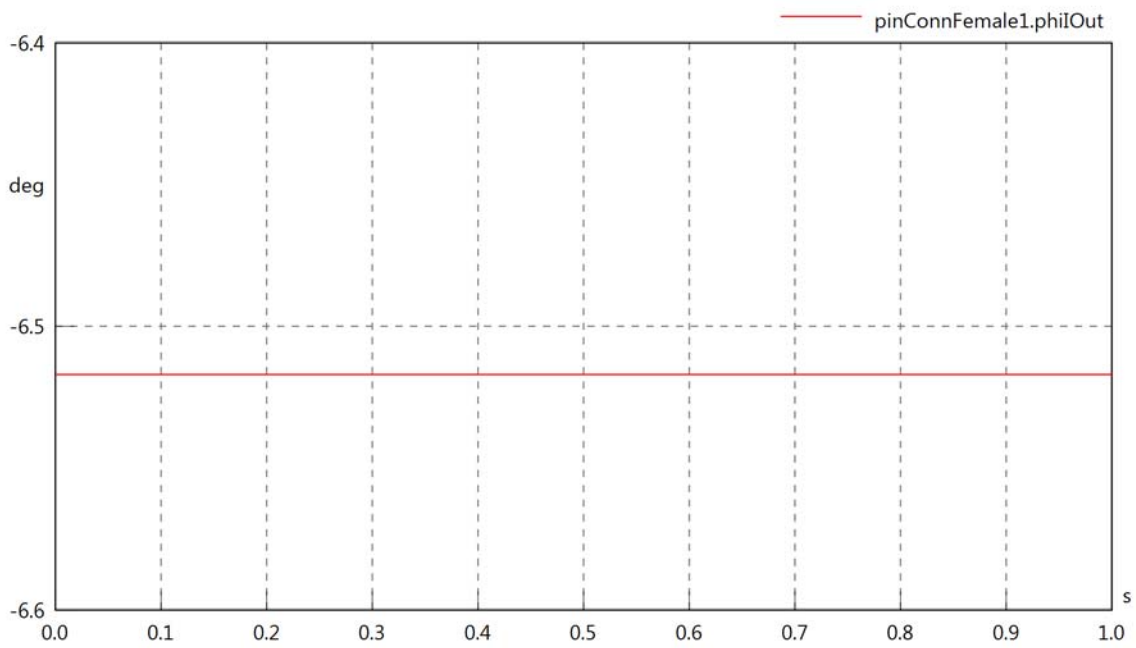

pinConnFemale1.phiIVOut

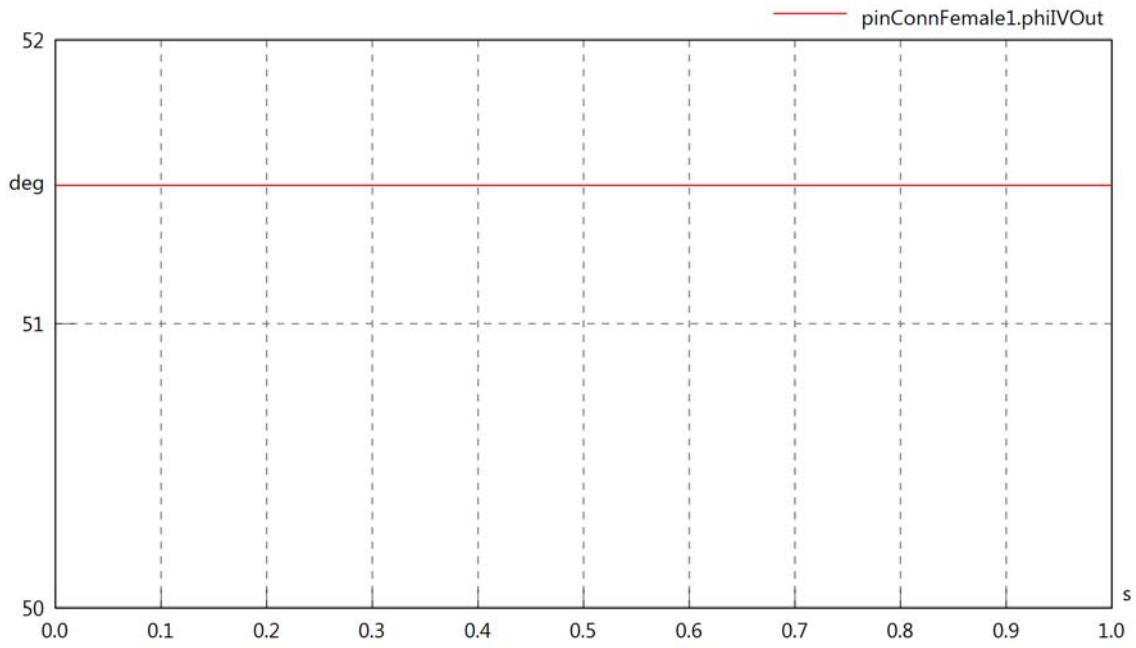

pinConnFemale1.PReIn

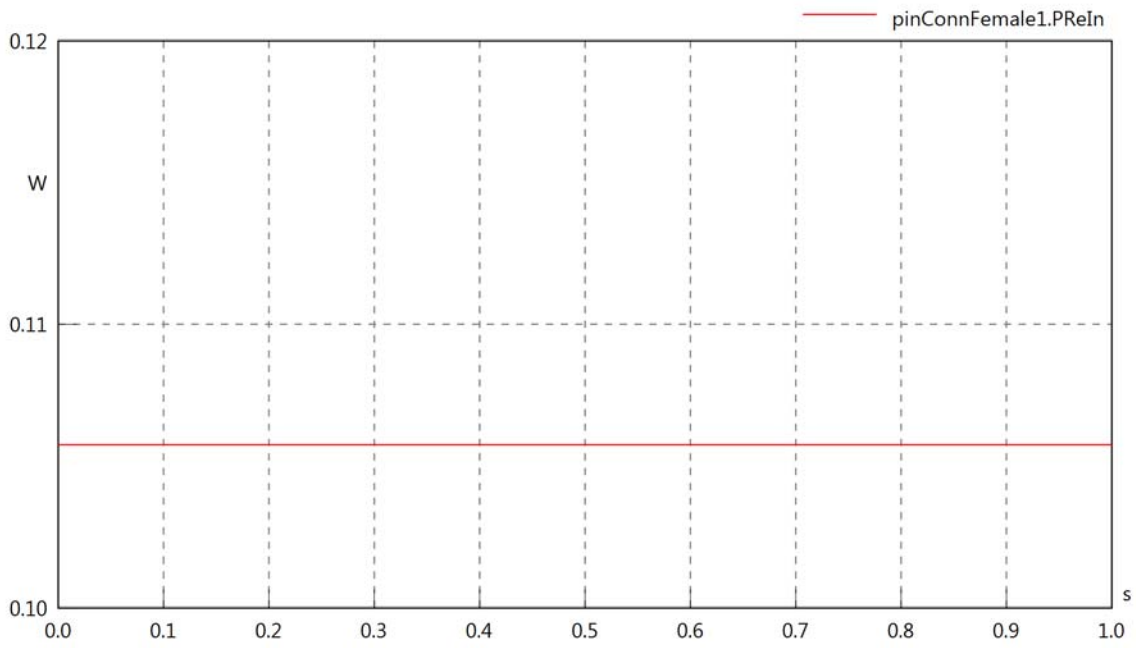

pinConnFemale1.PImIn

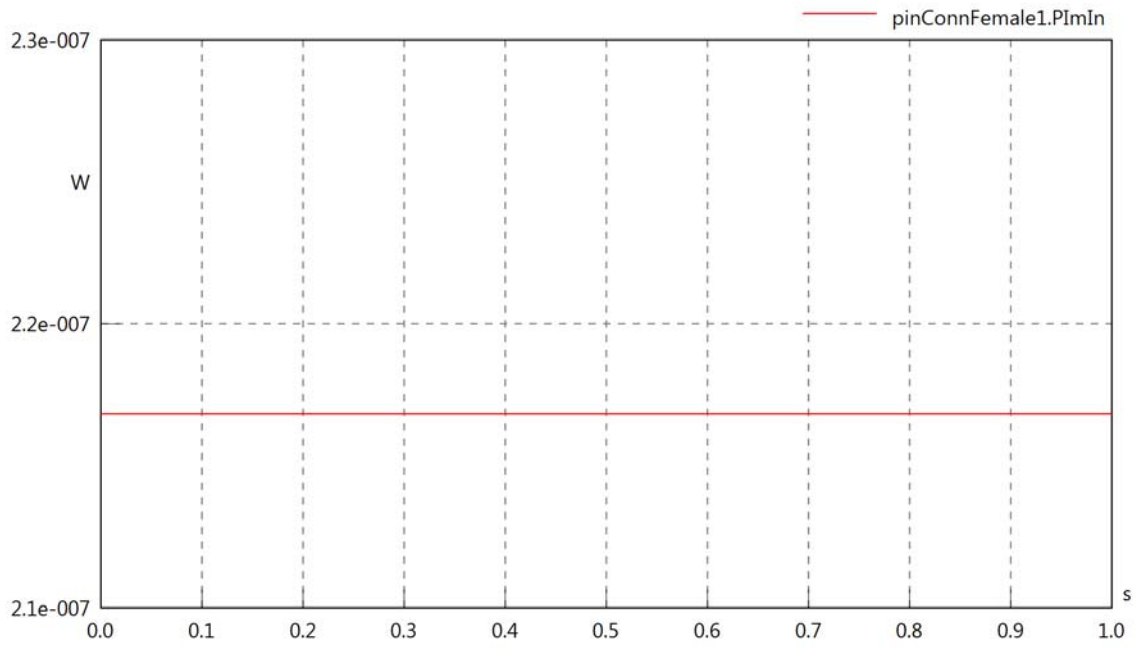

pinConnFemale1.SIn

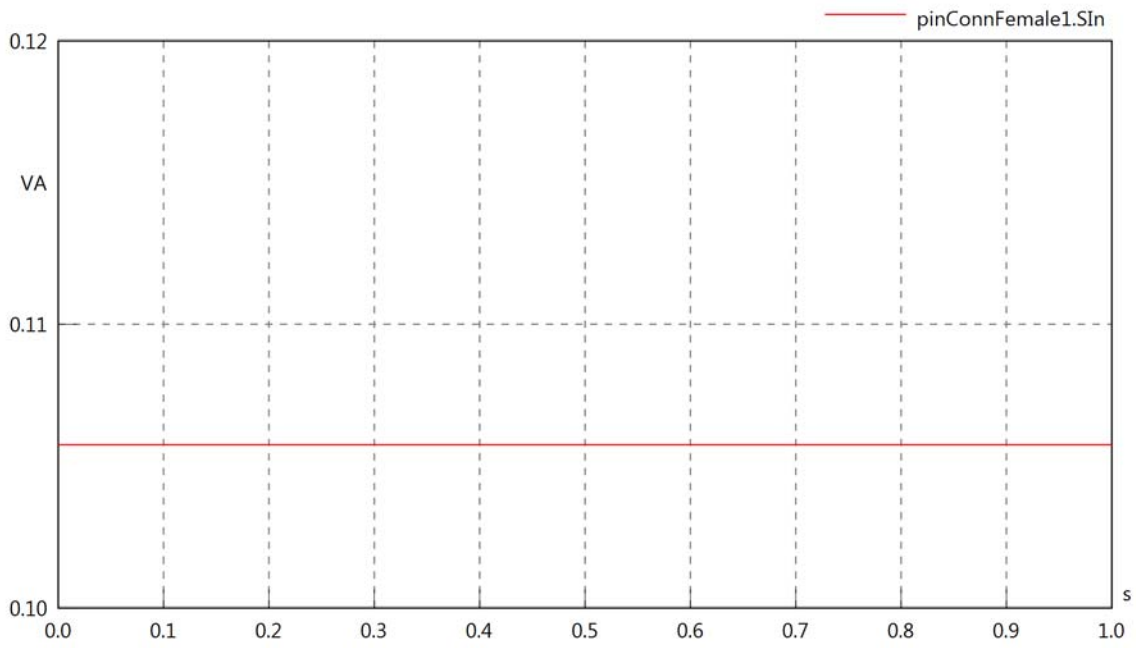

pinConnFemale1.PReOut

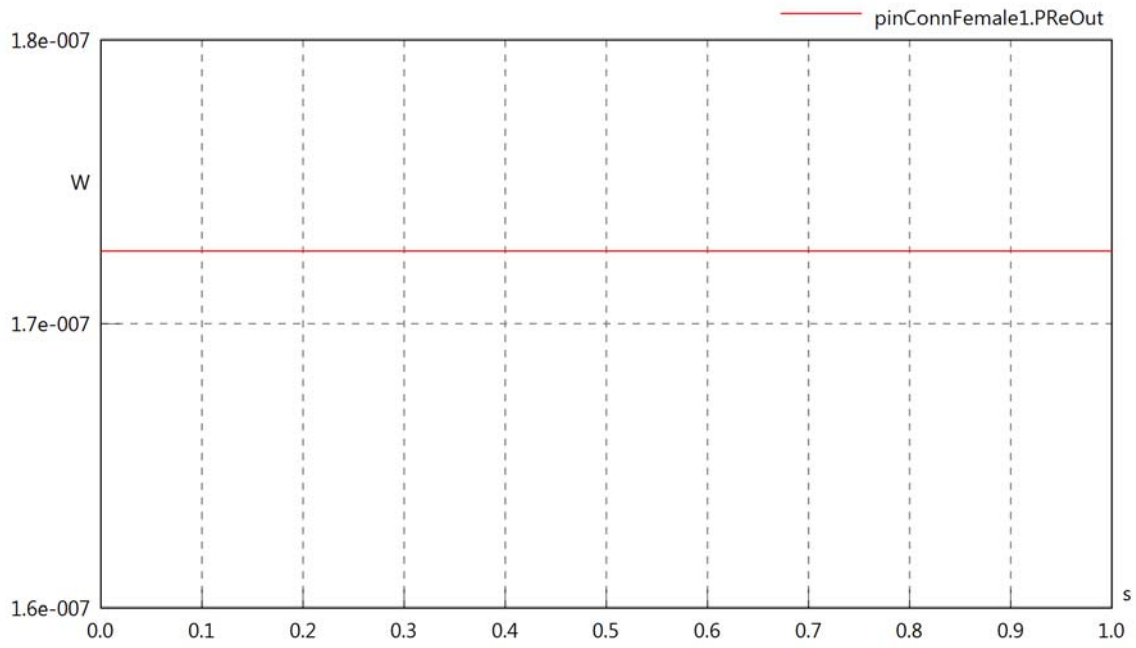

pinConnFemale1.PImOut

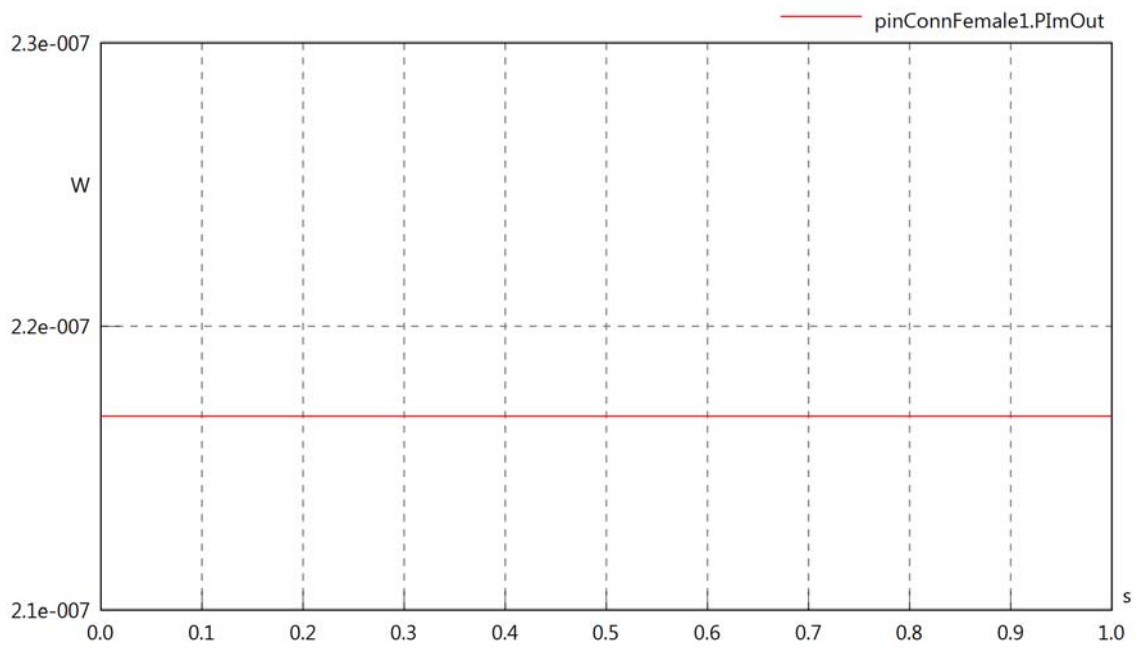

pinConnFemale1.SOut

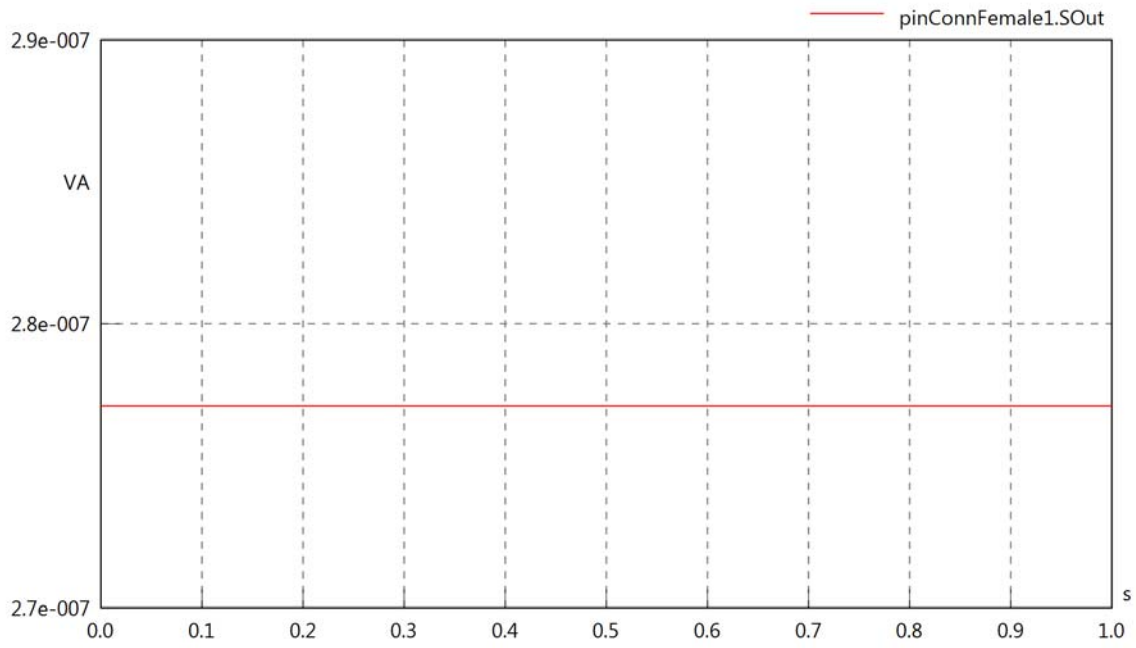
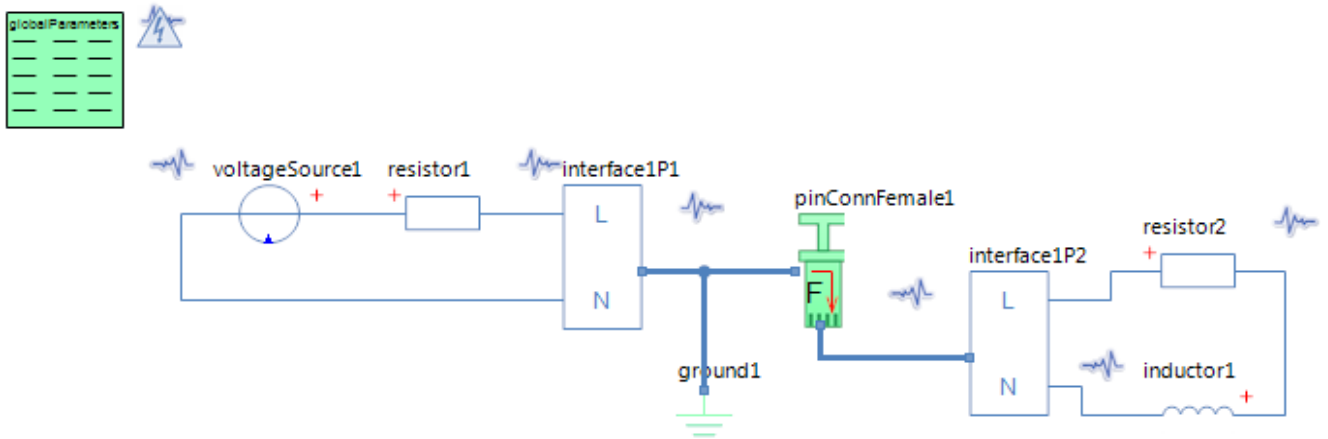

Diagram View



GlobalParameters globalParameters
Parameters

Comment	Name	Current Value	Unit
Type of Calculation	eCalculationKind	Signal Calculation	
Description of Frequency	eFrequencyKind	Linear	
Minimum Frequency	fMin	20000	[Hz]
Maximum Frequency	fMax	20000	[Hz]

Voltage Source voltageSource1
Parameters

Comment	Name	Current Value	Unit
Voltage RMS	VrmsSrc	230	[V]
Phase	phi	0	[deg]

Resistor resistor1
Parameters

Comment	Name	Current Value	Unit
Resistance	R	100	[Ohm]

Resistor resistor2
Parameters

Comment	Name	Current Value	Unit
Resistance	R	100	[Ohm]

Inductor inductor1
Parameters

Comment	Name	Current Value	Unit
Inductance	L	5	[mH]

Pin Connector Female pinConnFemale1
Parameters

Comment	Name	Current Value	Unit
Poor or failing L1 connection	bL1	true	
Resistance in L1 connection	rL1	1	[kOhm]
Conductance between L1 and N	G	50	[1/Ohm]

pinConnFemale1.VrmsIn

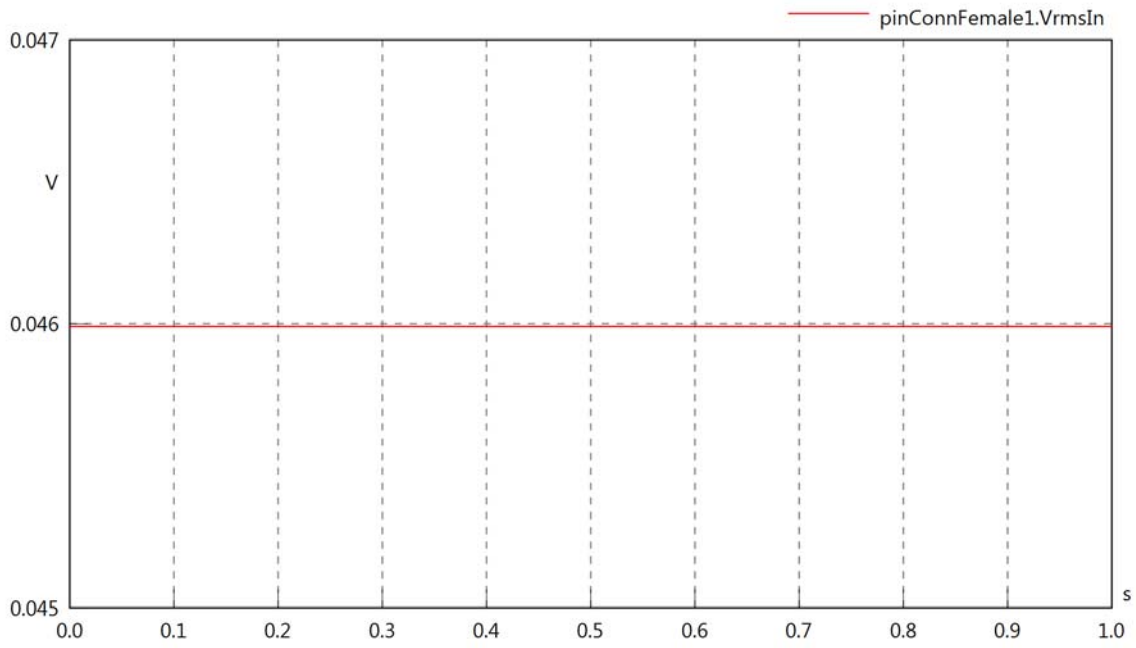

pinConnFemale1.vReIn

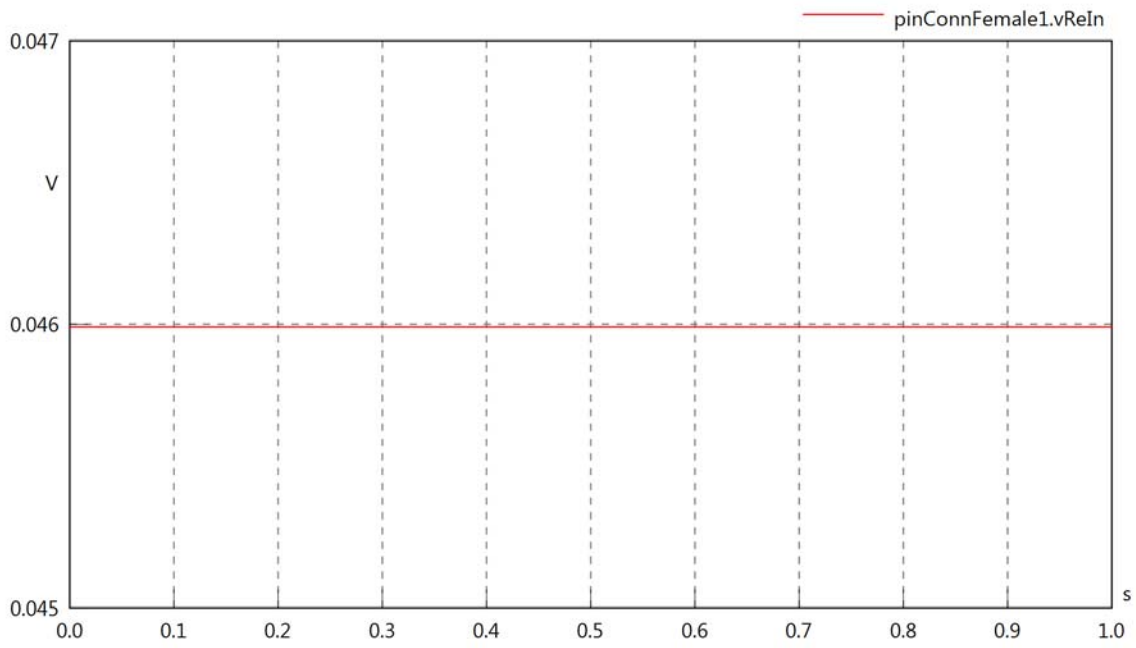

pinConnFemale1.vImIn

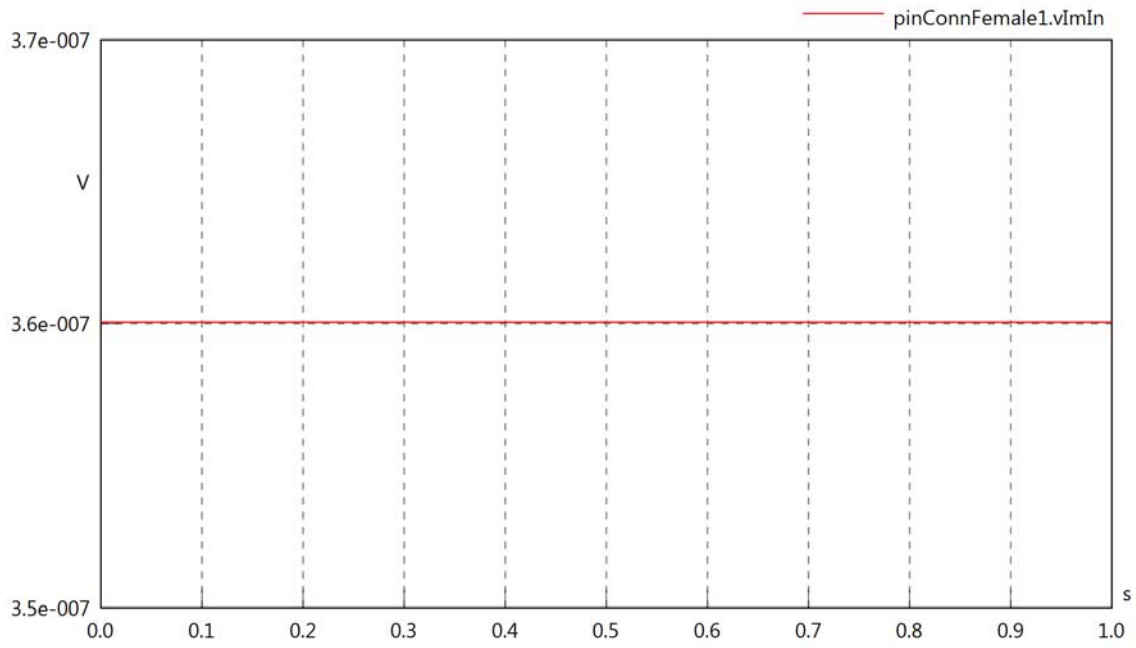

pinConnFemale1.VrmsOut

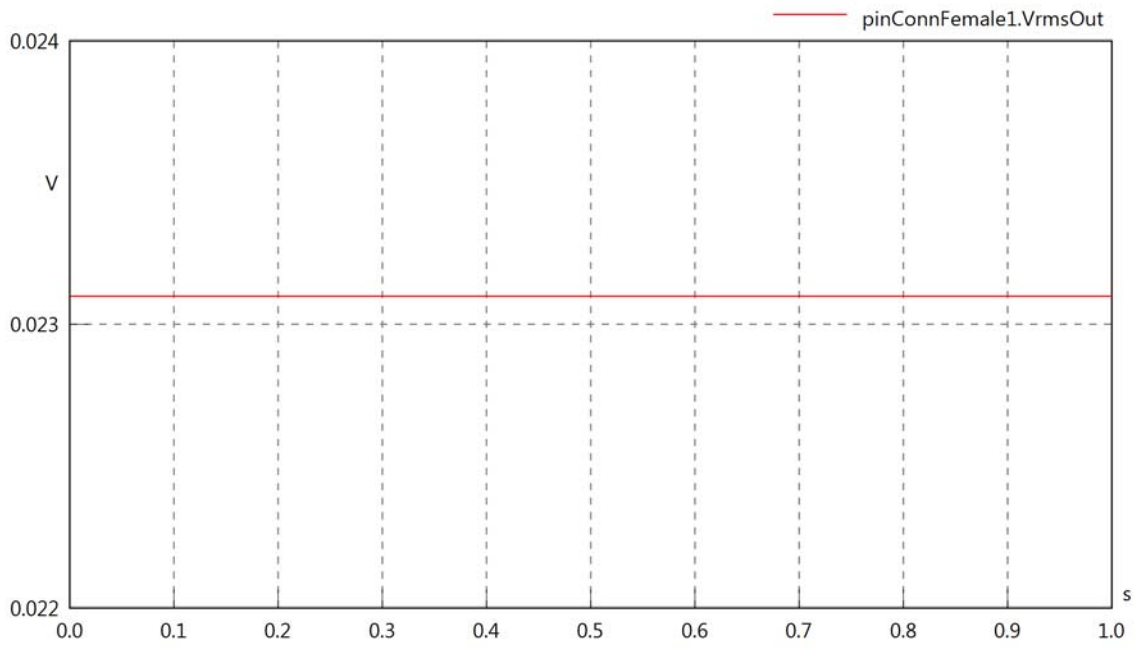

pinConnFemale1.vReOut

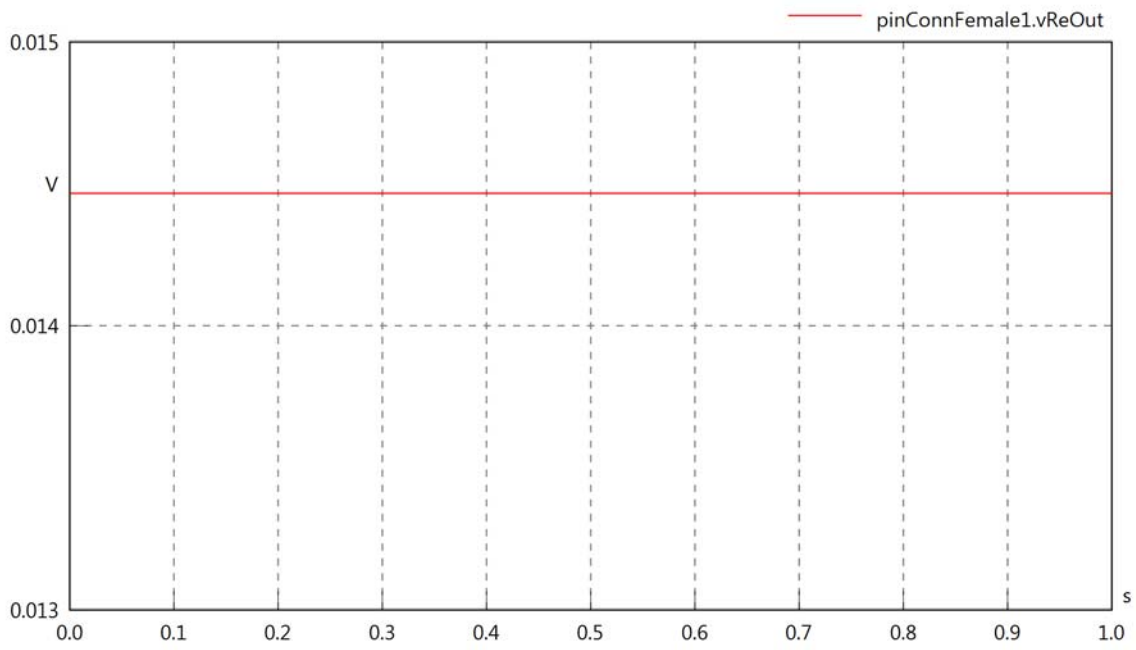

pinConnFemale1.vImOut

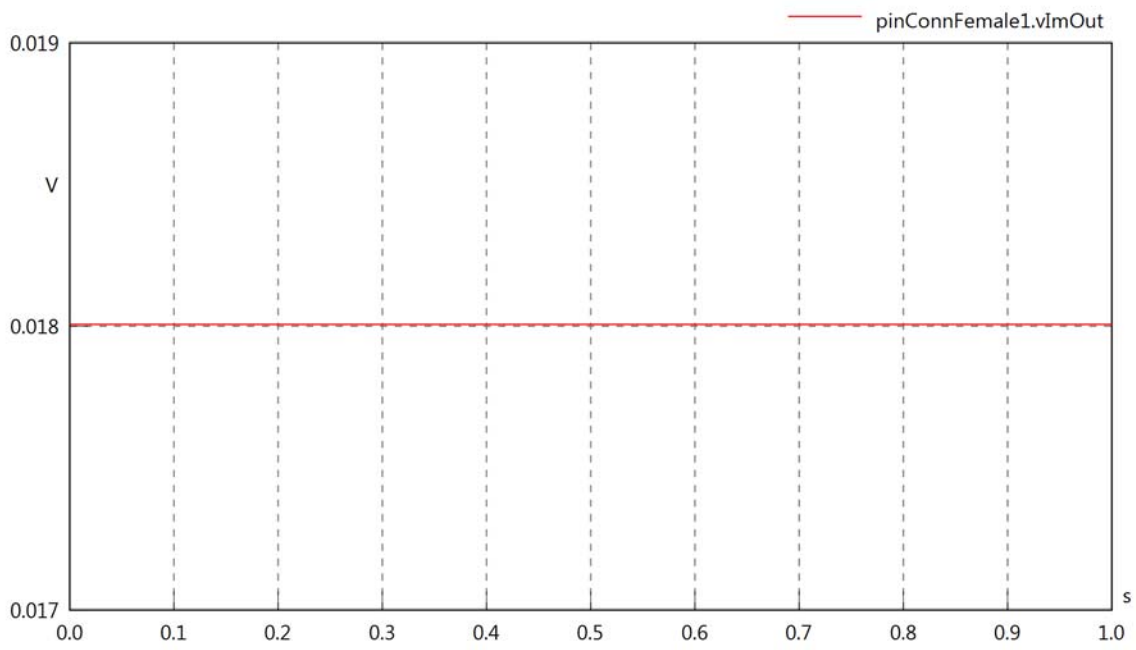

pinConnFemale1.Vrms

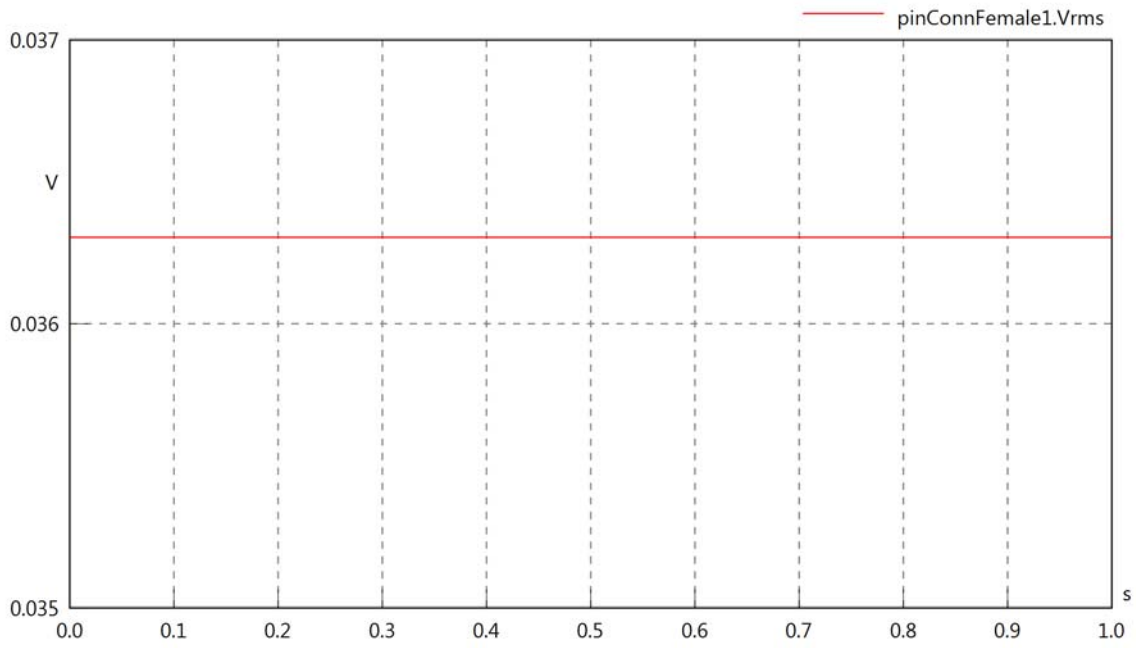

pinConnFemale1.vRe

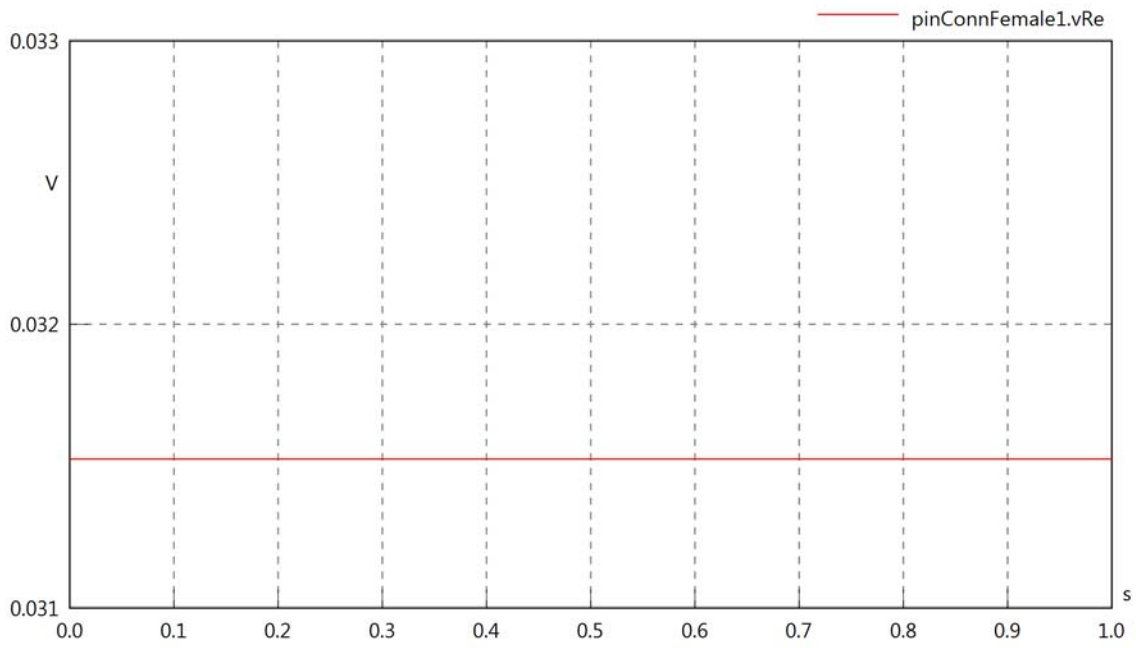

pinConnFemale1.vIm

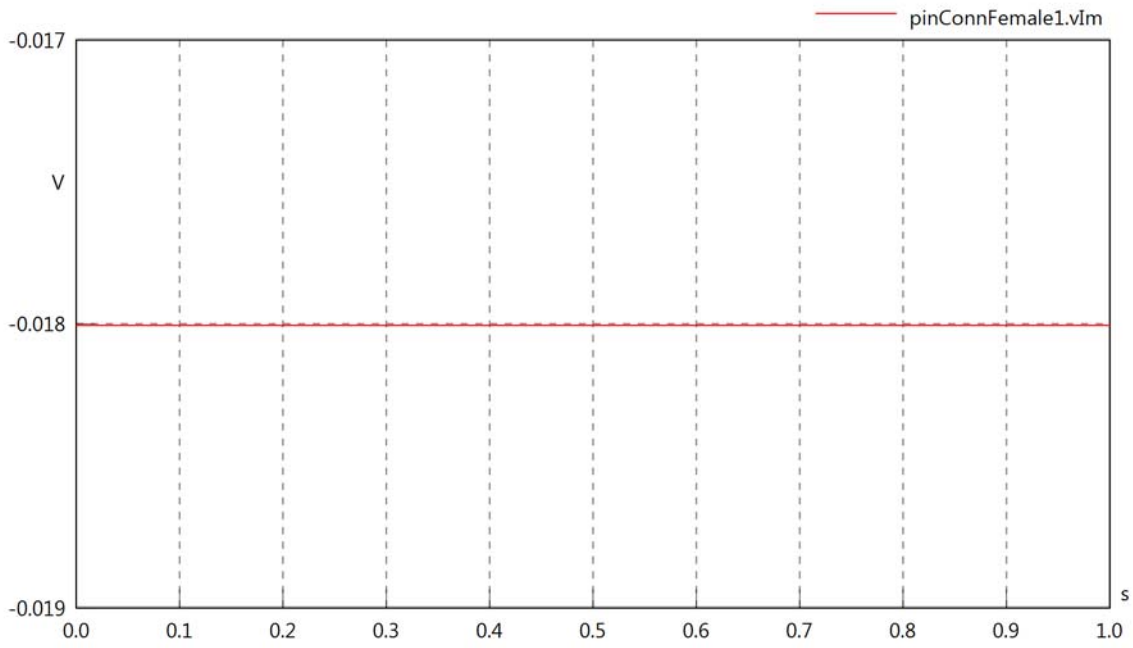

pinConnFemale1.IrmsIn

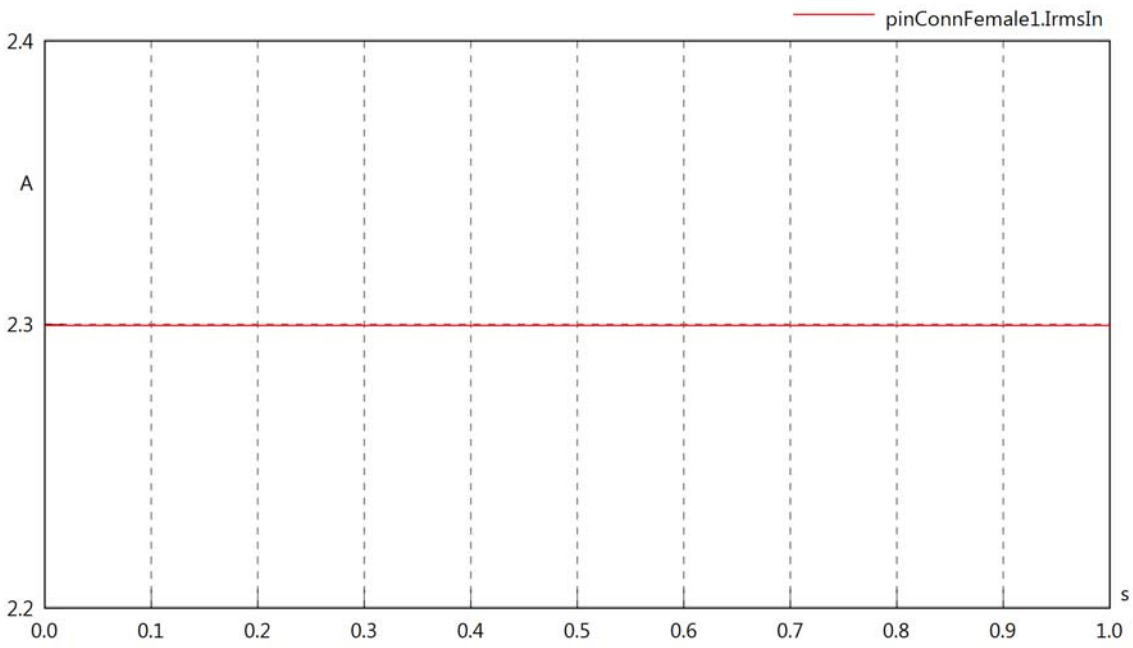

pinConnFemale1.iReIn

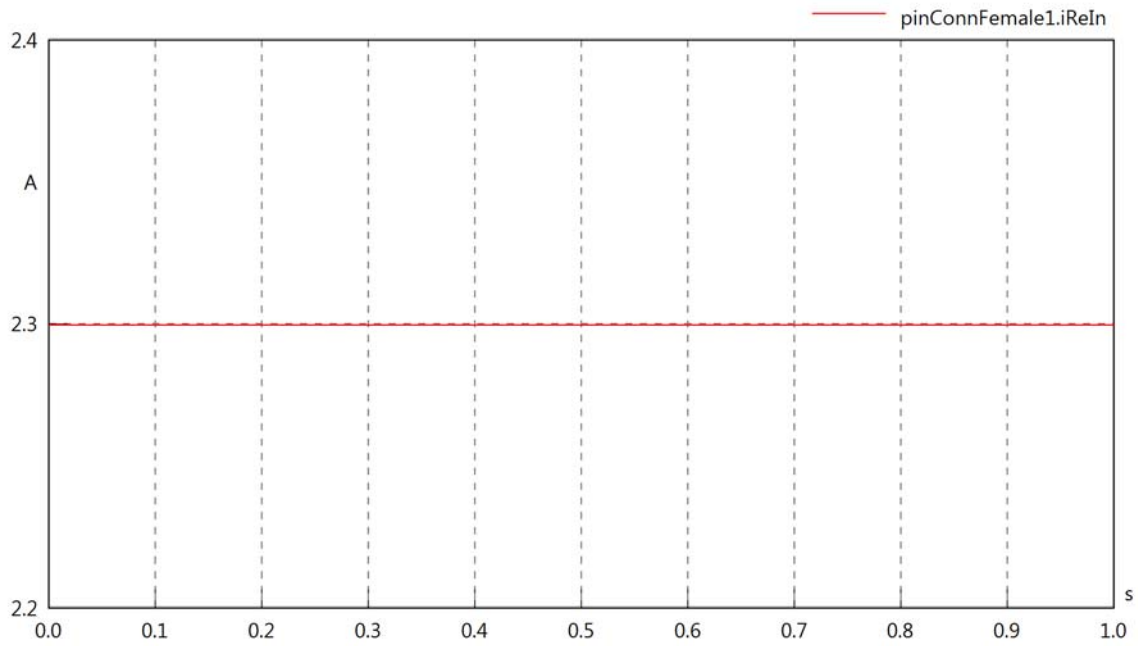

pinConnFemale1.iImIn

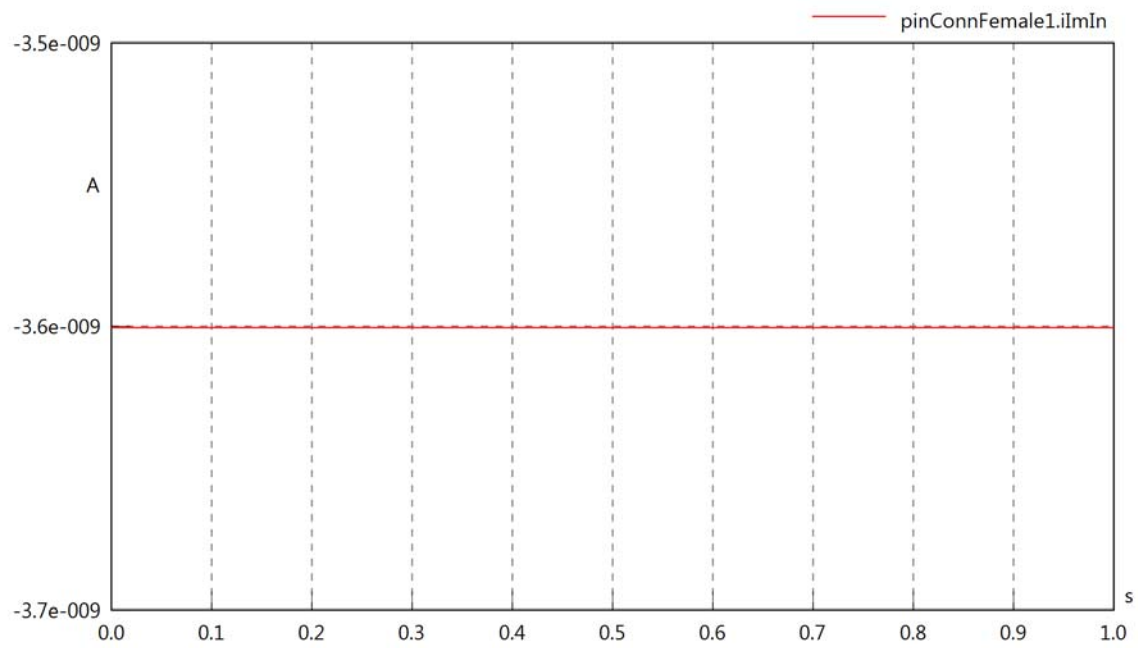

pinConnFemale1.IrmsOut

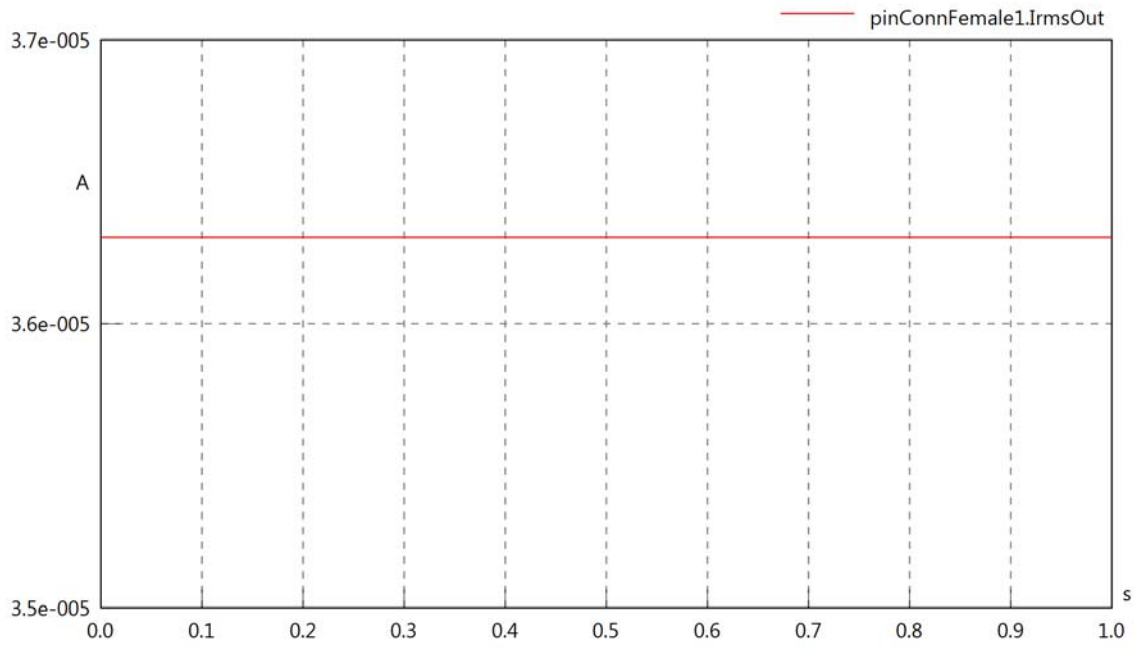

pinConnFemale1.iReOut

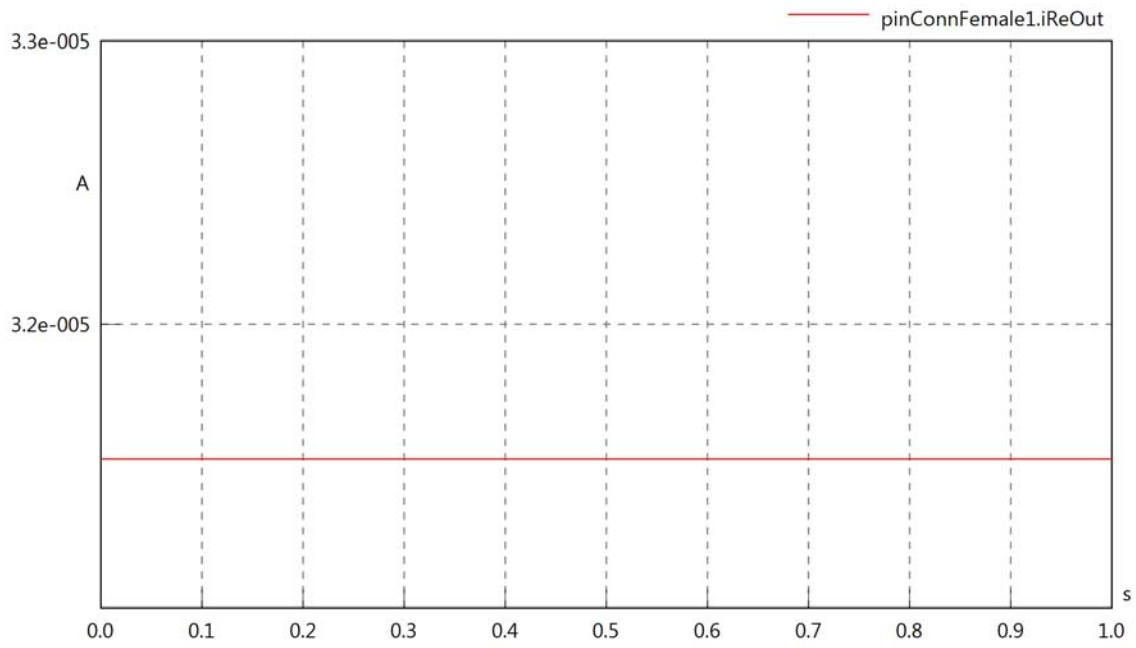

pinConnFemale1.iImOut

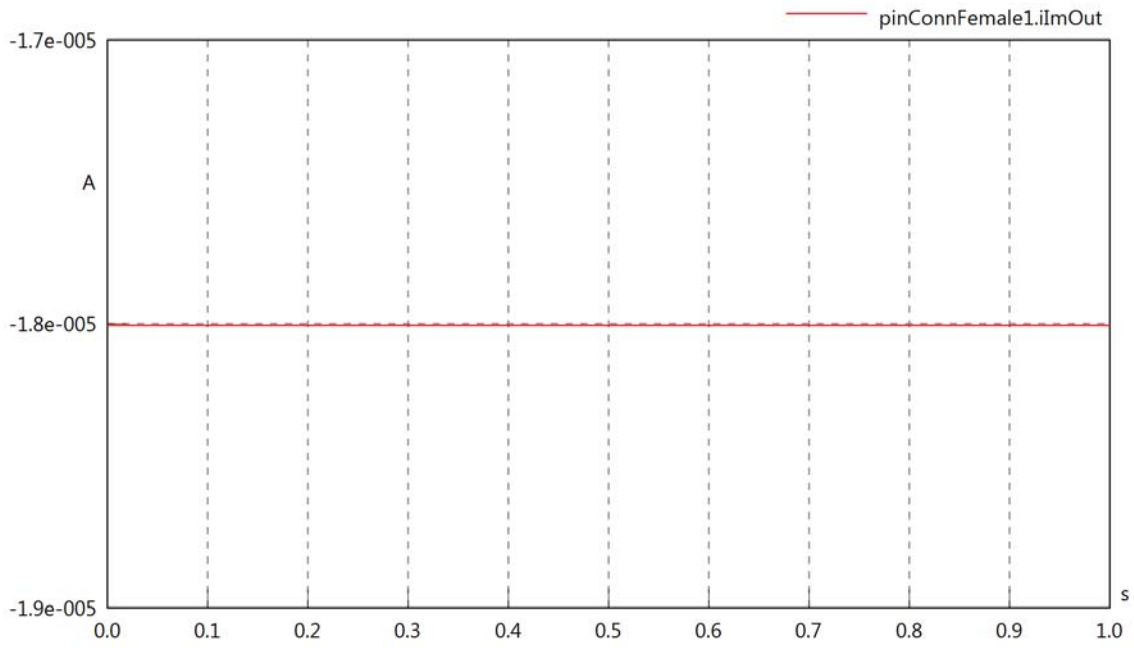

pinConnFemale1.phiVIn

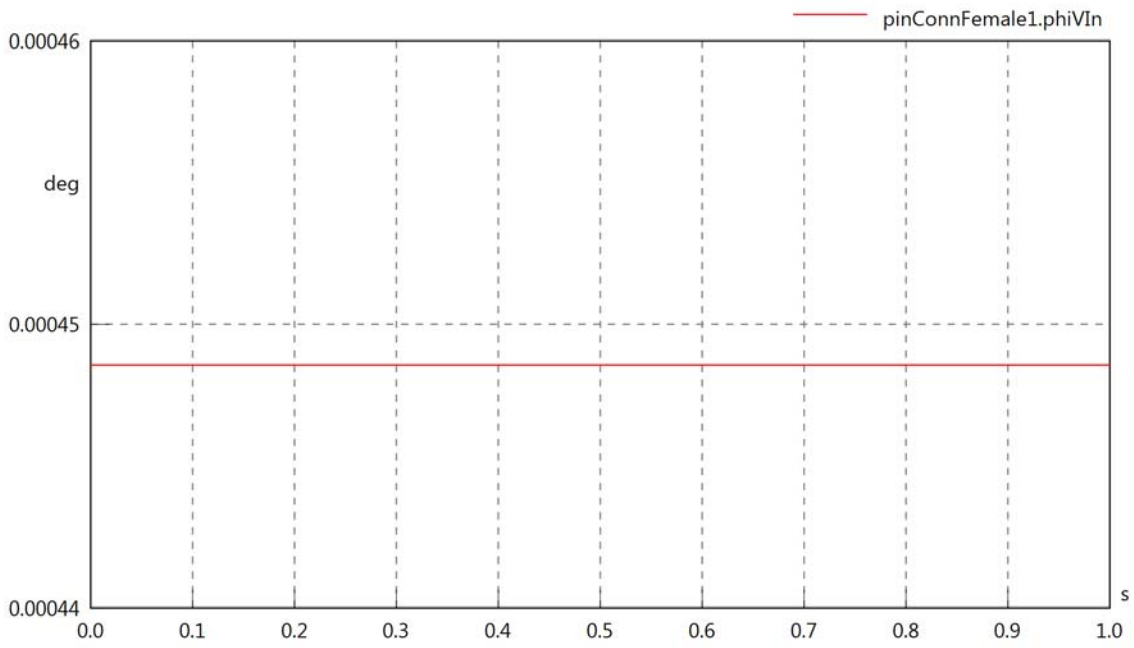

pinConnFemale1.phiIIn

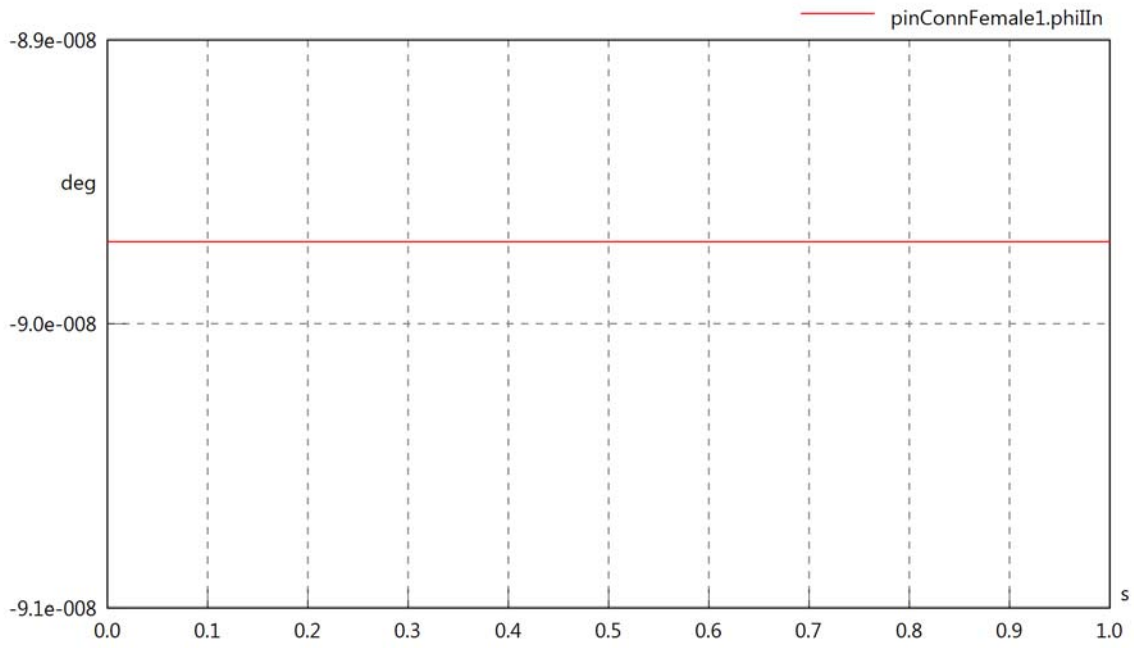

pinConnFemale1.phiIVIn

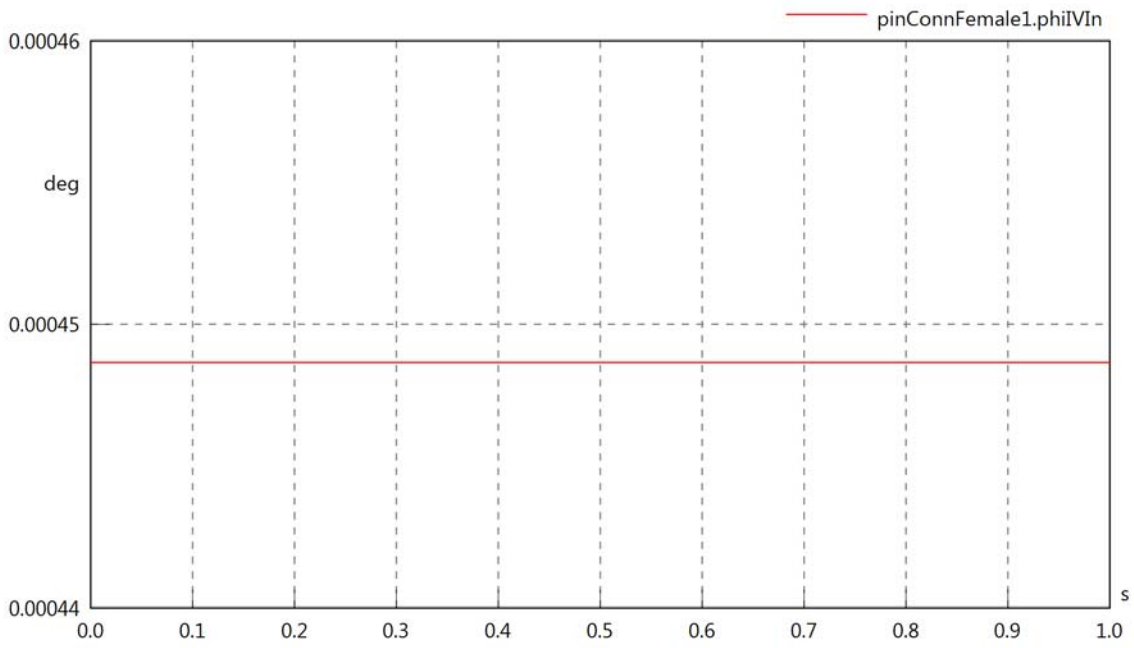

pinConnFemale1.phiVOut

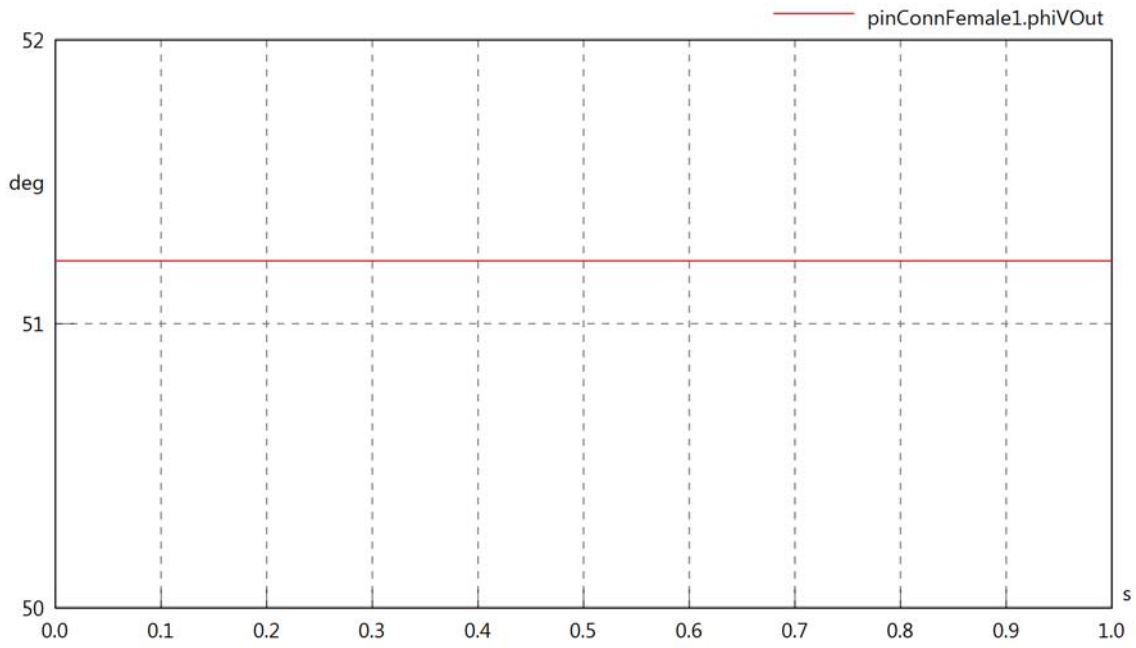

pinConnFemale1.phiIOut

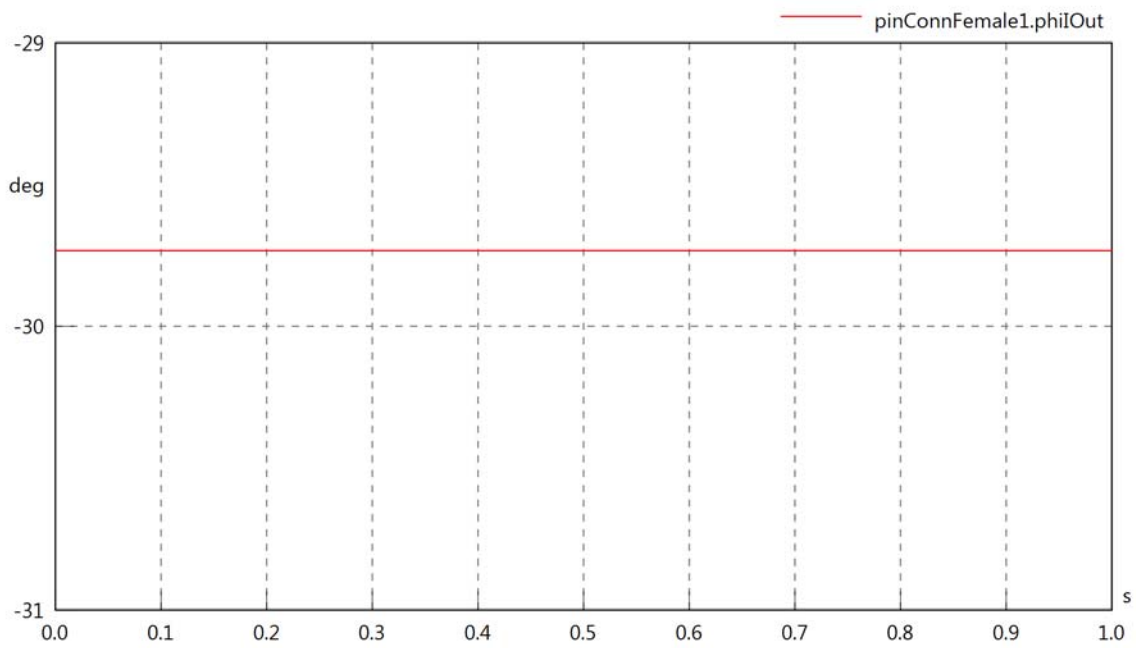

pinConnFemale1.phiIVOut

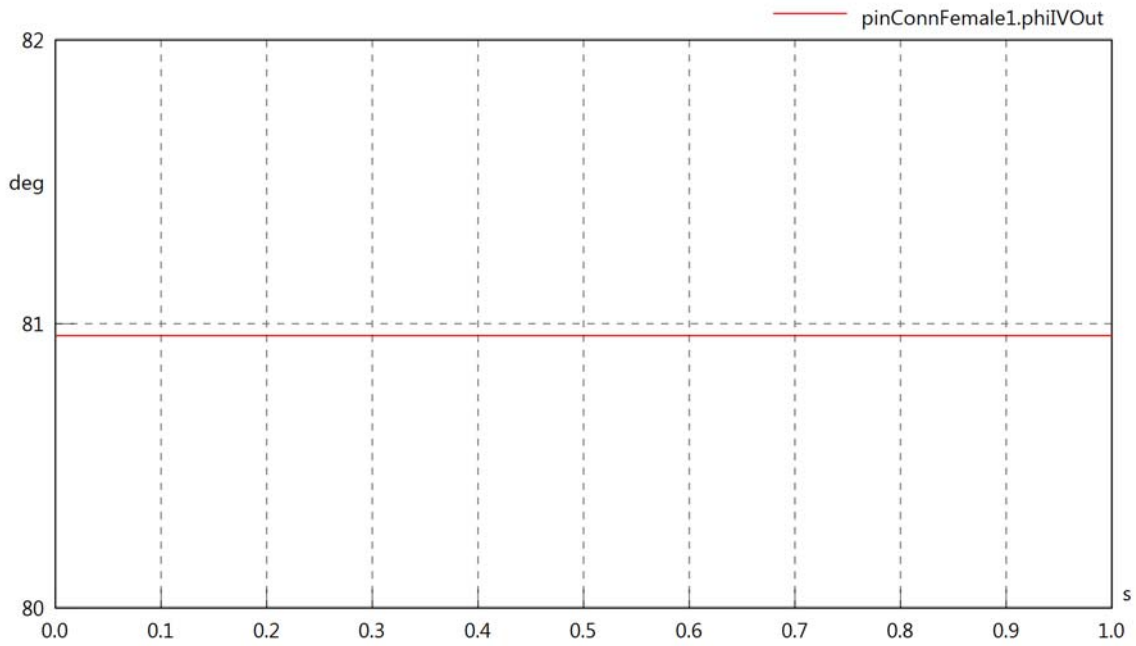

pinConnFemale1.PReIn

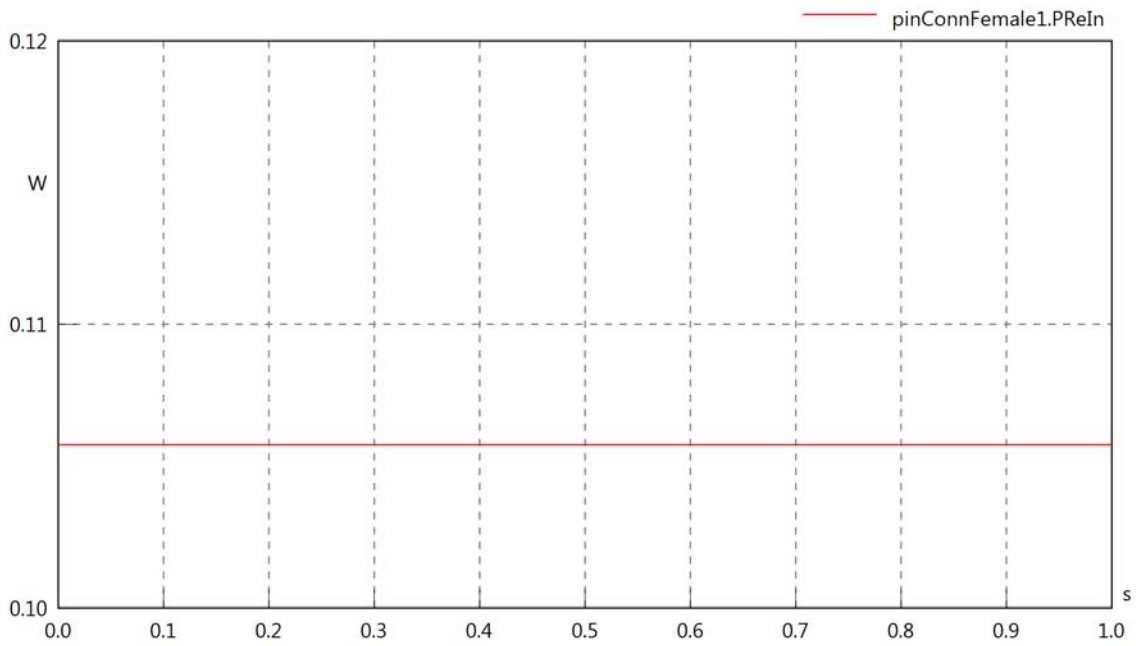

pinConnFemale1.PImIn

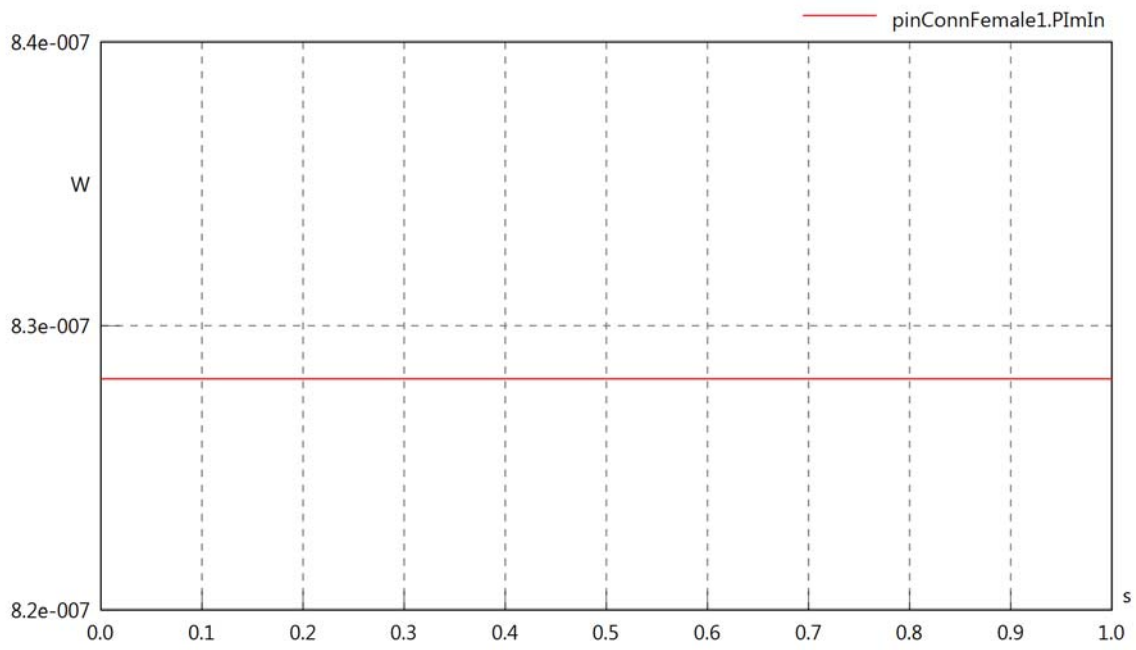

pinConnFemale1.SIn

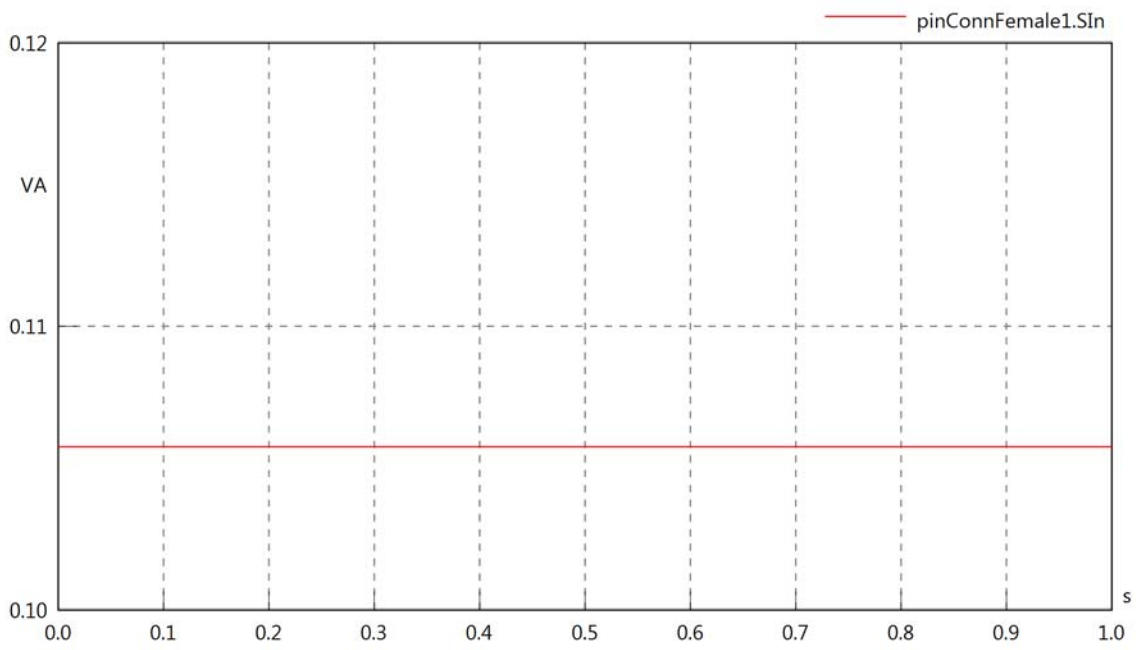

pinConnFemale1.PReOut

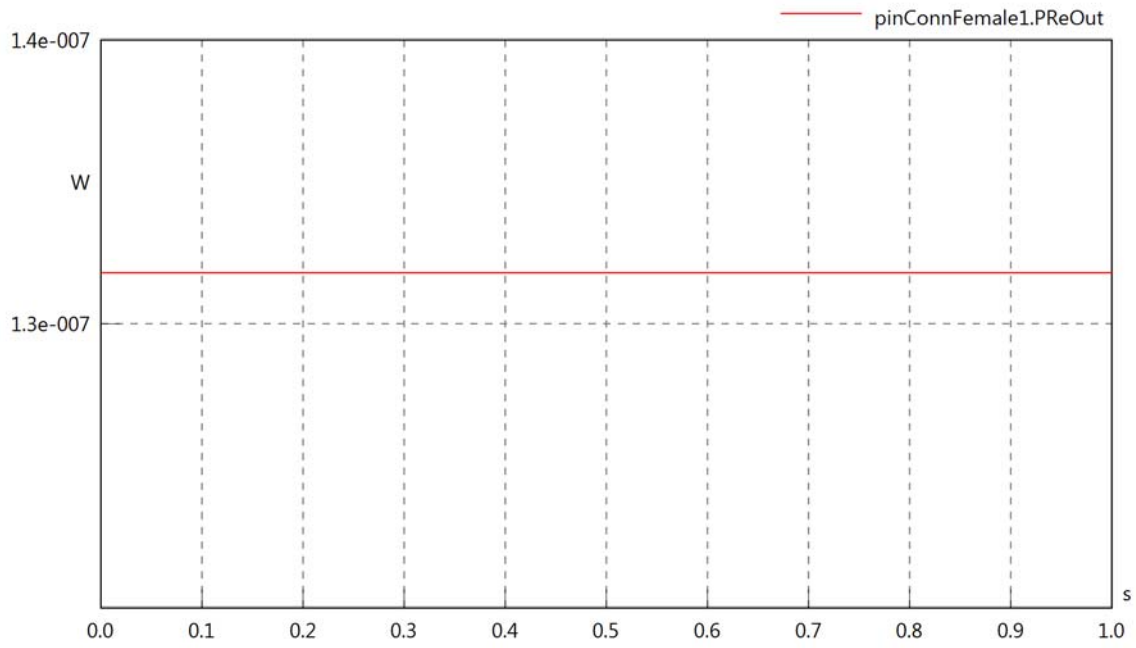

pinConnFemale1.PImOut

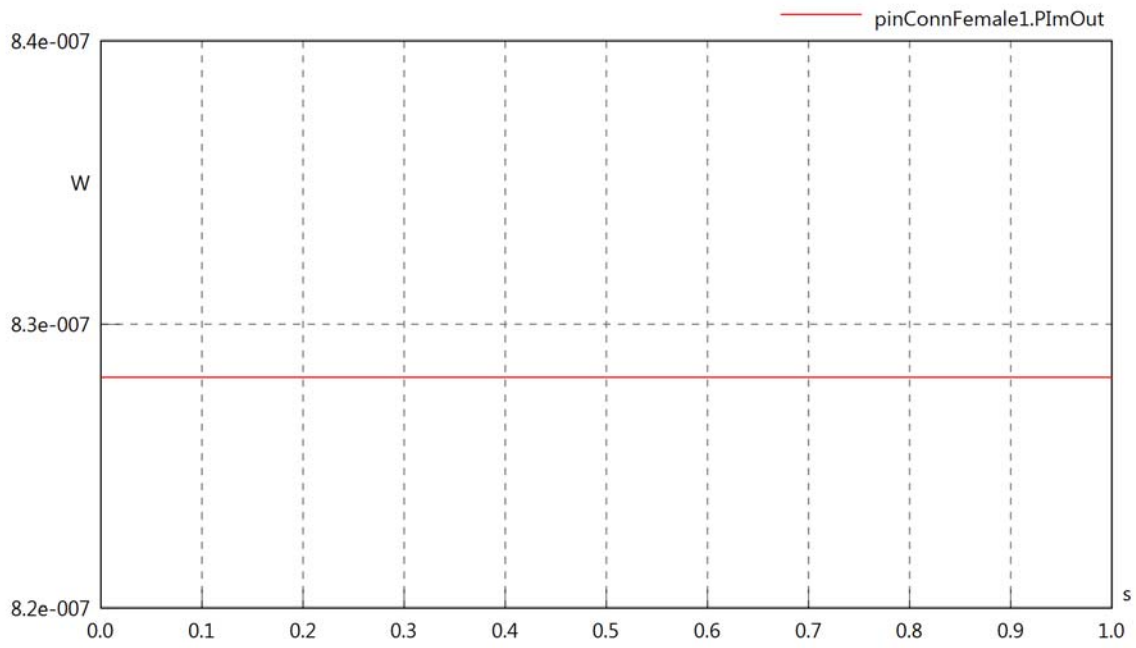

pinConnFemale1.SOut

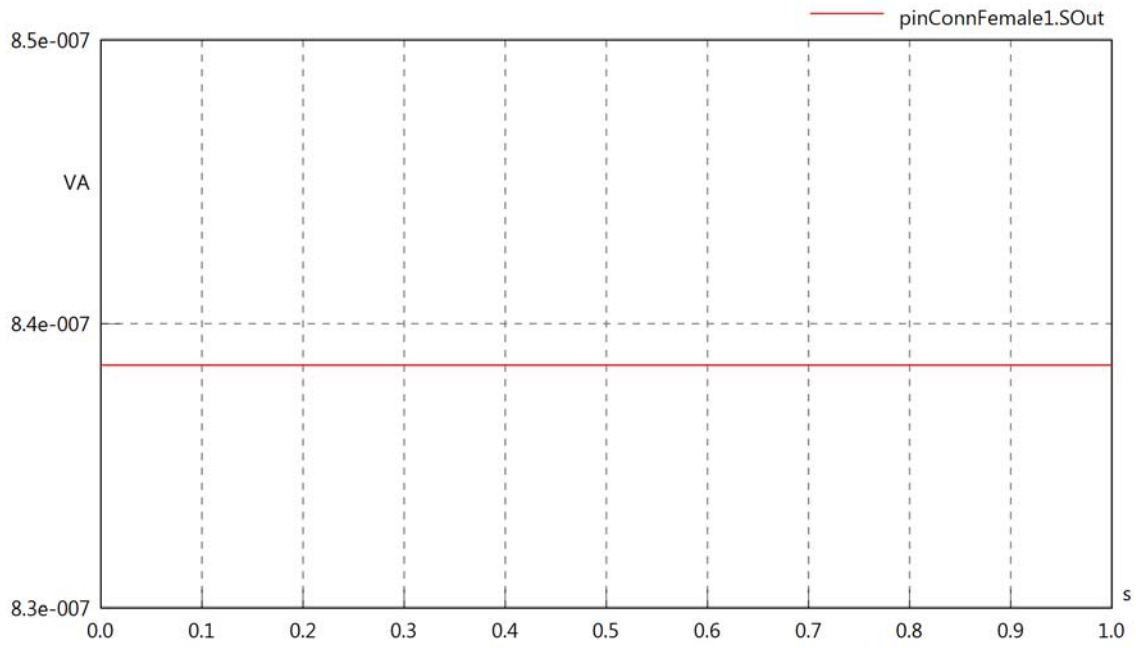
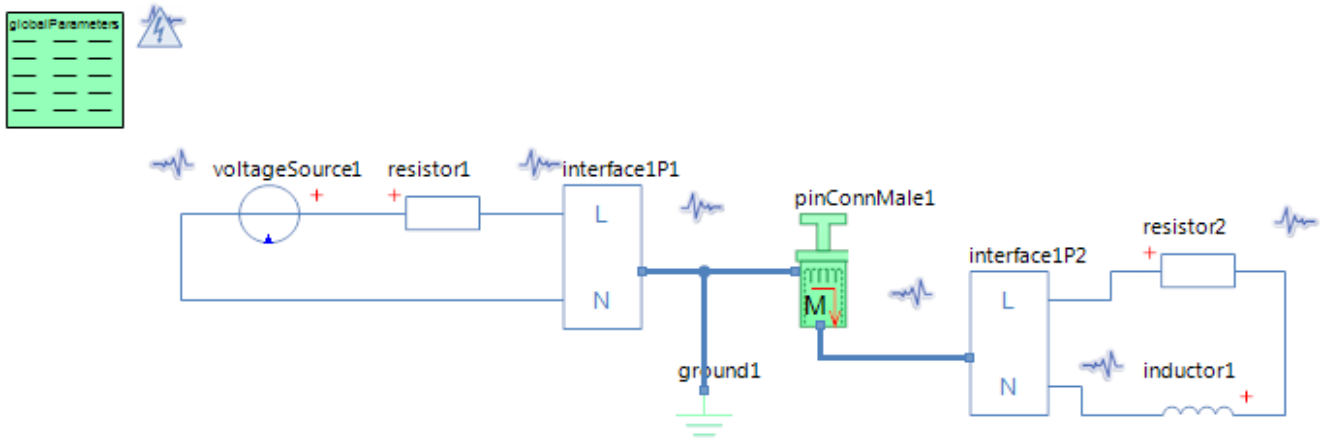

Diagram View



GlobalParameters globalParameters
Parameters

Comment	Name	Current Value	Unit
Type of Calculation	eCalculationKind	Signal Calculation	
Description of Frequency	eFrequencyKind	Linear	
Minimum Frequency	fMin	60	[Hz]
Maximum Frequency	fMax	60	[Hz]

Voltage Source voltageSource1
Parameters

Comment	Name	Current Value	Unit
Voltage RMS	VrmsSrc	230	[V]
Phase	phi	0	[deg]

Resistor resistor1
Parameters

Comment	Name	Current Value	Unit
Resistance	R	100	[Ohm]

Resistor resistor2
Parameters

Comment	Name	Current Value	Unit
Resistance	R	100	[Ohm]

Inductor inductor1
Parameters

Comment	Name	Current Value	Unit
Inductance	L	5	[mH]

Pin Connector Male pinConnMale1
Parameters

Comment	Name	Current Value	Unit
Poor or failing L1 connection	bL1	false	

pinConnMale1.VrmsIn

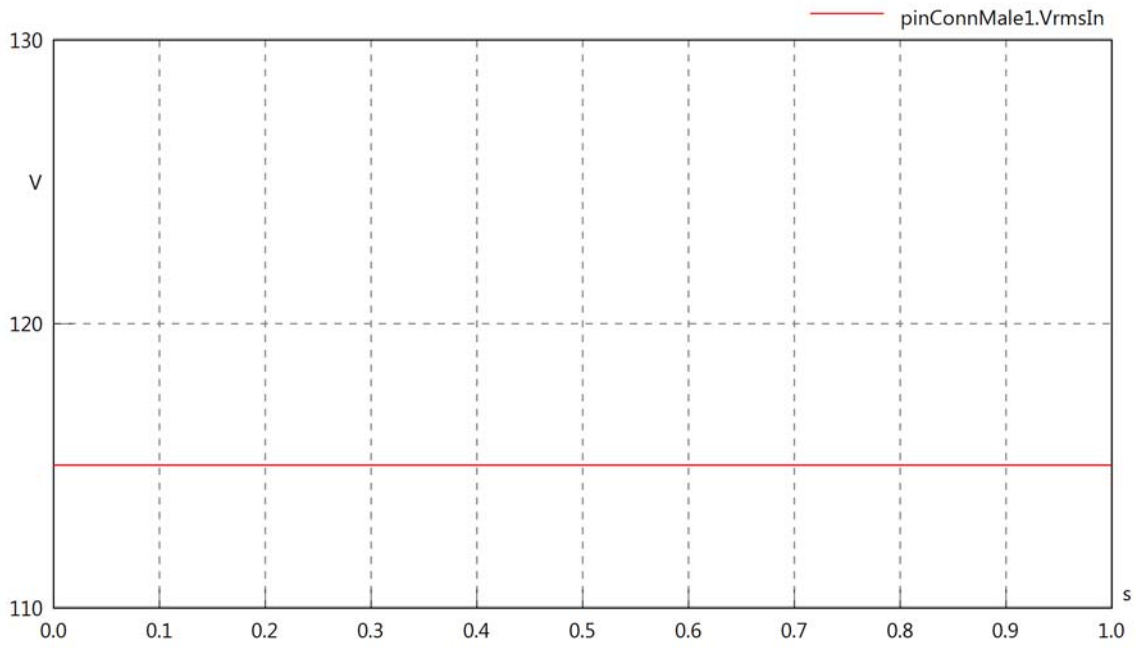

pinConnMale1.vReIn

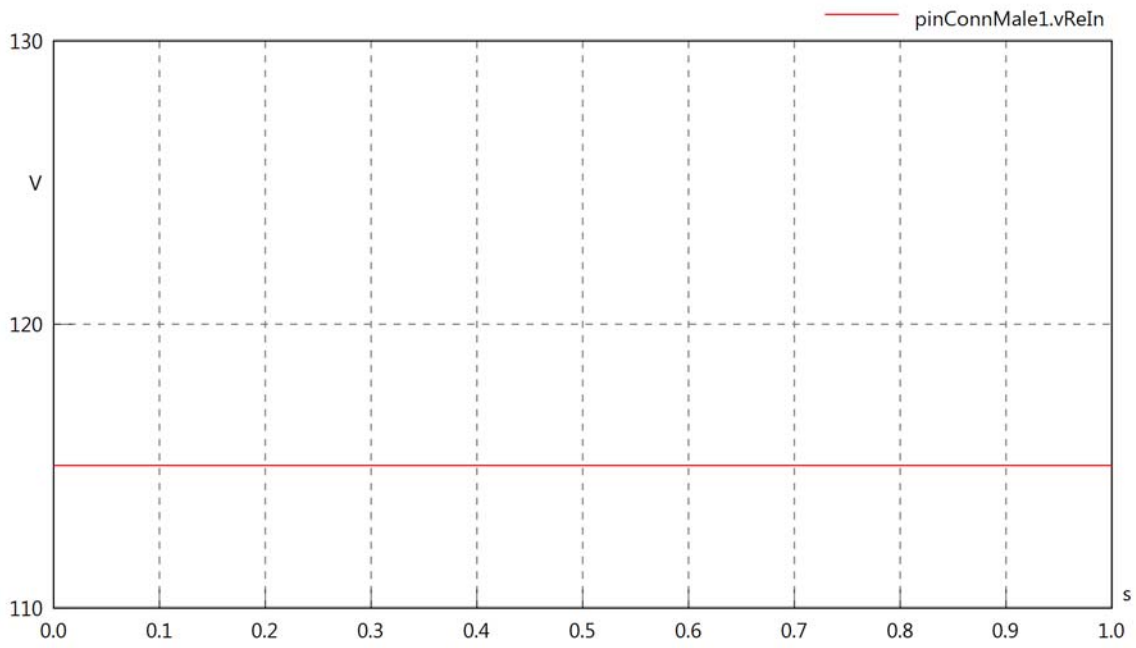

pinConnMale1.vImIn

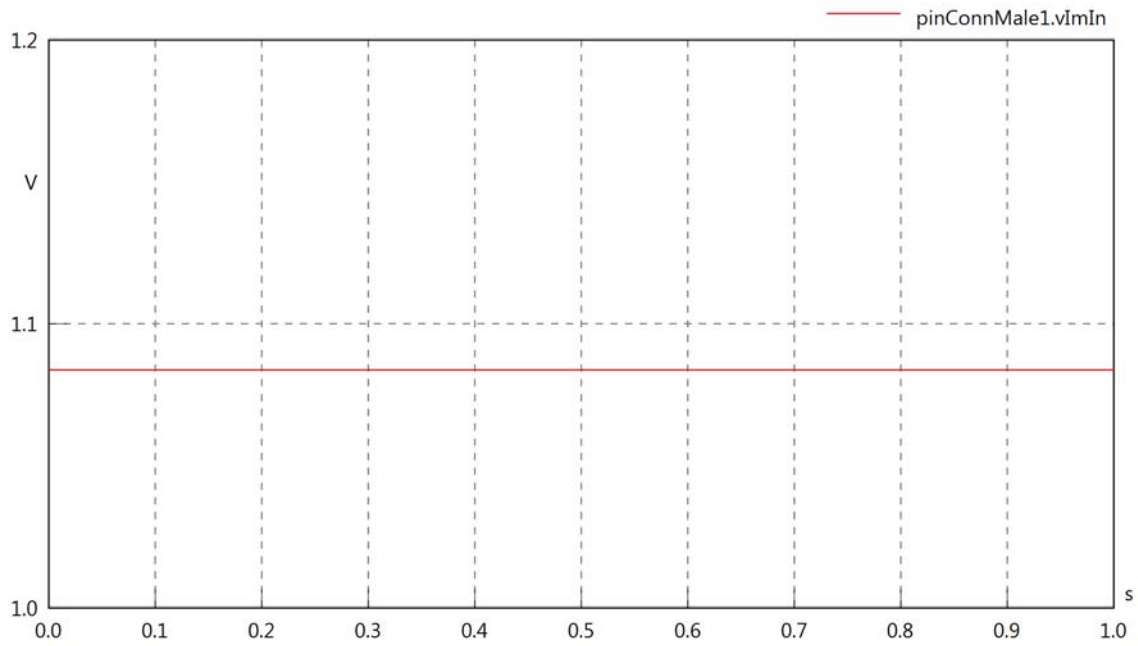

pinConnMale1.VrmsOut

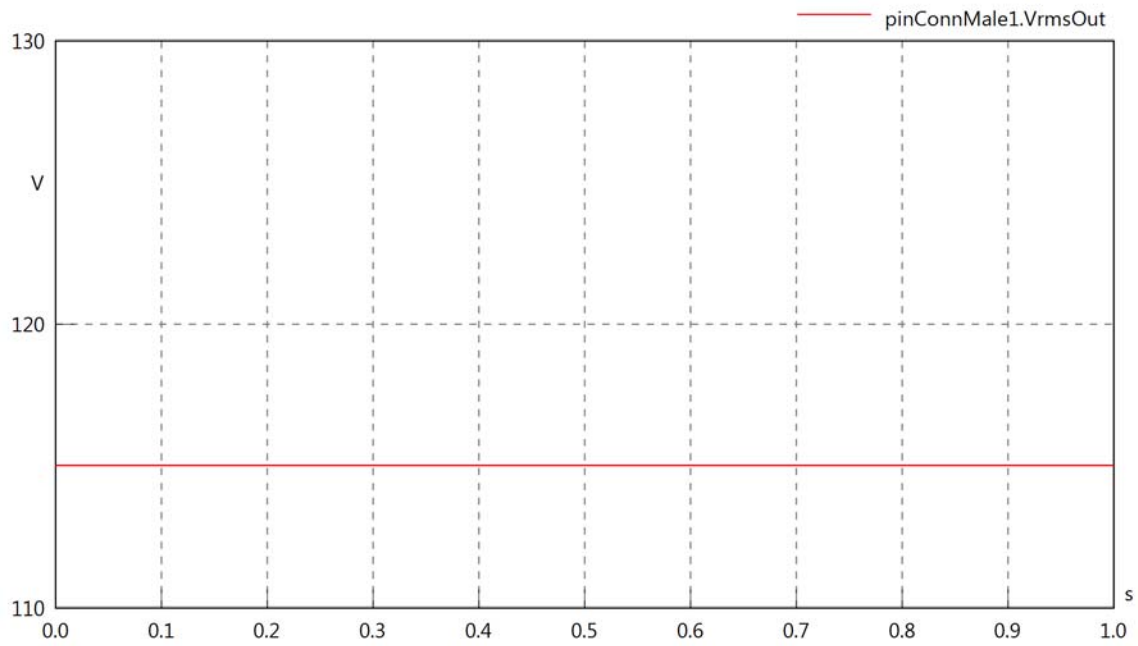

pinConnMale1.vReOut

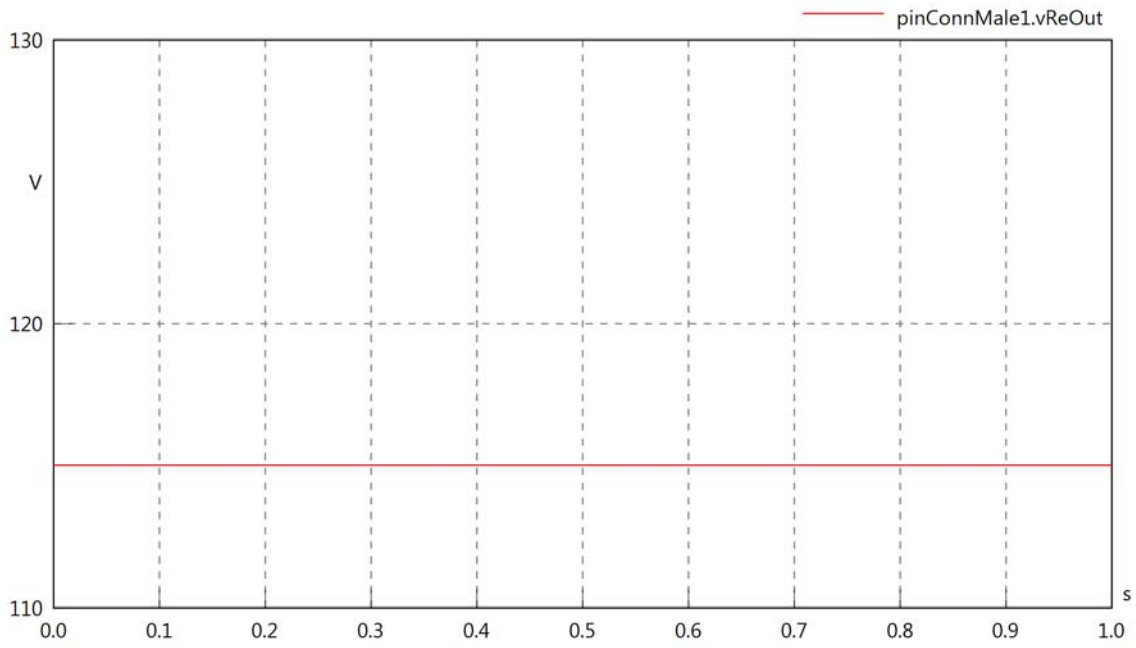

pinConnMale1.vImOut

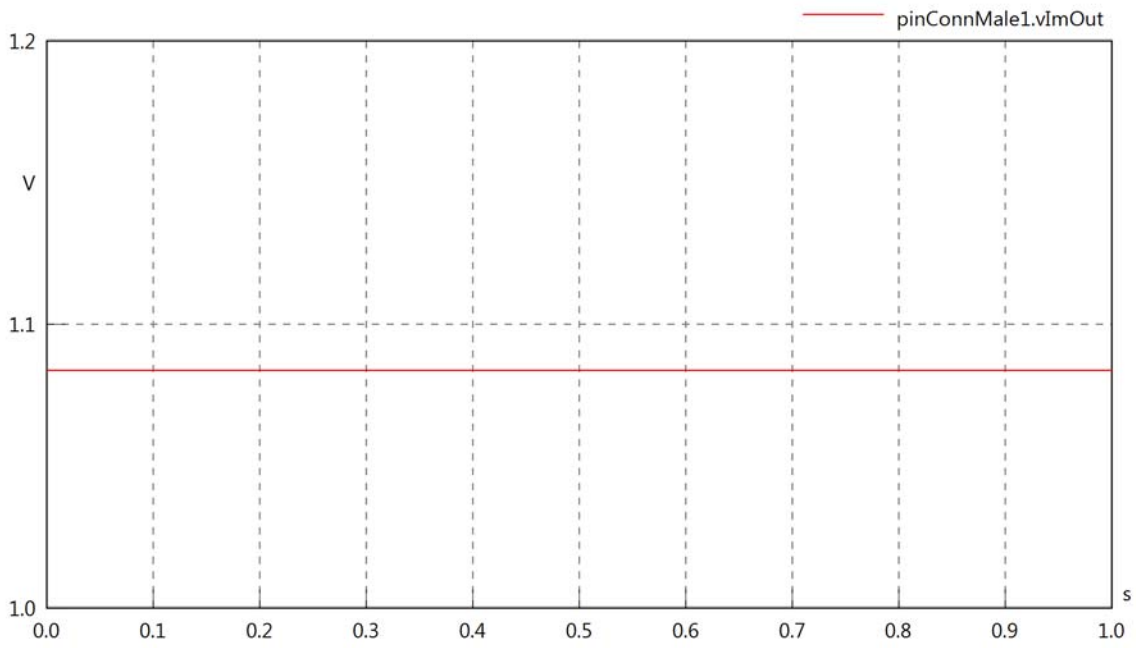

pinConnMale1.Vrms

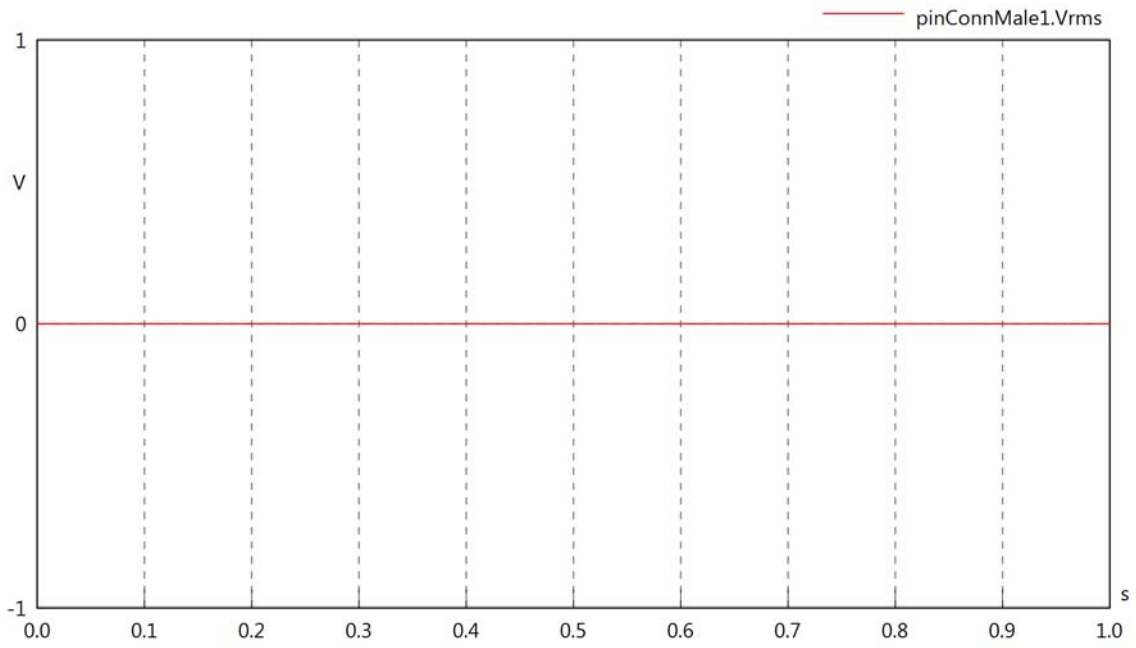

pinConnMale1.vRe

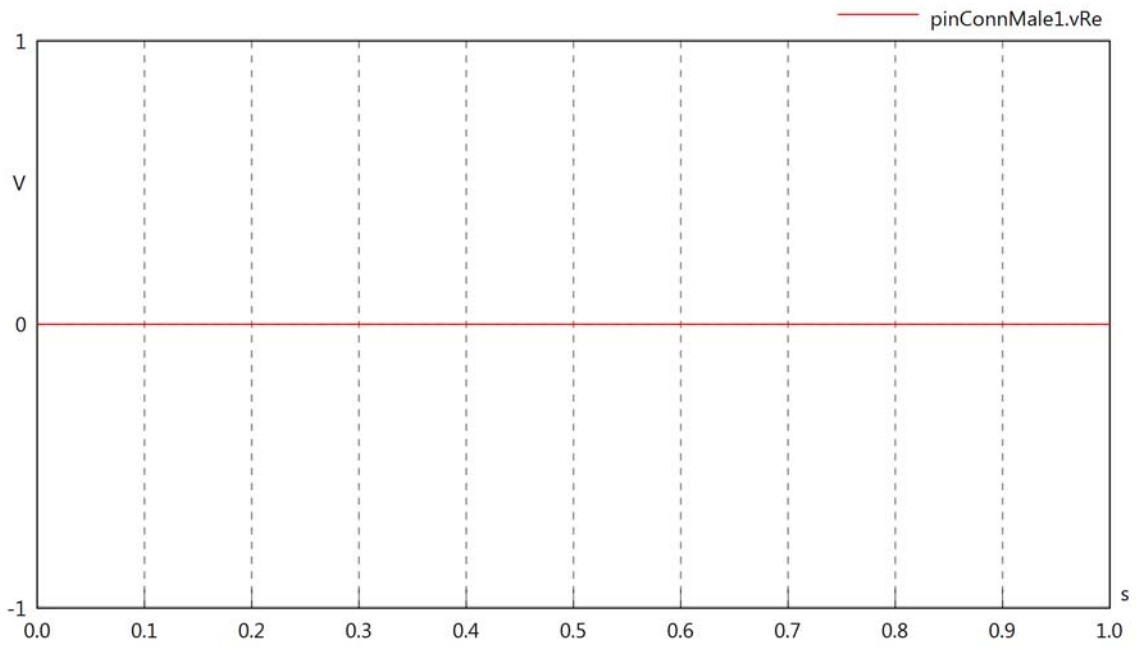

pinConnMale1.vIm

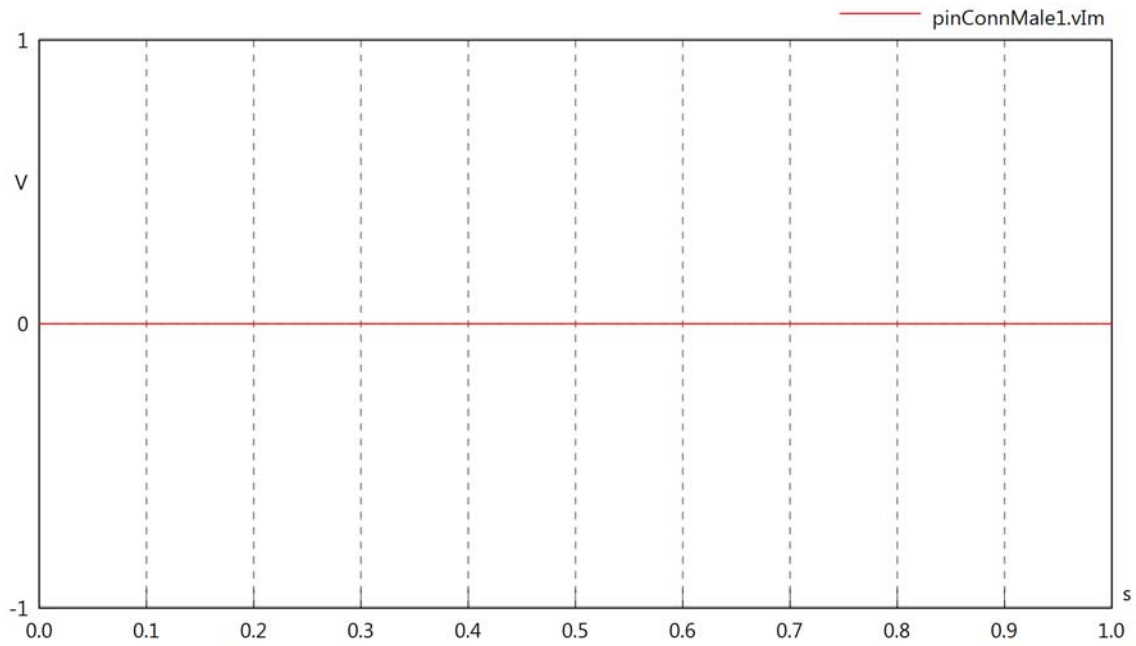

pinConnMale1.IrmsIn

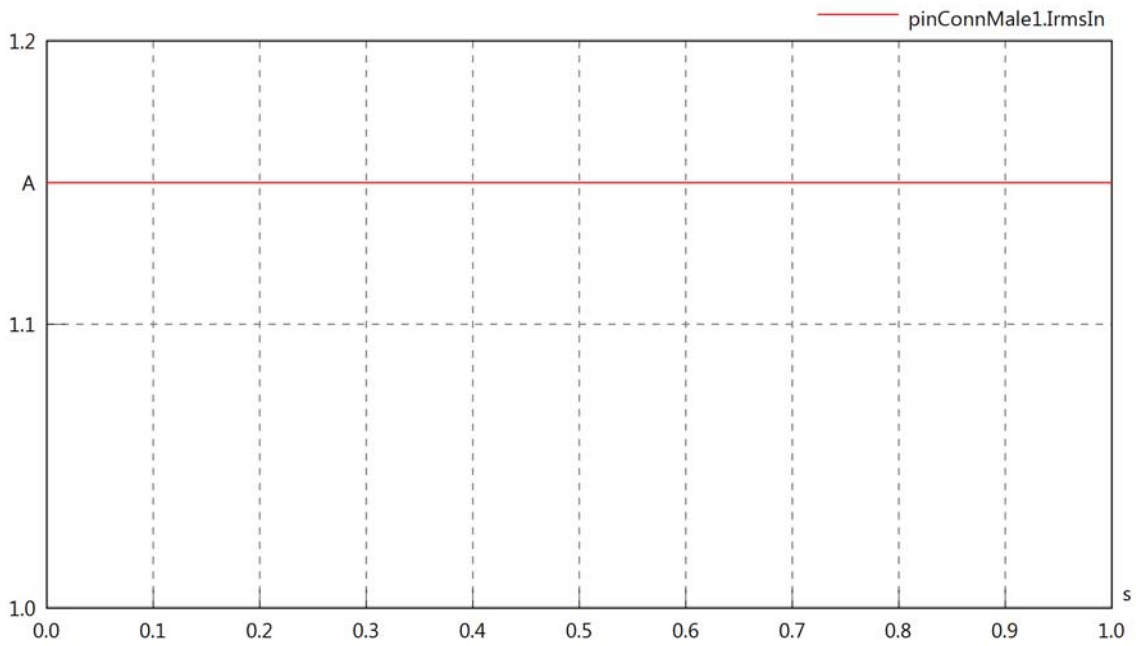

pinConnMale1.iReIn

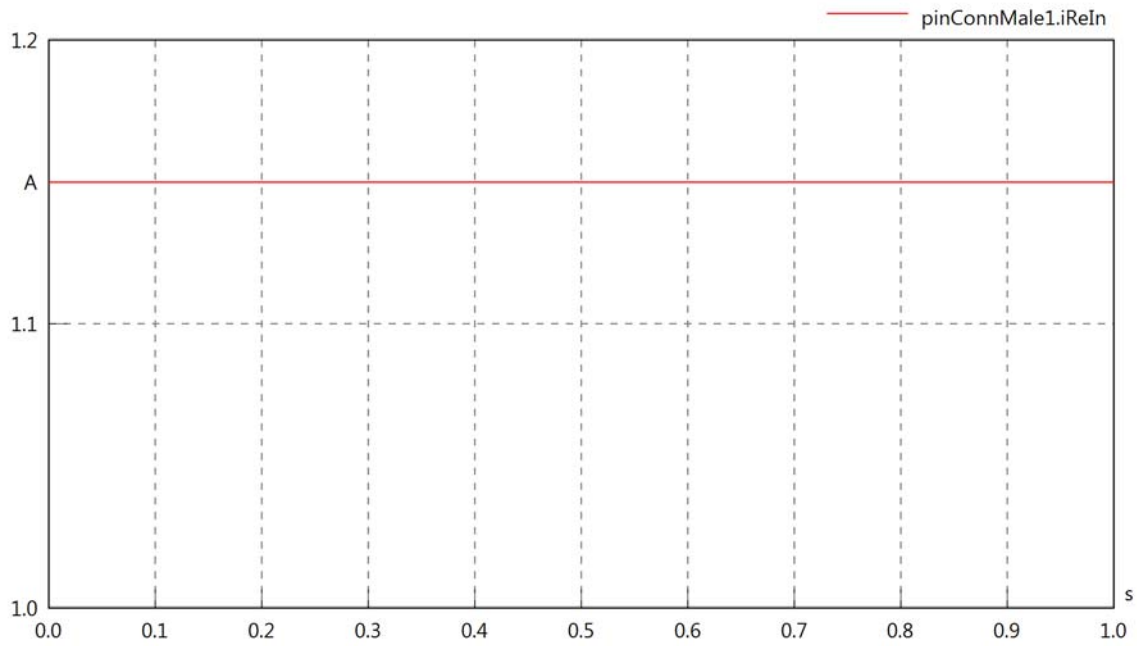

pinConnMale1.iImIn

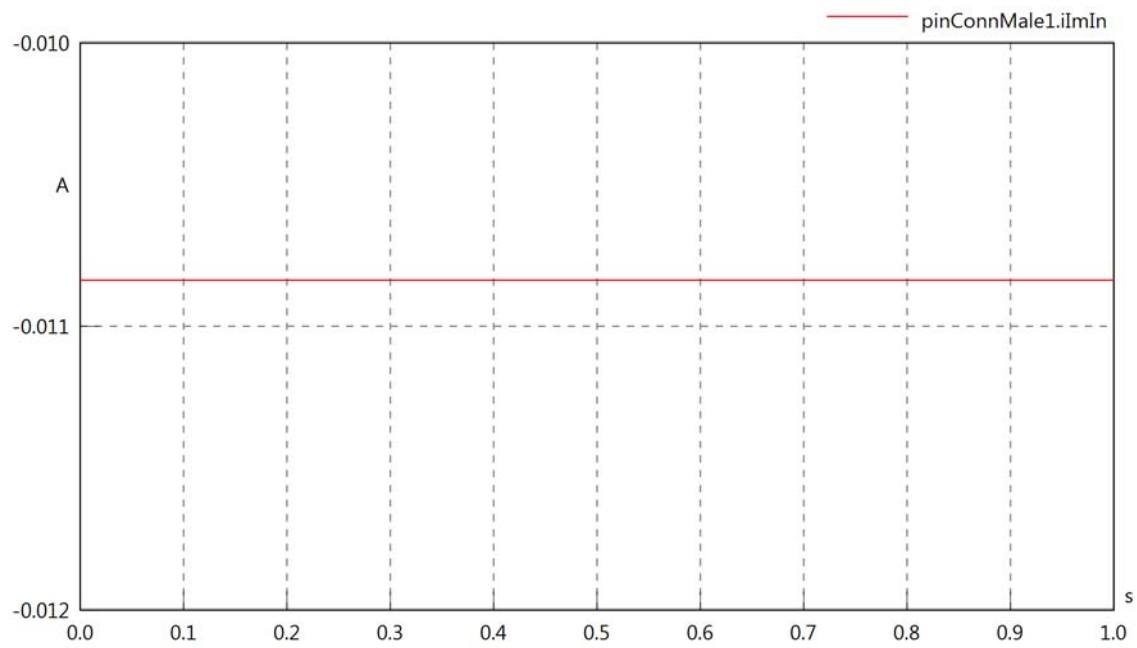

pinConnMale1.IrmsOut

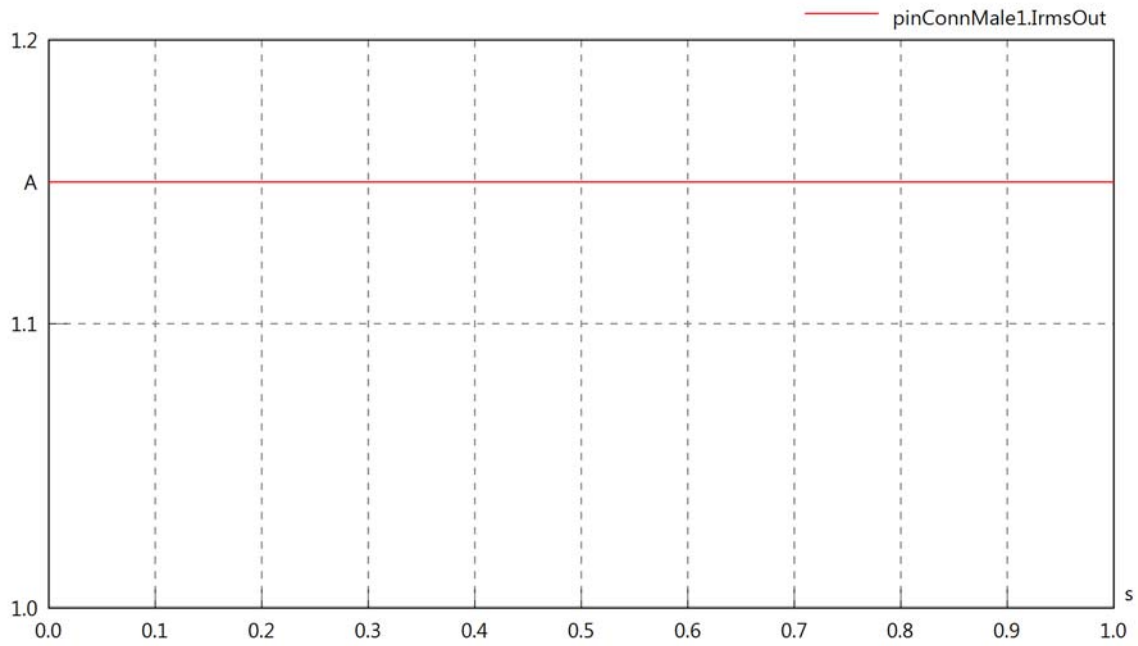

pinConnMale1.iReOut

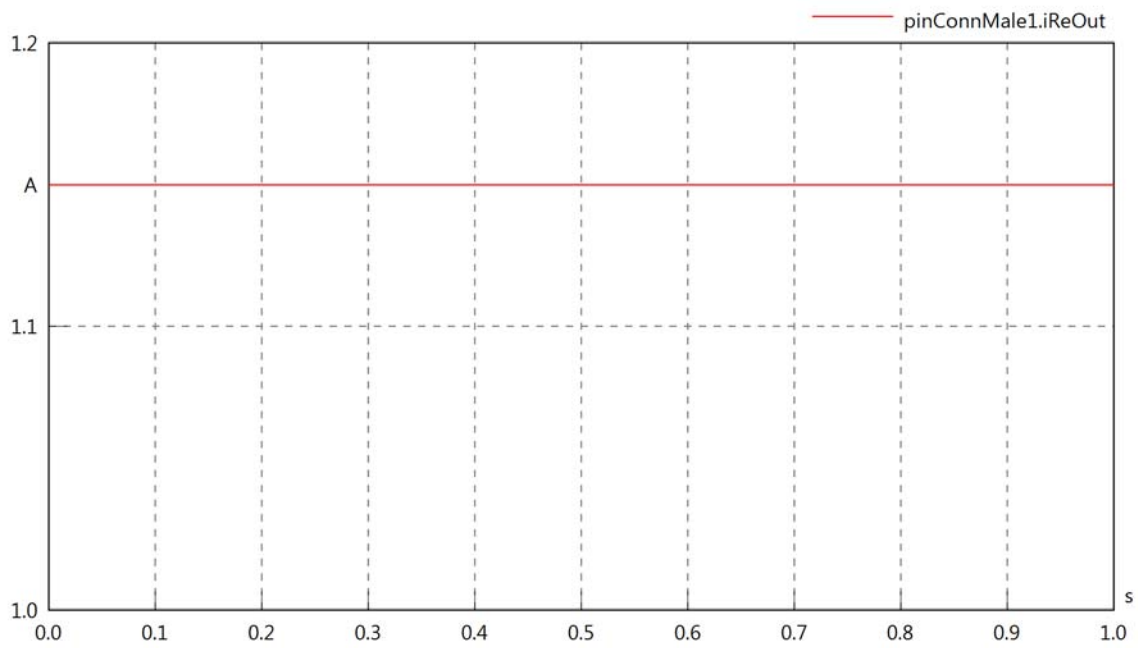

pinConnMale1.iImOut

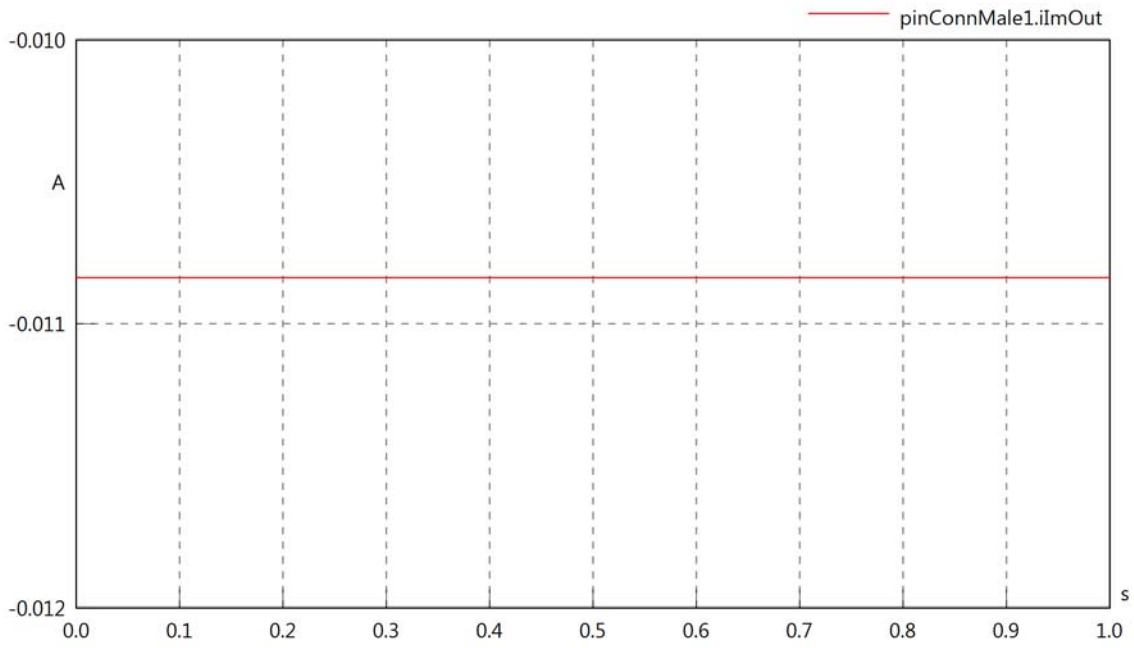

pinConnMale1.phiVIn

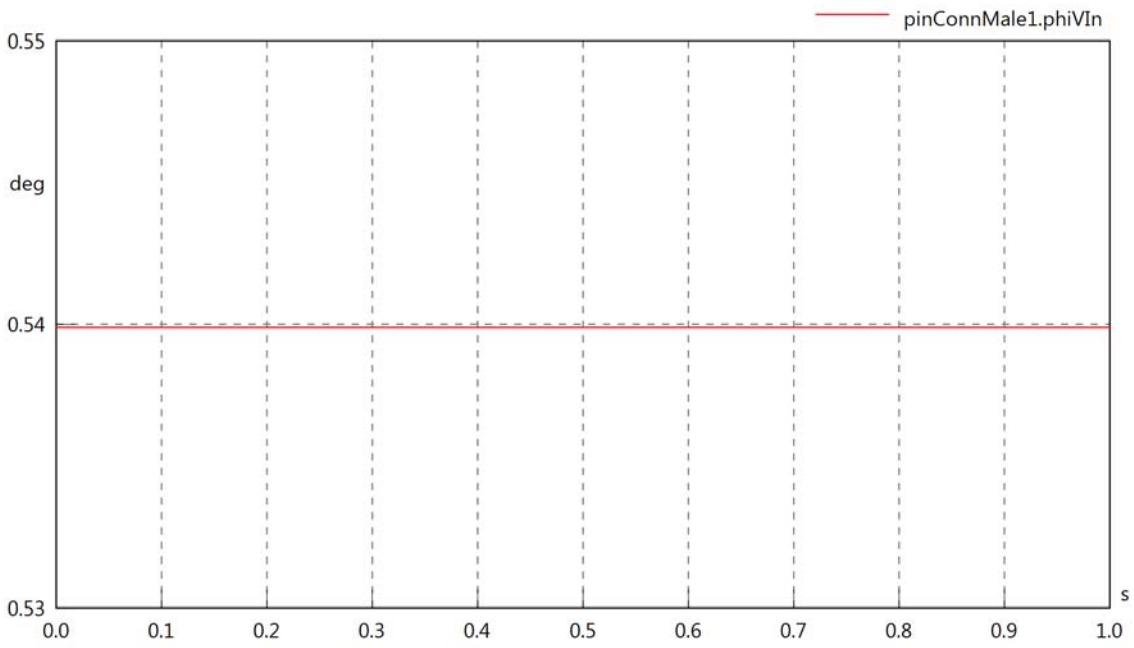

pinConnMale1.phiIIn

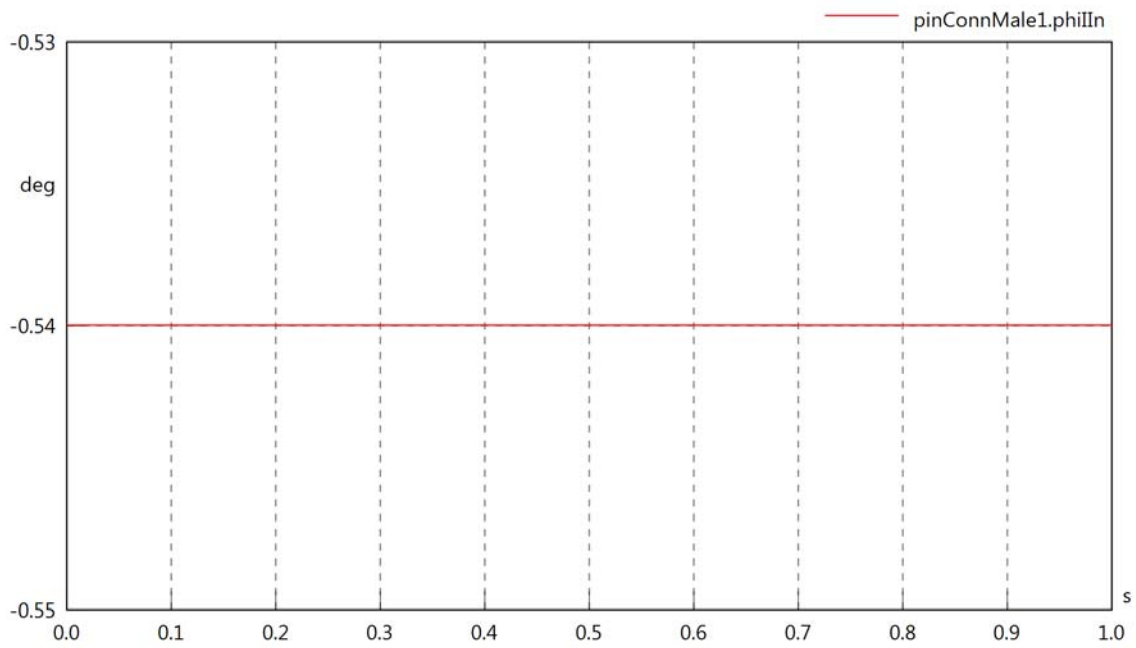

pinConnMale1.phiIVIn

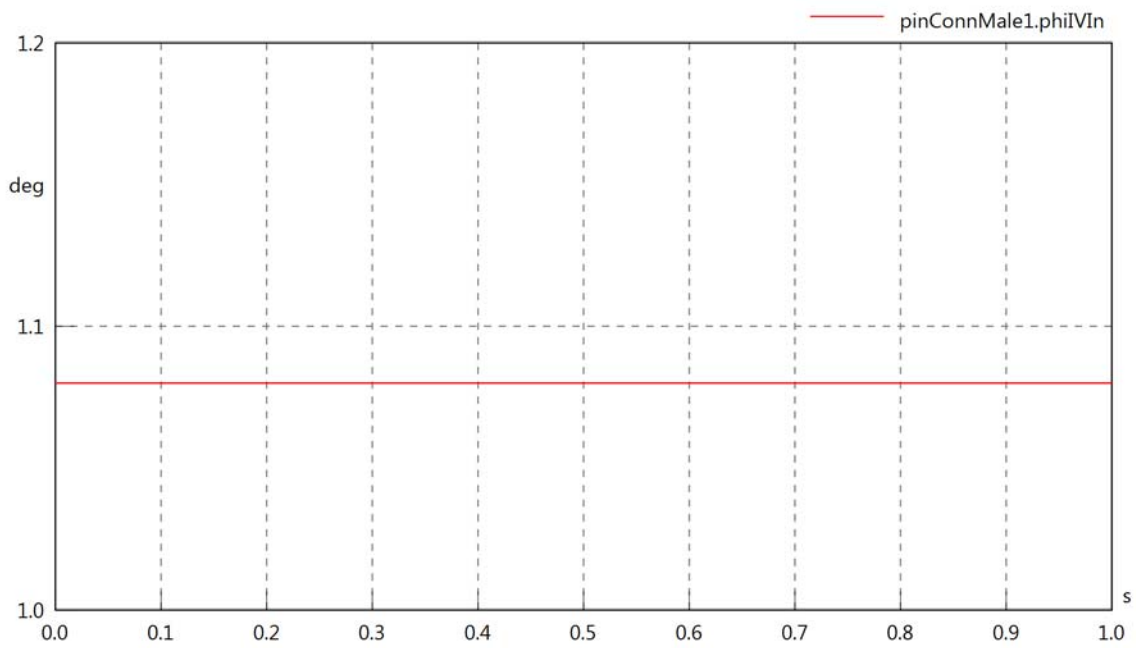

pinConnMale1.phiVOut

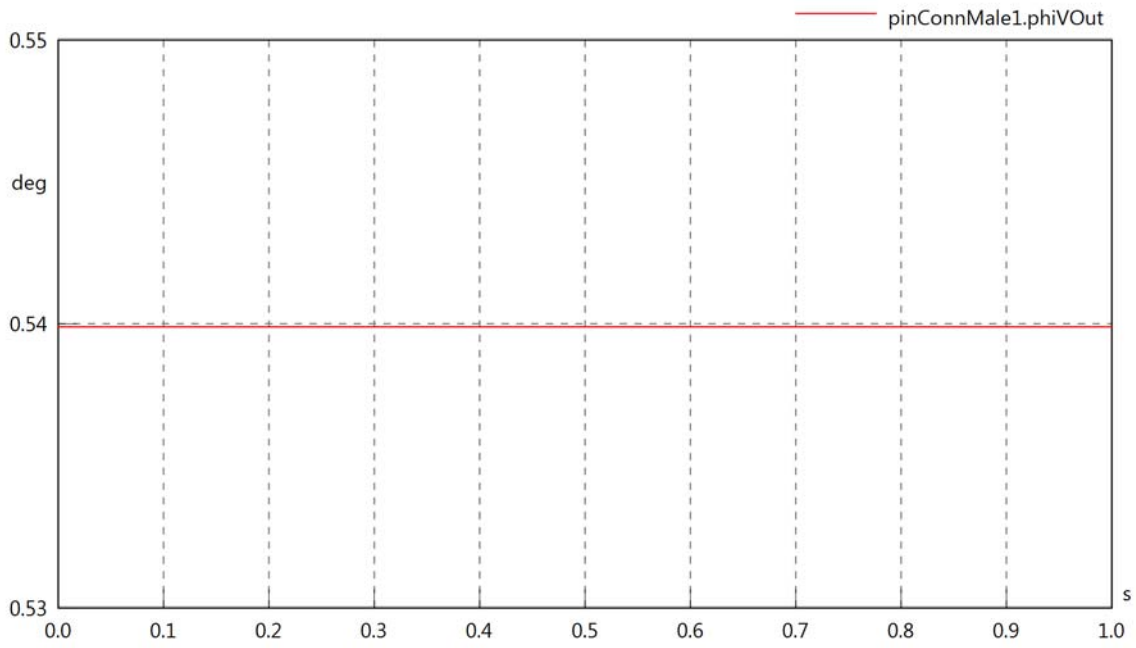

pinConnMale1.phiIOut

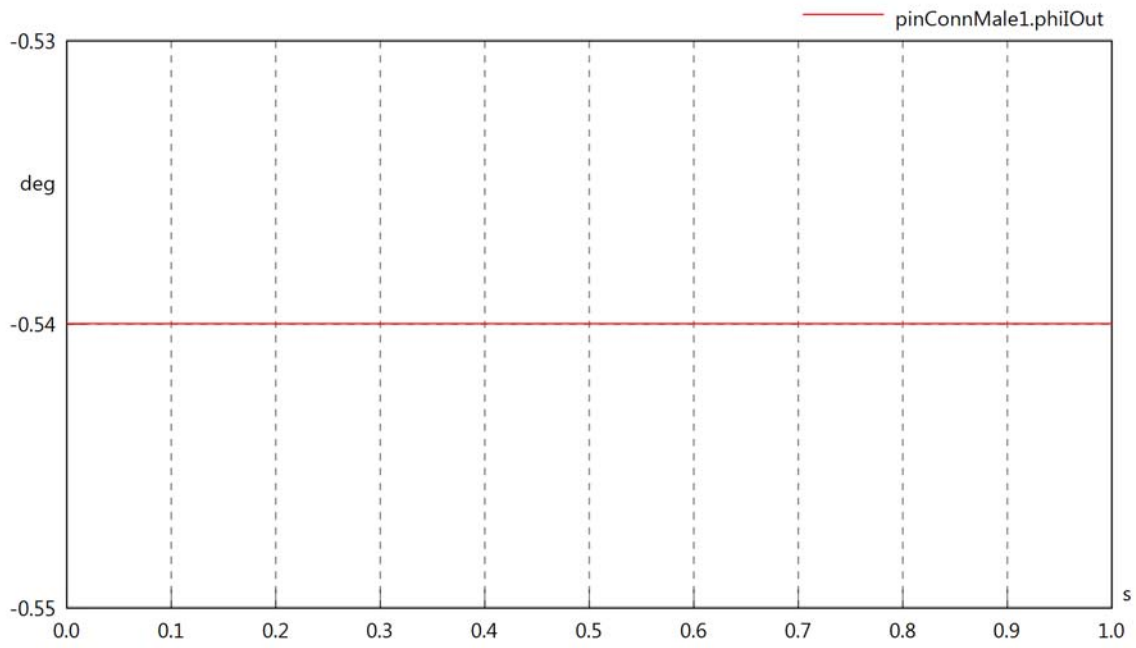

pinConnMale1.phiIVOut

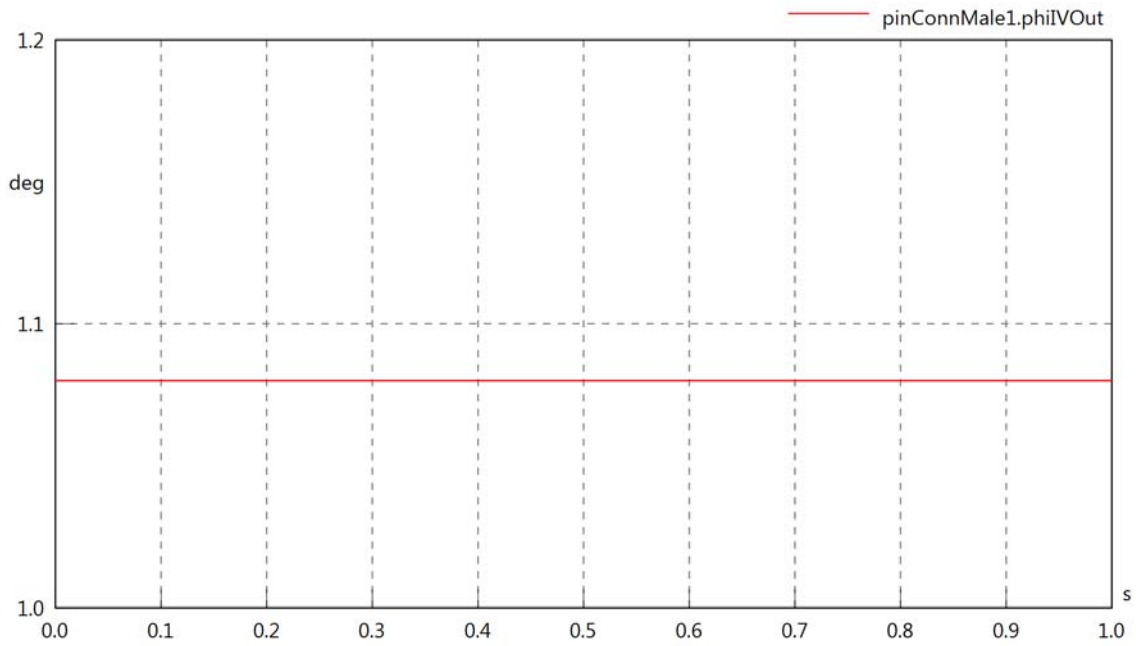

pinConnMale1.PReIn

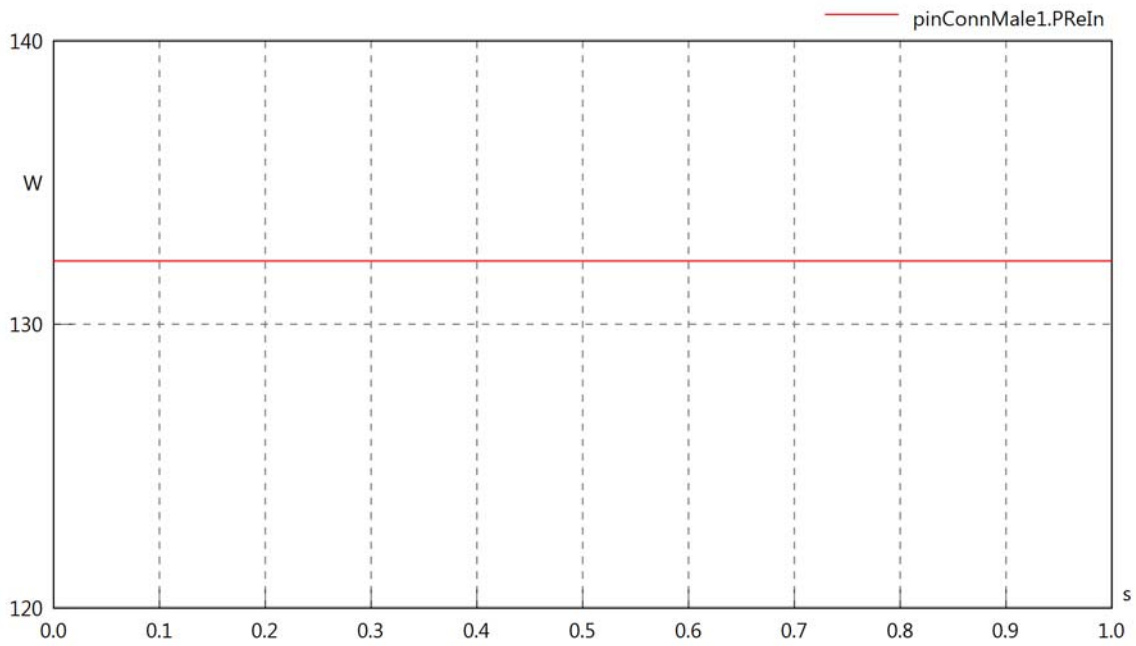

pinConnMale1.PImIn

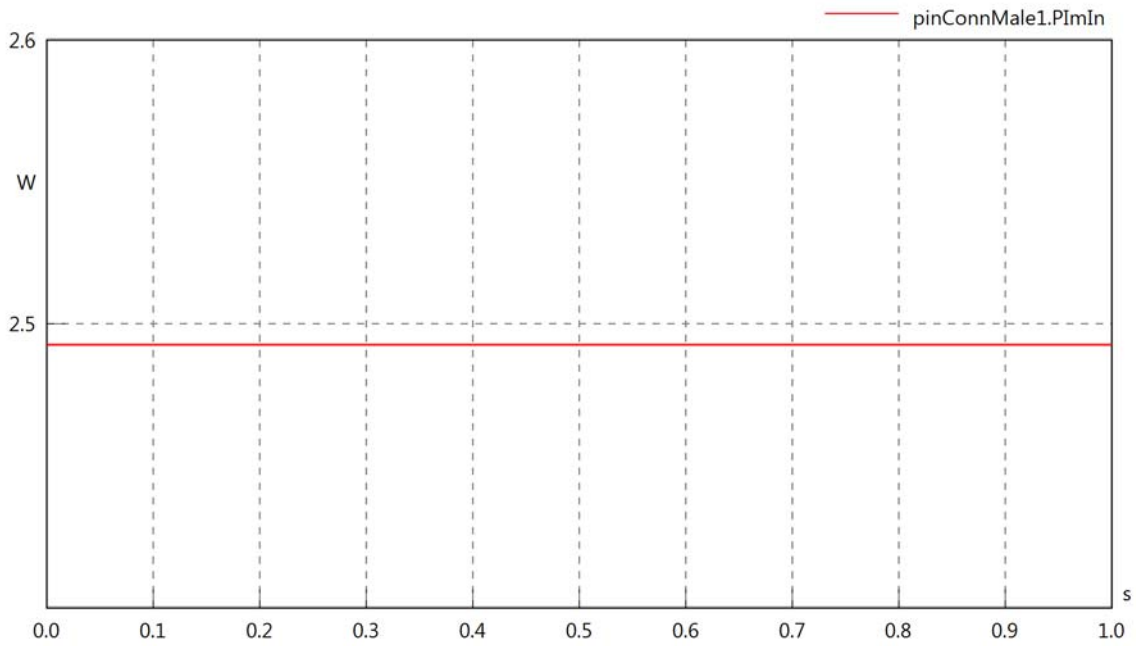

pinConnMale1.SIn

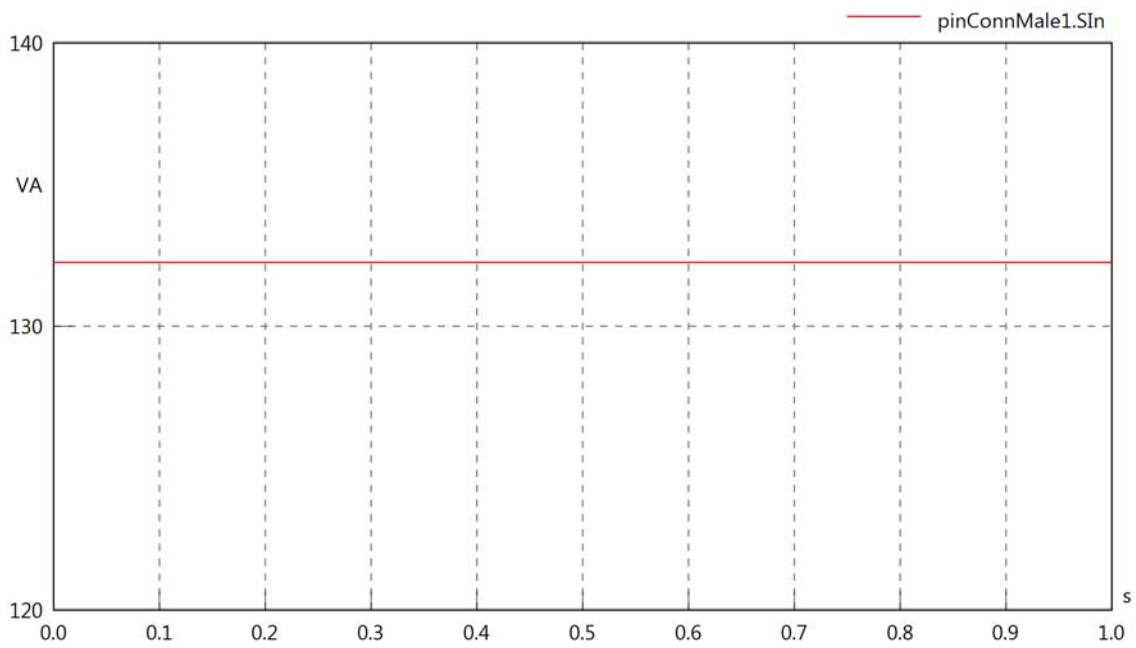

pinConnMale1.PReOut

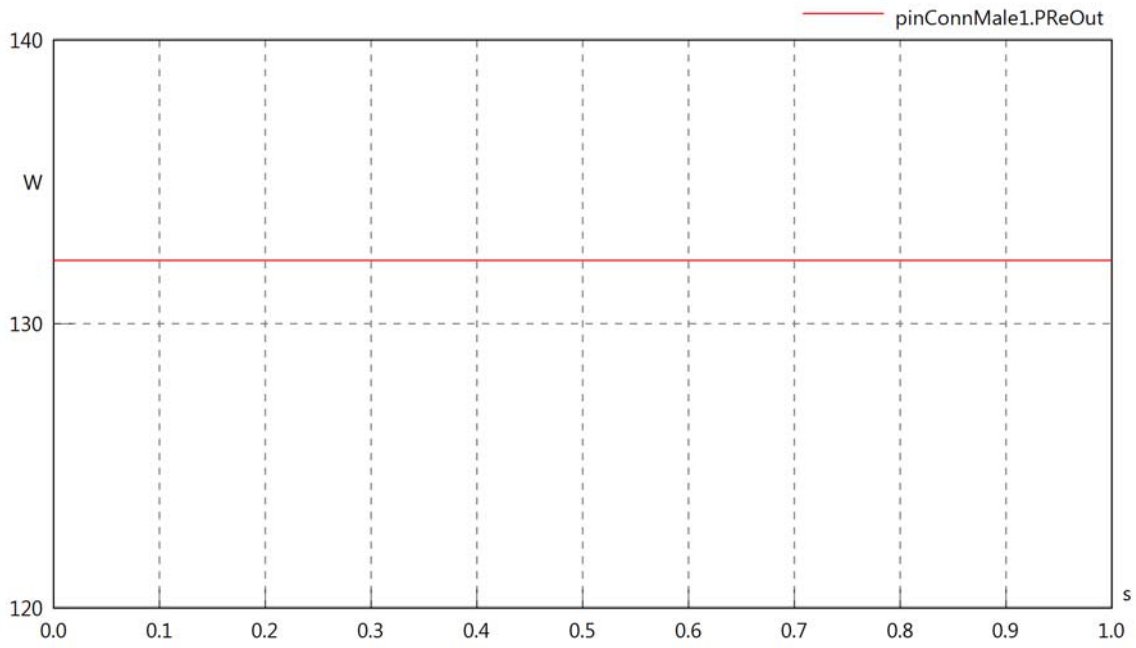

pinConnMale1.PImOut

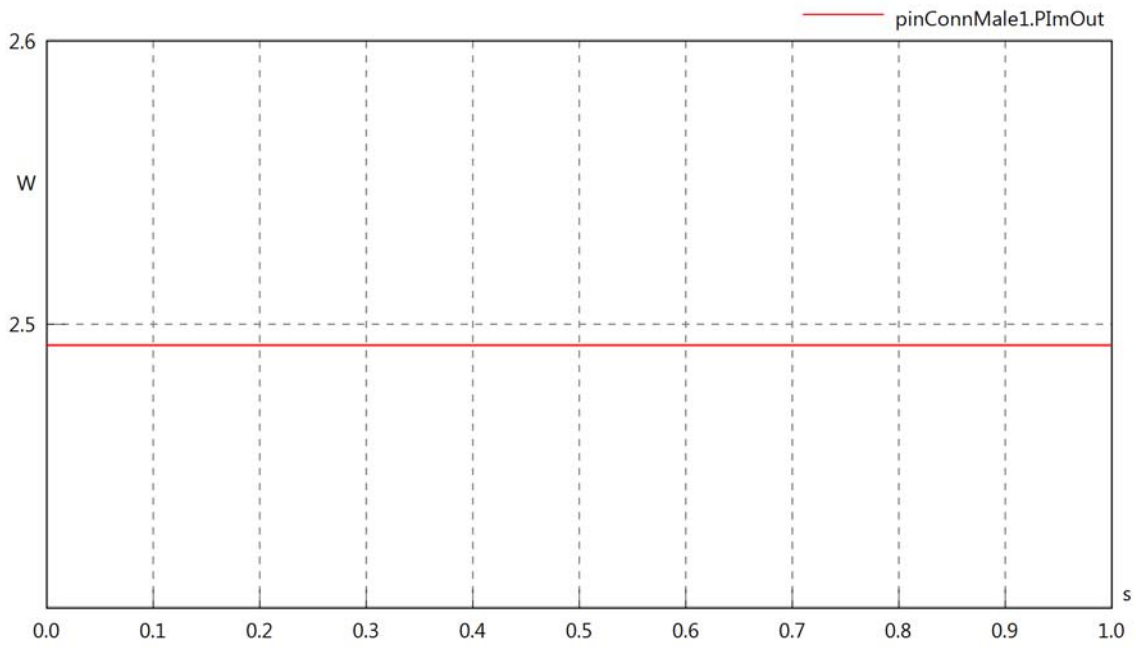

pinConnMale1.SOut

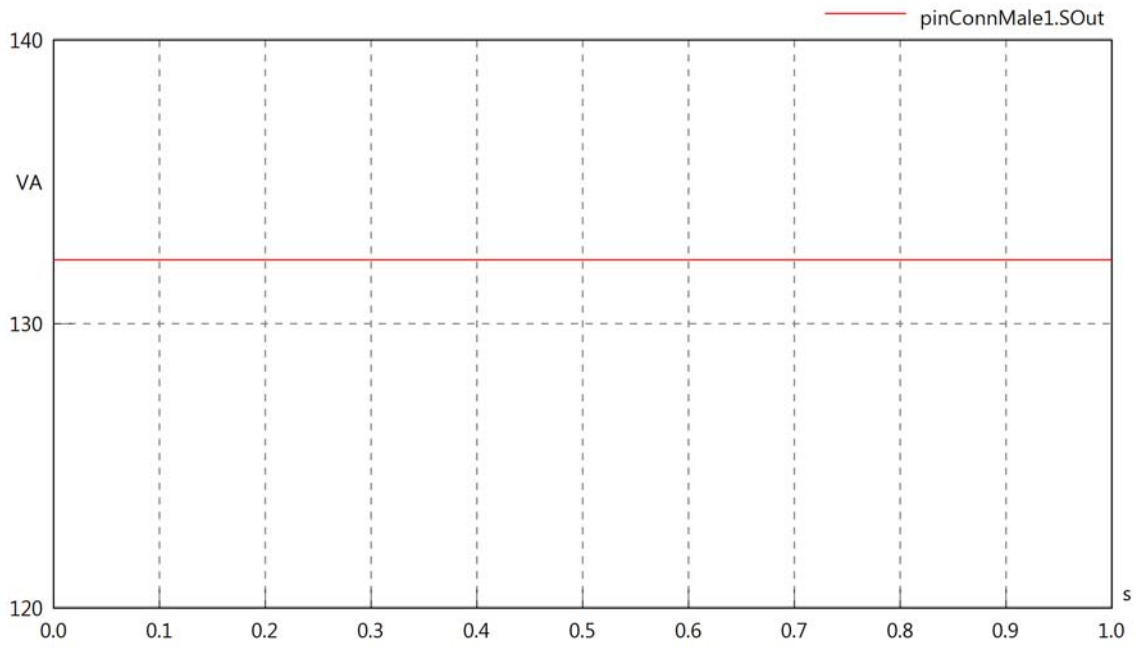
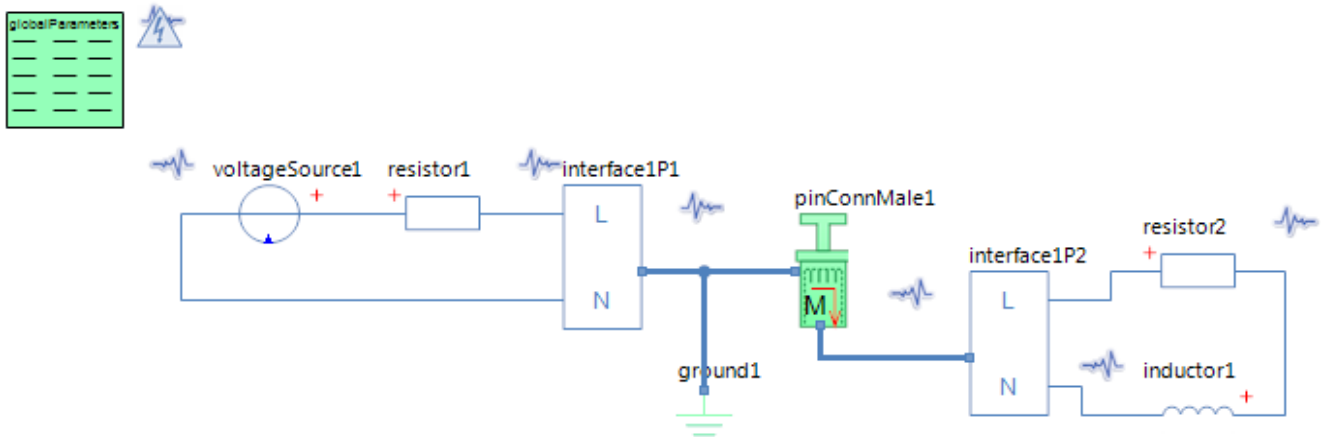

Diagram View



GlobalParameters globalParameters
Parameters

Comment	Name	Current Value	Unit
Type of Calculation	eCalculationKind	Signal Calculation	
Description of Frequency	eFrequencyKind	Linear	
Minimum Frequency	fMin	4000	[Hz]
Maximum Frequency	fMax	4000	[Hz]

Voltage Source voltageSource1
Parameters

Comment	Name	Current Value	Unit
Voltage RMS	VrmsSrc	230	[V]
Phase	phi	0	[deg]

Resistor resistor1
Parameters

Comment	Name	Current Value	Unit
Resistance	R	100	[Ohm]

Resistor resistor2
Parameters

Comment	Name	Current Value	Unit
Resistance	R	100	[Ohm]

Inductor inductor1
Parameters

Comment	Name	Current Value	Unit
Inductance	L	5	[mH]

Pin Connector Male pinConnMale1
Parameters

Comment	Name	Current Value	Unit
Poor or failing L1 connection	bL1	false	

pinConnMale1.VrmsIn

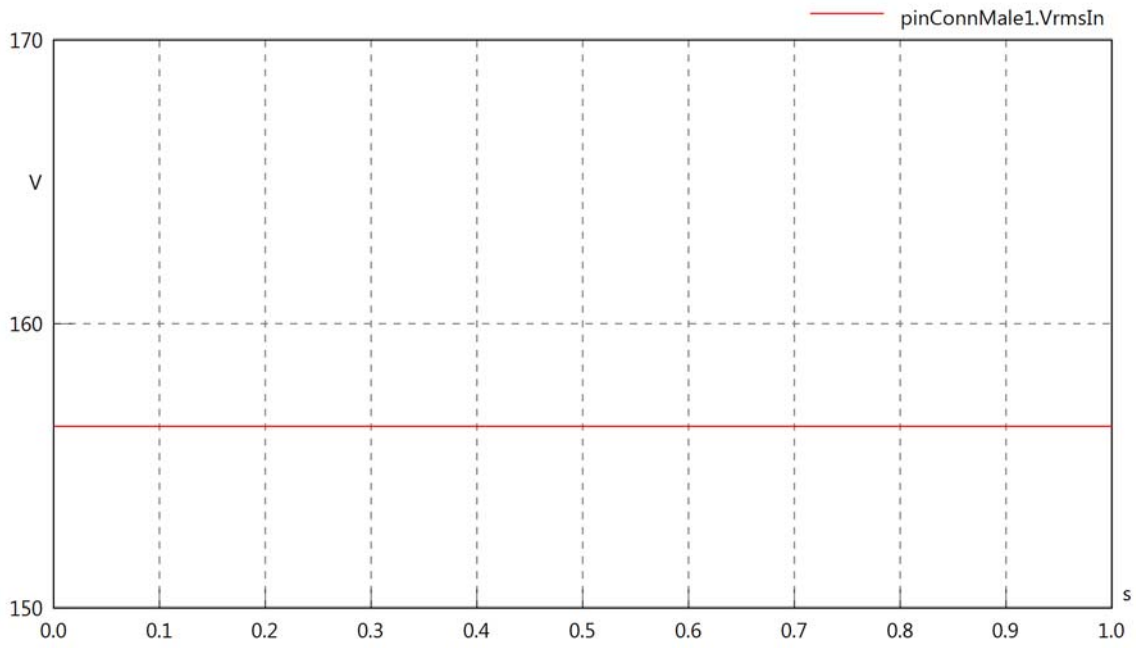

pinConnMale1.vReIn

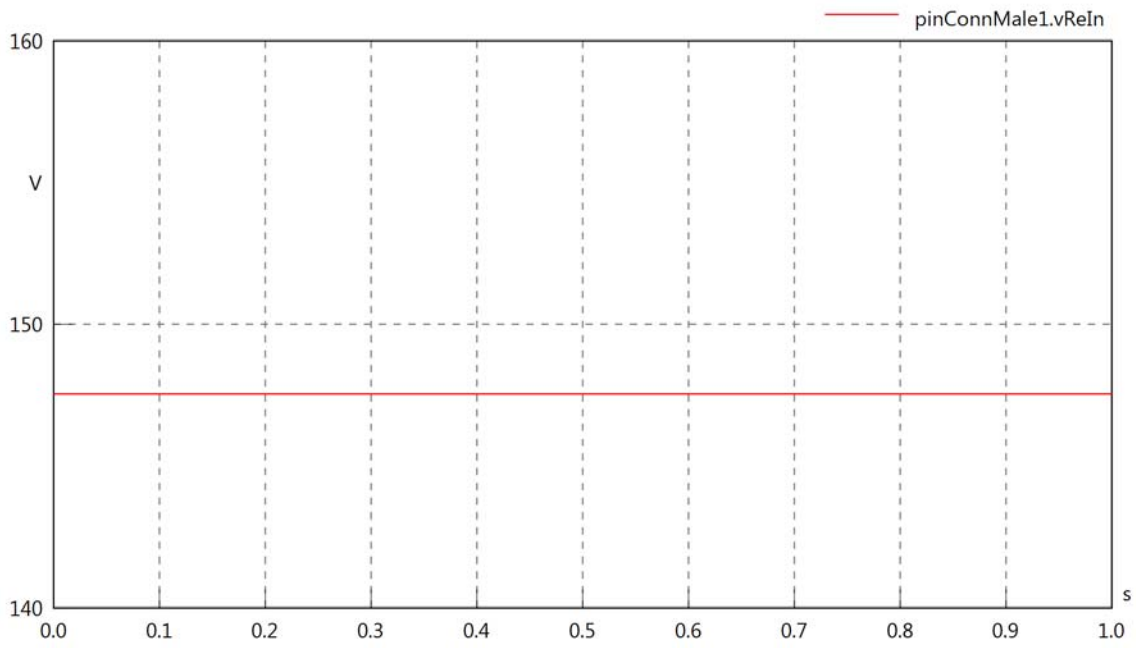

pinConnMale1.vImIn

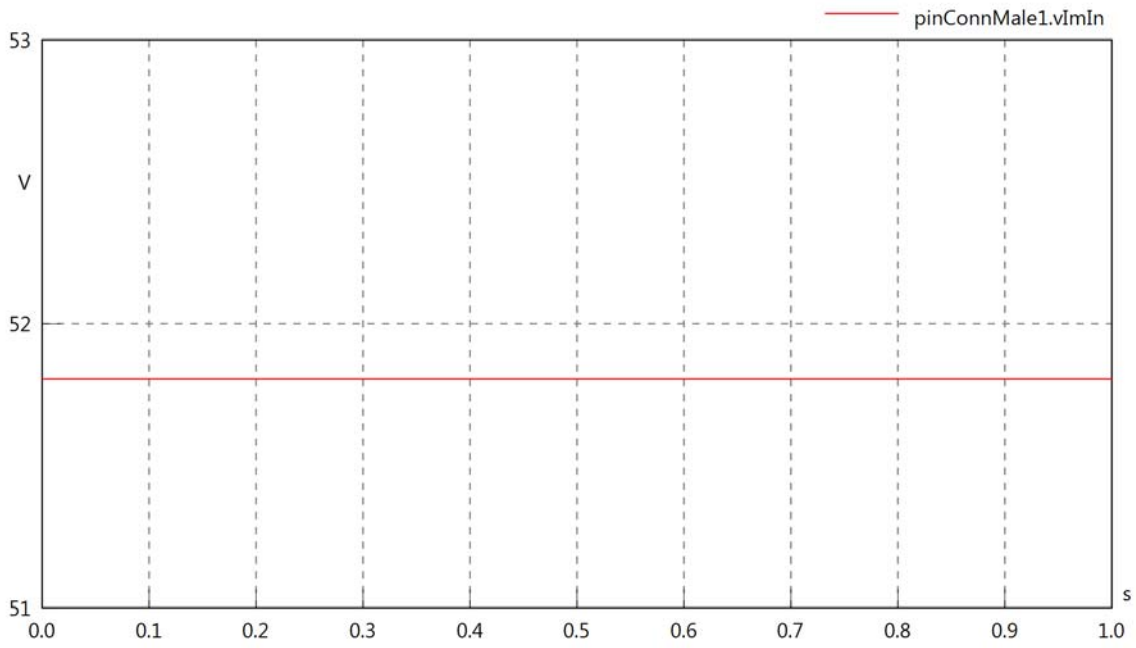

pinConnMale1.VrmsOut

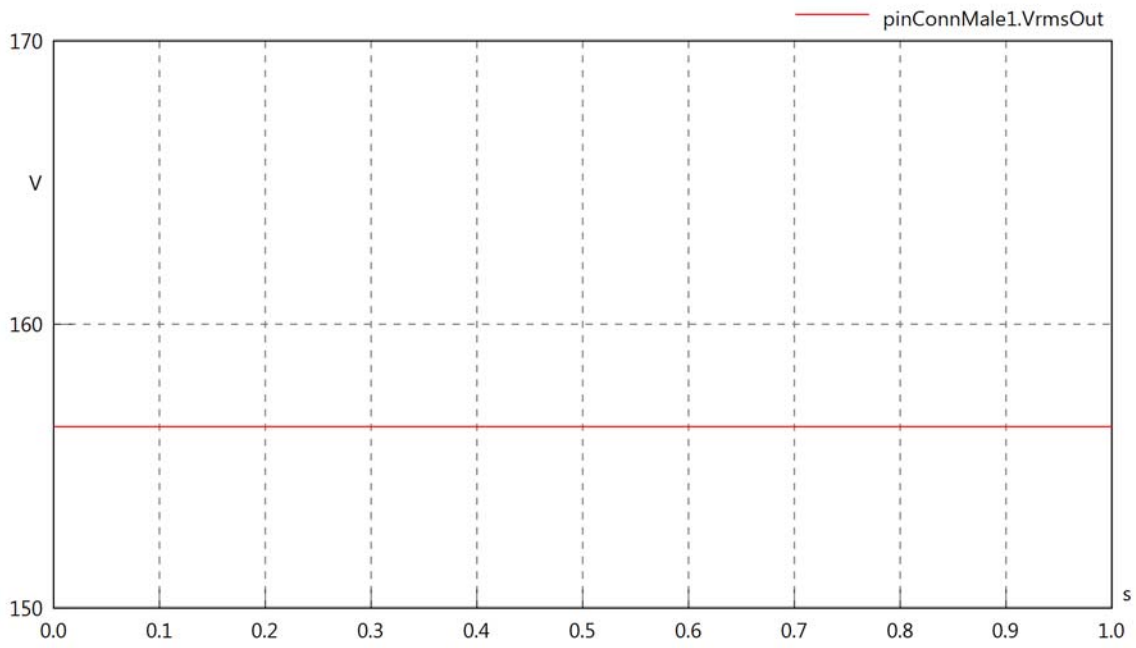

pinConnMale1.vReOut

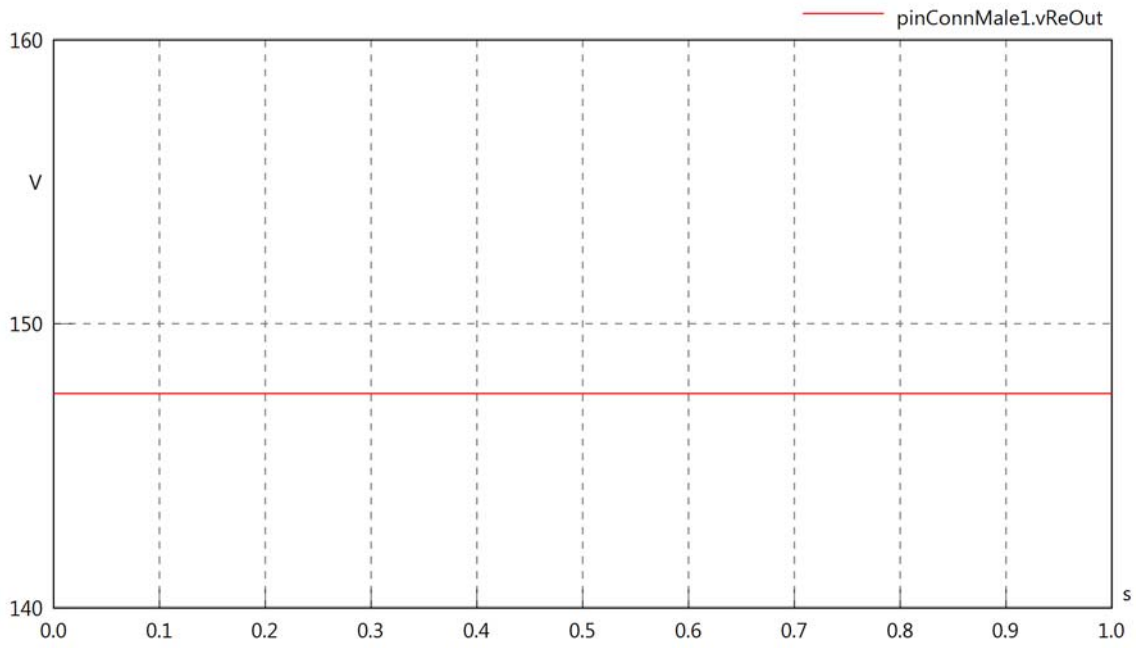

pinConnMale1.vImOut

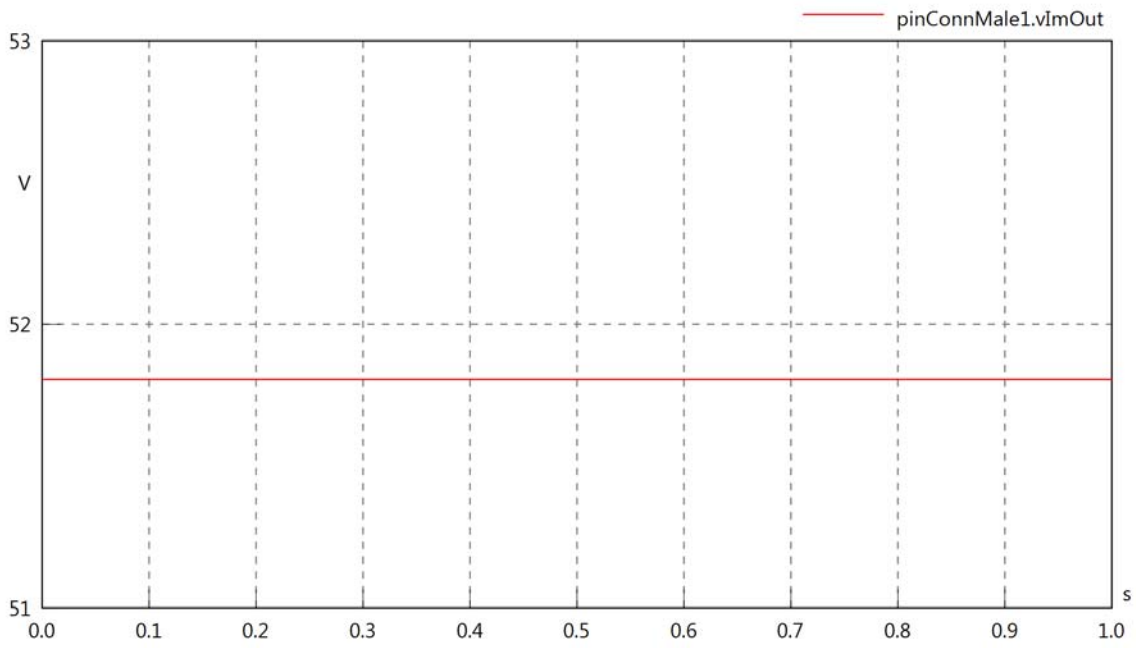

pinConnMale1.Vrms

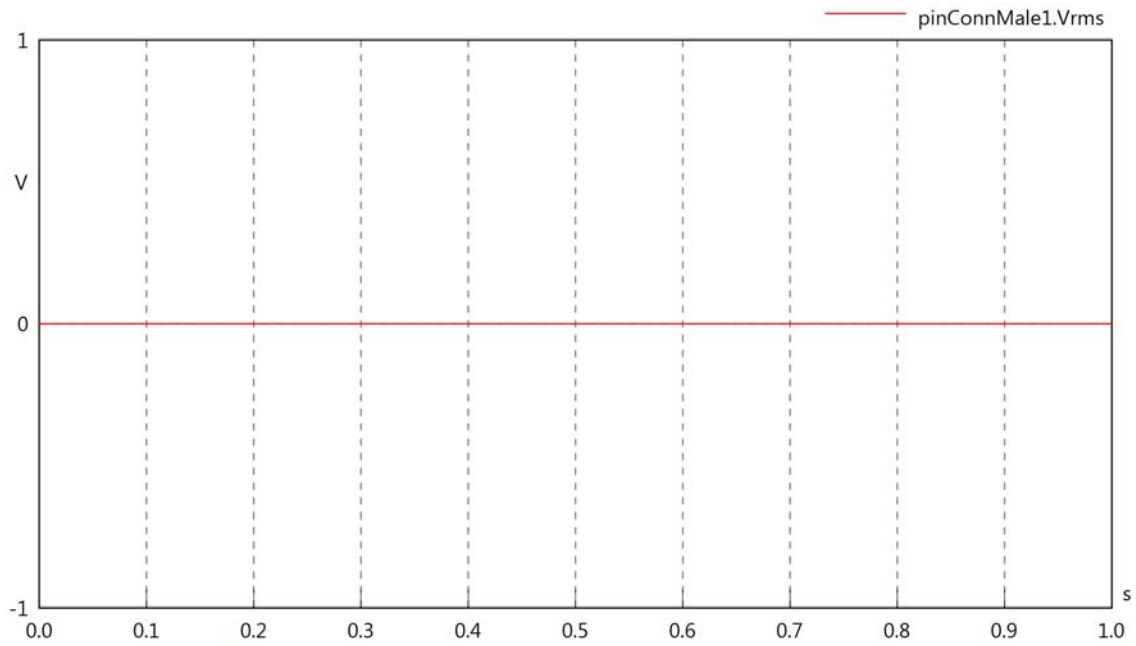

pinConnMale1.vRe

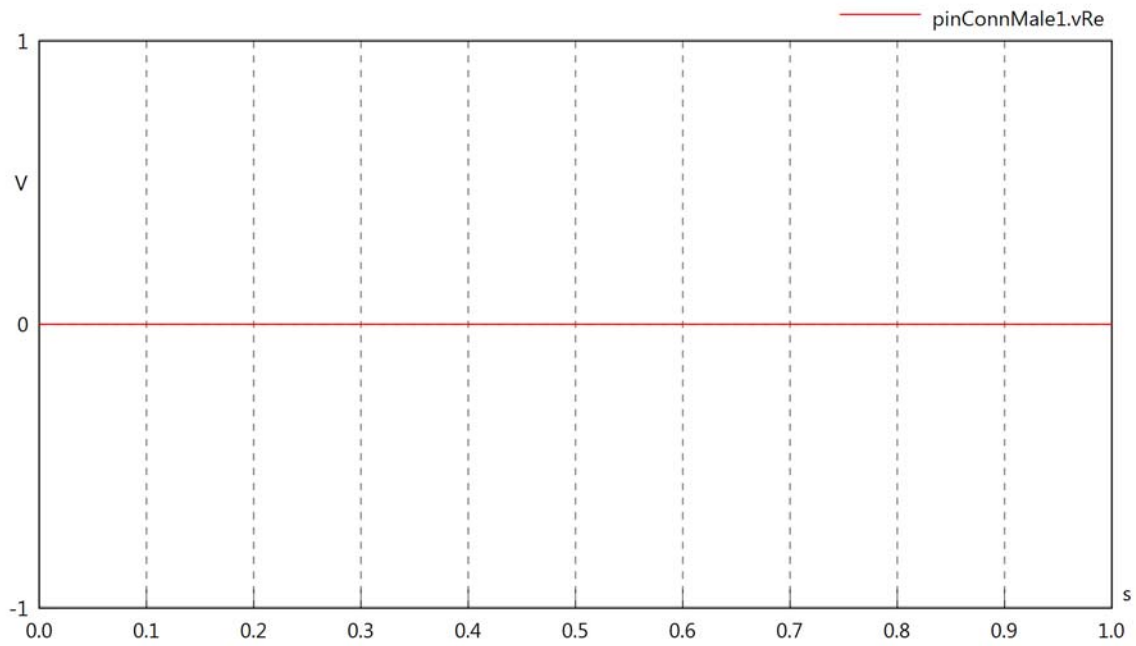

pinConnMale1.vIm

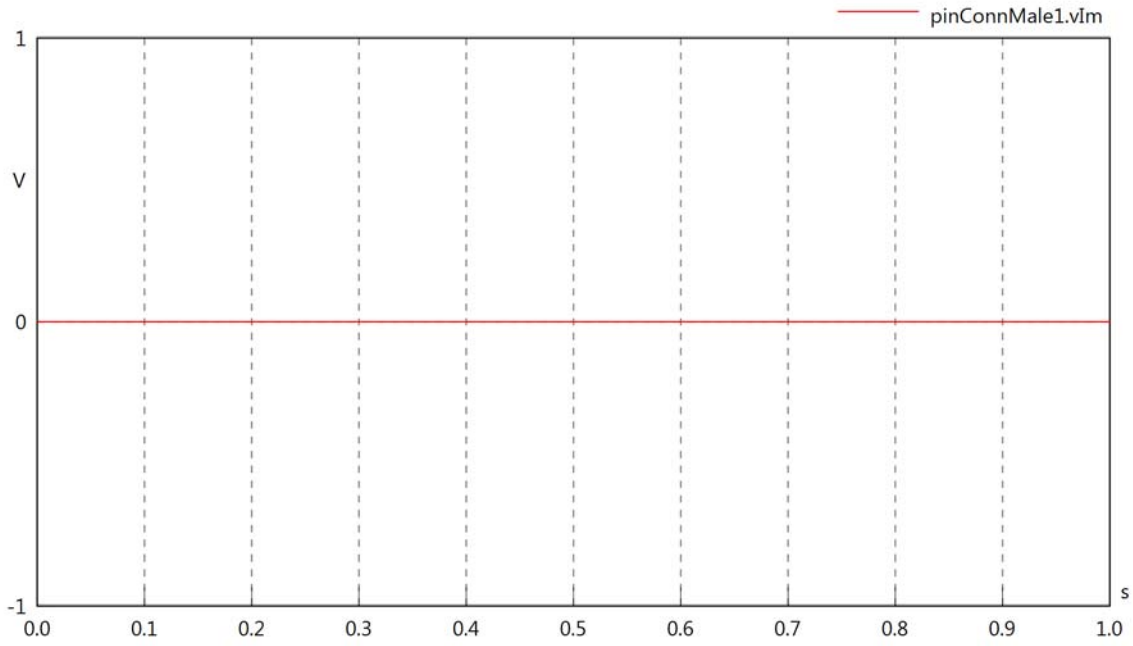

pinConnMale1.IrmsIn

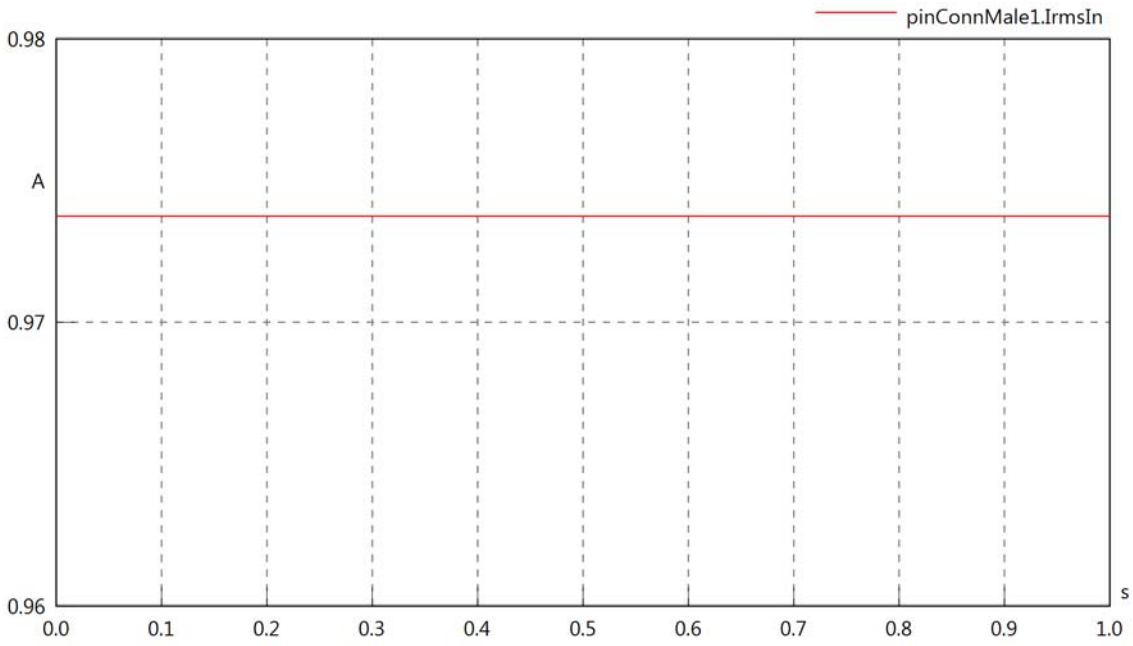

pinConnMale1.iReIn

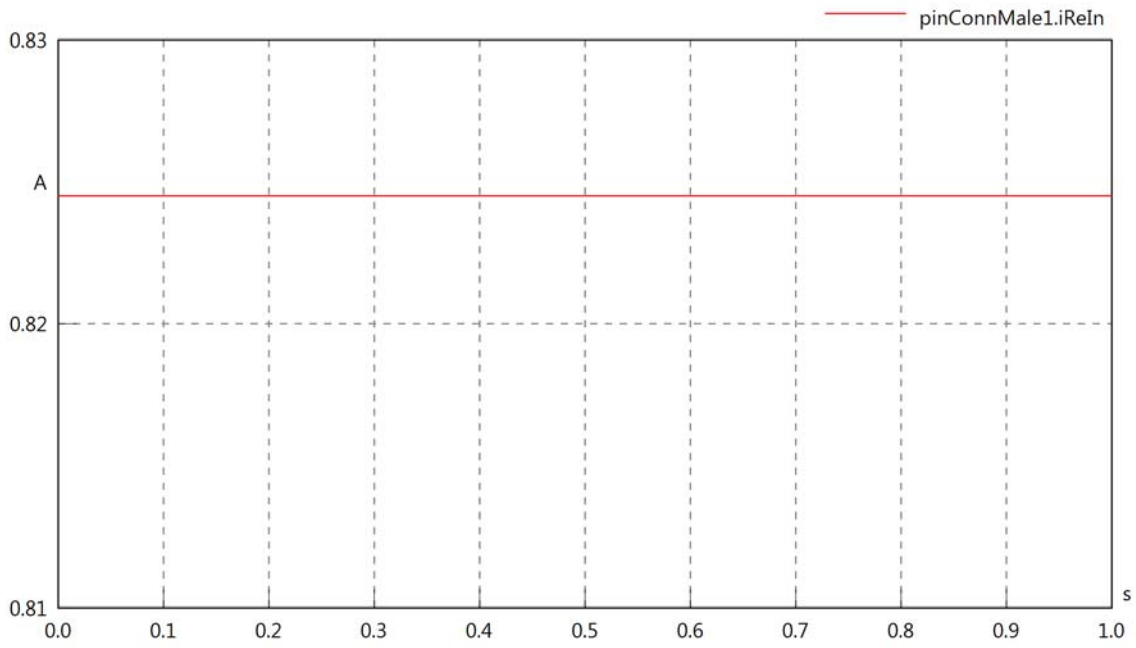

pinConnMale1.iImIn

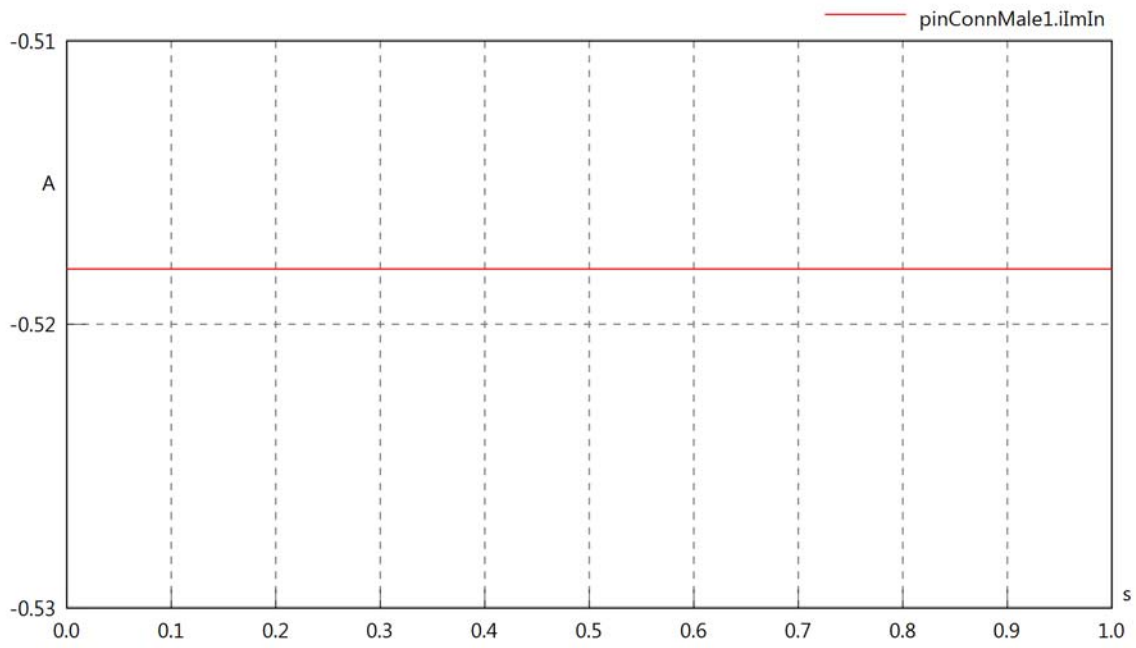

pinConnMale1.IrmsOut

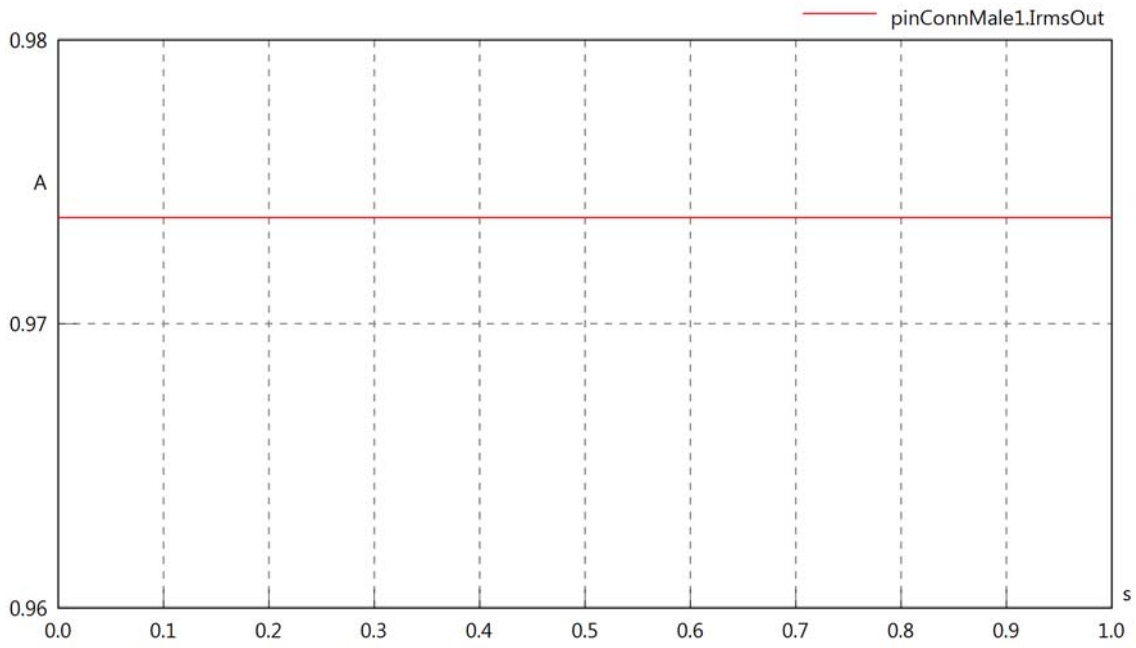

pinConnMale1.iReOut

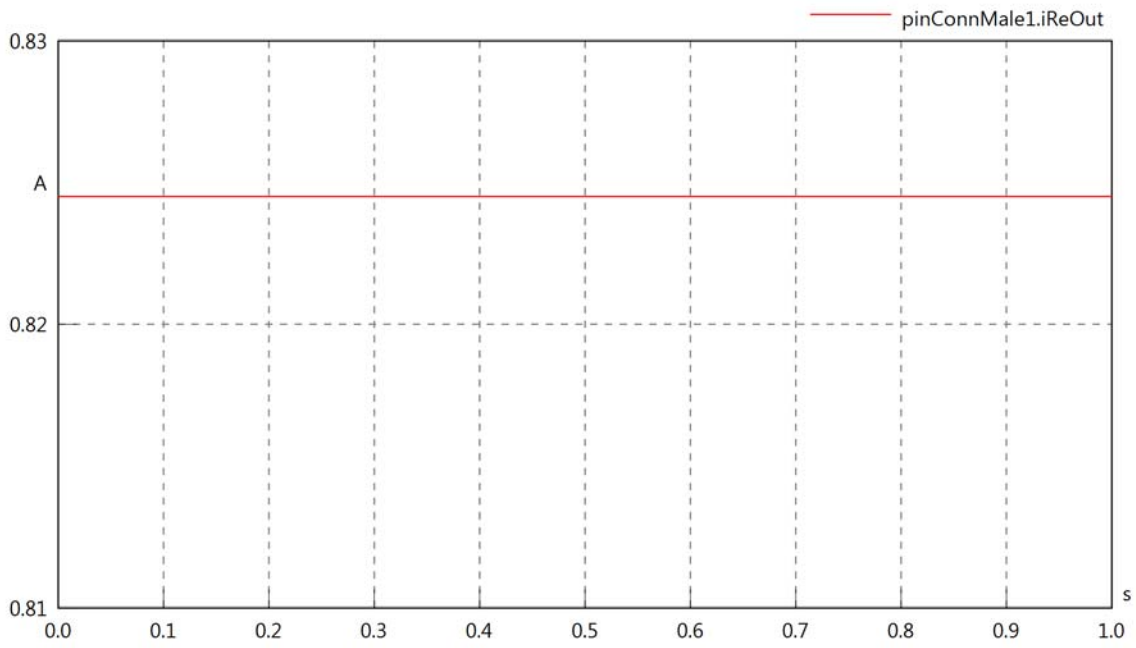

pinConnMale1.iImOut

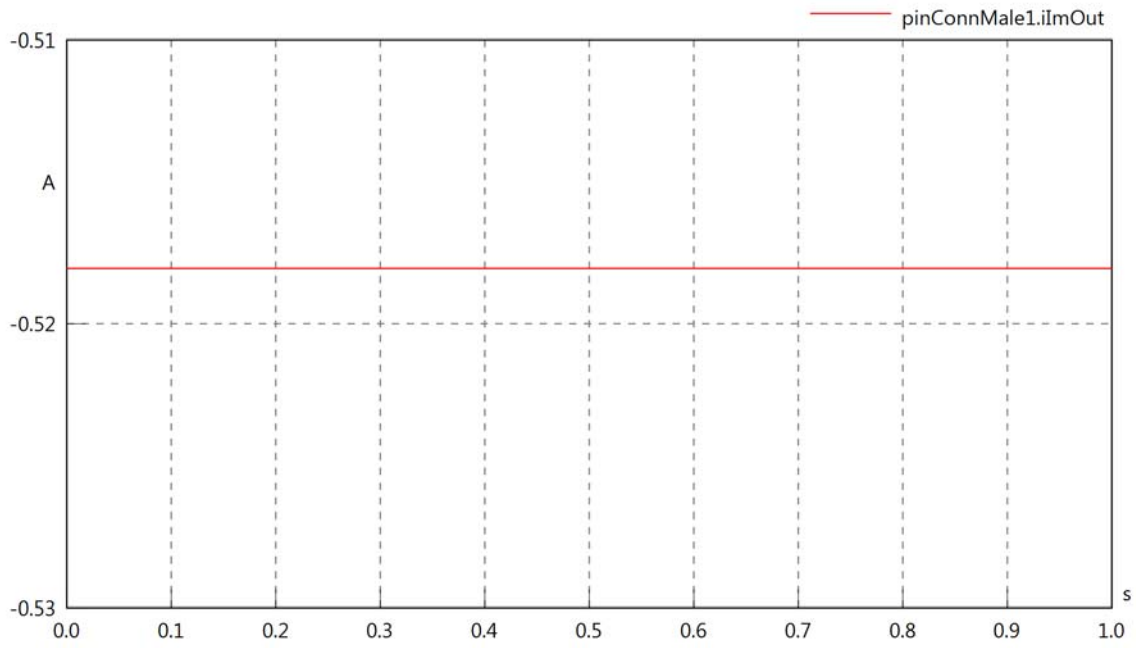

pinConnMale1.phiVIn

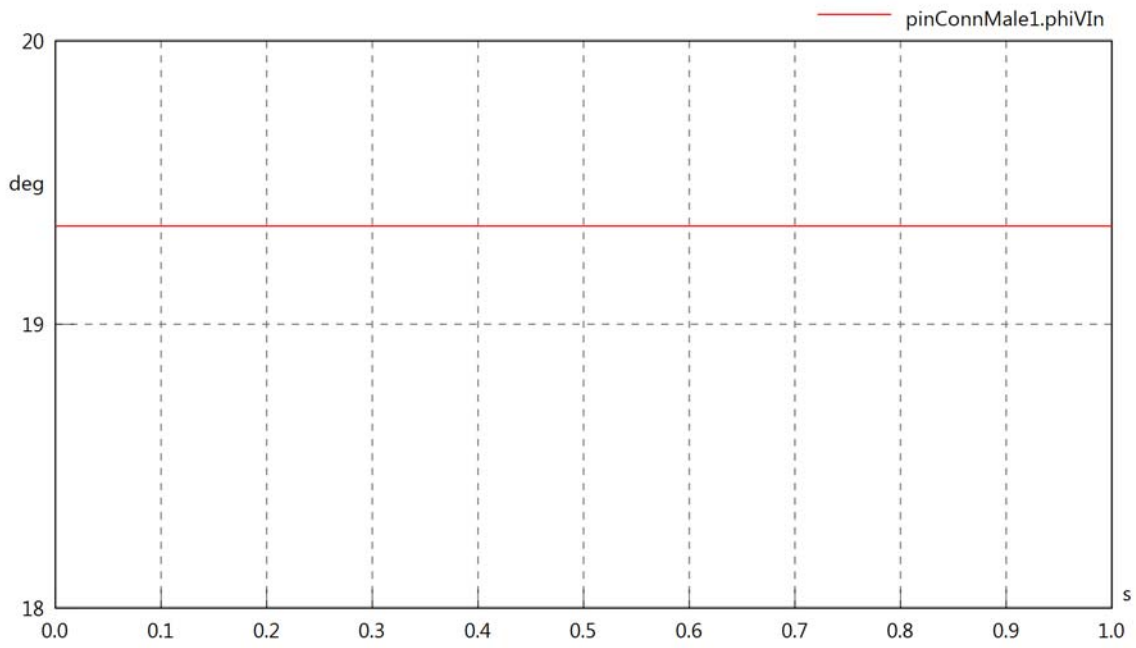

pinConnMale1.phiIIn

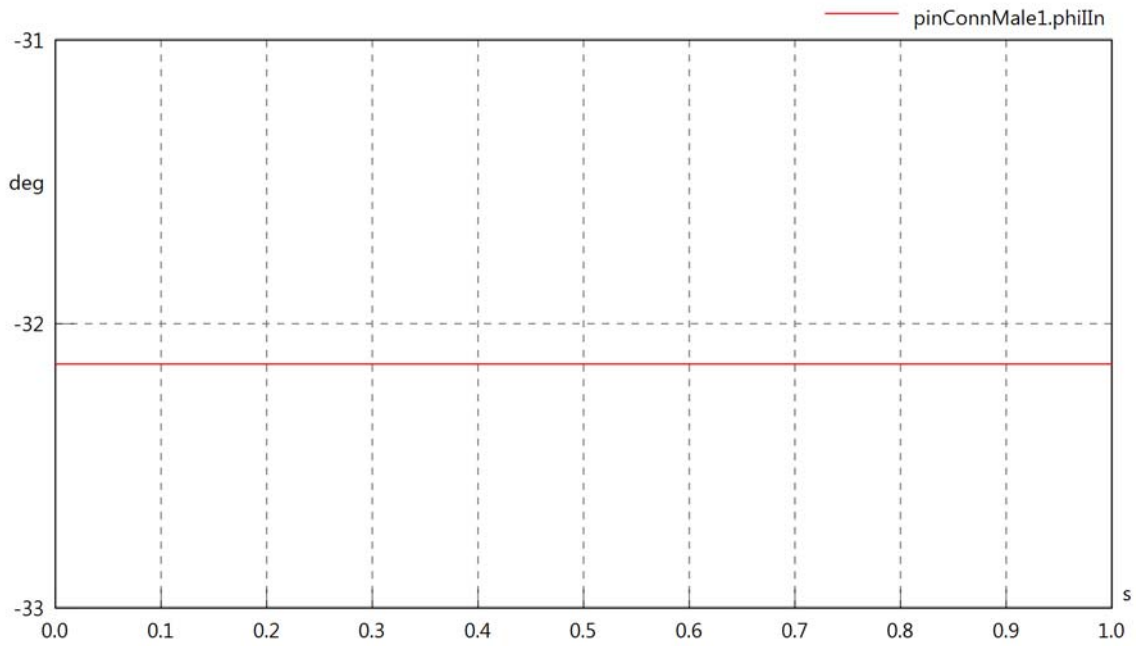

pinConnMale1.phiIVIn

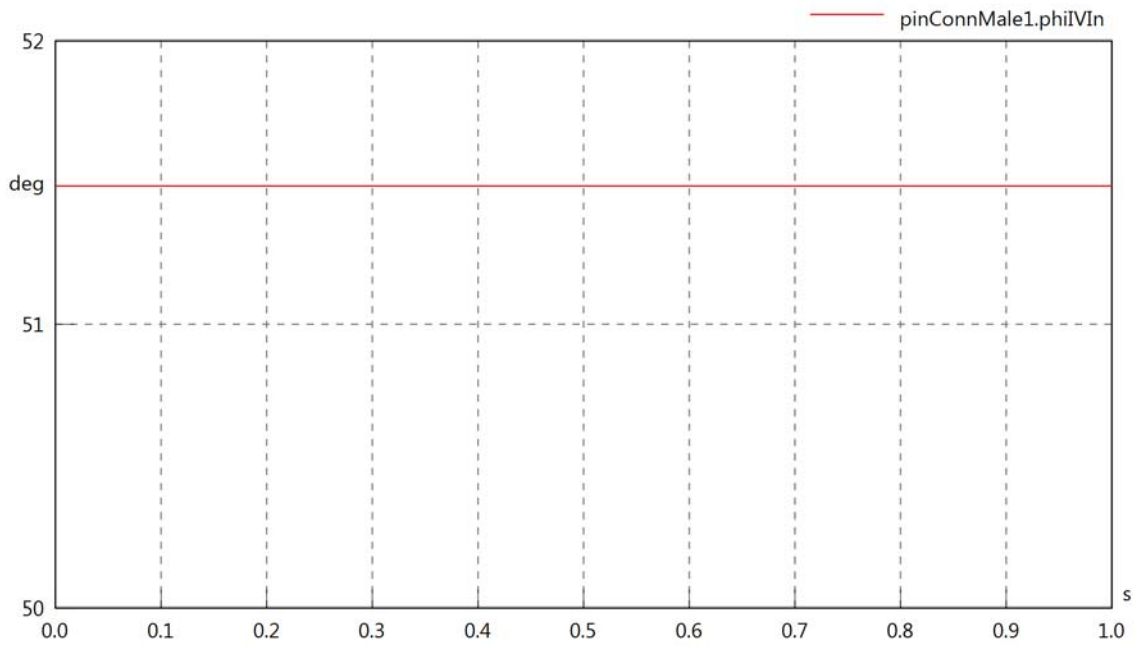

pinConnMale1.phiVOut

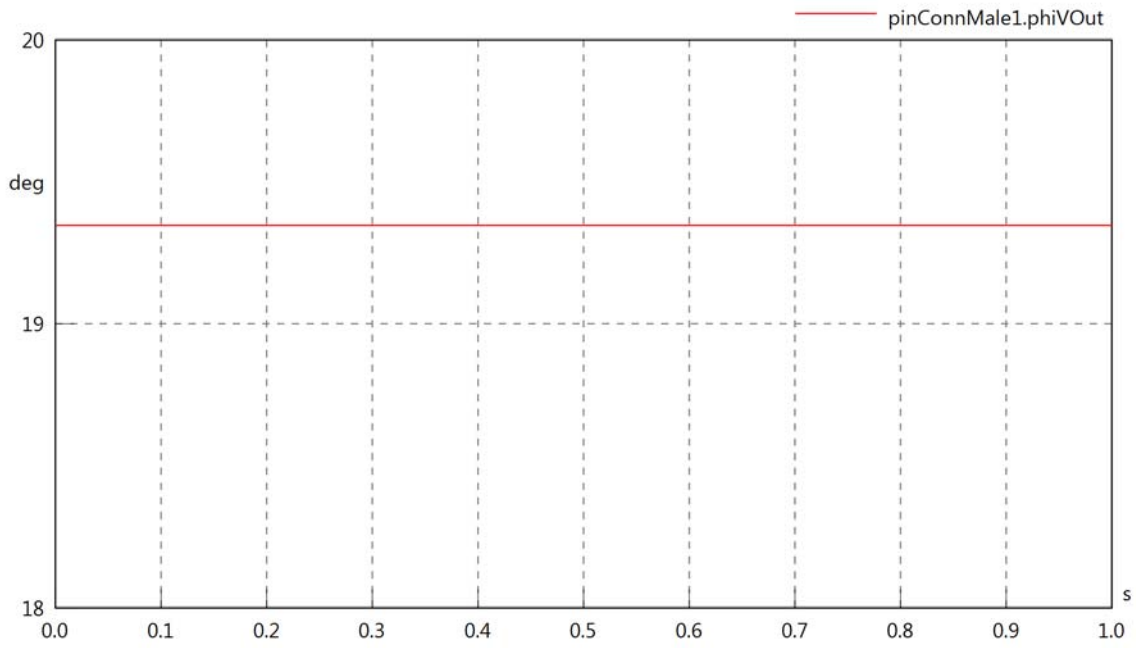

pinConnMale1.phiIOut

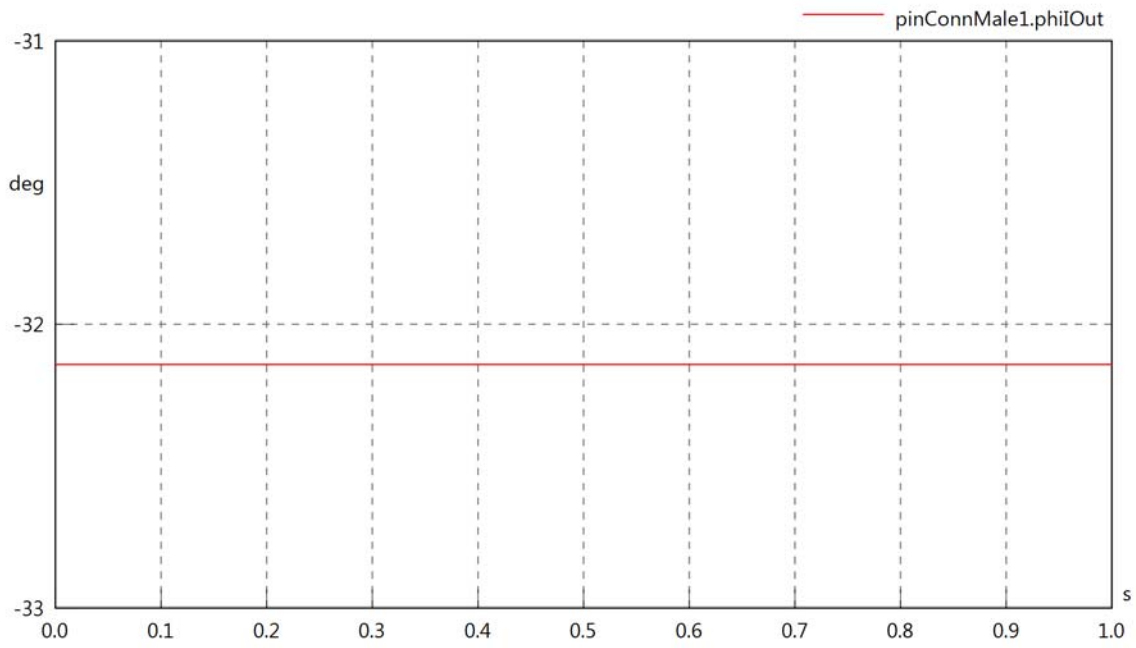

pinConnMale1.phiIVOut

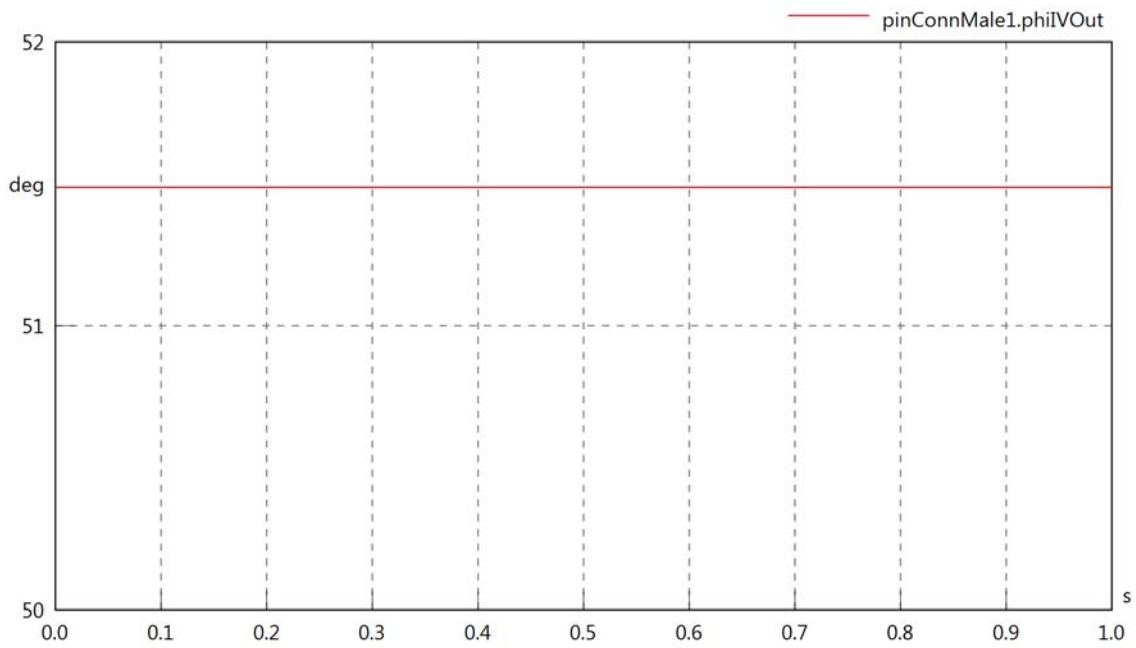

pinConnMale1.PReIn

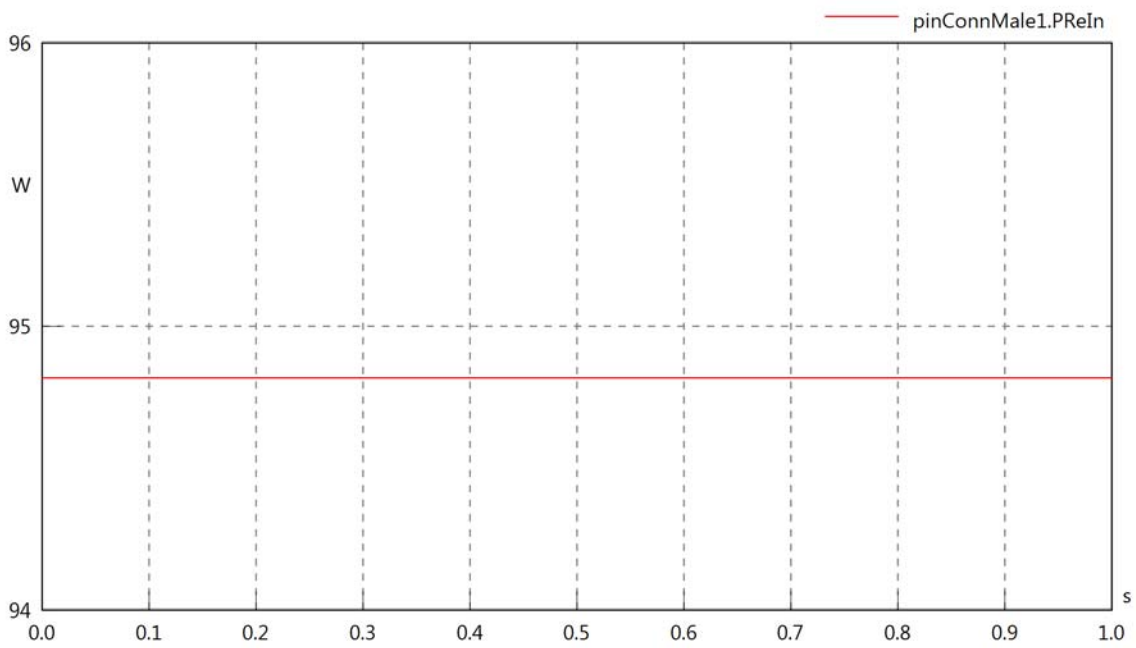

pinConnMale1.PImIn

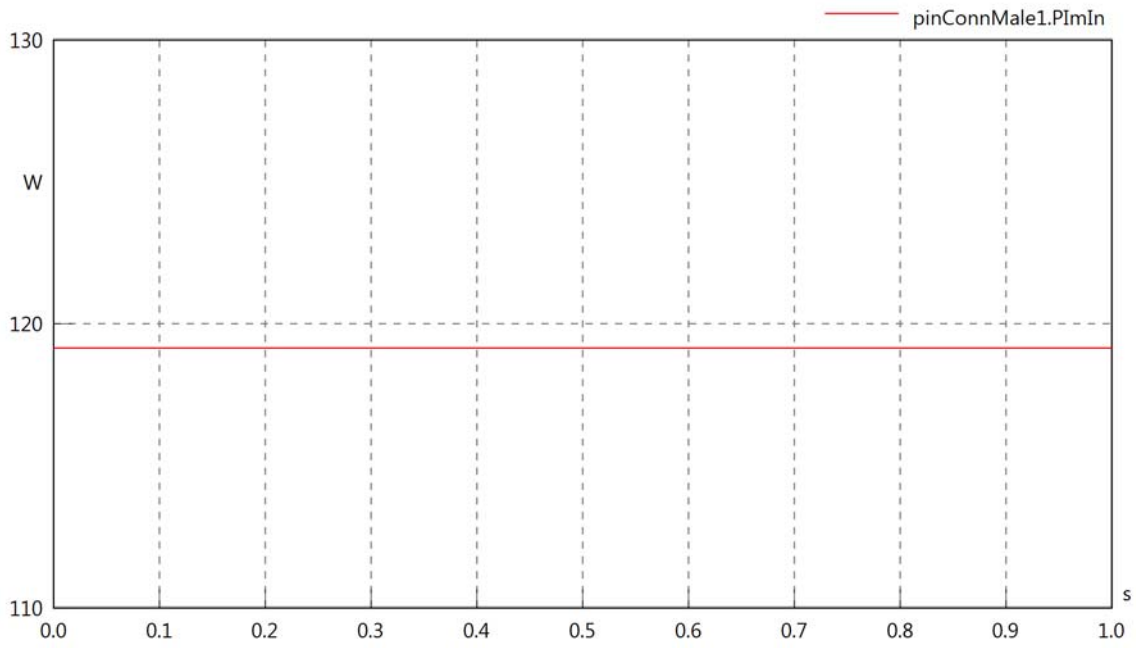

pinConnMale1.SIn

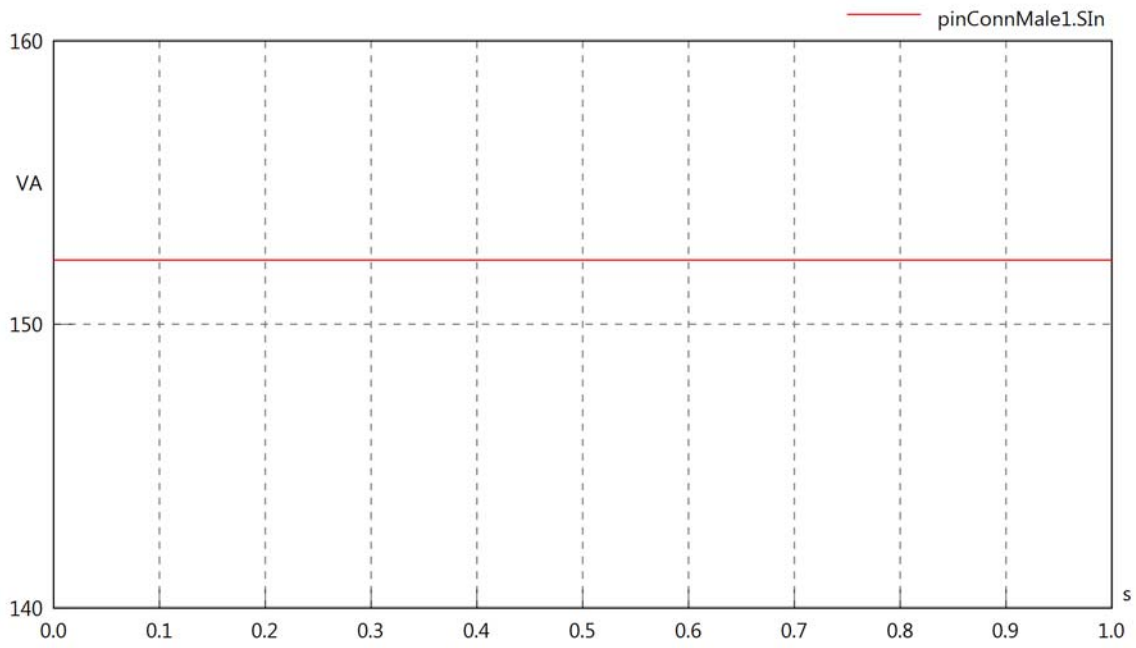

pinConnMale1.PReOut

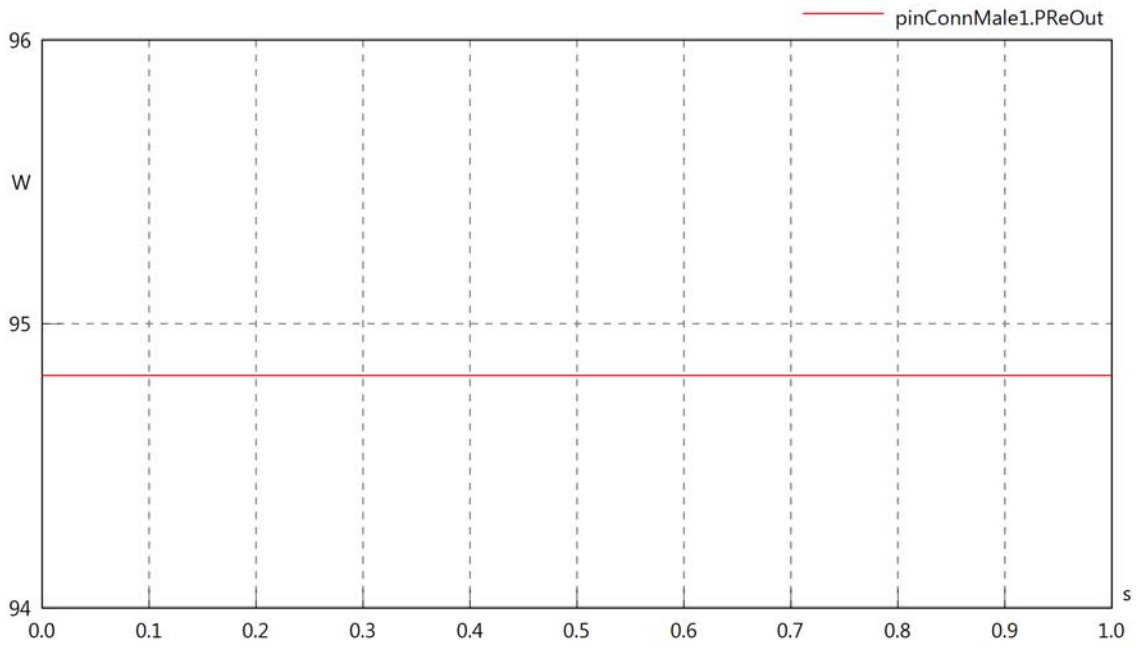

pinConnMale1.PImOut

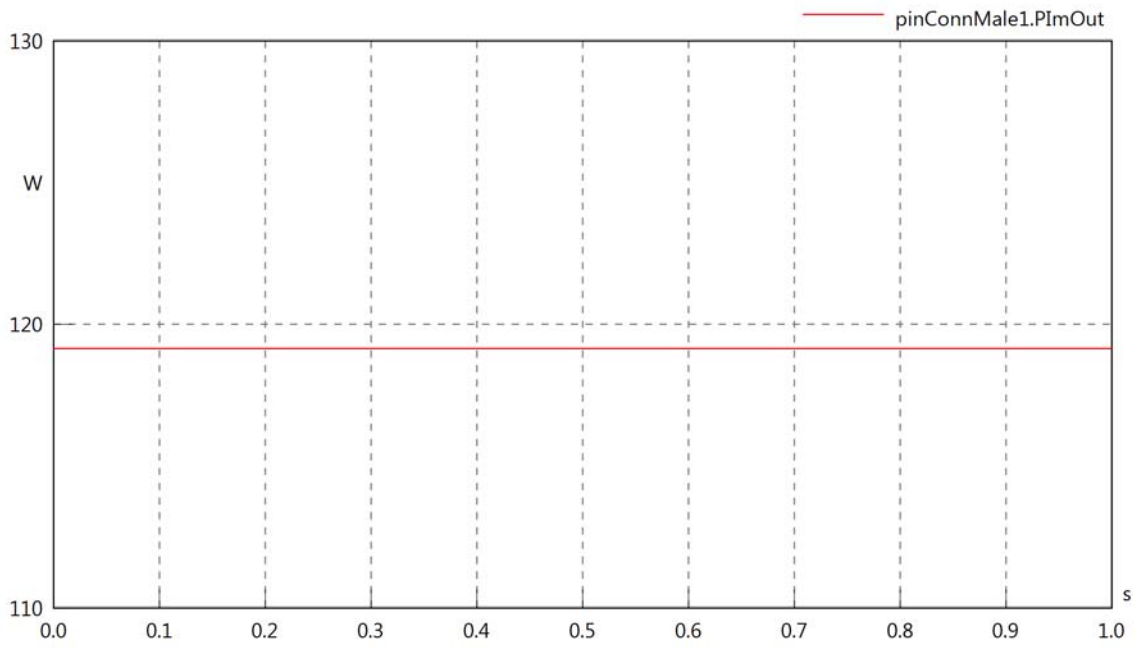

pinConnMale1.SOut

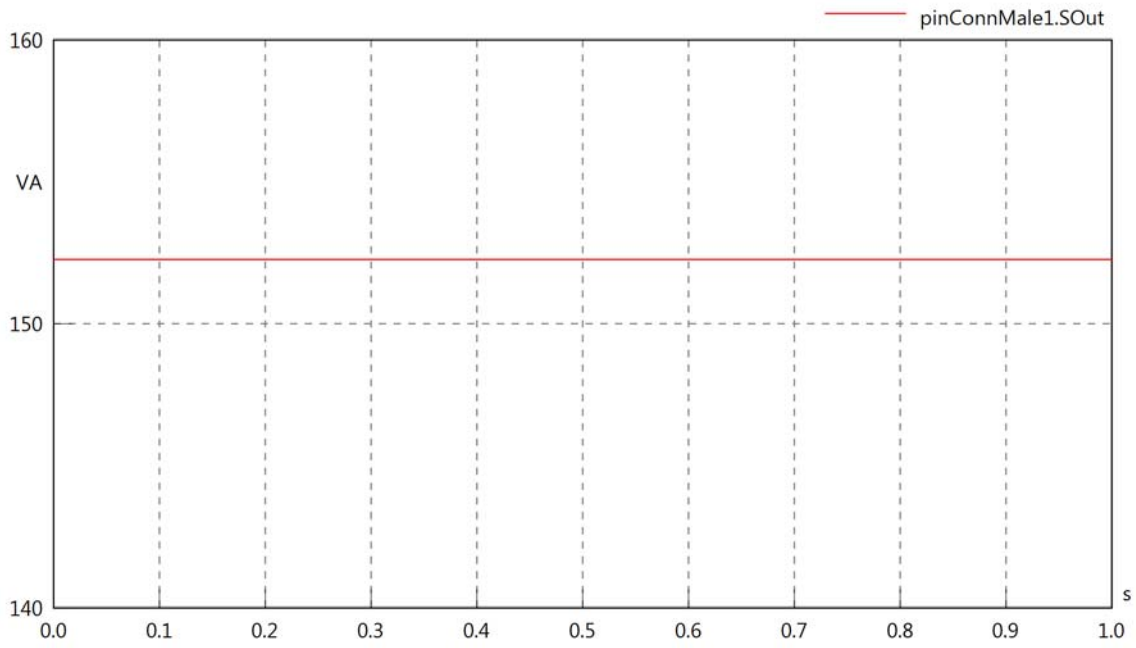
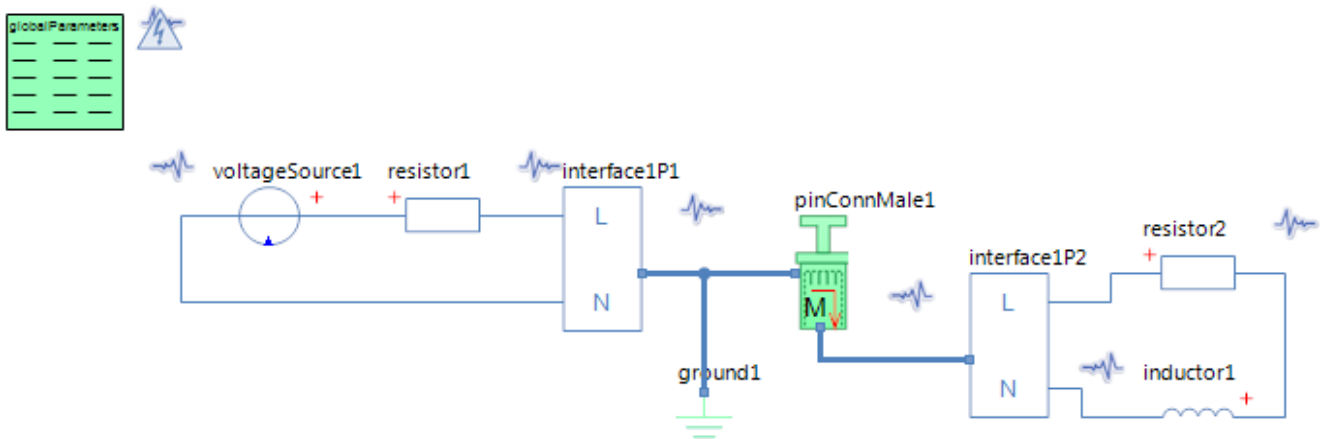

Diagram View



GlobalParameters globalParameters
Parameters

Comment	Name	Current Value	Unit
Type of Calculation	eCalculationKind	Signal Calculation	
Description of Frequency	eFrequencyKind	Linear	
Minimum Frequency	fMin	20000	[Hz]
Maximum Frequency	fMax	20000	[Hz]

Voltage Source voltageSource1
Parameters

Comment	Name	Current Value	Unit
Voltage RMS	VrmsSrc	230	[V]
Phase	phi	0	[deg]

Resistor resistor1
Parameters

Comment	Name	Current Value	Unit
Resistance	R	100	[Ohm]

Resistor resistor2
Parameters

Comment	Name	Current Value	Unit
Resistance	R	100	[Ohm]

Inductor inductor1
Parameters

Comment	Name	Current Value	Unit
Inductance	L	5	[mH]

Pin Connector Male pinConnMale1
Parameters

Comment	Name	Current Value	Unit
Poor or failing L1 connection	bL1	false	

pinConnMale1.VrmsIn

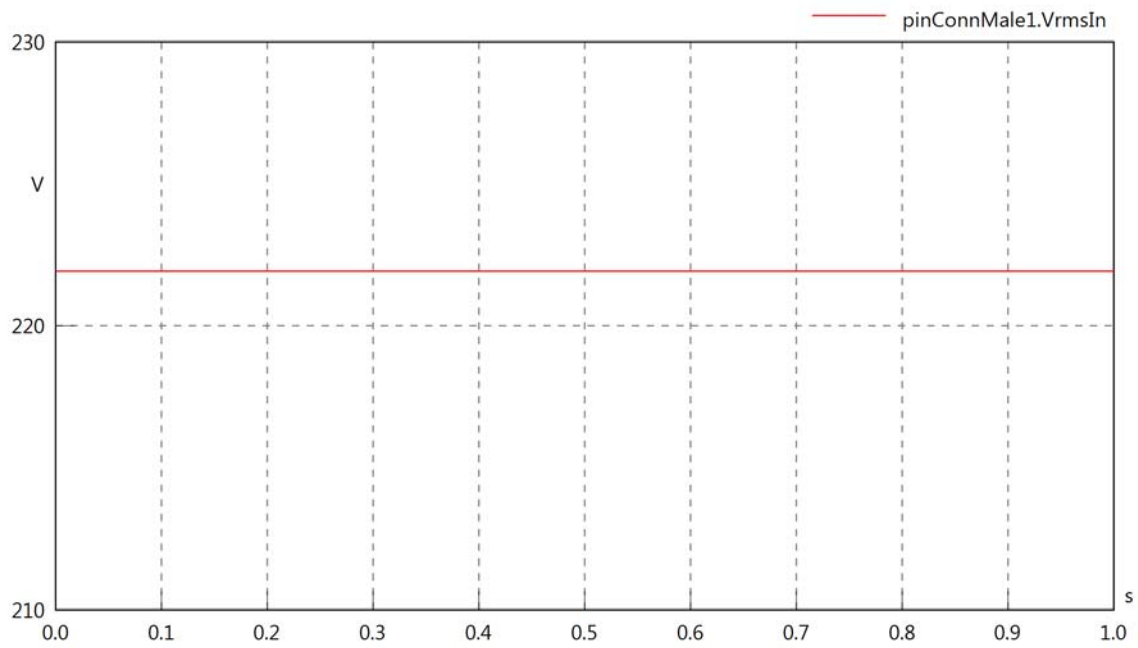

pinConnMale1.vReIn

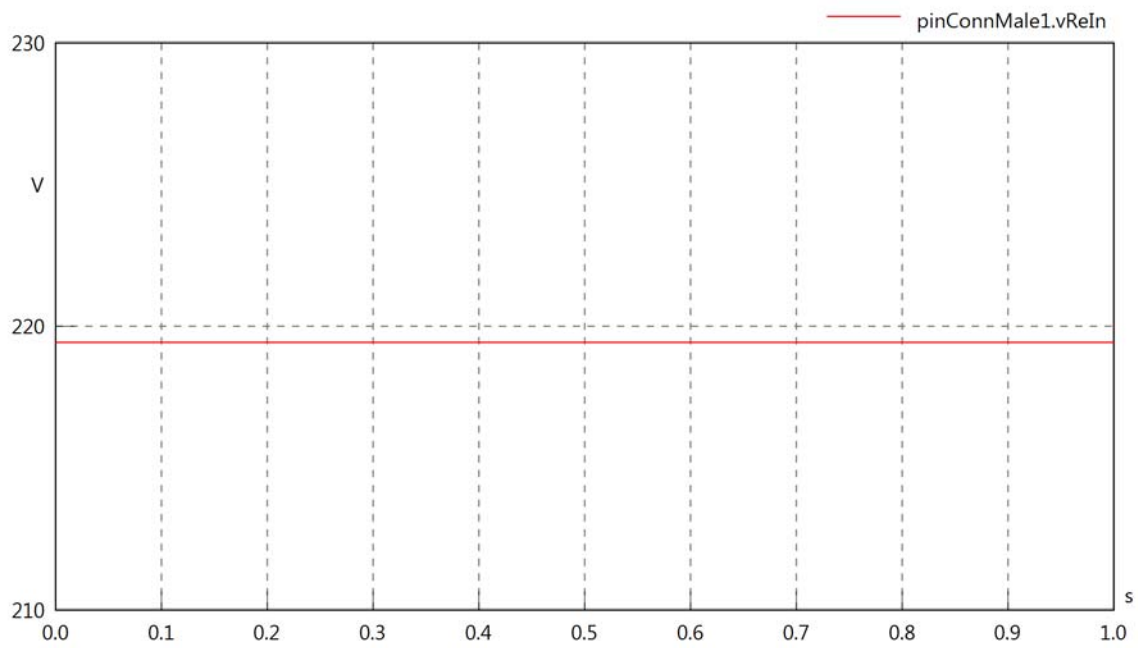

pinConnMale1.vImIn

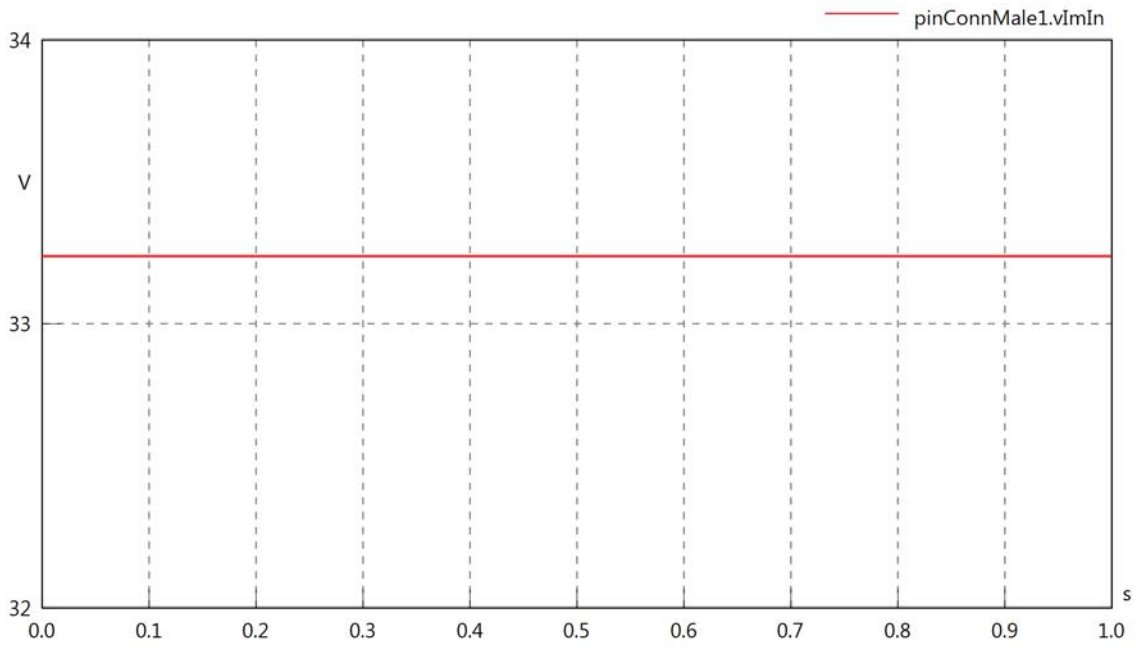

pinConnMale1.VrmsOut

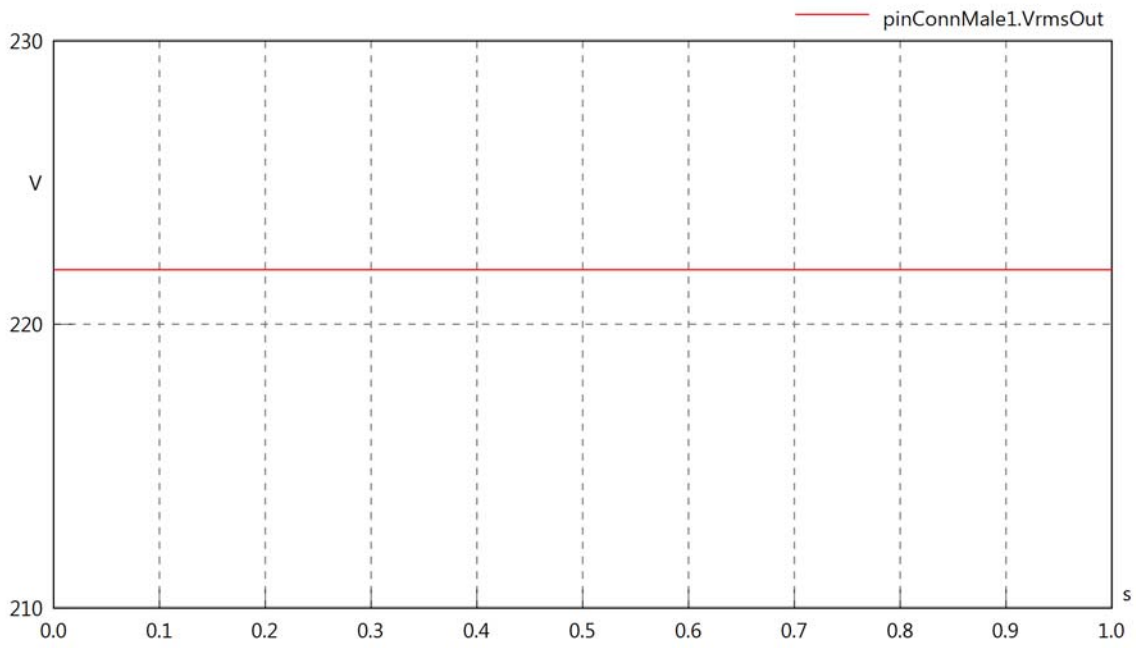

pinConnMale1.vReOut

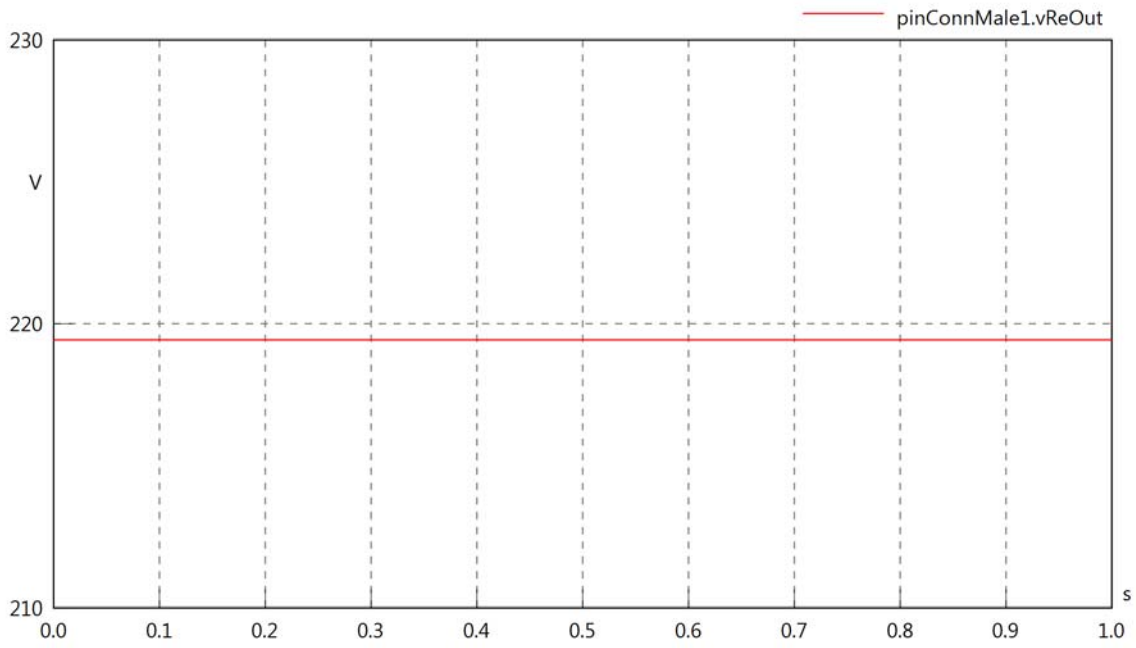

pinConnMale1.vImOut

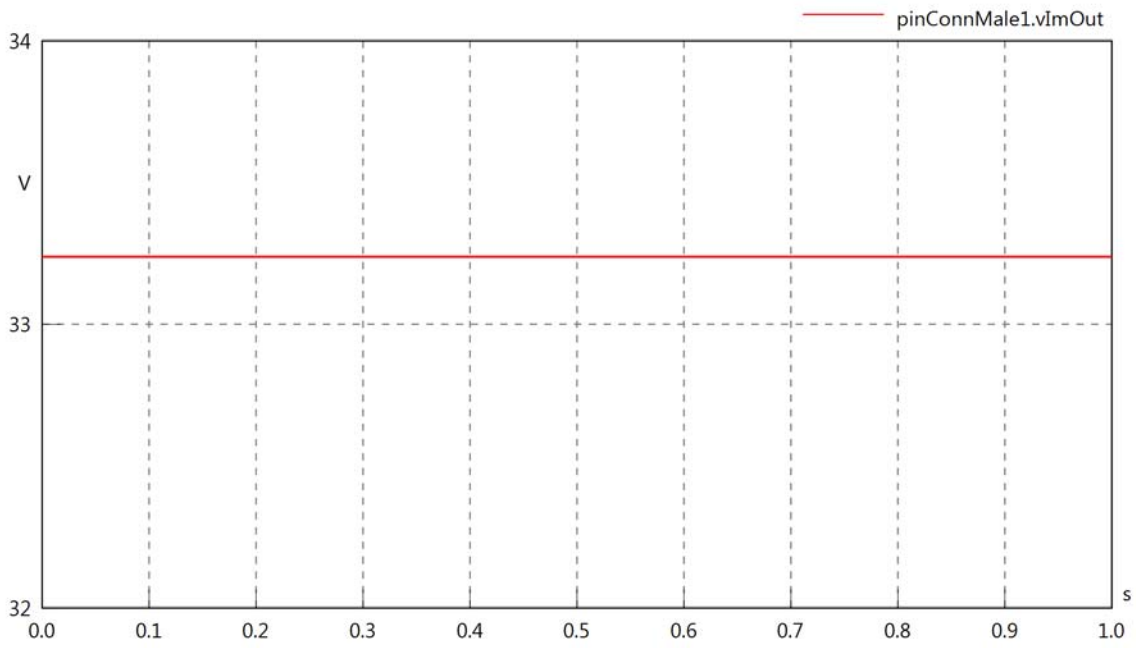

pinConnMale1.Vrms

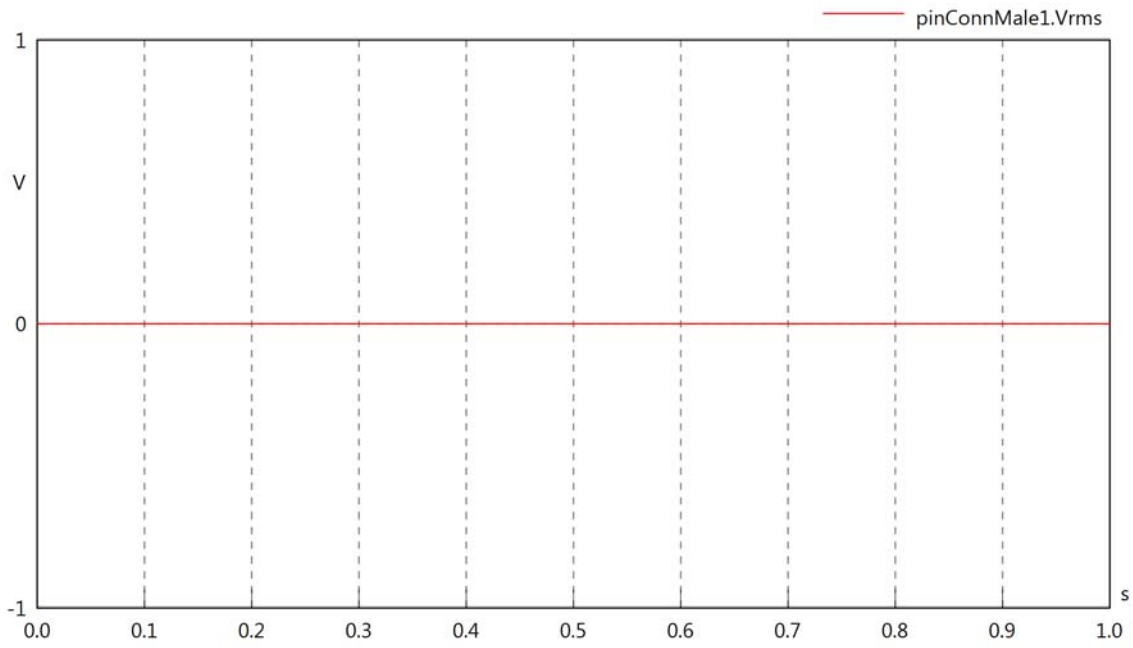

pinConnMale1.vRe

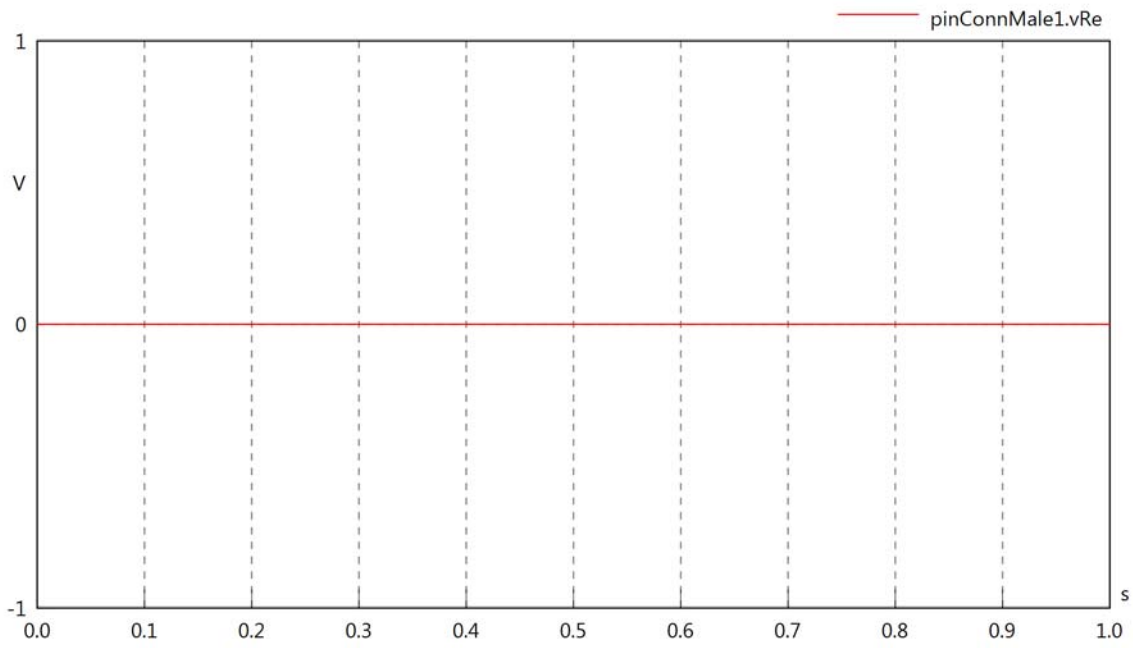

pinConnMale1.vIm

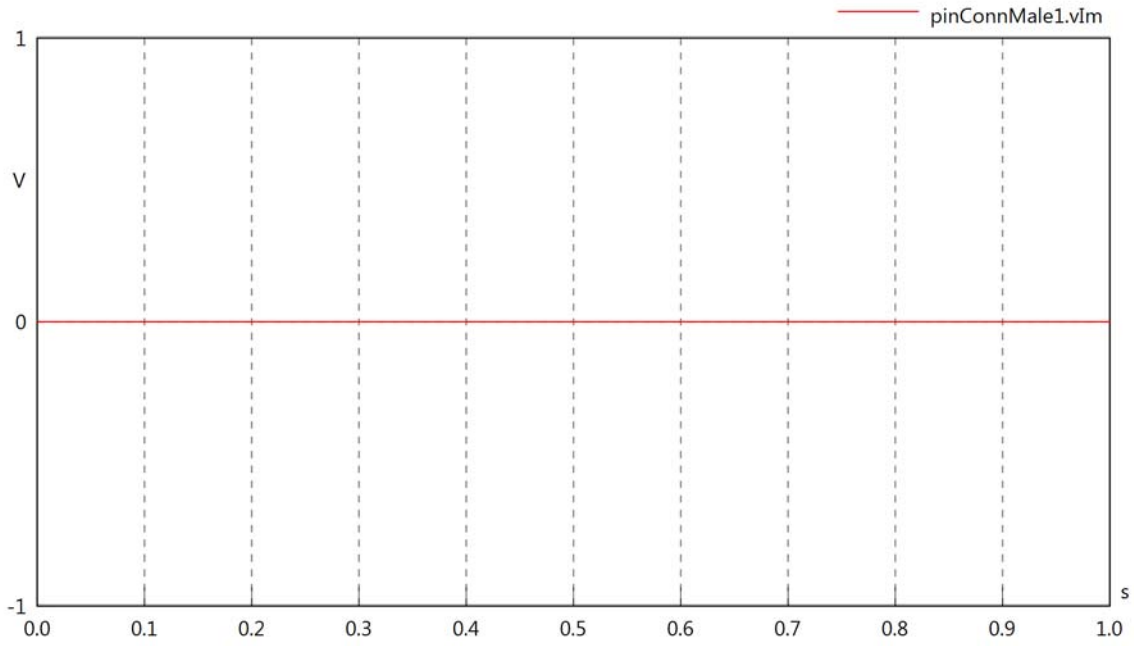

pinConnMale1.IrmsIn

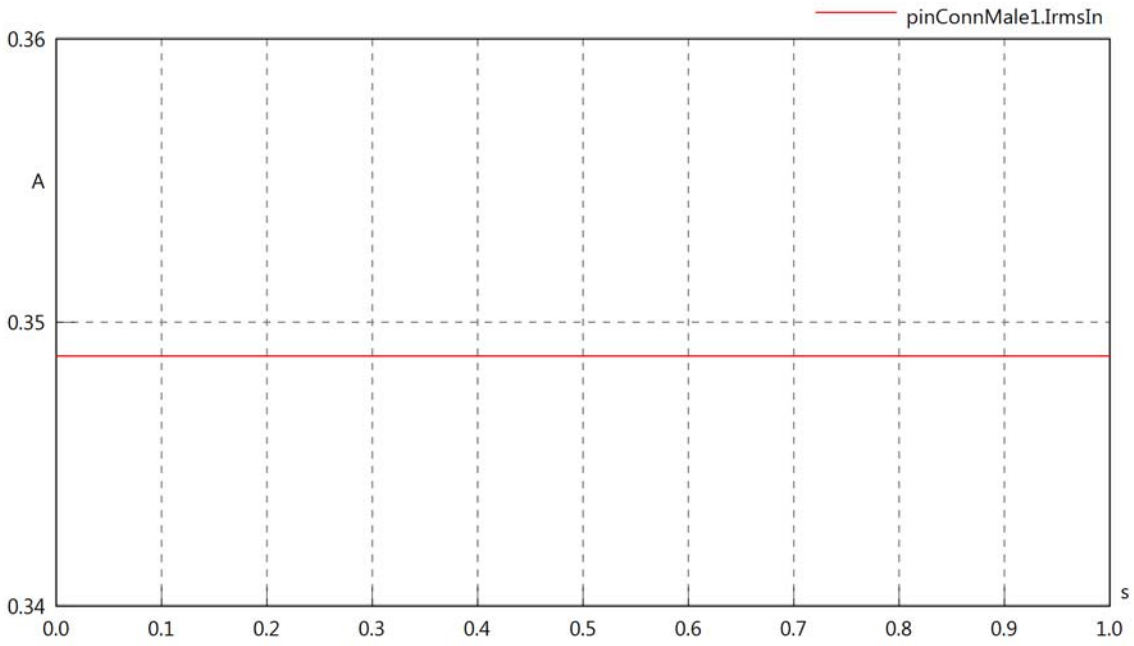

pinConnMale1.iReIn

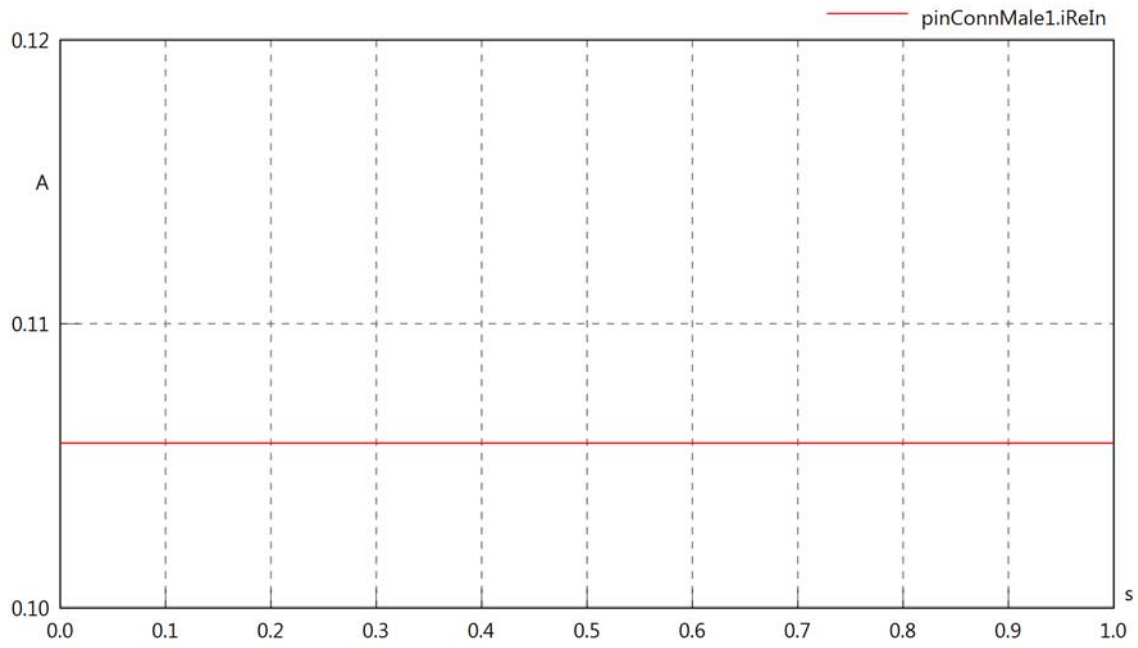

pinConnMale1.iImIn

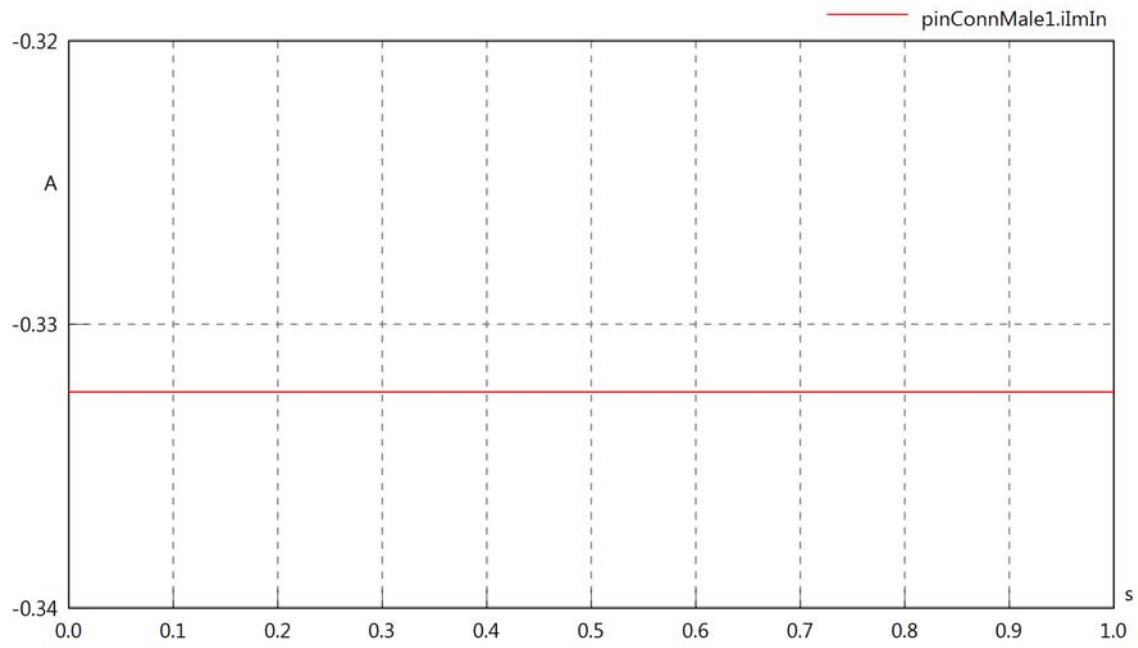

pinConnMale1.IrmsOut

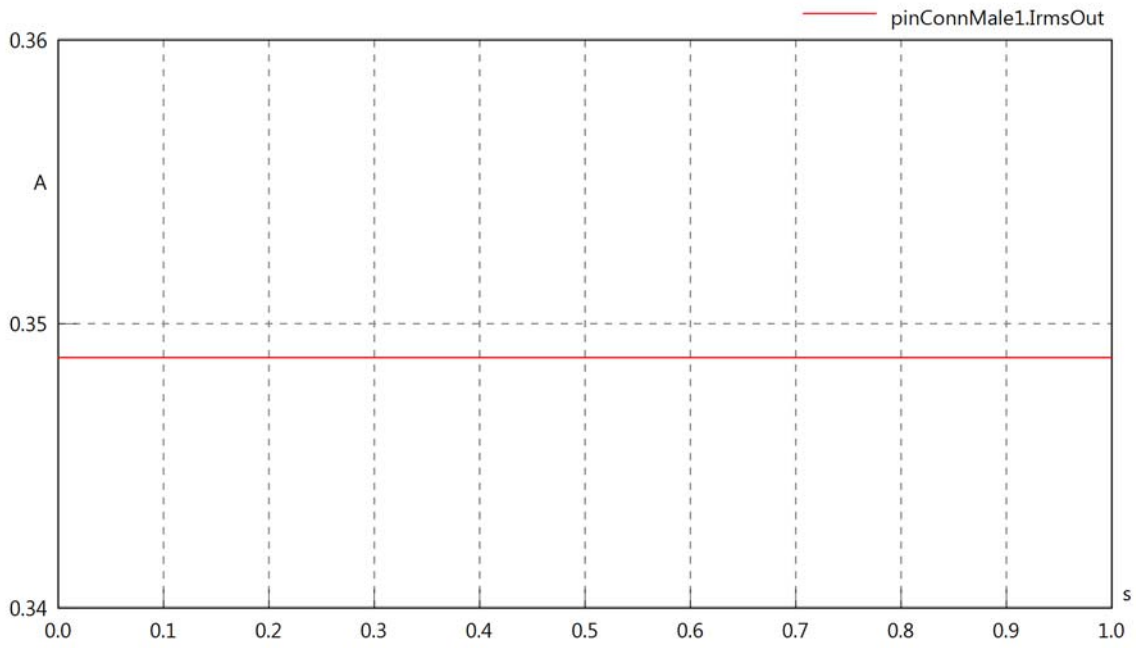

pinConnMale1.iReOut

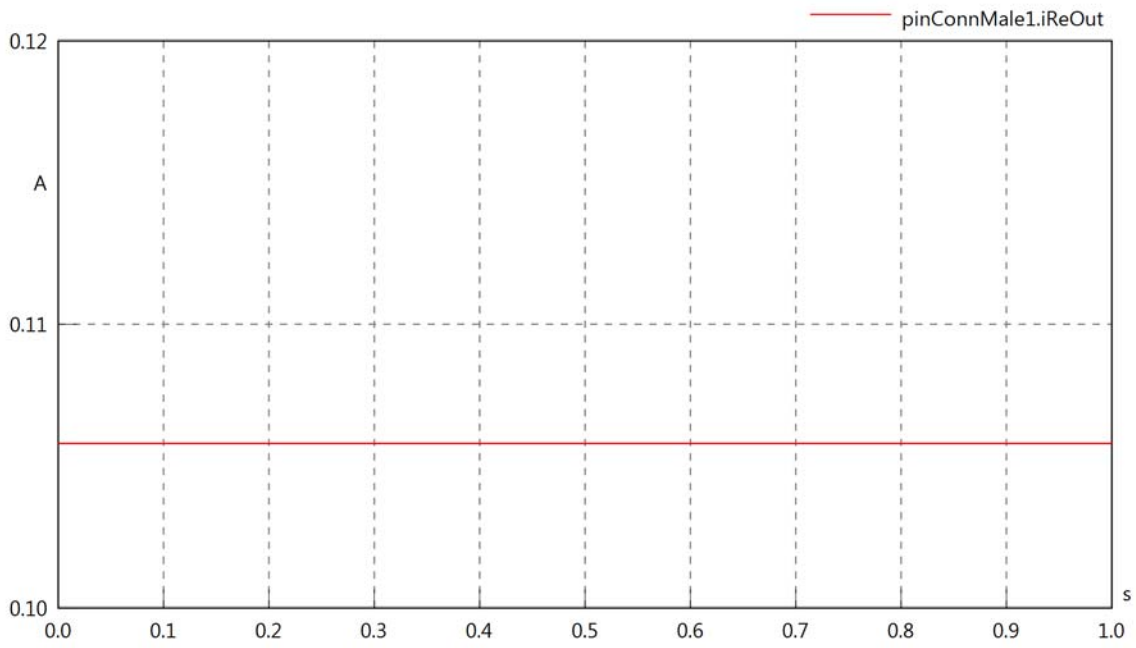

pinConnMale1.iImOut

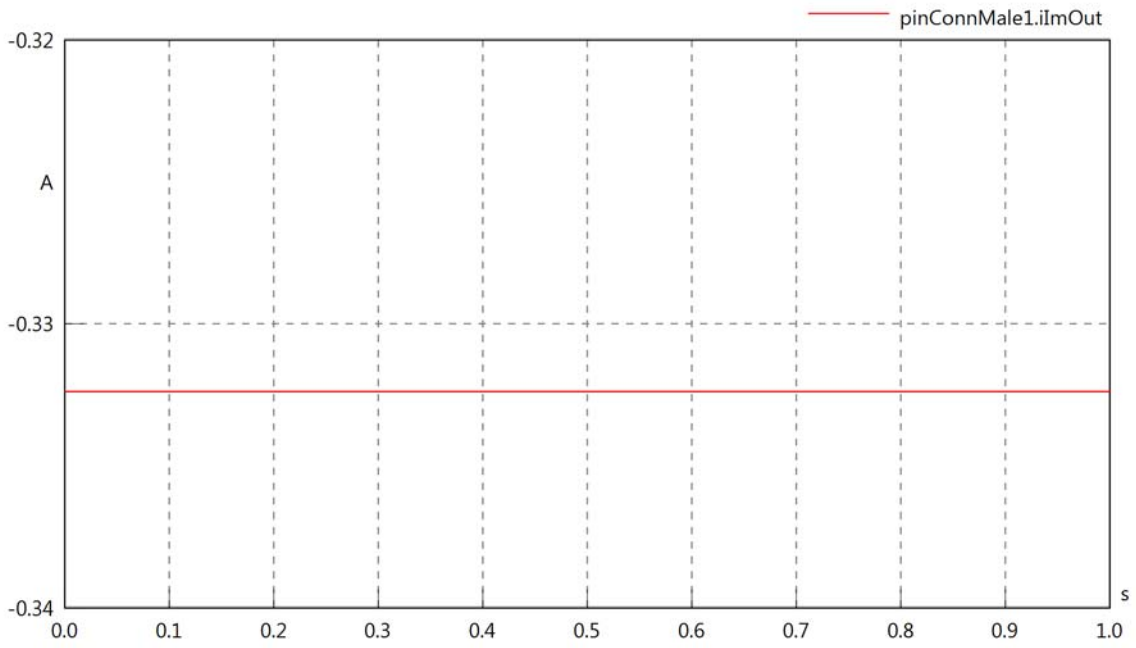

pinConnMale1.phiVIn

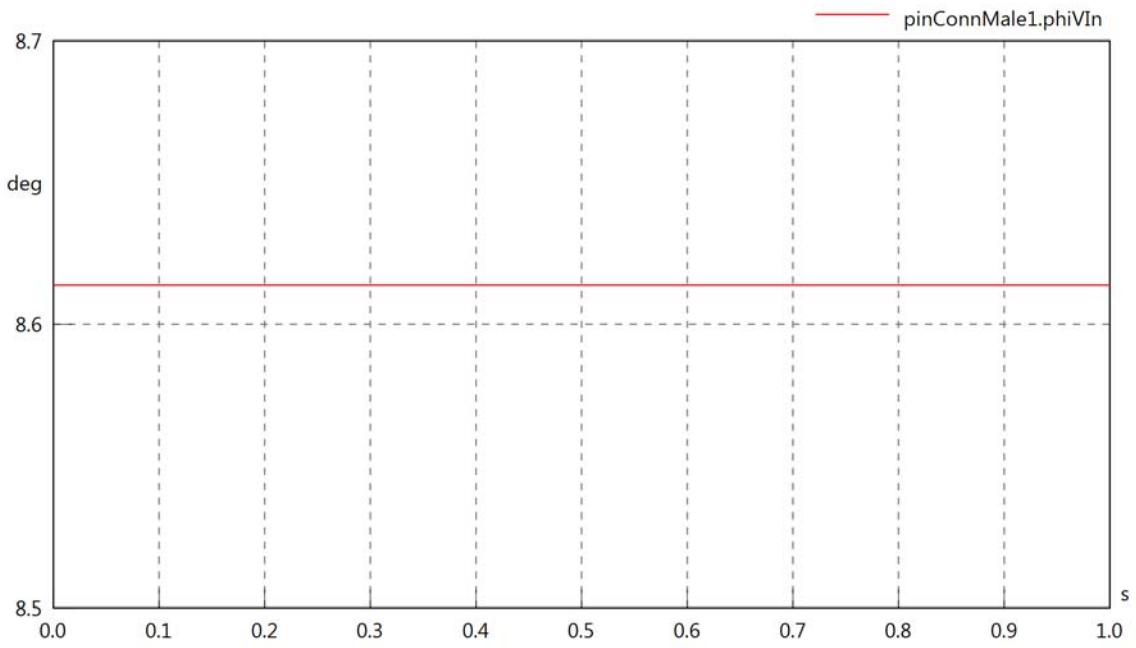

pinConnMale1.phiIIn

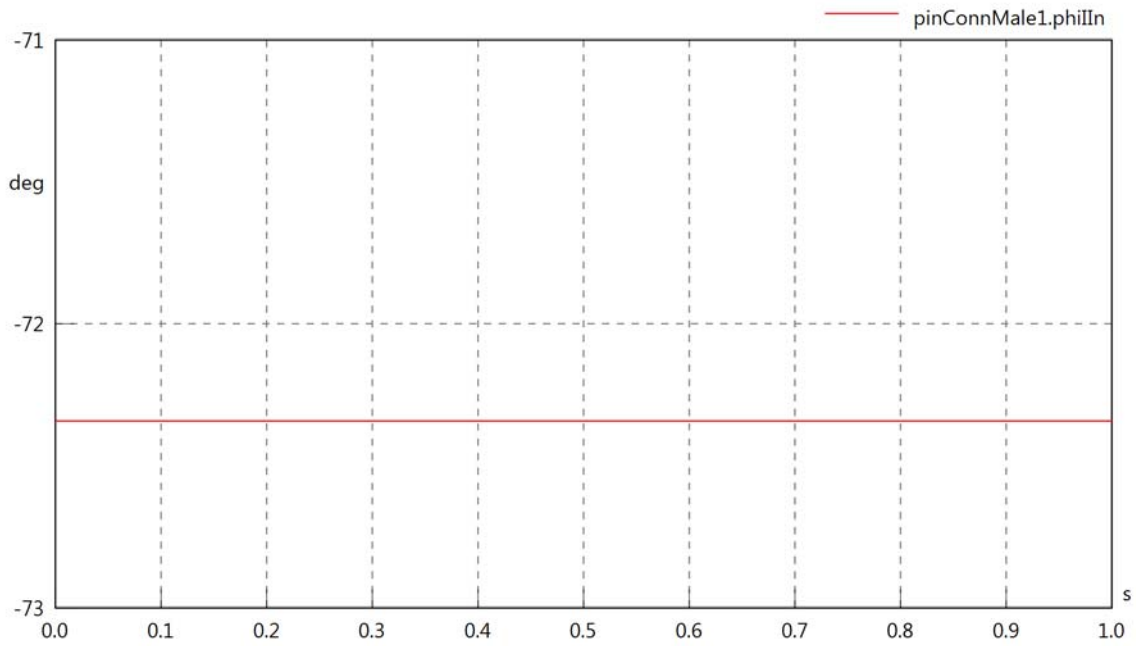

pinConnMale1.phiIVIn

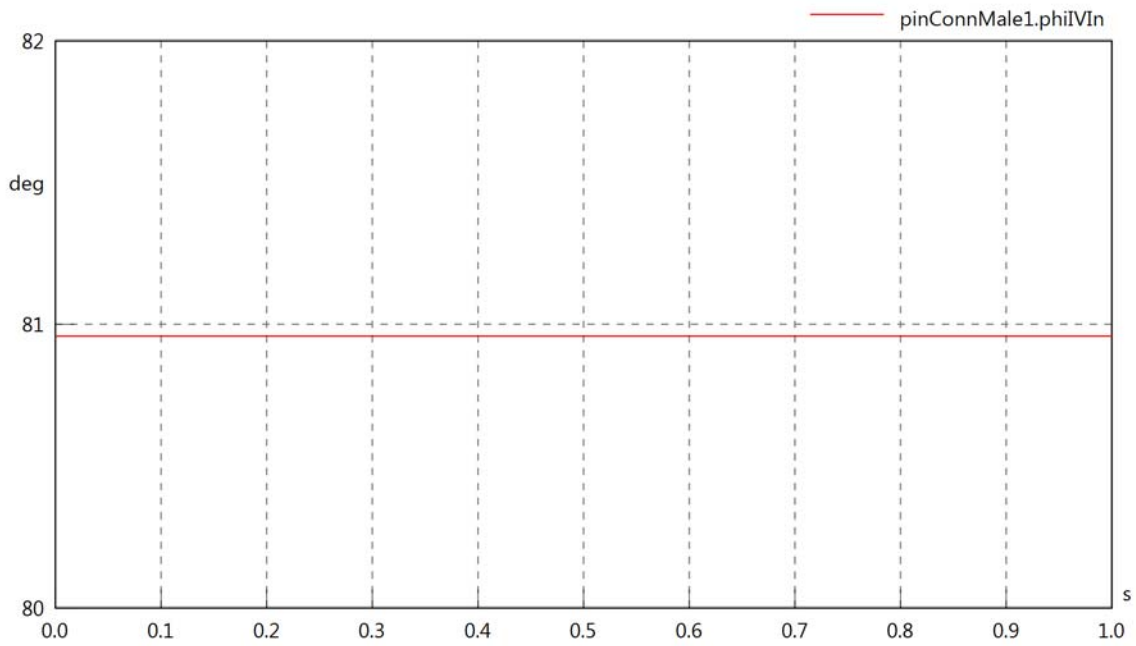

pinConnMale1.phiVOut

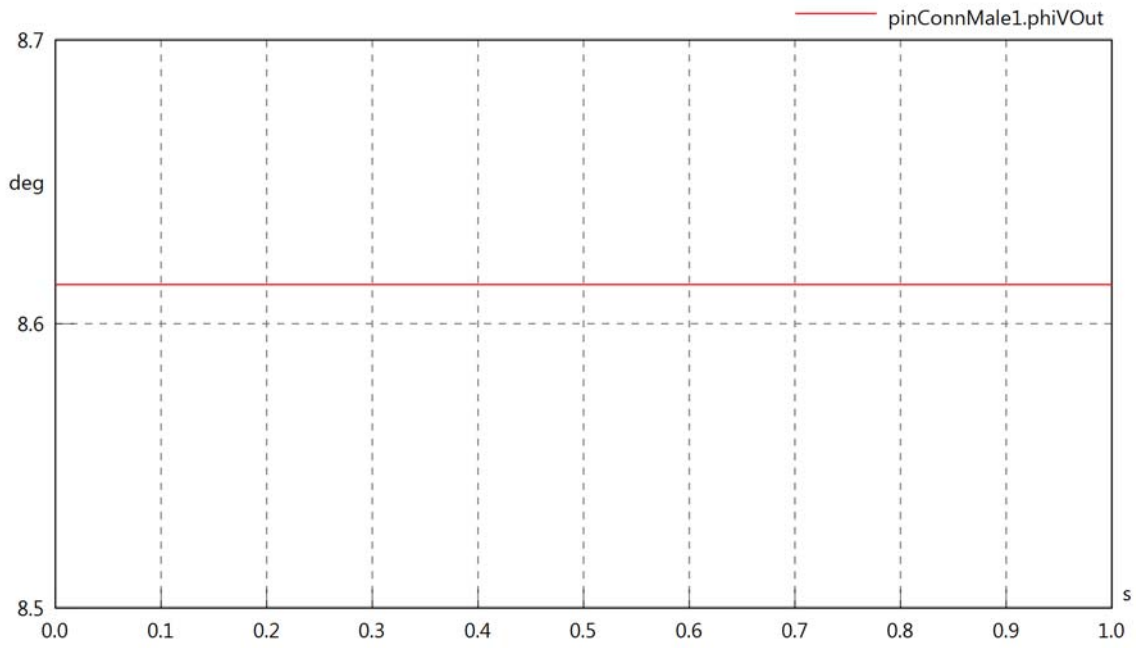

pinConnMale1.phiIOut

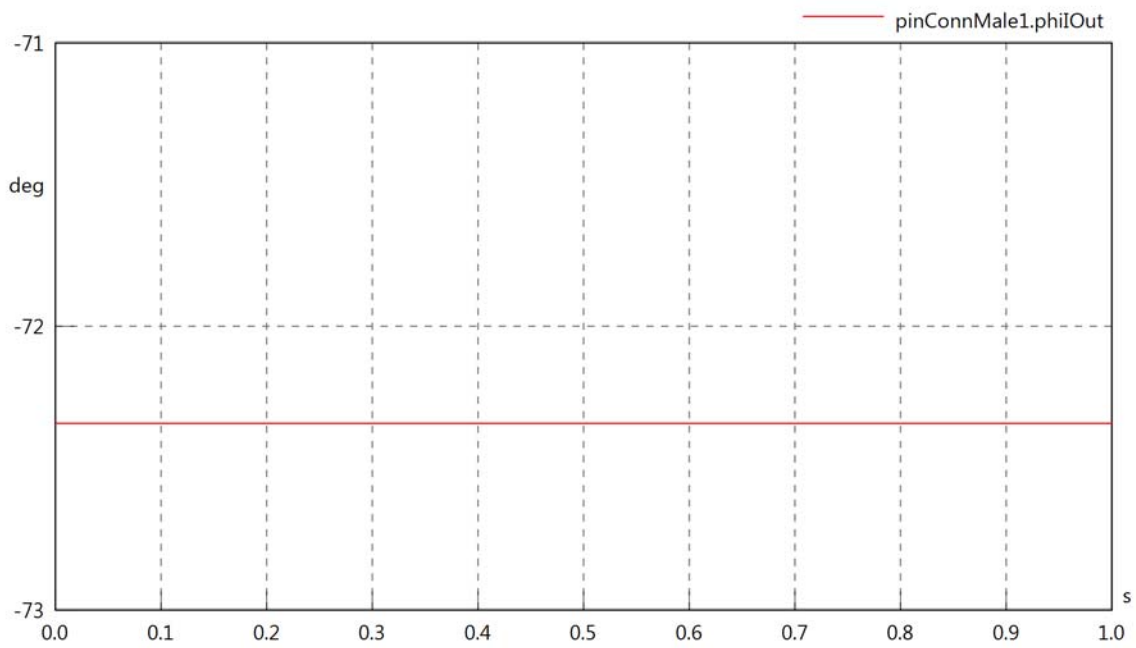

pinConnMale1.phiIVOut

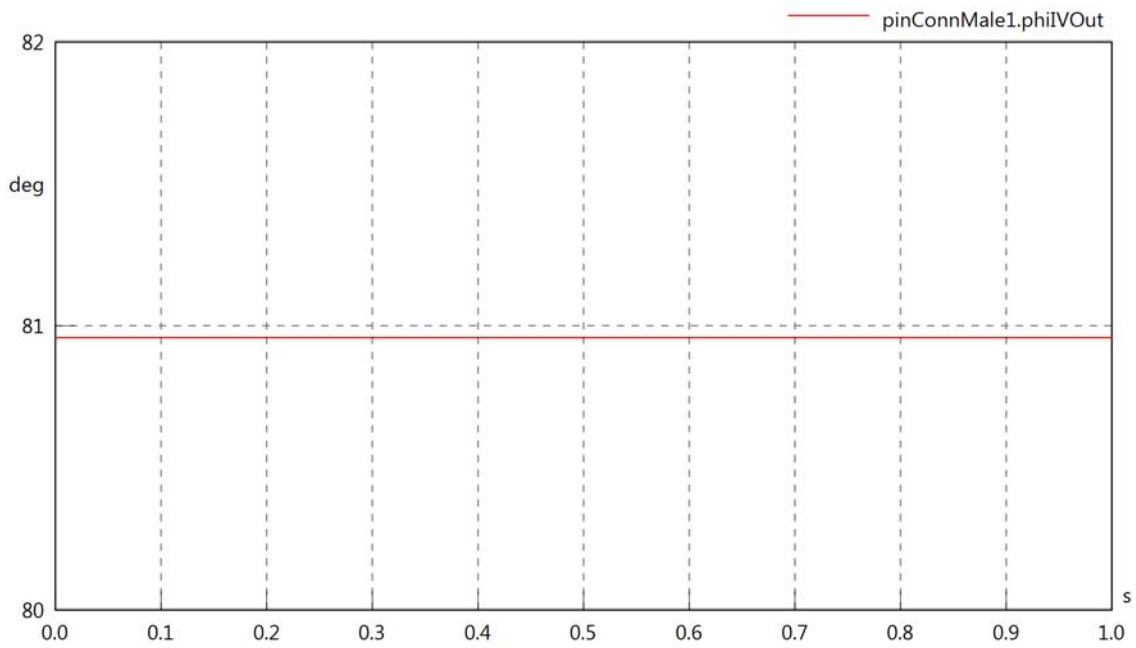

pinConnMale1.PReIn

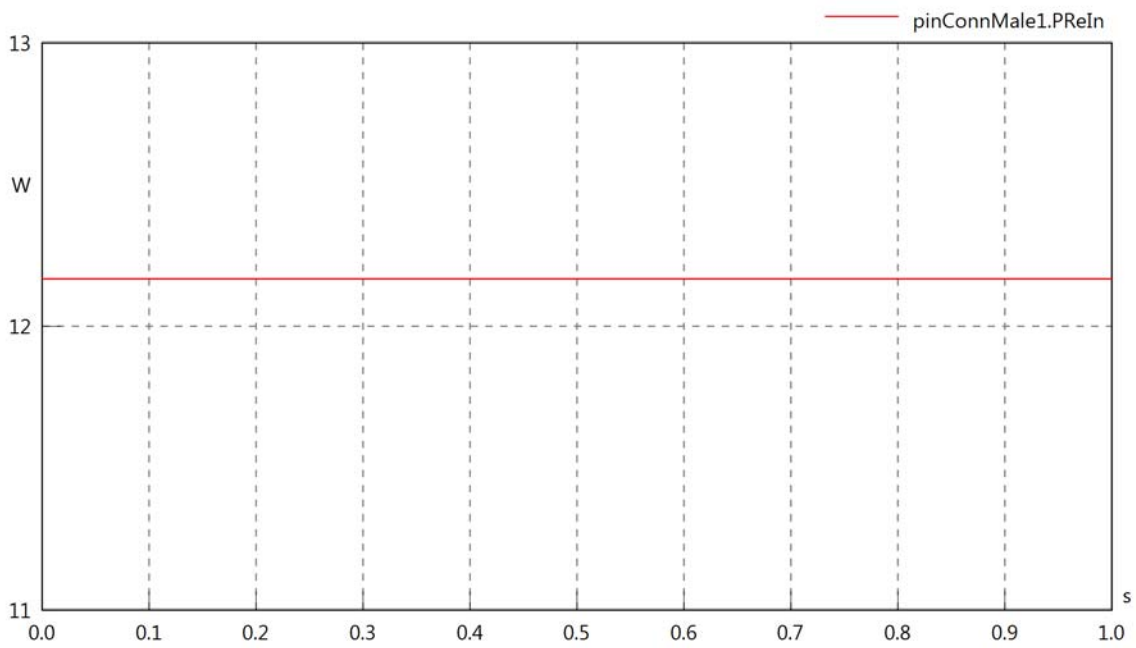

pinConnMale1.PImIn

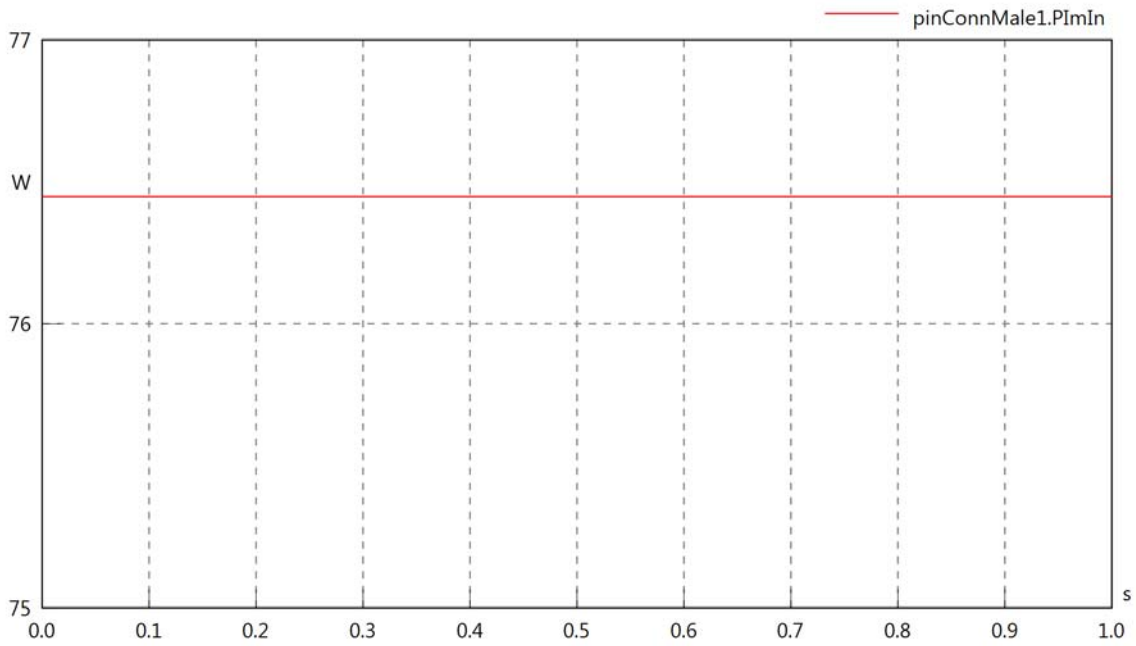

pinConnMale1.SIn

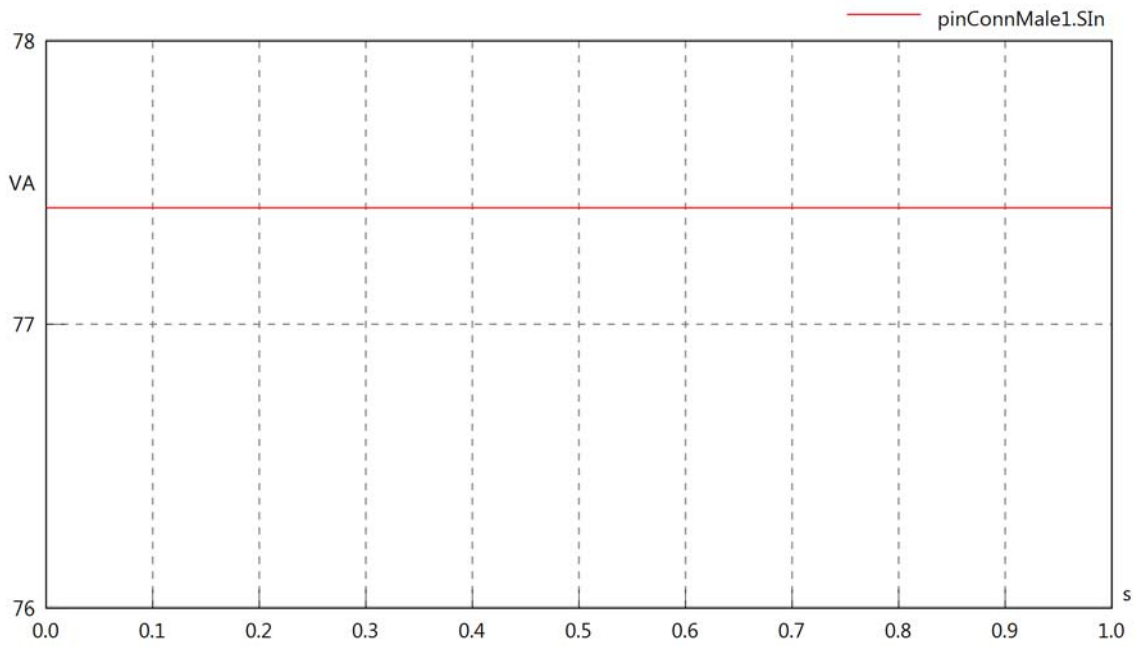

pinConnMale1.PReOut

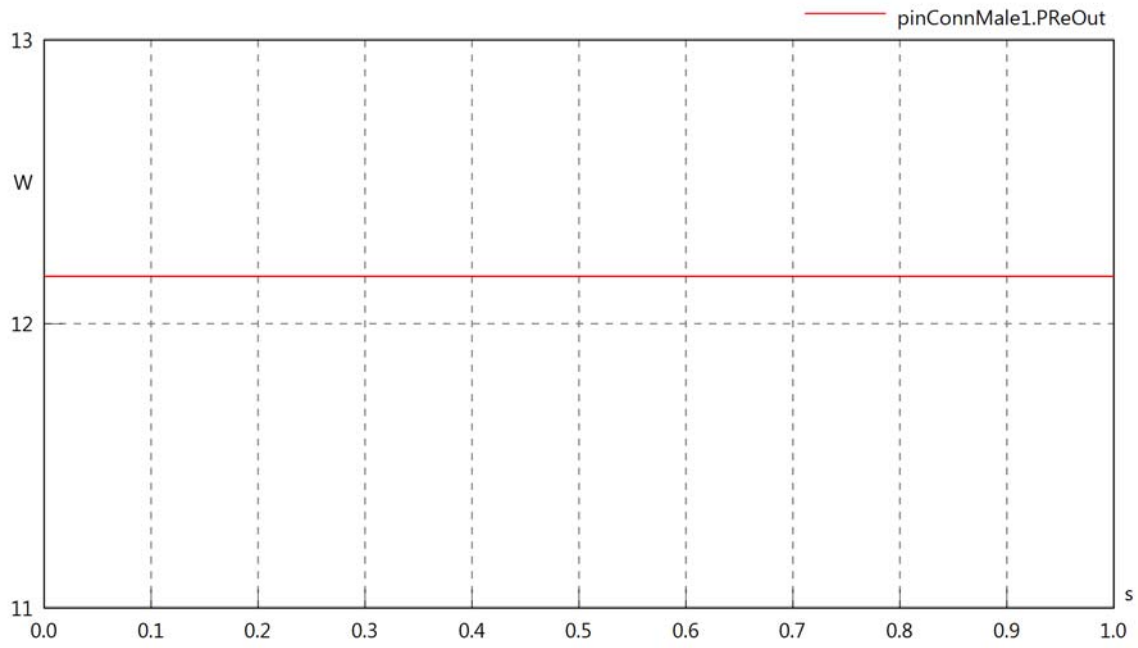

pinConnMale1.PImOut

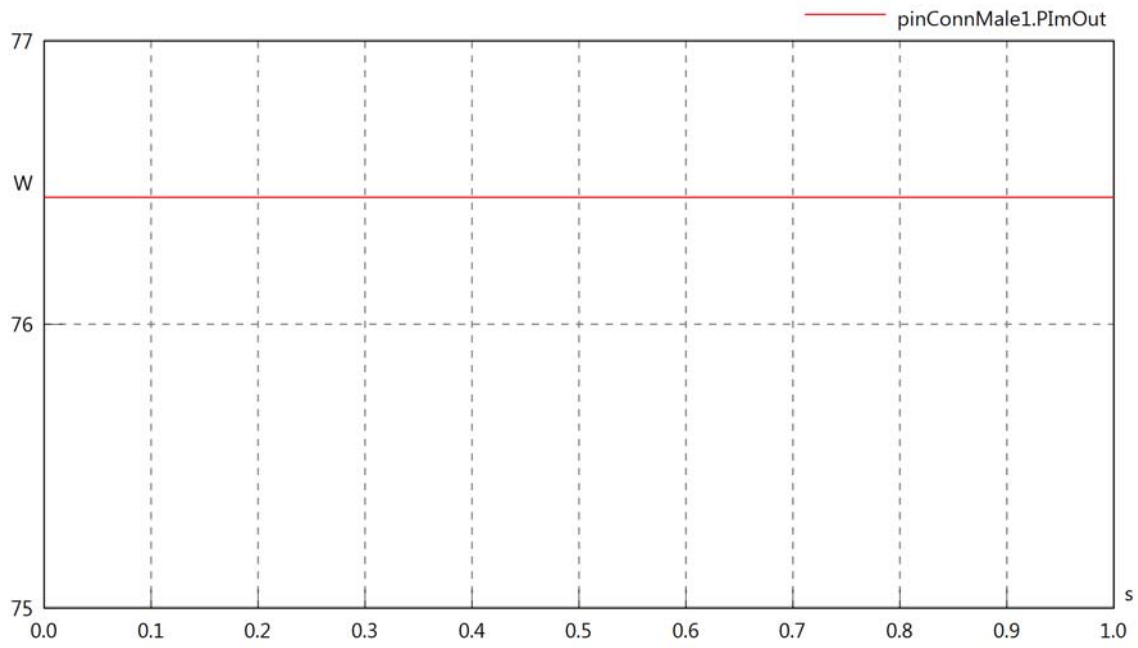

pinConnMale1.SOut

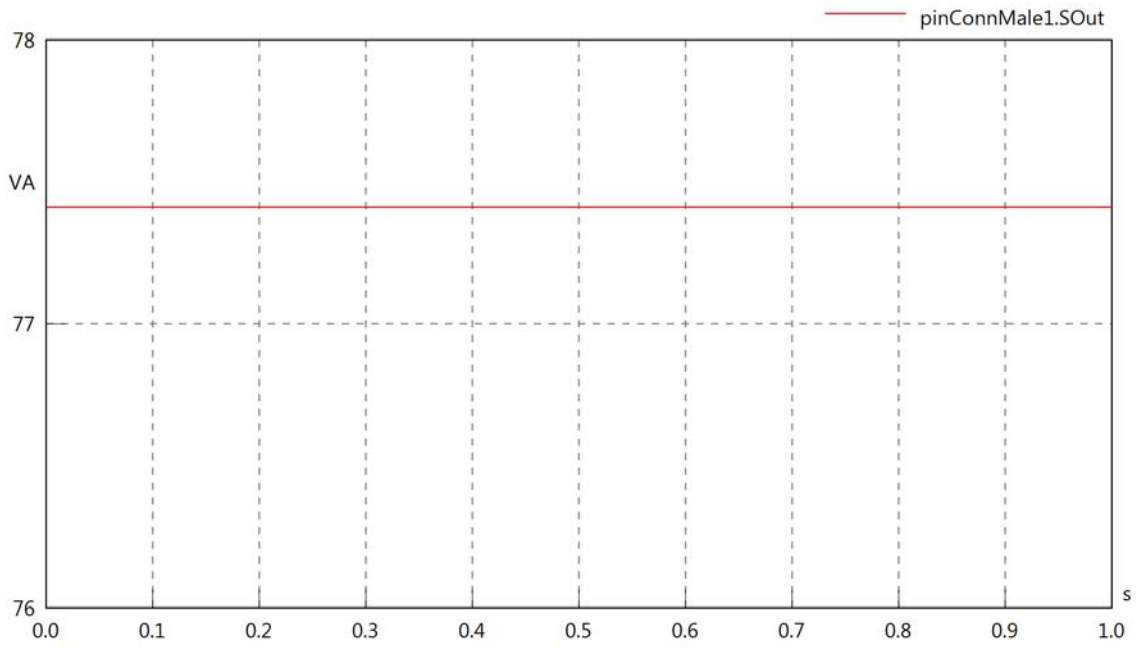
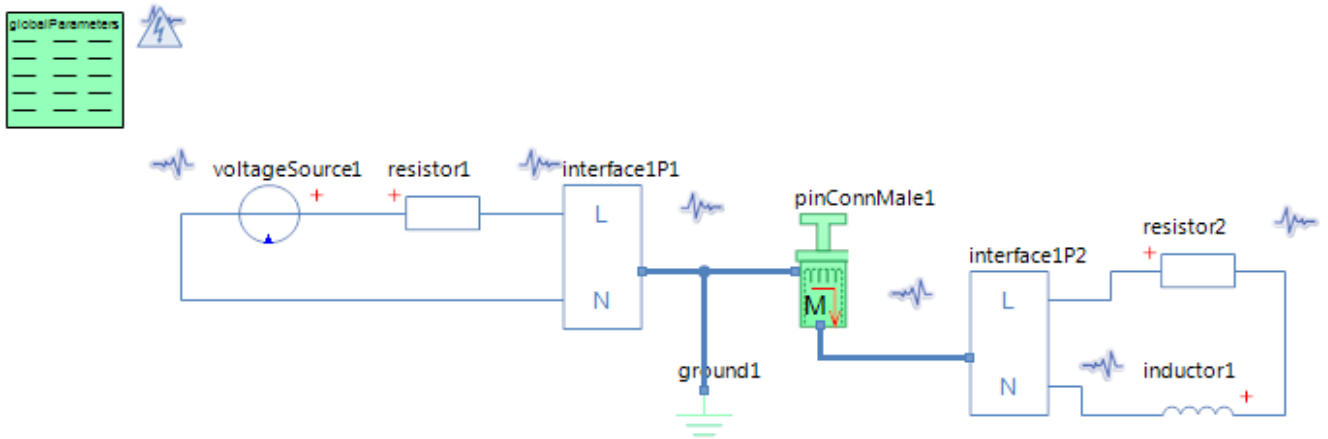

Diagram View



GlobalParameters globalParameters
Parameters

Comment	Name	Current Value	Unit
Type of Calculation	eCalculationKind	Signal Calculation	
Description of Frequency	eFrequencyKind	Linear	
Minimum Frequency	fMin	60	[Hz]
Maximum Frequency	fMax	60	[Hz]

Voltage Source voltageSource1
Parameters

Comment	Name	Current Value	Unit
Voltage RMS	VrmsSrc	230	[V]
Phase	phi	0	[deg]

Resistor resistor1
Parameters

Comment	Name	Current Value	Unit
Resistance	R	100	[Ohm]

Resistor resistor2
Parameters

Comment	Name	Current Value	Unit
Resistance	R	100	[Ohm]

Inductor inductor1
Parameters

Comment	Name	Current Value	Unit
Inductance	L	5	[mH]

Pin Connector Male pinConnMale1
Parameters

Comment	Name	Current Value	Unit
Poor or failing L1 connection	bL1	true	
Resistance in L1 connection	rL1	1	[kOhm]
Conductance between L1 and N	G	50	[1/Ohm]

pinConnMale1.VrmsIn

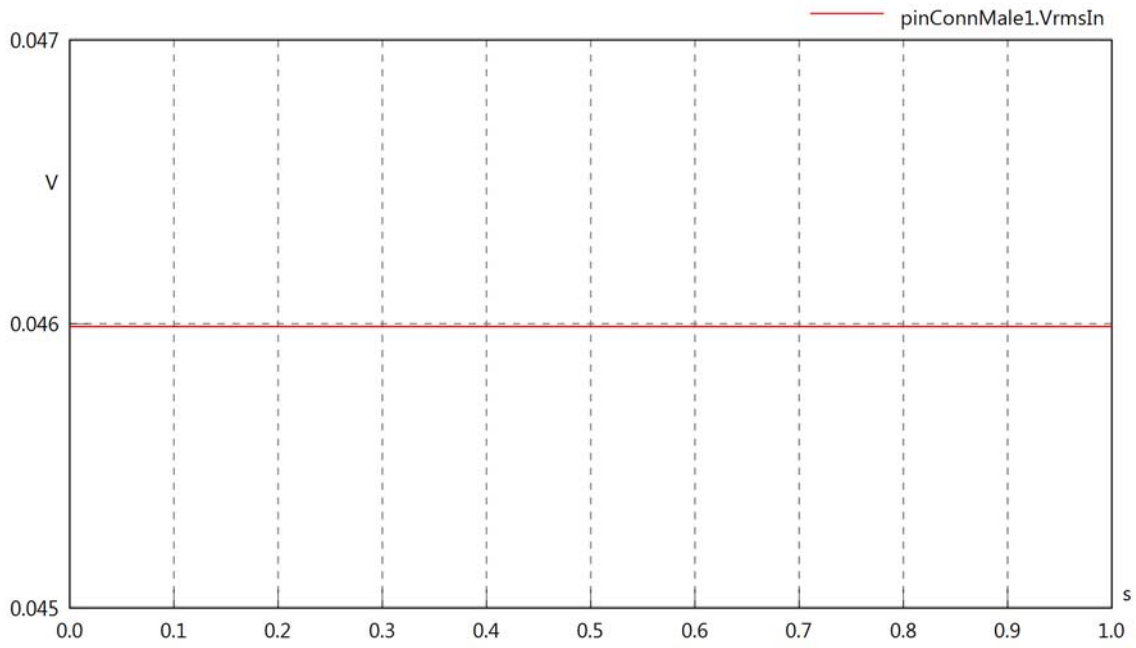

pinConnMale1.vReIn

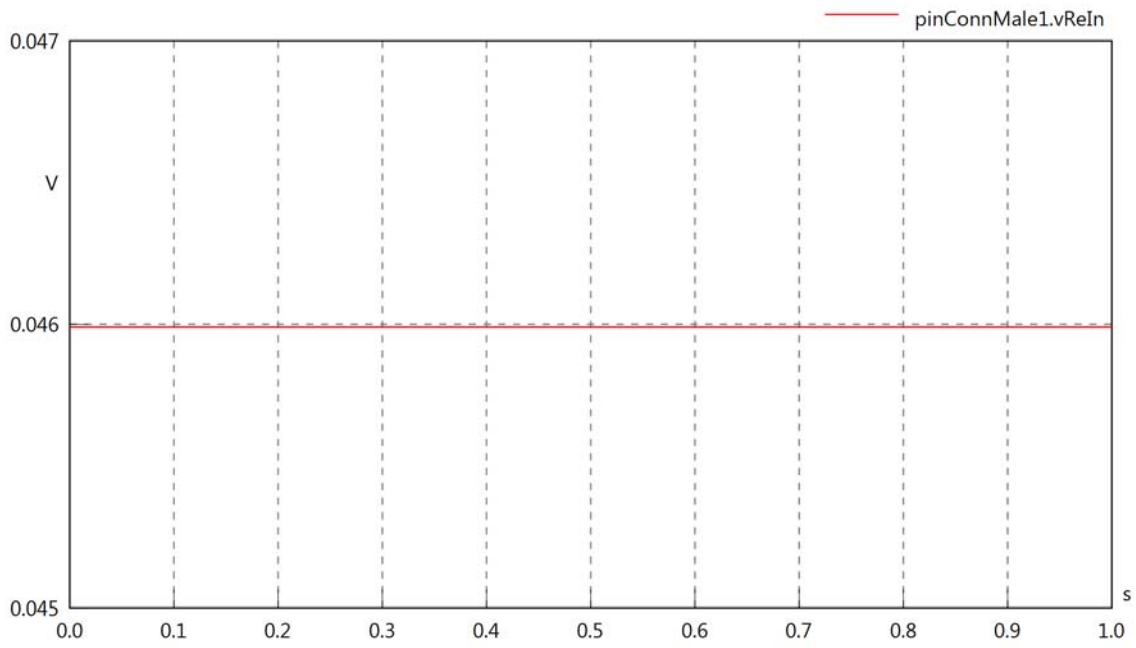

pinConnMale1.vImIn

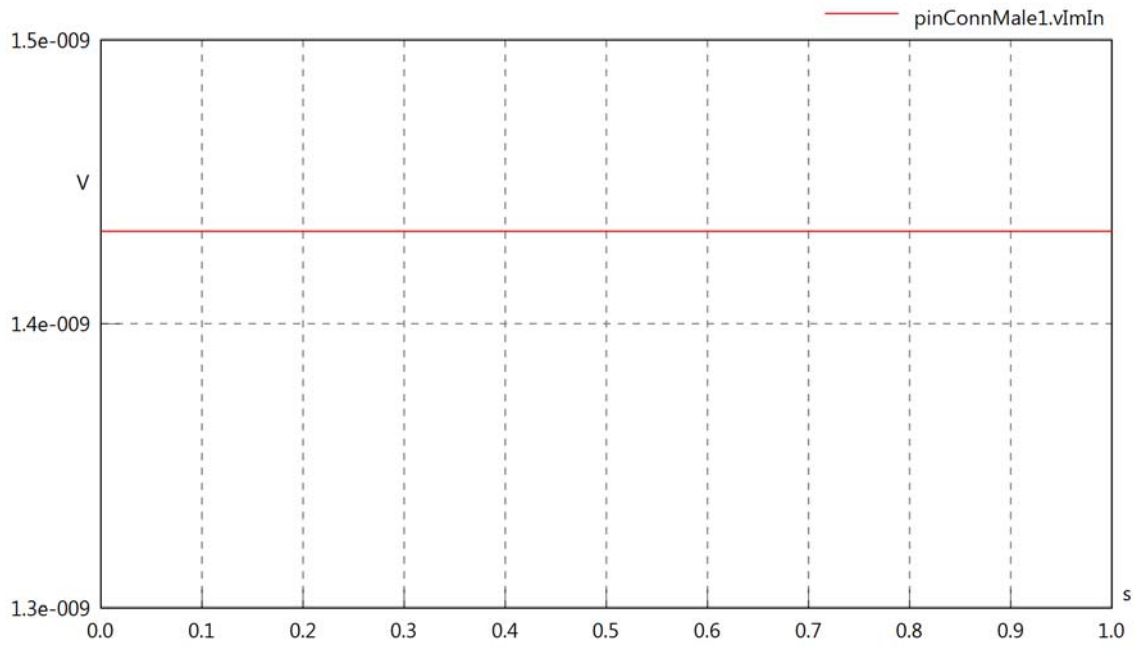

pinConnMale1.VrmsOut

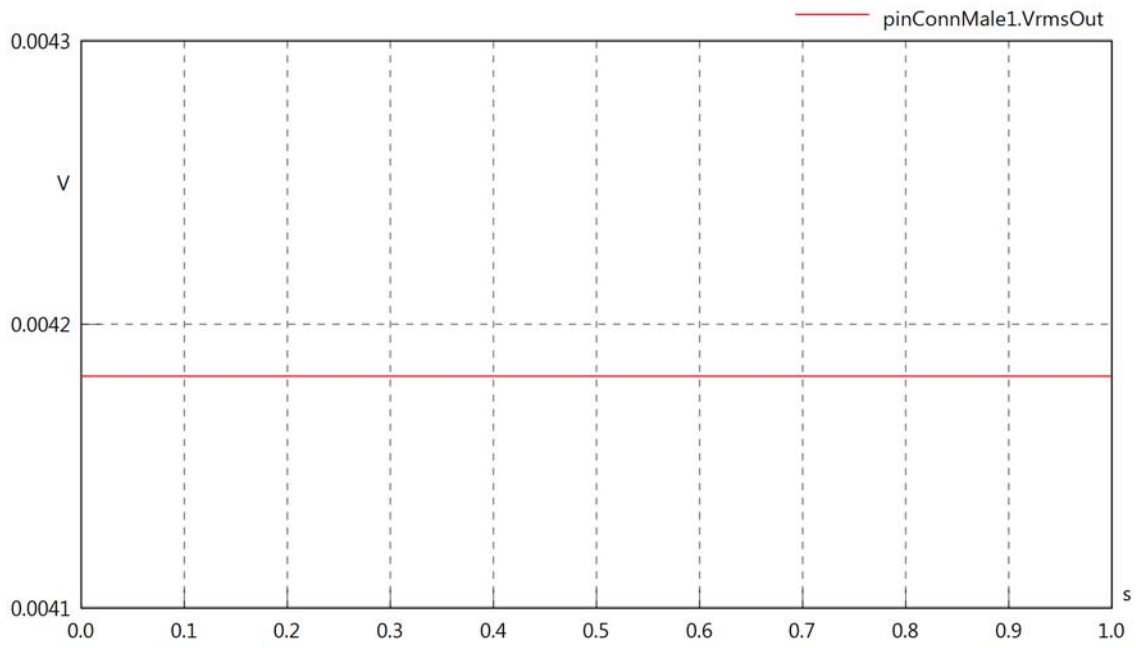

pinConnMale1.vReOut

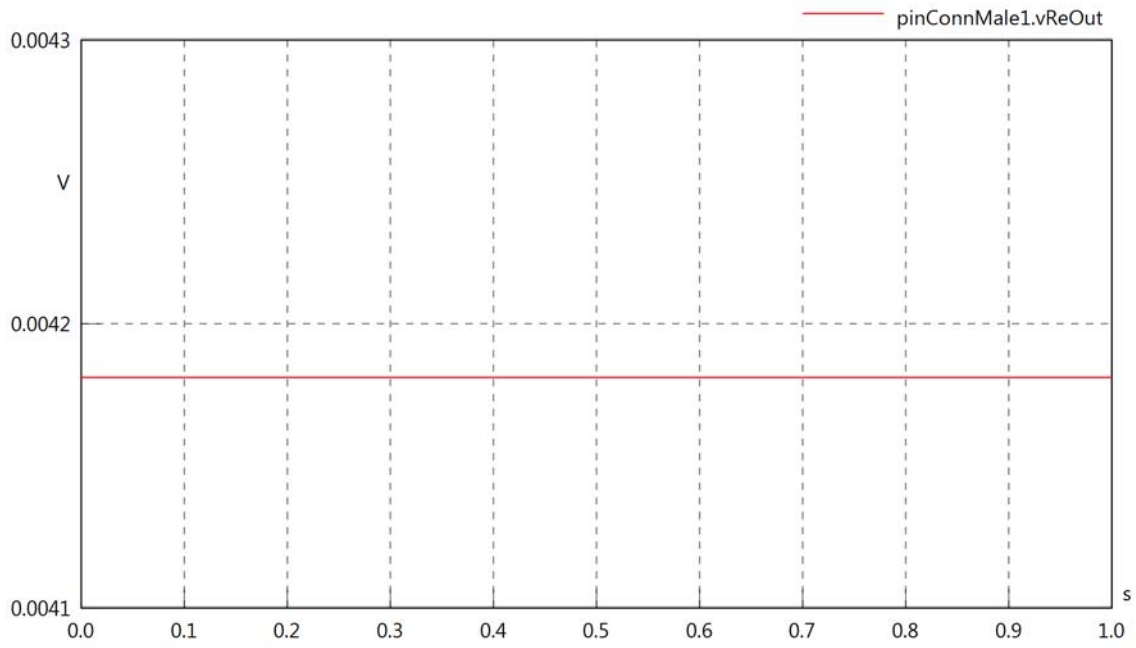

pinConnMale1.vImOut

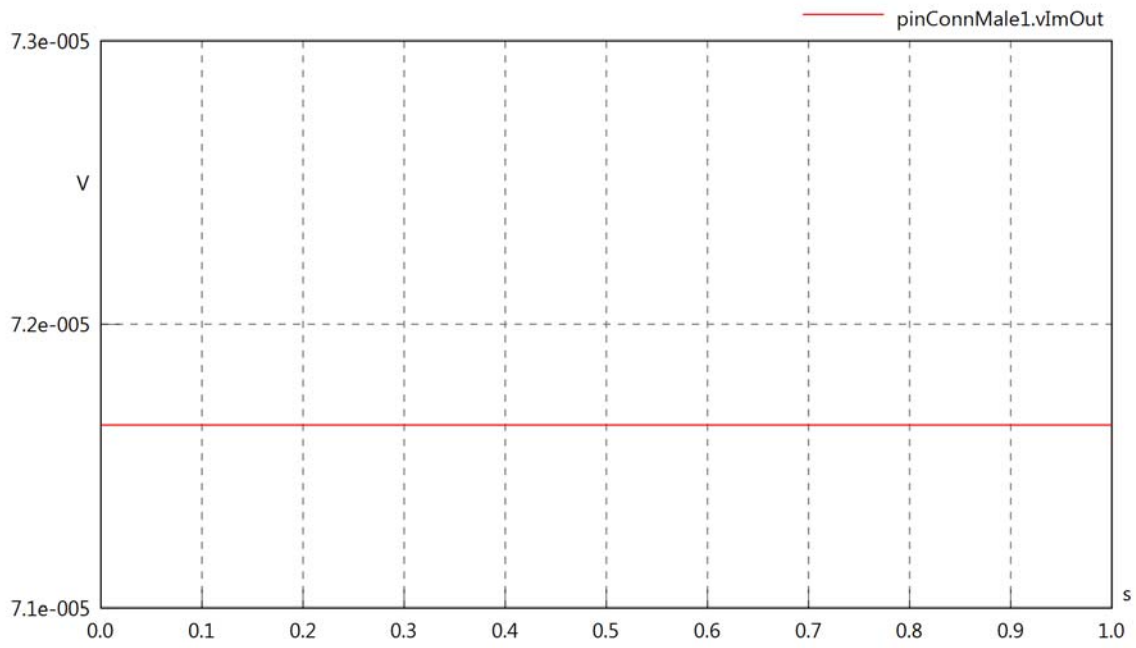

pinConnMale1.Vrms

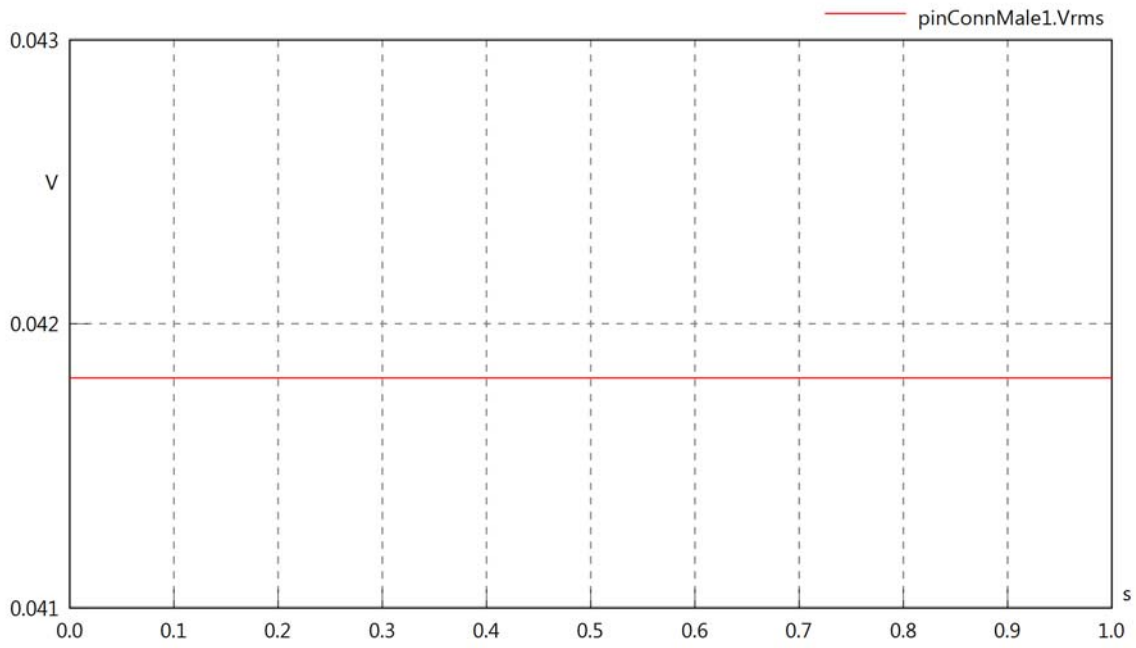

pinConnMale1.vRe

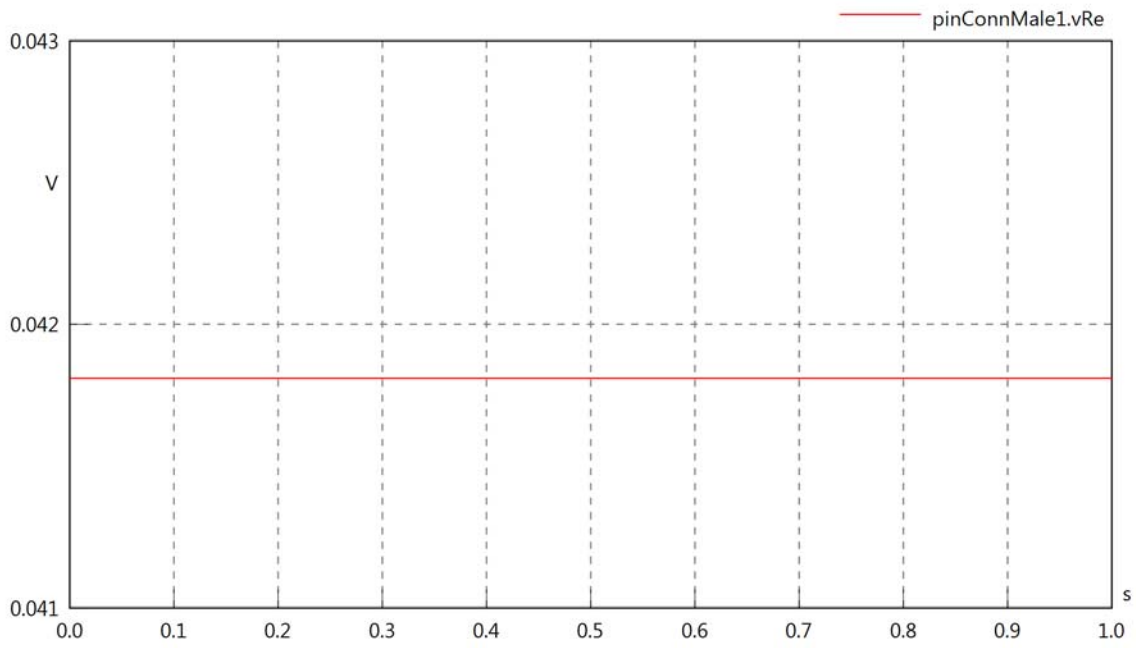

pinConnMale1.vIm

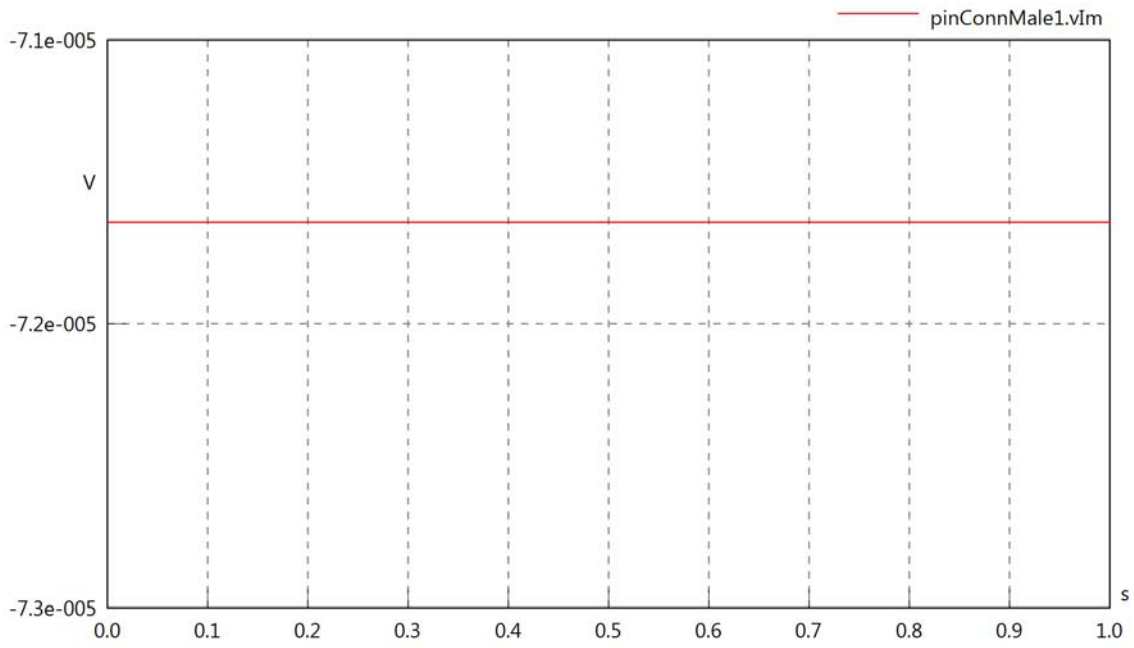

pinConnMale1.IrmsIn

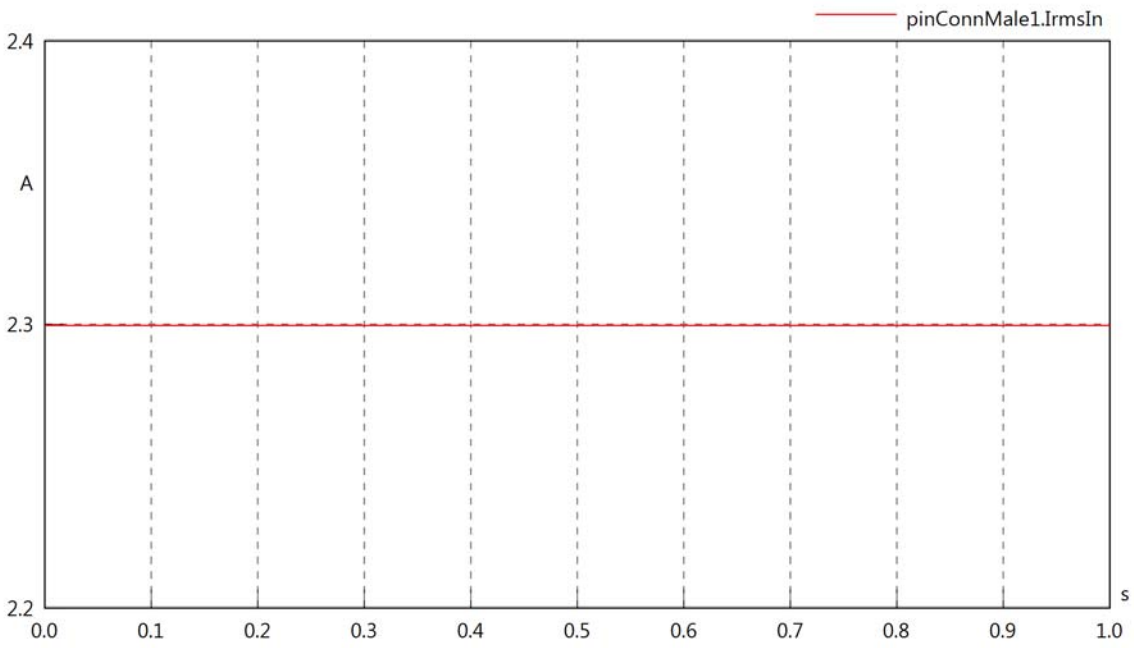

pinConnMale1.iReIn

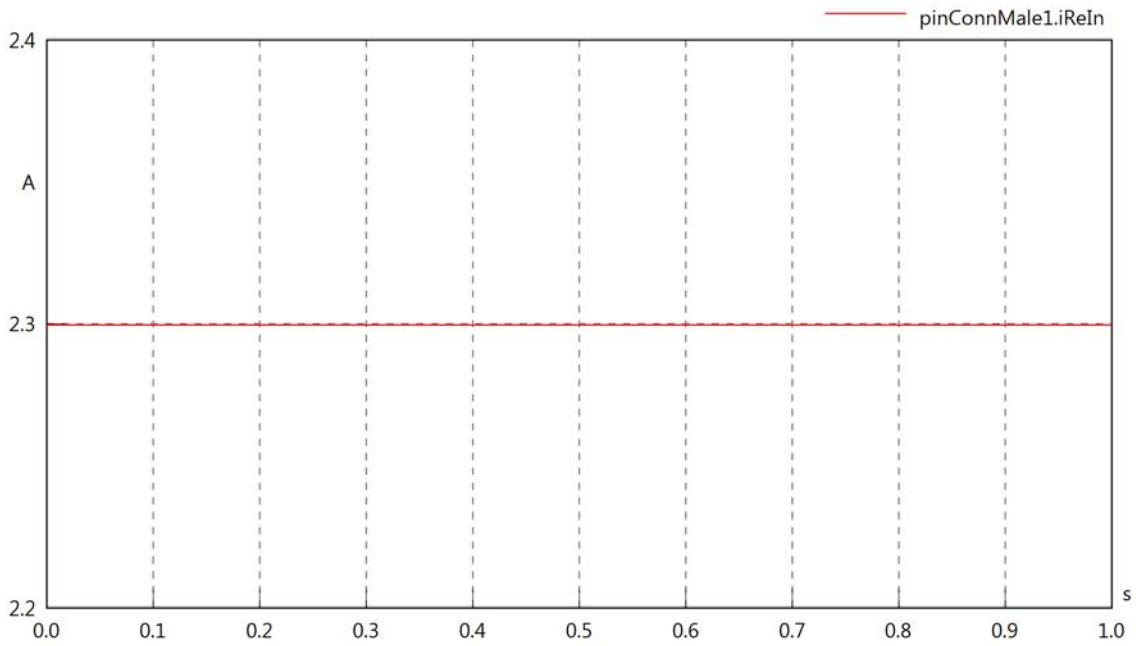

pinConnMale1.iImIn

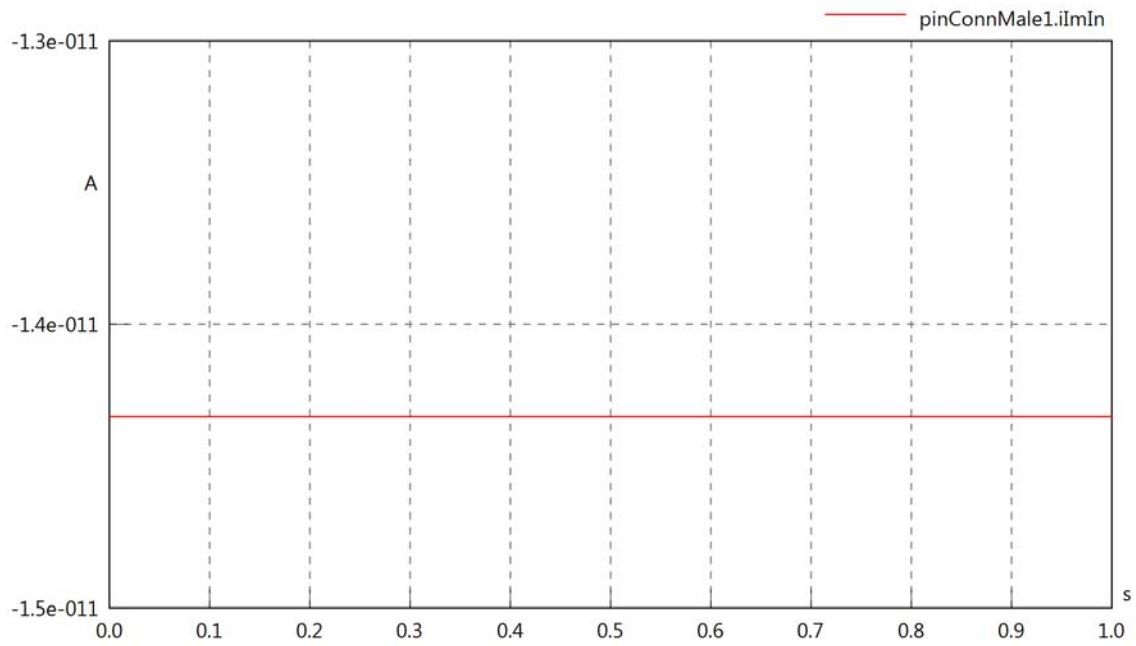

pinConnMale1.IrmsOut

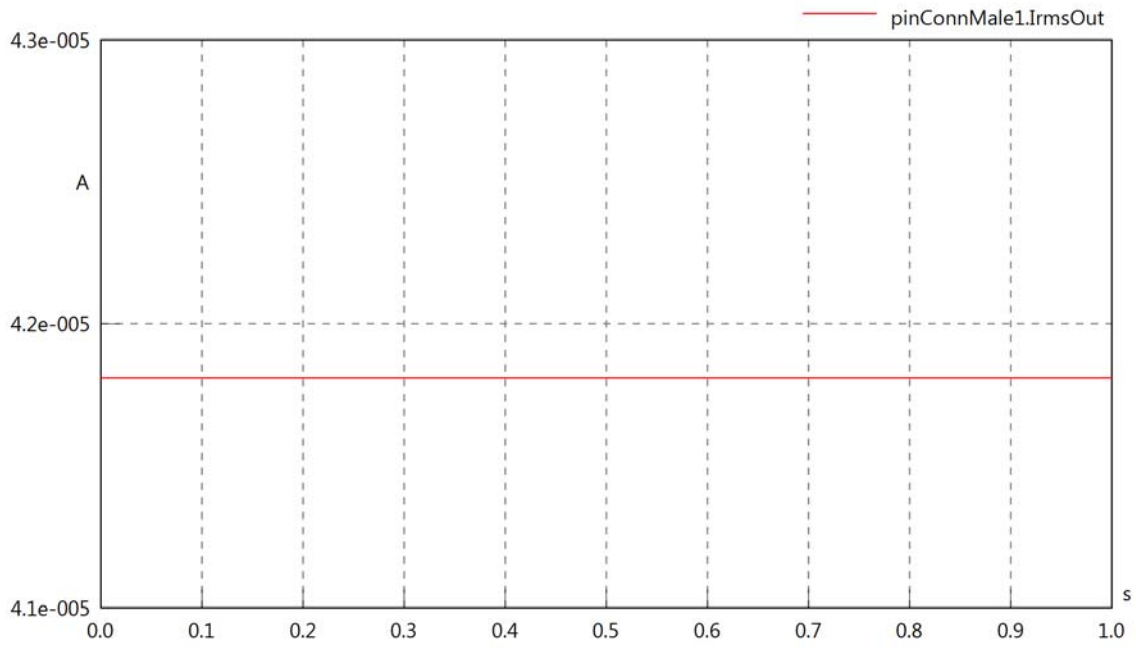

pinConnMale1.iReOut

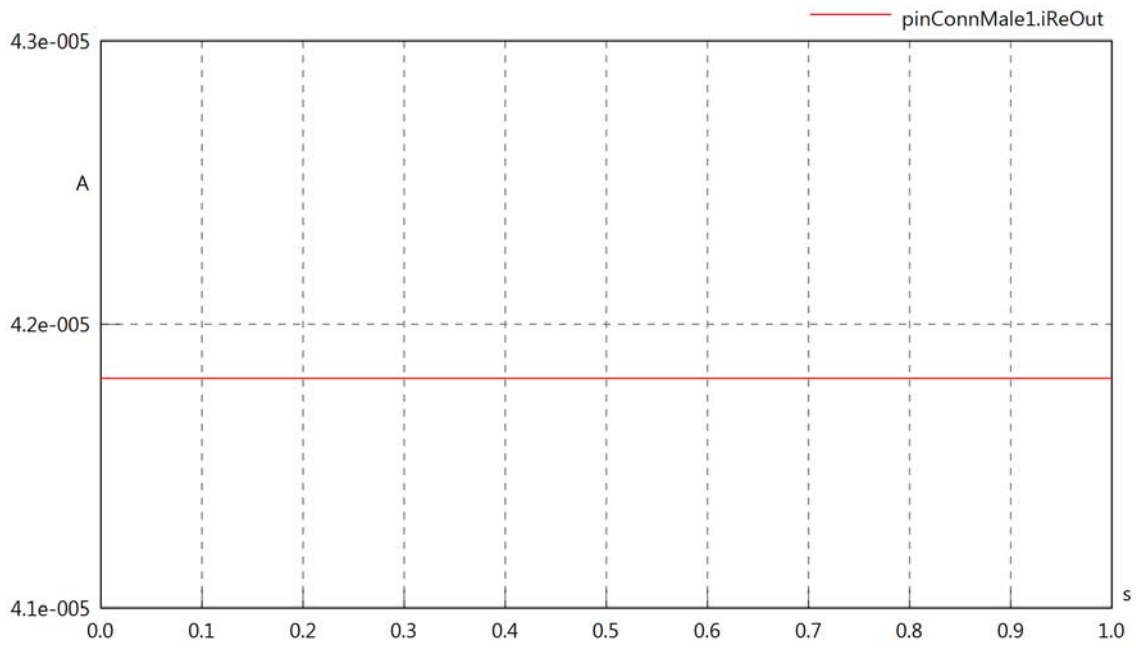

pinConnMale1.iImOut

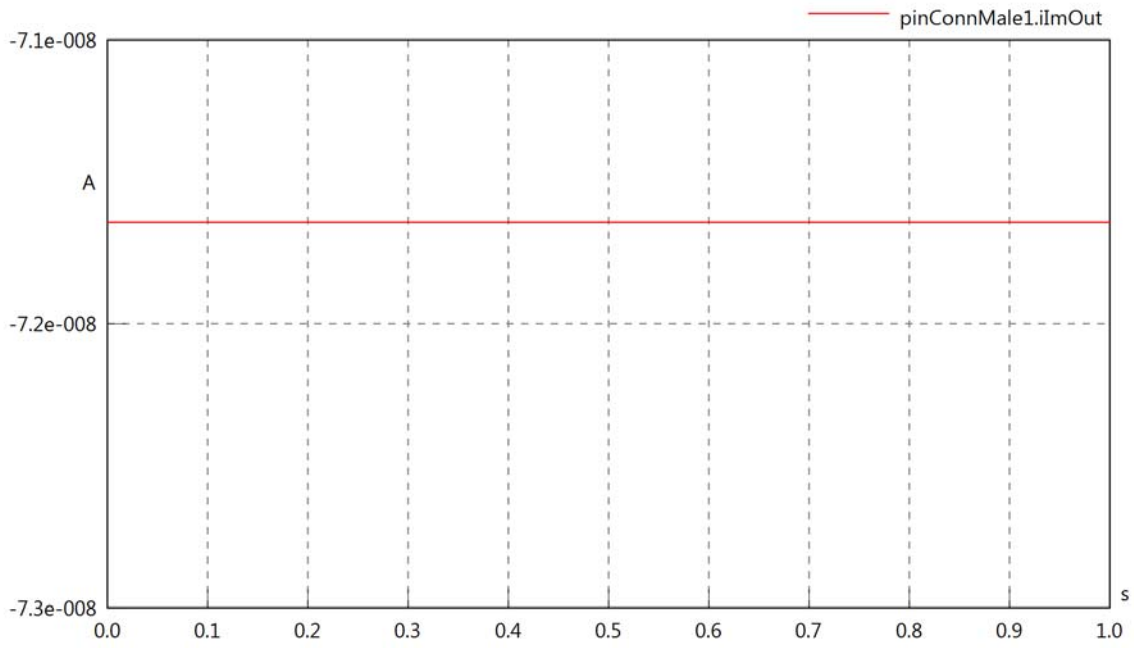

pinConnMale1.phiVIn

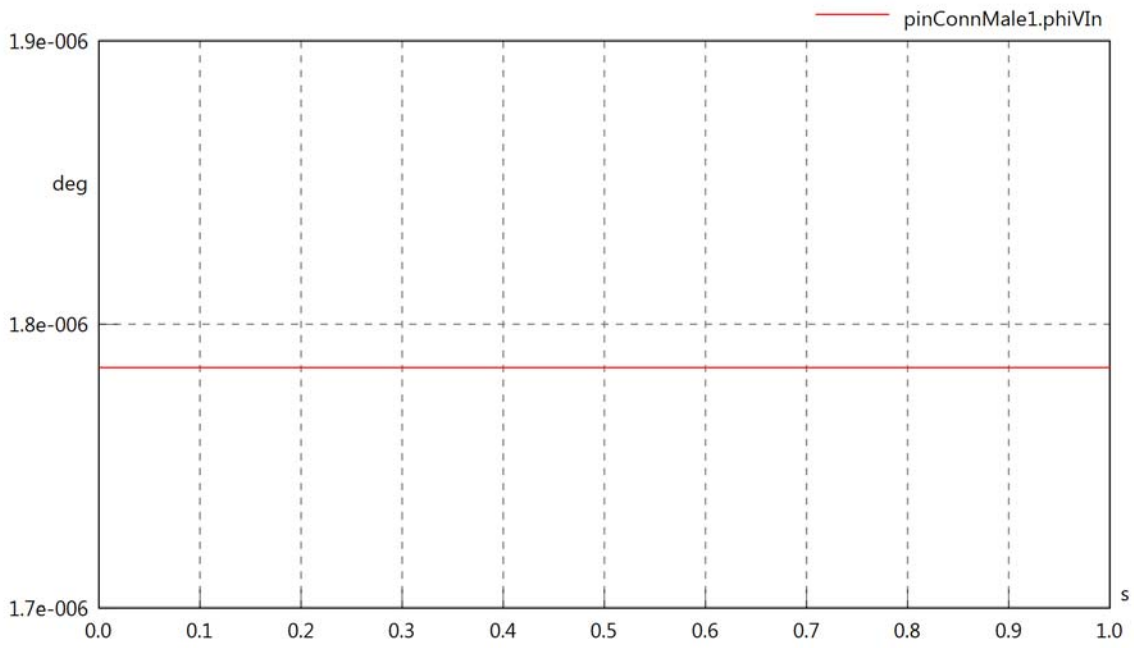

pinConnMale1.phiIIn

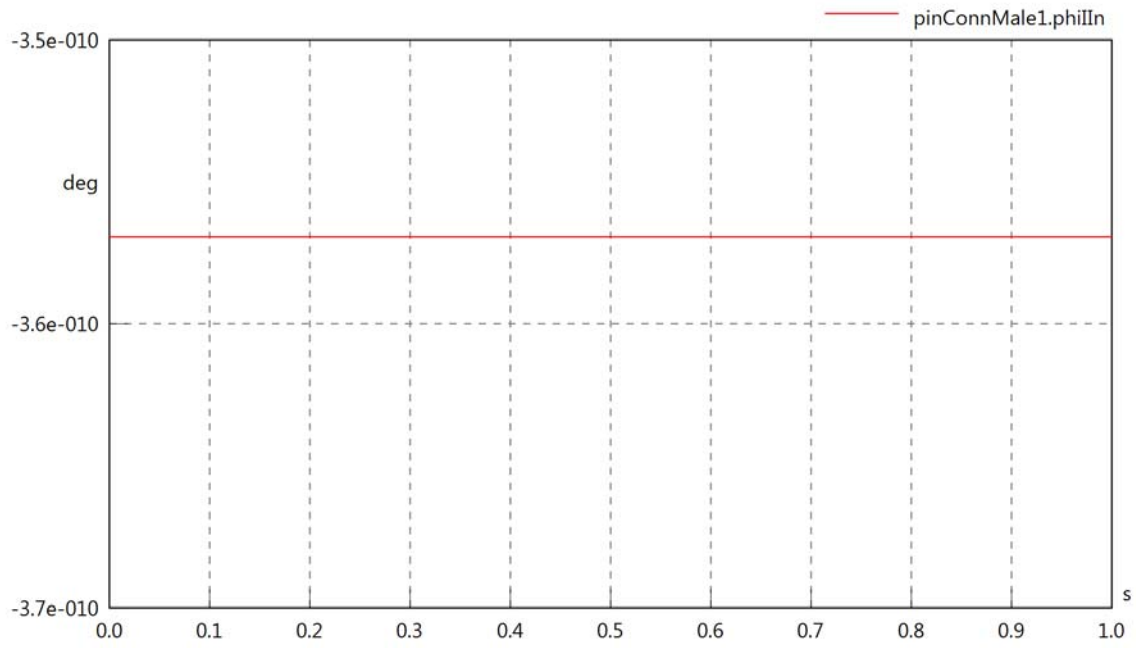

pinConnMale1.phiIVIn

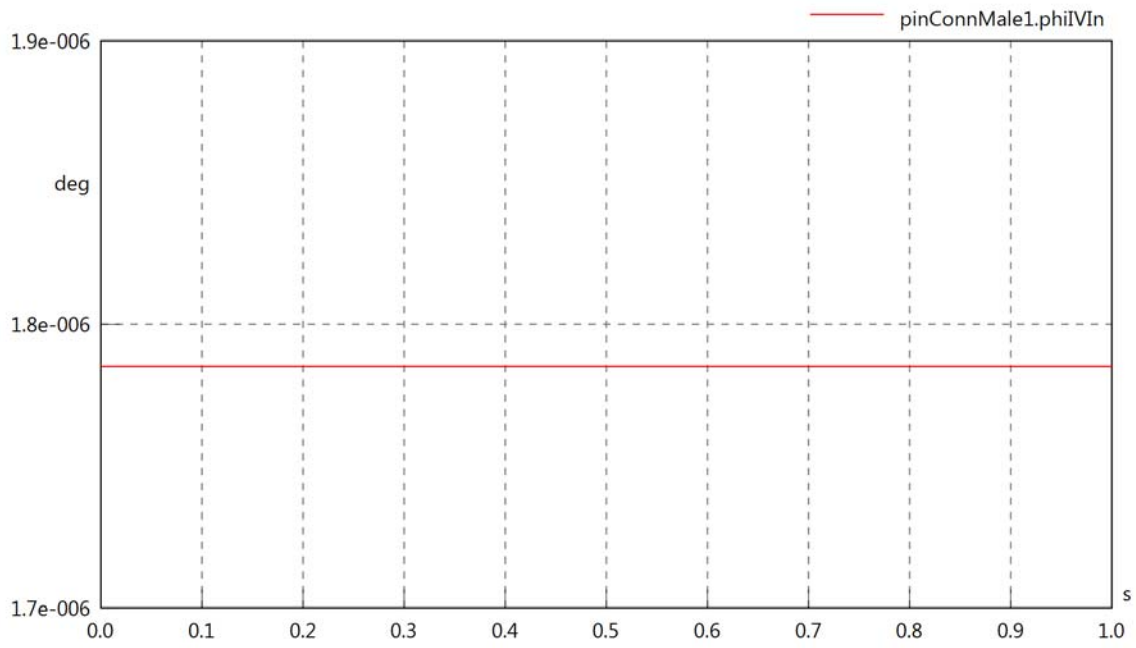

pinConnMale1.phiVOut

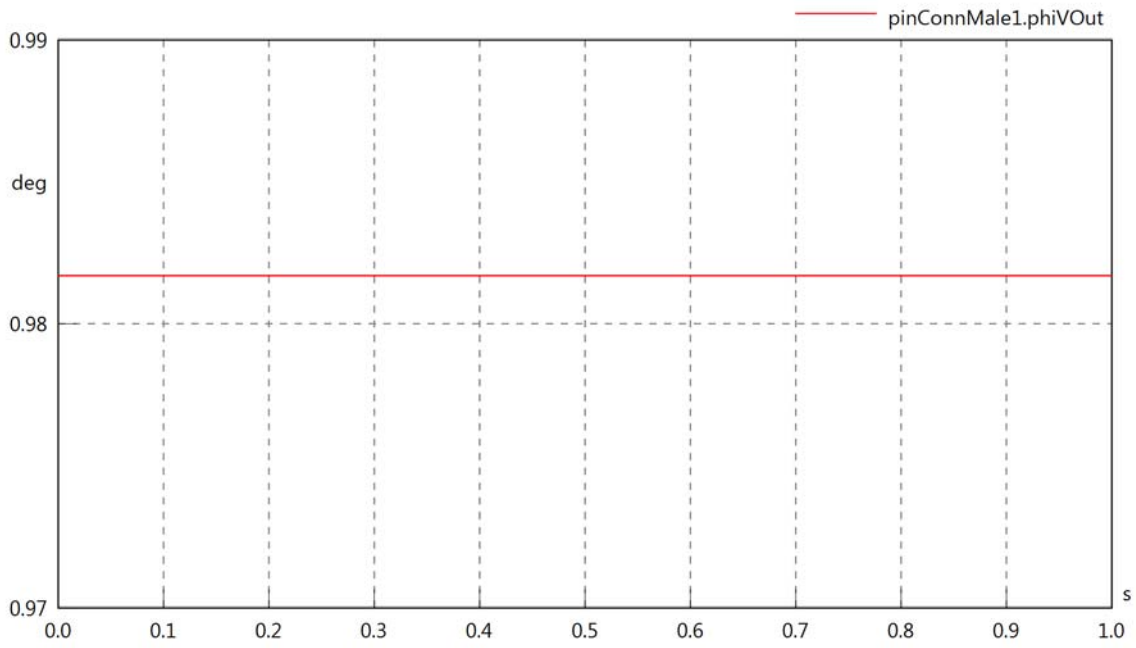

pinConnMale1.phiIOut

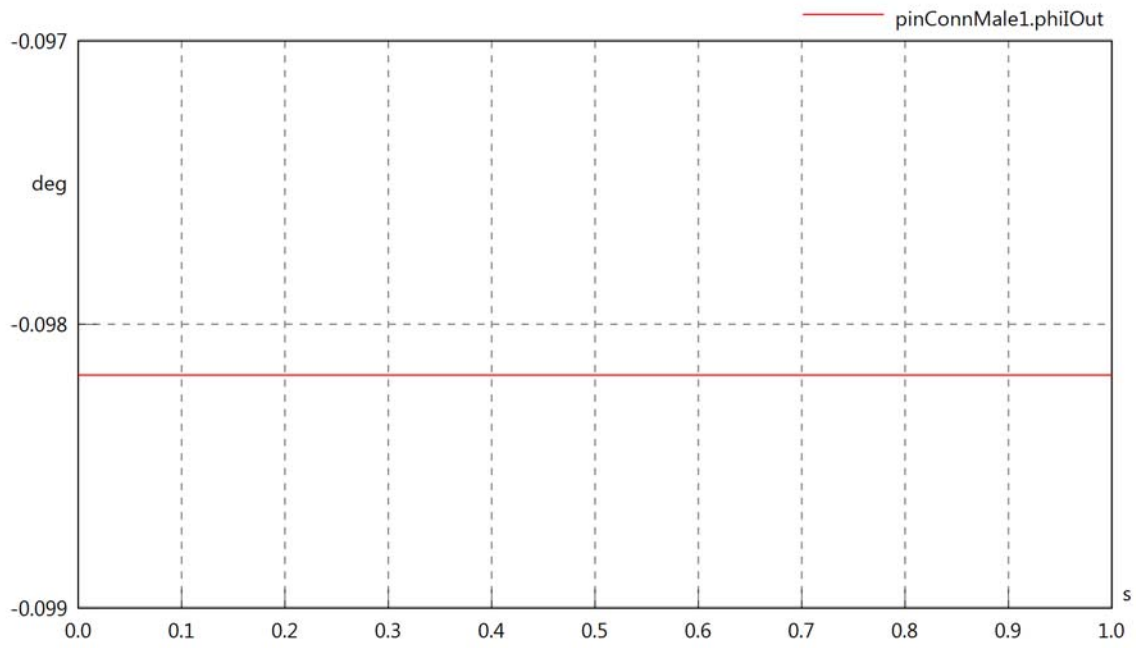

pinConnMale1.phiIVOut

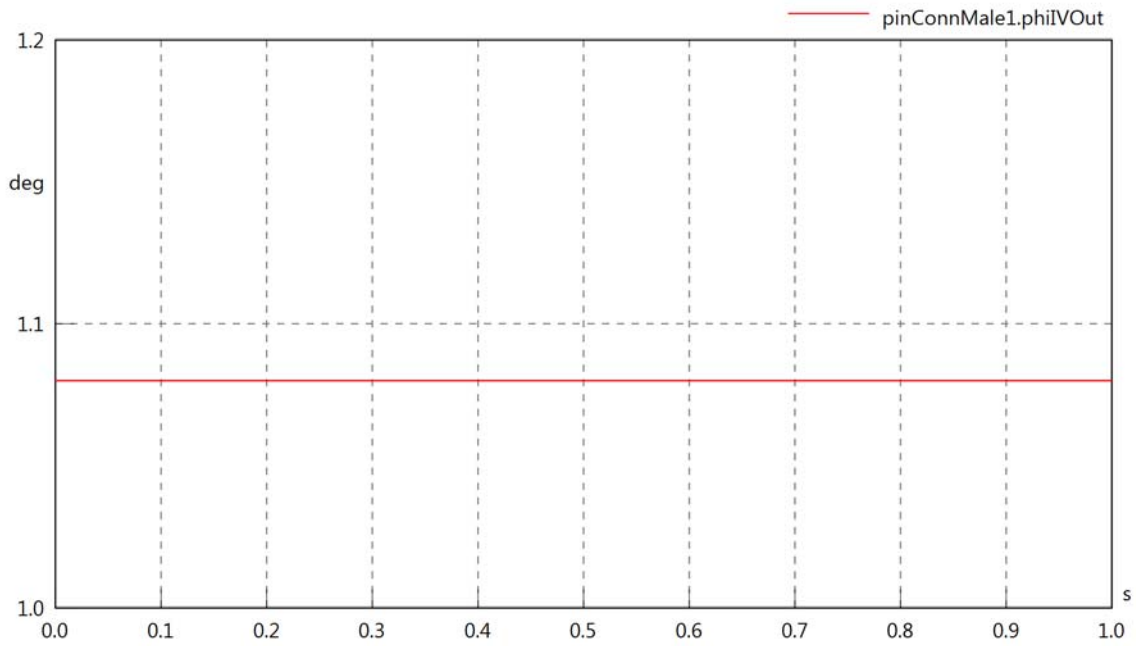

pinConnMale1.PReIn

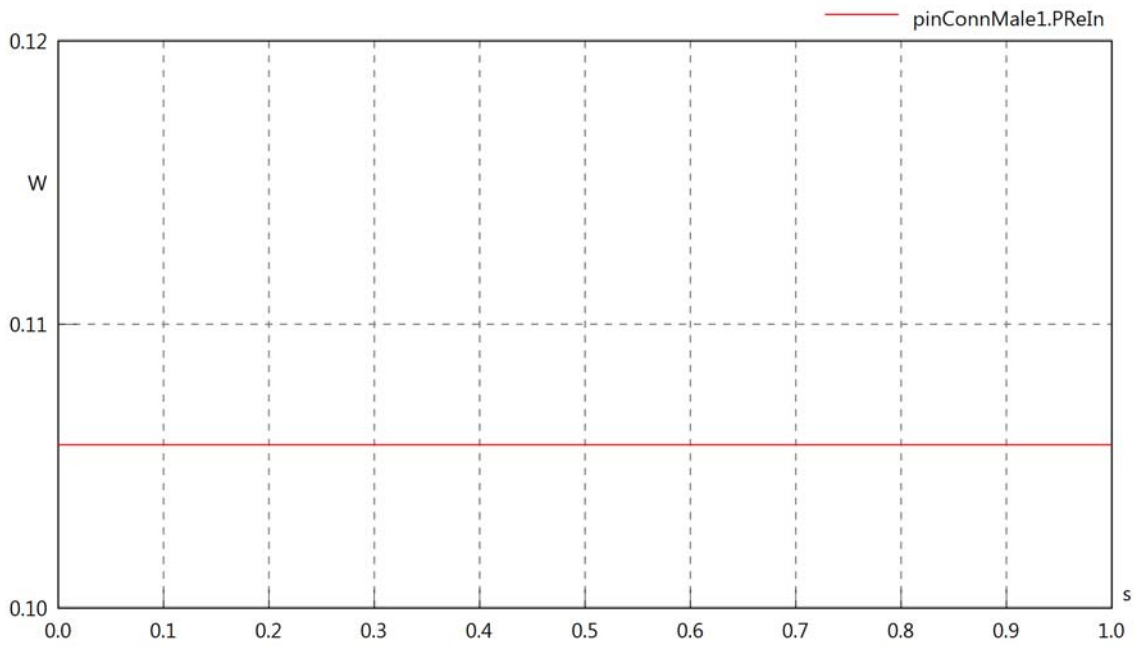

pinConnMale1.PImIn

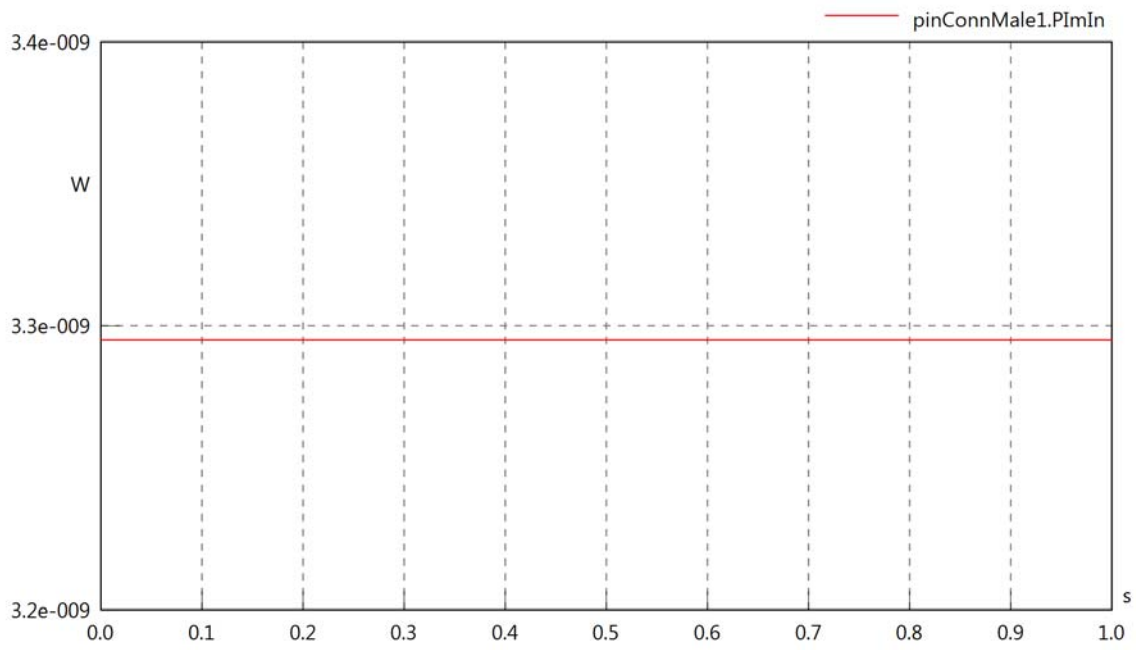

pinConnMale1.SIn

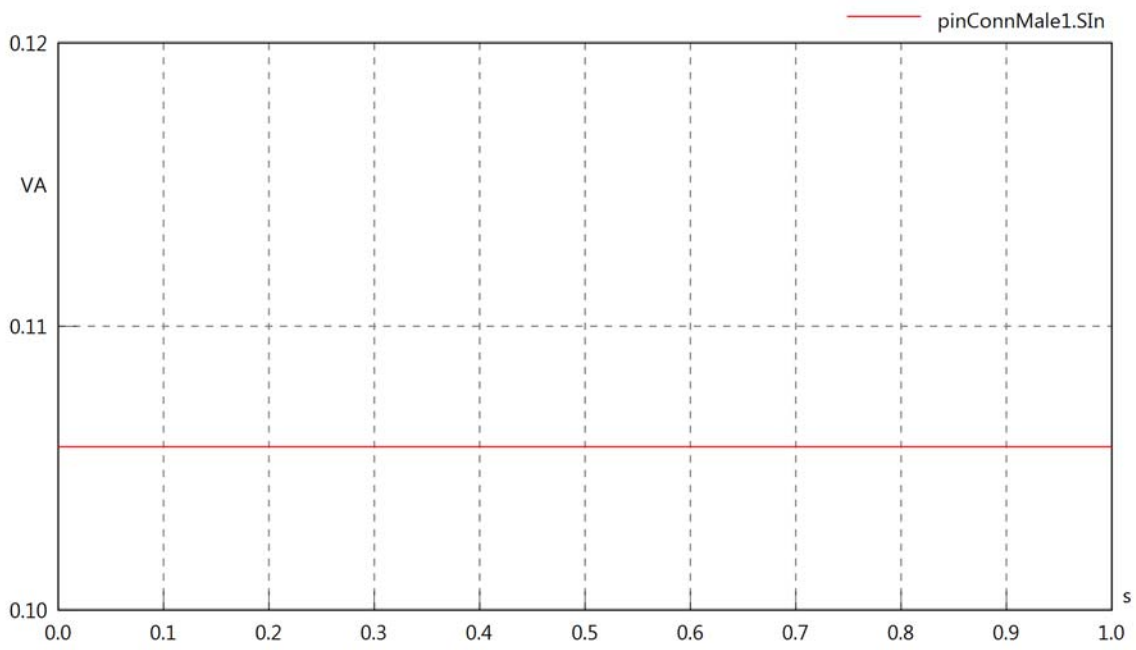

pinConnMale1.PReOut

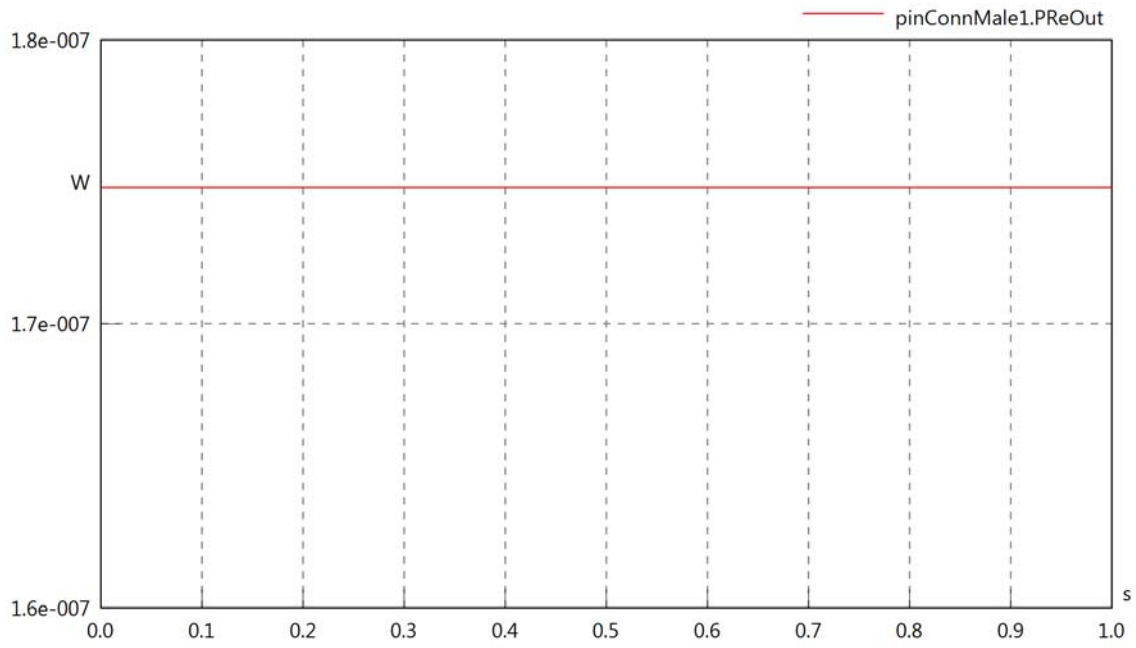

pinConnMale1.PImOut

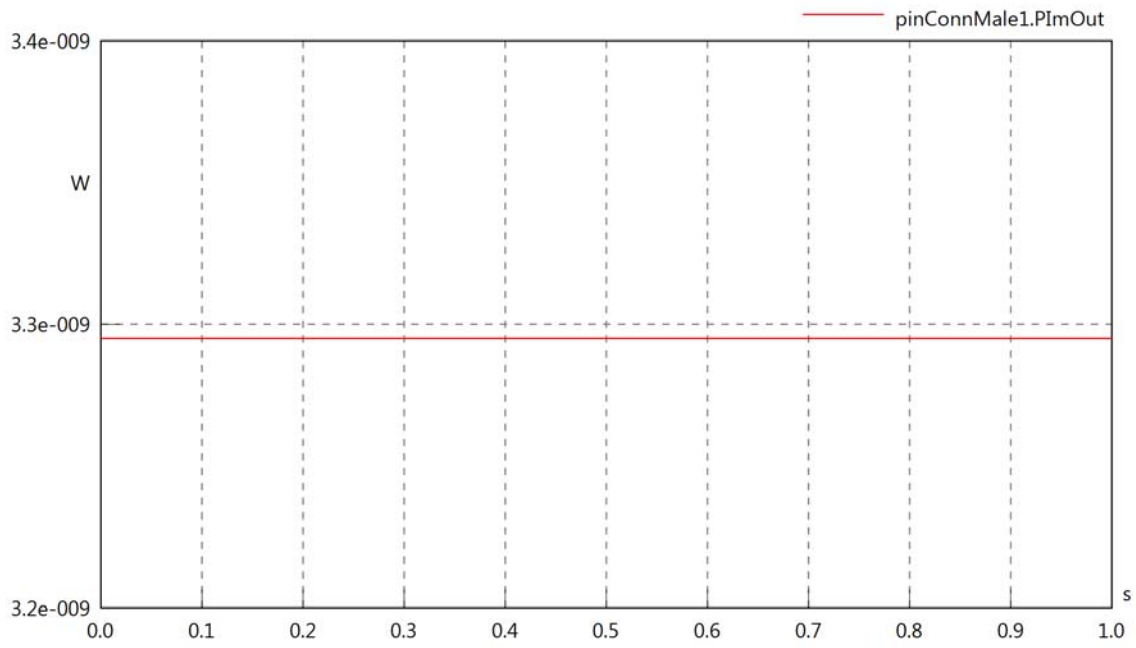

pinConnMale1.SOut

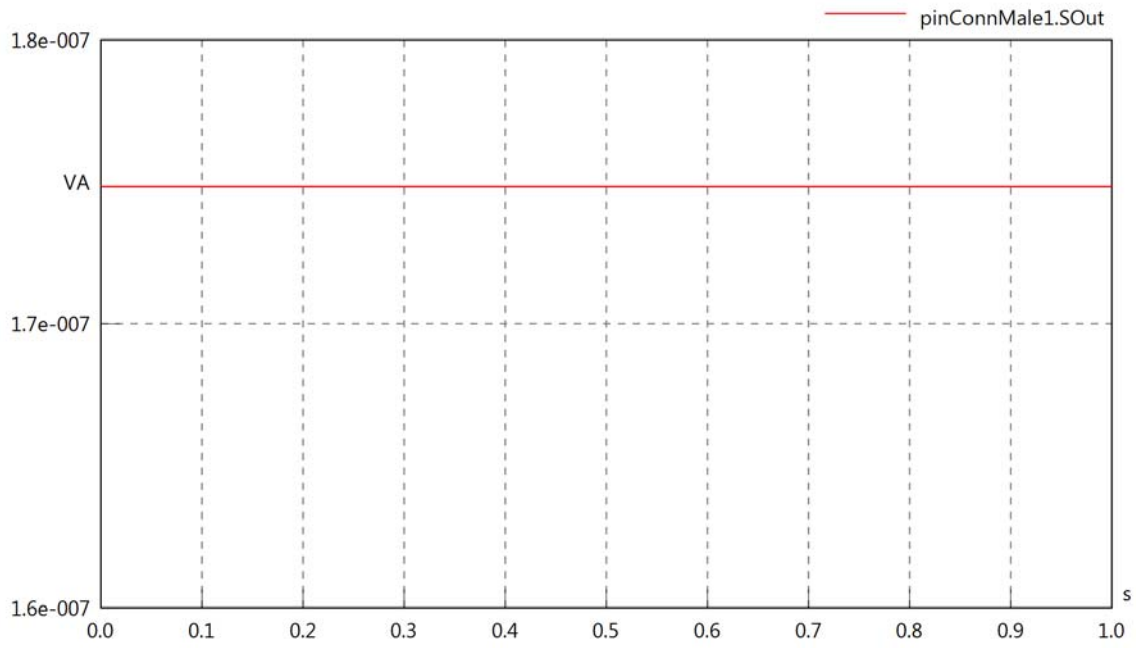
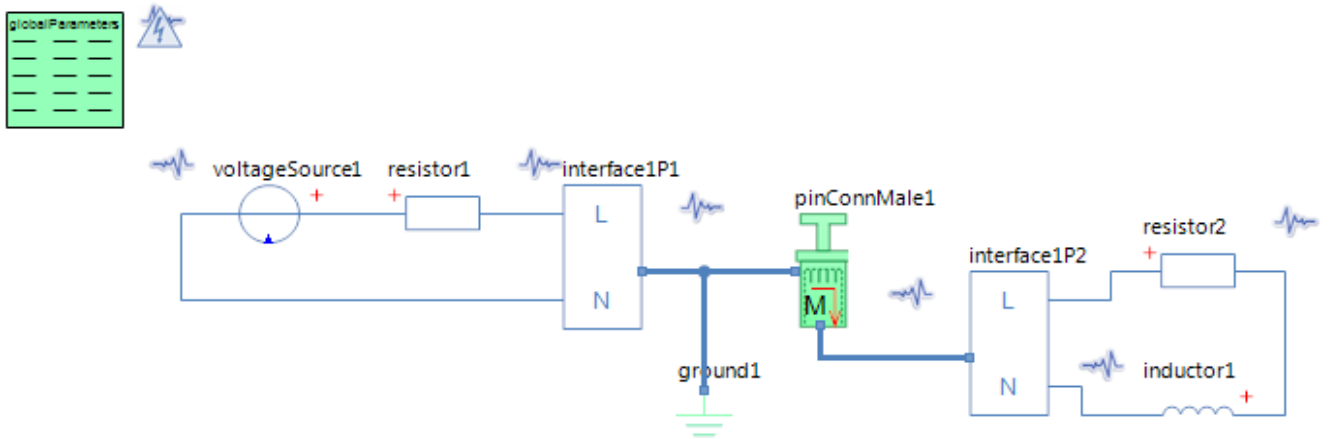

Diagram View



GlobalParameters globalParameters
Parameters

Comment	Name	Current Value	Unit
Type of Calculation	eCalculationKind	Signal Calculation	
Description of Frequency	eFrequencyKind	Linear	
Minimum Frequency	fMin	4000	[Hz]
Maximum Frequency	fMax	4000	[Hz]

Voltage Source voltageSource1
Parameters

Comment	Name	Current Value	Unit
Voltage RMS	VrmsSrc	230	[V]
Phase	phi	0	[deg]

Resistor resistor1
Parameters

Comment	Name	Current Value	Unit
Resistance	R	100	[Ohm]

Resistor resistor2
Parameters

Comment	Name	Current Value	Unit
Resistance	R	100	[Ohm]

Inductor inductor1
Parameters

Comment	Name	Current Value	Unit
Inductance	L	5	[mH]

Pin Connector Male pinConnMale1
Parameters

Comment	Name	Current Value	Unit
Poor or failing L1 connection	bL1	true	
Resistance in L1 connection	rL1	1	[kOhm]
Conductance between L1 and N	G	50	[1/Ohm]

pinConnMale1.VrmsIn

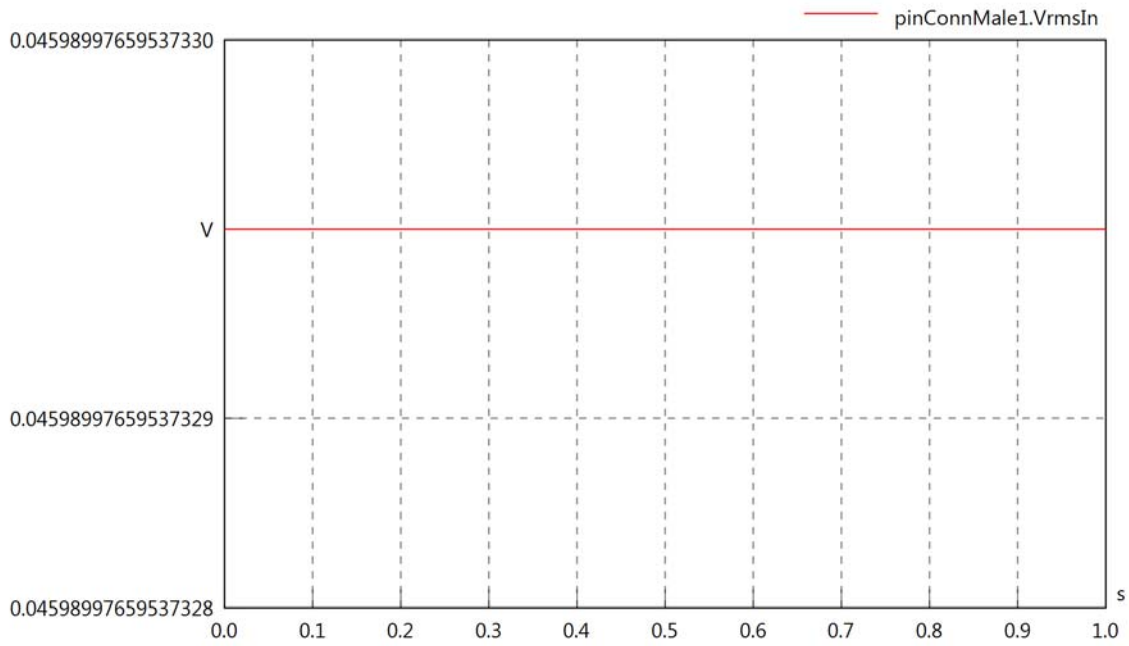

pinConnMale1.vReIn

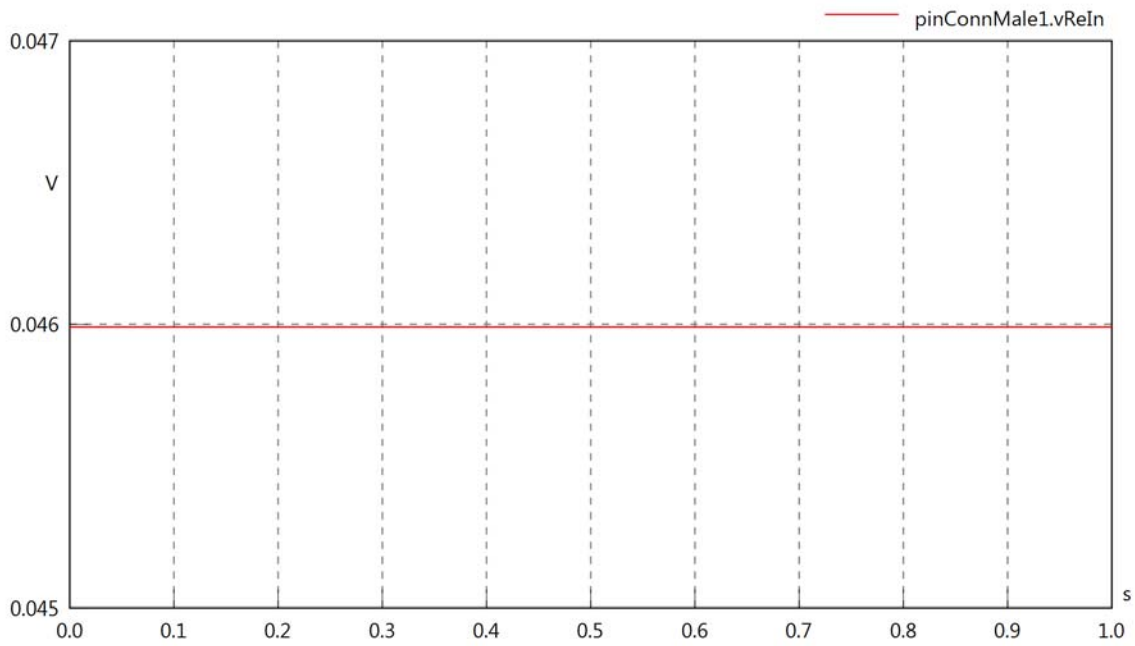

pinConnMale1.vImIn

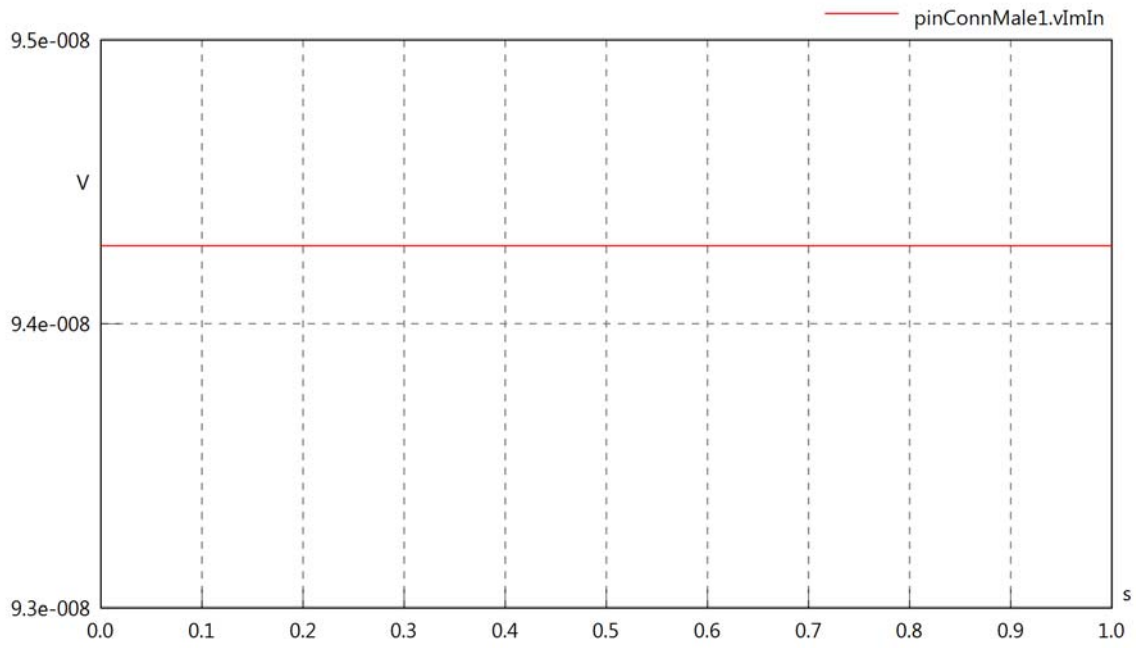

pinConnMale1.VrmsOut

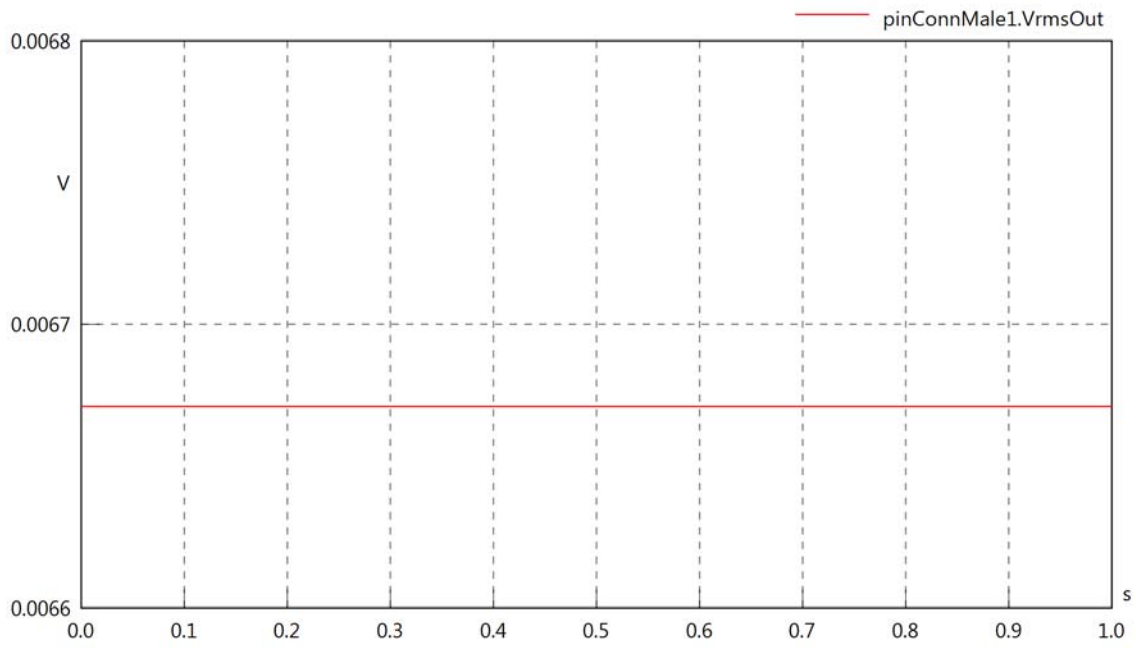

pinConnMale1.vReOut

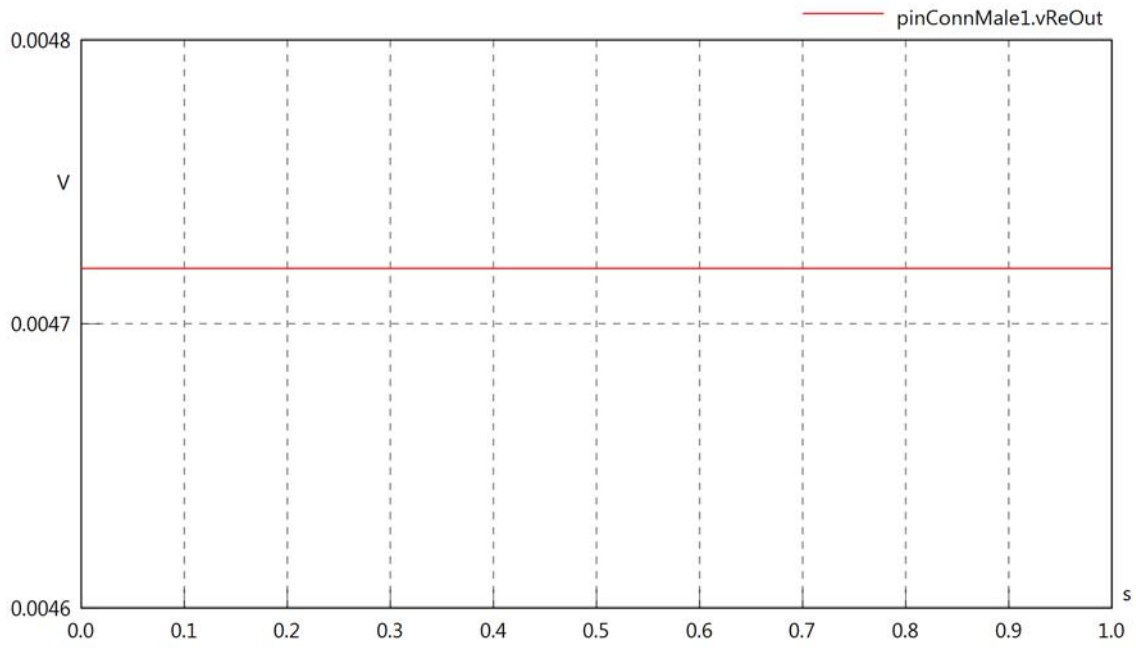

pinConnMale1.vImOut

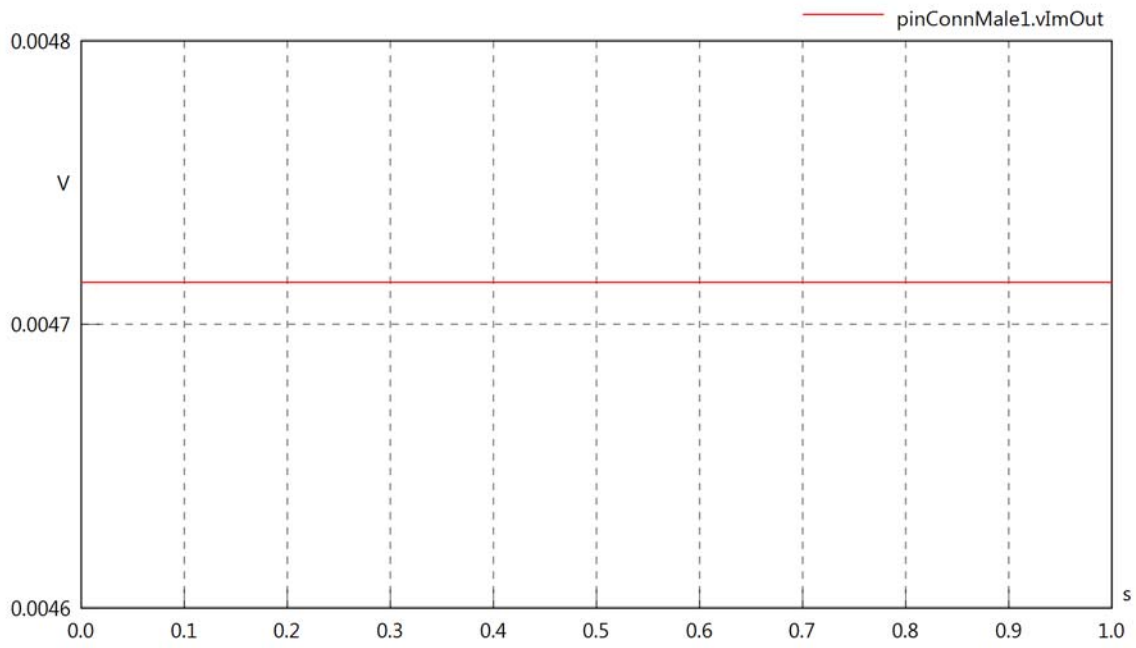

pinConnMale1.Vrms

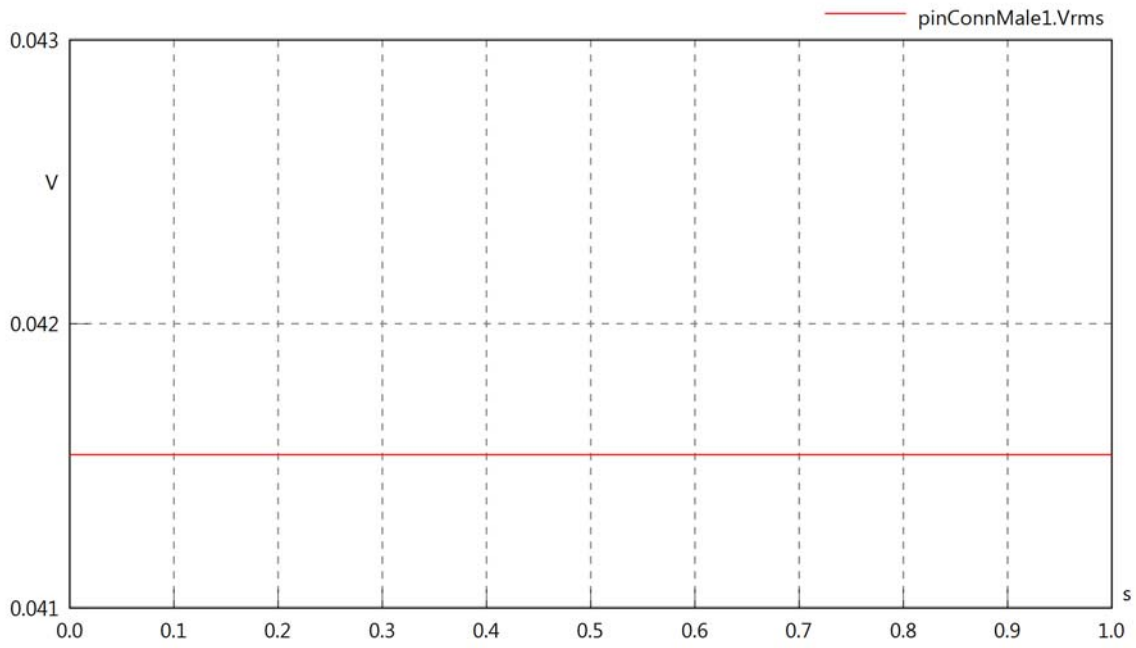

pinConnMale1.vRe

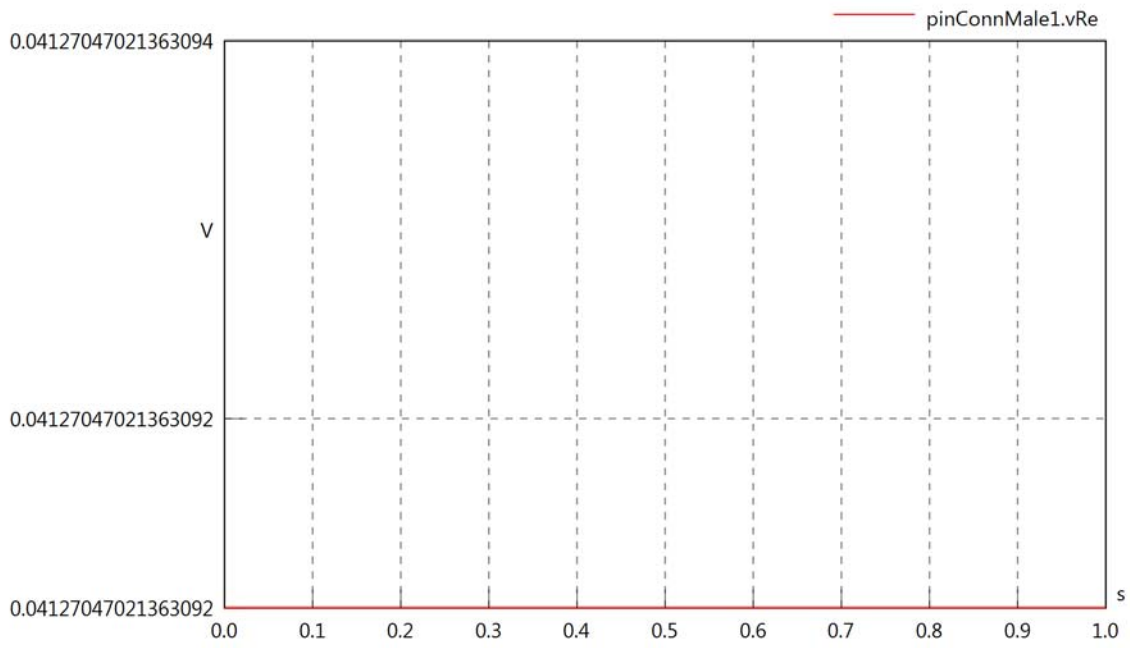

pinConnMale1.vIm

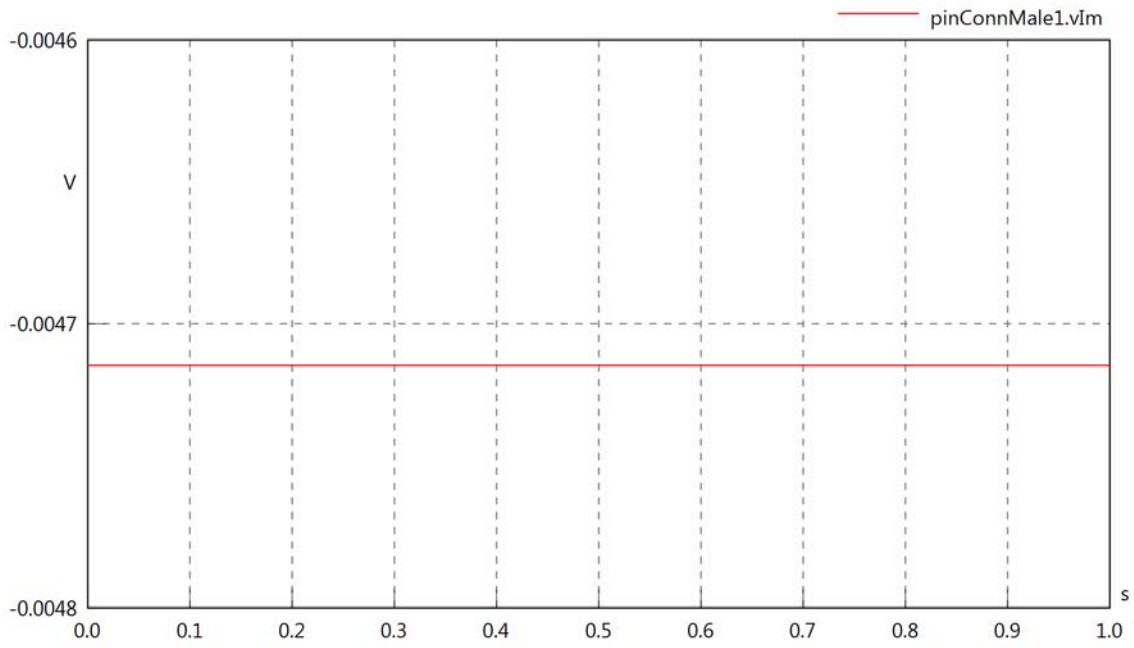

pinConnMale1.IrmsIn

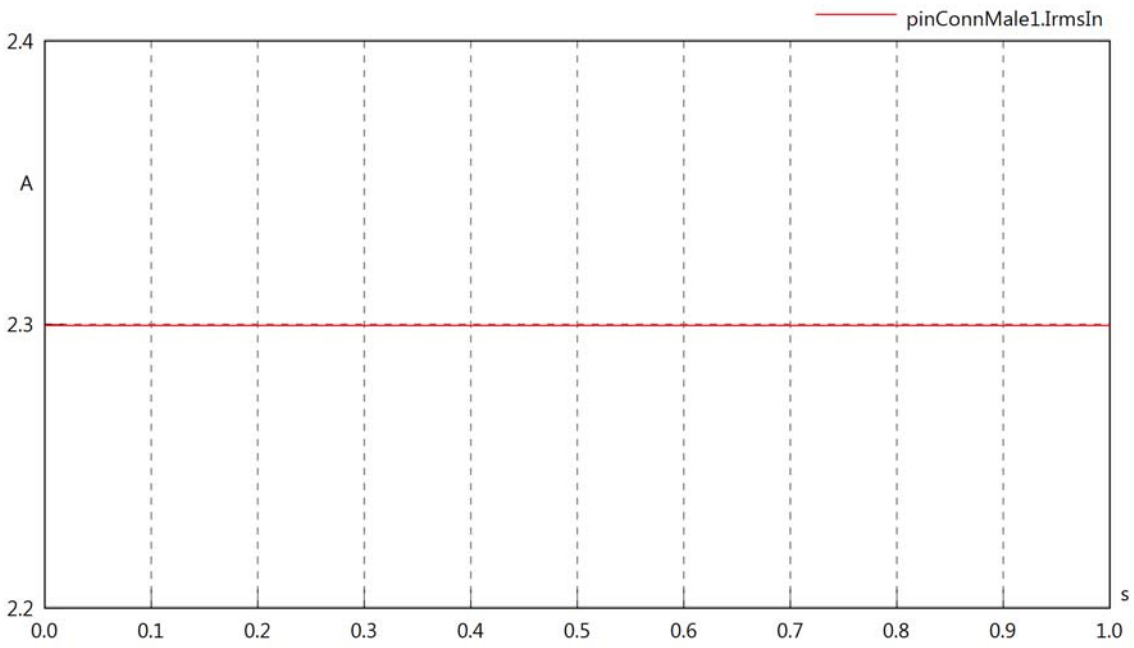

pinConnMale1.iReIn

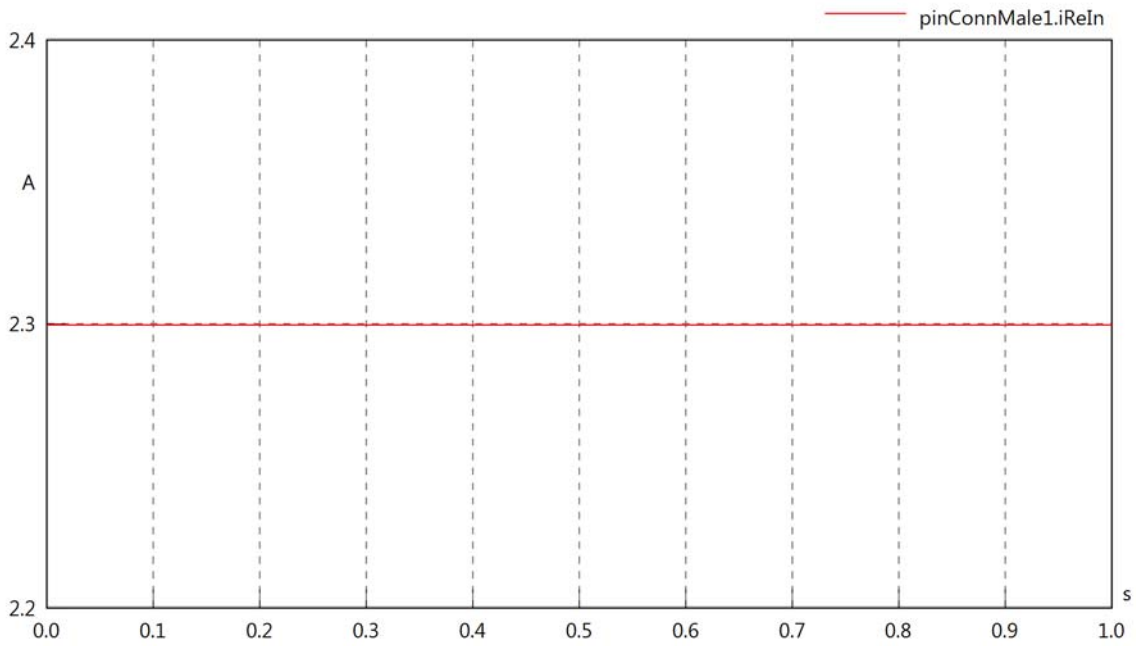

pinConnMale1.iImIn

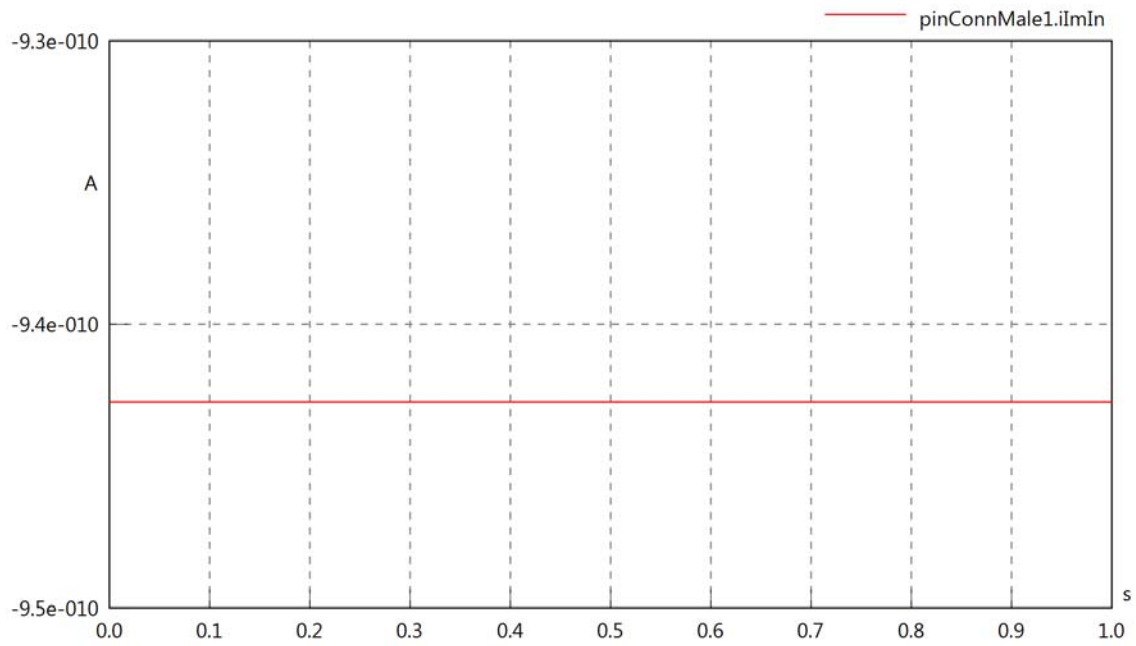

pinConnMale1.IrmsOut

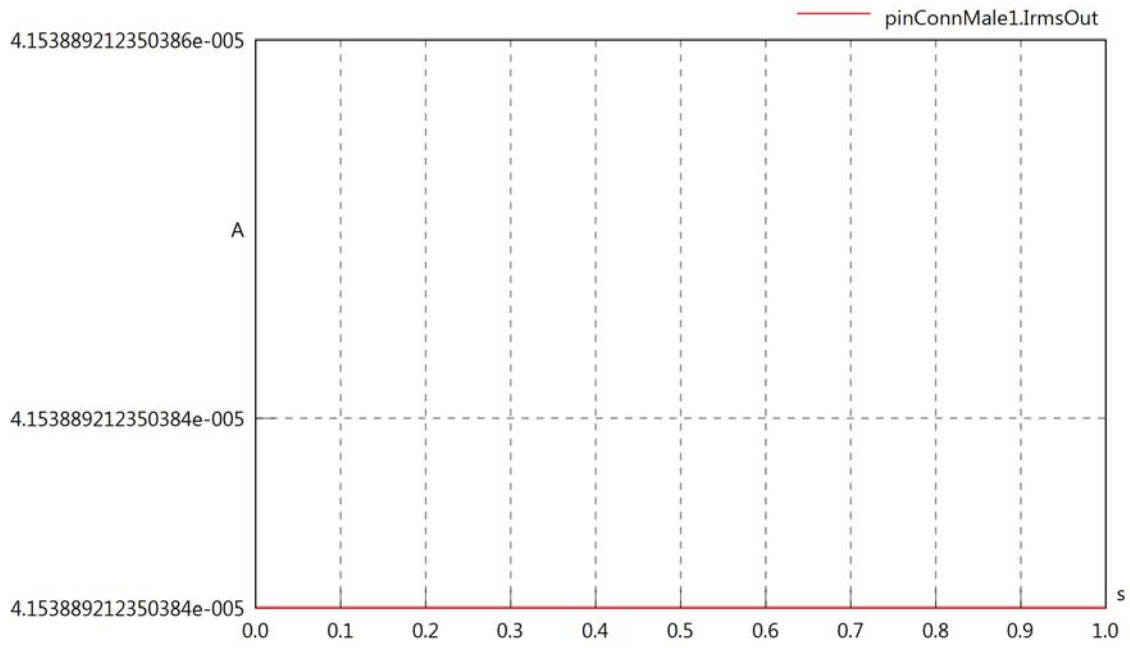

pinConnMale1.iReOut

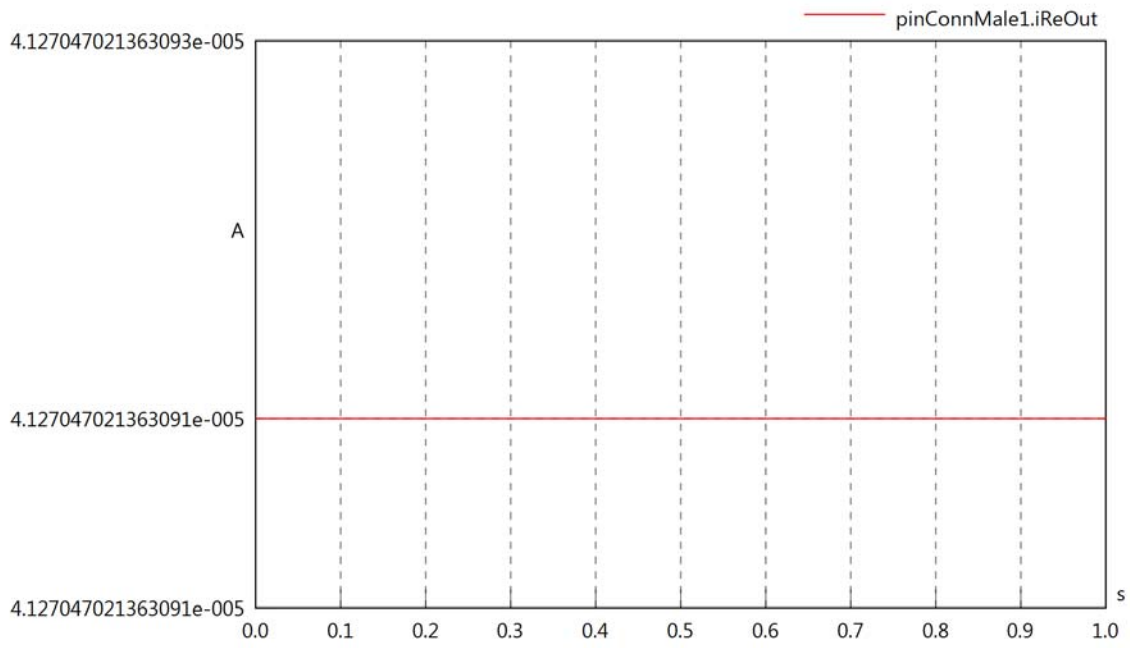

pinConnMale1.iImOut

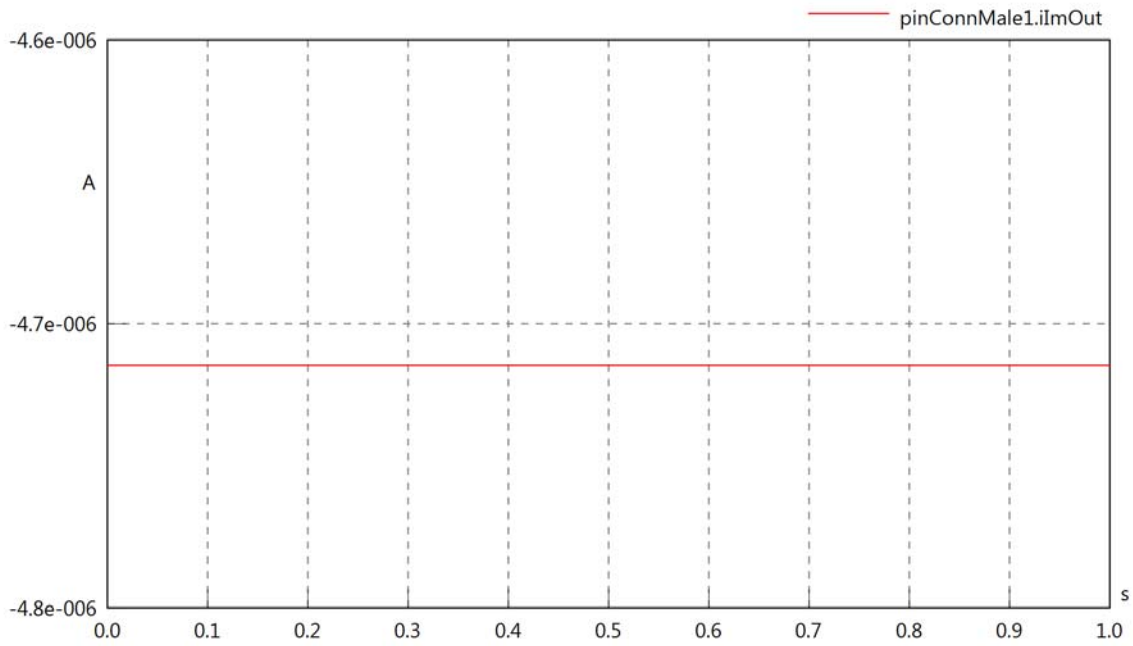

pinConnMale1.phiVIn

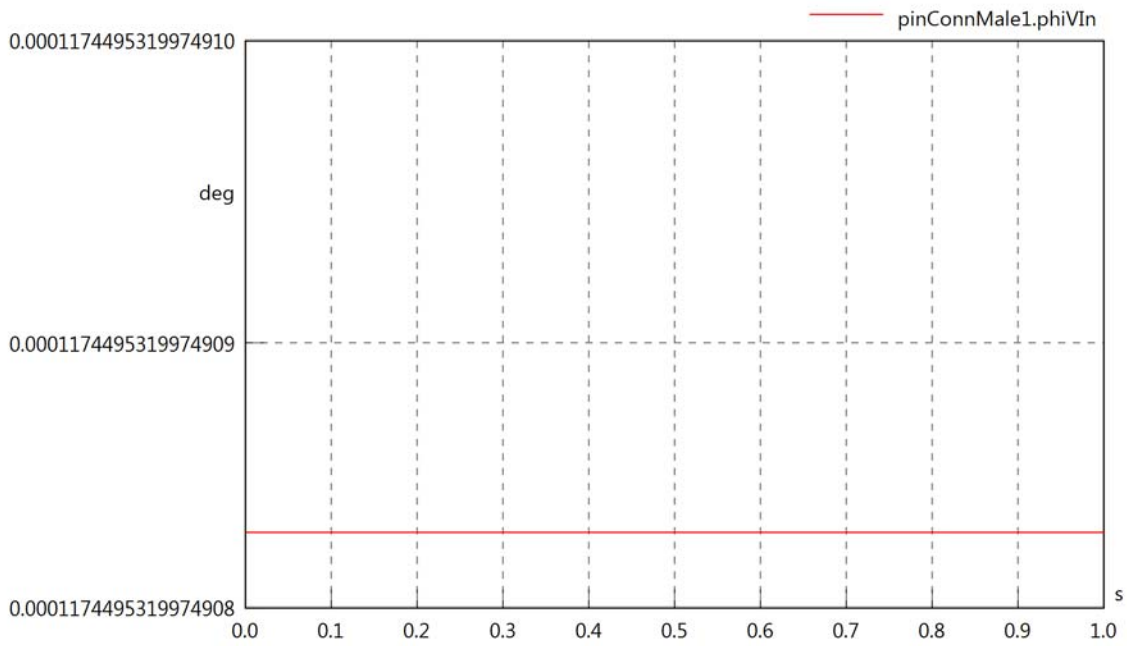

pinConnMale1.phiIIn

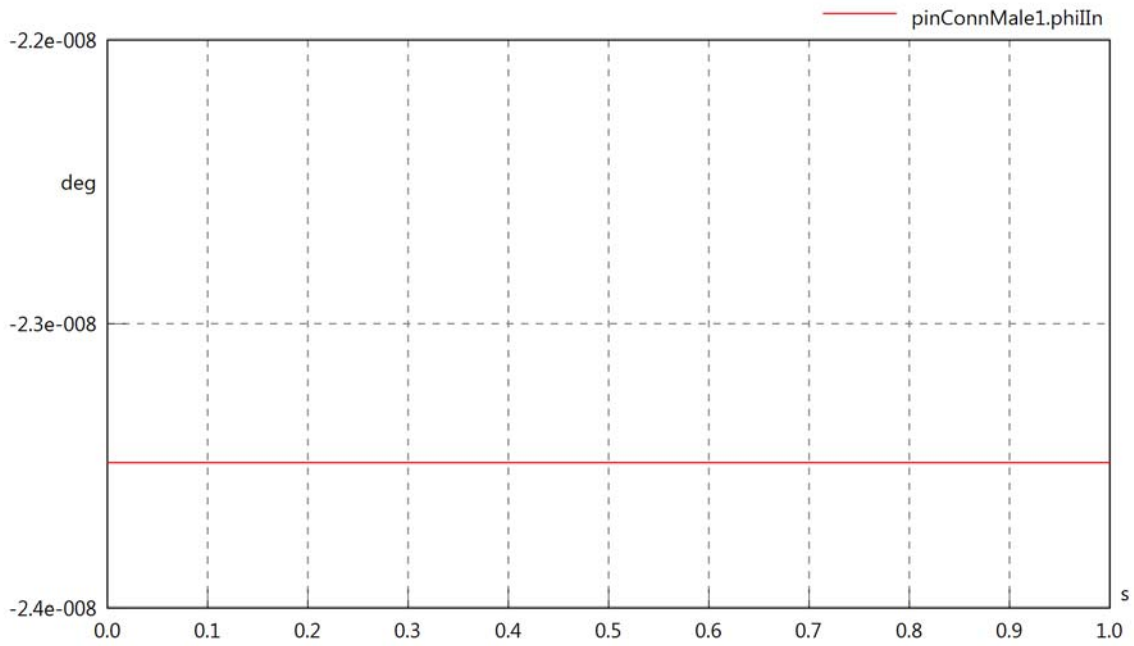

pinConnMale1.phiIVIn

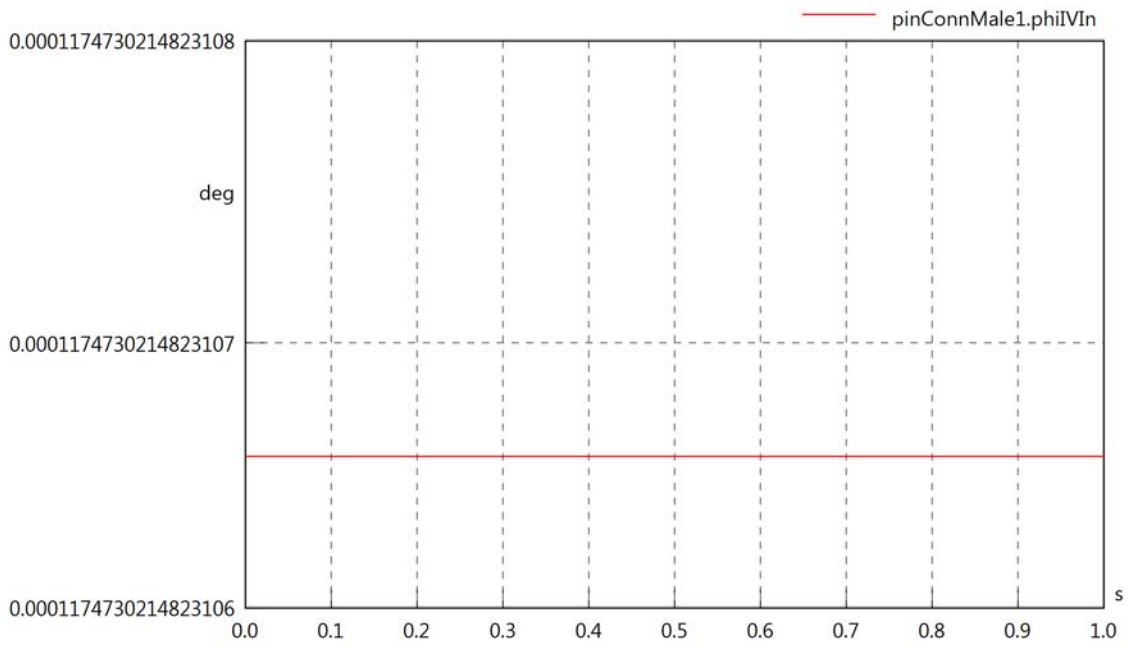

pinConnMale1.phiVOut

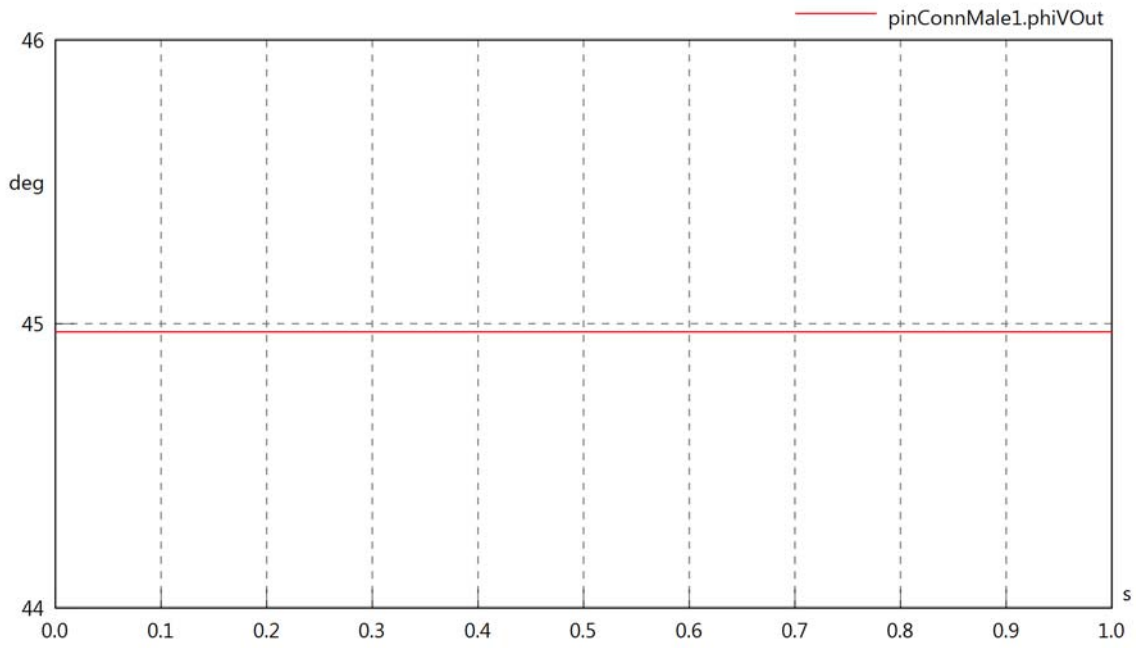

pinConnMale1.phiIOut

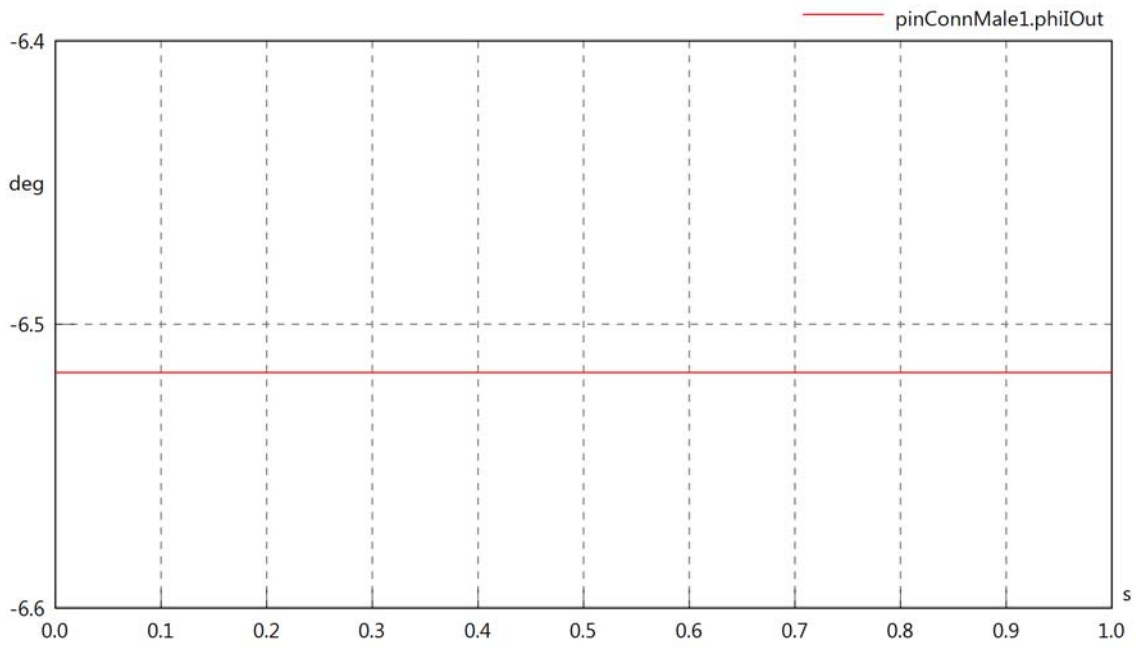

pinConnMale1.phiIVOut

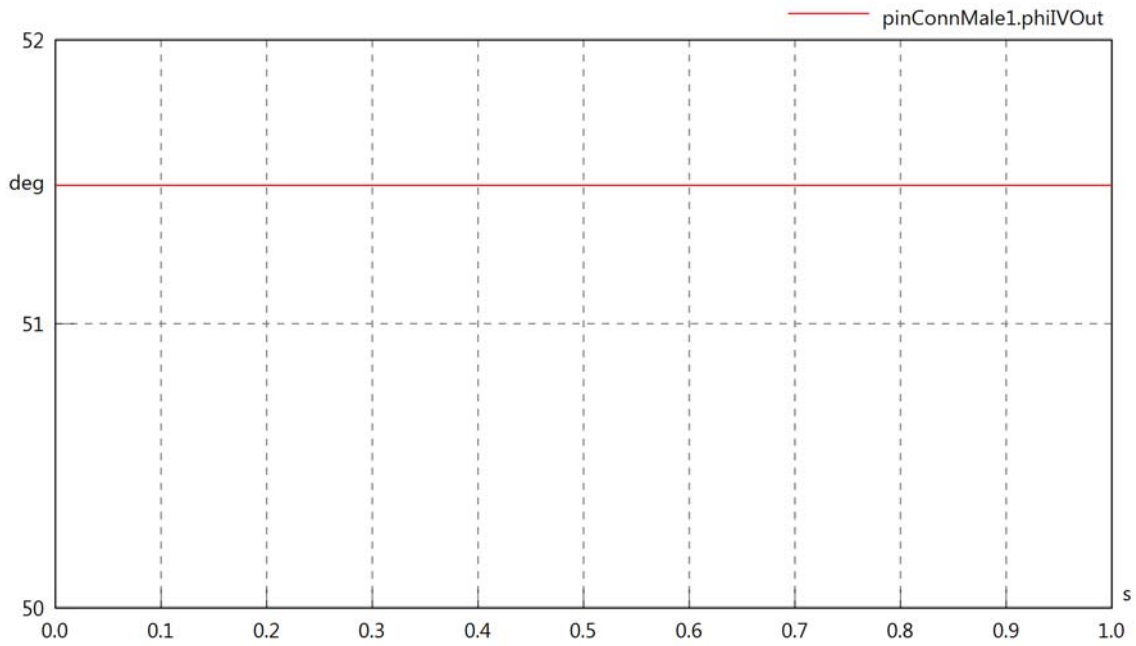

pinConnMale1.PReIn

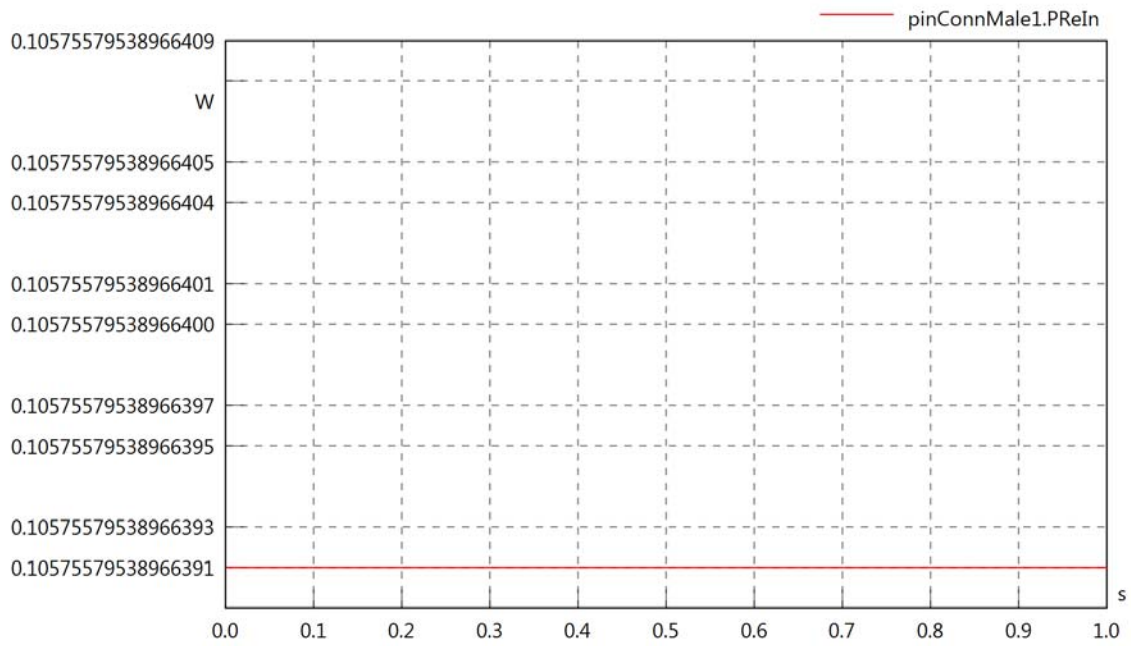

pinConnMale1.PImIn

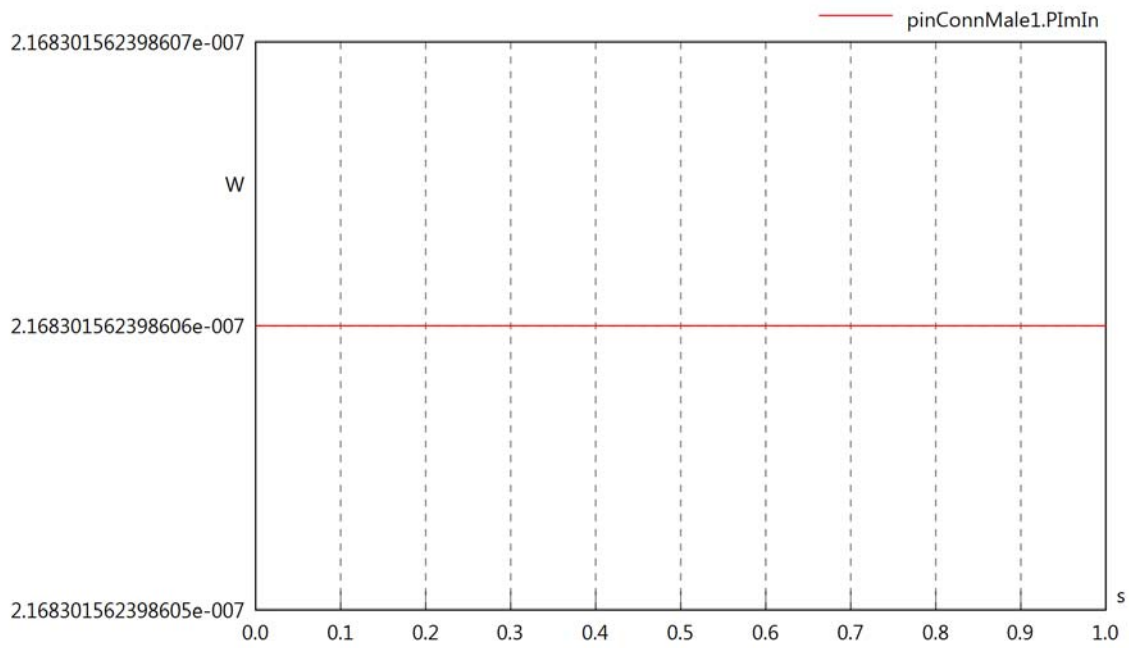

pinConnMale1.SIn

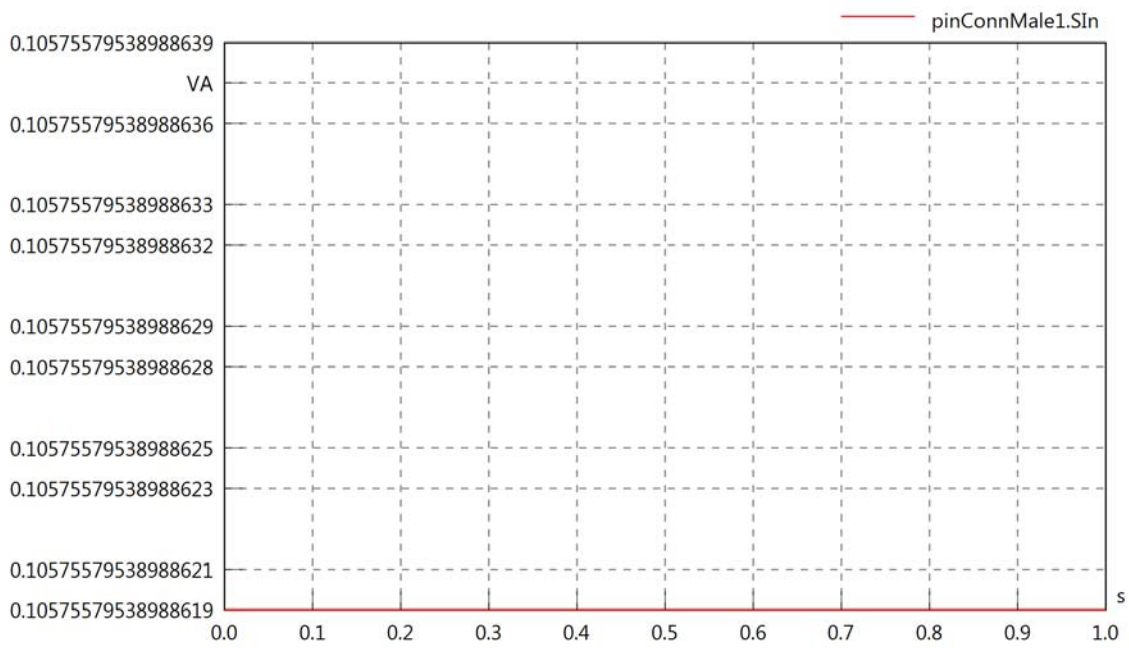

pinConnMale1.PReOut

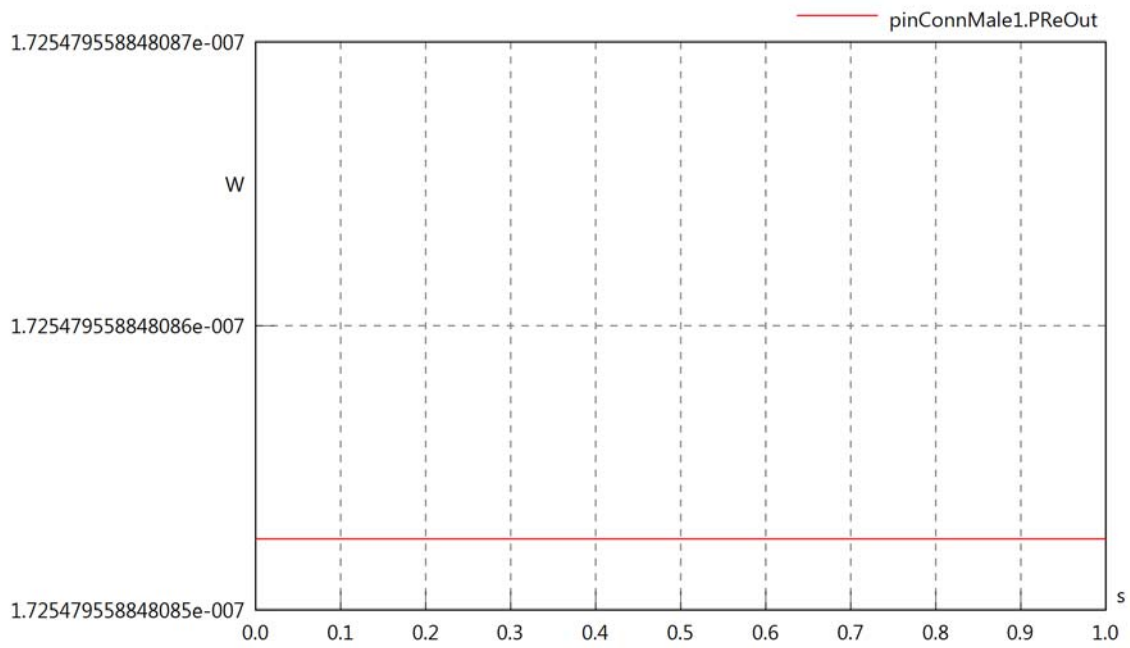

pinConnMale1.PImOut

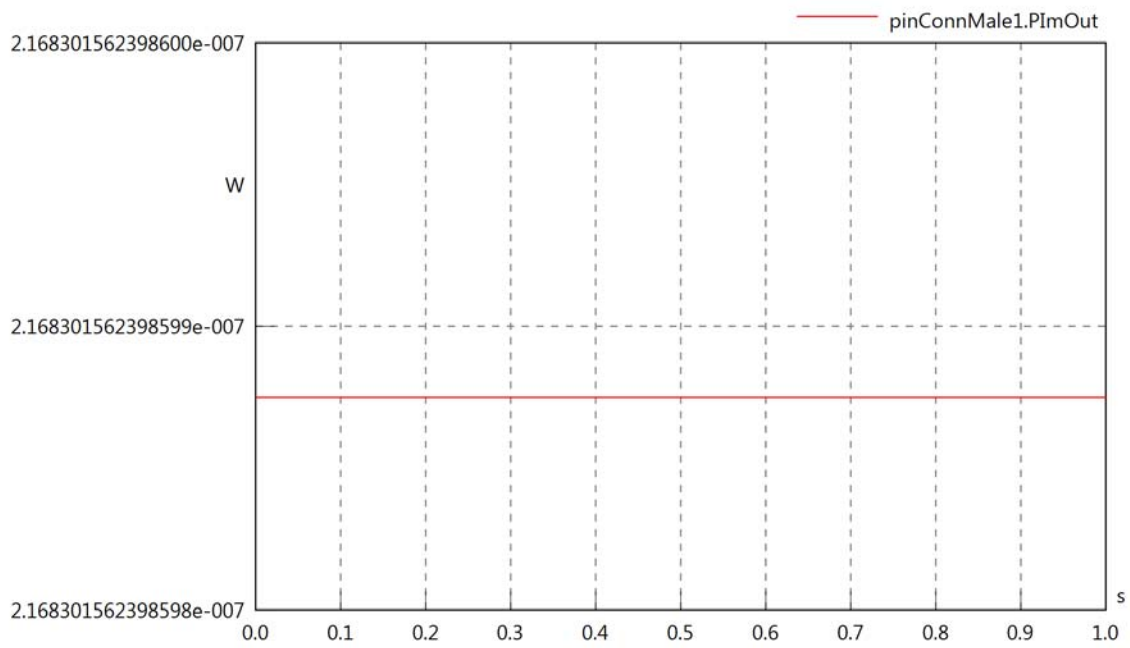

pinConnMale1.SOut

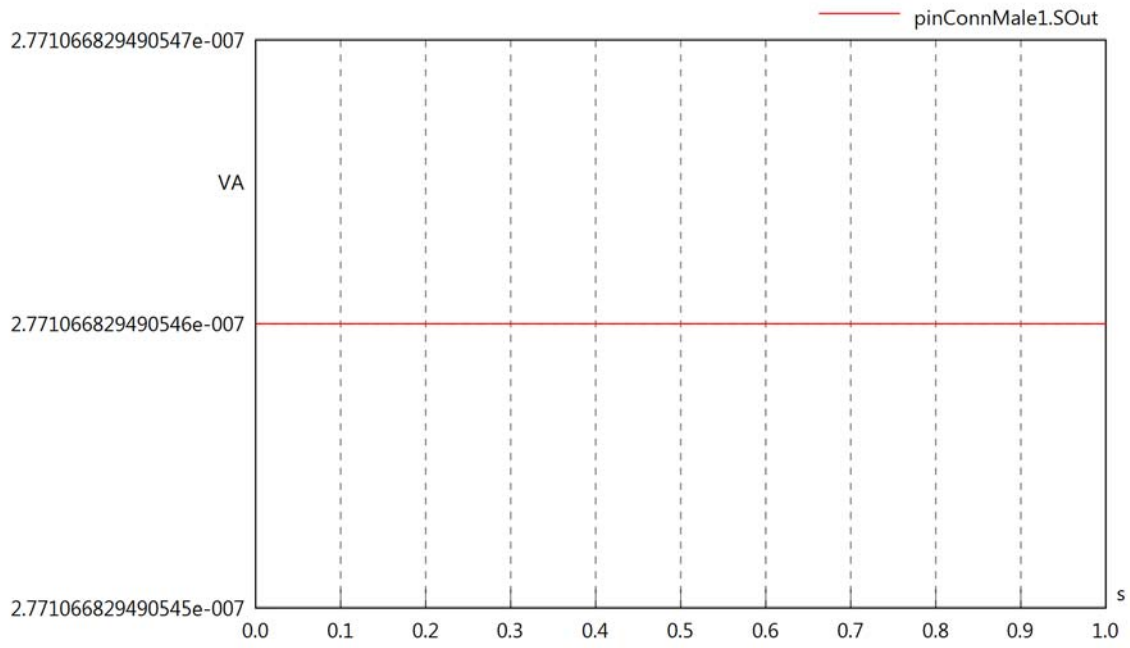
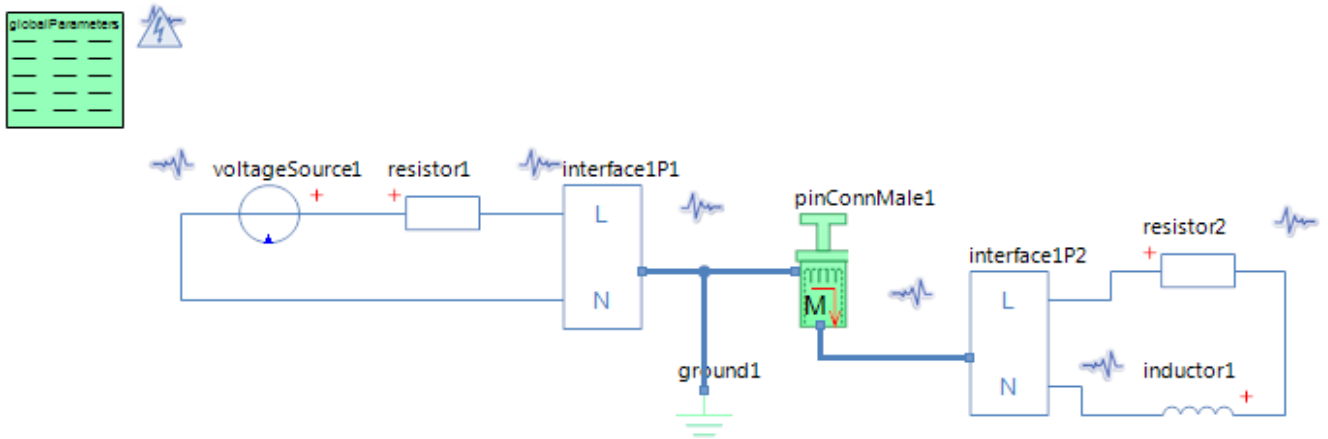

Diagram View



GlobalParameters globalParameters
Parameters

Comment	Name	Current Value	Unit
Type of Calculation	eCalculationKind	Signal Calculation	
Description of Frequency	eFrequencyKind	Linear	
Minimum Frequency	fMin	20000	[Hz]
Maximum Frequency	fMax	20000	[Hz]

Voltage Source voltageSource1
Parameters

Comment	Name	Current Value	Unit
Voltage RMS	VrmsSrc	230	[V]
Phase	phi	0	[deg]

Resistor resistor1
Parameters

Comment	Name	Current Value	Unit
Resistance	R	100	[Ohm]

Resistor resistor2
Parameters

Comment	Name	Current Value	Unit
Resistance	R	100	[Ohm]

Inductor inductor1
Parameters

Comment	Name	Current Value	Unit
Inductance	L	5	[mH]

Pin Connector Male pinConnMale1
Parameters

Comment	Name	Current Value	Unit
Poor or failing L1 connection	bL1	true	
Resistance in L1 connection	rL1	1	[kOhm]
Conductance between L1 and N	G	50	[1/Ohm]

pinConnMale1.VrmsIn

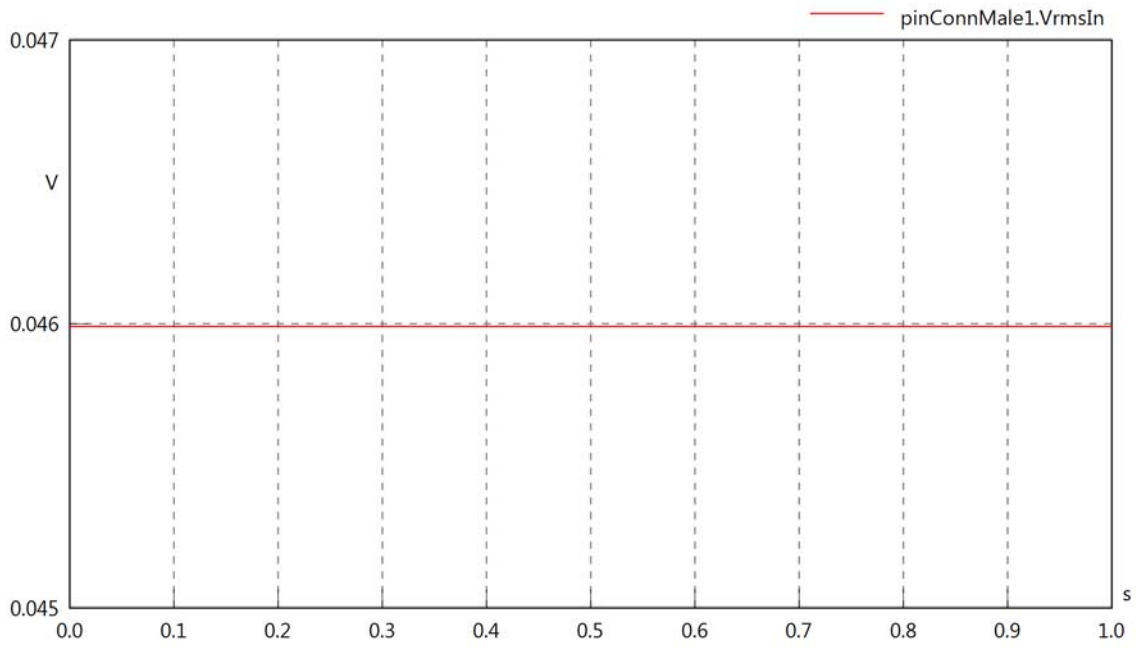

pinConnMale1.vReIn

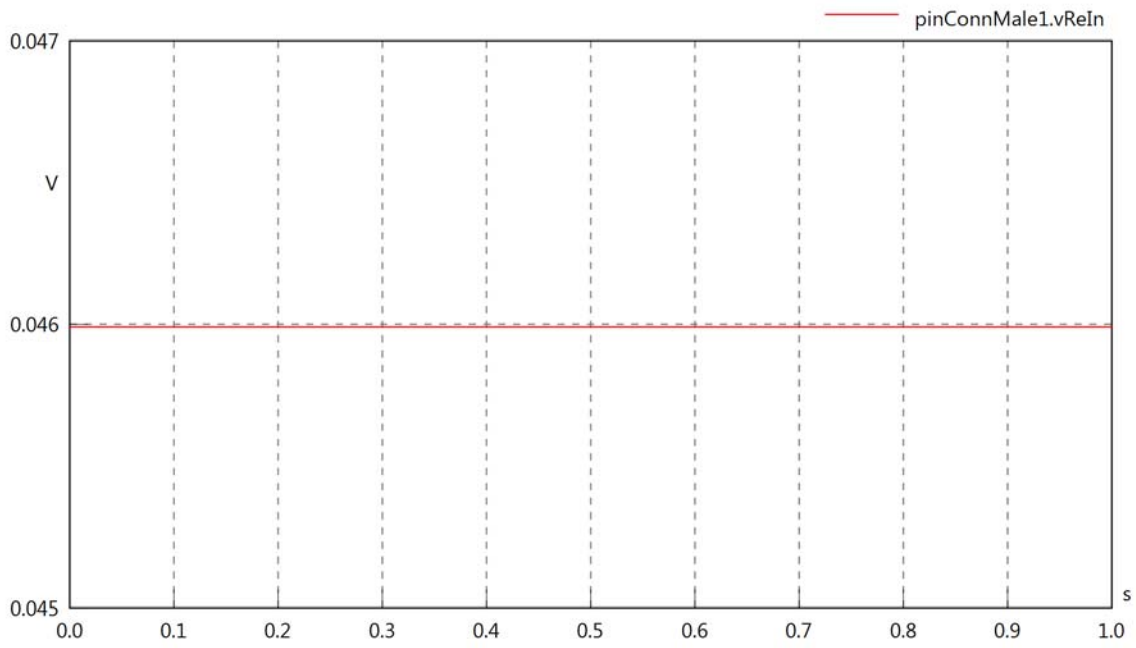

pinConnMale1.vImIn

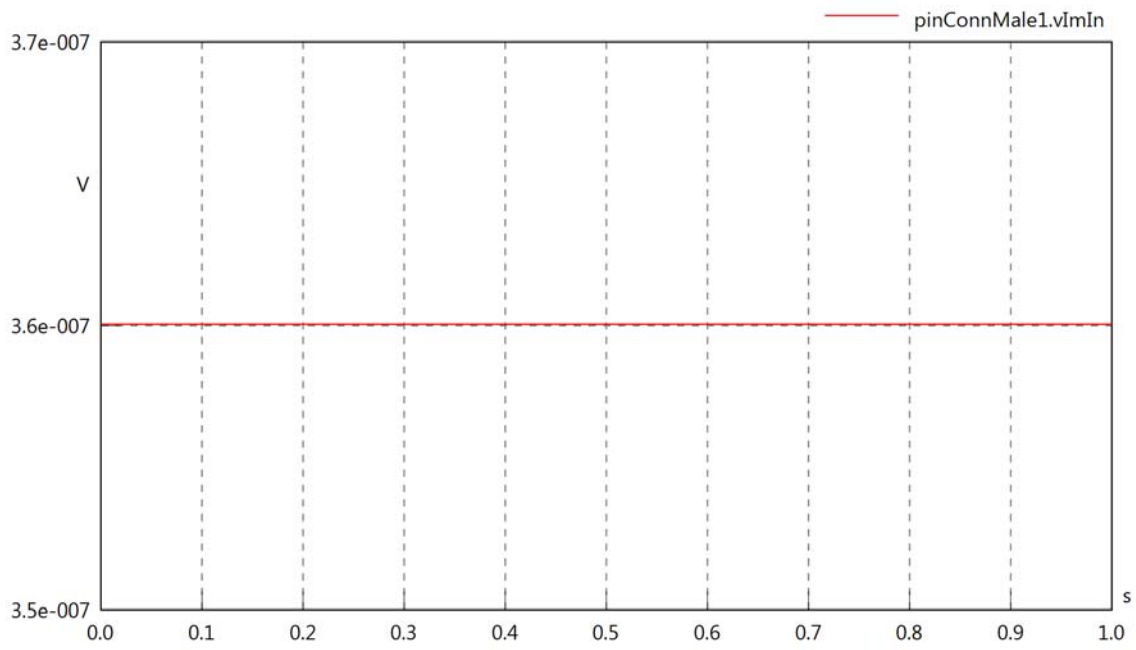

pinConnMale1.VrmsOut

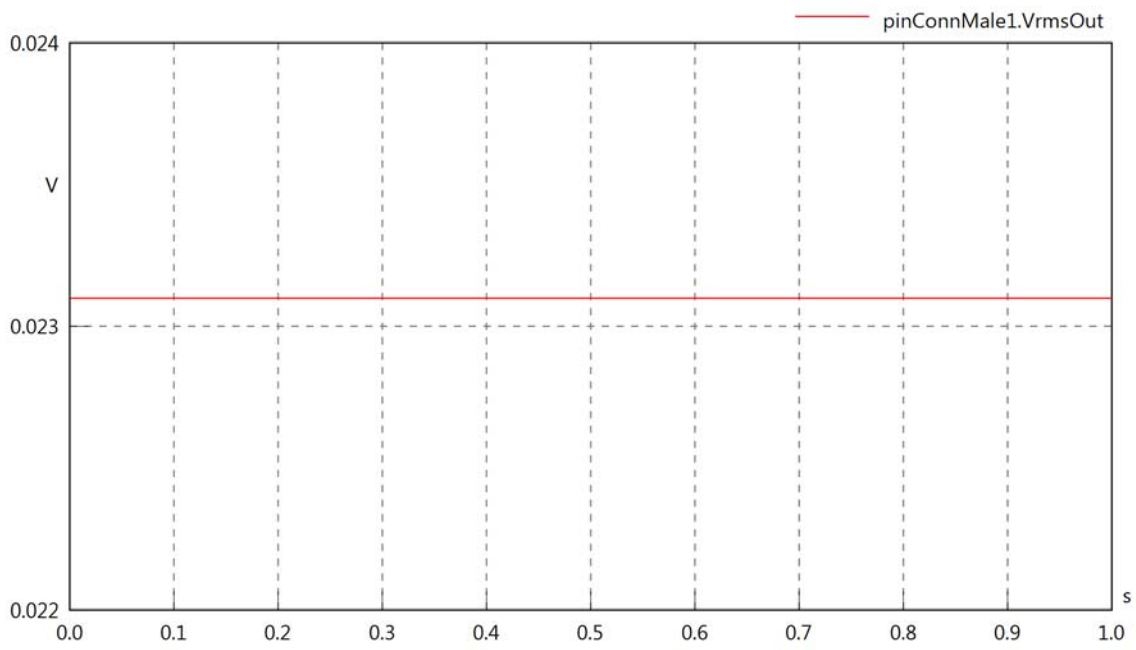

pinConnMale1.vReOut

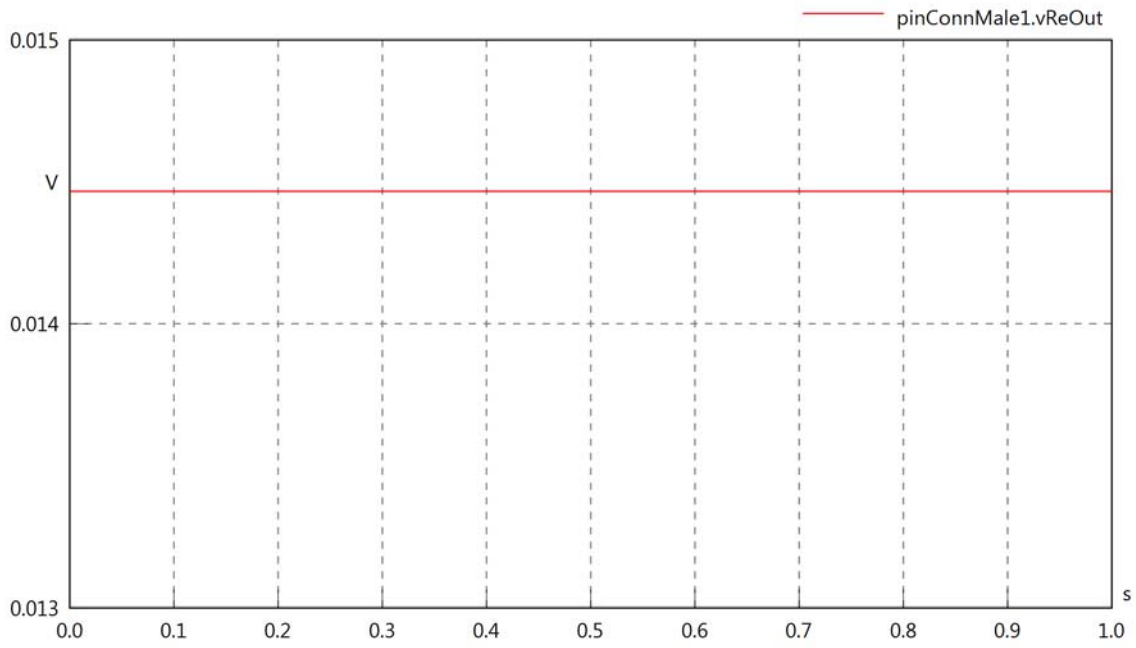

pinConnMale1.vImOut

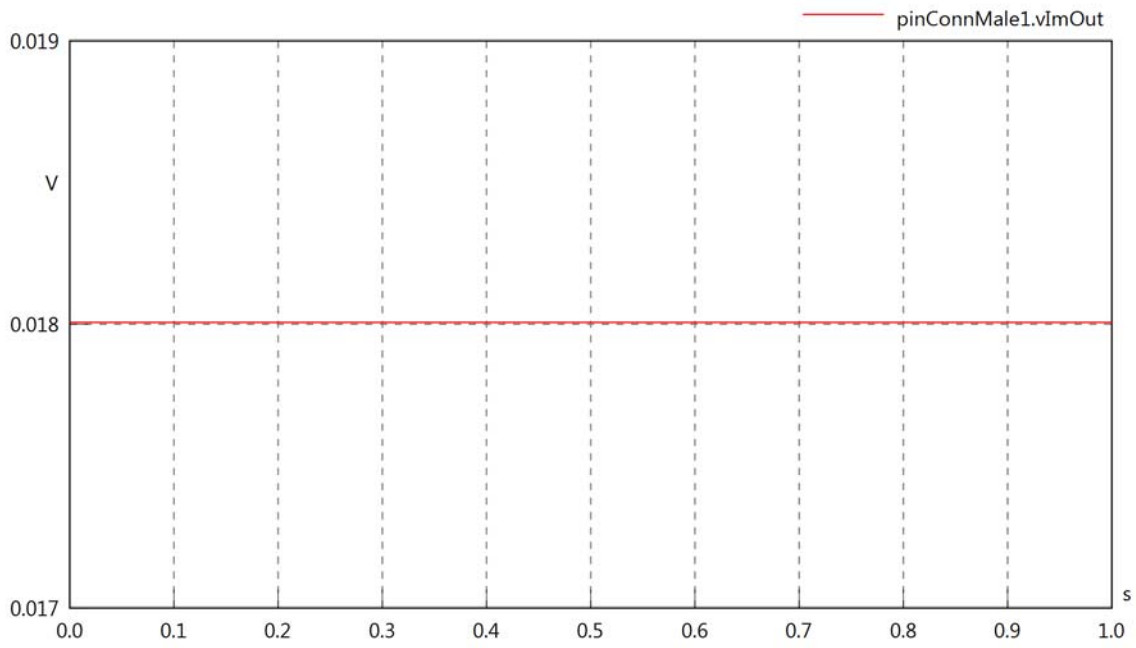

pinConnMale1.Vrms

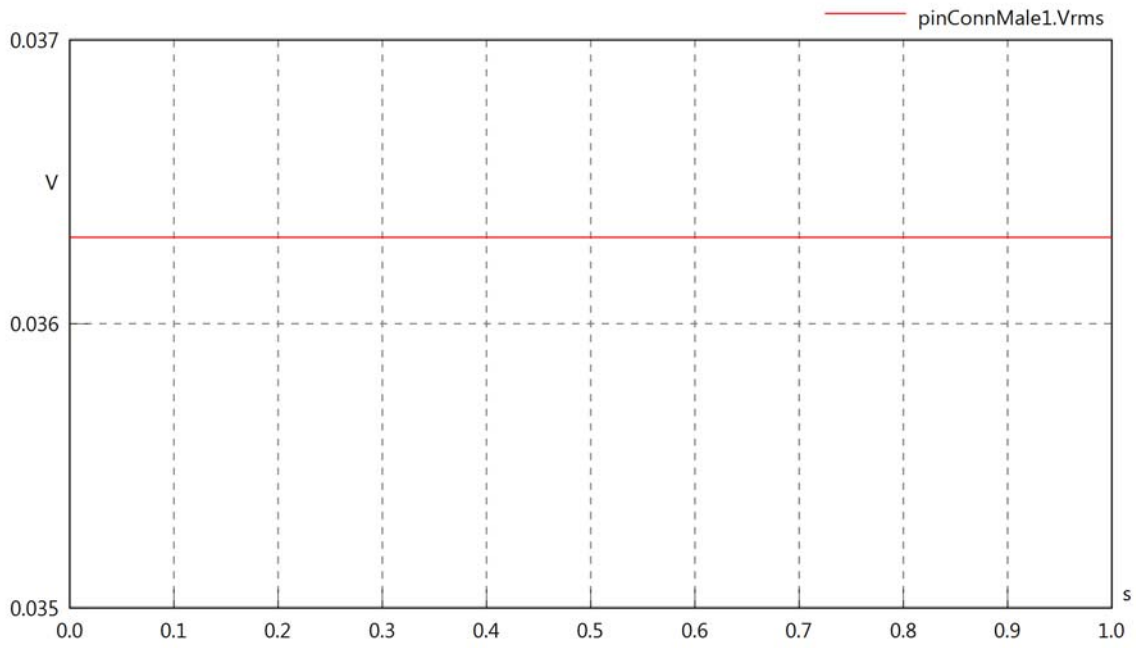

pinConnMale1.vRe

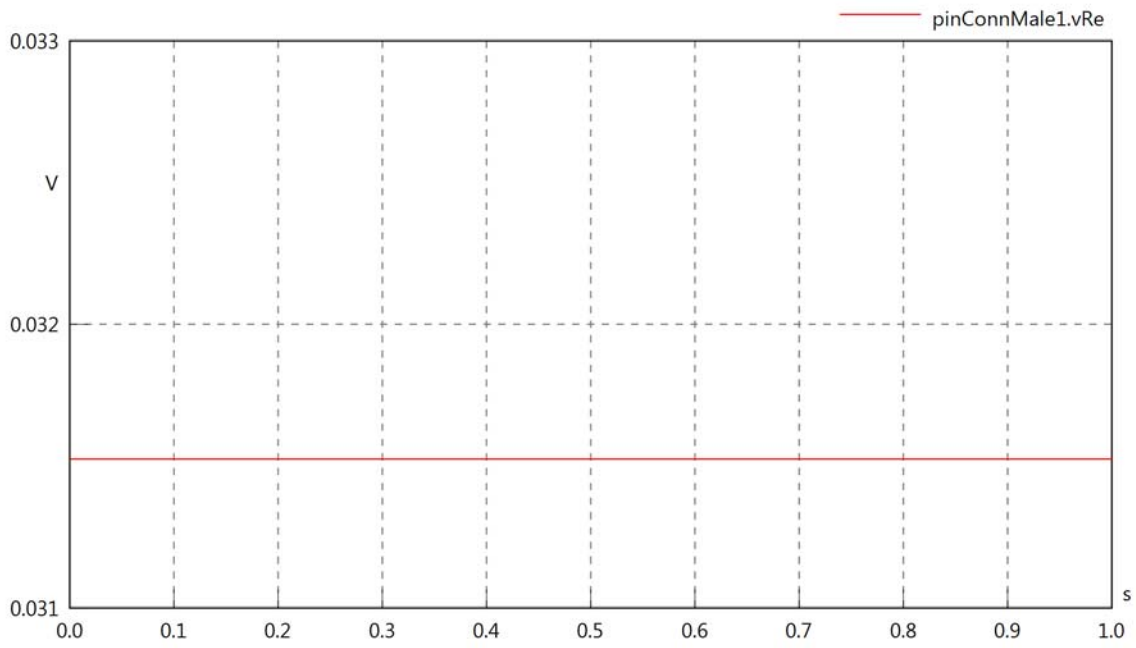

pinConnMale1.vIm

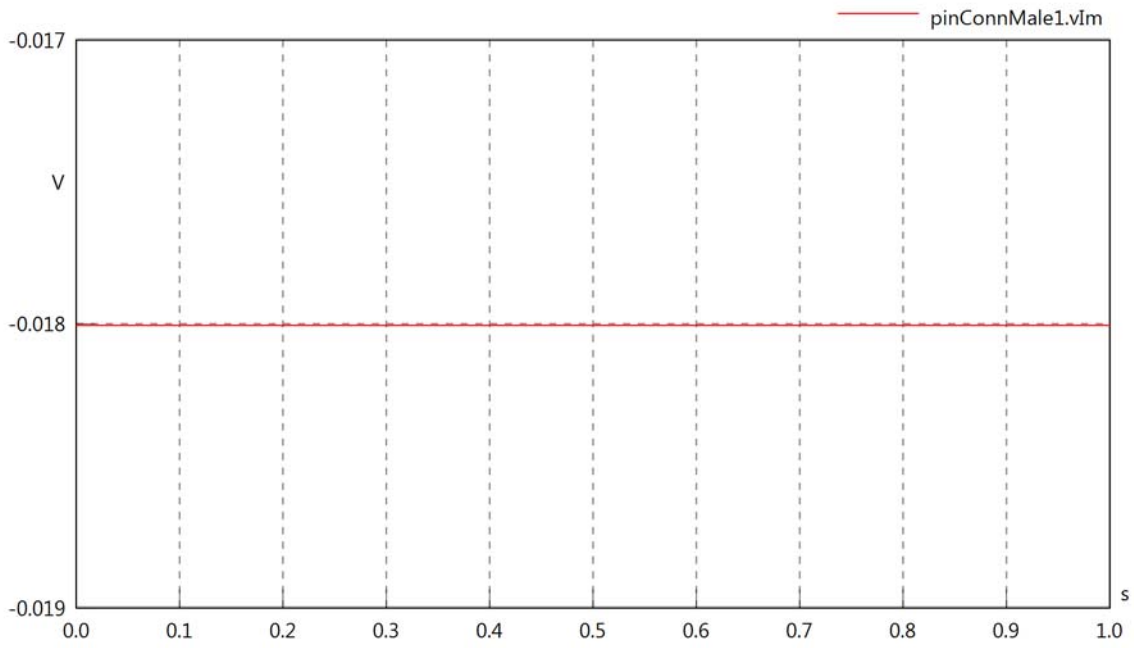

pinConnMale1.IrmsIn

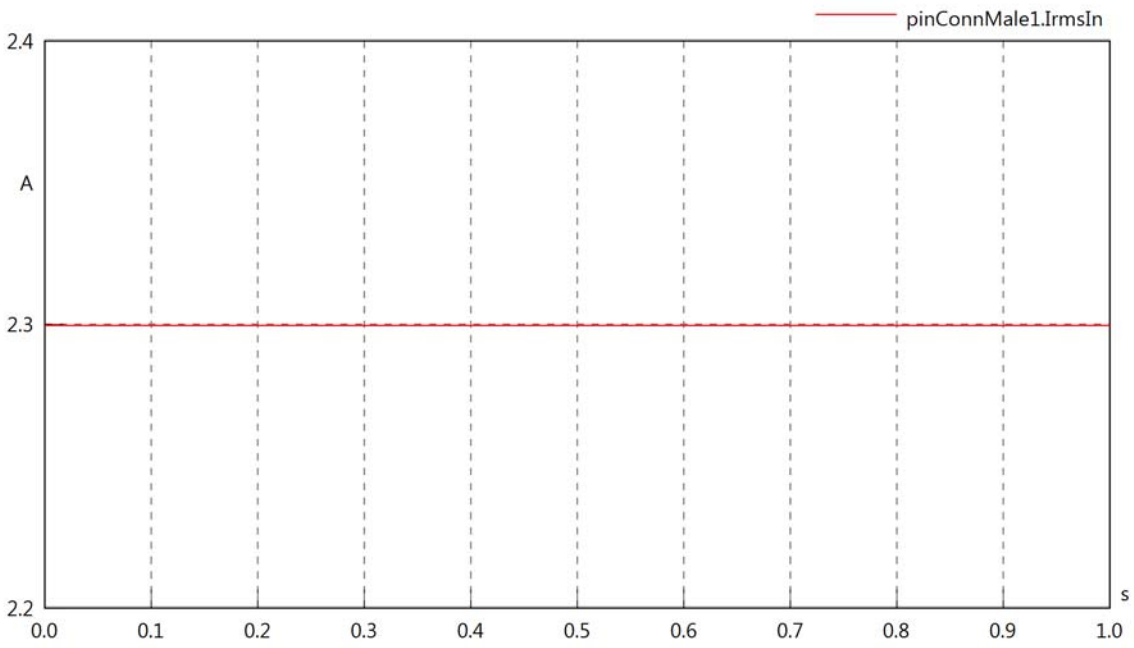

pinConnMale1.iReIn

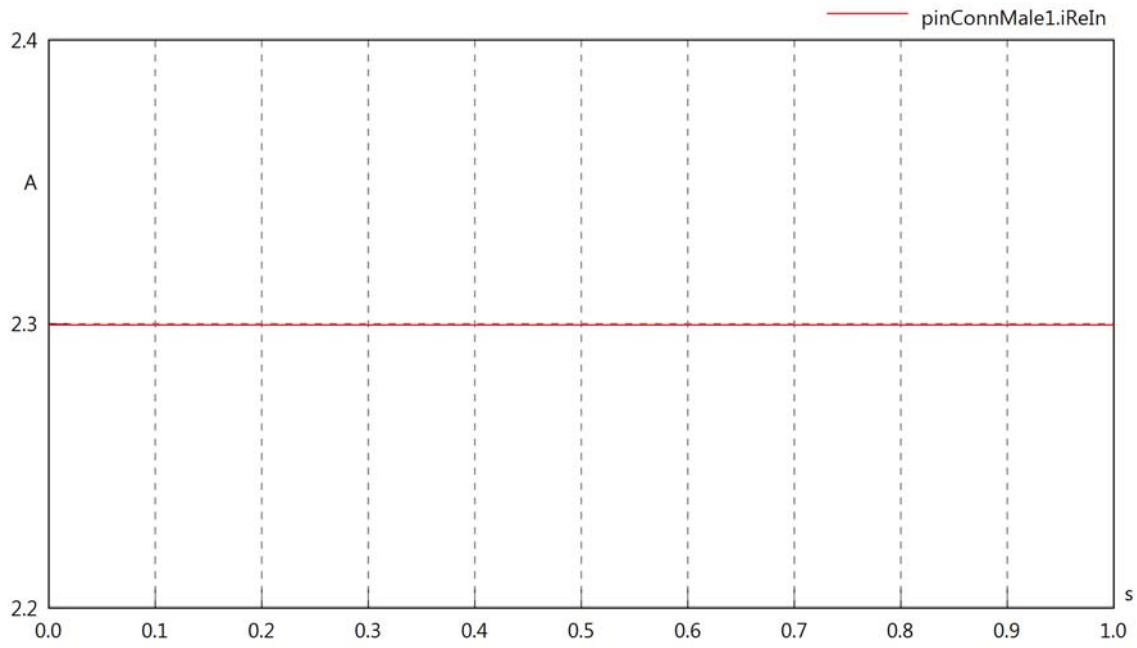

pinConnMale1.iImIn

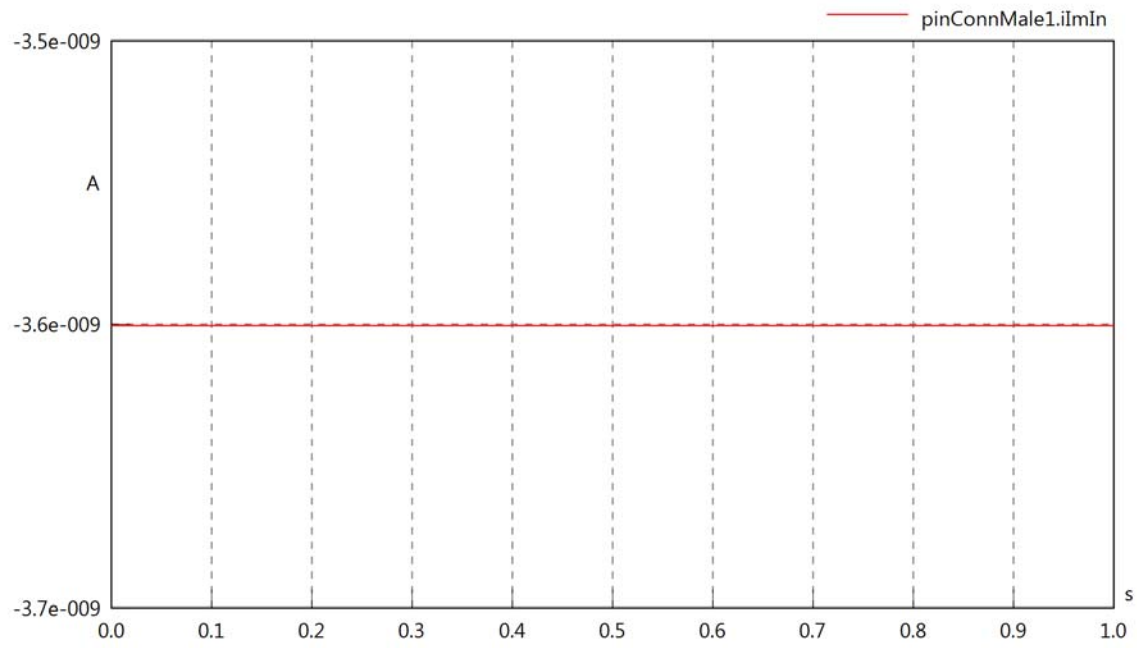

pinConnMale1.IrmsOut

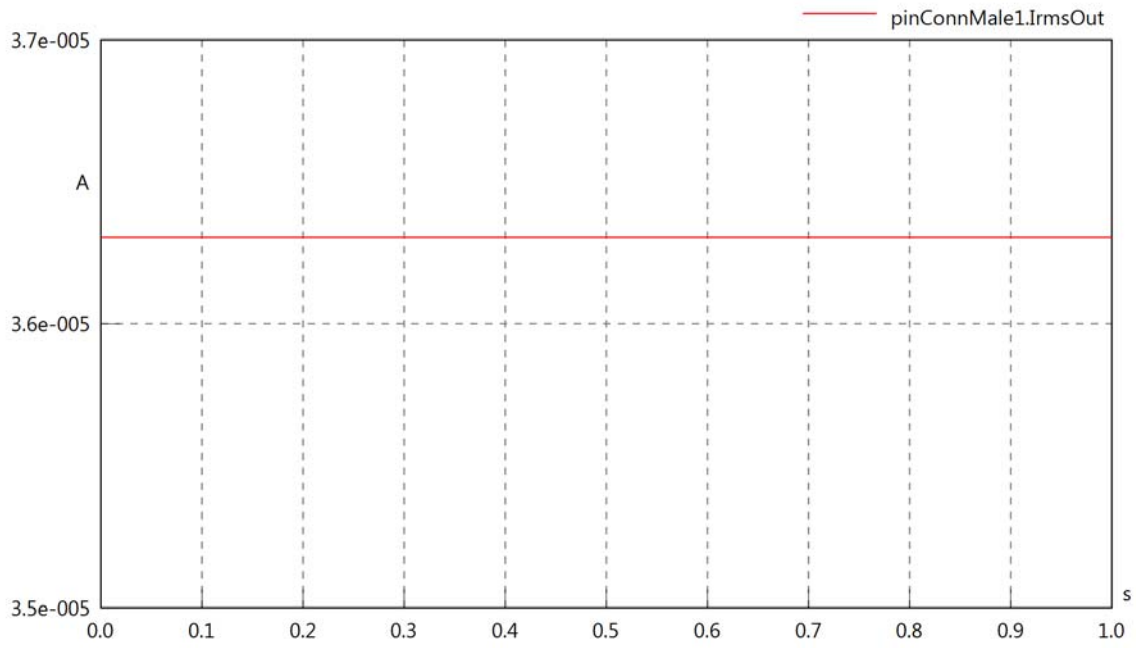

pinConnMale1.iReOut

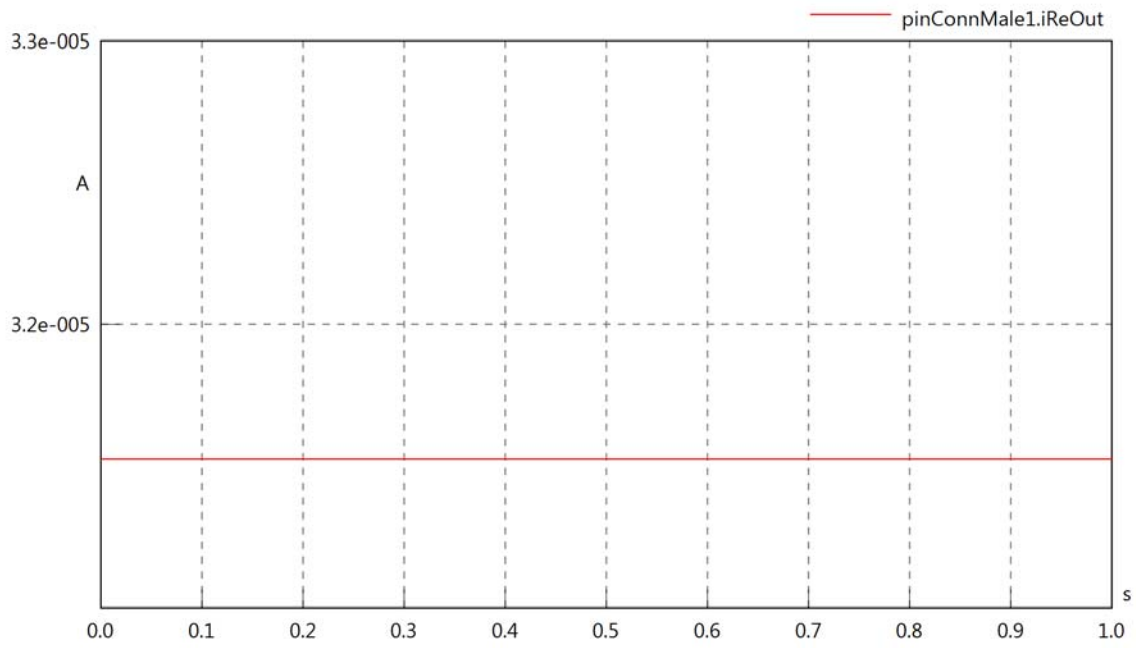

pinConnMale1.iImOut

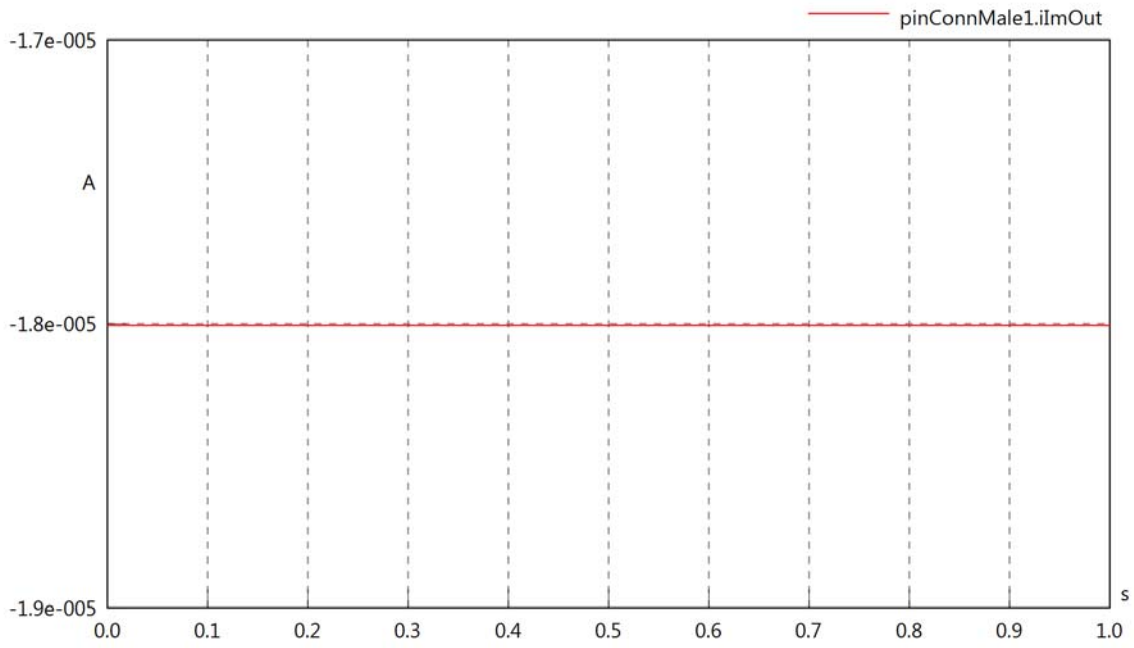

pinConnMale1.phiVIn

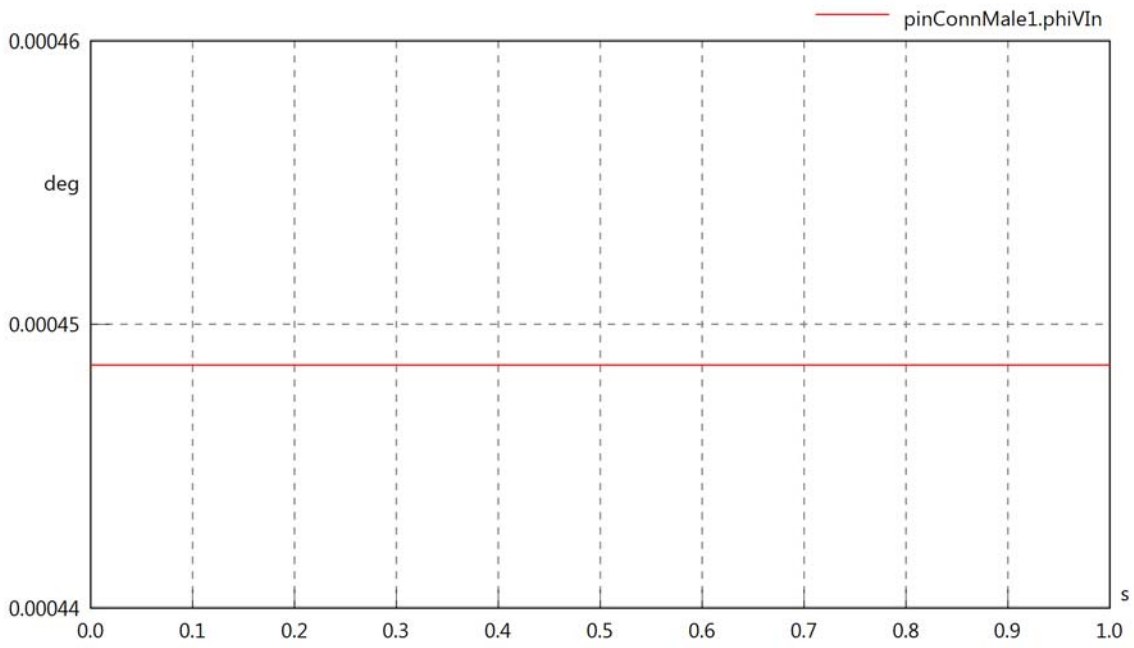

pinConnMale1.phiIIn

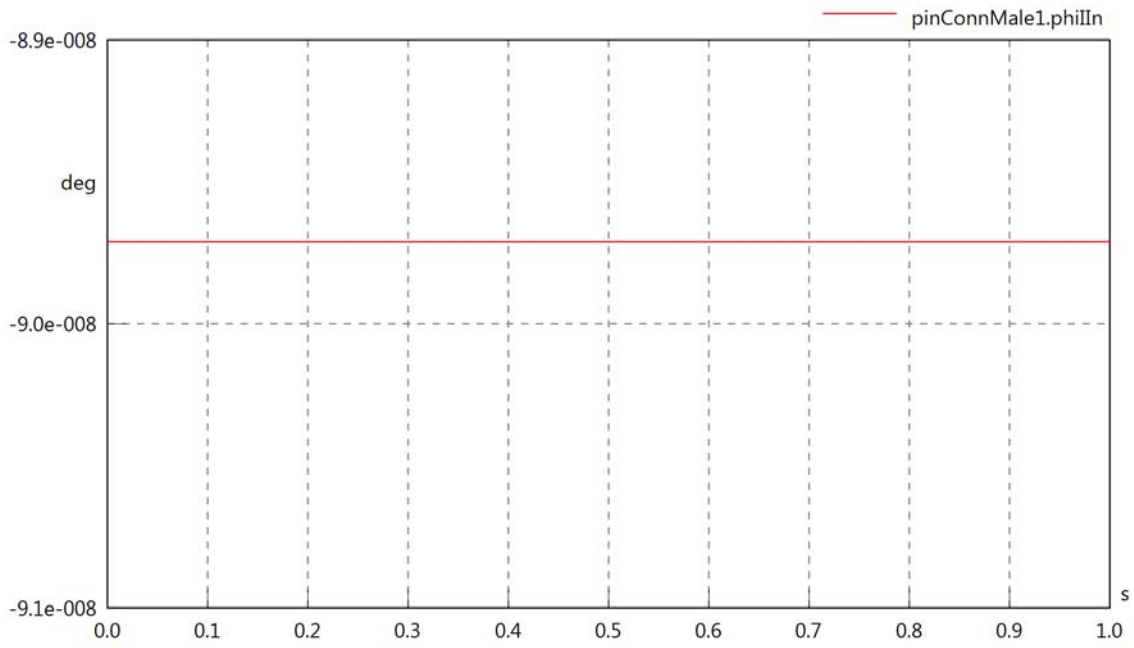

pinConnMale1.phiIVIn

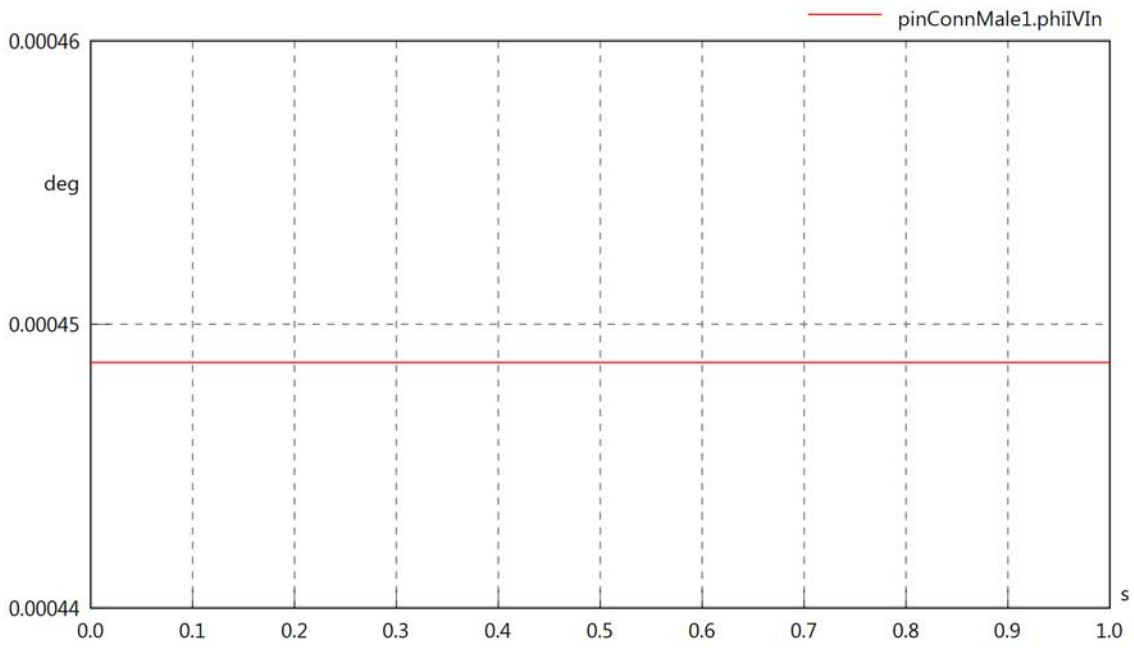

pinConnMale1.phiVOut

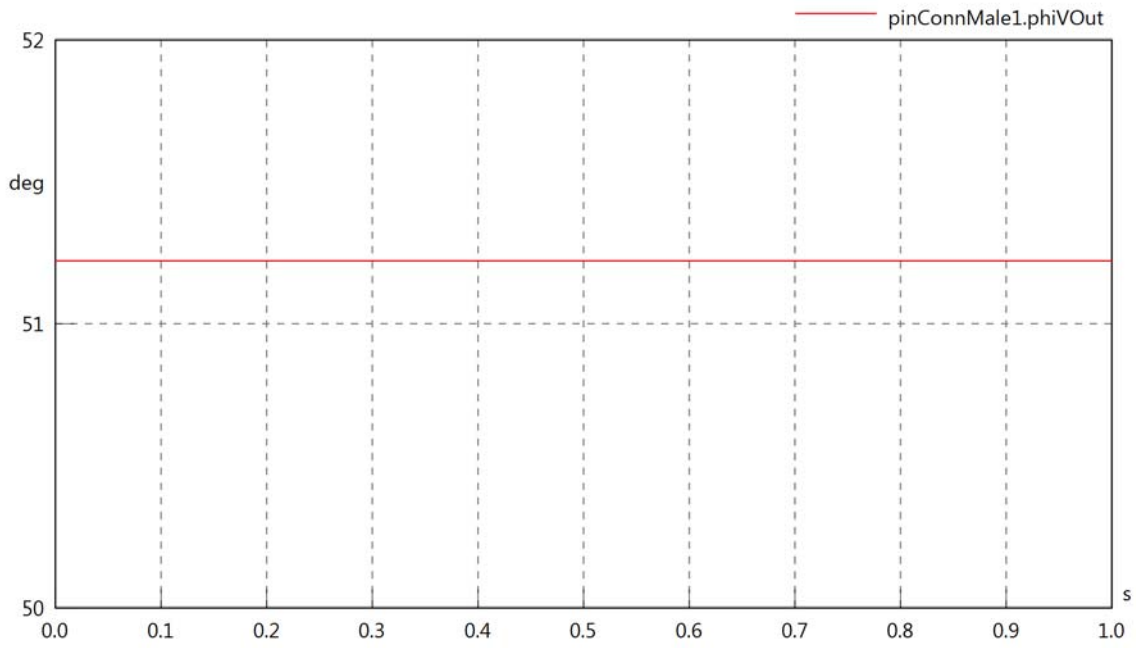

pinConnMale1.phiIOut

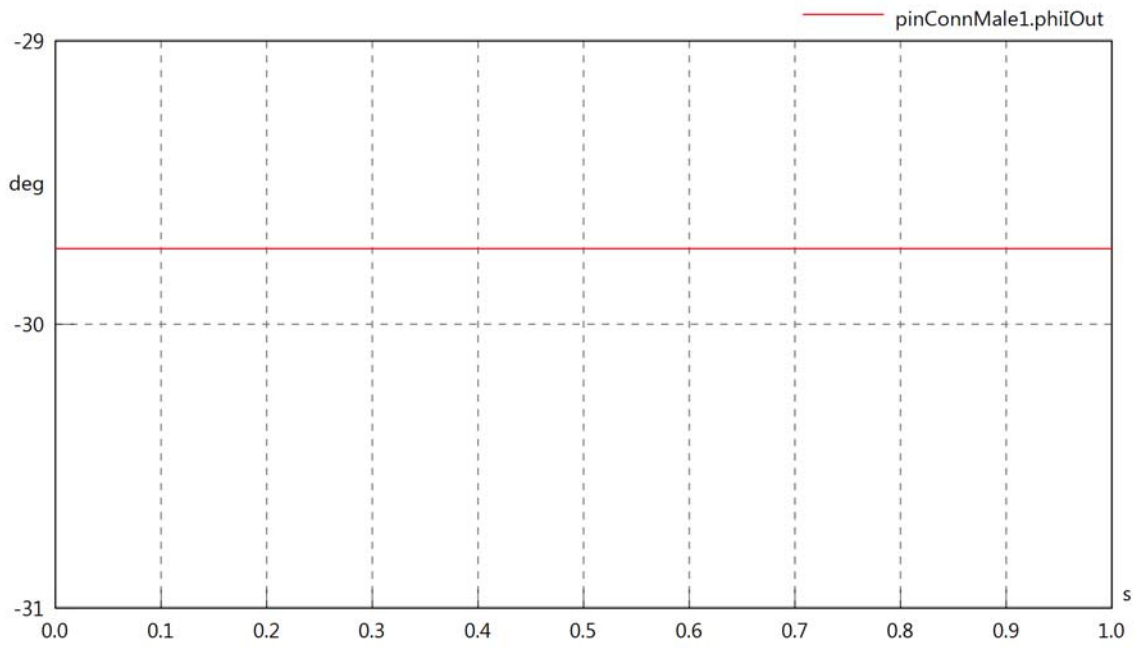

pinConnMale1.phiIVOut

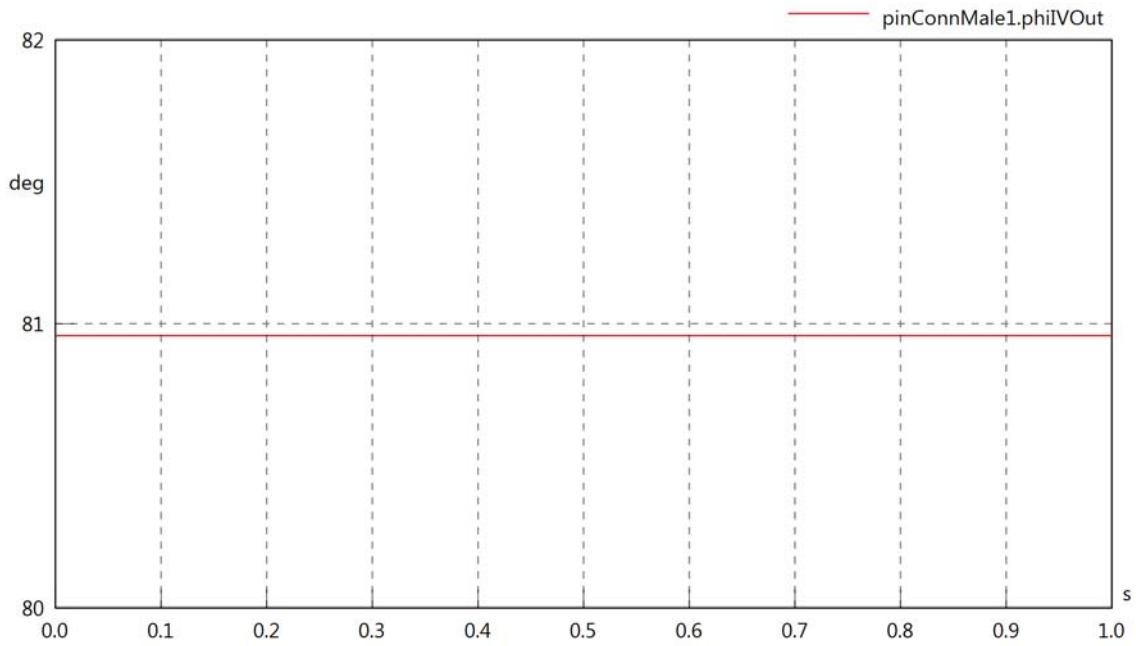

pinConnMale1.PReIn

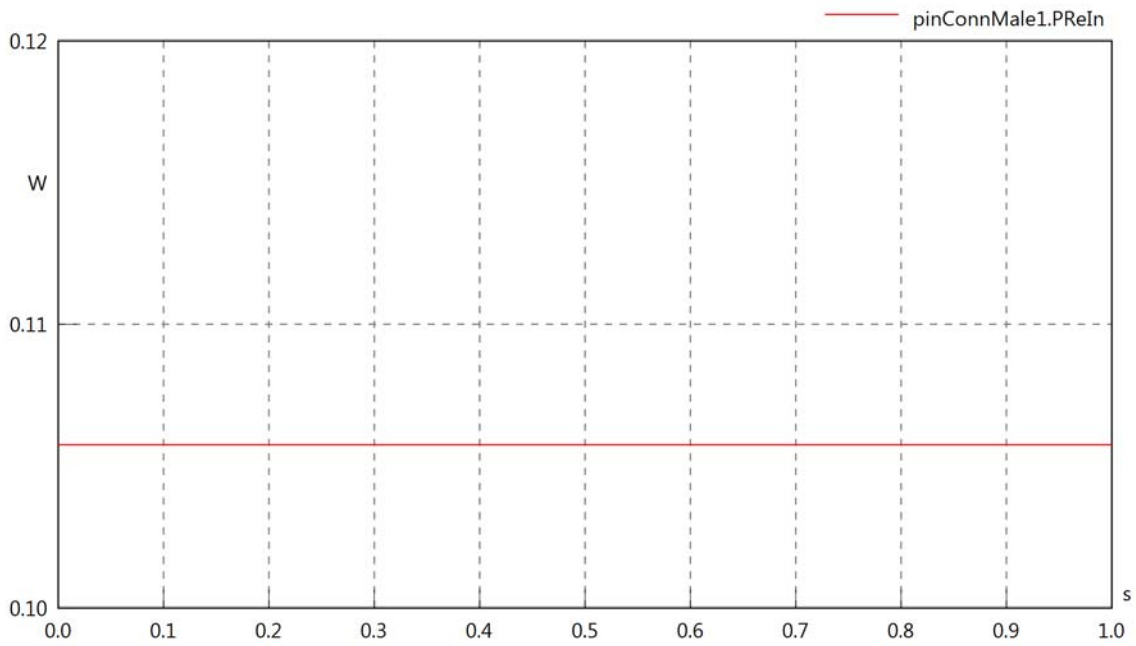

pinConnMale1.PImIn

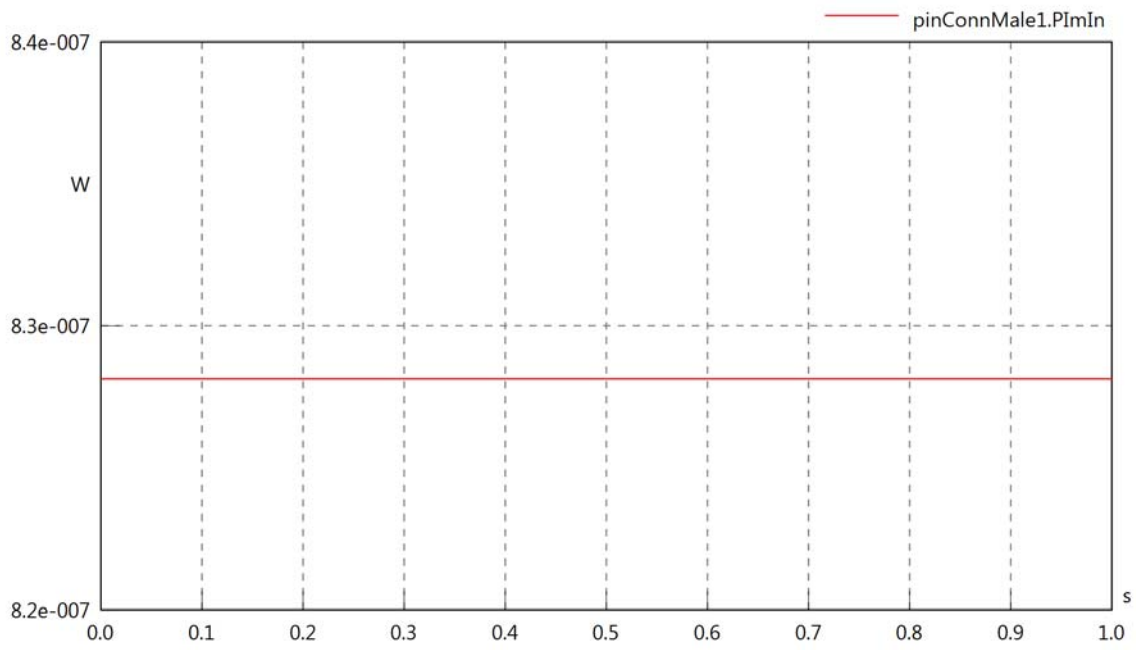

pinConnMale1.SIn

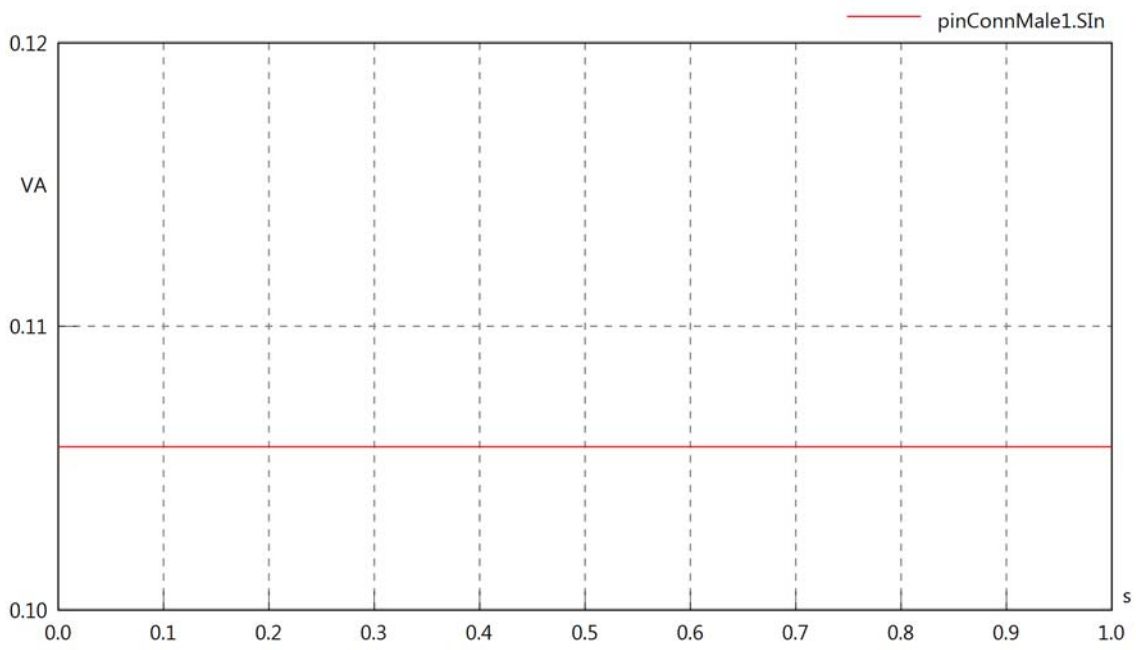

pinConnMale1.PReOut

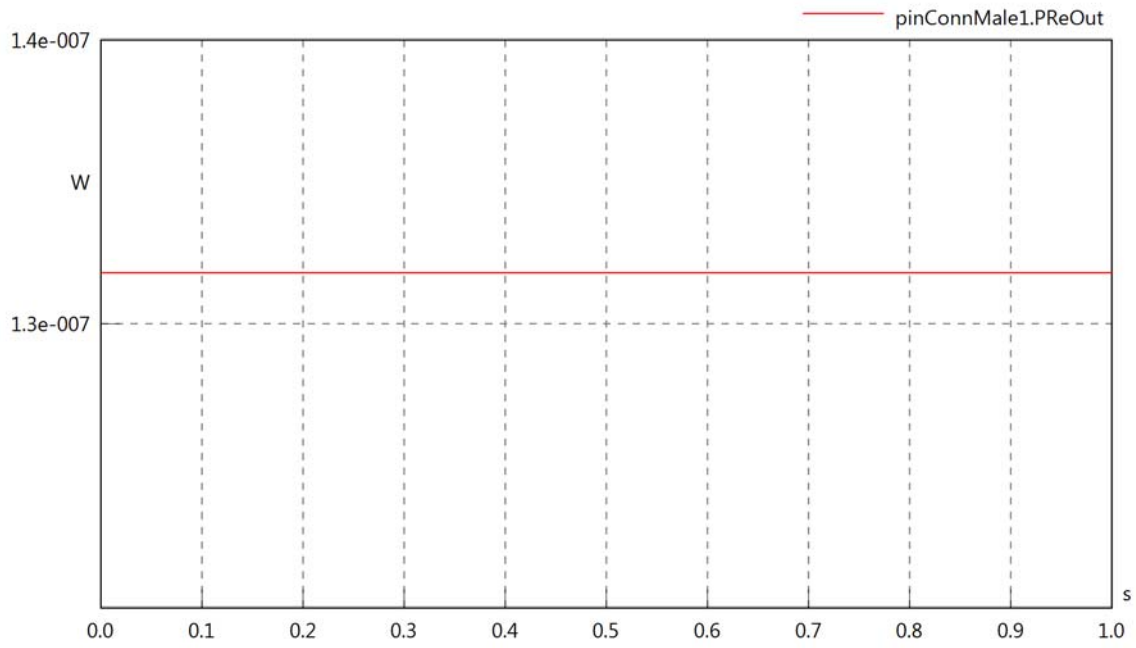

pinConnMale1.PImOut

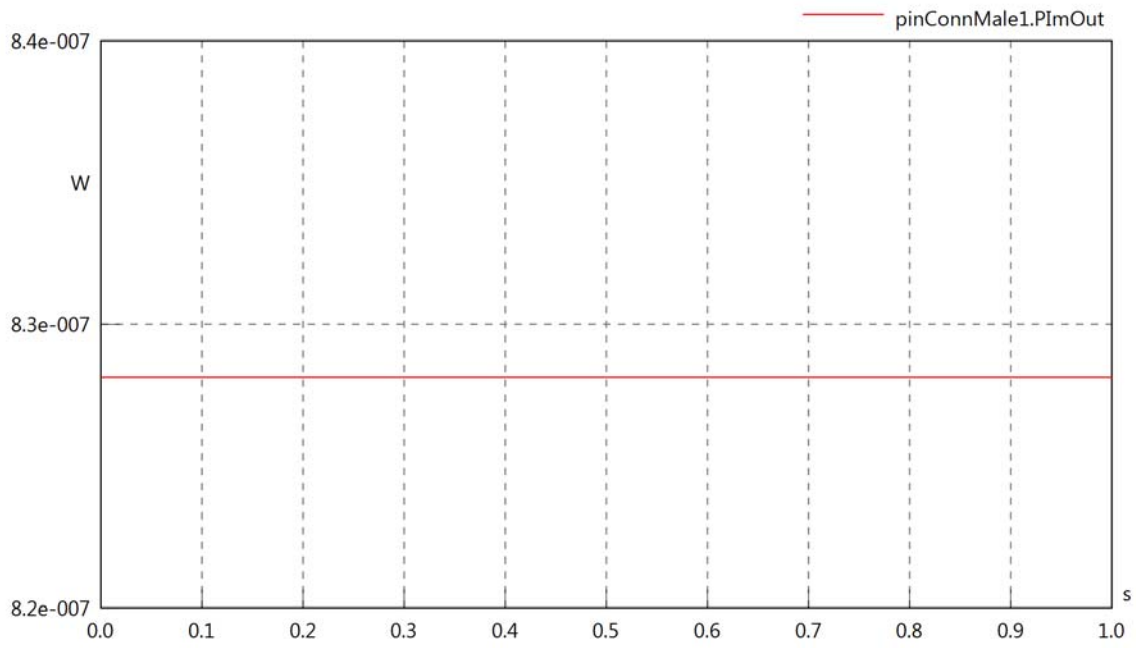

pinConnMale1.SOut

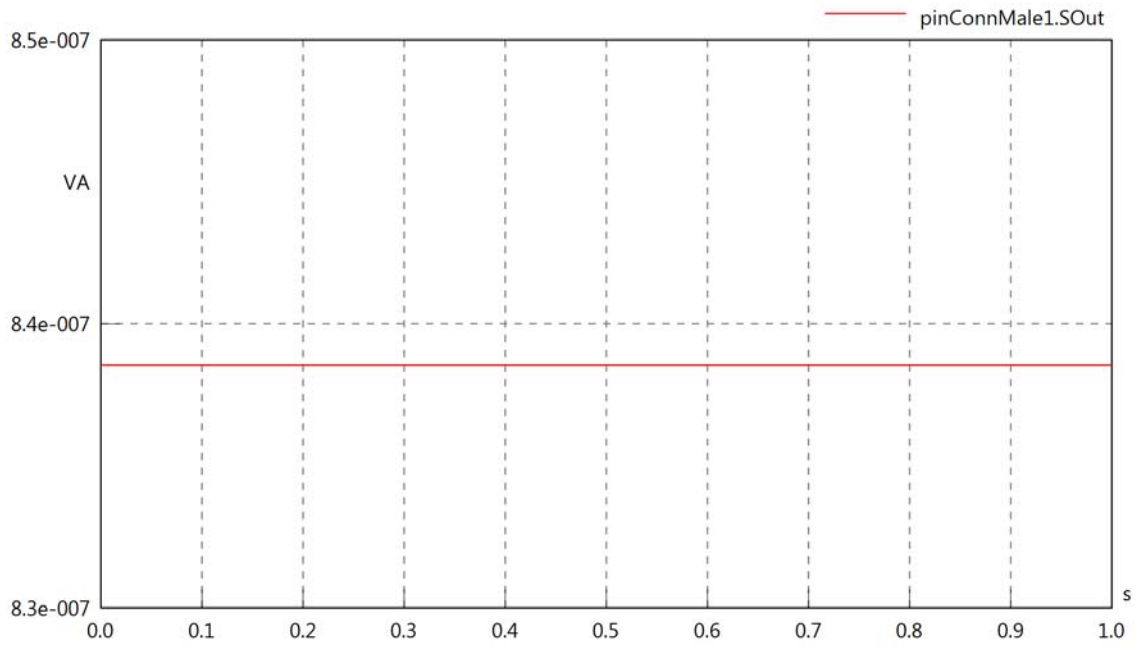
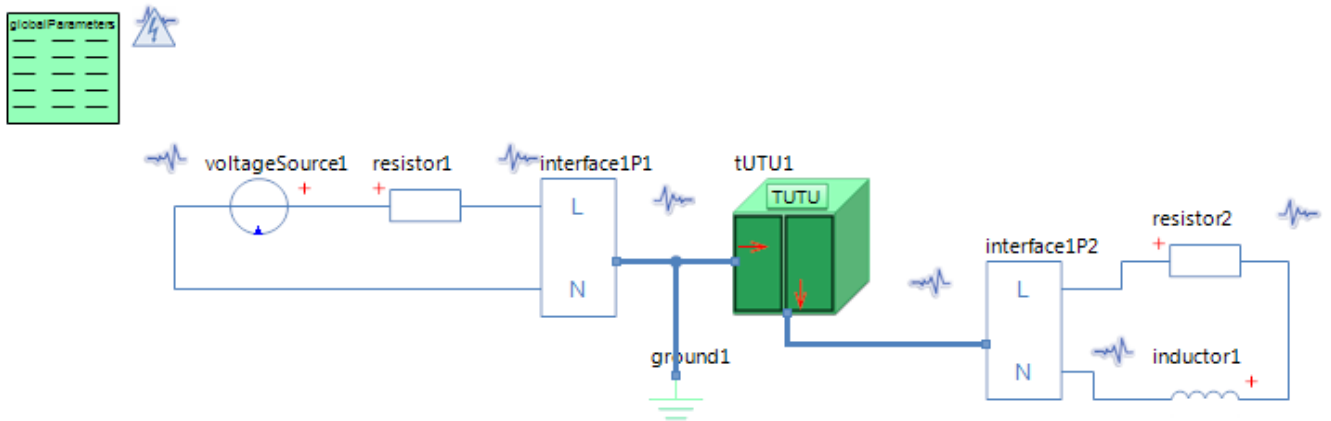

Diagram View



GlobalParameters globalParameters
Parameters

Comment	Name	Current Value	Unit
Type of Calculation	eCalculationKind	Signal Calculation	
Description of Frequency	eFrequencyKind	Linear	
Minimum Frequency	fMin	60	[Hz]
Maximum Frequency	fMax	60	[Hz]

Voltage Source voltageSource1
Parameters

Comment	Name	Current Value	Unit
Voltage RMS	VrmsSrc	230	[V]
Phase	phi	0	[deg]

Resistor resistor1
Parameters

Comment	Name	Current Value	Unit
Resistance	R	100	[Ohm]

Resistor resistor2
Parameters

Comment	Name	Current Value	Unit
Resistance	R	100	[Ohm]

Inductor inductor1
Parameters

Comment	Name	Current Value	Unit
Inductance	L	5	[mH]

Topside Umbilical Termination Unit tUTU1
Parameters

Comment	Name	Current Value	Unit
Poor or failing L1 connection	bL1	false	

tUTU1.VrmsIn

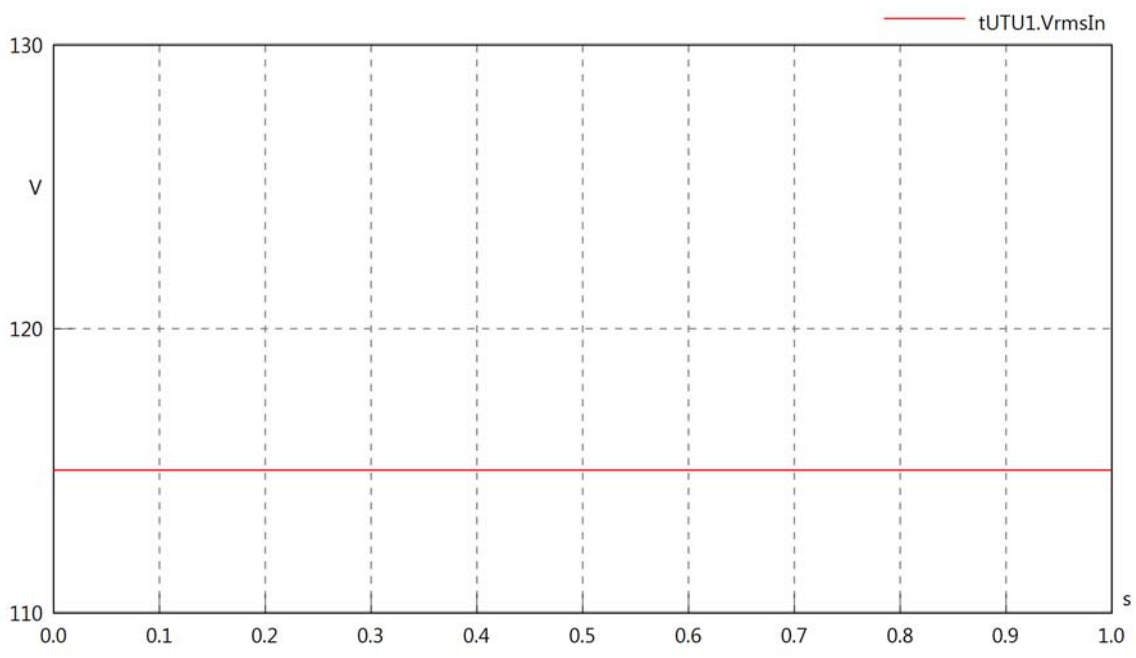

tUTU1.vReIn

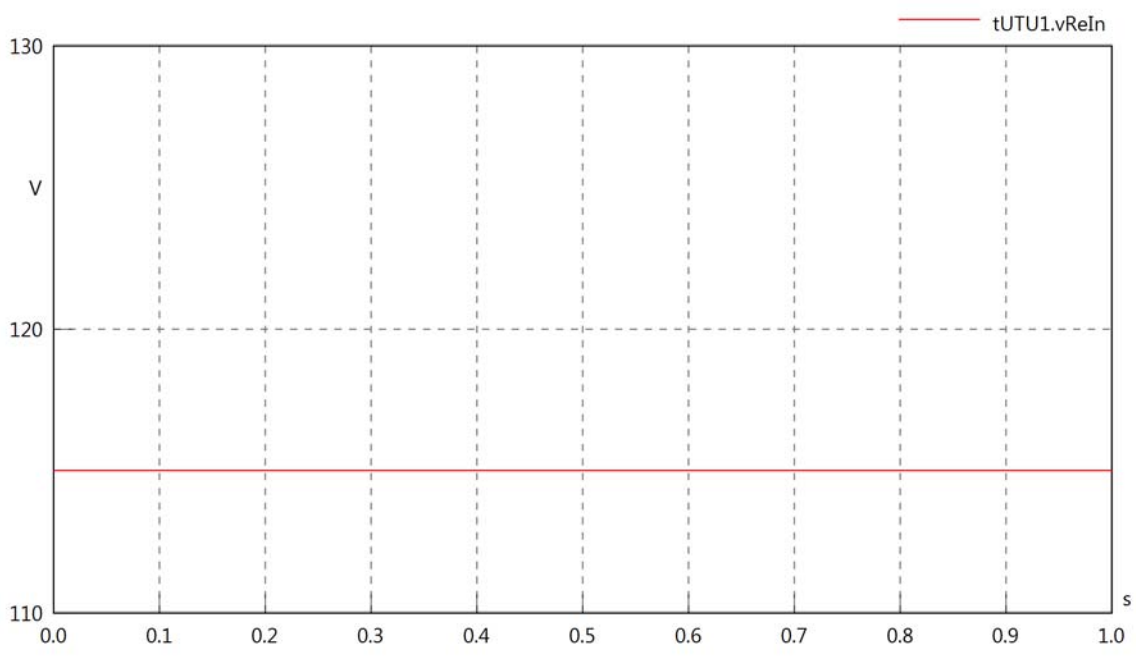

tUTU1.vImIn

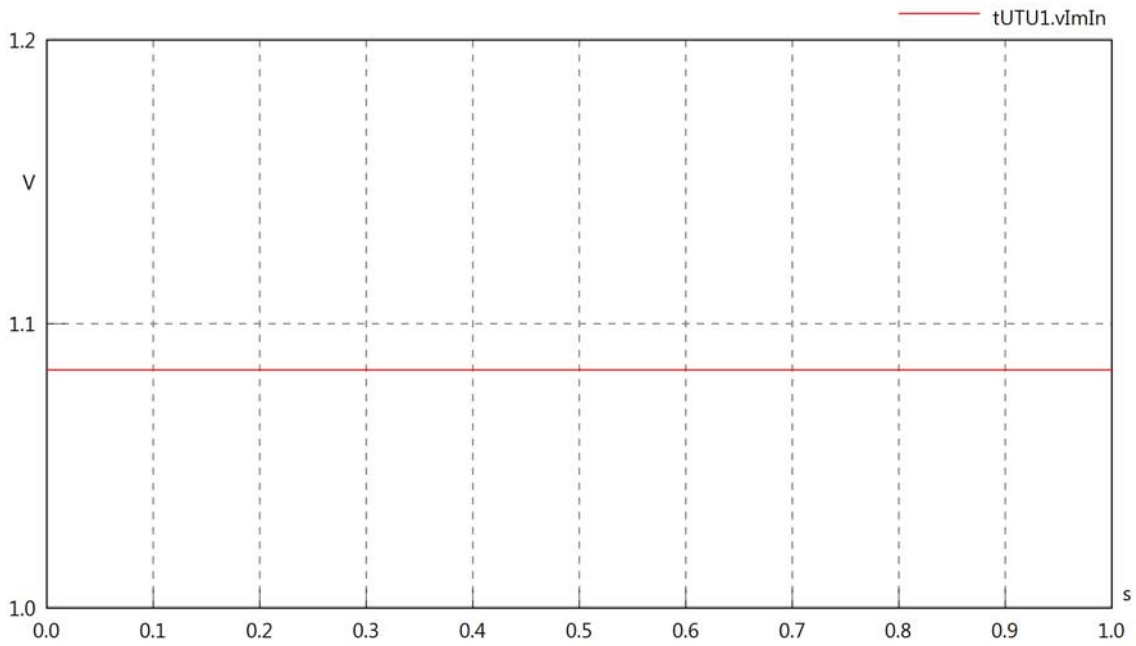

tUTU1.VrmsOut

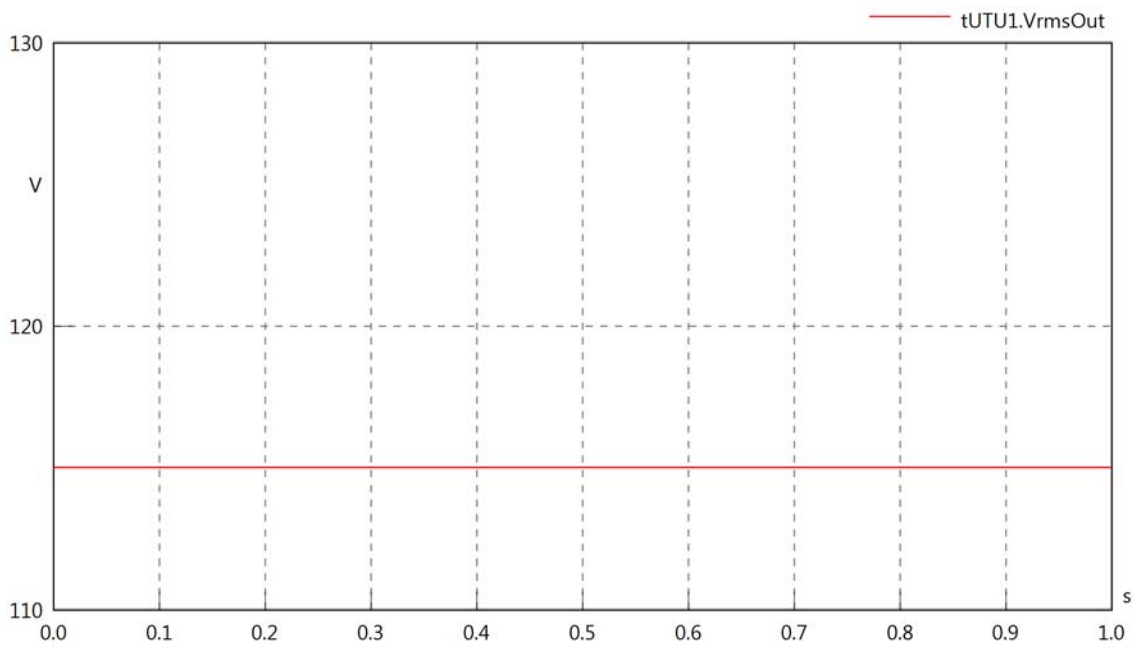

tUTU1.vReOut

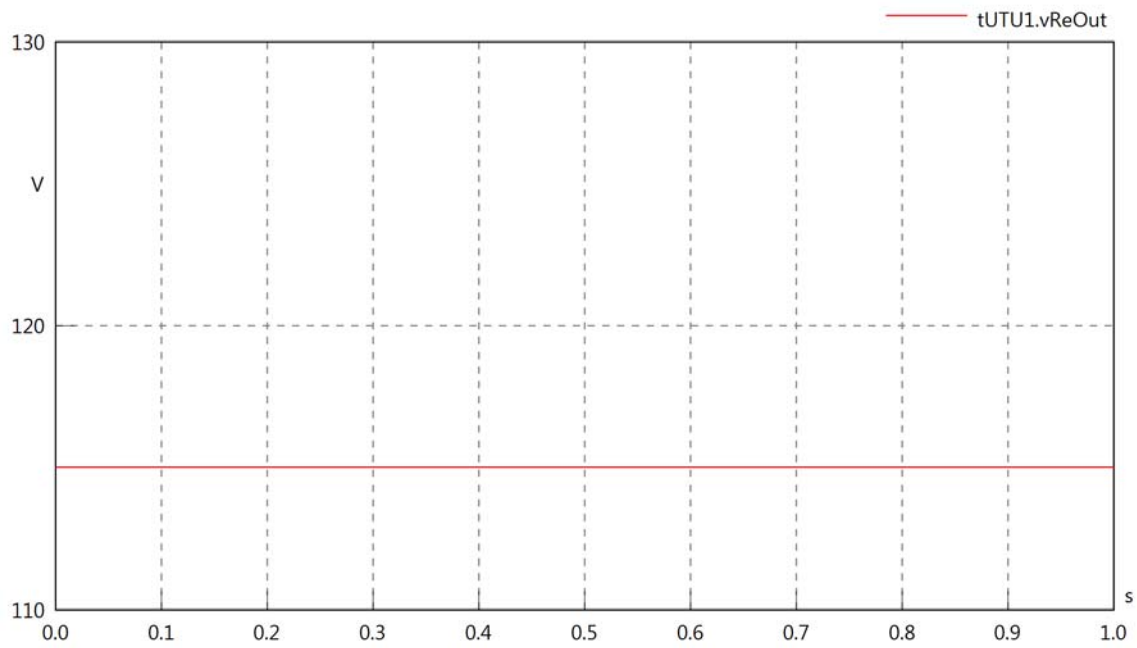

tUTU1.vImOut

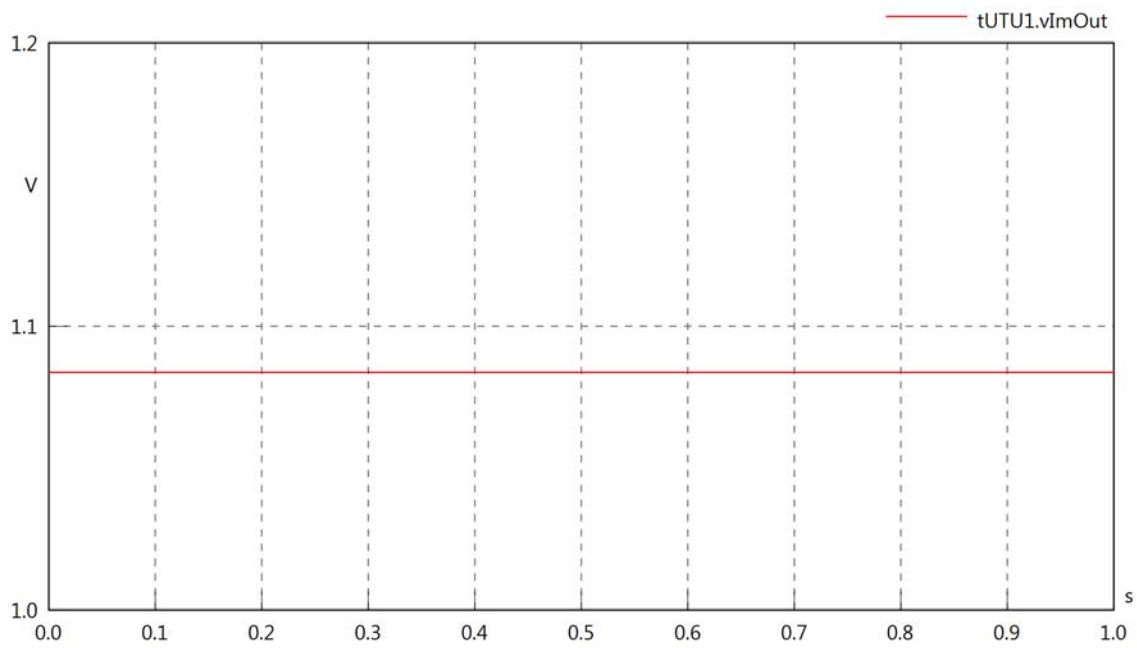

tUTU1.Vrms

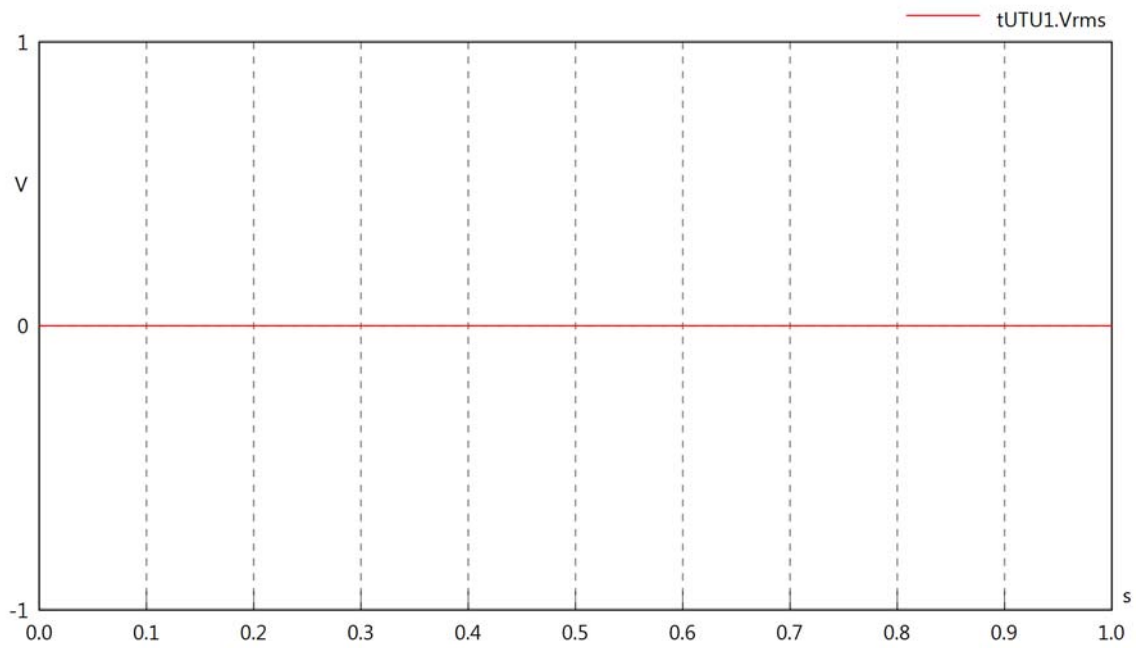

tUTU1.vRe

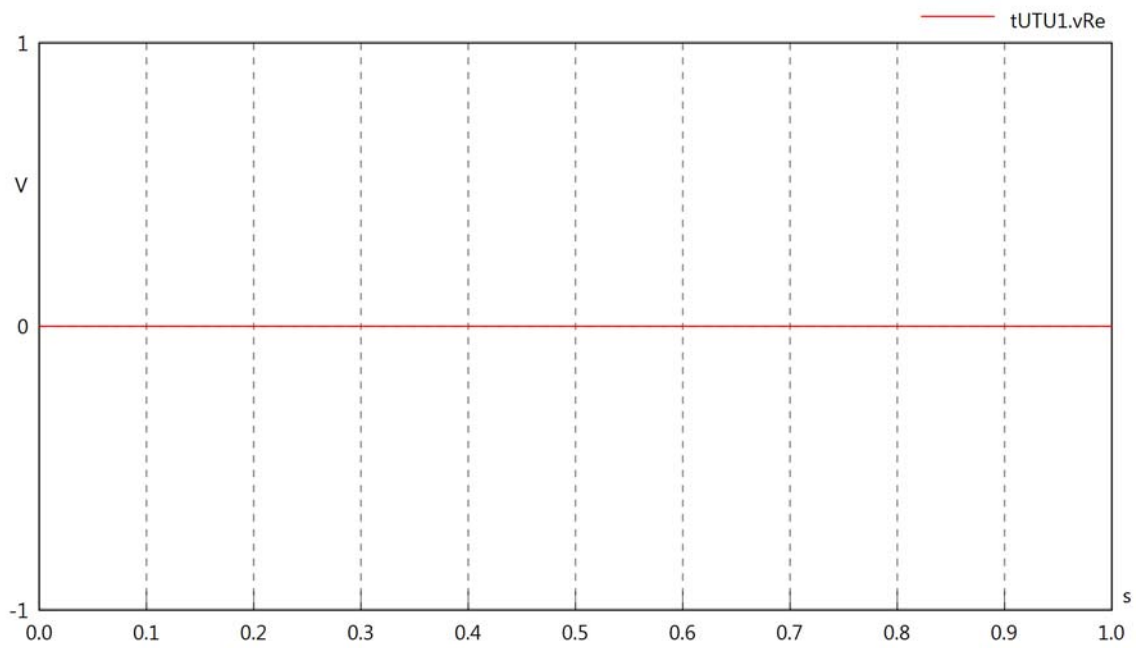

tUTU1.vIm

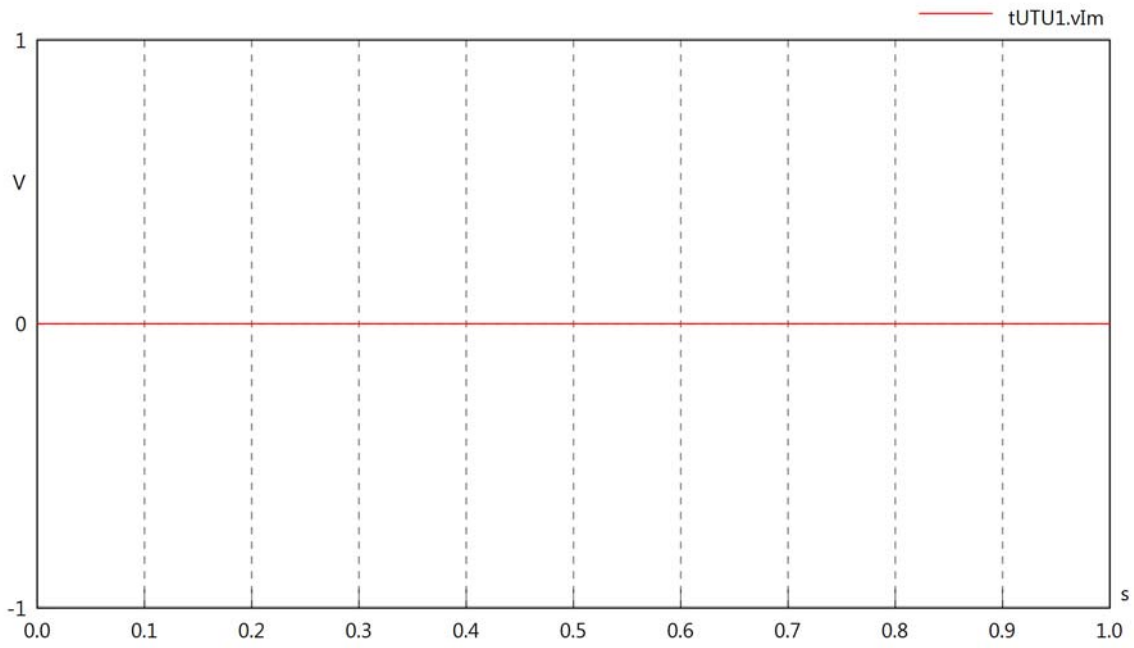

tUTU1.IrmsIn

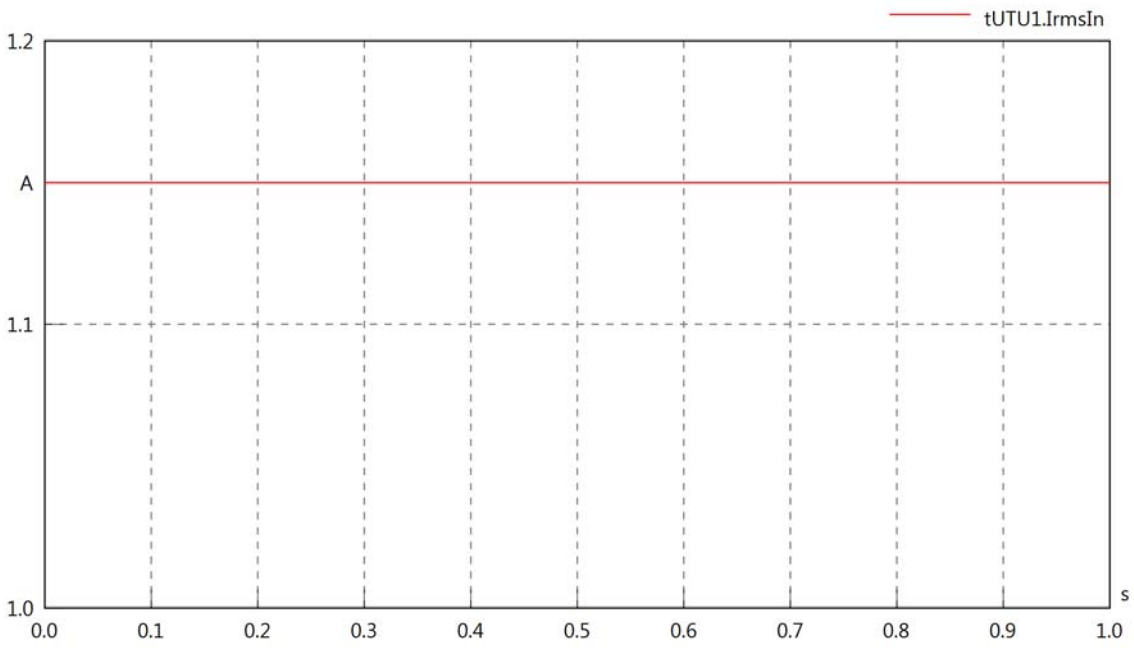

tUTU1.iReIn

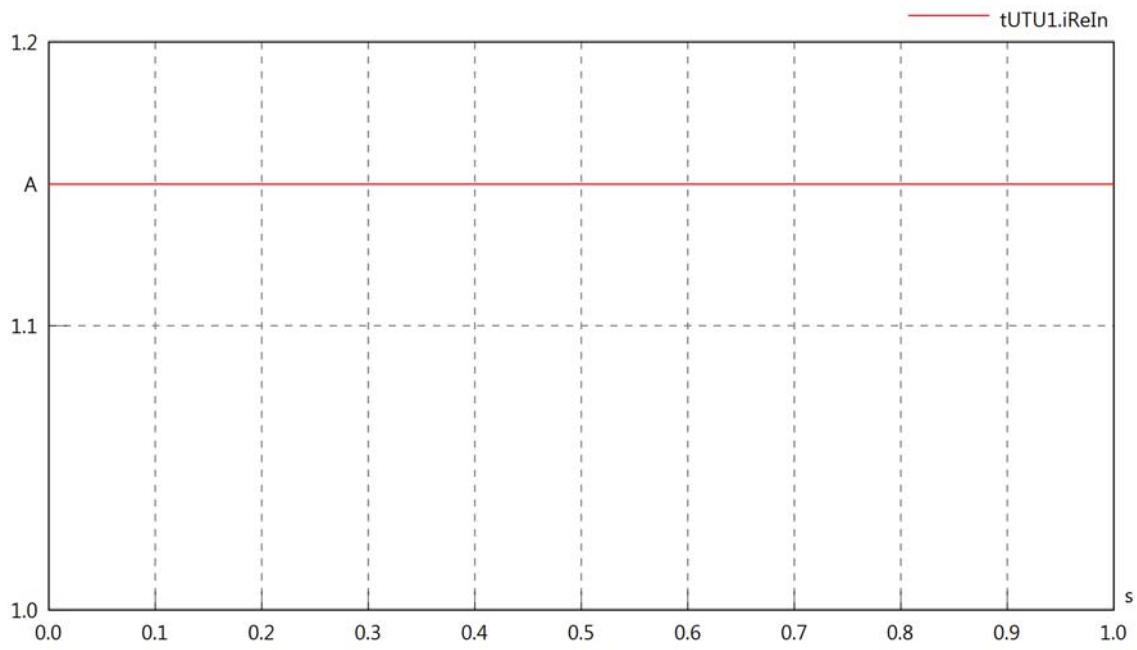

tUTU1.iImIn

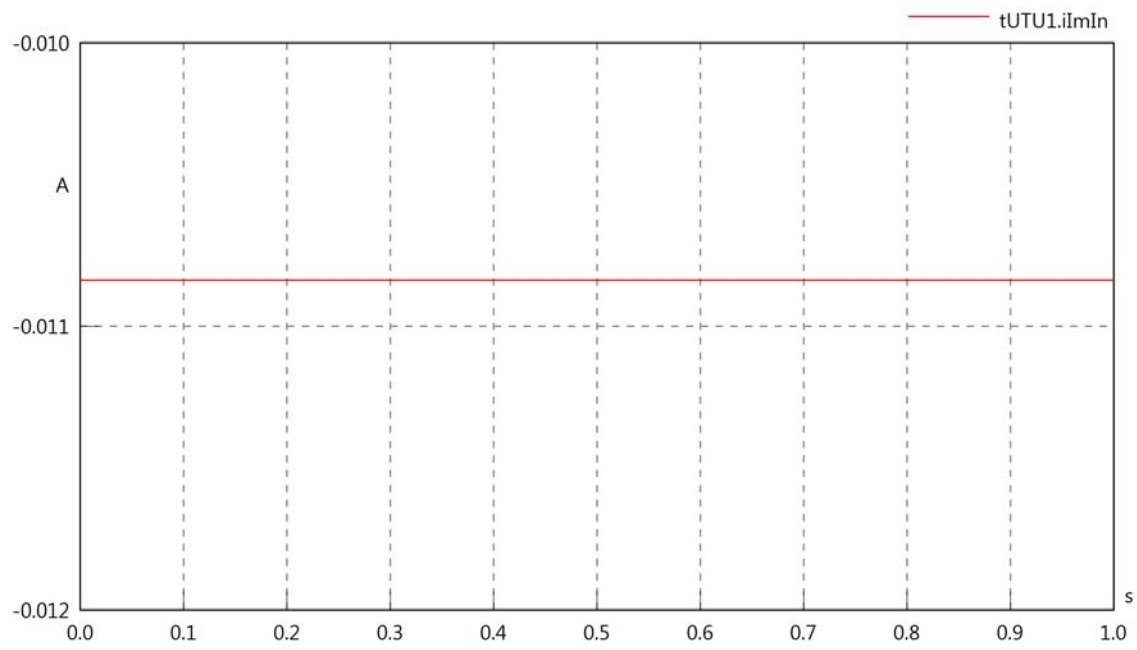

tUTU1.IrmsOut

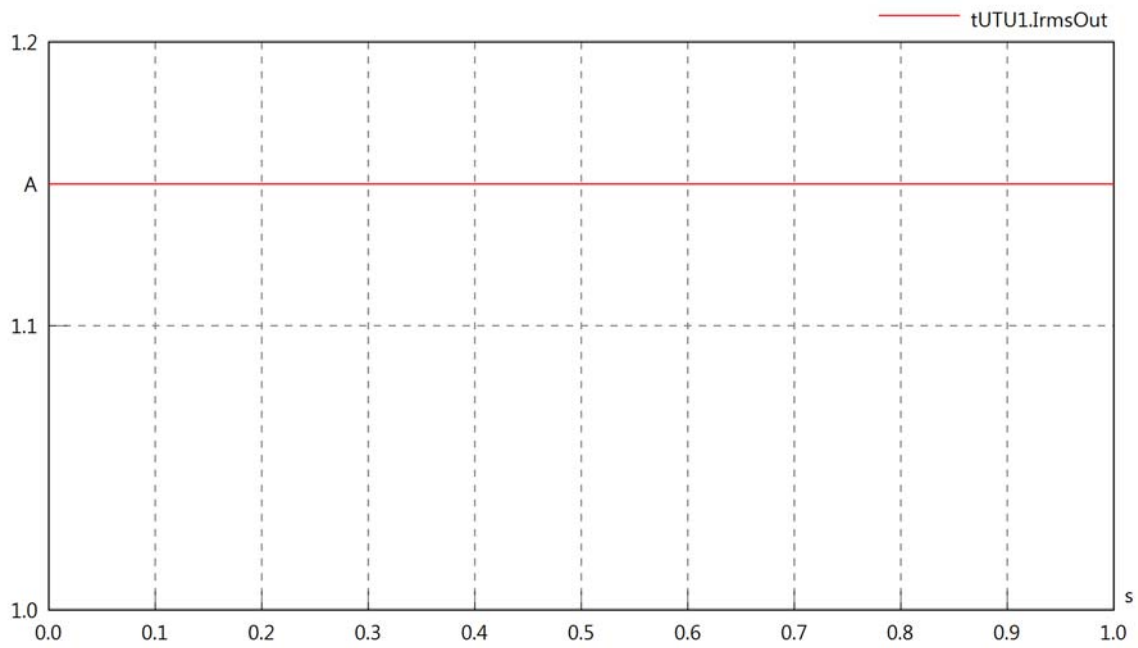

tUTU1.iReOut

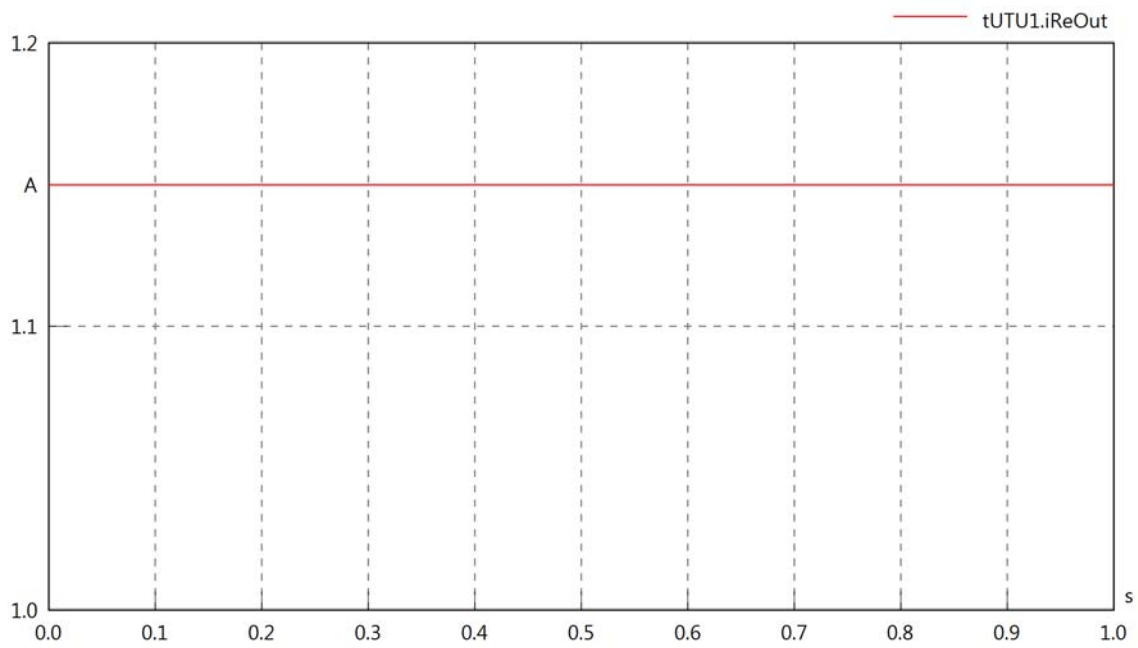

tUTU1.iImOut

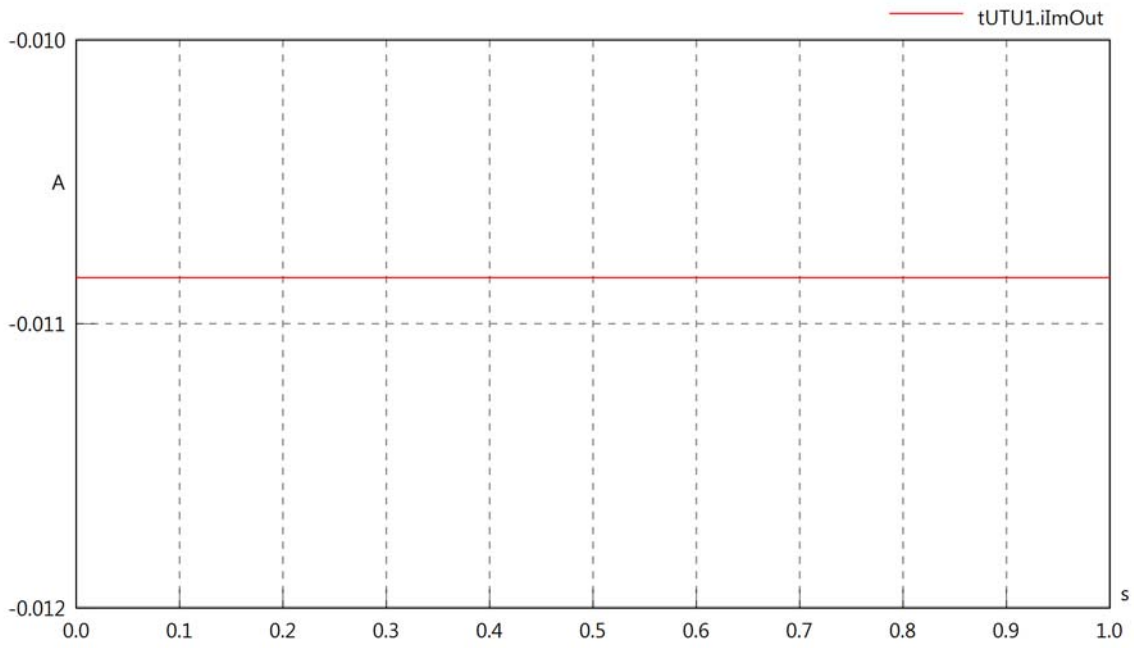

tUTU1.phiVIn

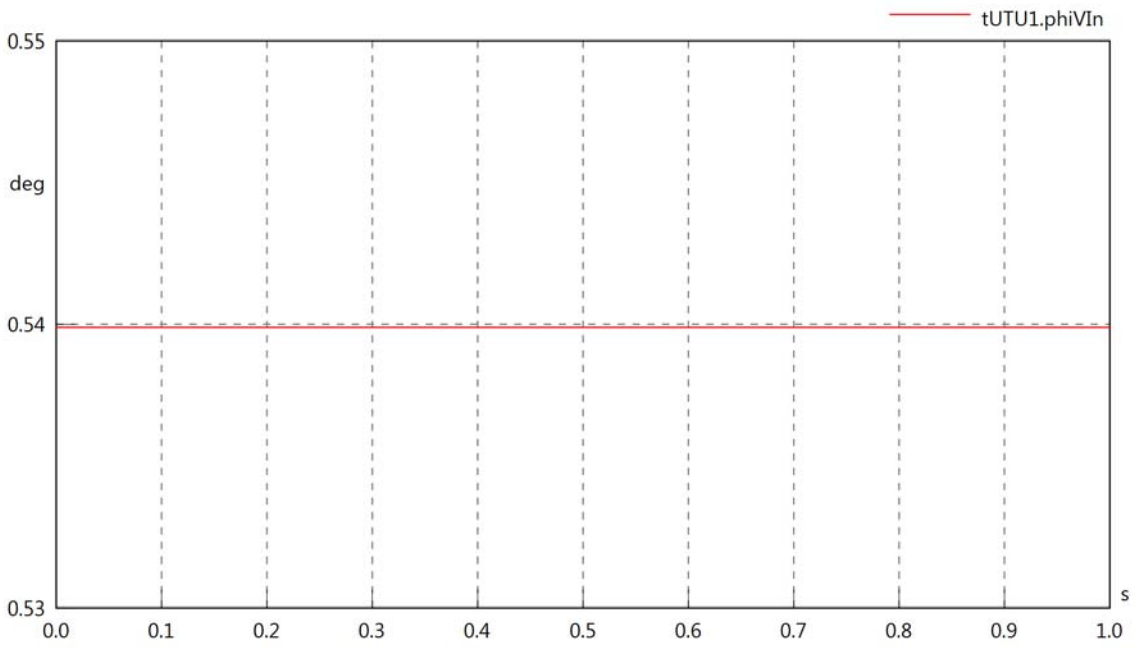

tUTU1.phiIIIn

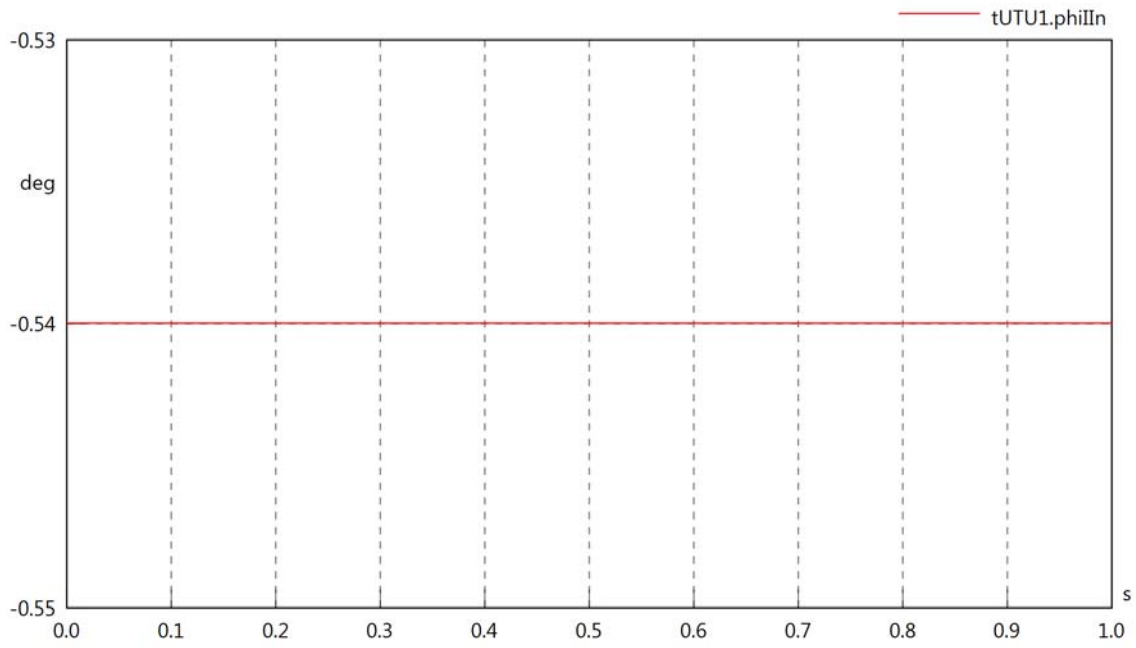

tUTU1.phiIVIn

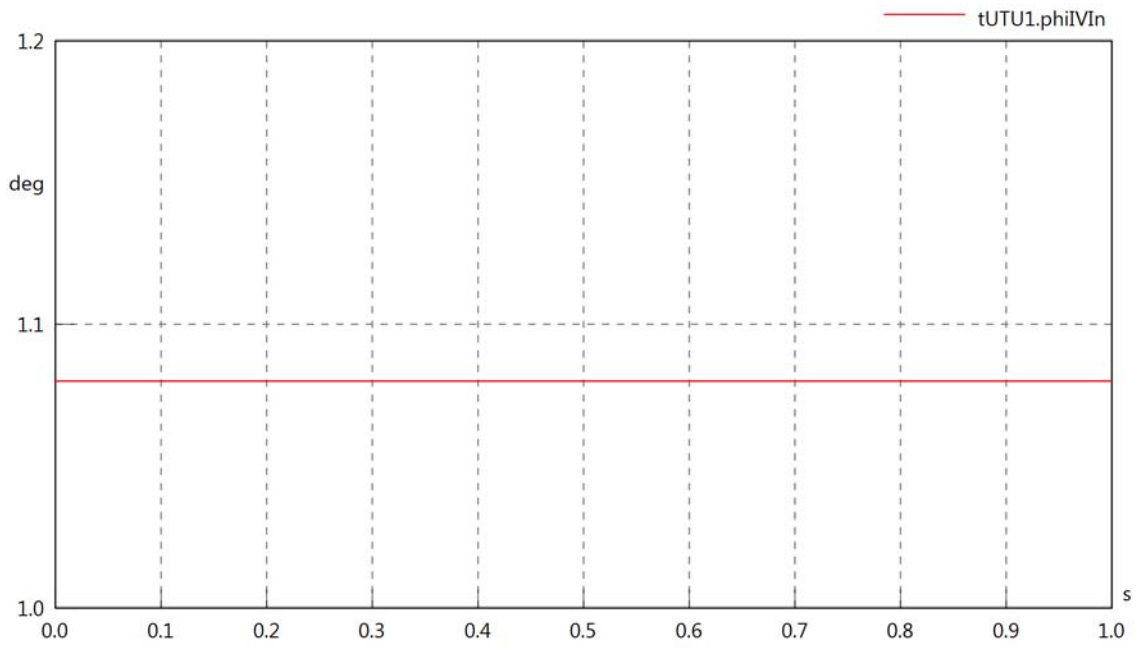

tUTU1.phiVOut

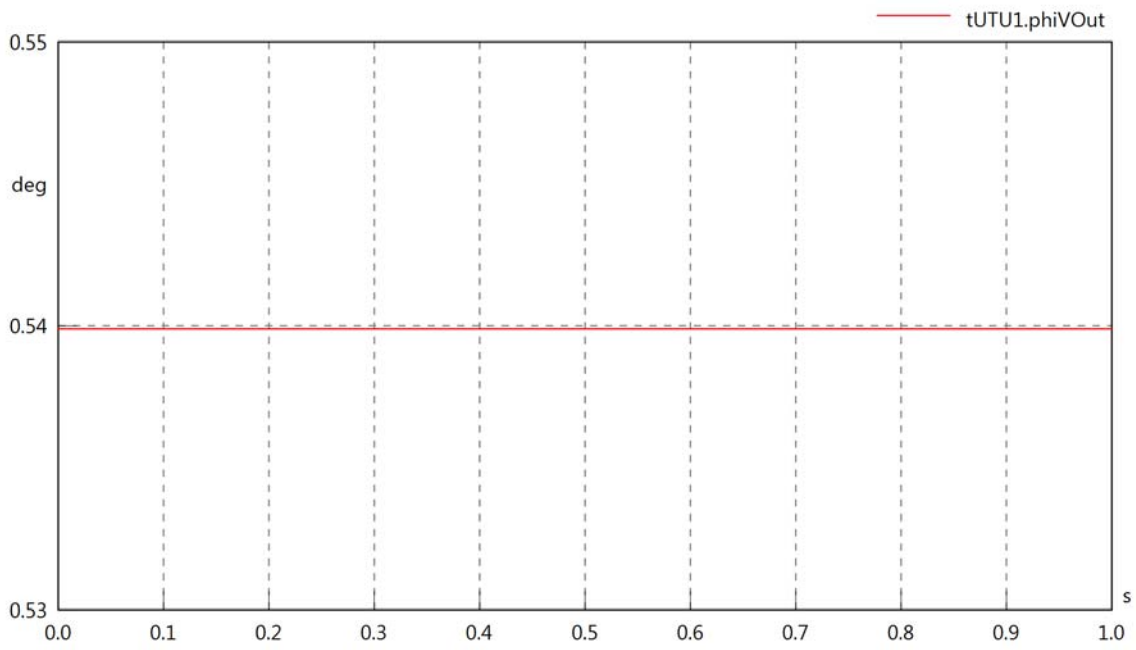

tUTU1.phiIOut

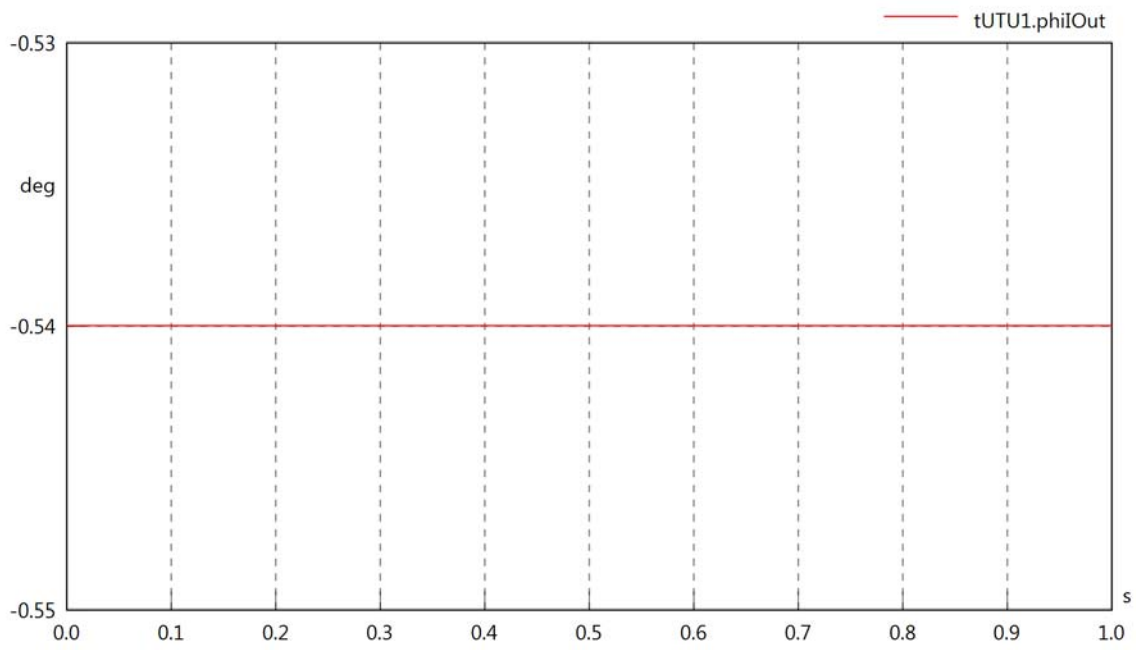

tUTU1.phiIVOut

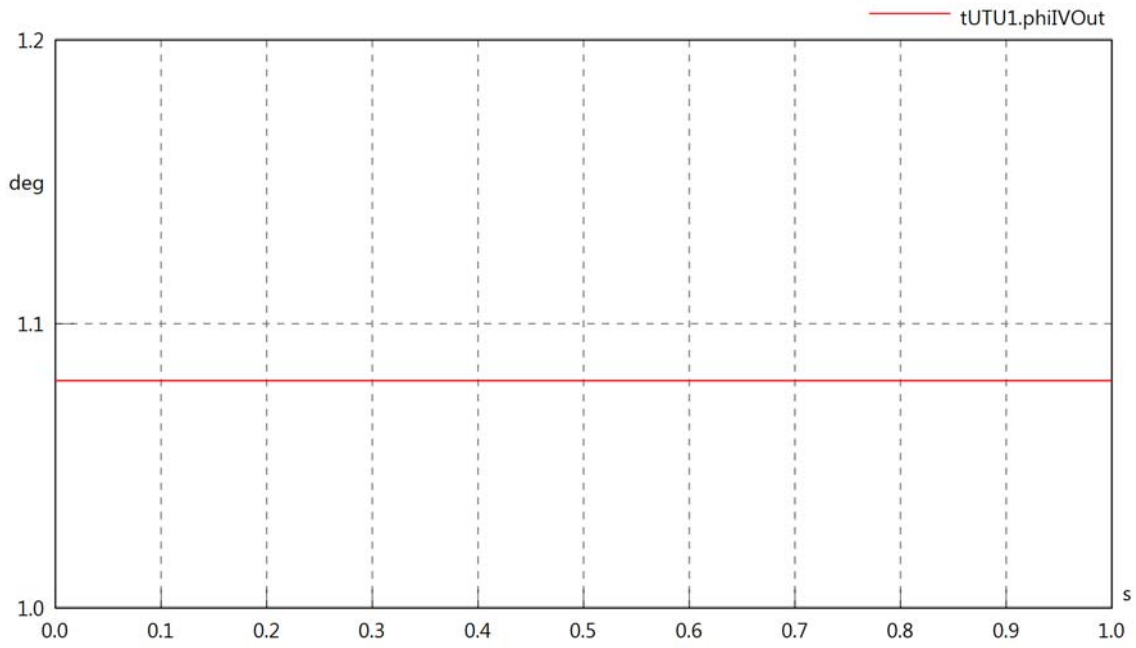

tUTU1.PReIn

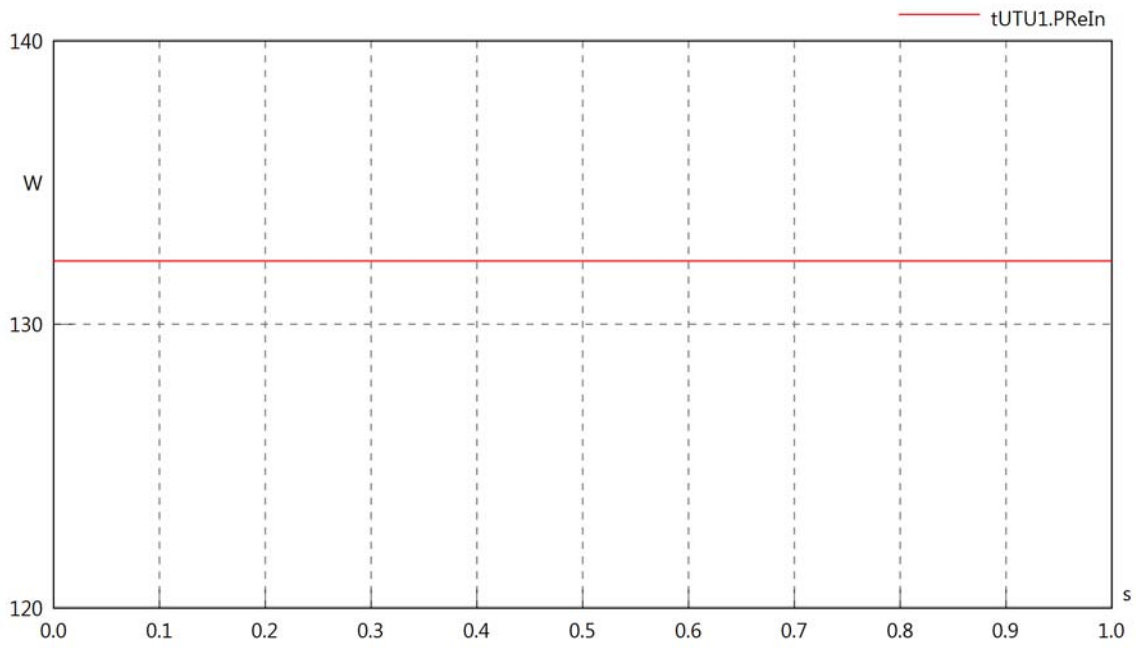

tUTU1.PImIn

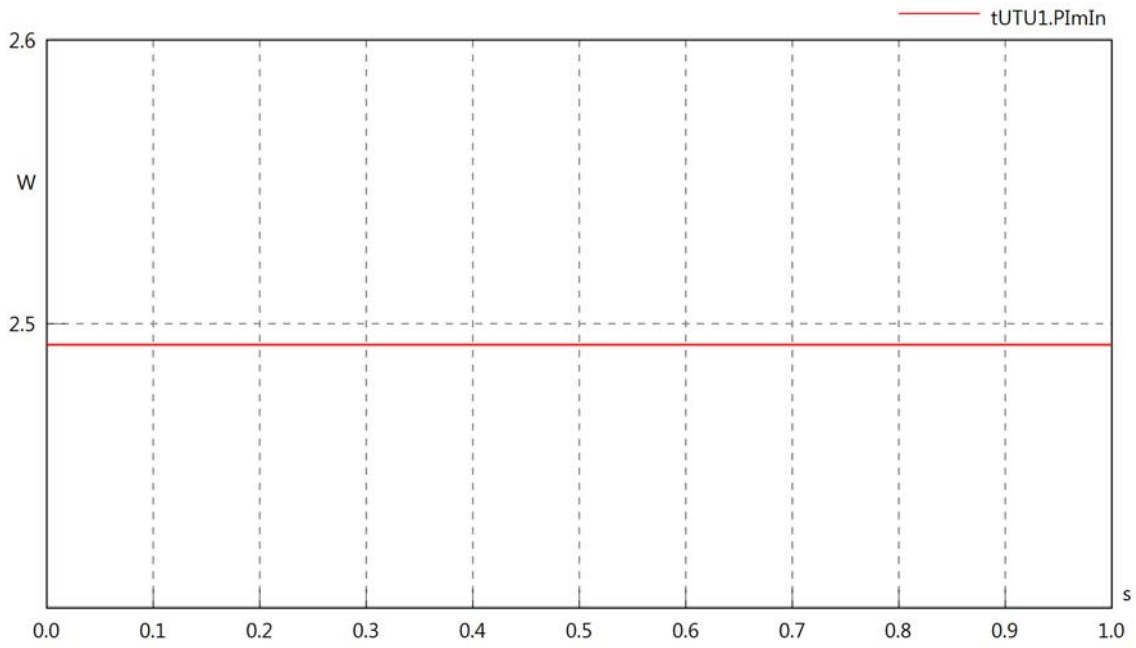

tUTU1.SIn

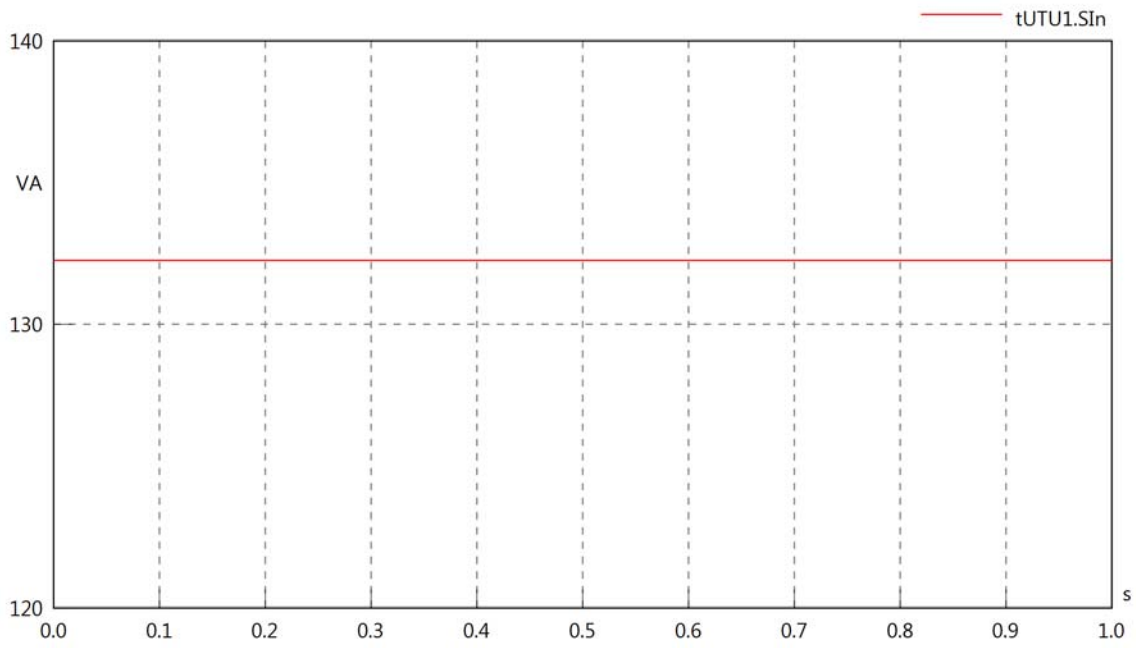

tUTU1.PReOut

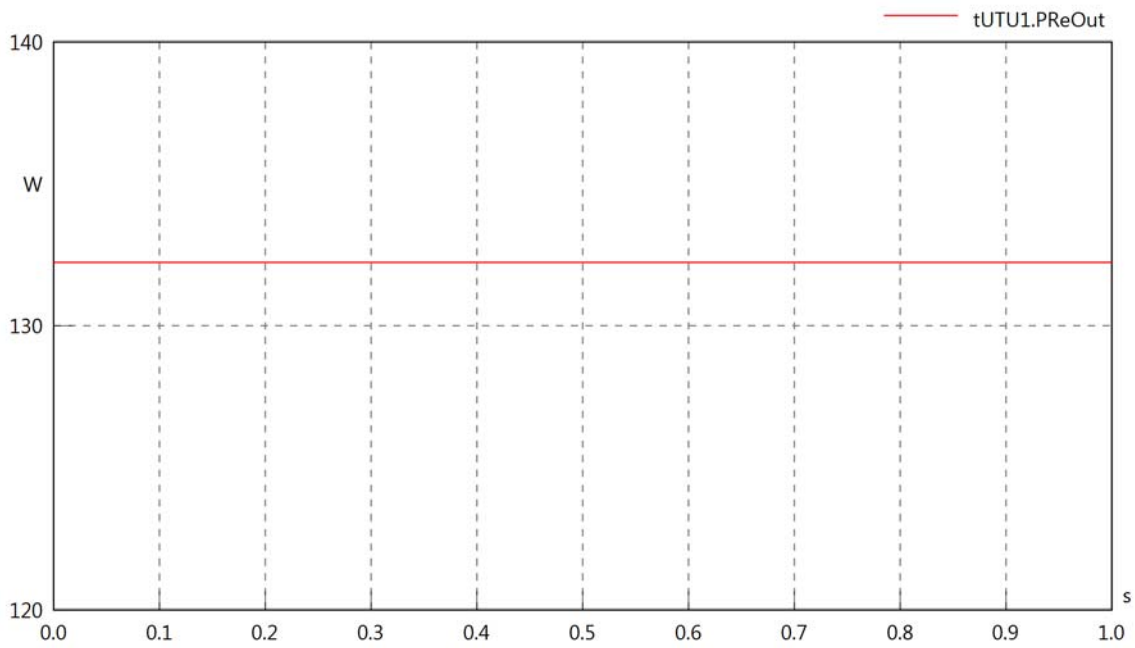

tUTU1.PImOut

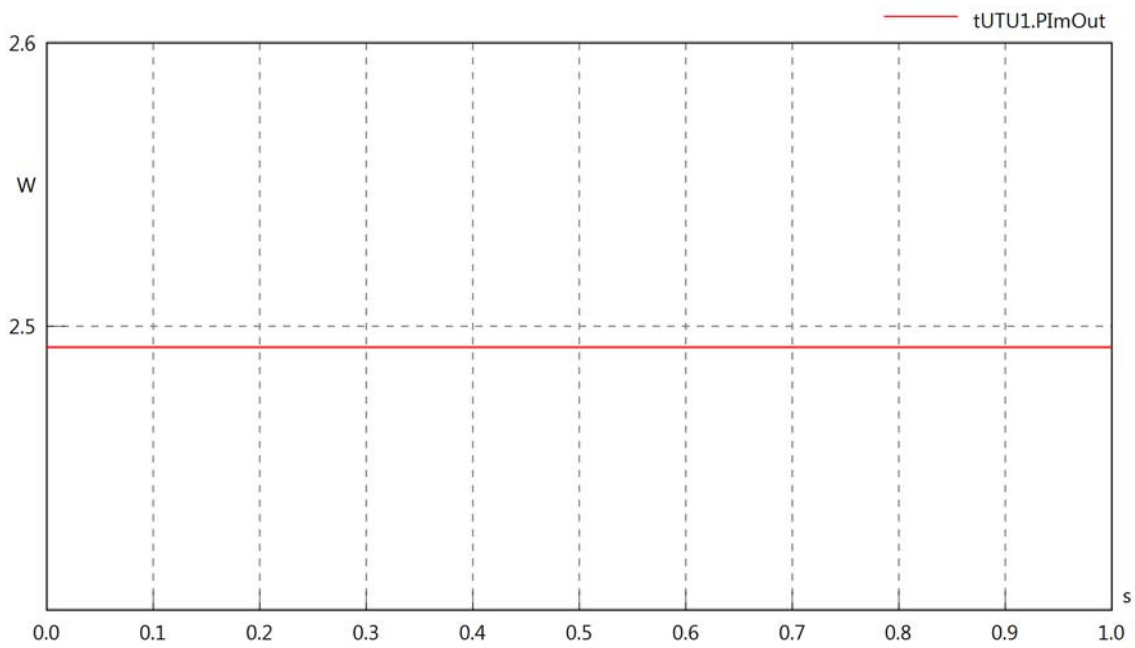

tUTU1.SOut

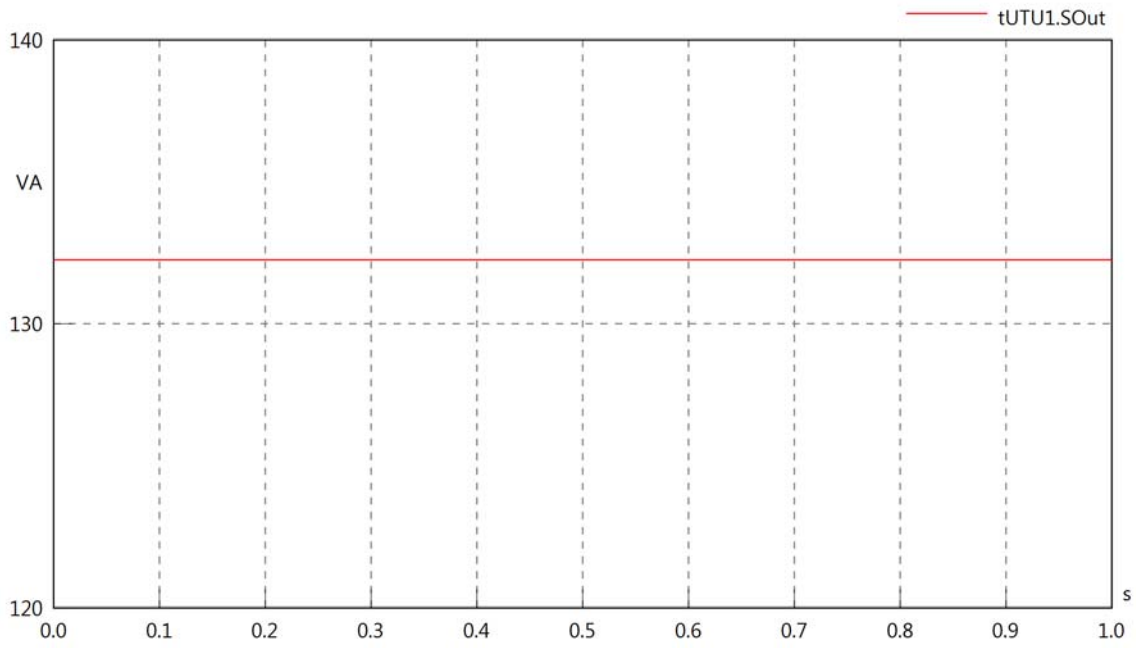
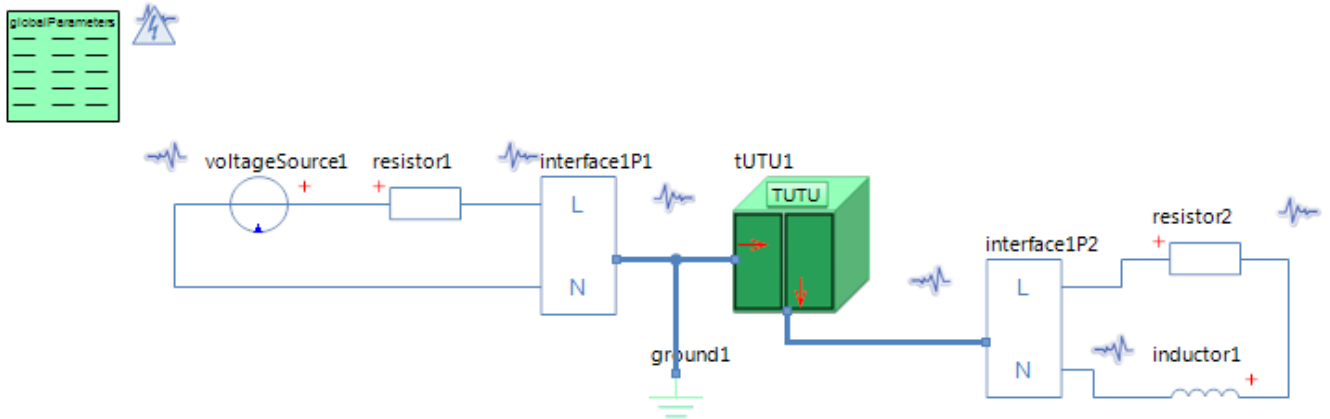

Diagram View



GlobalParameters globalParameters
Parameters

Comment	Name	Current Value	Unit
Type of Calculation	eCalculationKind	Signal Calculation	
Description of Frequency	eFrequencyKind	Linear	
Minimum Frequency	fMin	4000	[Hz]
Maximum Frequency	fMax	4000	[Hz]

Voltage Source voltageSource1
Parameters

Comment	Name	Current Value	Unit
Voltage RMS	VrmsSrc	230	[V]
Phase	phi	0	[deg]

Resistor resistor1
Parameters

Comment	Name	Current Value	Unit
Resistance	R	100	[Ohm]

Resistor resistor2
Parameters

Comment	Name	Current Value	Unit
Resistance	R	100	[Ohm]

Inductor inductor1
Parameters

Comment	Name	Current Value	Unit
Inductance	L	5	[mH]

Topside Umbilical Termination Unit tUTU1
Parameters

Comment	Name	Current Value	Unit
Poor or failing L1 connection	bL1	false	

tUTU1.VrmsIn

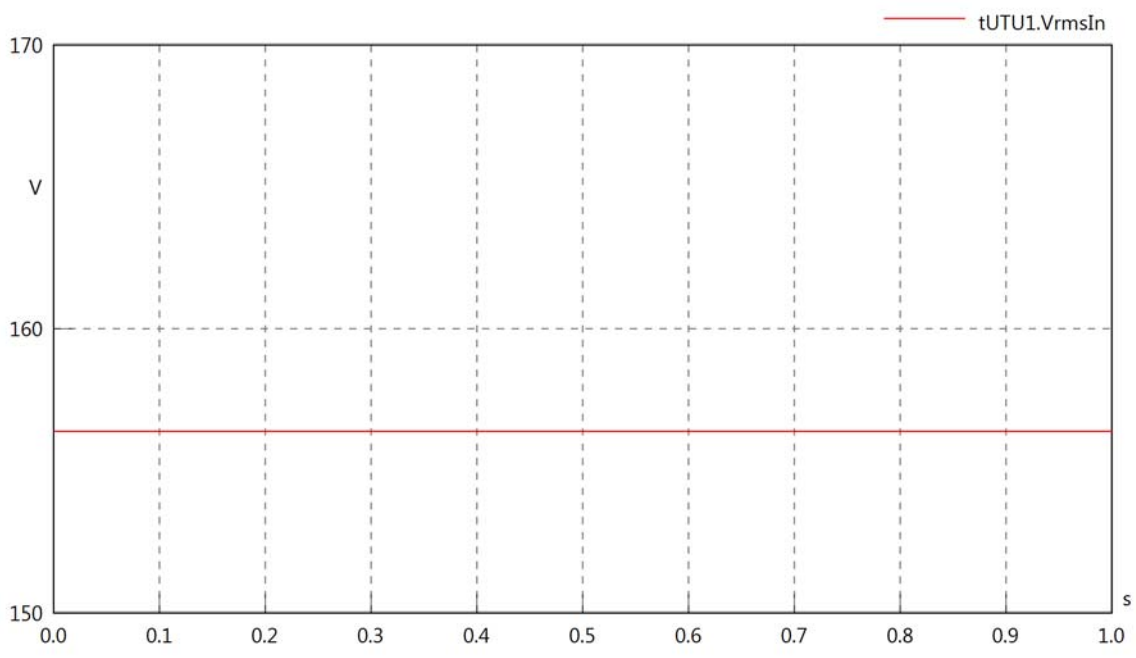

tUTU1.vReIn

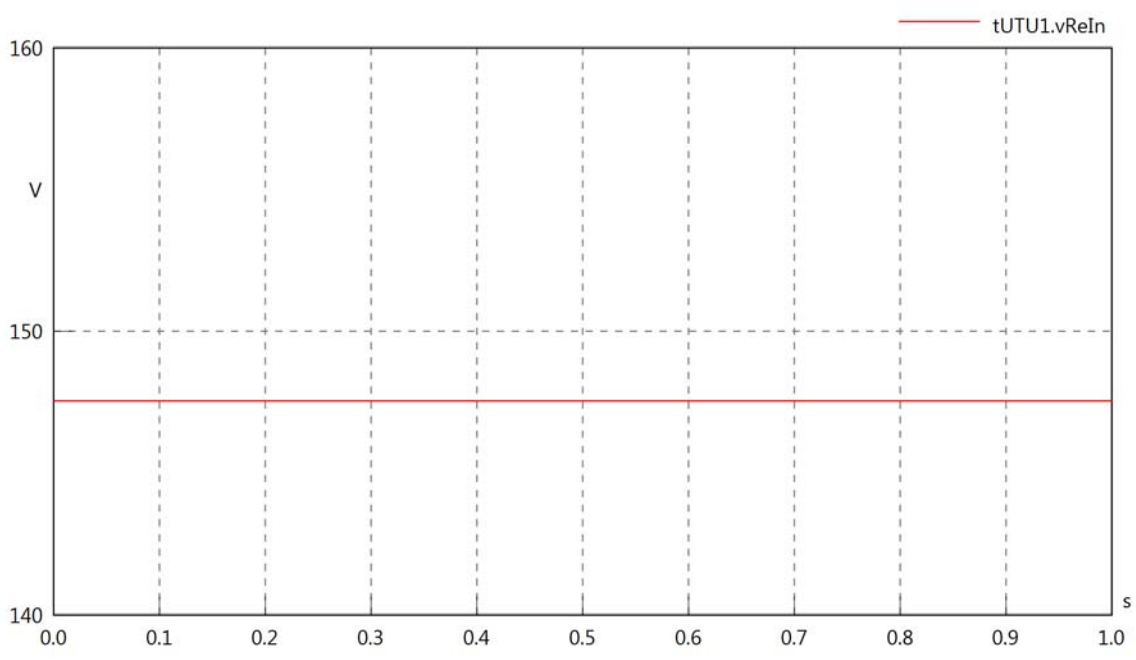

tUTU1.vImIn

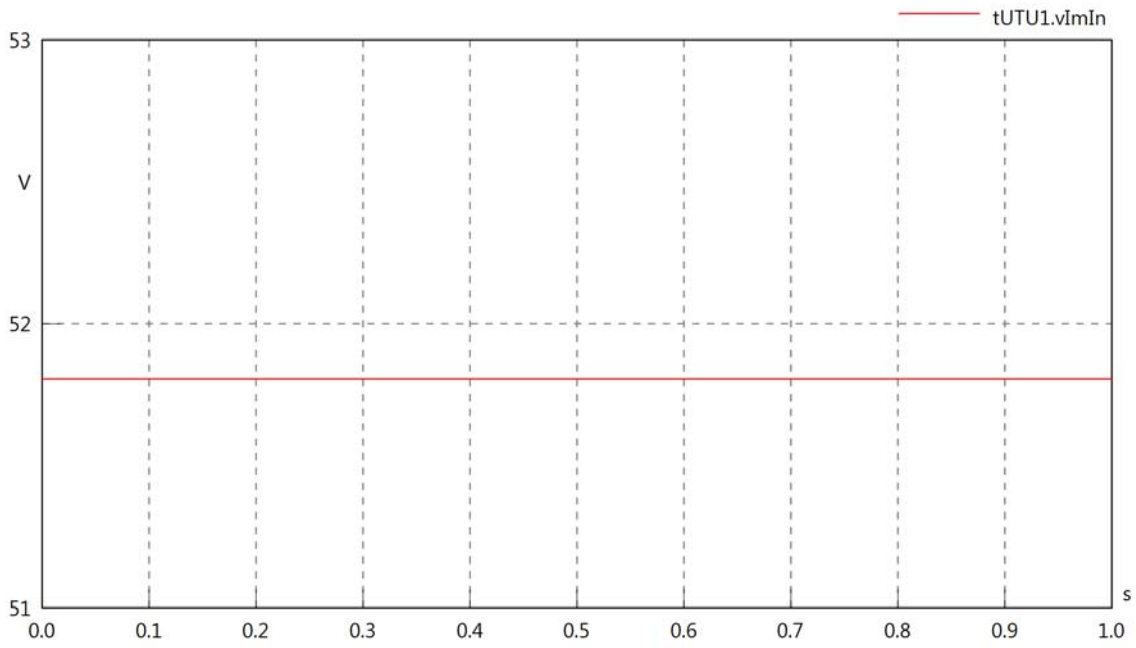

tUTU1.VrmsOut

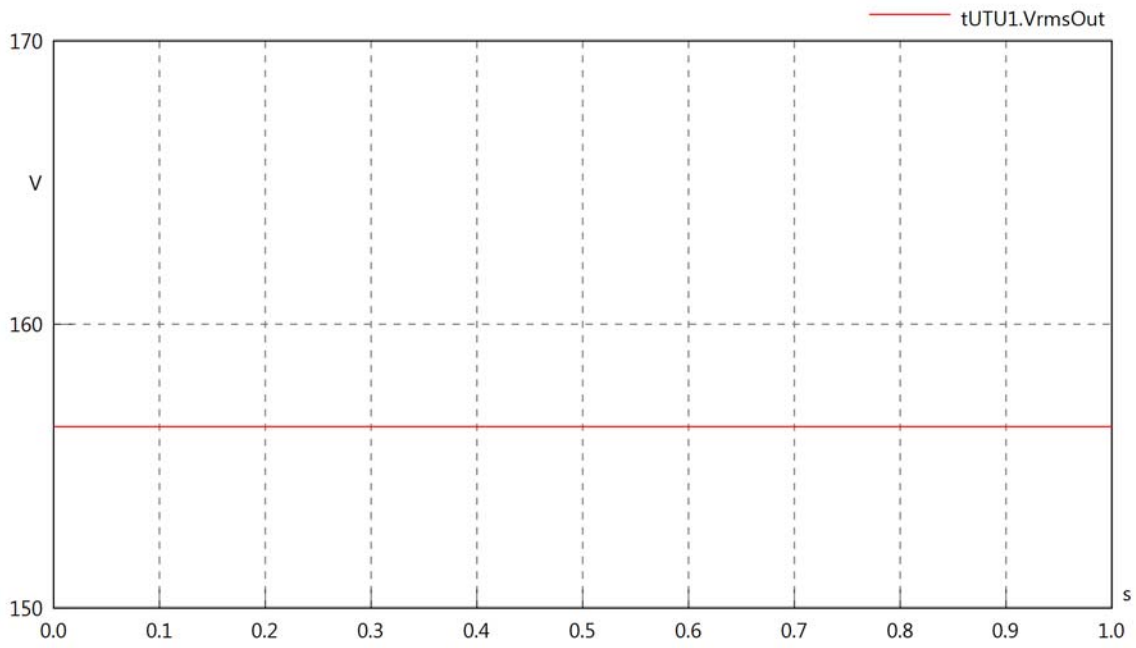

tUTU1.vReOut

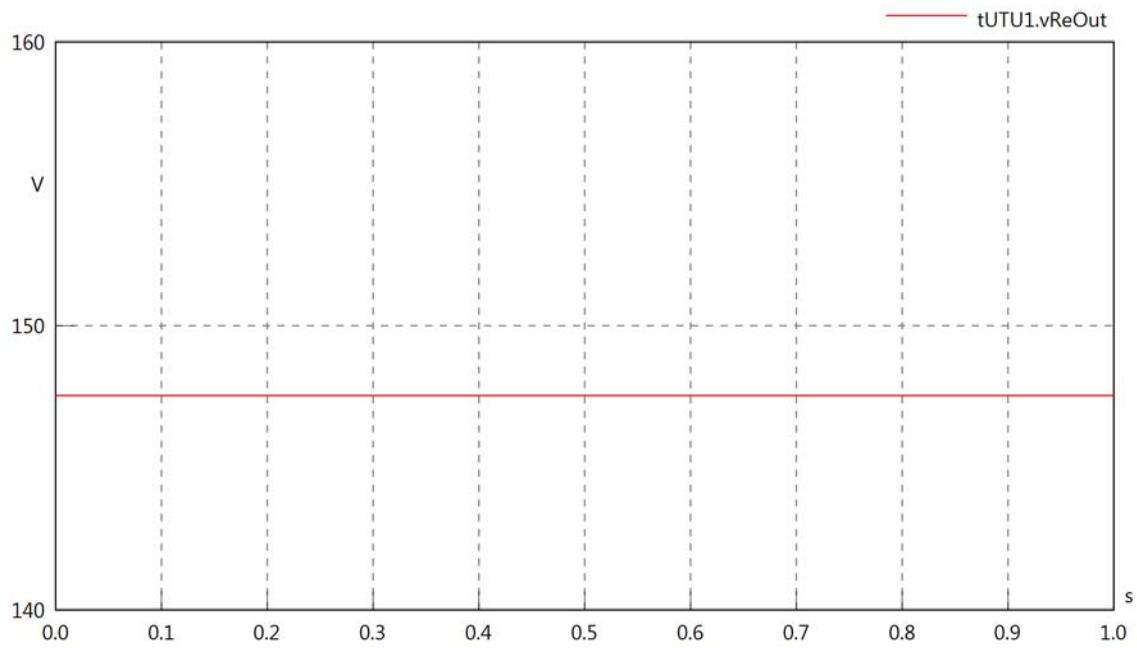

tUTU1.vImOut

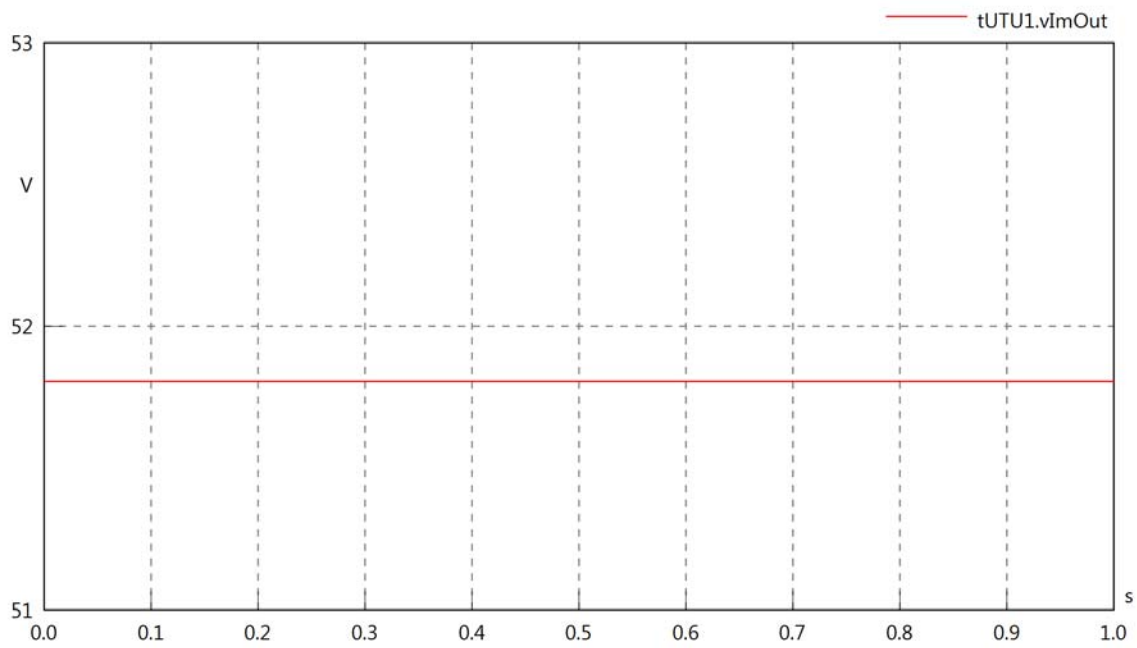

tUTU1.Vrms

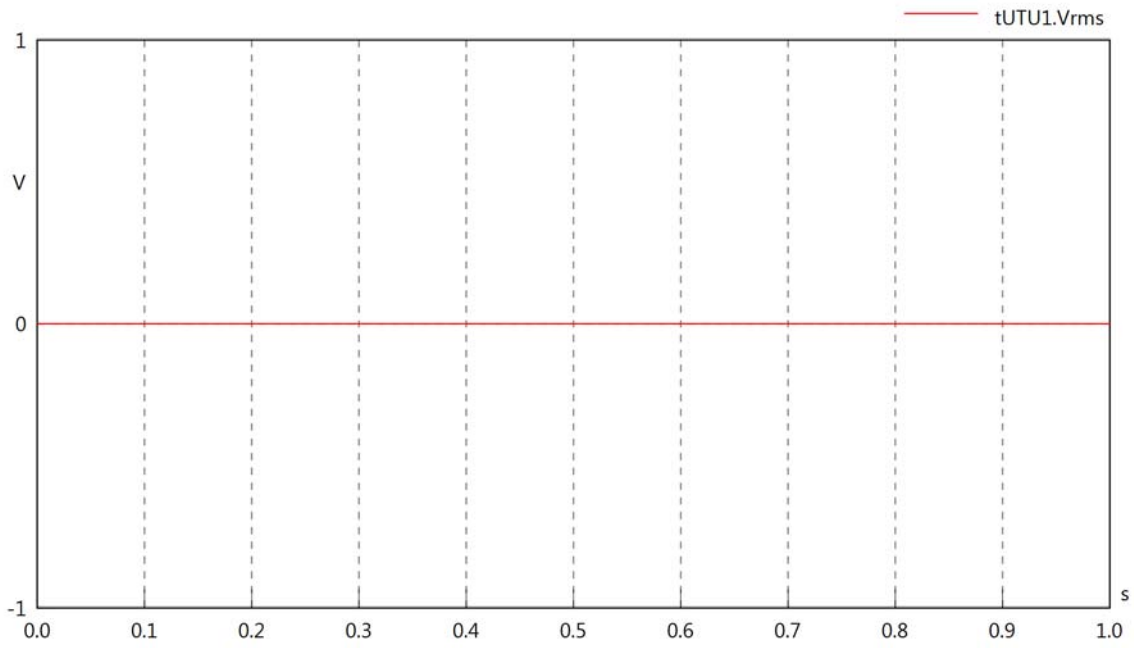

tUTU1.vRe

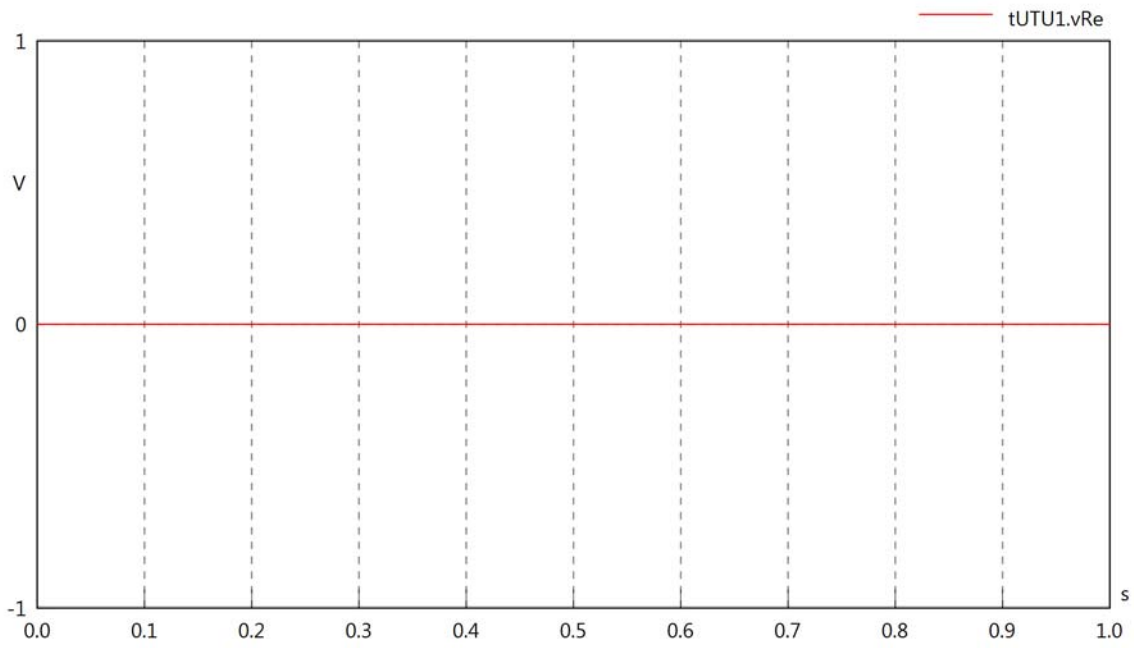

tUTU1.vIm

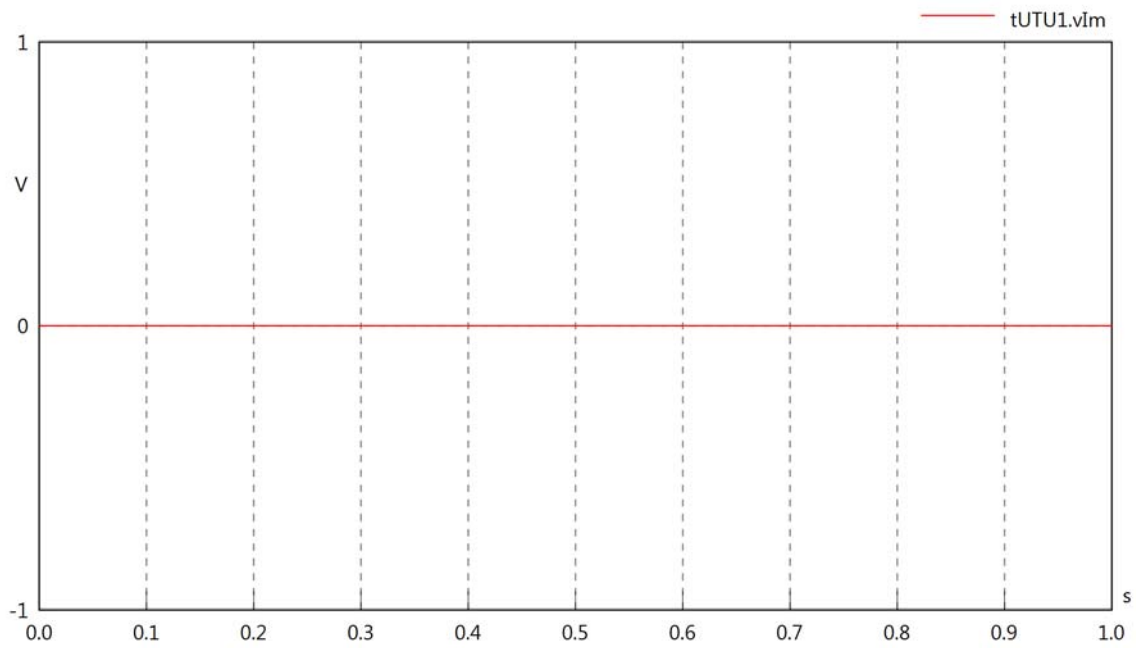

tUTU1.IrmsIn

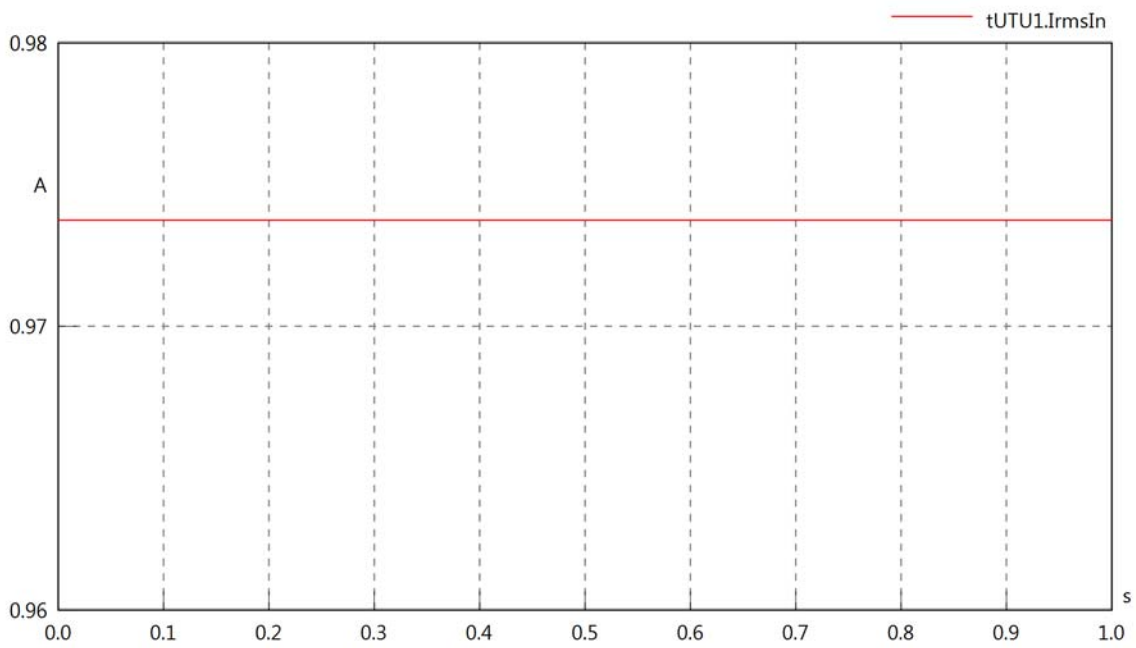

tUTU1.iReIn

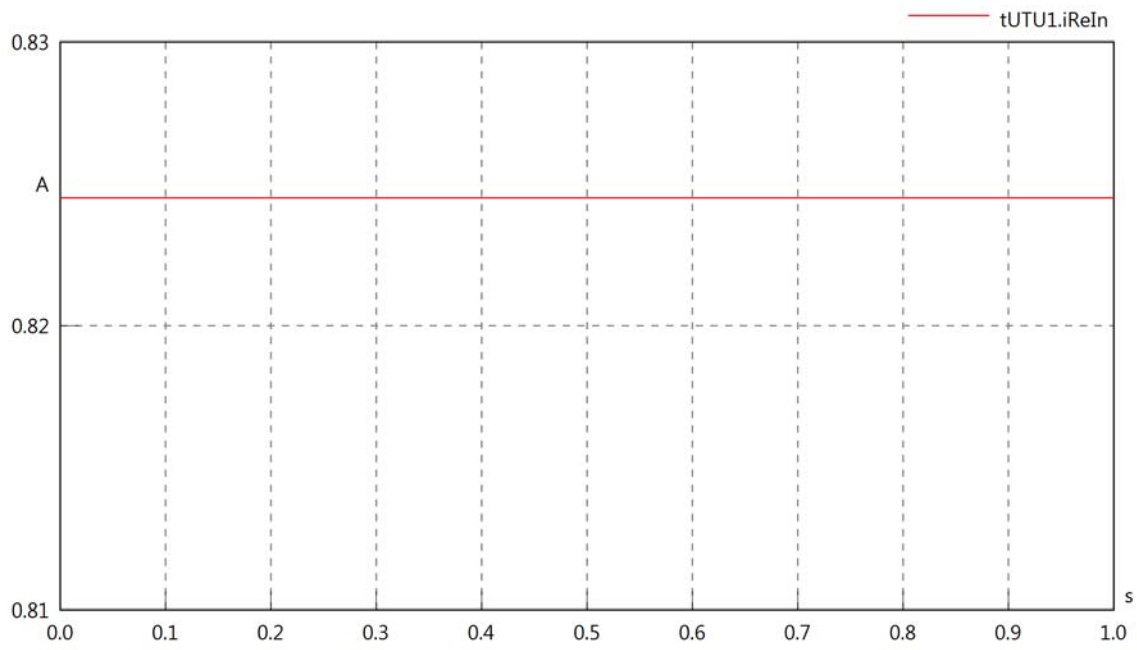

tUTU1.iImIn

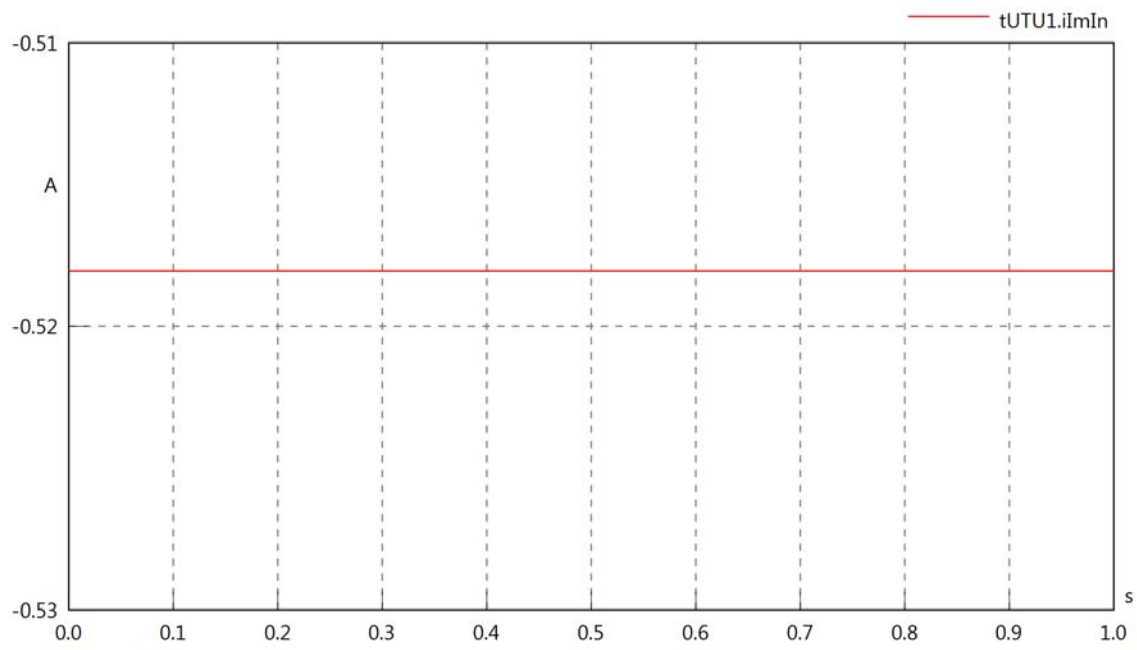

tUTU1.IrmsOut

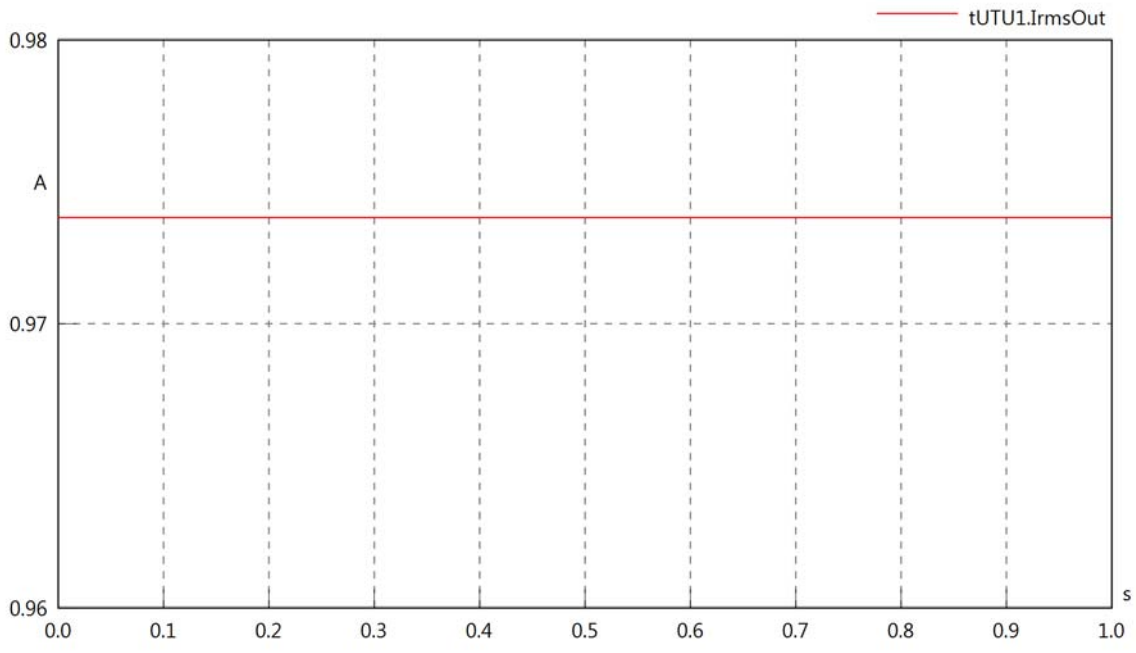

tUTU1.iReOut

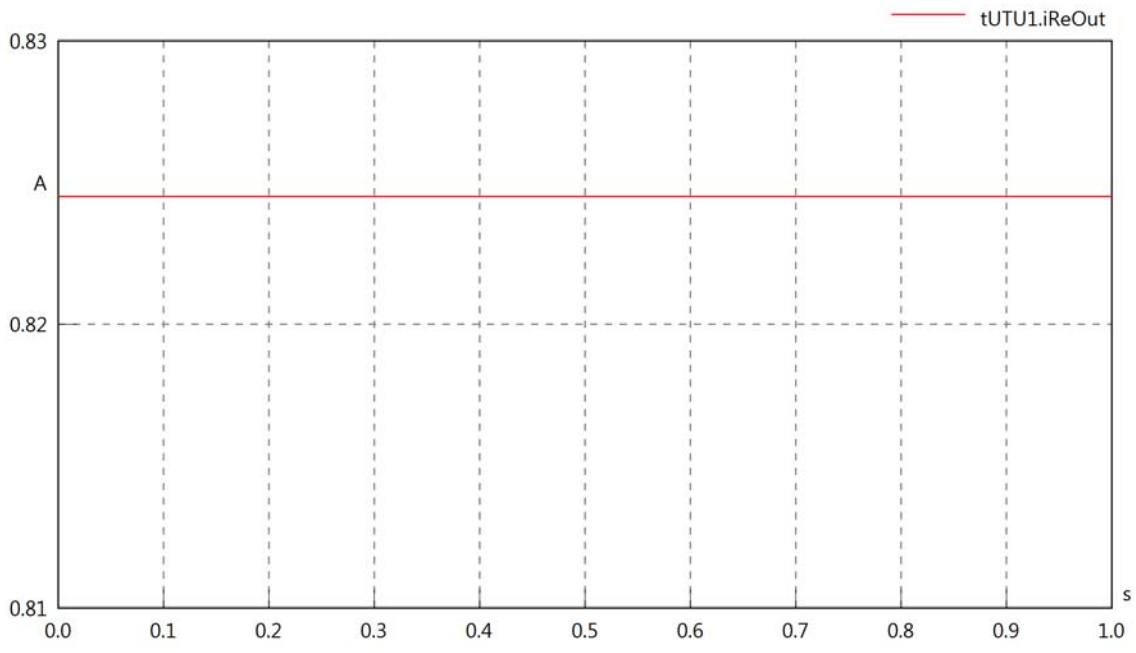

tUTU1.iImOut

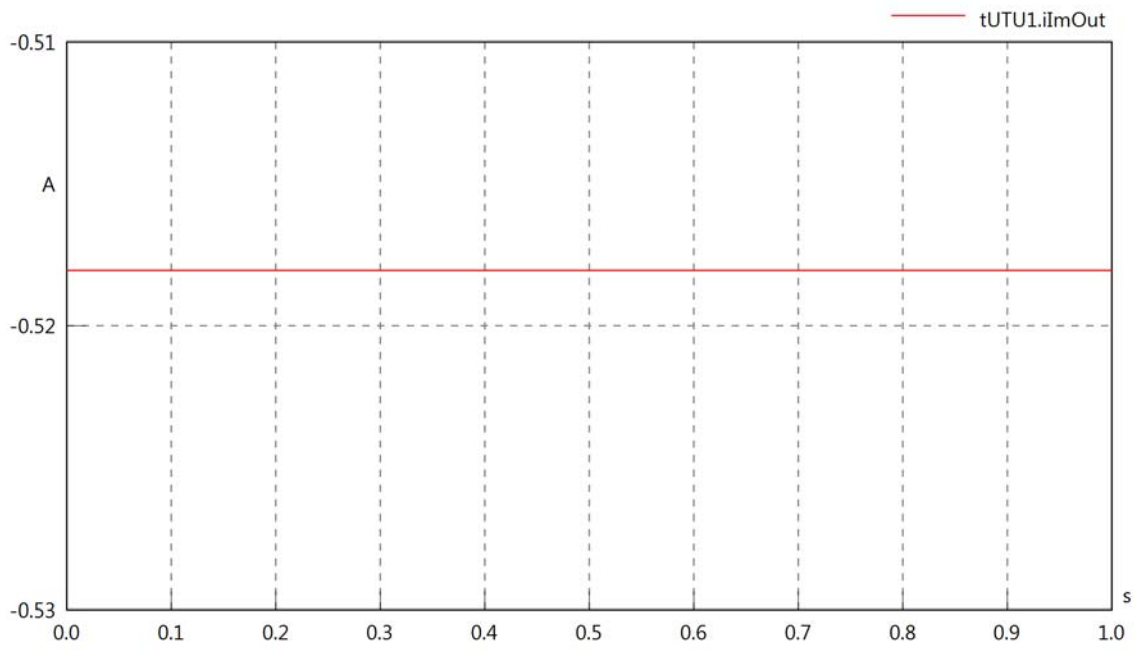

tUTU1.phiVIn

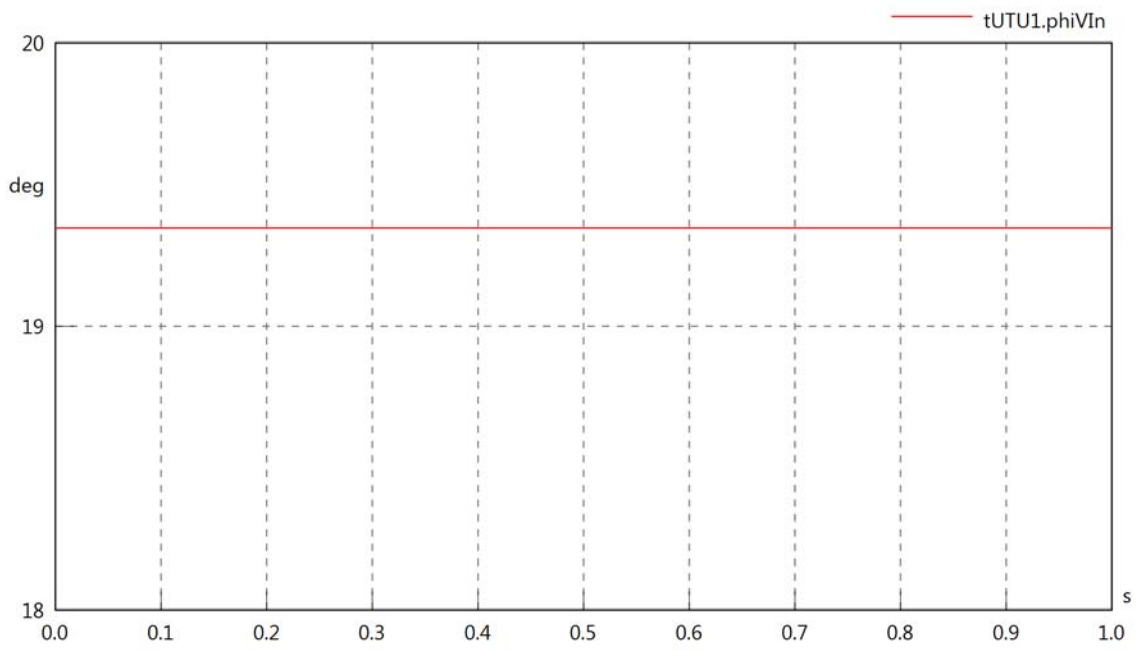

tUTU1.phiIIIn

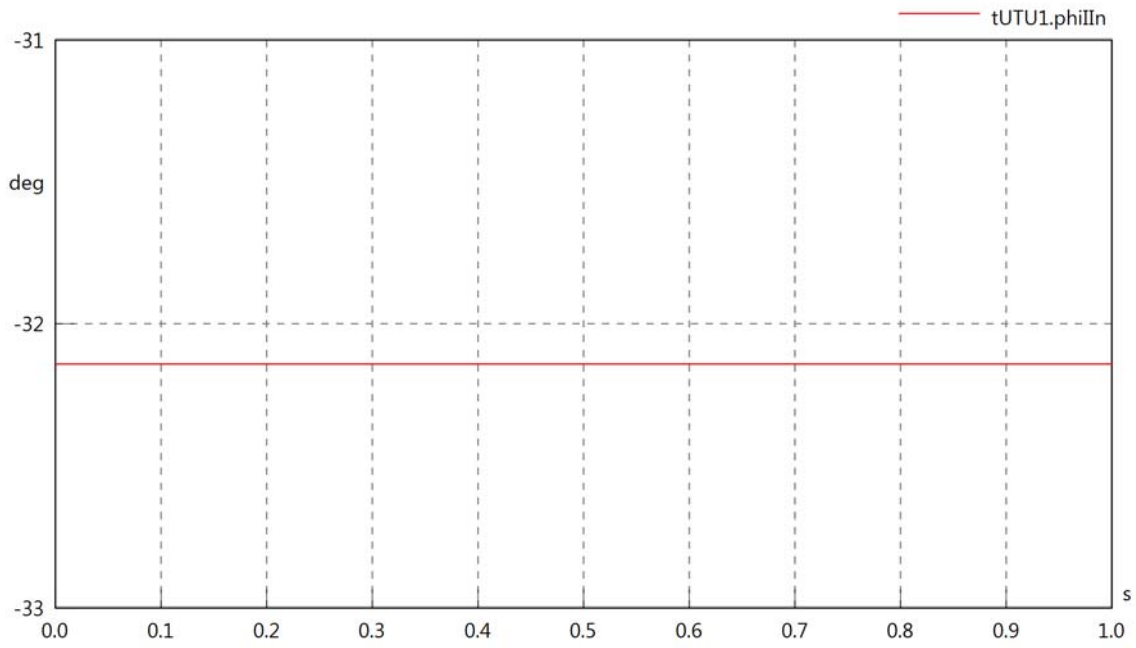

tUTU1.phiIVIn

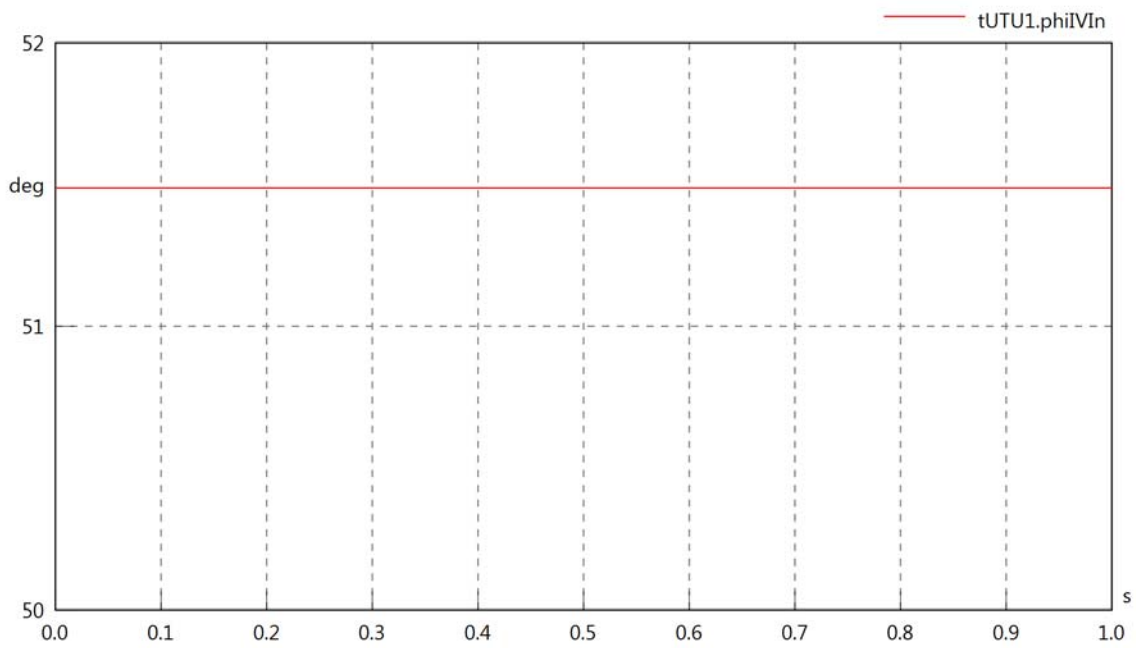

tUTU1.phiVOut

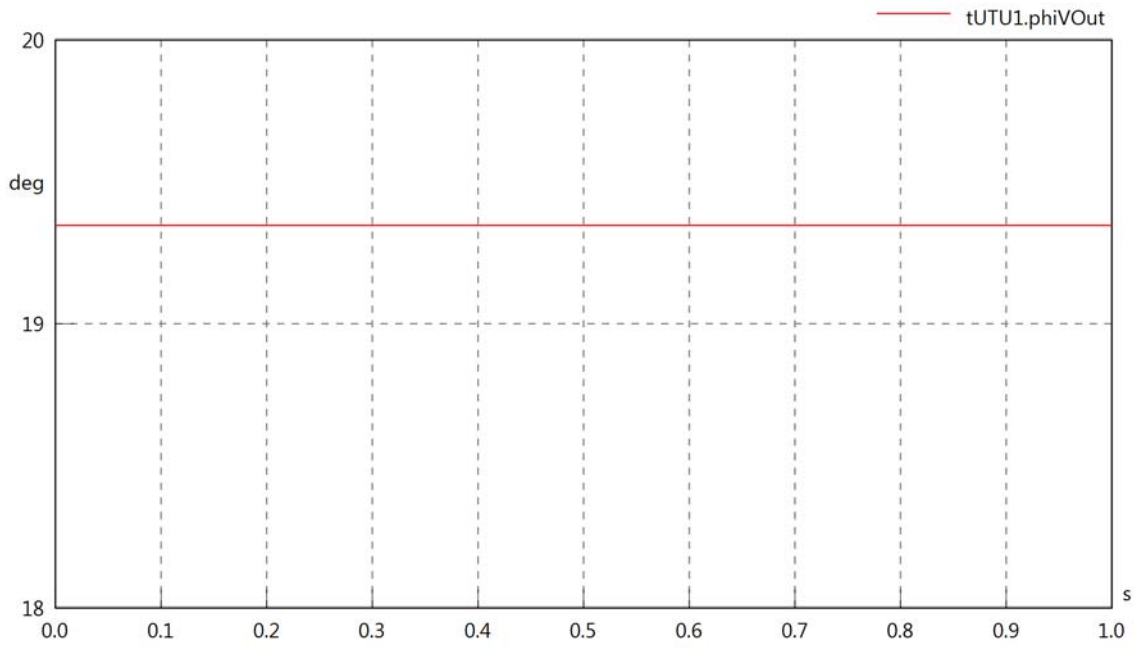

tUTU1.phiIOut

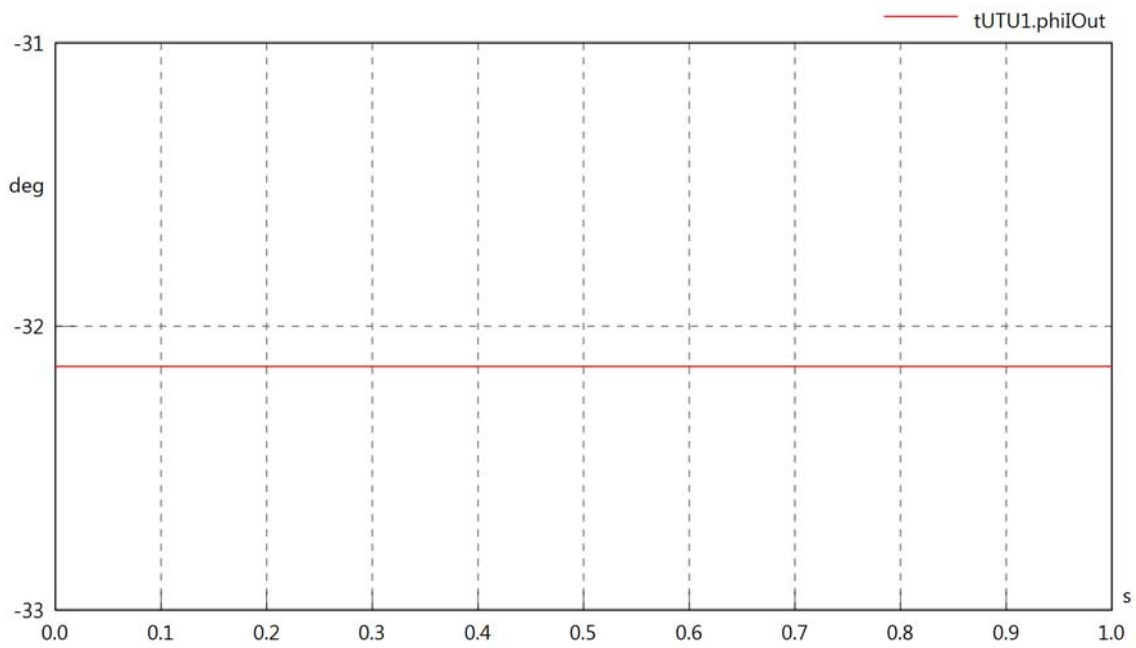

tUTU1.phiIVOut

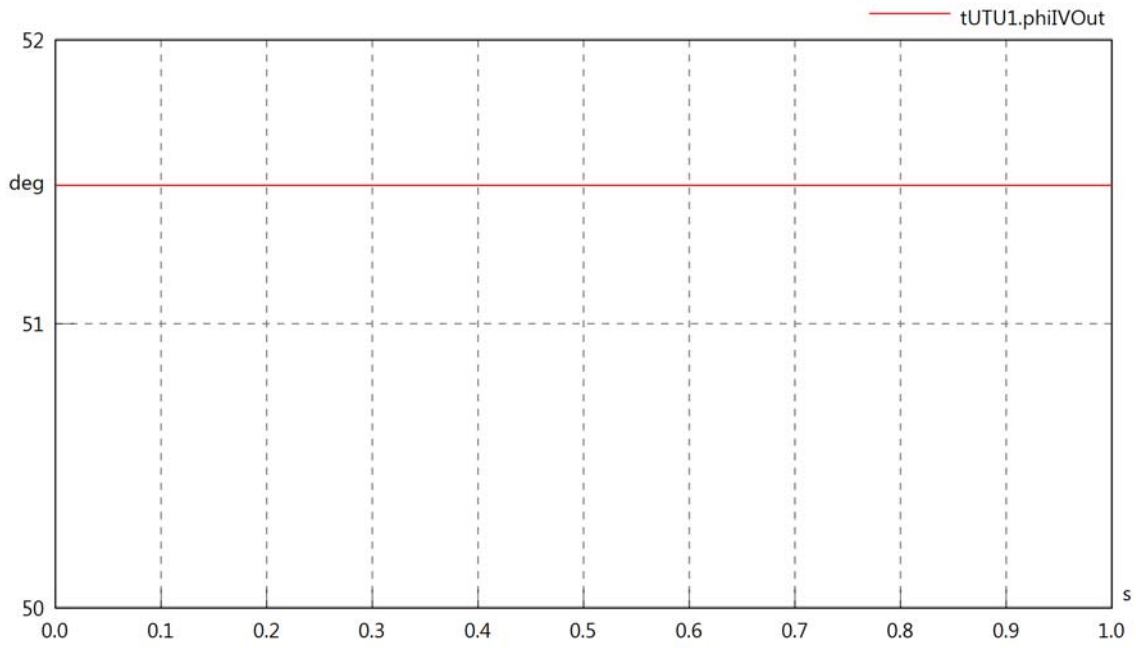

tUTU1.PReIn

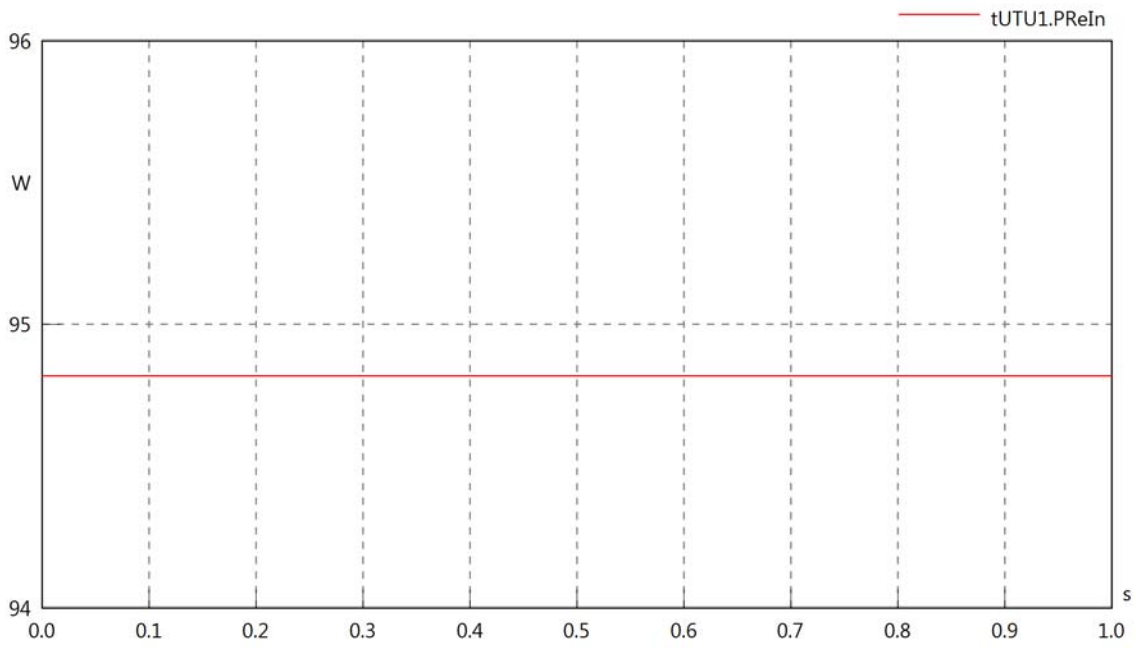

tUTU1.PImIn

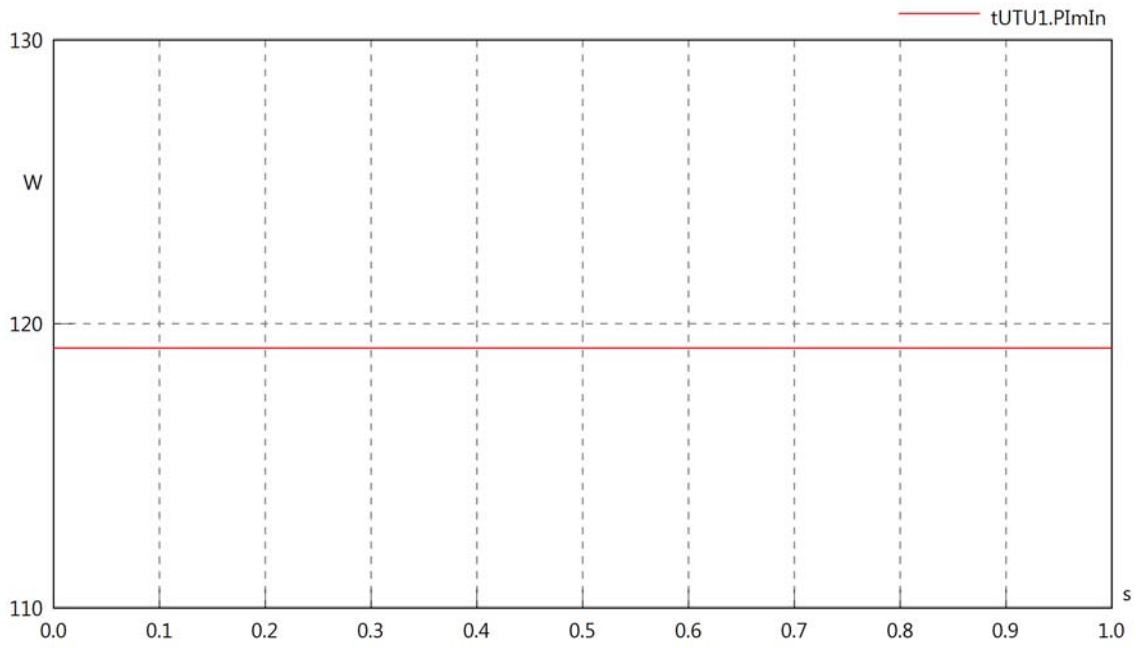

tUTU1.SIn

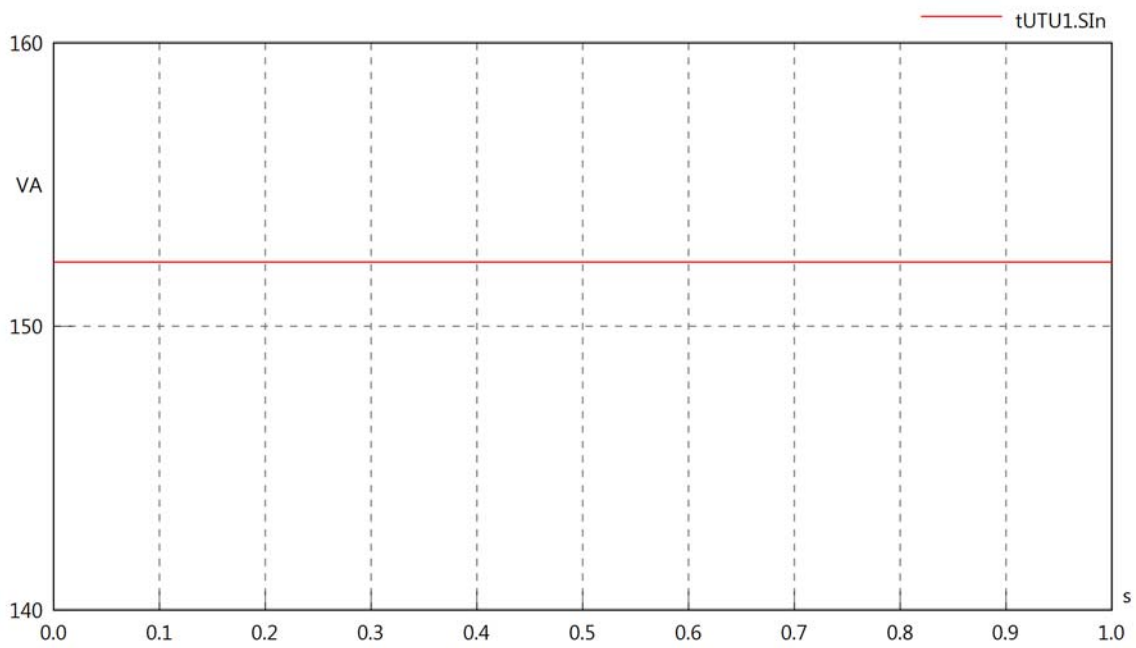

tUTU1.PReOut

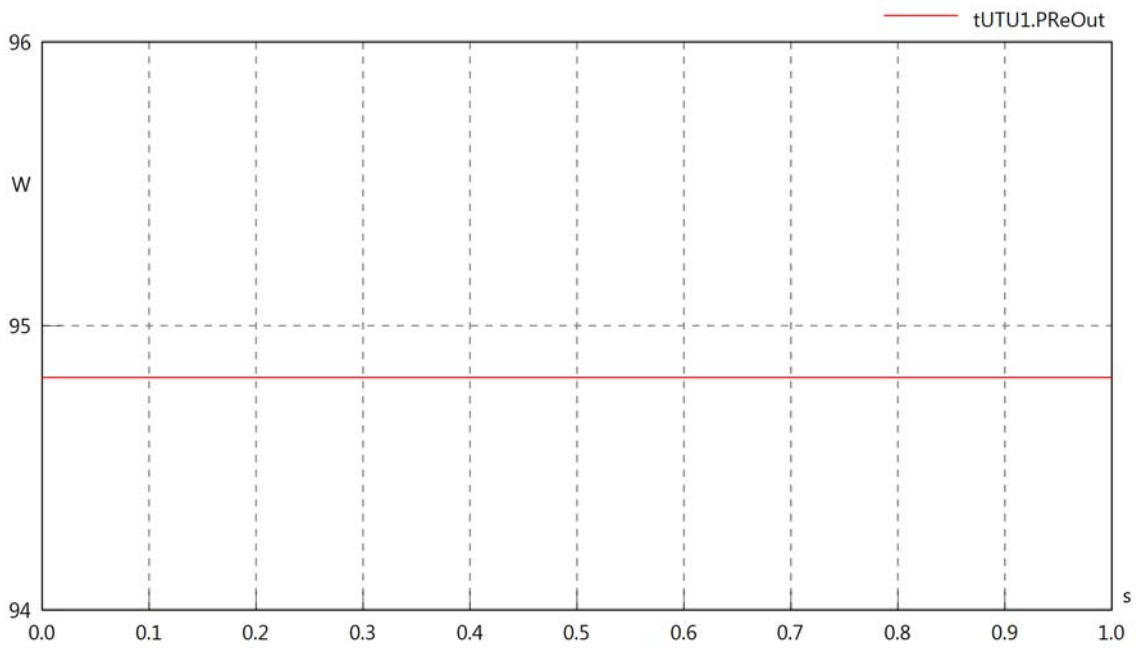

tUTU1.PImOut

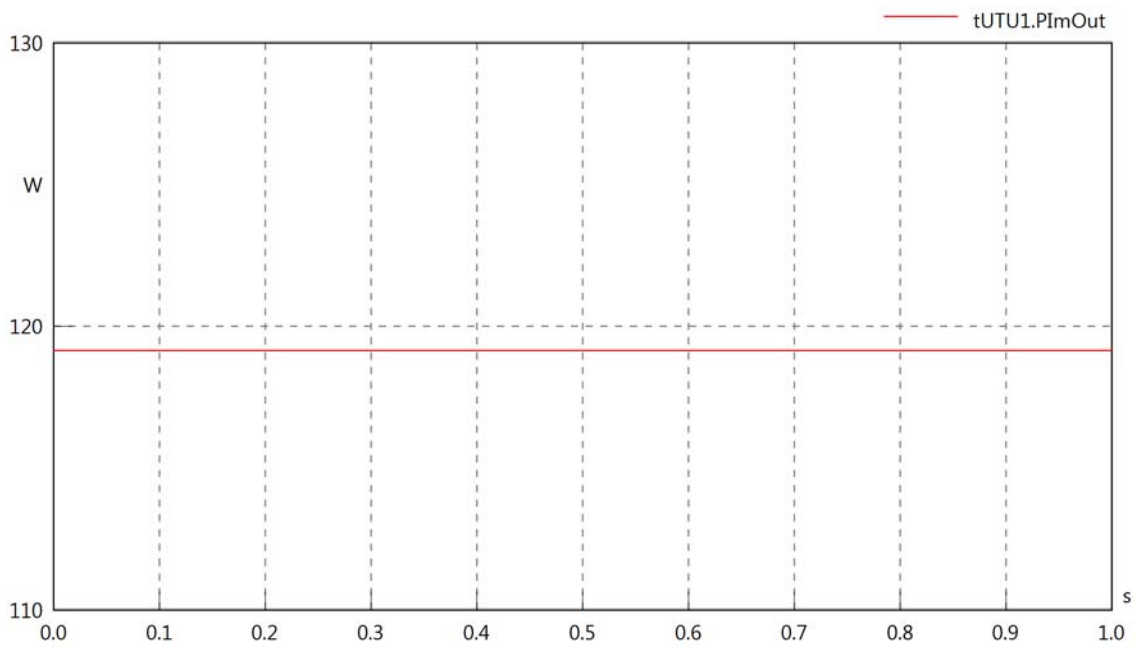

tUTU1.SOut

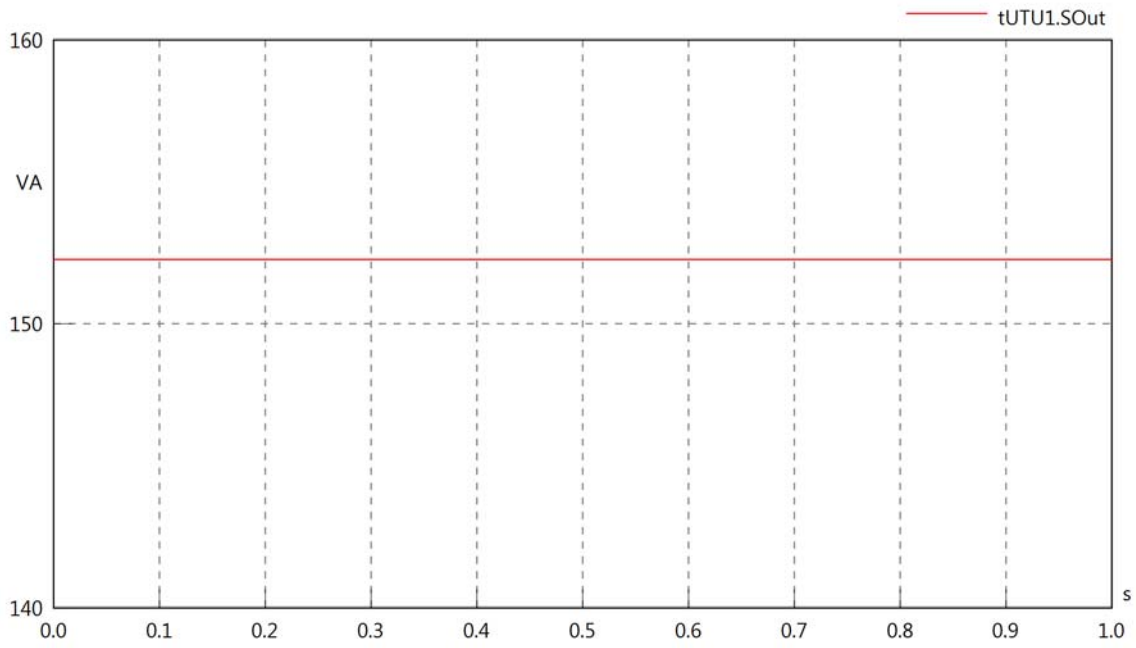
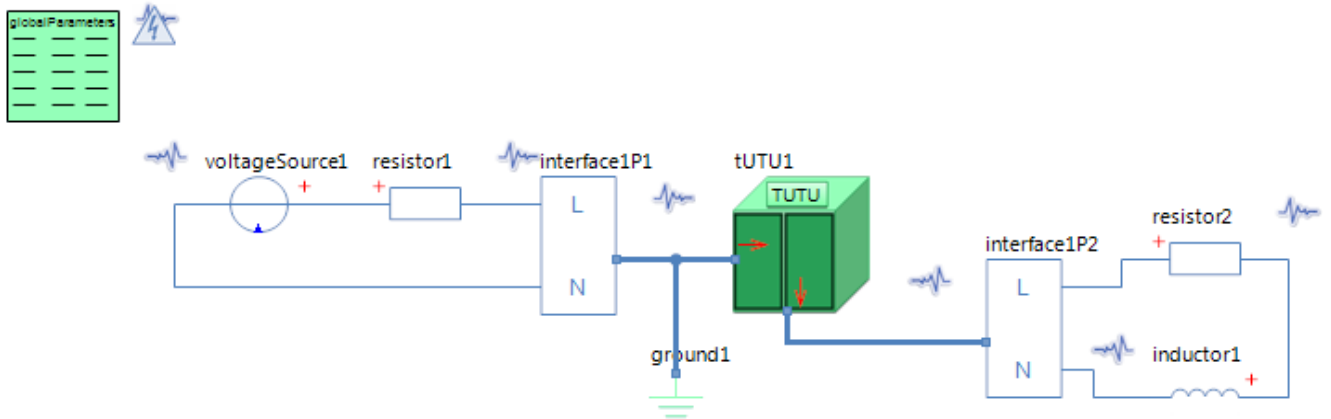

Diagram View



GlobalParameters globalParameters
Parameters

Comment	Name	Current Value	Unit
Type of Calculation	eCalculationKind	Signal Calculation	
Description of Frequency	eFrequencyKind	Linear	
Minimum Frequency	fMin	20000	[Hz]
Maximum Frequency	fMax	20000	[Hz]

Voltage Source voltageSource1
Parameters

Comment	Name	Current Value	Unit
Voltage RMS	VrmsSrc	230	[V]
Phase	phi	0	[deg]

Resistor resistor1
Parameters

Comment	Name	Current Value	Unit
Resistance	R	100	[Ohm]

Resistor resistor2
Parameters

Comment	Name	Current Value	Unit
Resistance	R	100	[Ohm]

Inductor inductor1
Parameters

Comment	Name	Current Value	Unit
Inductance	L	5	[mH]

Topside Umbilical Termination Unit tUTU1
Parameters

Comment	Name	Current Value	Unit
Poor or failing L1 connection	bL1	false	

tUTU1.VrmsIn

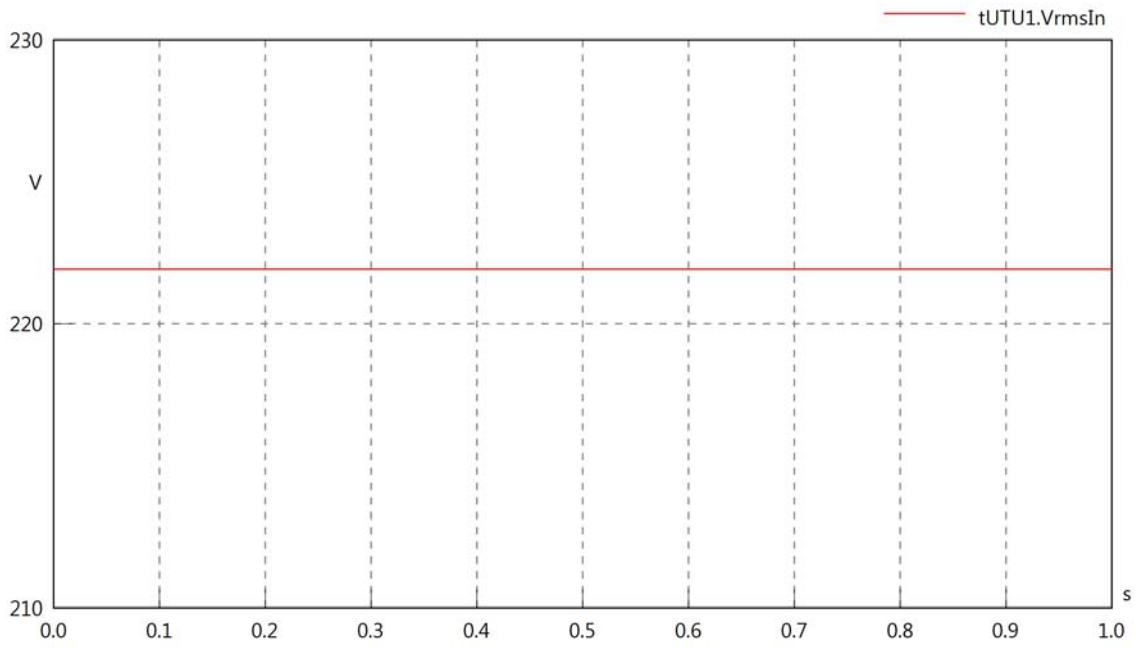

tUTU1.vReIn

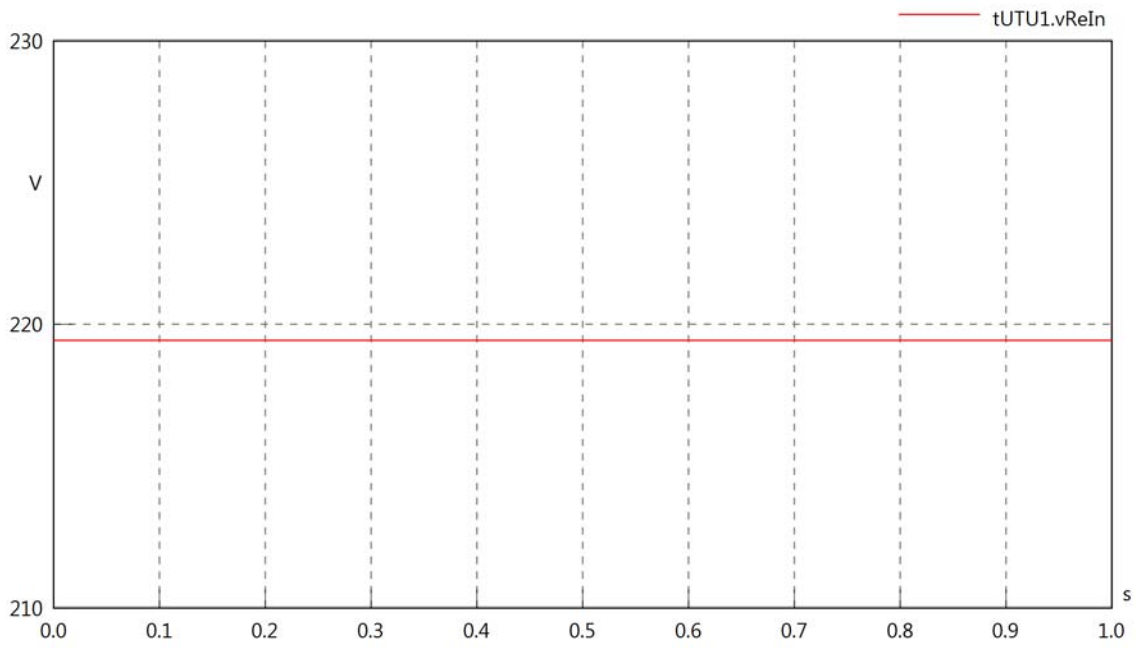

tUTU1.vImIn

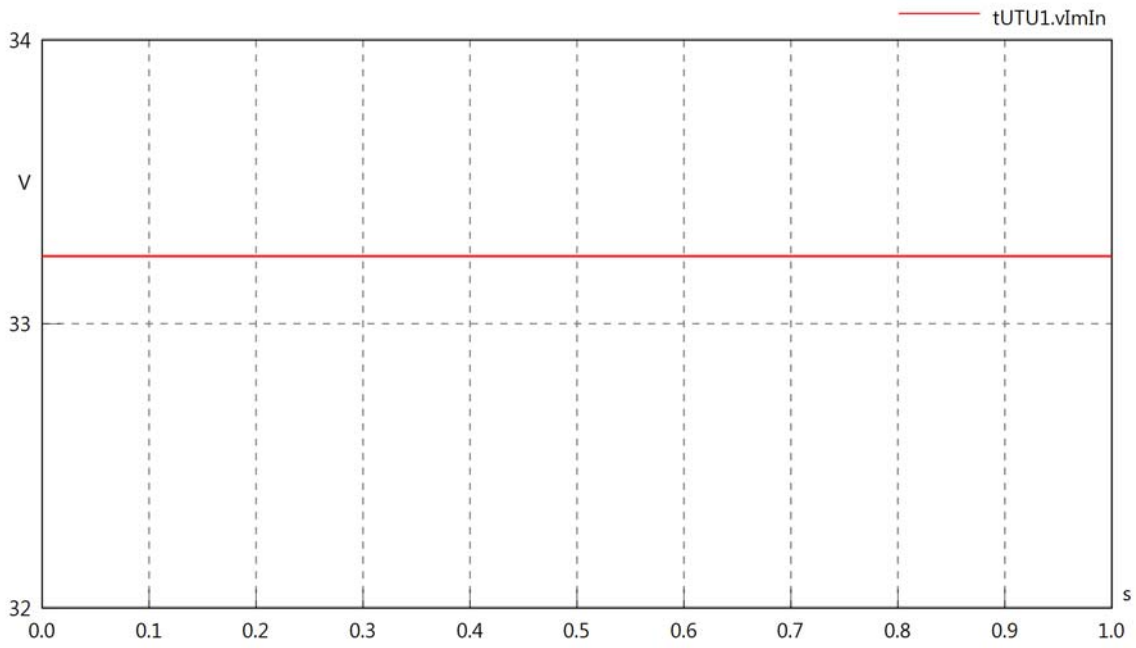

tUTU1.VrmsOut

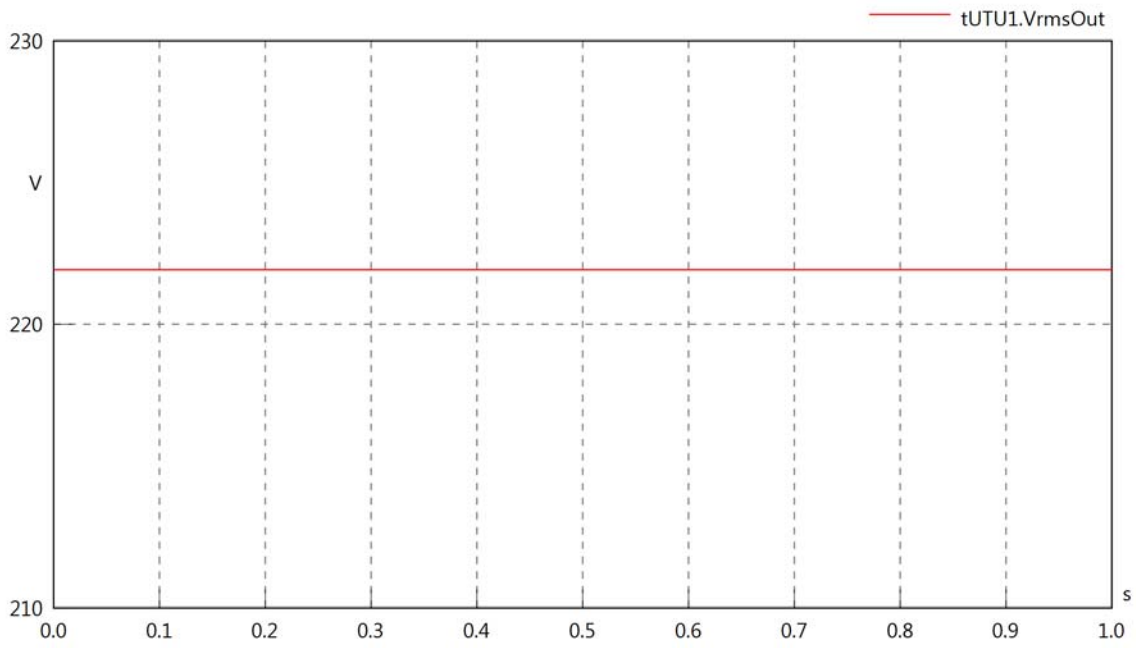

tUTU1.vReOut

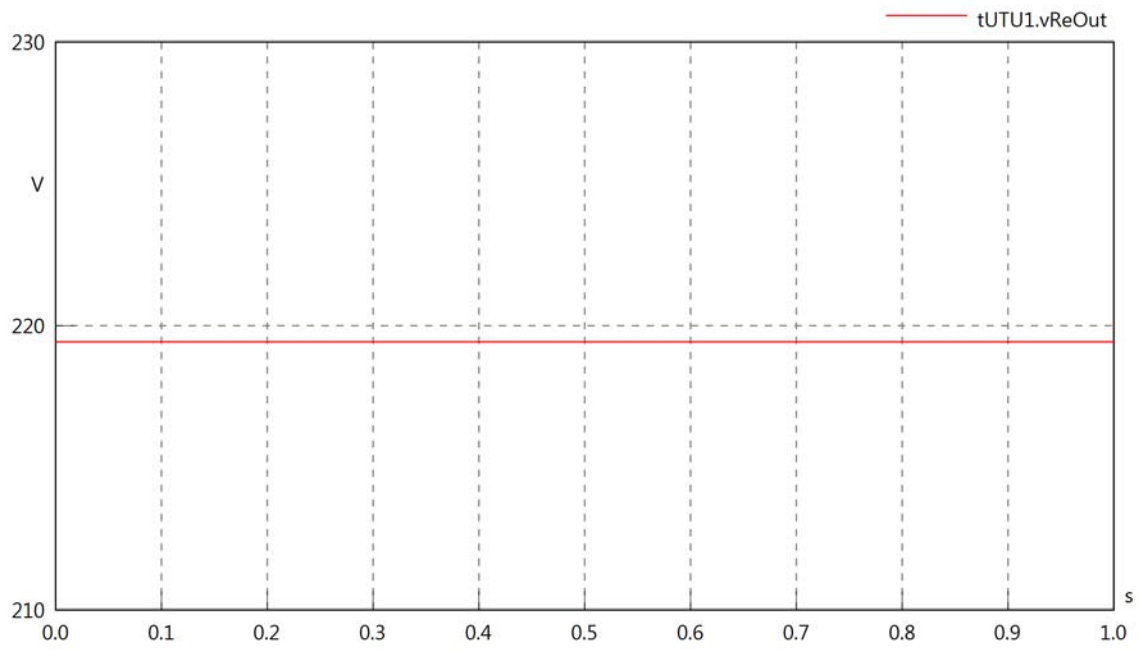

tUTU1.vImOut

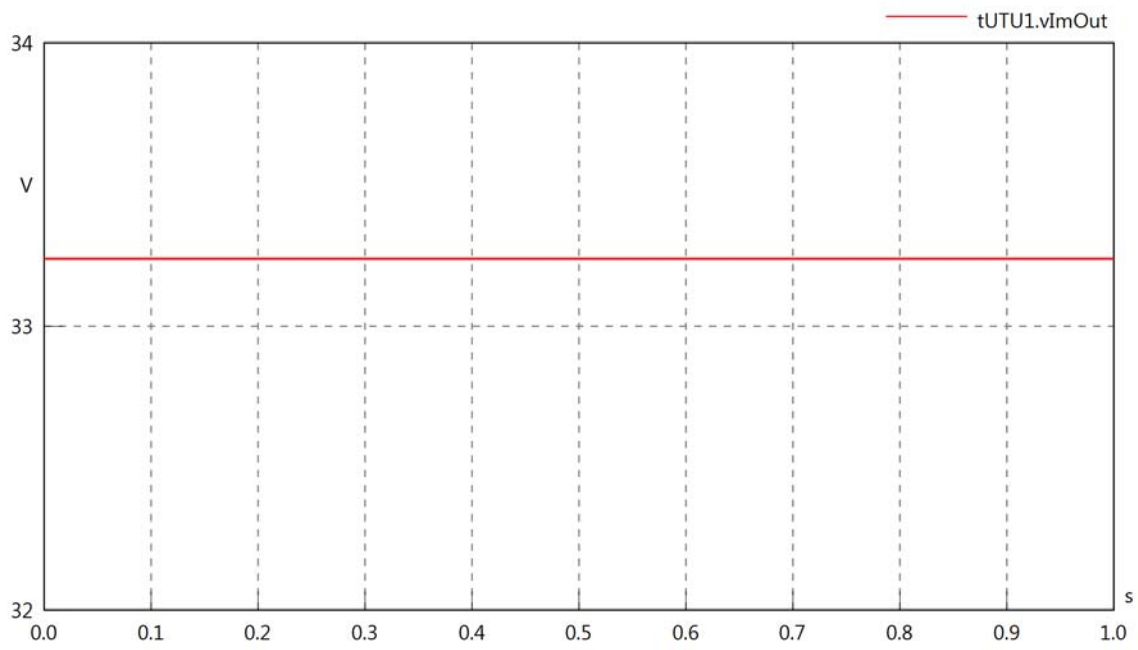

tUTU1.Vrms

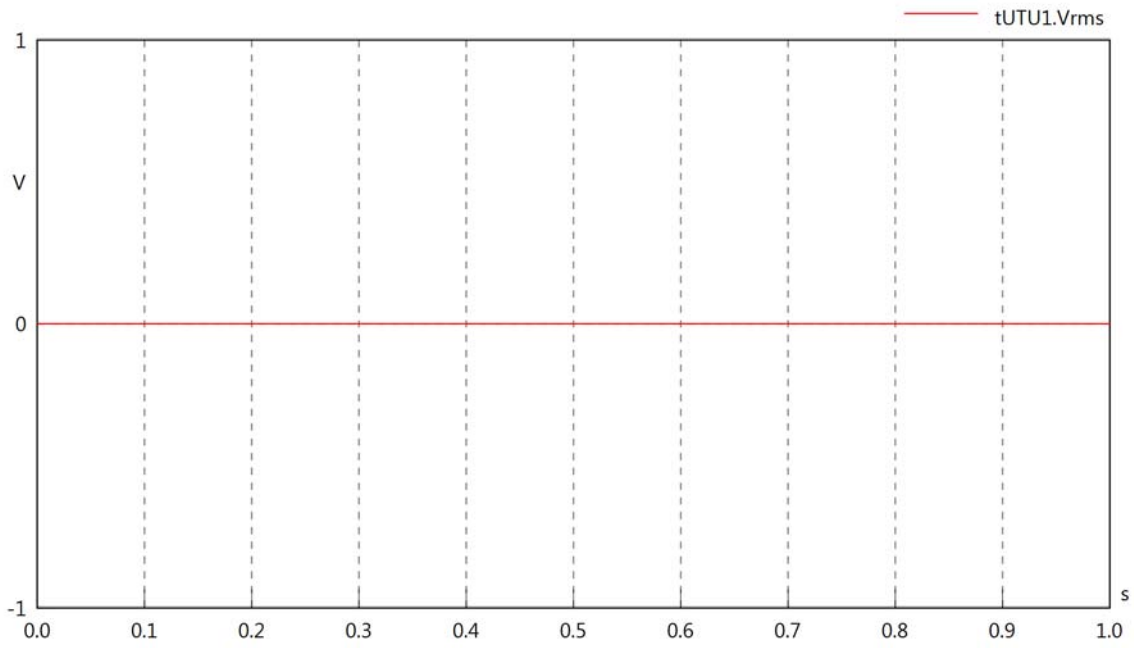

tUTU1.vRe

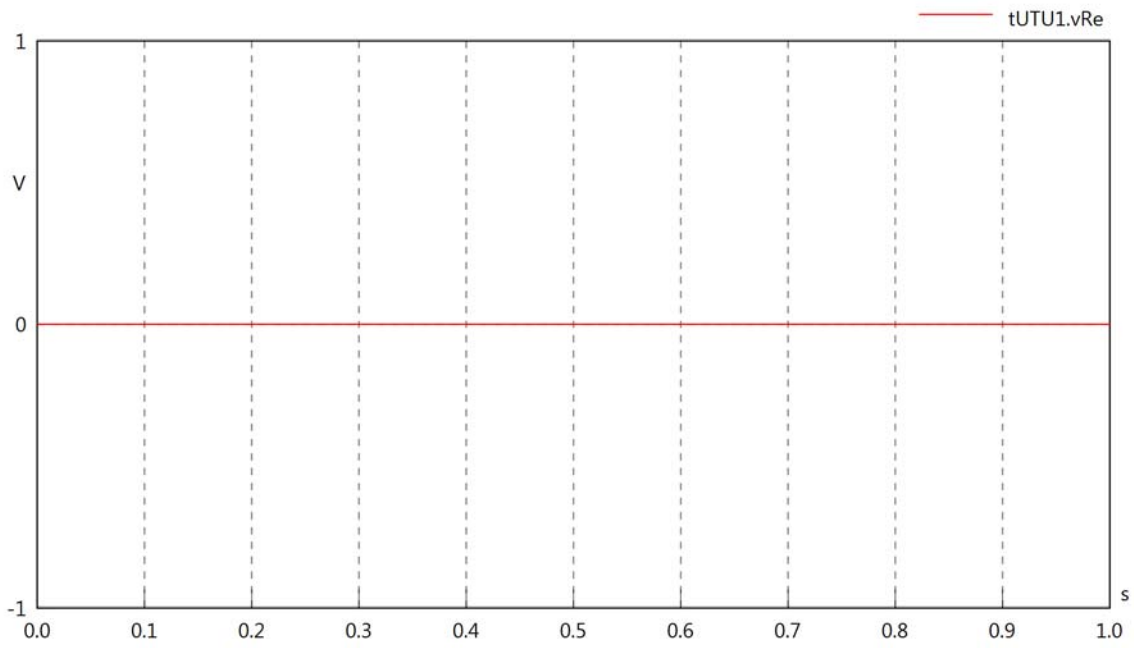

tUTU1.vIm

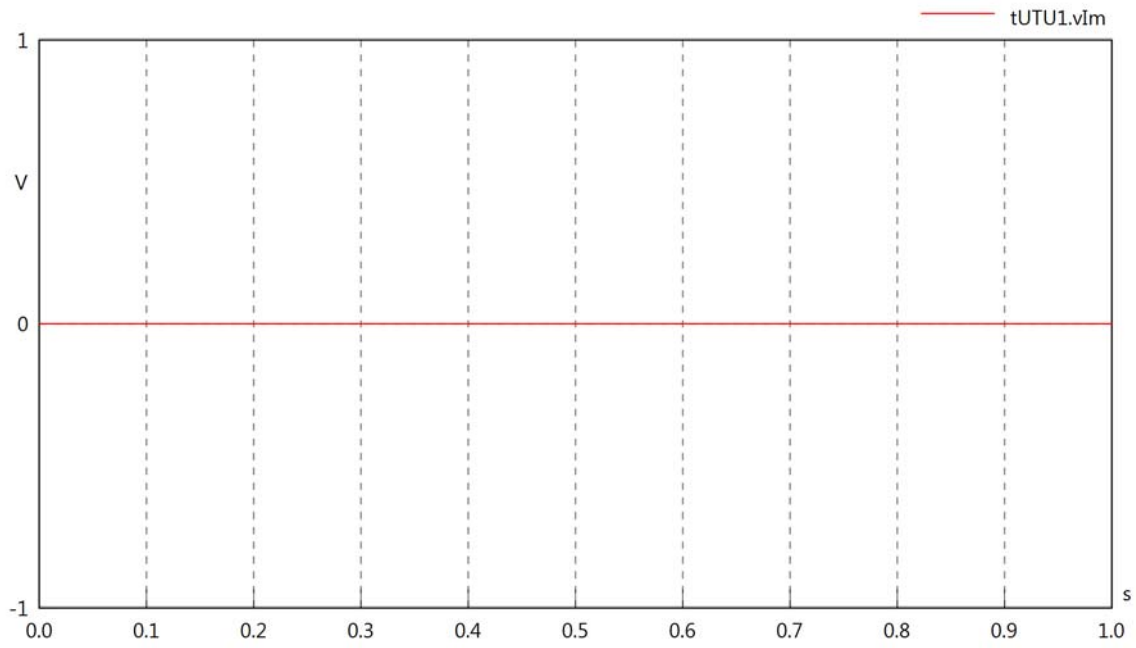

tUTU1.IrmsIn

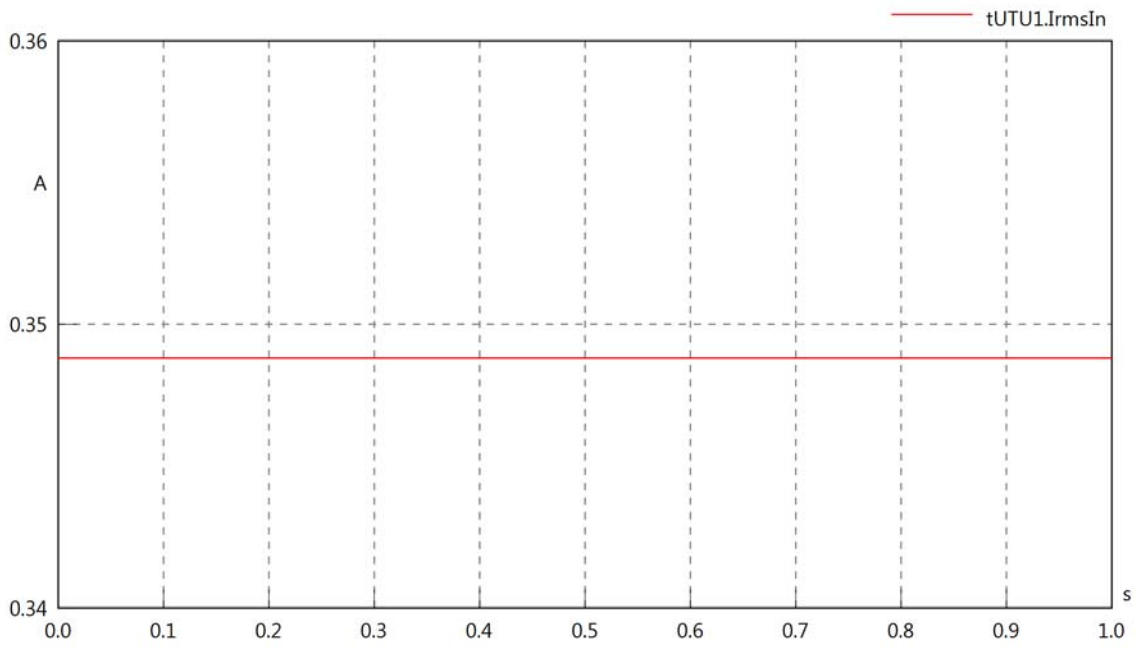

tUTU1.iReIn

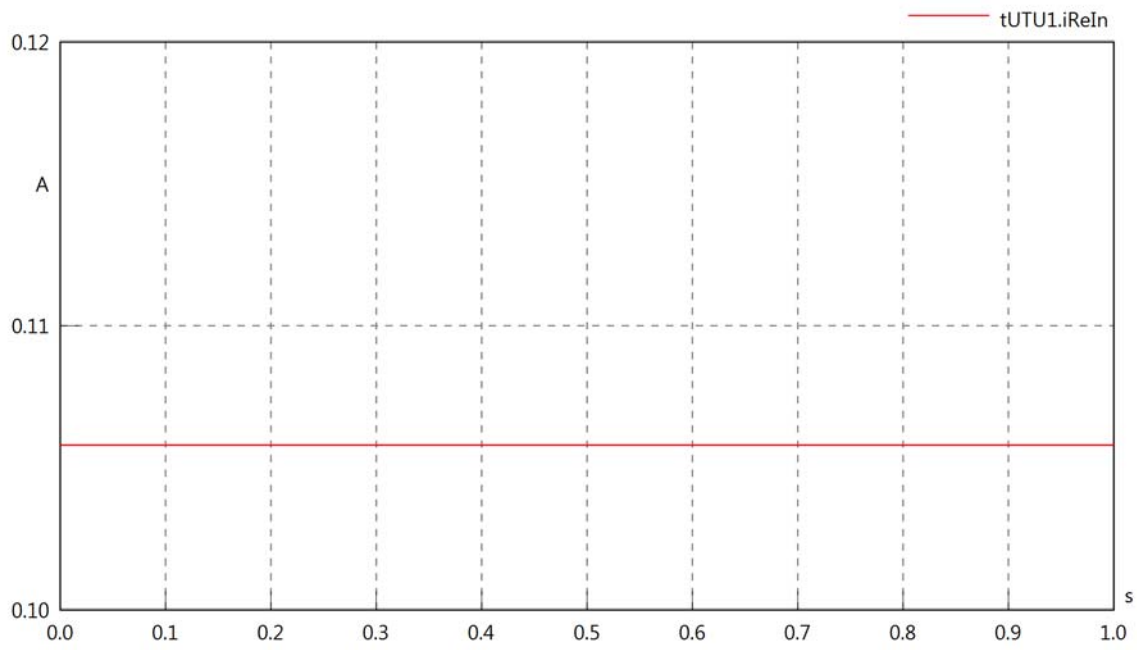

tUTU1.iImIn

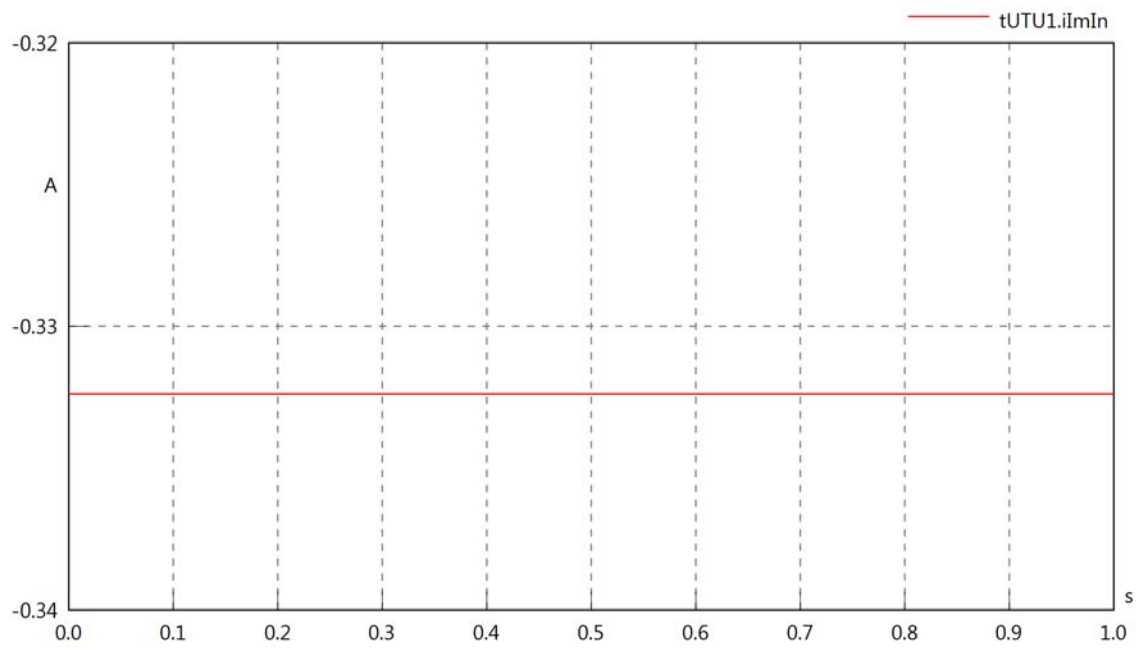

tUTU1.IrmsOut

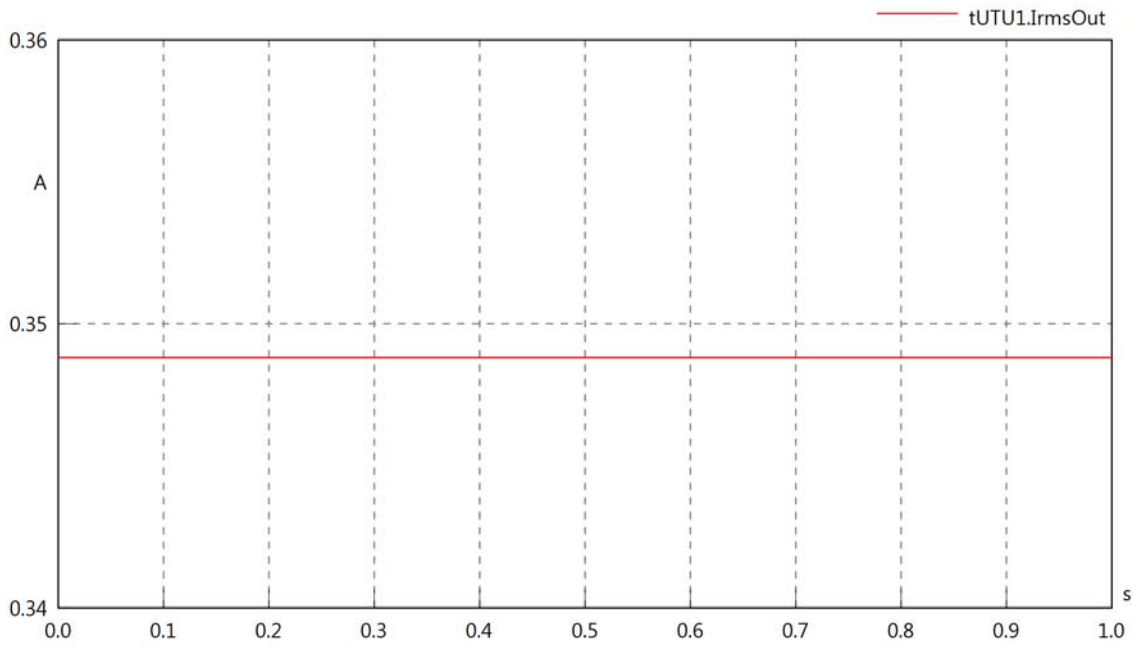

tUTU1.iReOut

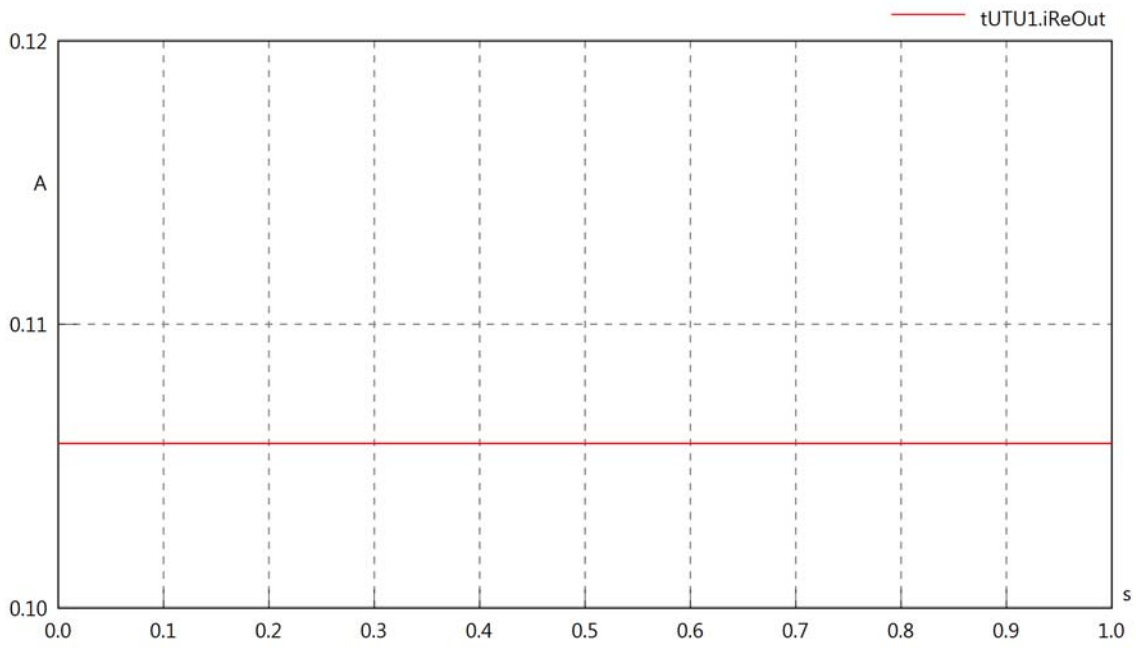

tUTU1.iImOut

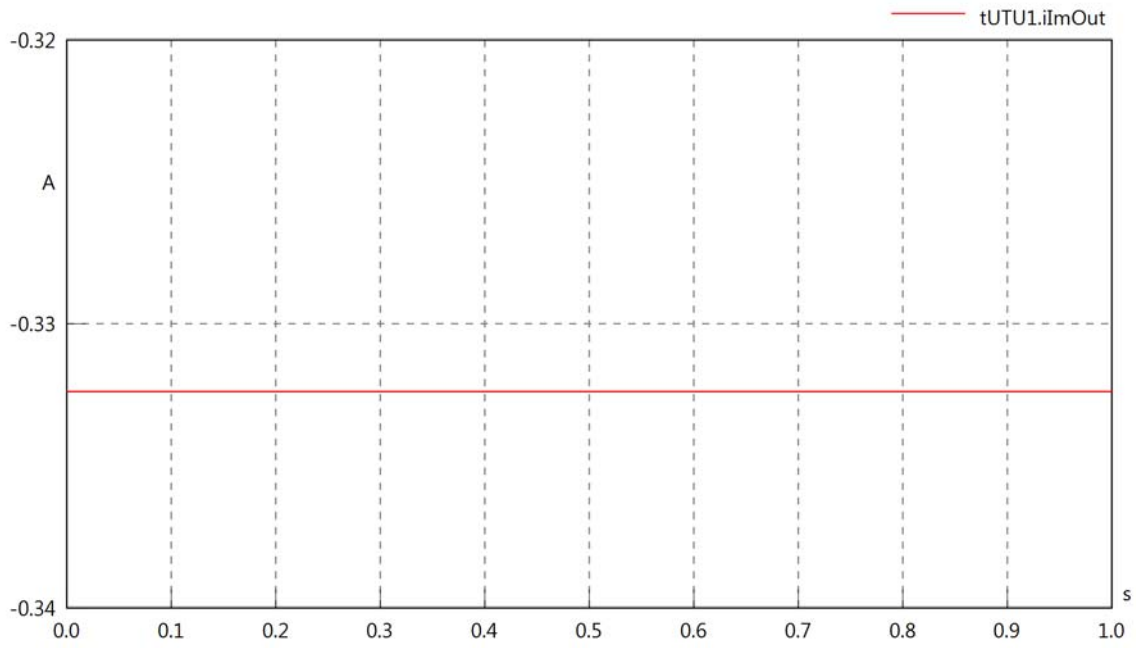

tUTU1.phiVIn

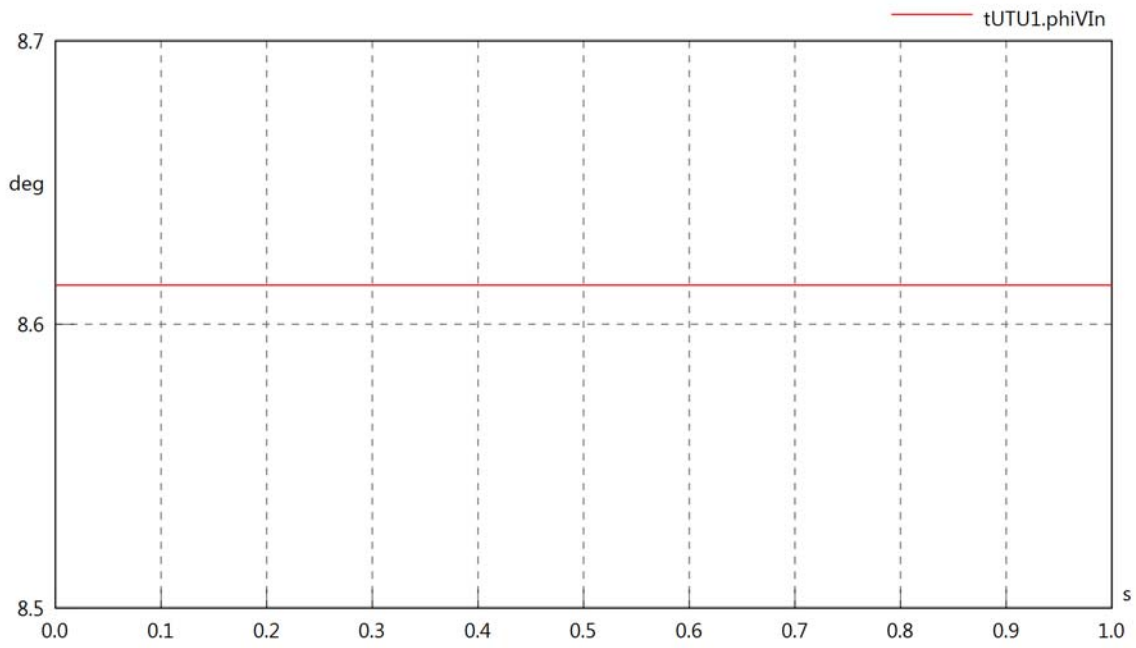

tUTU1.phiIIIn

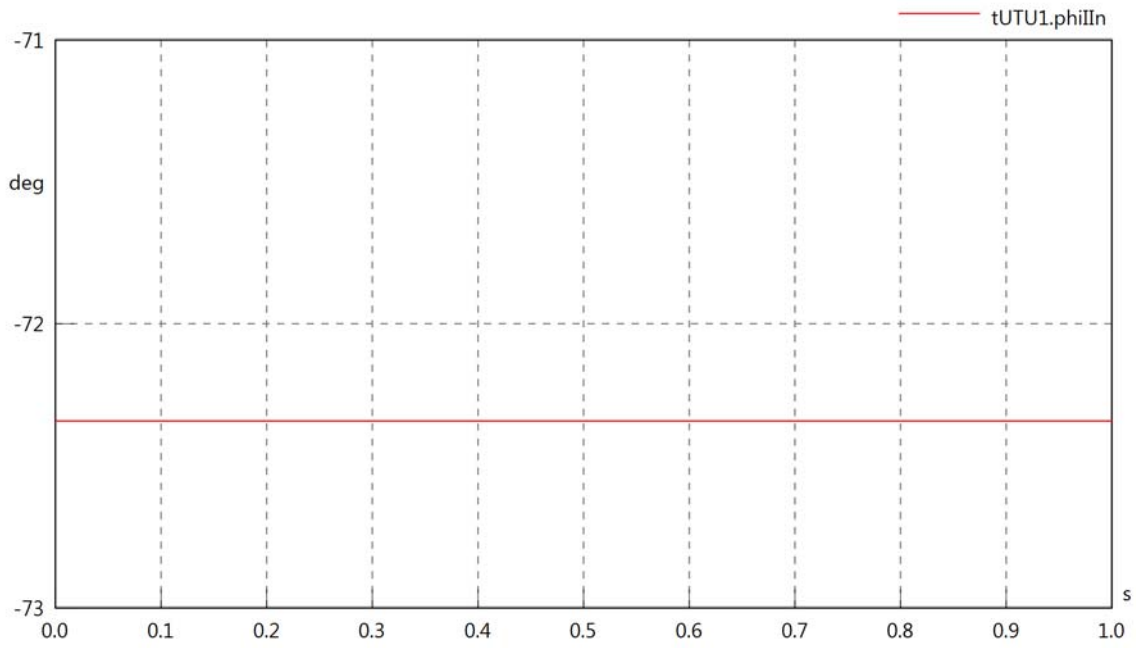

tUTU1.phiIVIn

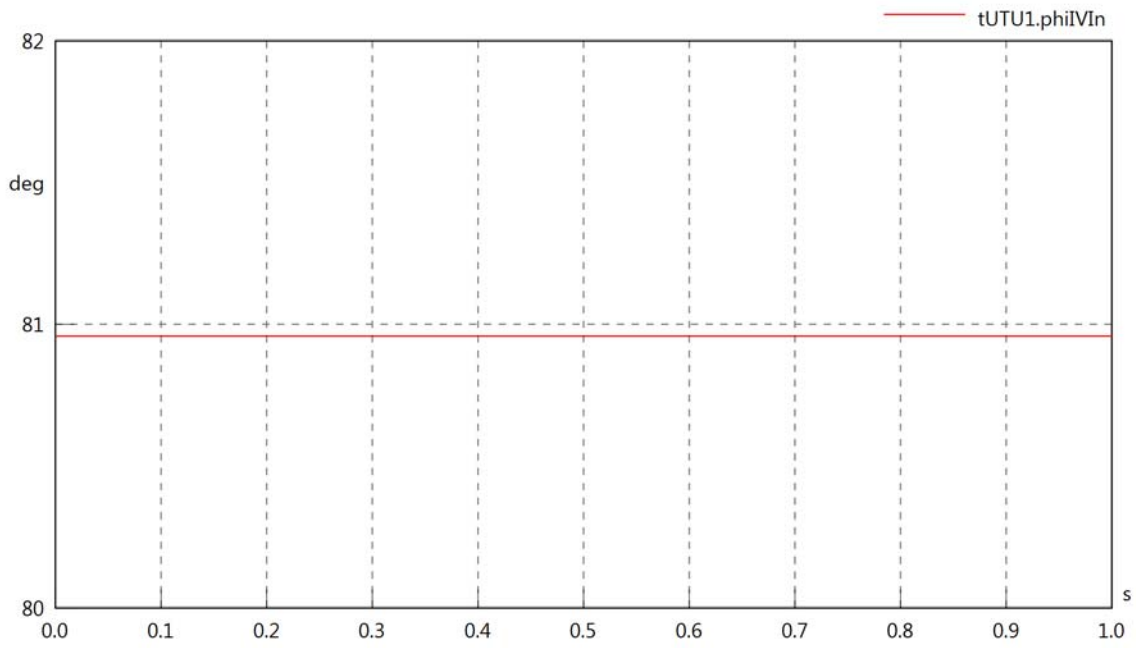

tUTU1.phiVOut

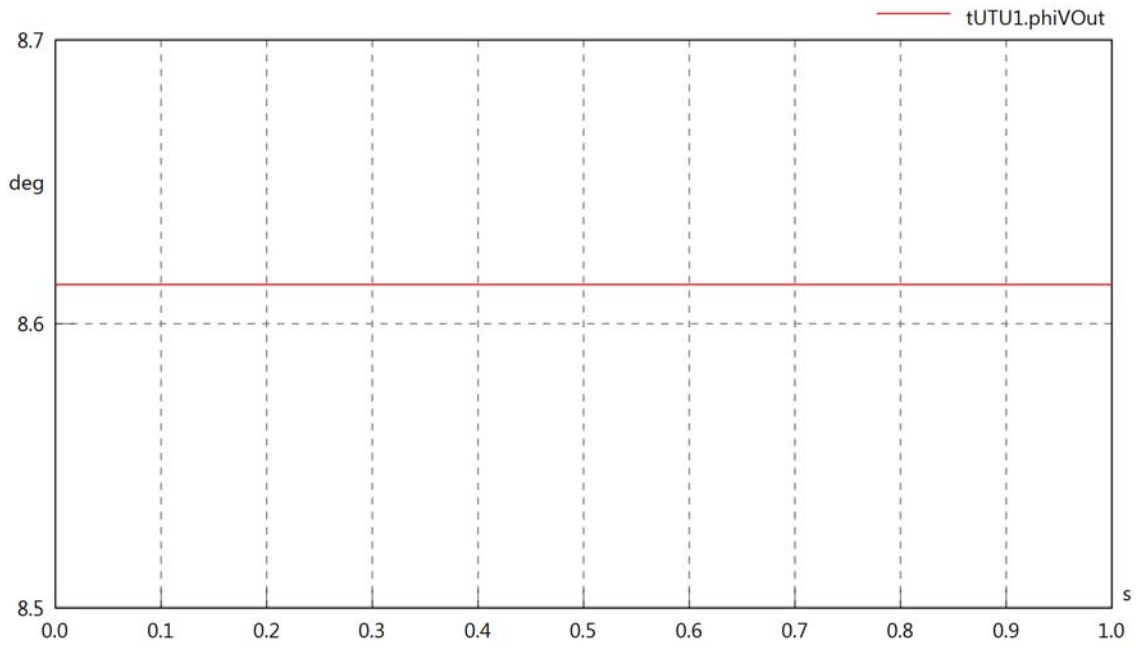

tUTU1.phiIOut

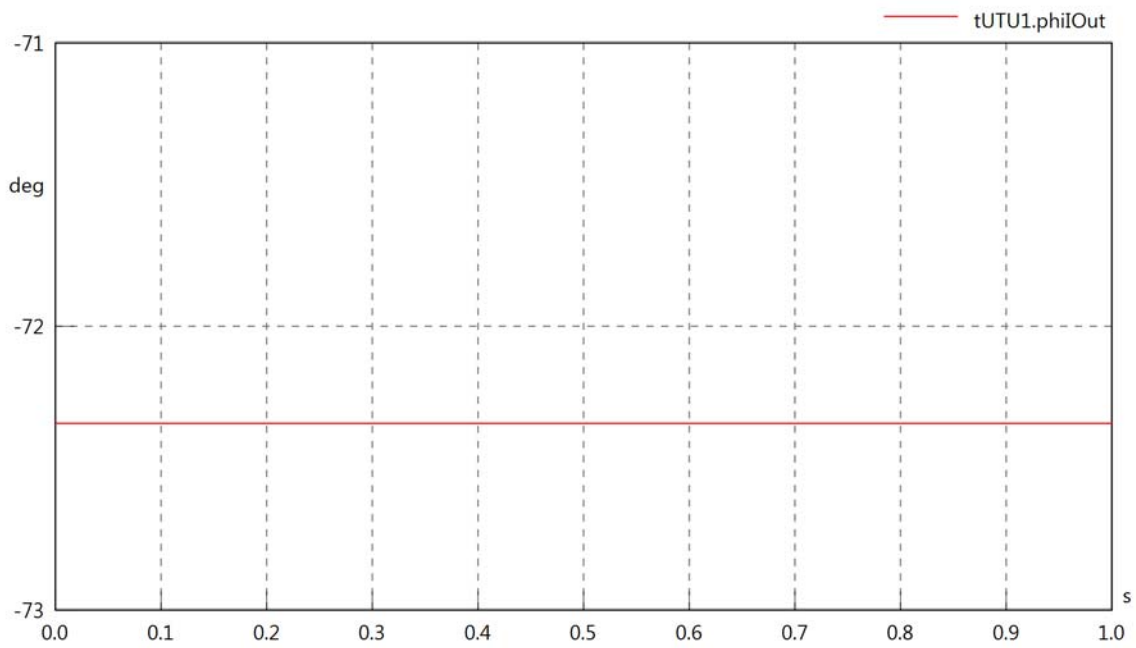

tUTU1.phiIVOut

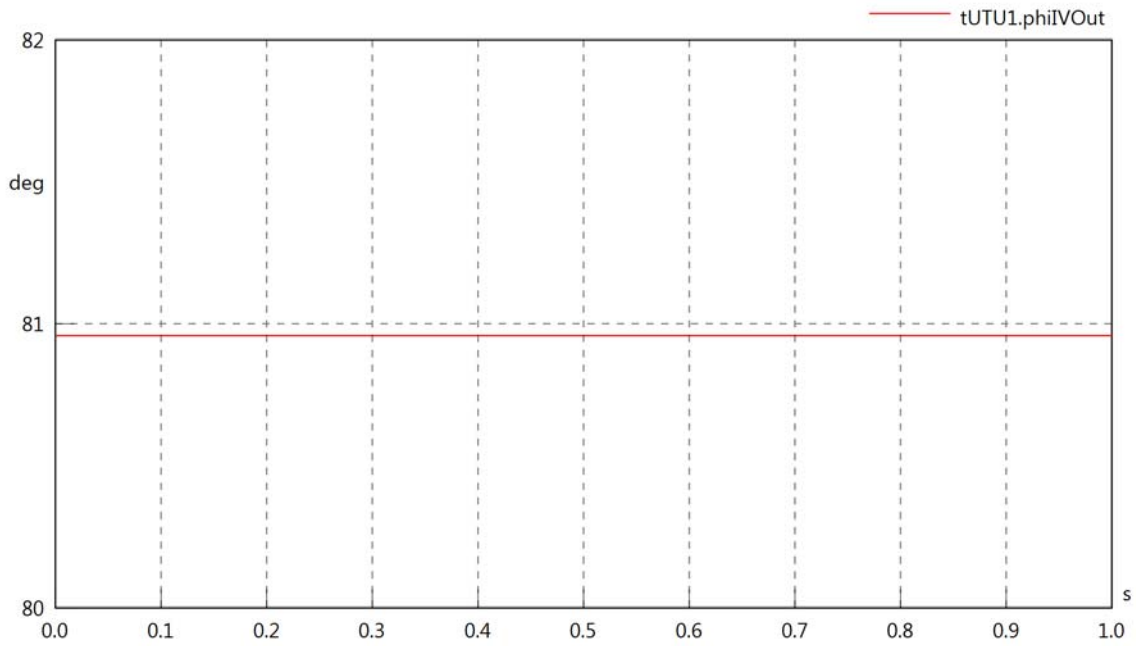

tUTU1.PReIn

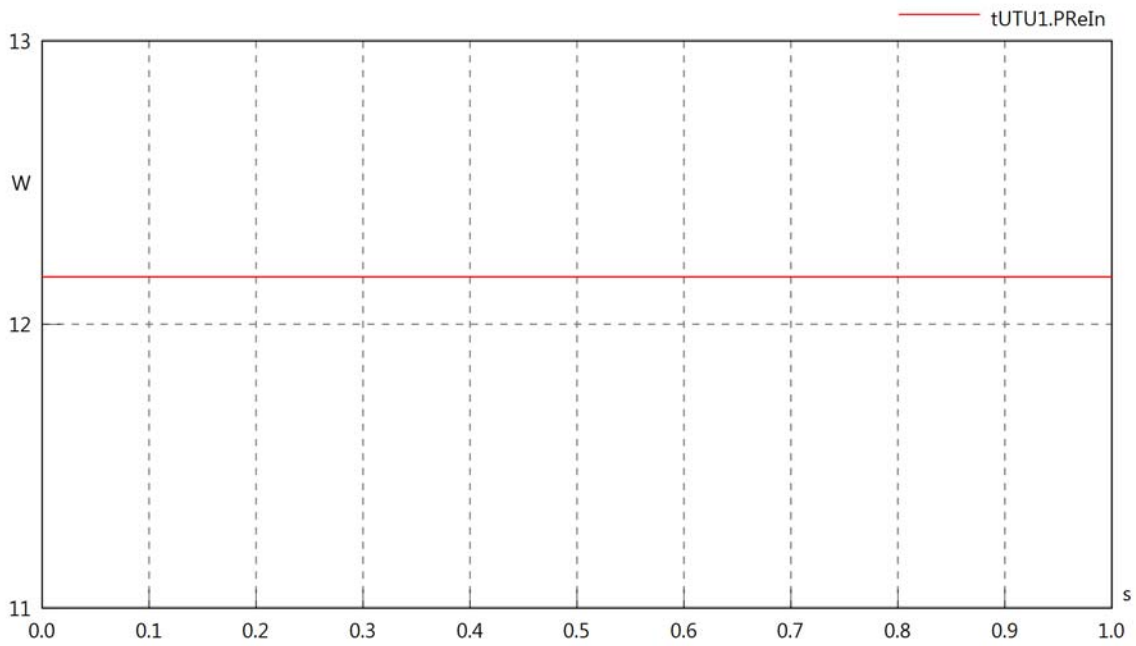

tUTU1.PImIn

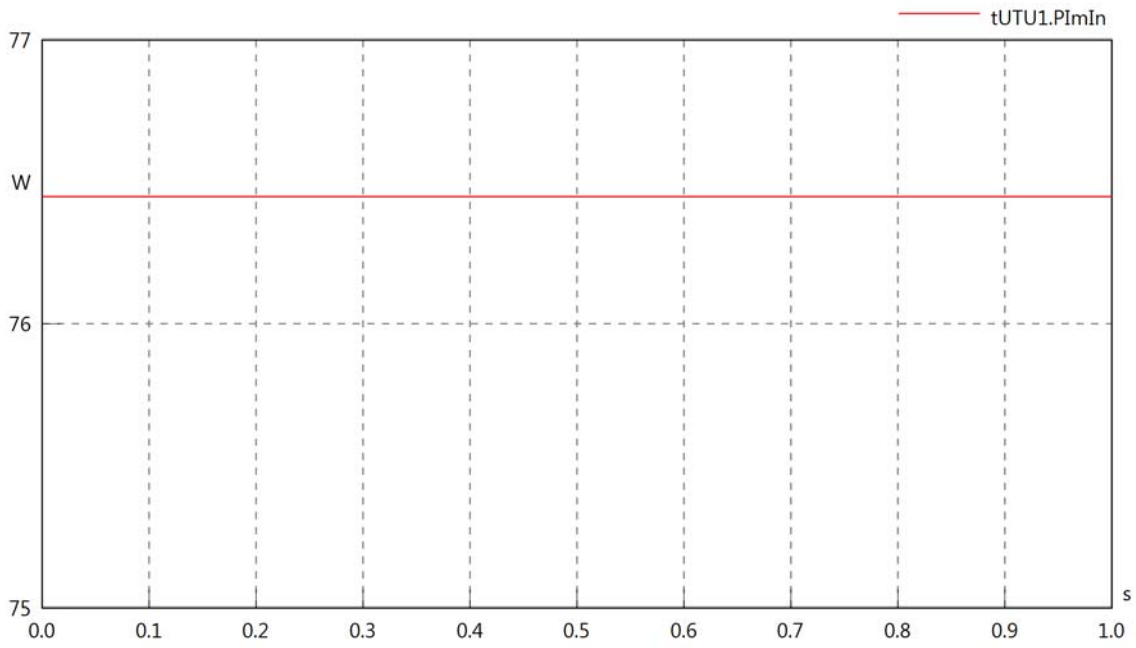

tUTU1.SIn

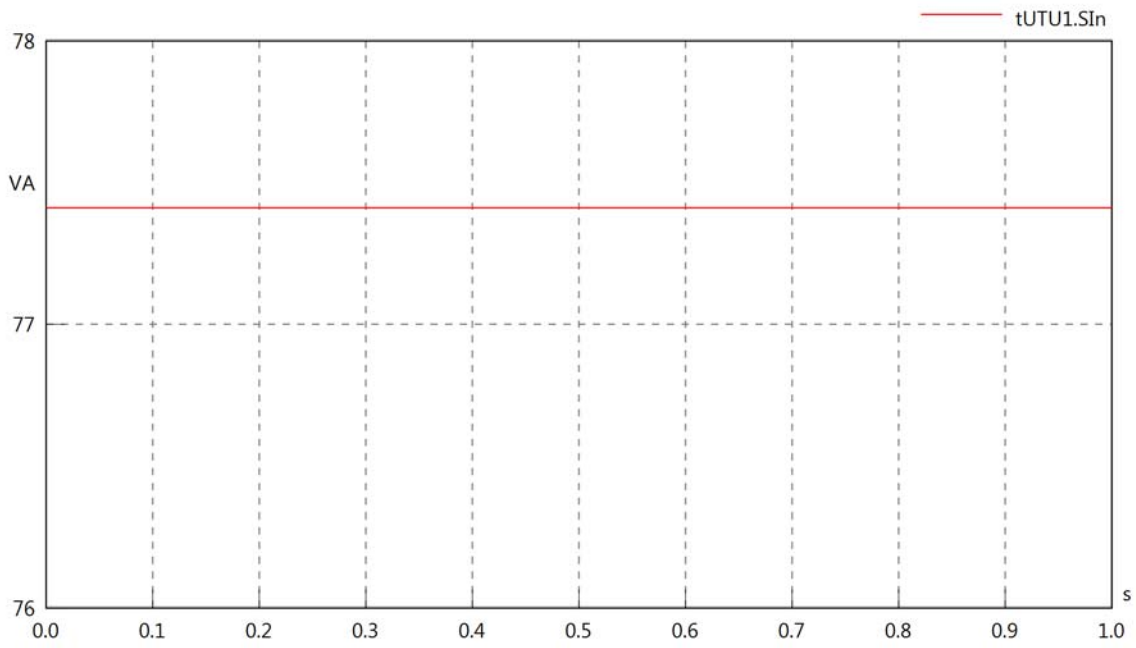

tUTU1.PReOut

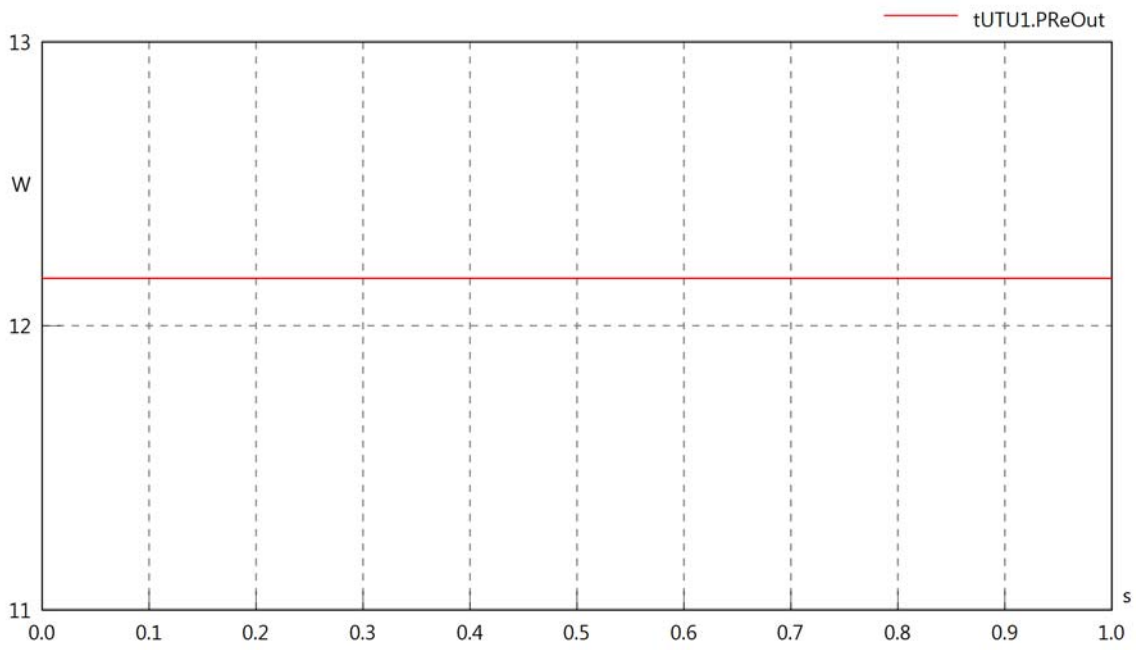

tUTU1.PImOut

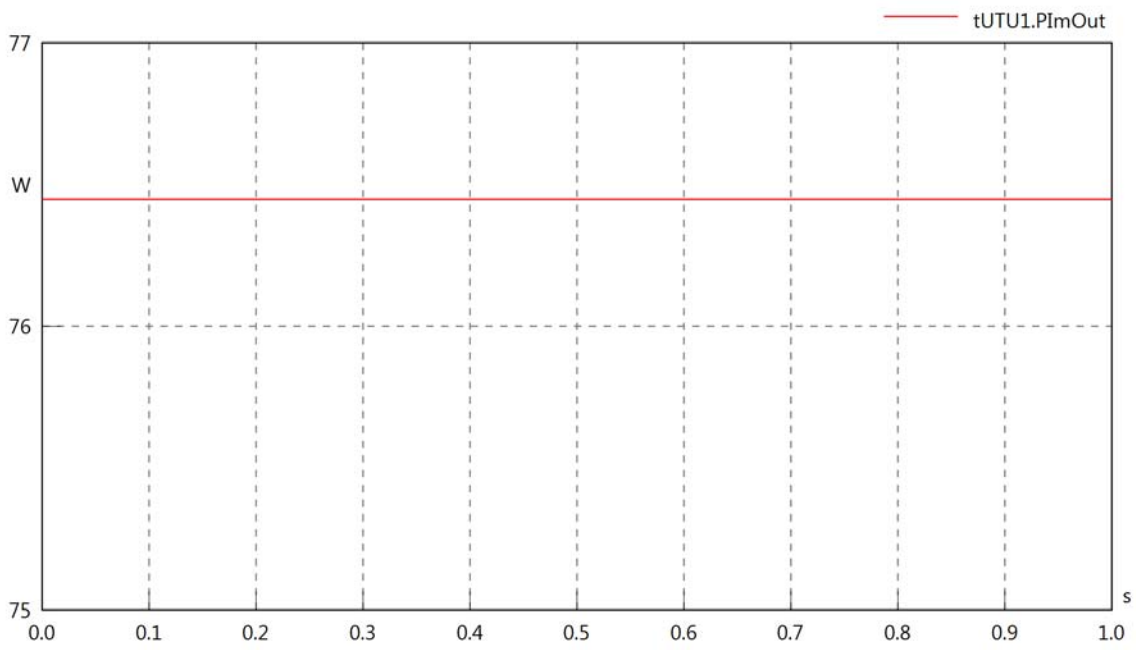

tUTU1.SOut

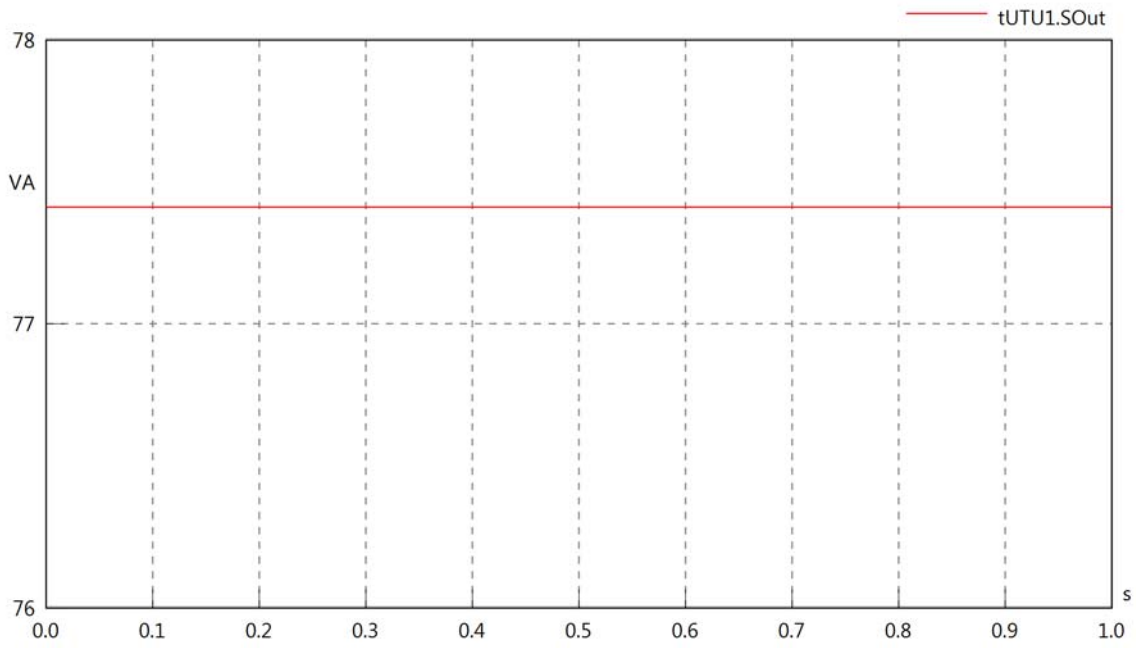
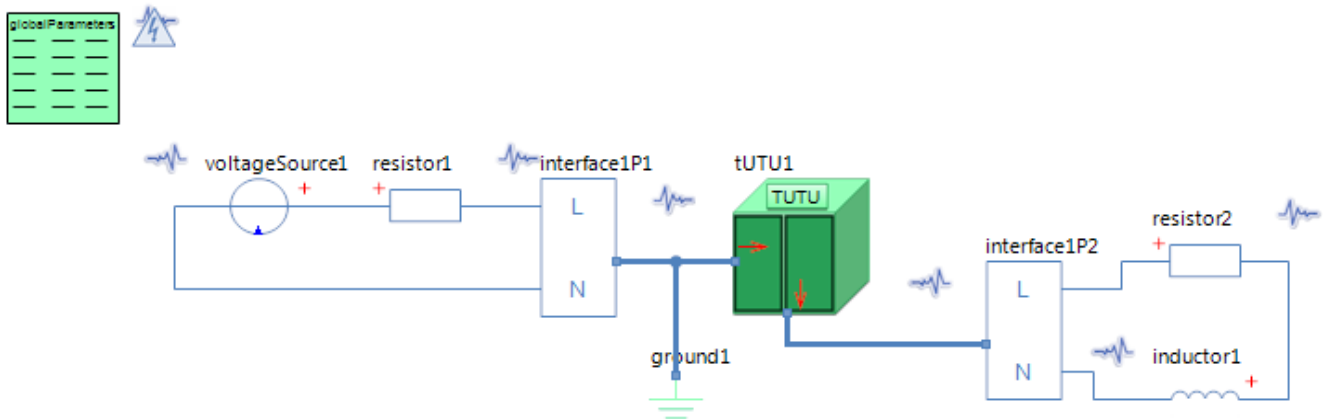

Diagram View



GlobalParameters globalParameters
Parameters

Comment	Name	Current Value	Unit
Type of Calculation	eCalculationKind	Signal Calculation	
Description of Frequency	eFrequencyKind	Linear	
Minimum Frequency	fMin	60	[Hz]
Maximum Frequency	fMax	60	[Hz]

Voltage Source voltageSource1
Parameters

Comment	Name	Current Value	Unit
Voltage RMS	VrmsSrc	230	[V]
Phase	phi	0	[deg]

Resistor resistor1
Parameters

Comment	Name	Current Value	Unit
Resistance	R	100	[Ohm]

Resistor resistor2
Parameters

Comment	Name	Current Value	Unit
Resistance	R	100	[Ohm]

Inductor inductor1
Parameters

Comment	Name	Current Value	Unit
Inductance	L	5	[mH]

Topside Umbilical Termination Unit tUTU1
Parameters

Comment	Name	Current Value	Unit
Poor or failing L1 connection	bL1	true	
Resistance in L1 connection	rL1	1	[kOhm]
Conductance between L1 and N	G	50	[1/Ohm]

tUTU1.VrmsIn

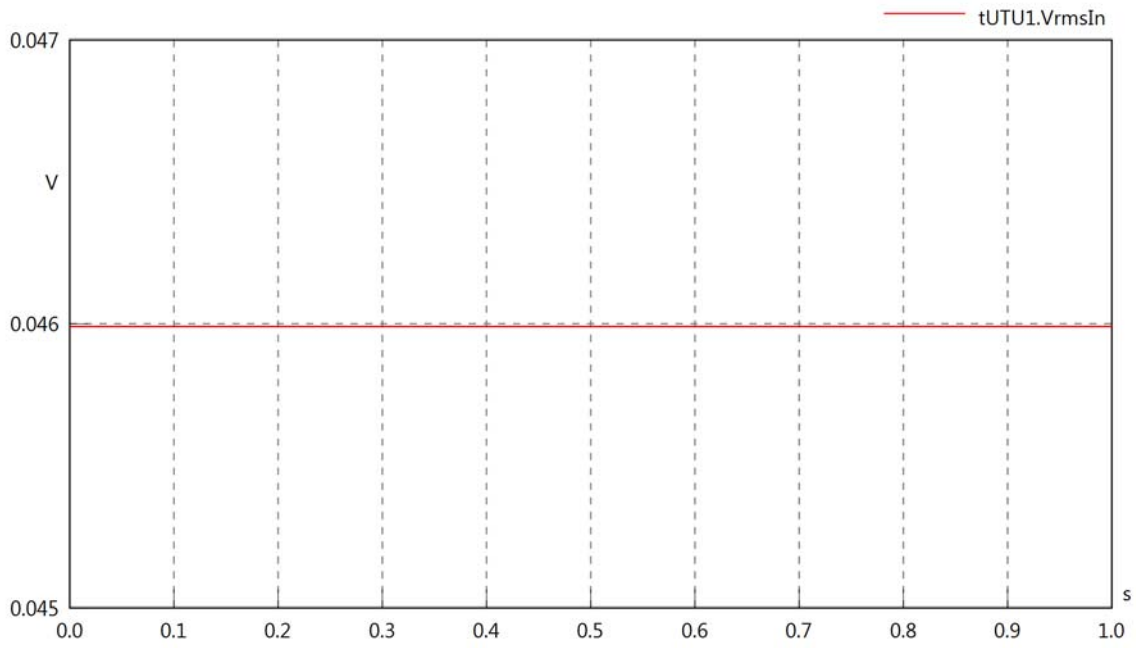

tUTU1.vReIn

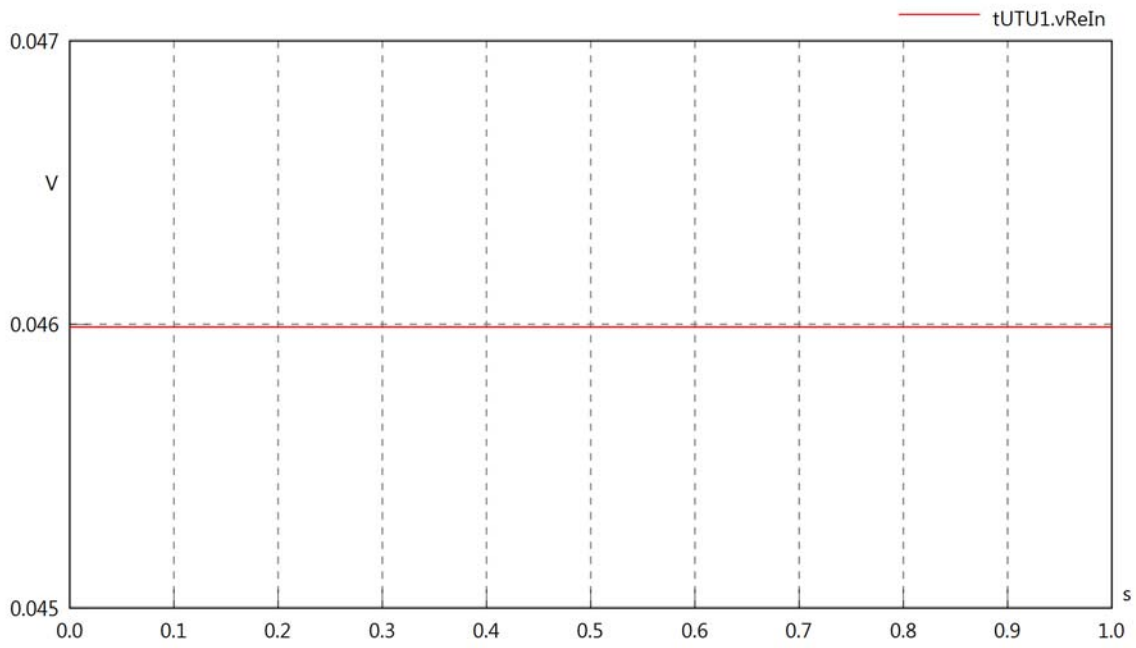

tUTU1.vImIn

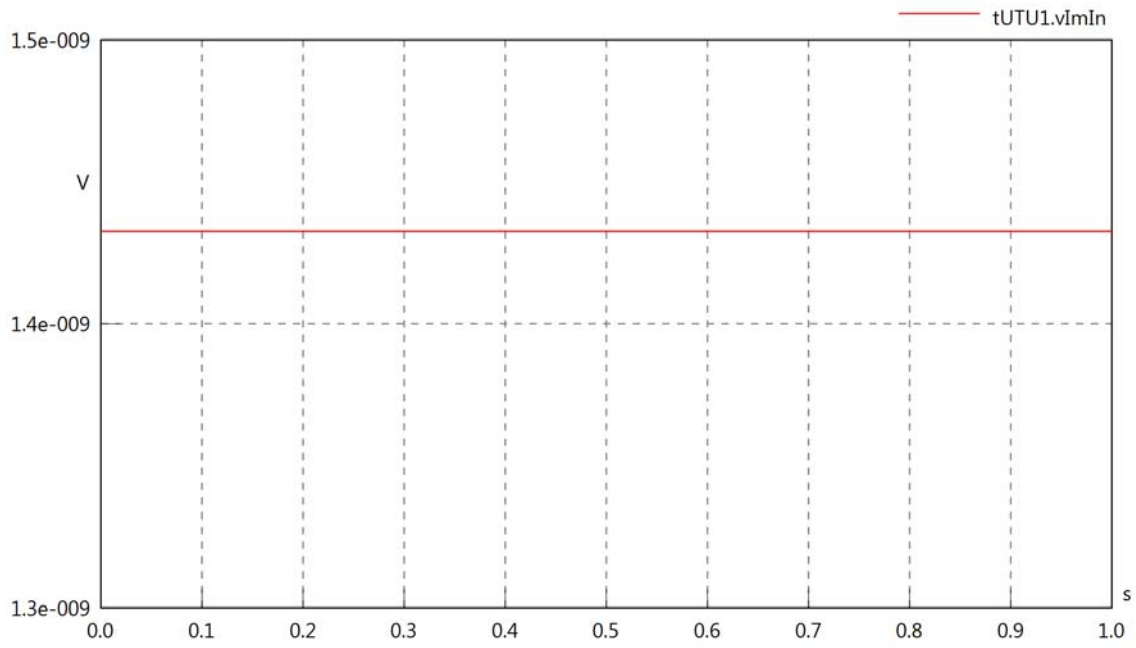

tUTU1.VrmsOut

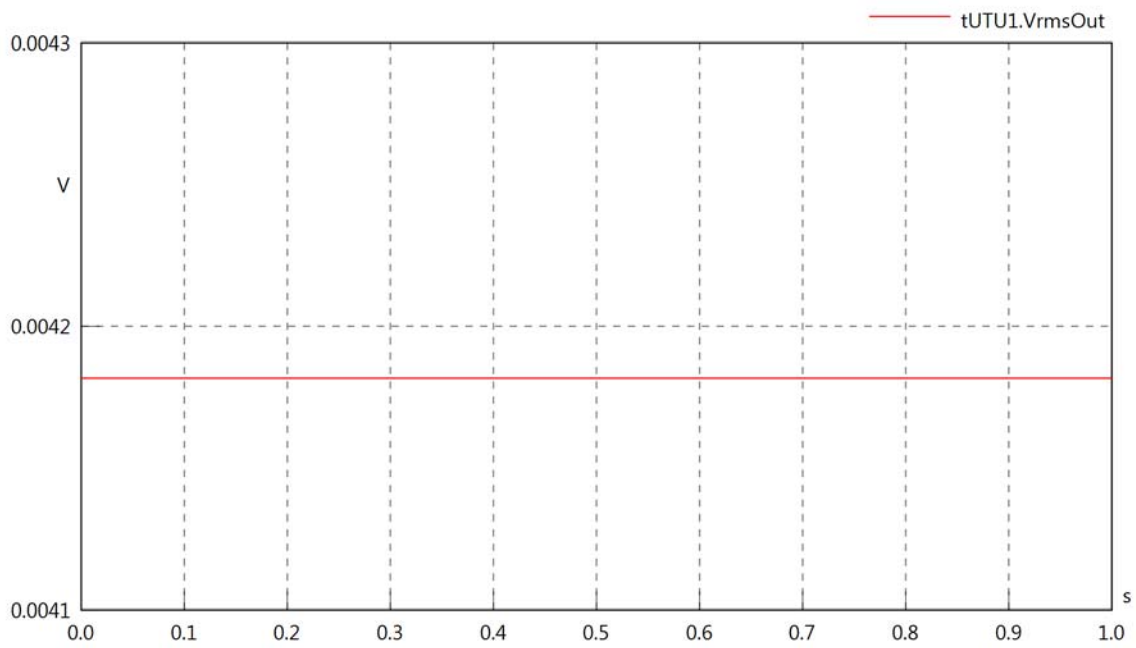

tUTU1.vReOut

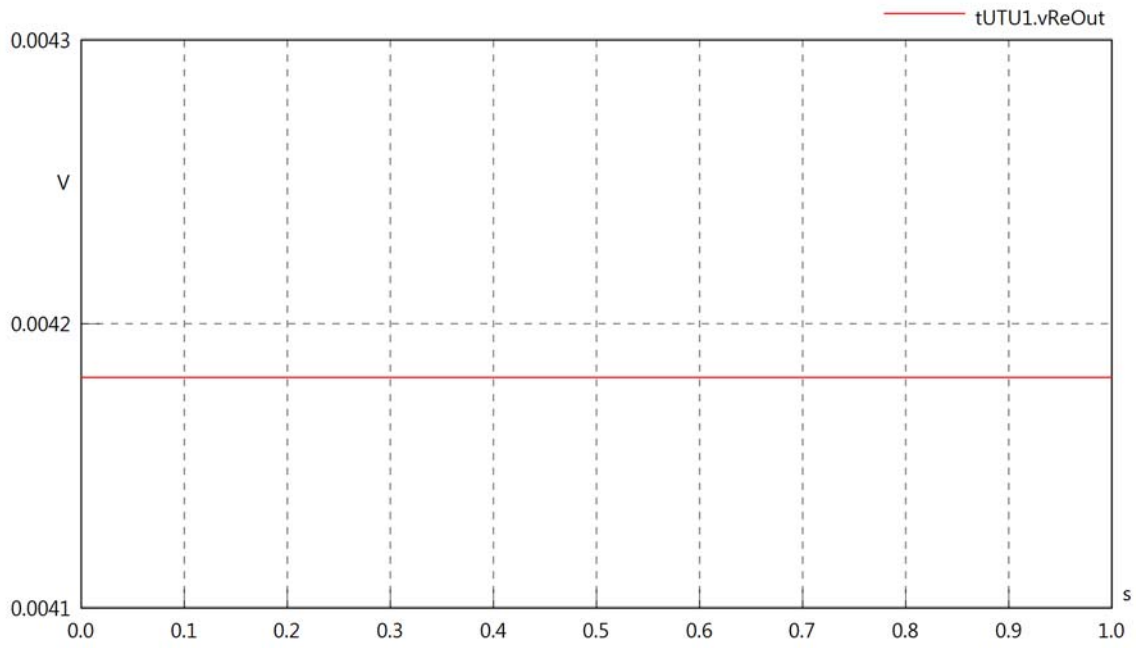

tUTU1.vImOut

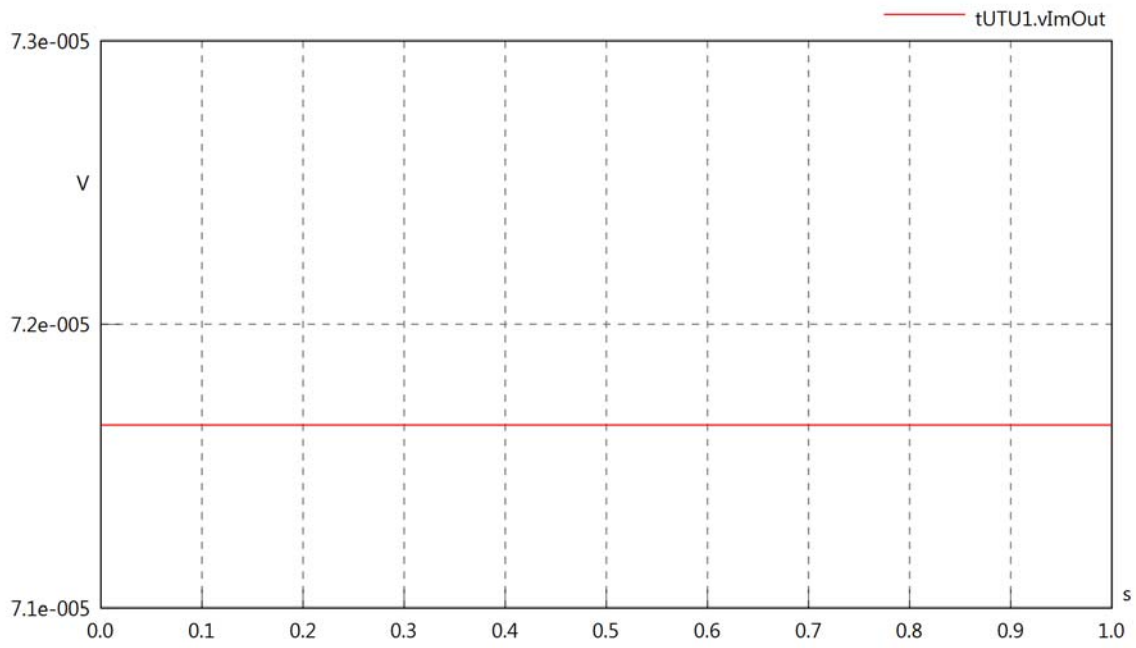

tUTU1.Vrms

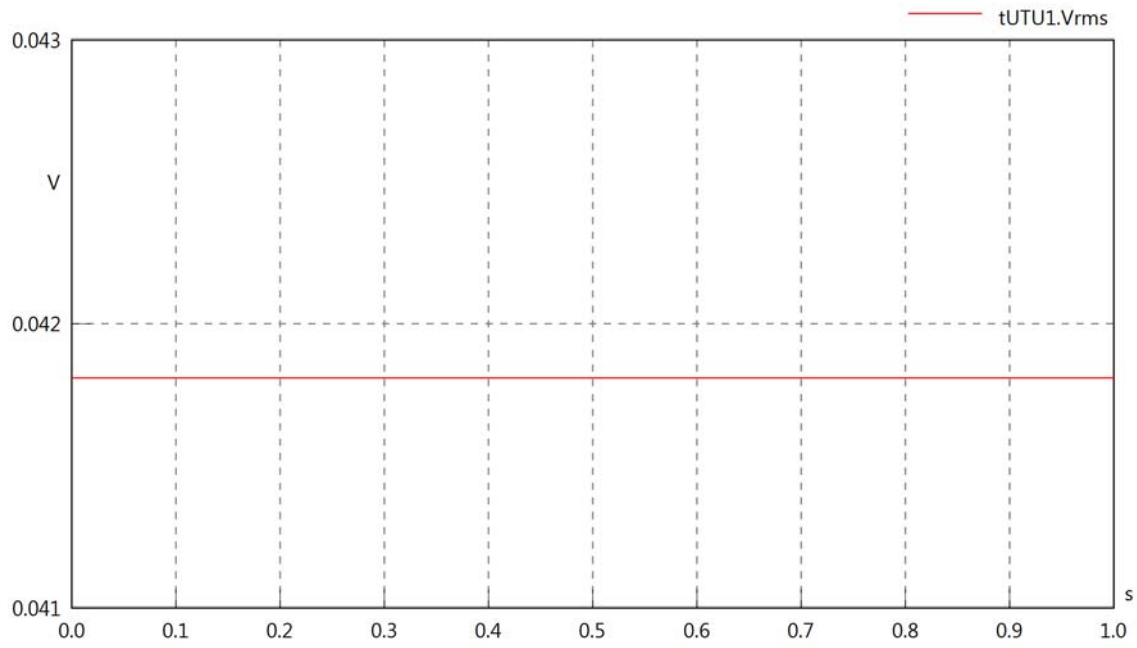

tUTU1.vRe

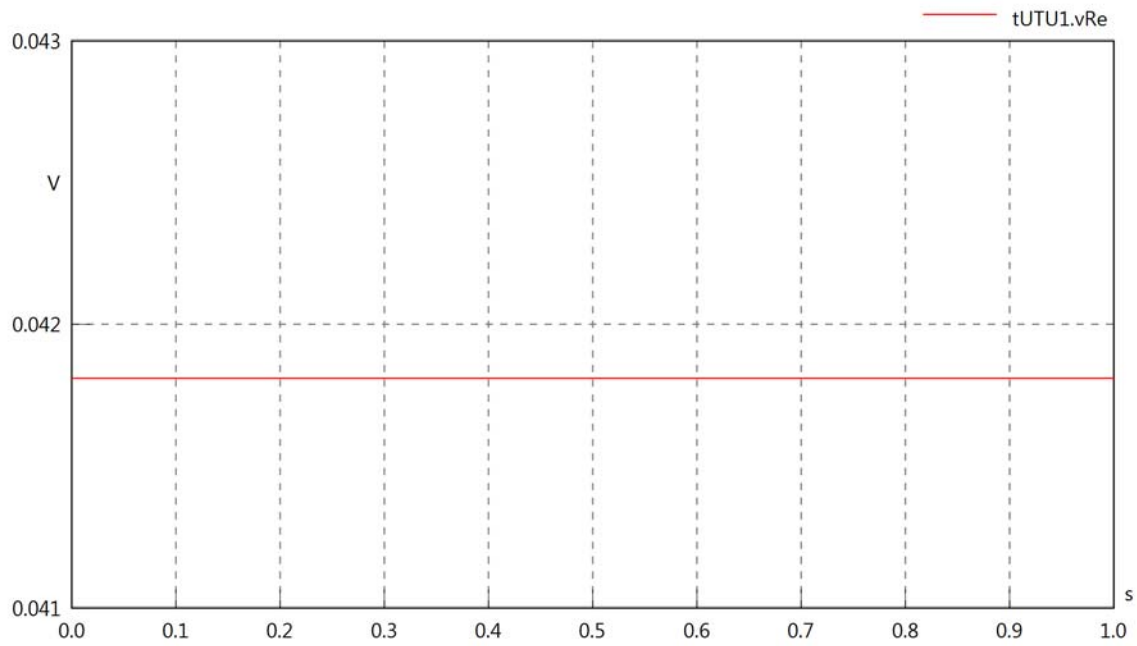

tUTU1.vIm

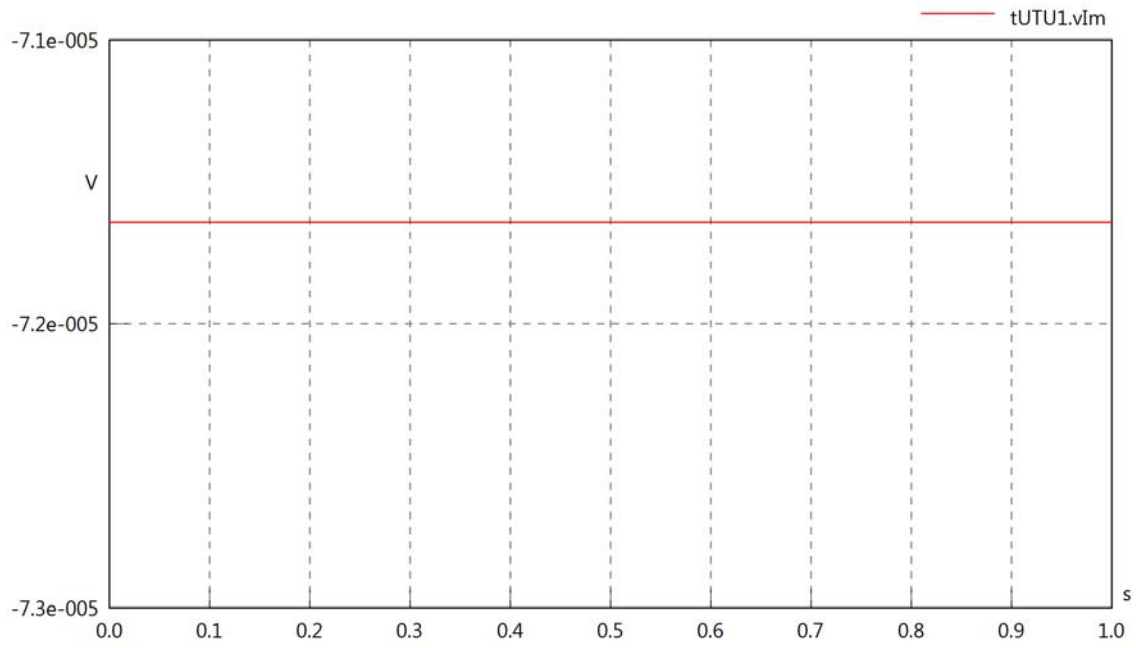

tUTU1.IrmsIn

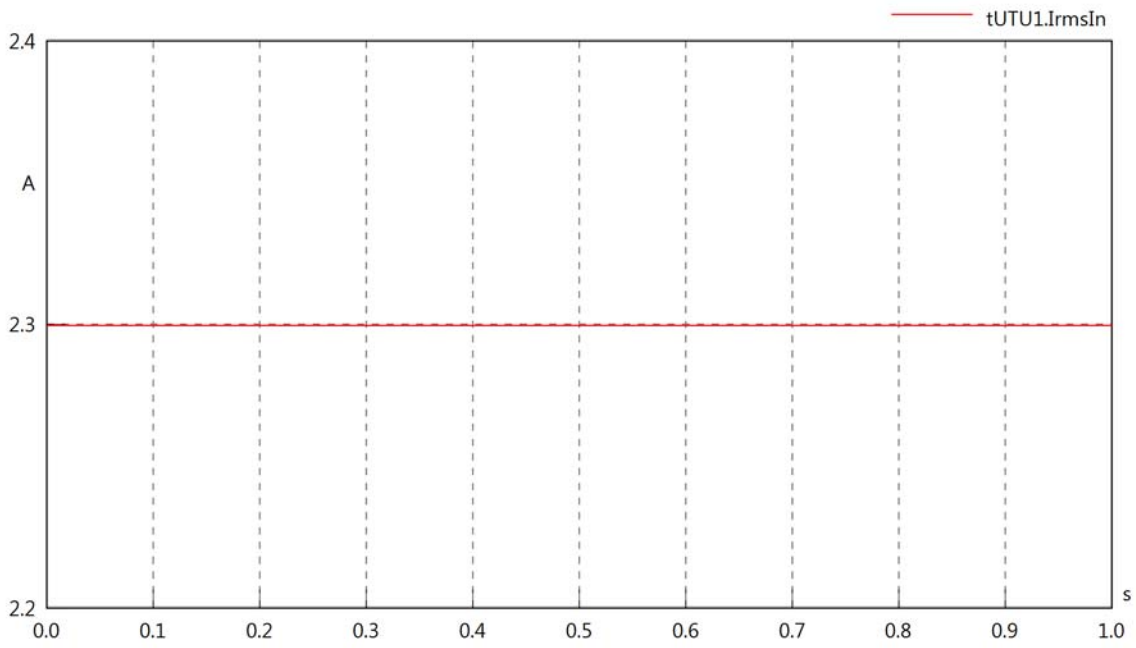

tUTU1.iReIn

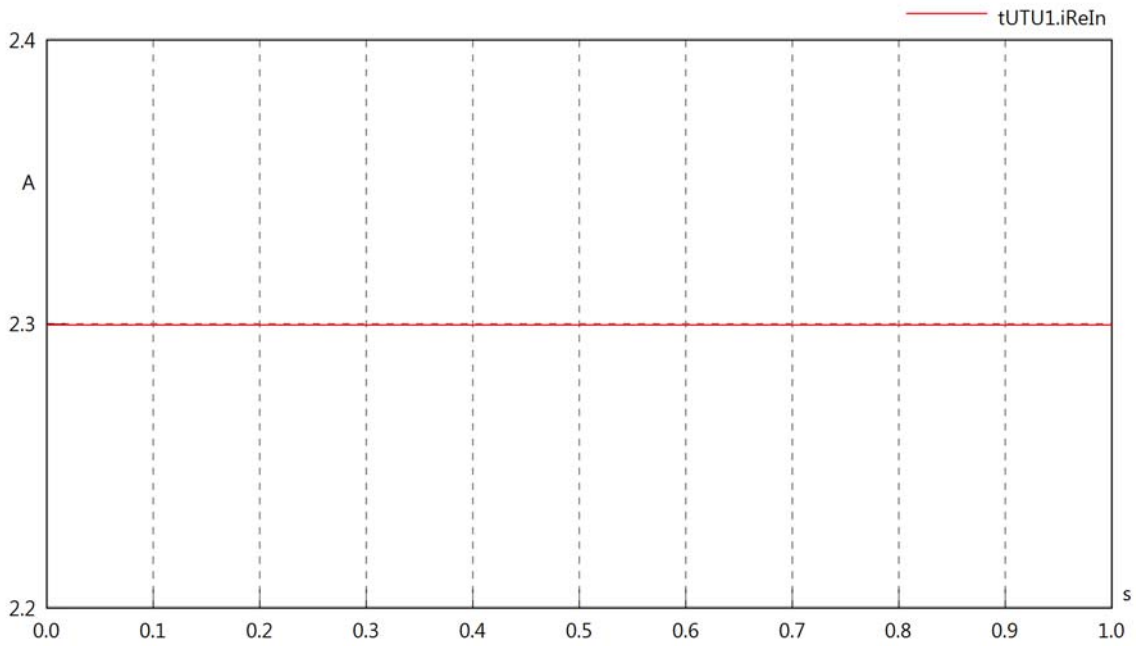

tUTU1.iImIn

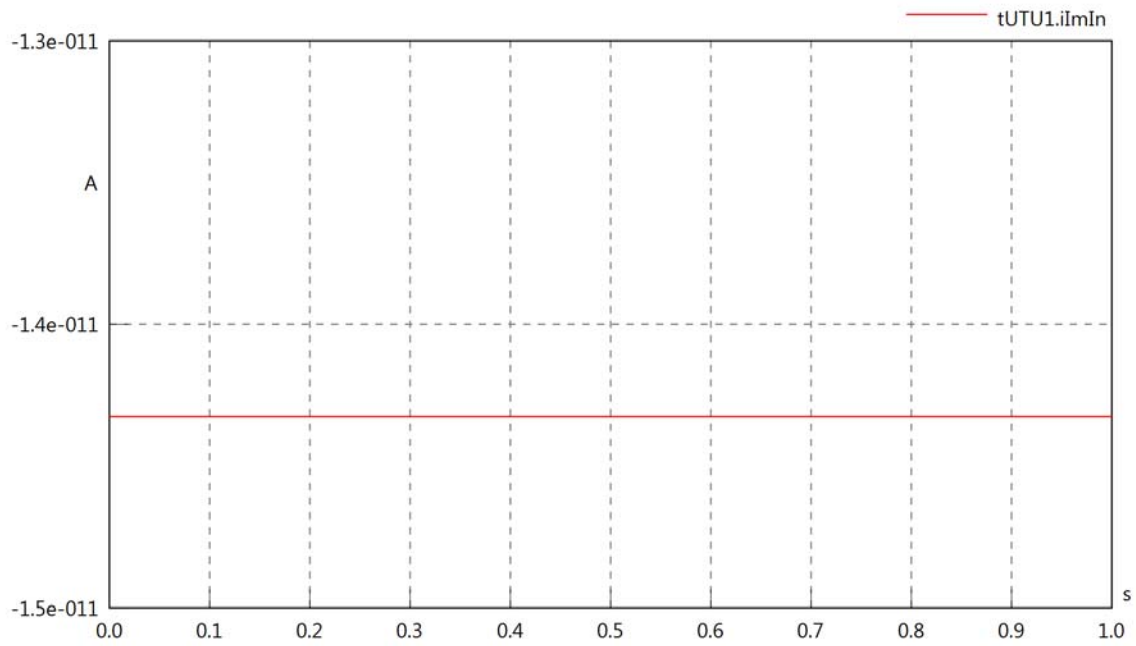

tUTU1.IrmsOut

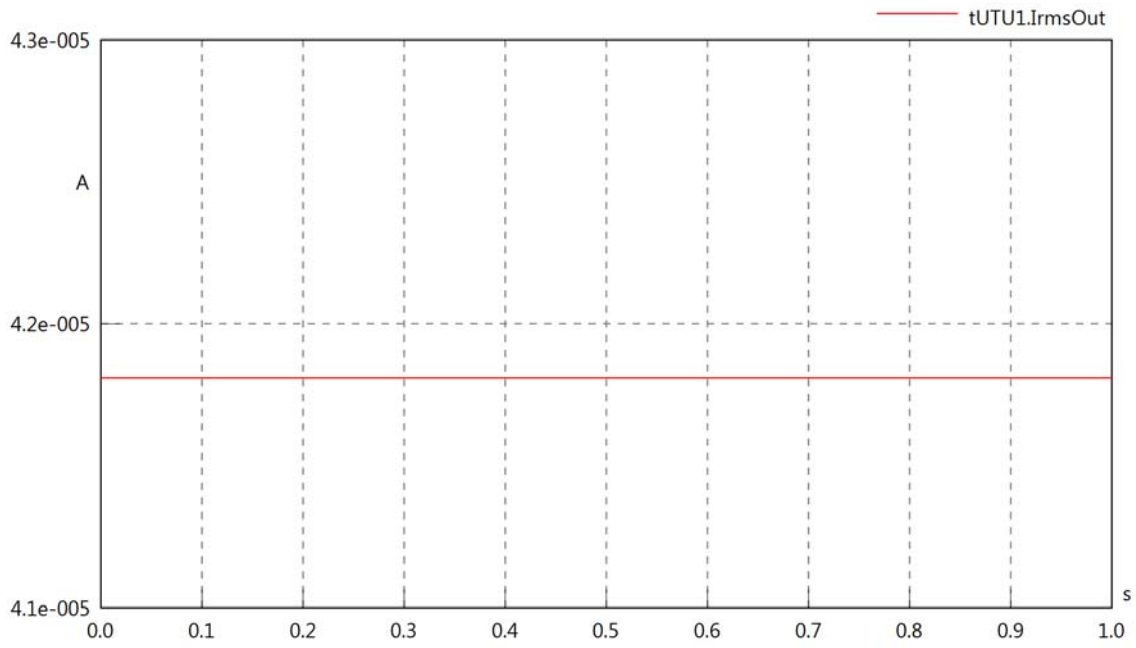

tUTU1.iReOut

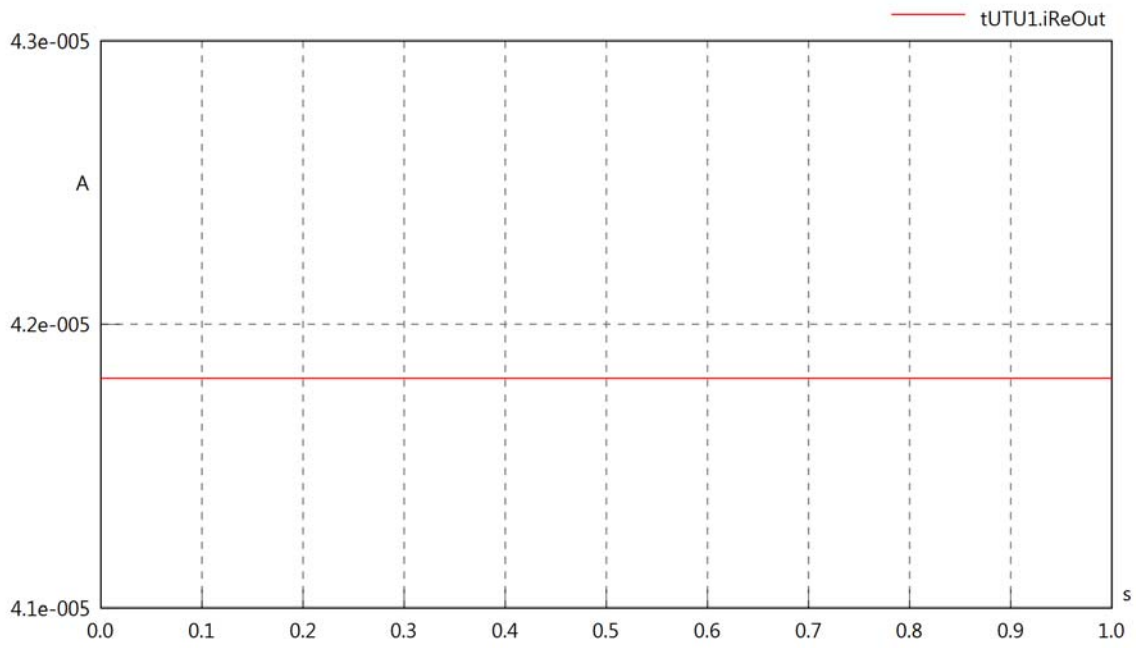

tUTU1.iImOut

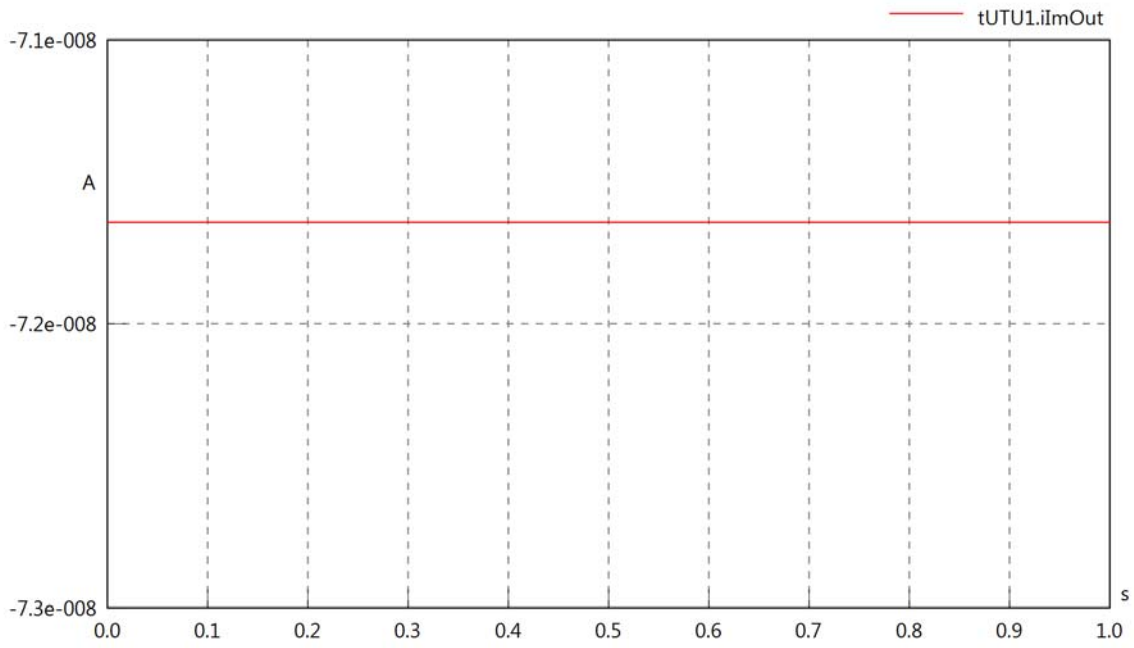

tUTU1.phiVIn

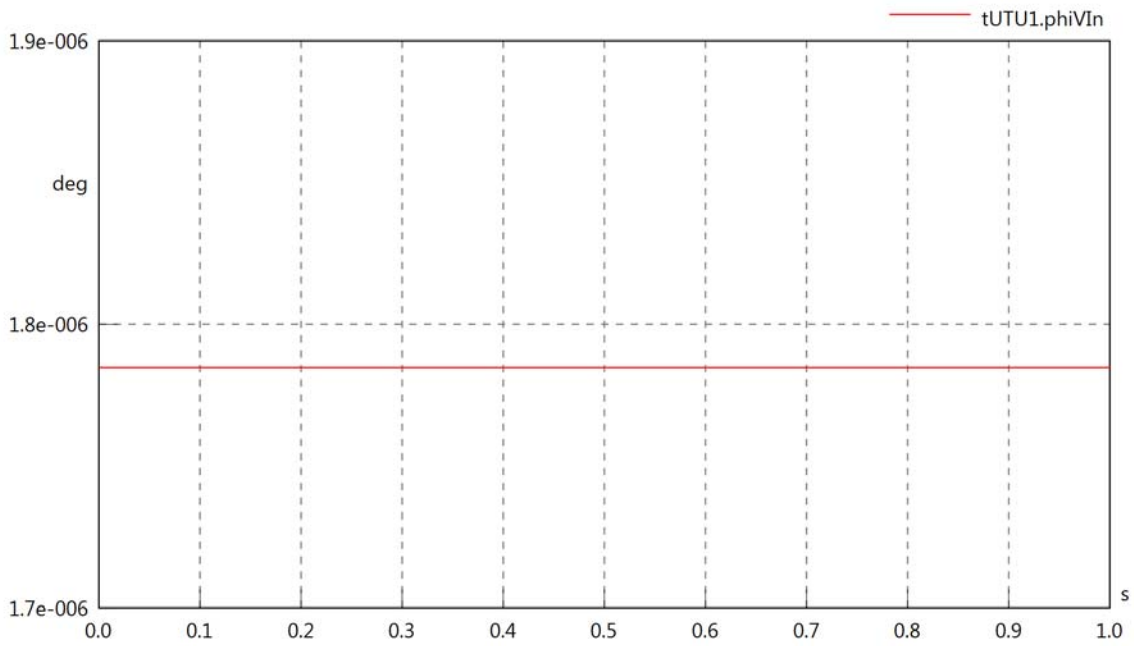

tUTU1.phiIIIn

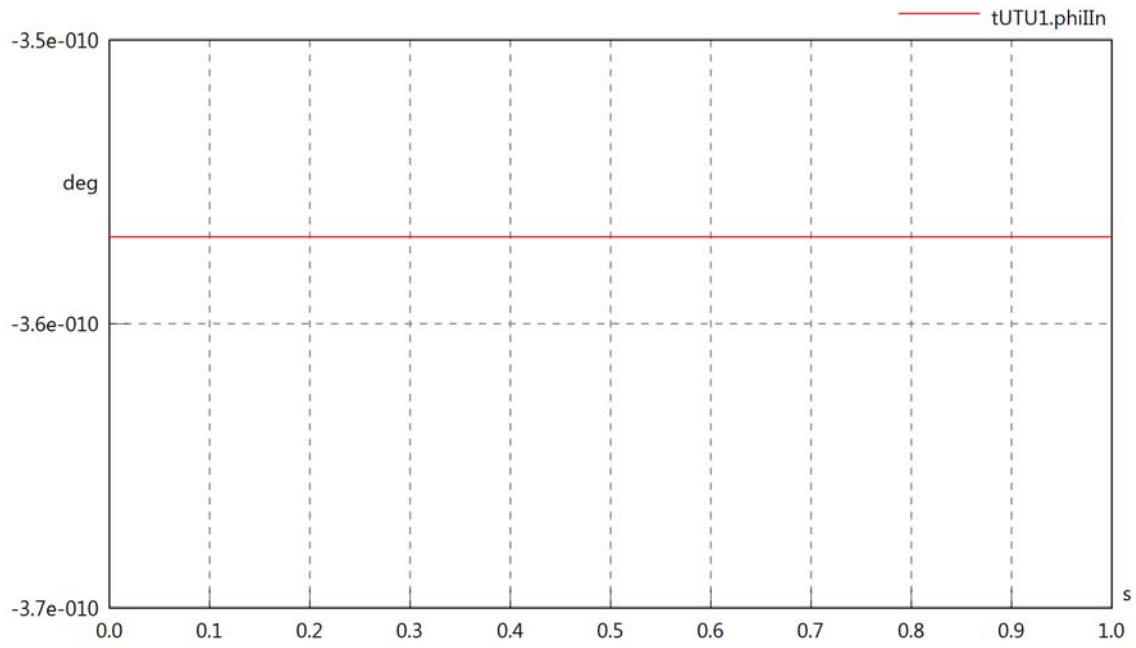

tUTU1.phiIVIn

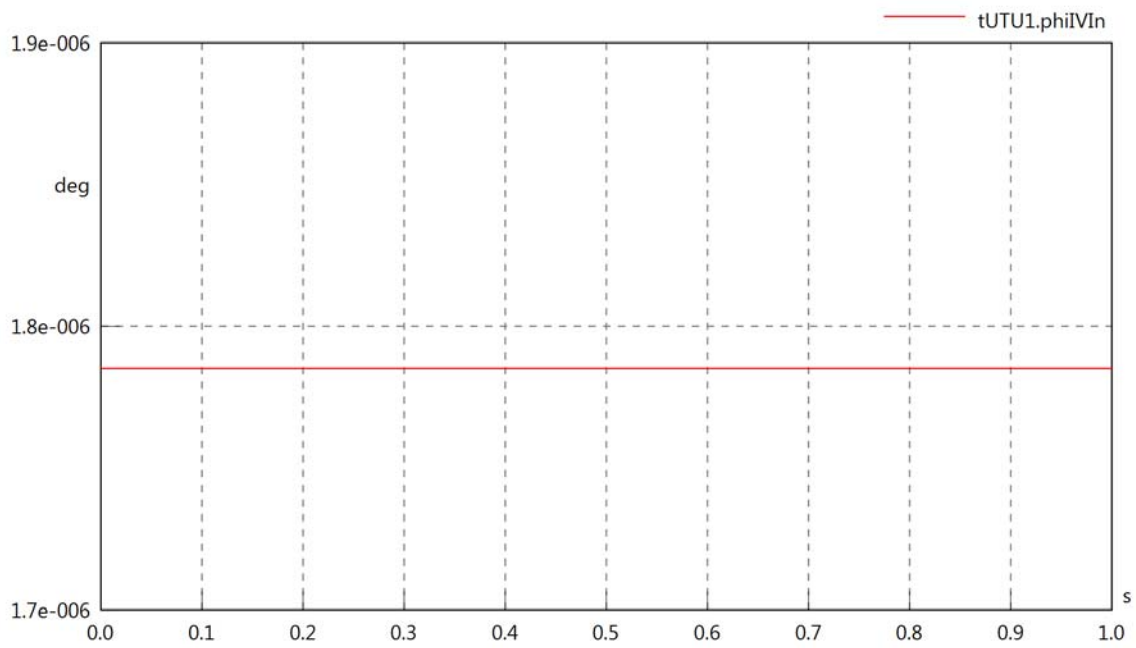

tUTU1.phiVOut

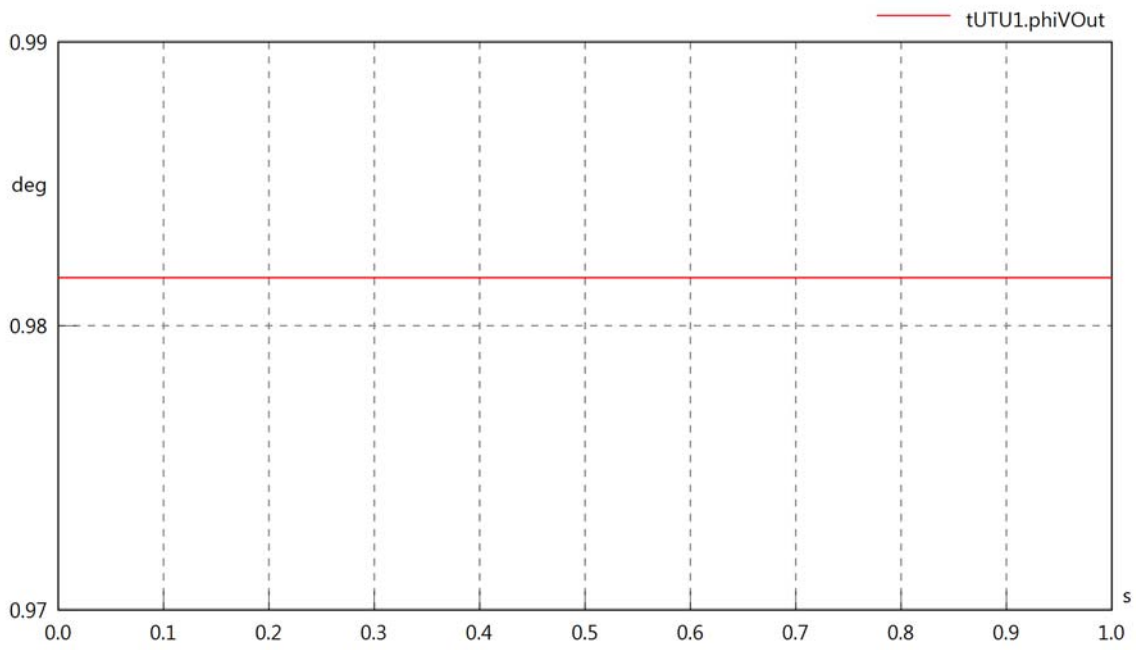

tUTU1.phiIOut

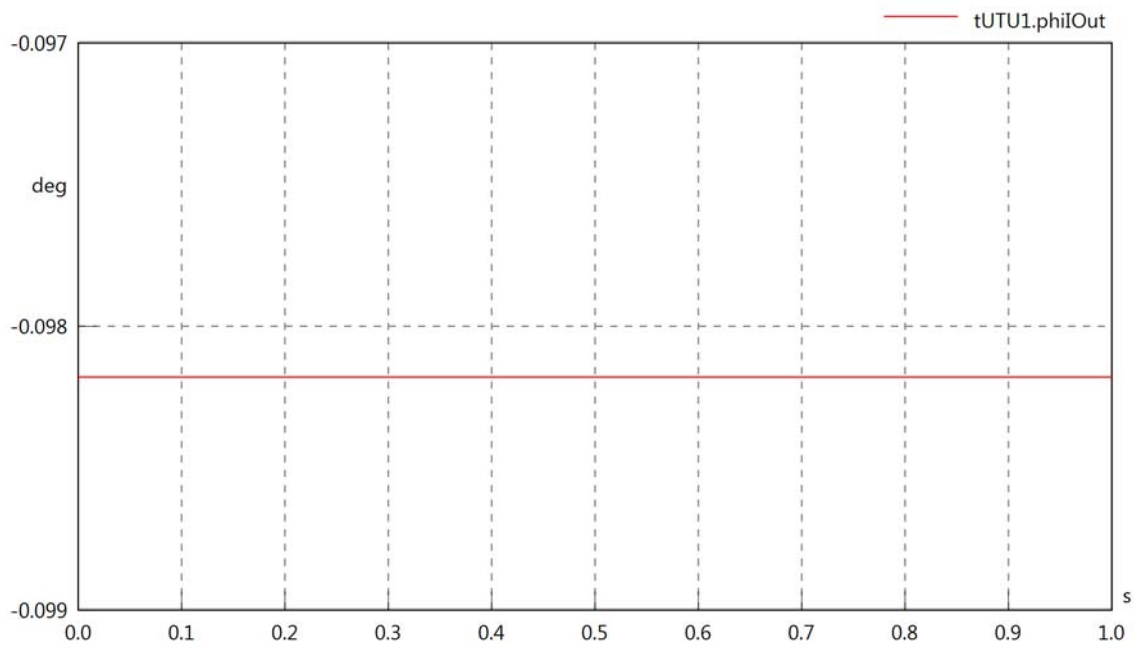

tUTU1.phiIVOut

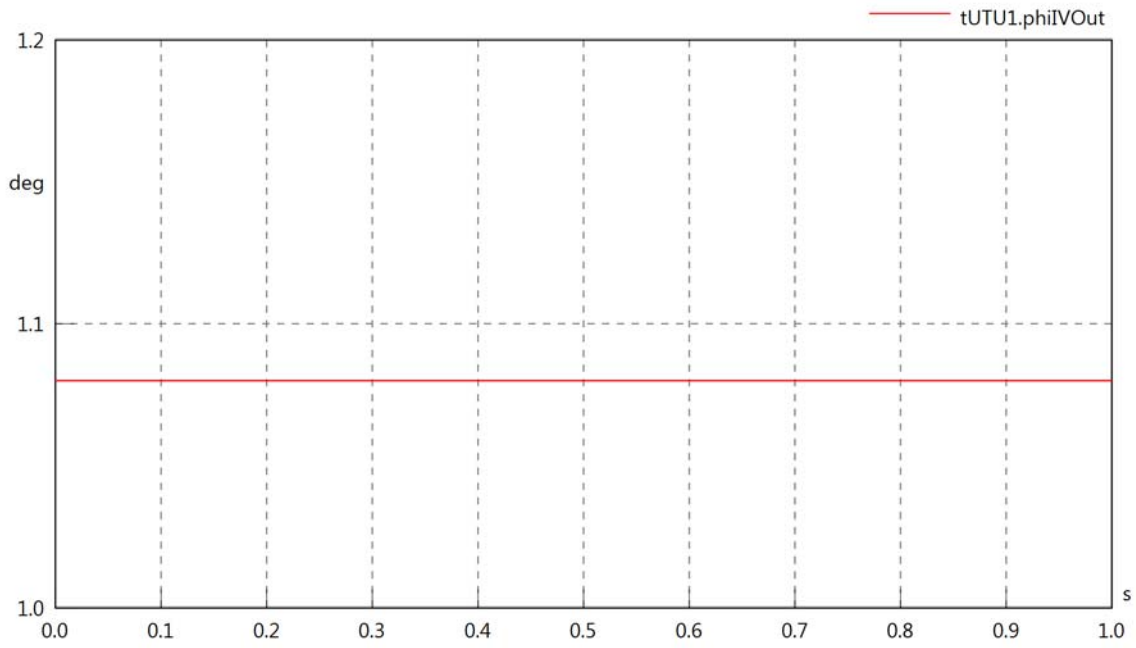

tUTU1.PReIn

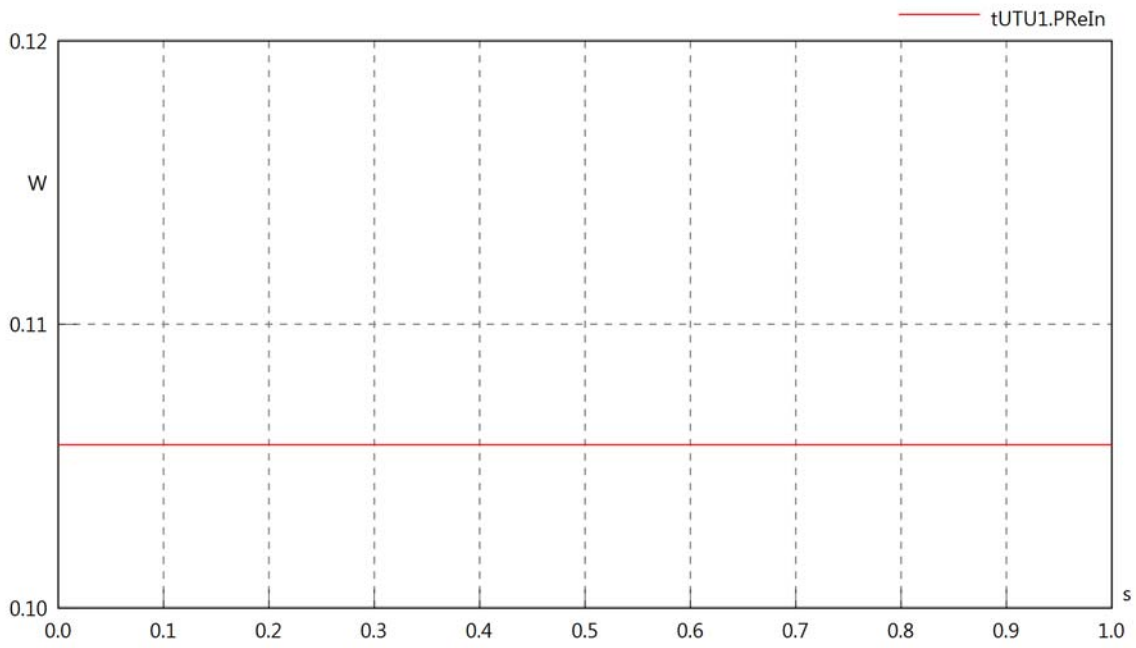

tUTU1.PImIn

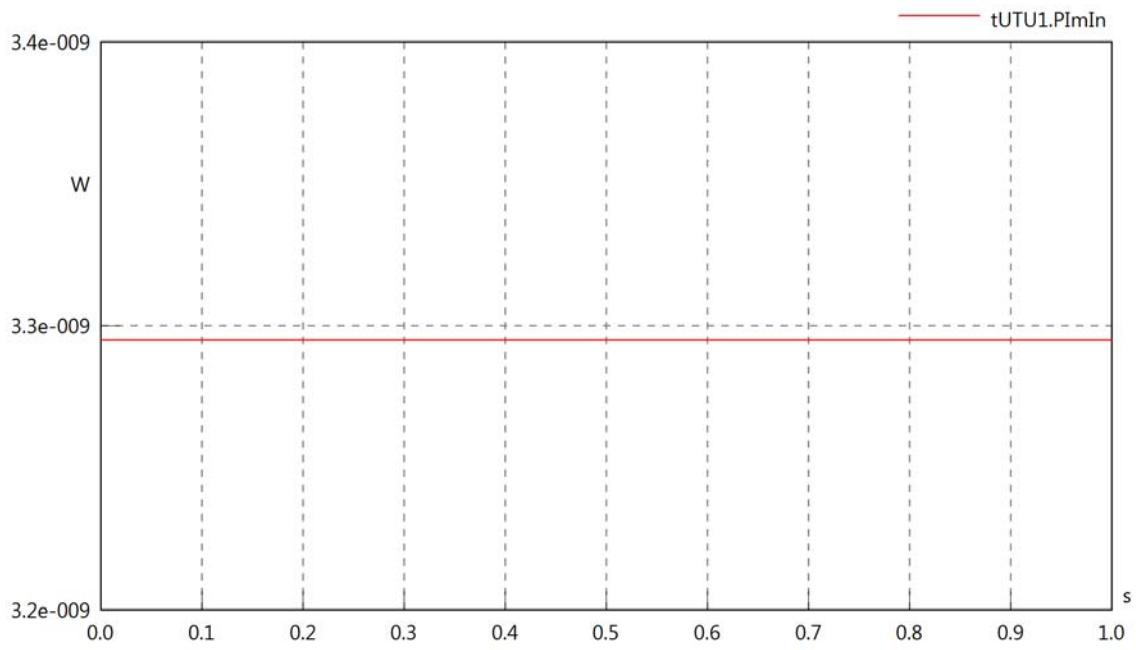

tUTU1.SIn

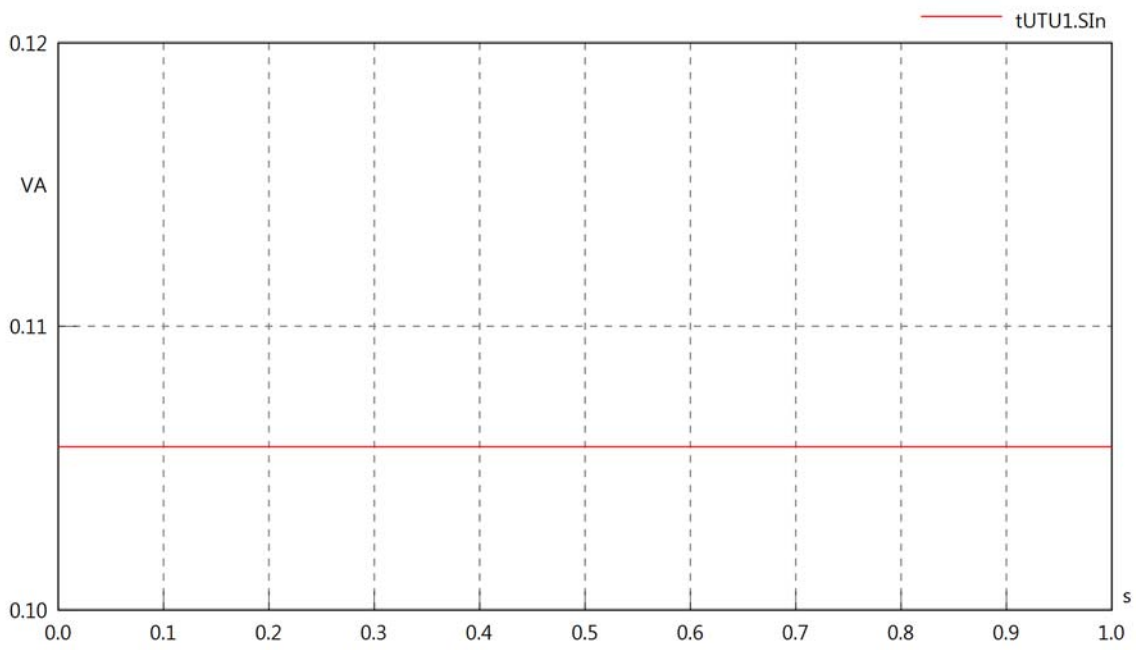

tUTU1.PReOut

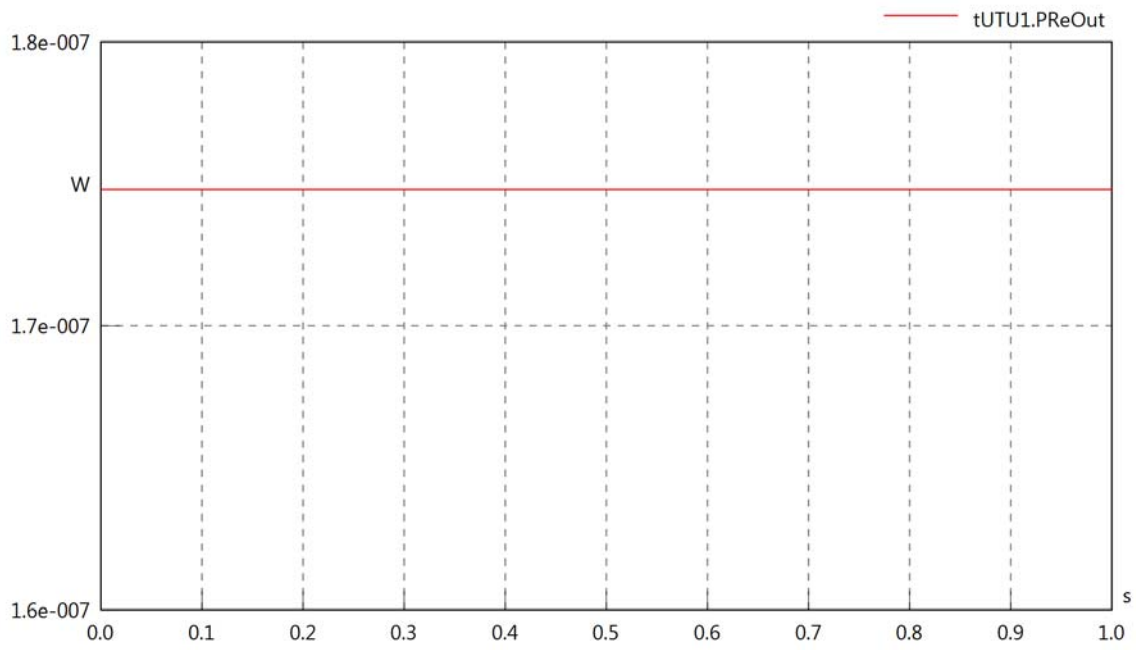

tUTU1.PImOut

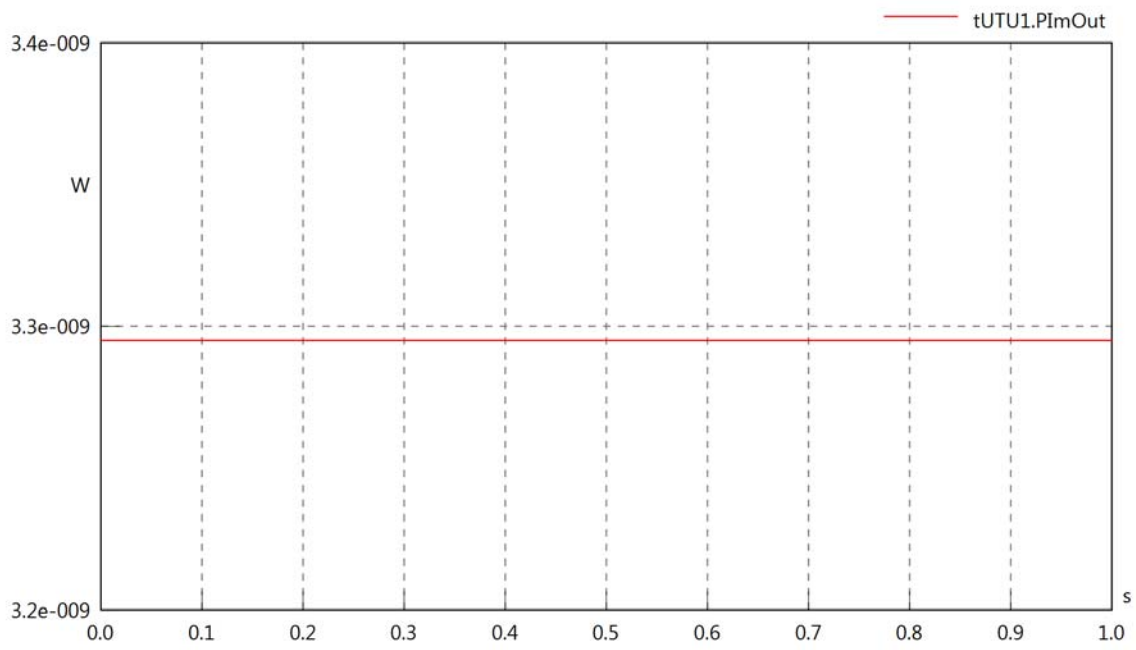

tUTU1.SOut

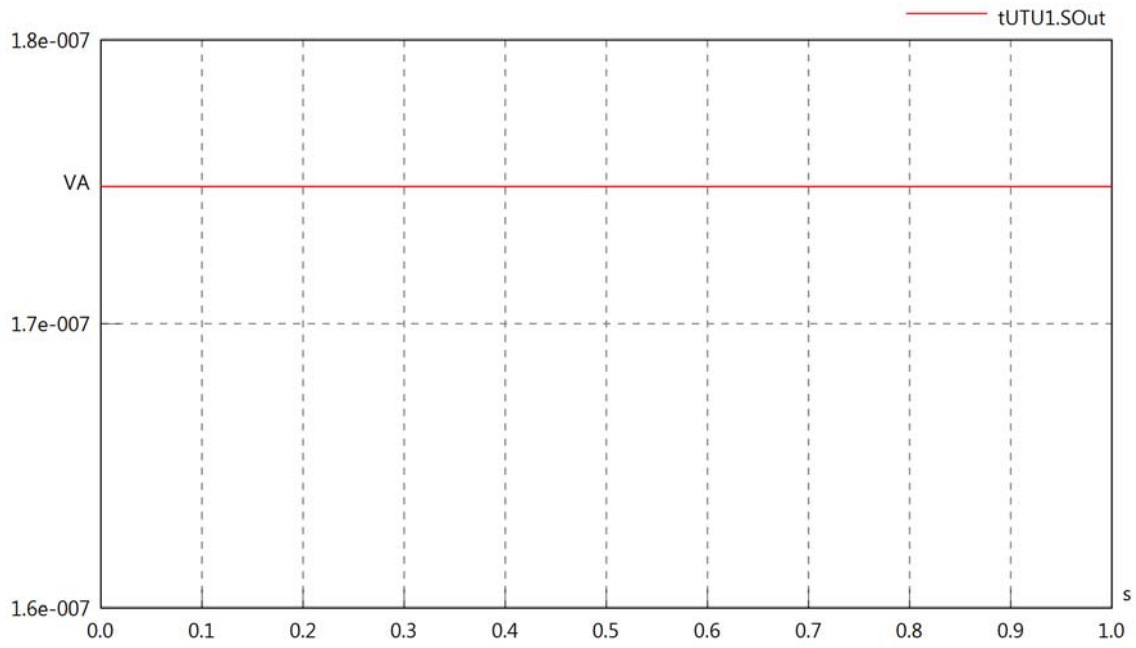
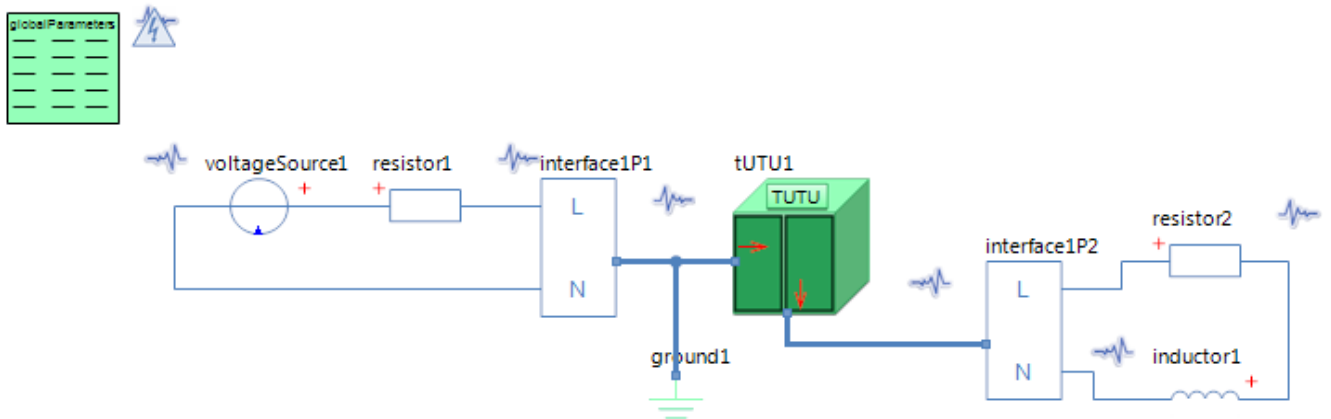

Diagram View



GlobalParameters globalParameters
Parameters

Comment	Name	Current Value	Unit
Type of Calculation	eCalculationKind	Signal Calculation	
Description of Frequency	eFrequencyKind	Linear	
Minimum Frequency	fMin	4000	[Hz]
Maximum Frequency	fMax	4000	[Hz]

Voltage Source voltageSource1
Parameters

Comment	Name	Current Value	Unit
Voltage RMS	VrmsSrc	230	[V]
Phase	phi	0	[deg]

Resistor resistor1
Parameters

Comment	Name	Current Value	Unit
Resistance	R	100	[Ohm]

Resistor resistor2
Parameters

Comment	Name	Current Value	Unit
Resistance	R	100	[Ohm]

Inductor inductor1
Parameters

Comment	Name	Current Value	Unit
Inductance	L	5	[mH]

Topside Umbilical Termination Unit tUTU1
Parameters

Comment	Name	Current Value	Unit
Poor or failing L1 connection	bL1	true	
Resistance in L1 connection	rL1	1	[kOhm]
Conductance between L1 and N	G	50	[1/Ohm]

tUTU1.VrmsIn

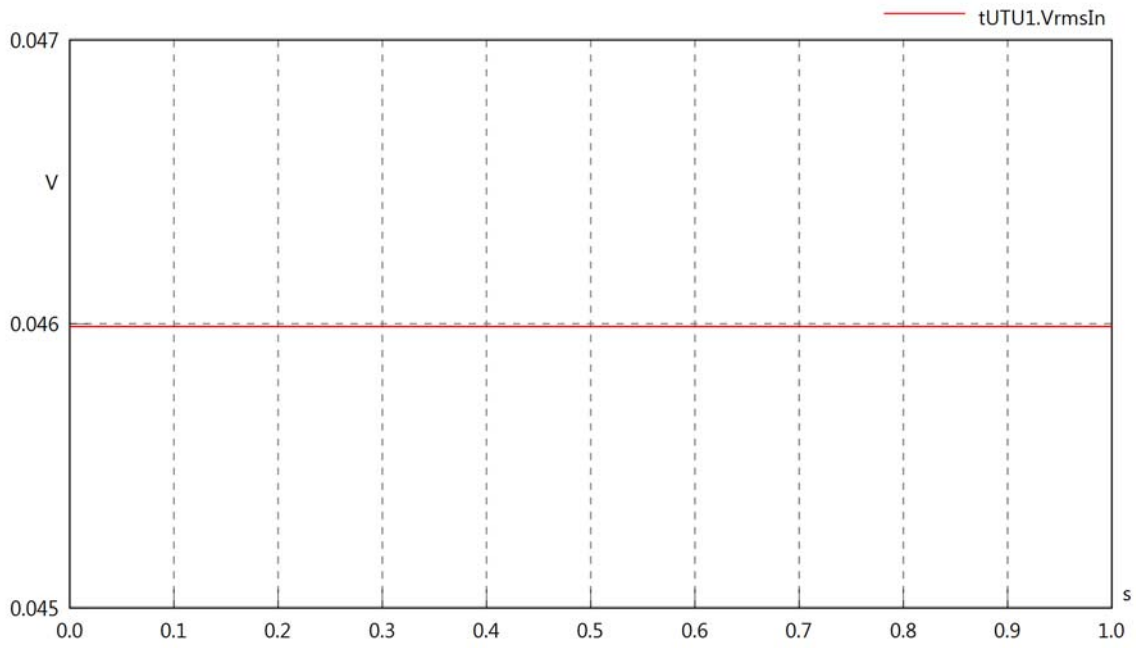

tUTU1.vReIn

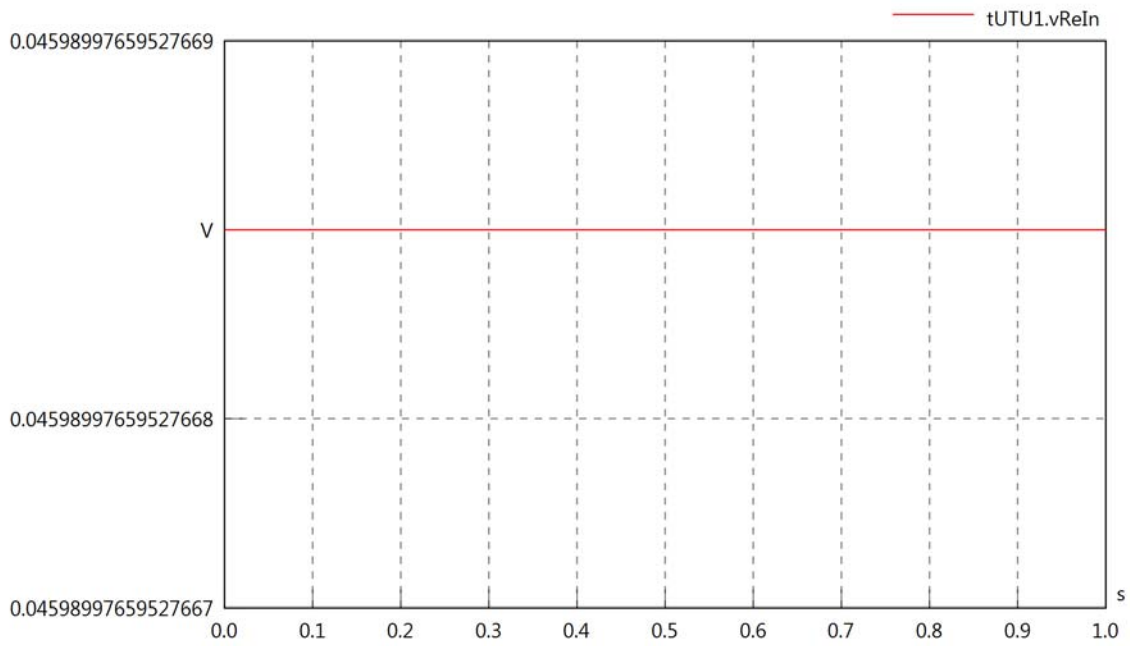

tUTU1.vImIn

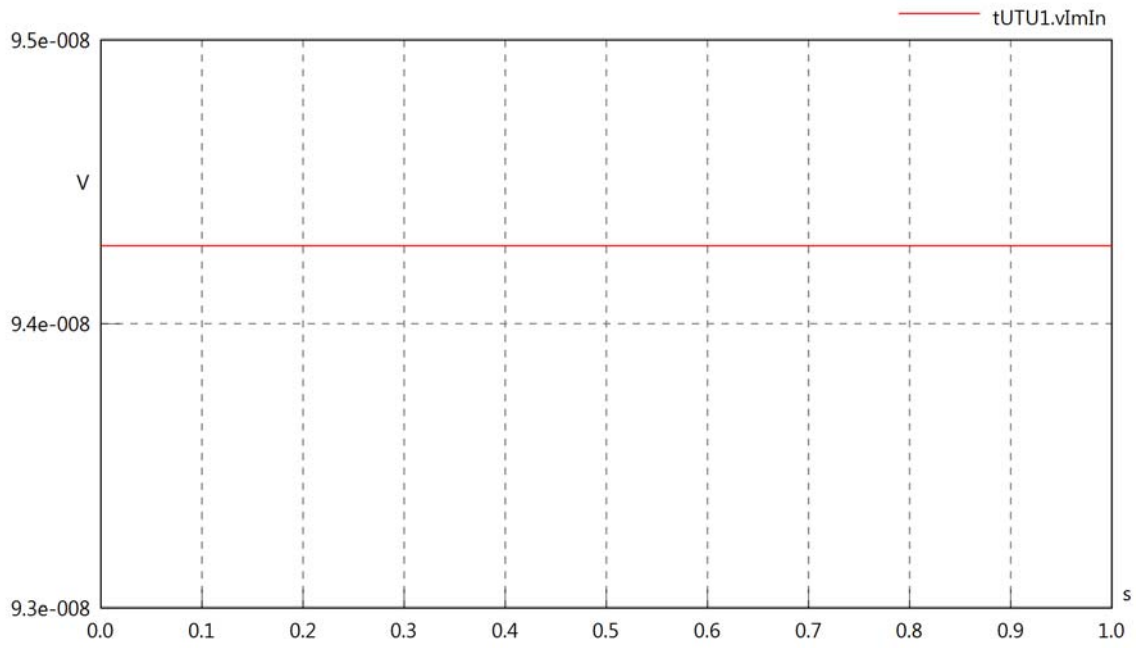

tUTU1.VrmsOut

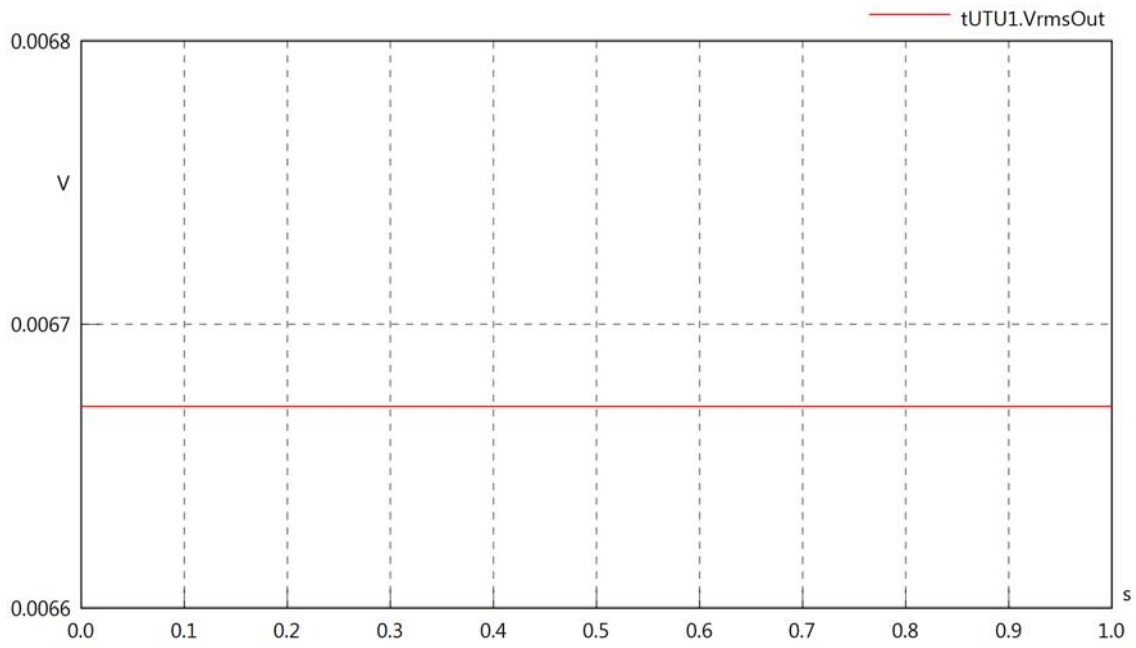

tUTU1.vReOut

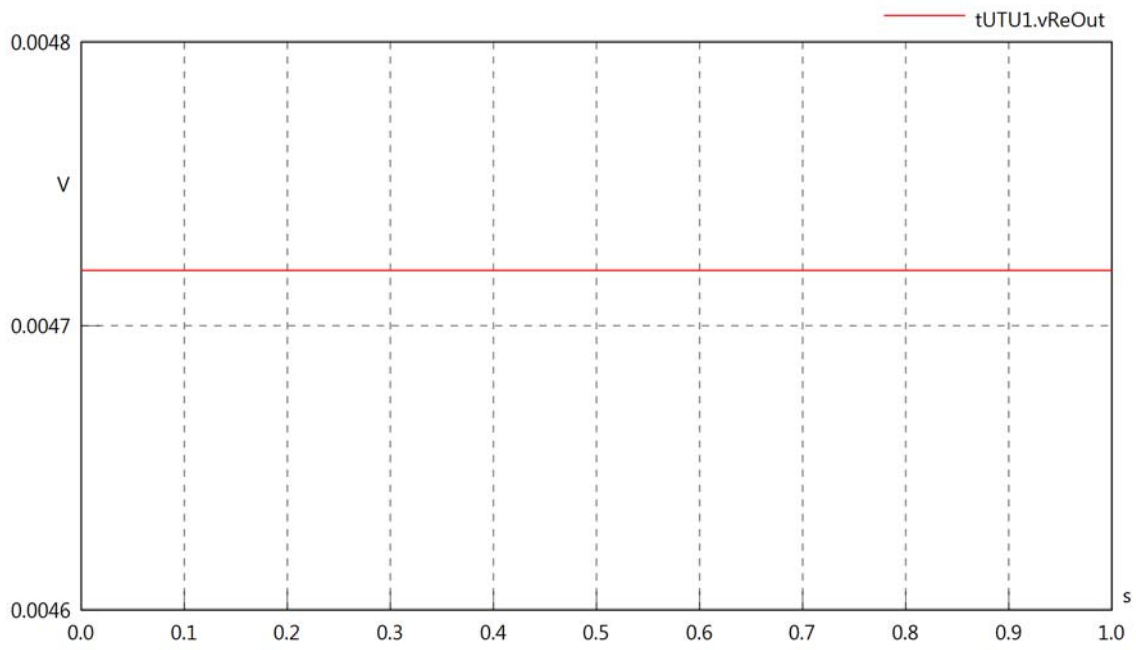

tUTU1.vImOut

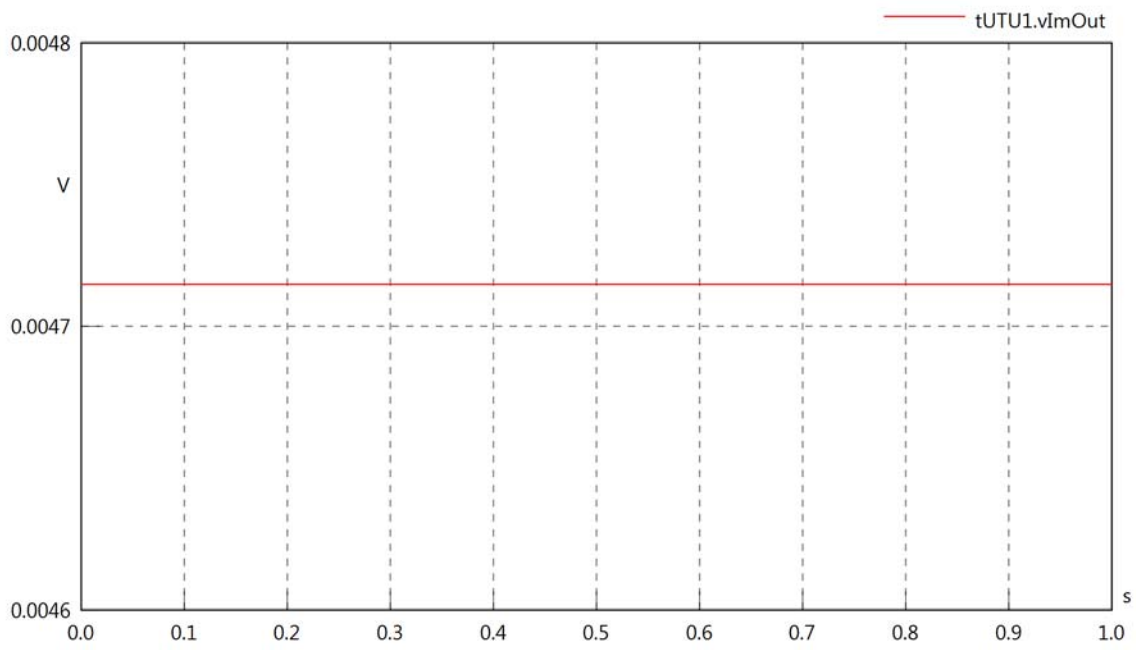

tUTU1.Vrms

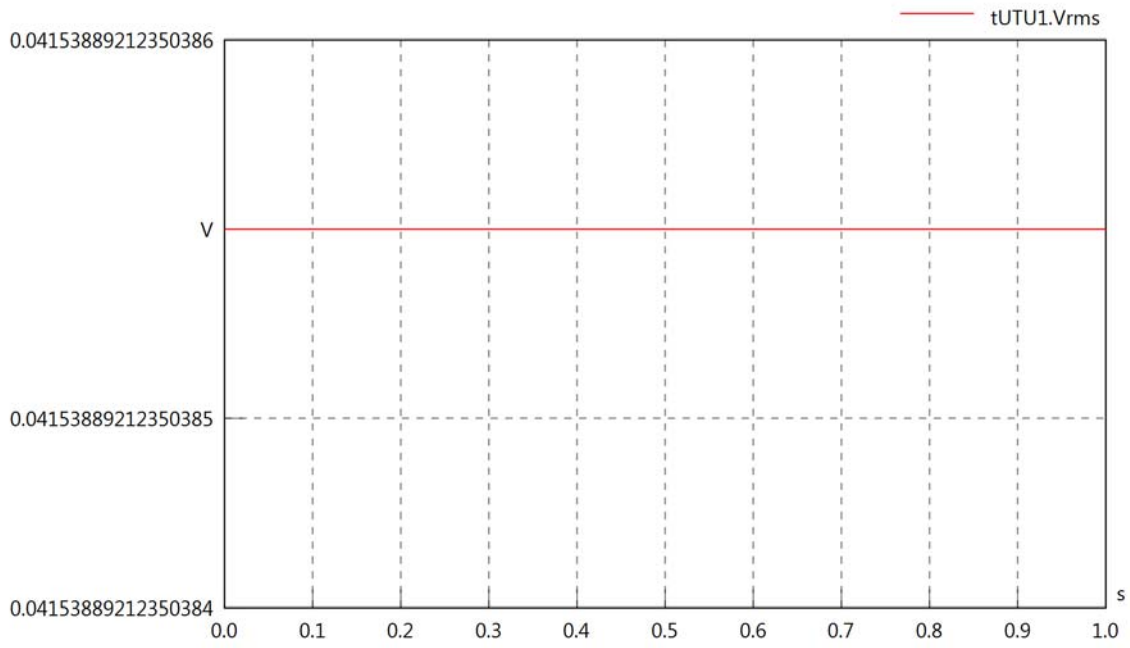

tUTU1.vRe

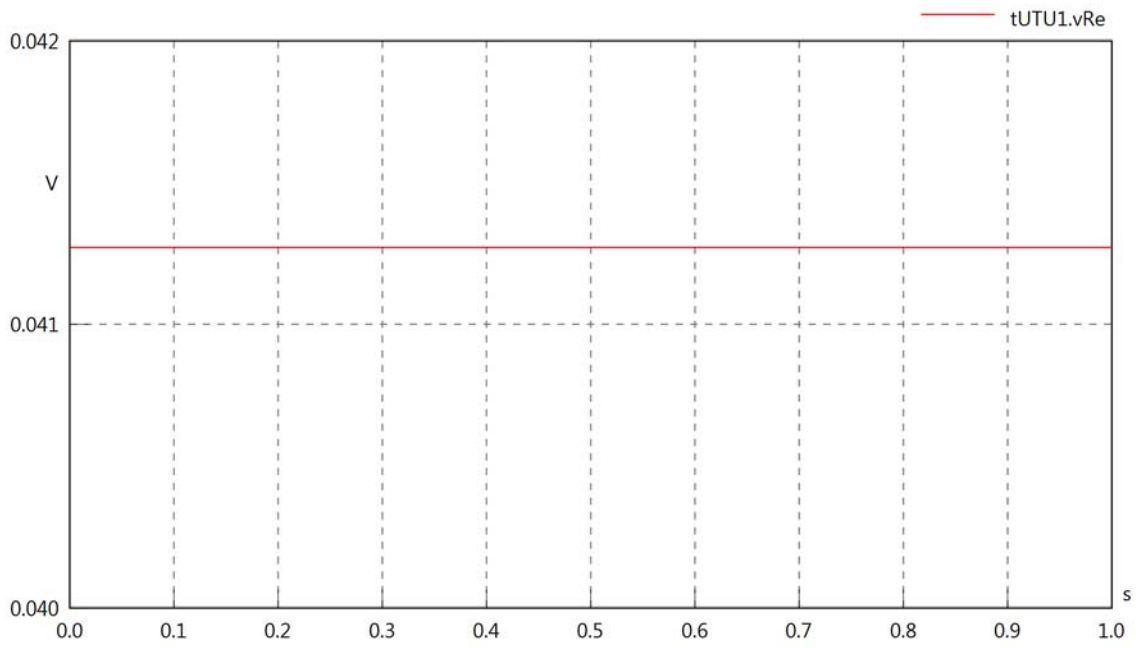

tUTU1.vIm

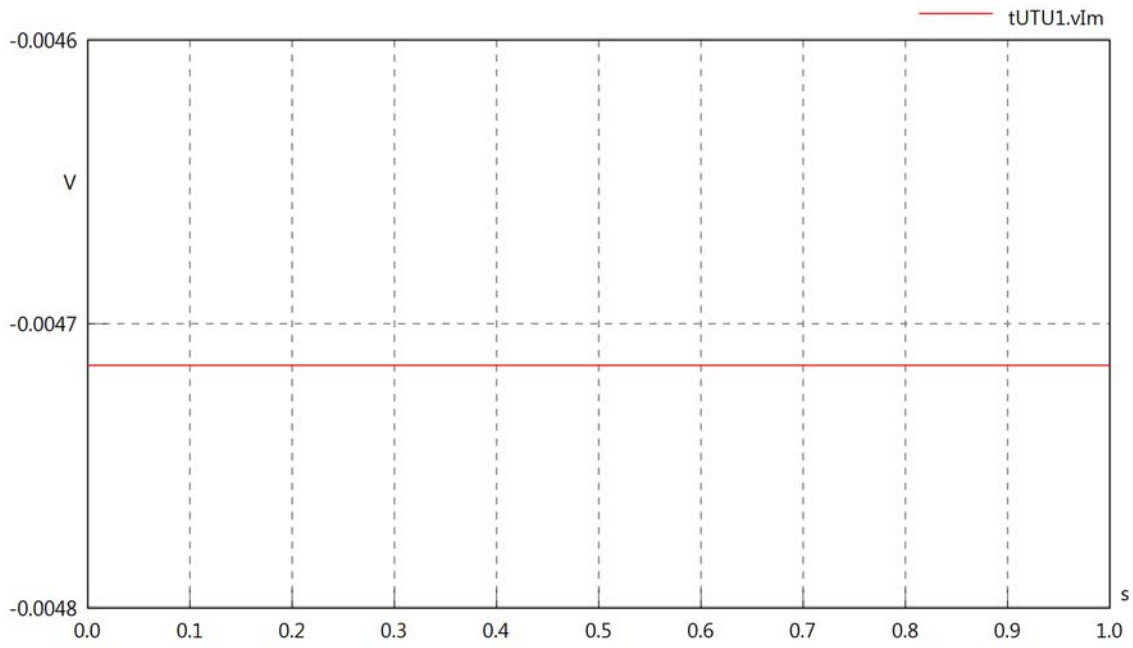

tUTU1.IrmsIn

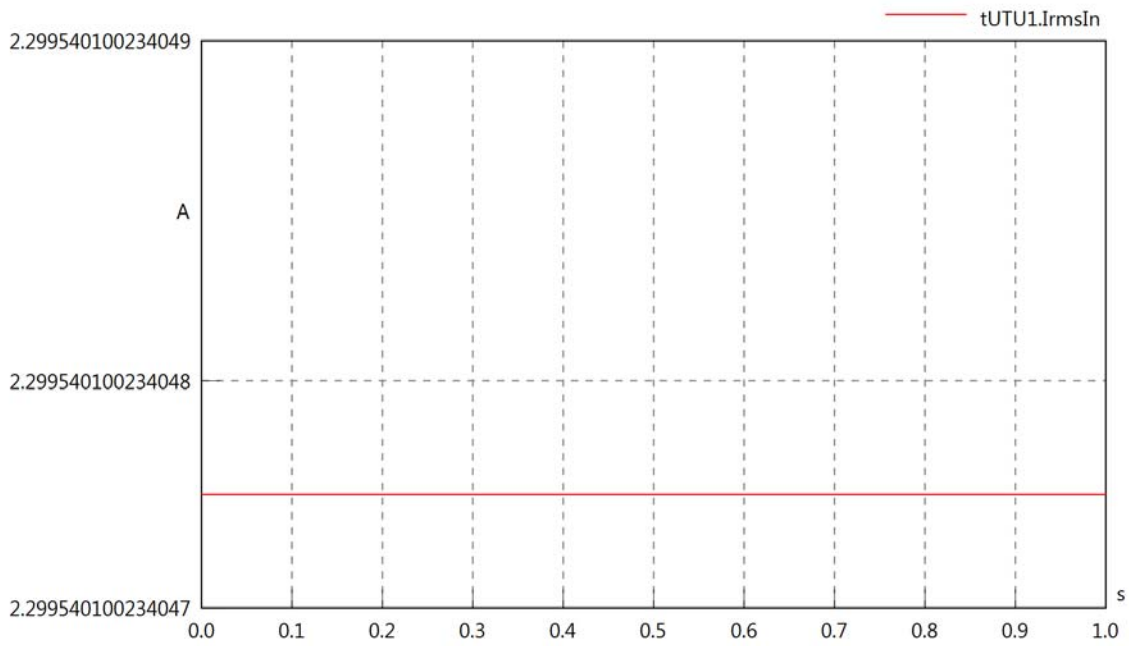

tUTU1.iReIn

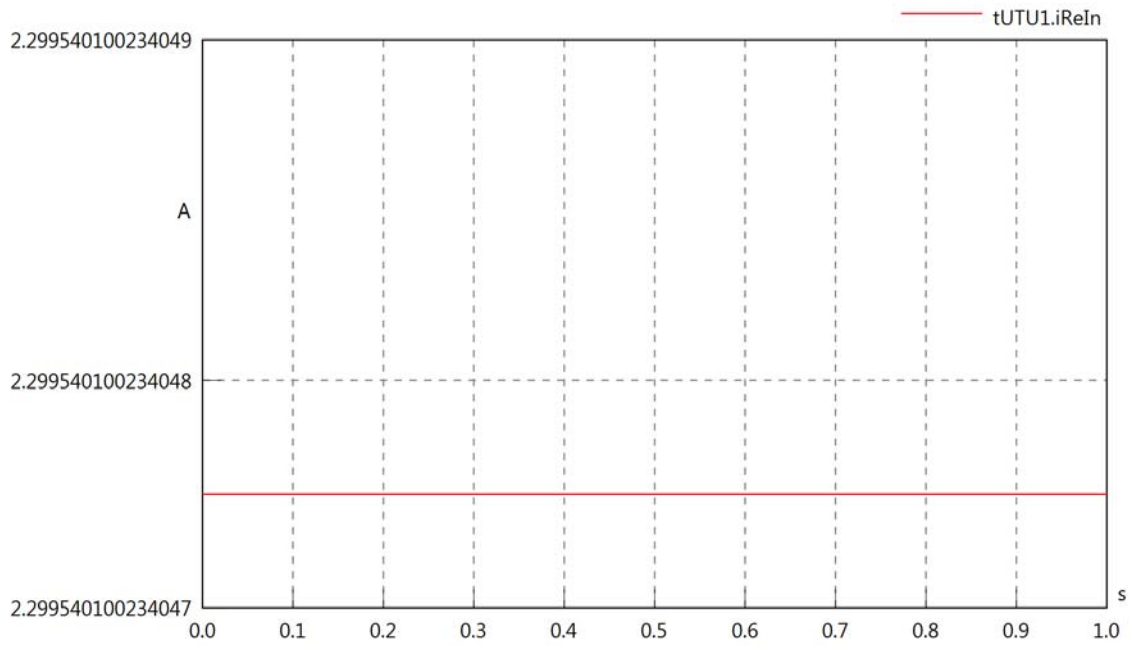

tUTU1.iImIn

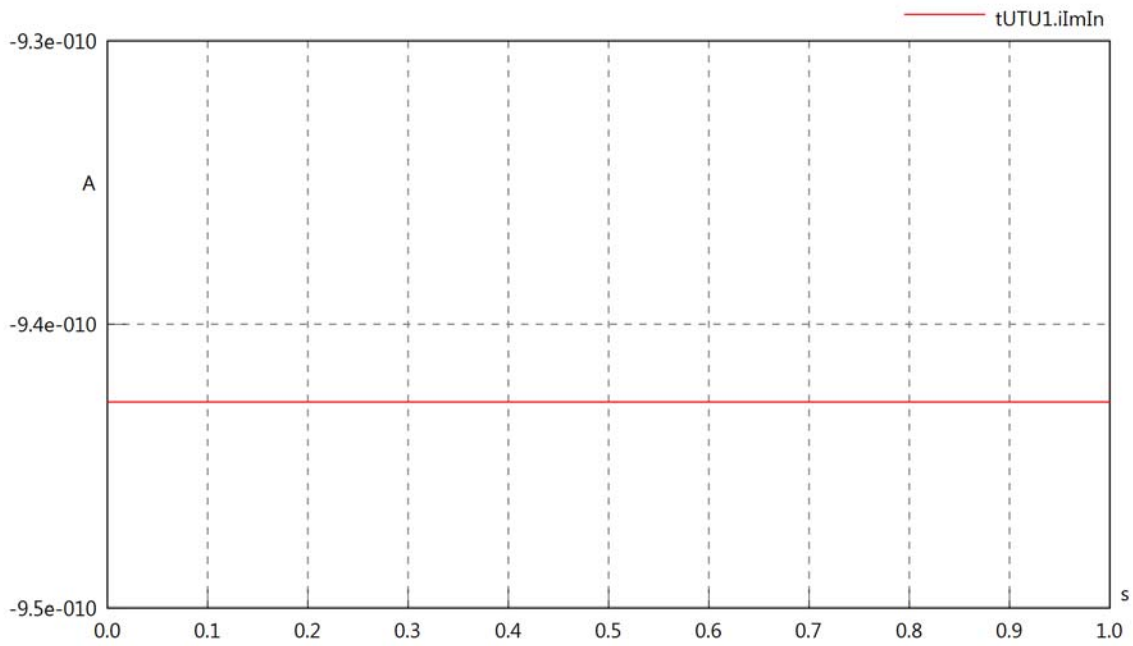

tUTU1.IrmsOut

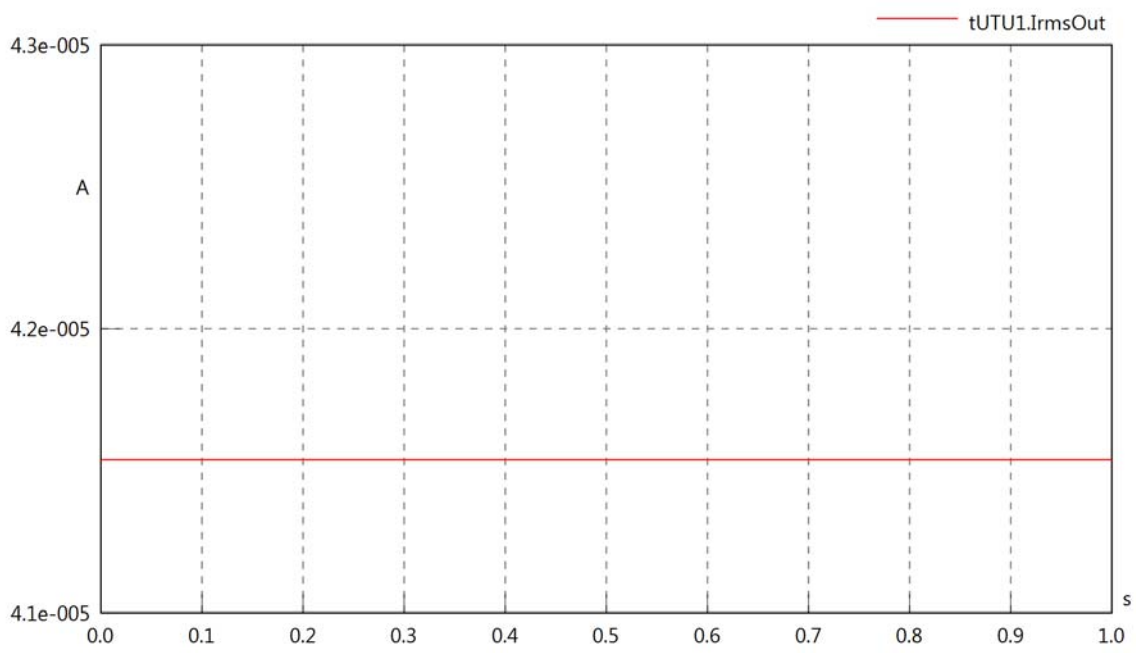

tUTU1.iReOut

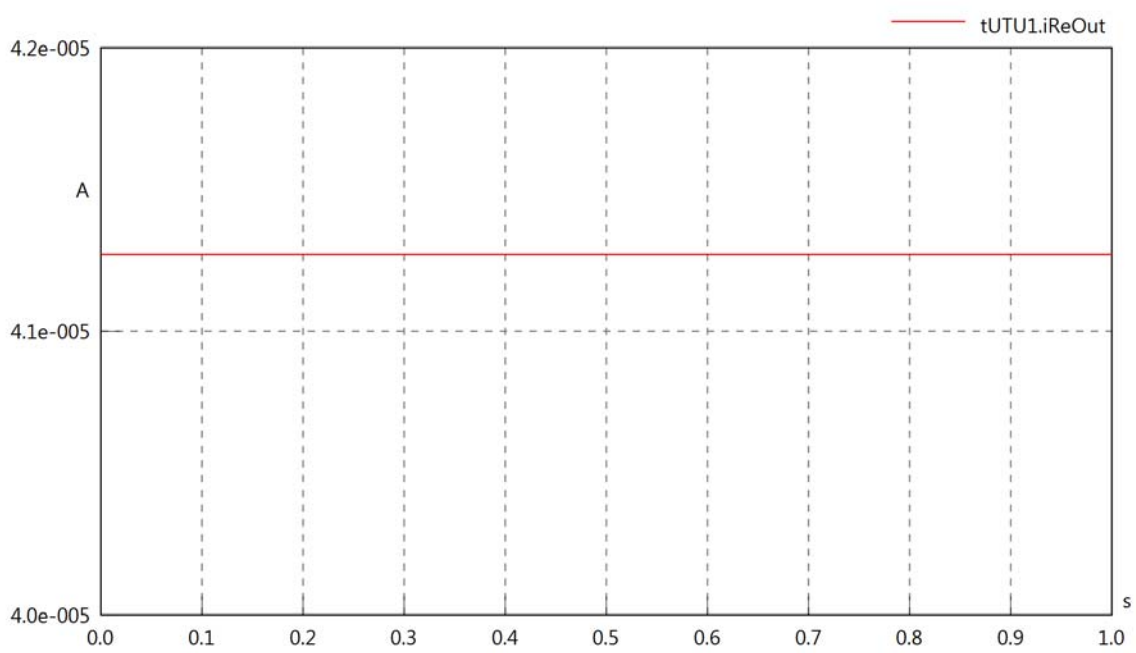

tUTU1.iImOut

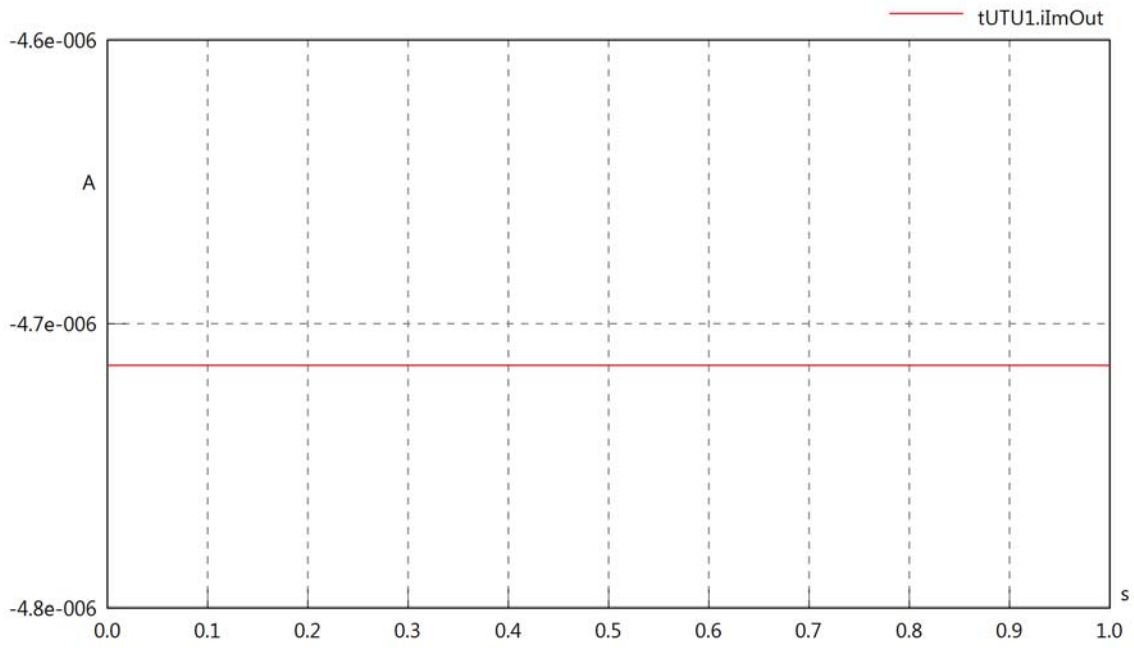

tUTU1.phiVIn

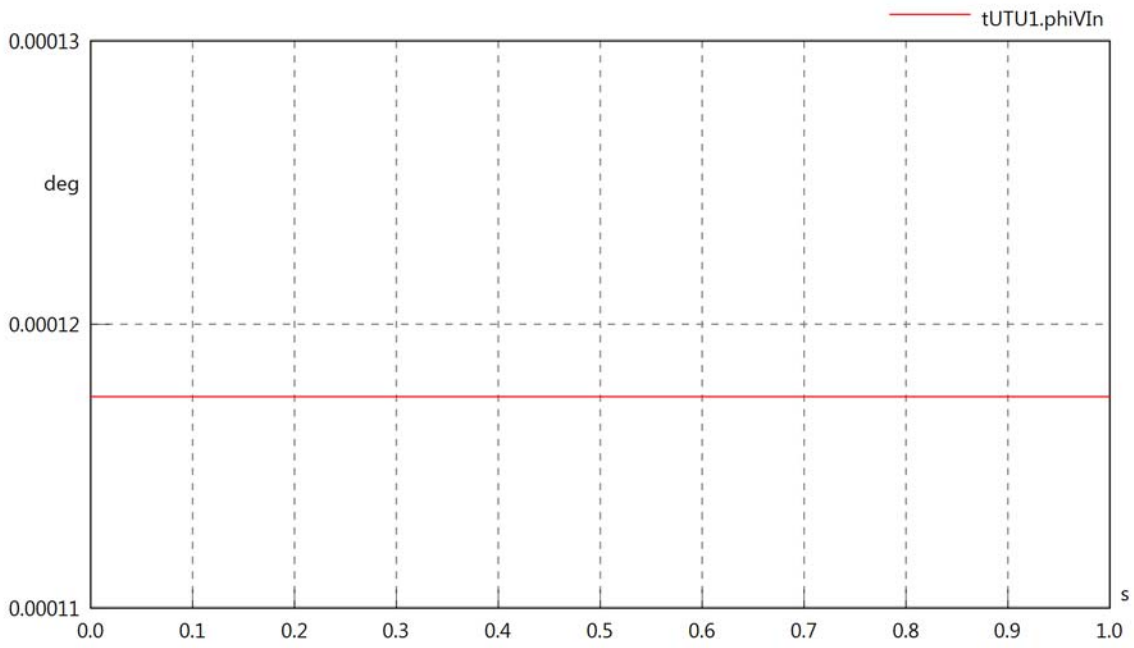

tUTU1.phiIIIn

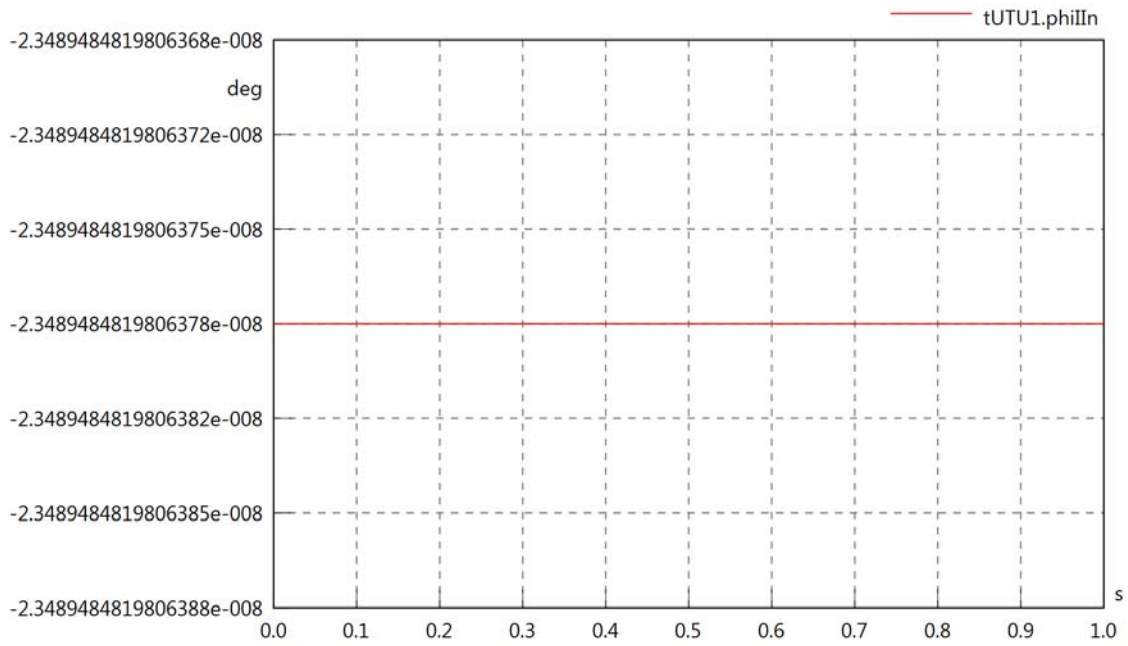

tUTU1.phiIVIn

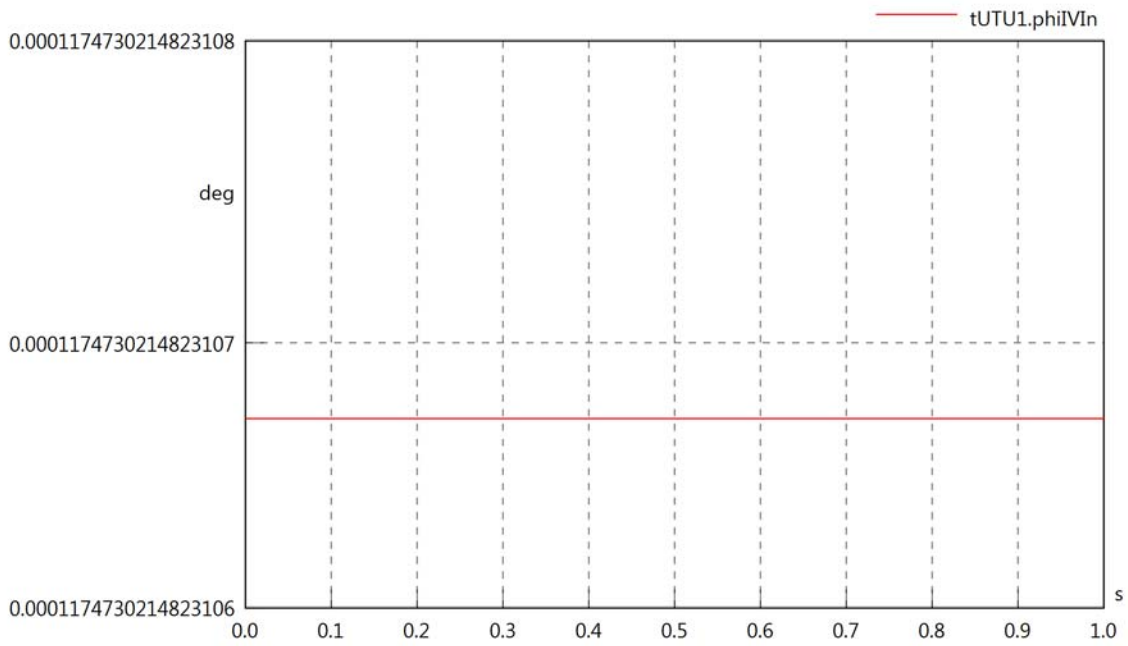

tUTU1.phiVOut

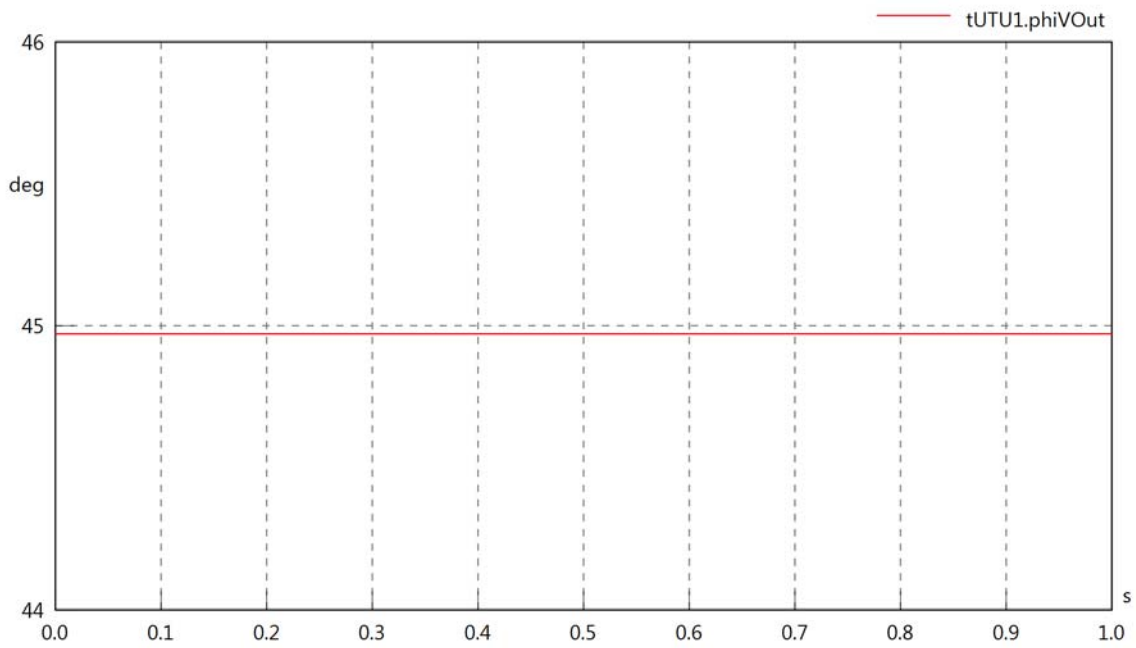

tUTU1.phiIOut

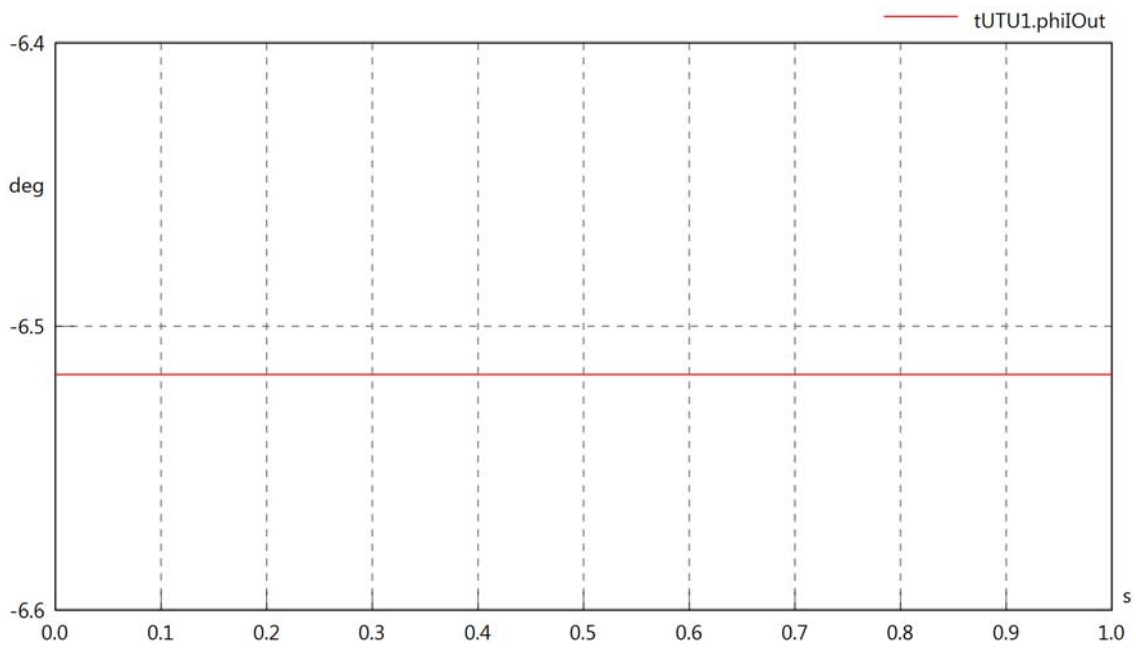

tUTU1.phiIVOut

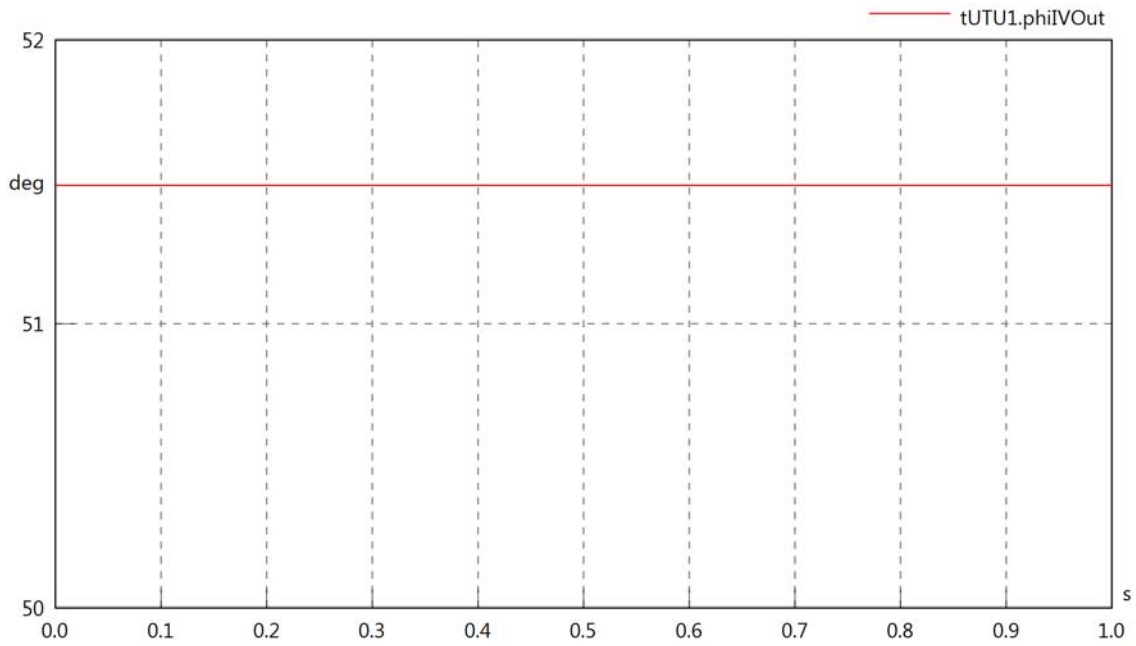

tUTU1.PReIn

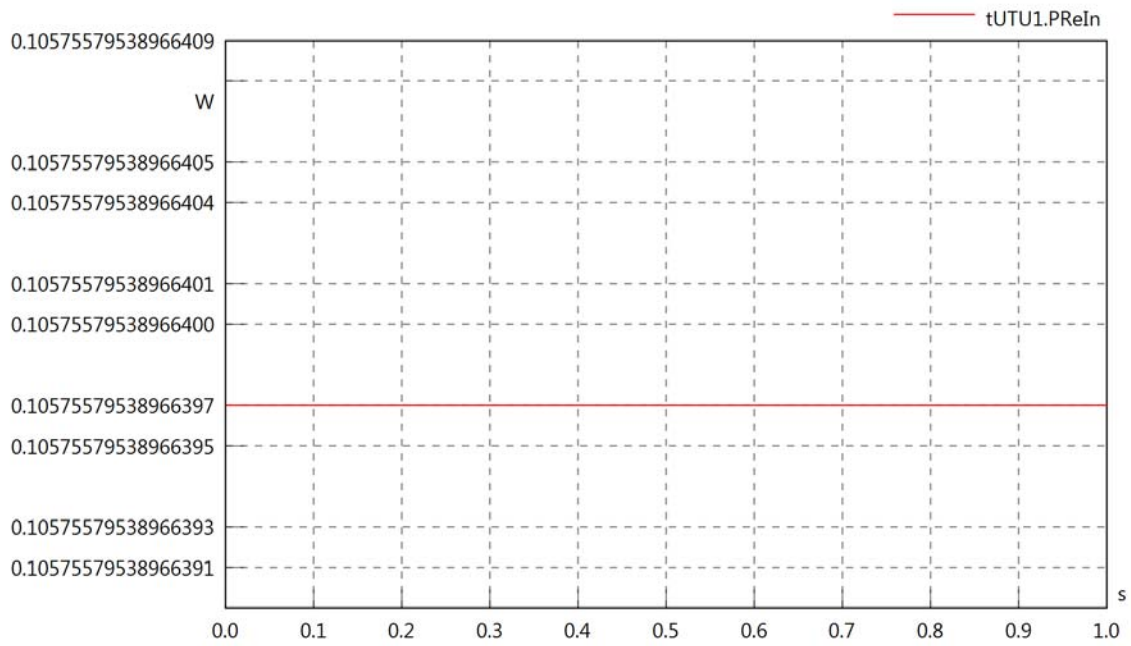

tUTU1.PImIn

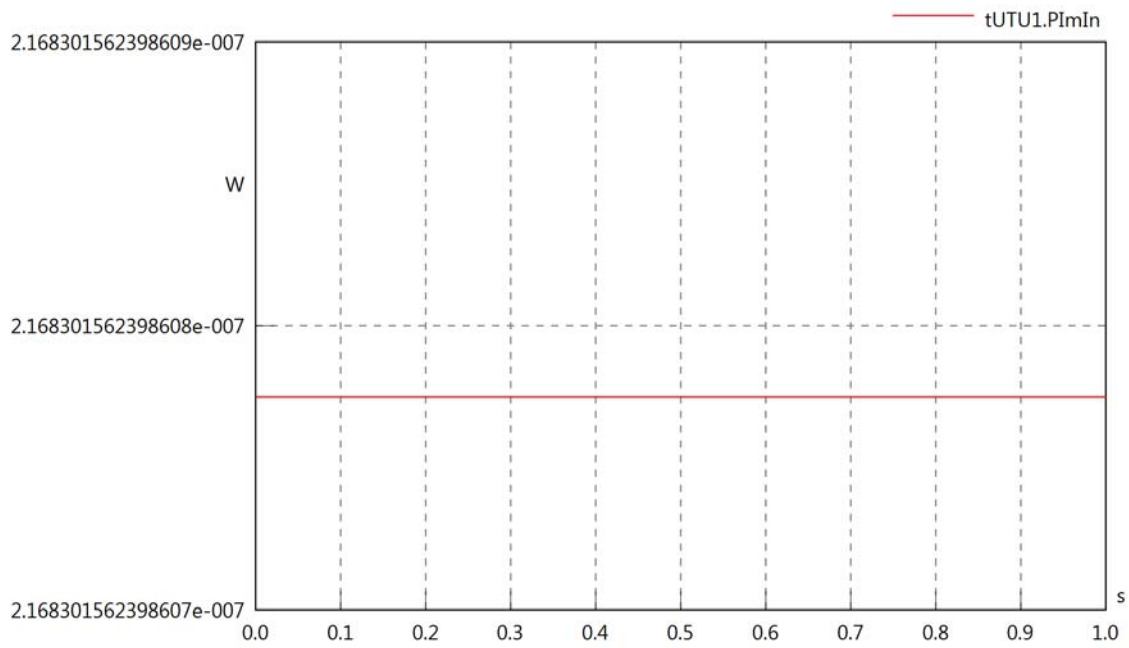

tUTU1.SIn

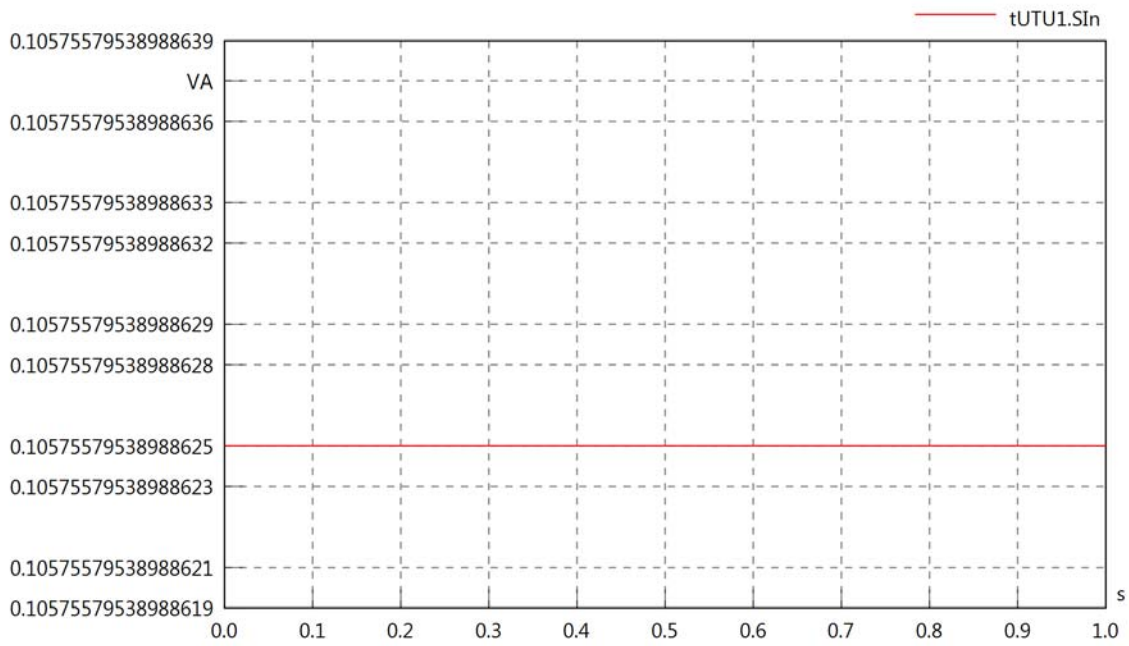

tUTU1.PReOut

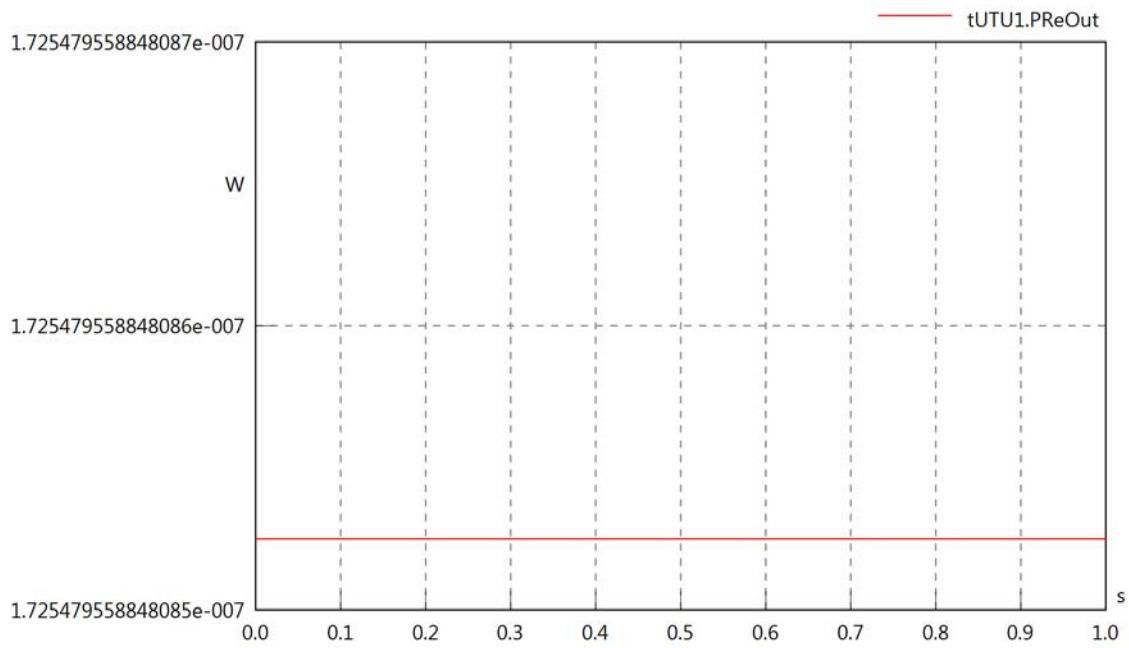

tUTU1.PImOut

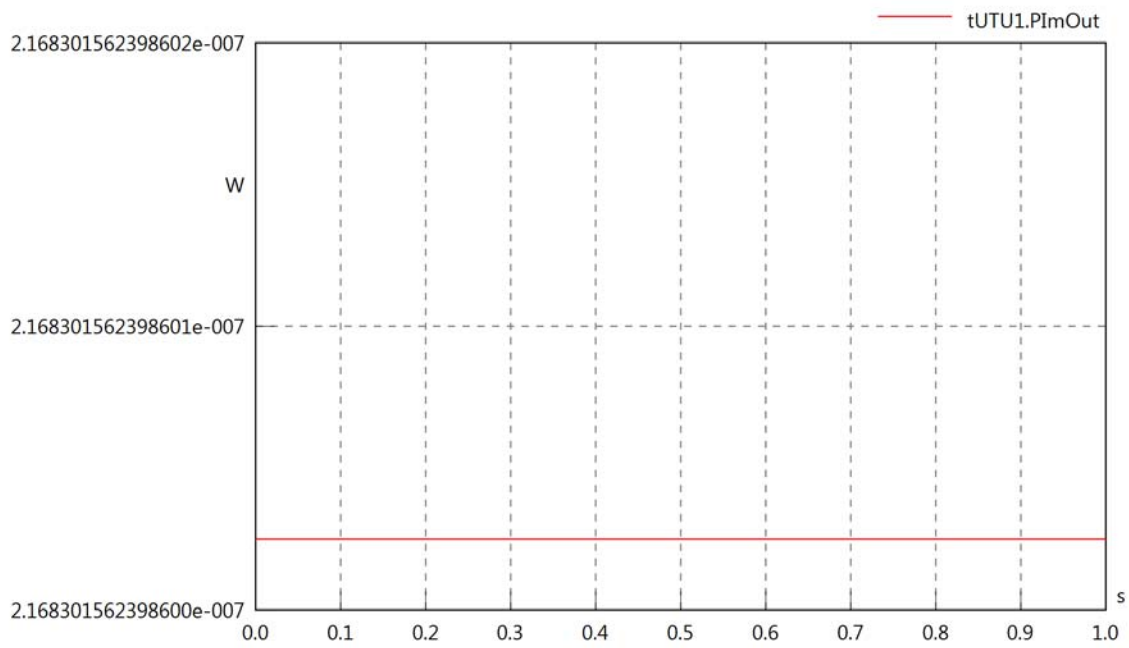

tUTU1.SOut

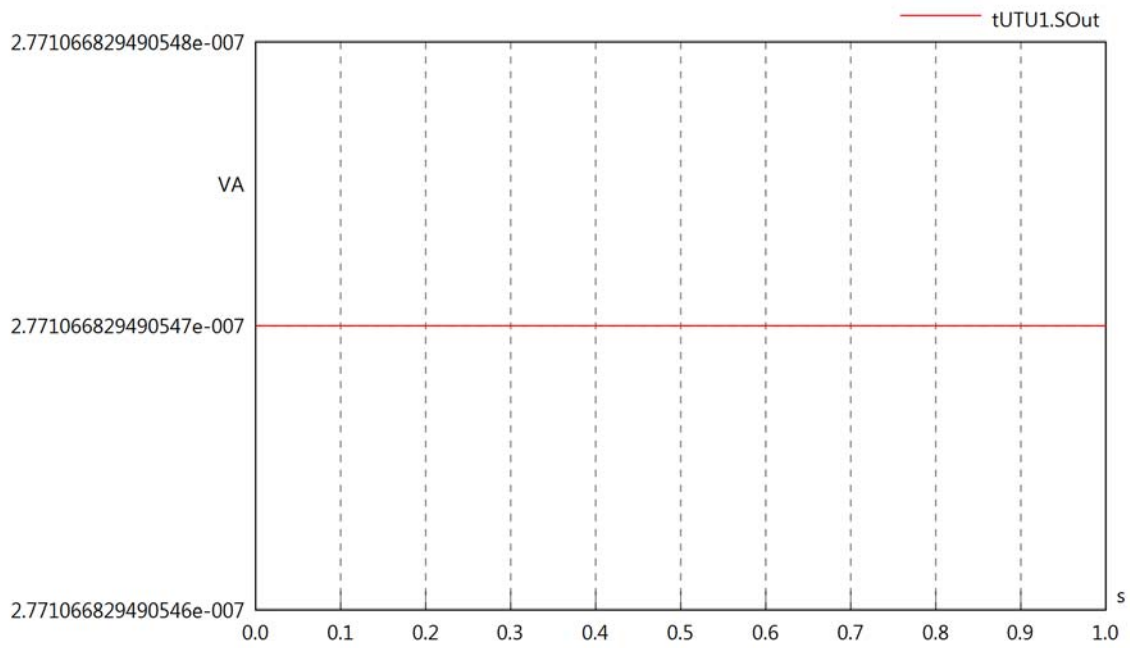
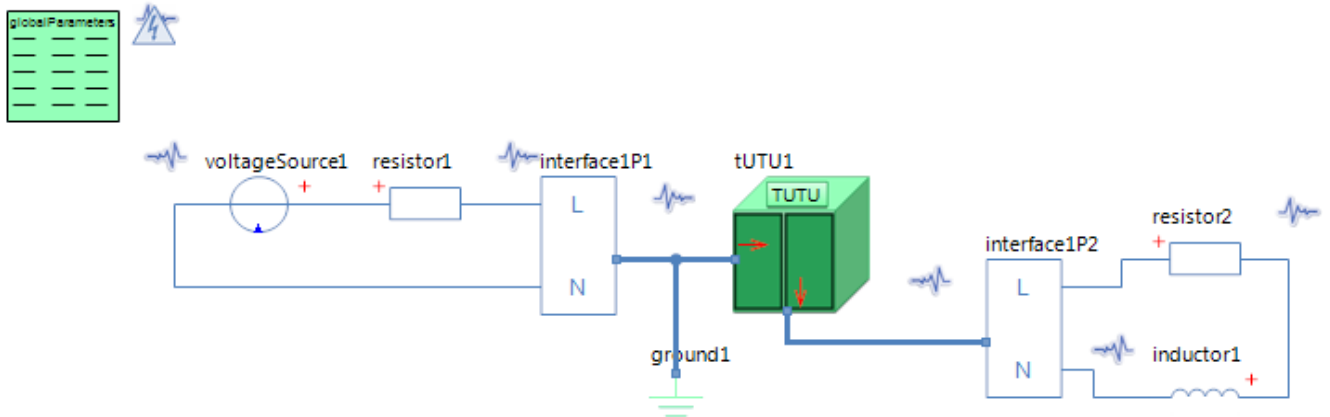

Diagram View



GlobalParameters globalParameters
Parameters

Comment	Name	Current Value	Unit
Type of Calculation	eCalculationKind	Signal Calculation	
Description of Frequency	eFrequencyKind	Linear	
Minimum Frequency	fMin	20000	[Hz]
Maximum Frequency	fMax	20000	[Hz]

Voltage Source voltageSource1
Parameters

Comment	Name	Current Value	Unit
Voltage RMS	VrmsSrc	230	[V]
Phase	phi	0	[deg]

Resistor resistor1
Parameters

Comment	Name	Current Value	Unit
Resistance	R	100	[Ohm]

Resistor resistor2
Parameters

Comment	Name	Current Value	Unit
Resistance	R	100	[Ohm]

Inductor inductor1
Parameters

Comment	Name	Current Value	Unit
Inductance	L	5	[mH]

Topside Umbilical Termination Unit tUTU1
Parameters

Comment	Name	Current Value	Unit
Poor or failing L1 connection	bL1	true	
Resistance in L1 connection	rL1	1	[kOhm]
Conductance between L1 and N	G	50	[1/Ohm]

tUTU1.VrmsIn

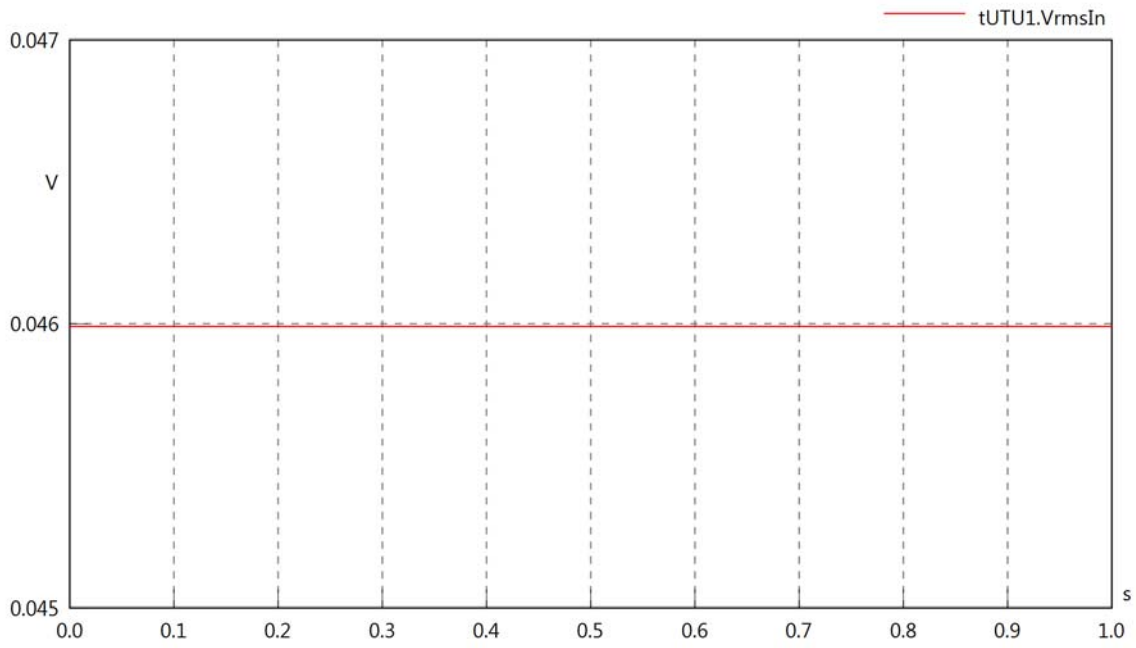

tUTU1.vReIn

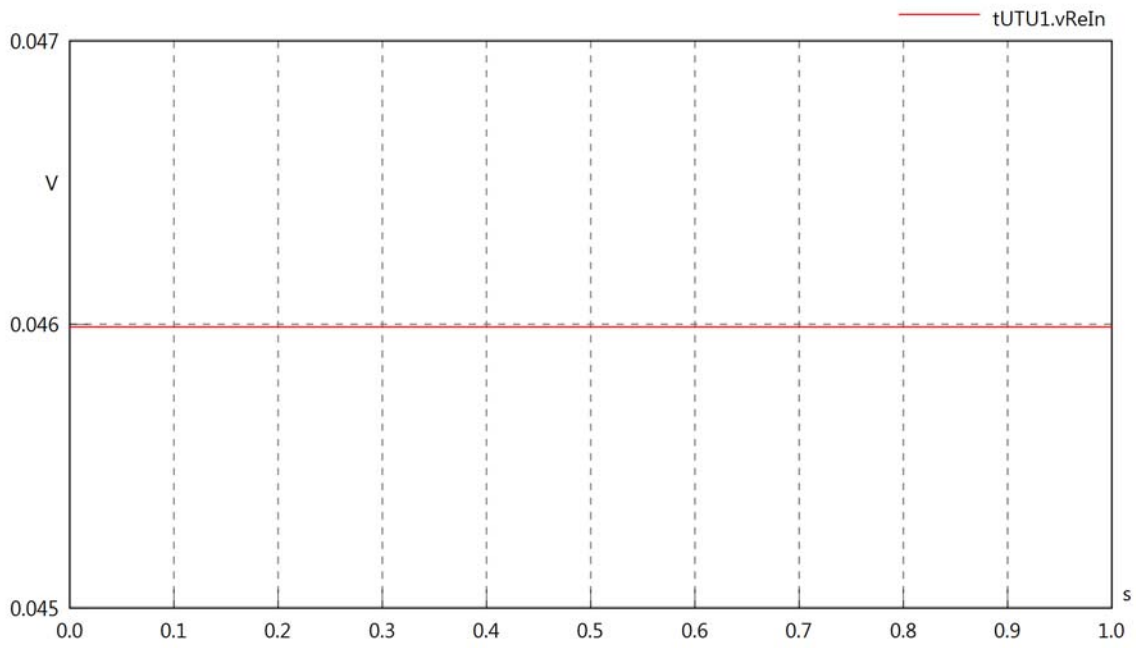

tUTU1.vImIn

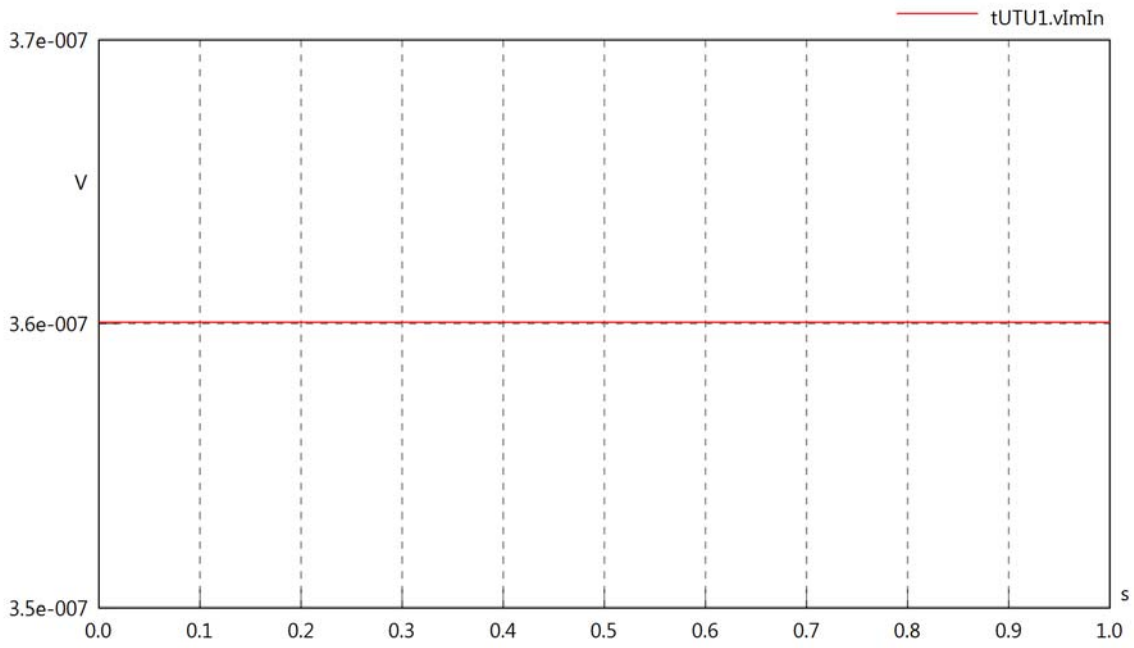

tUTU1.VrmsOut

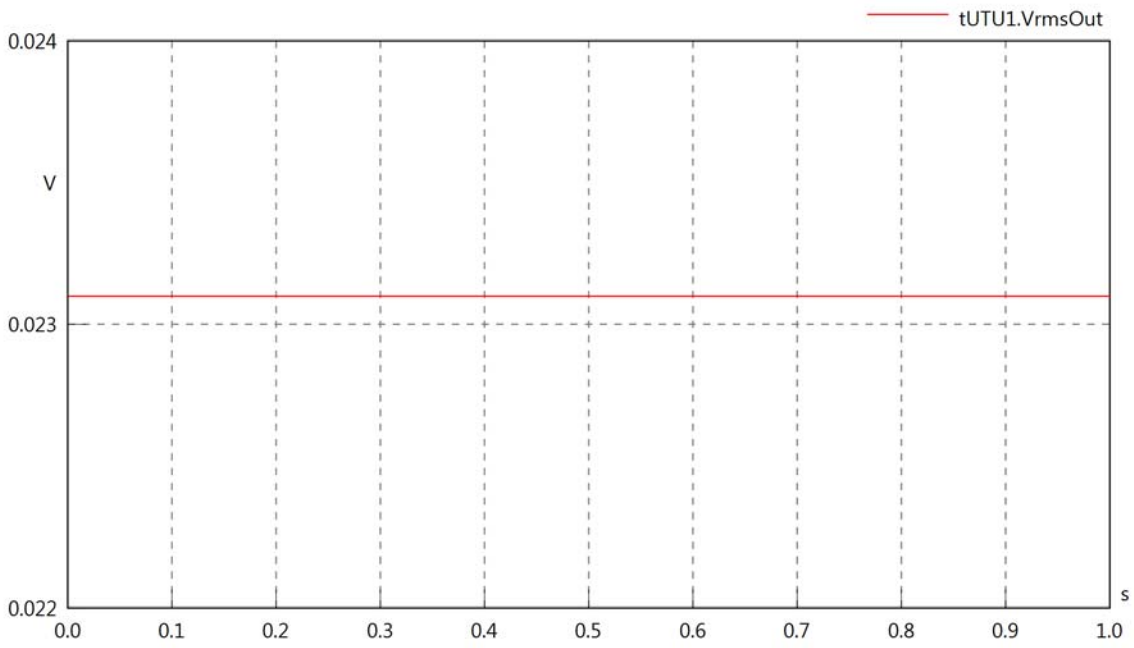

tUTU1.vReOut

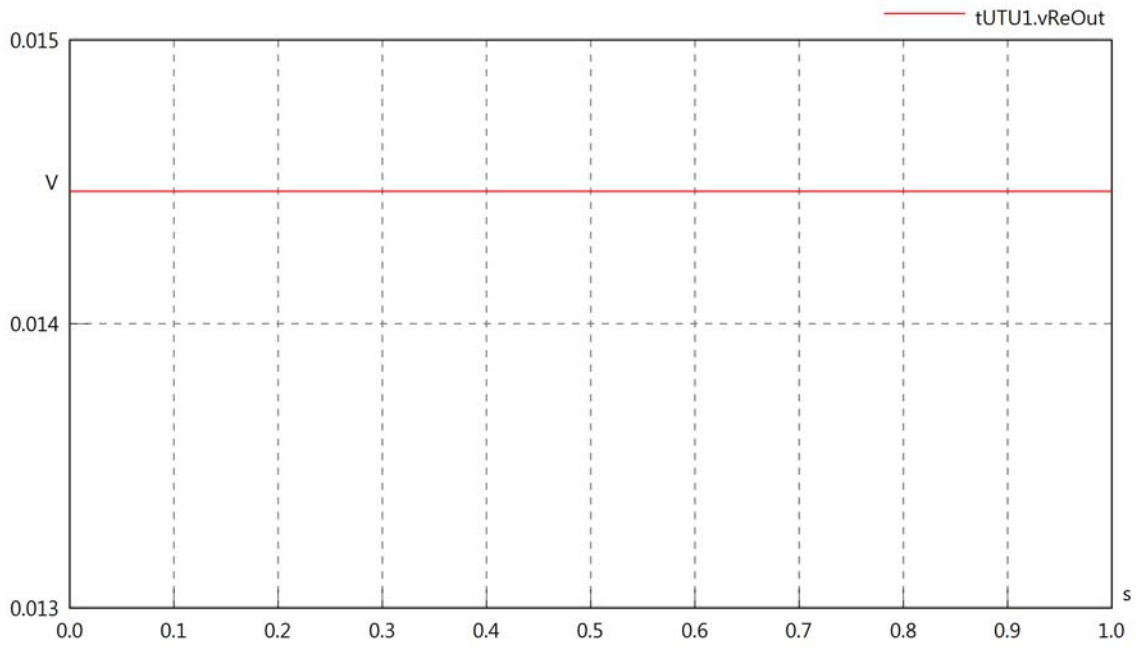

tUTU1.vImOut

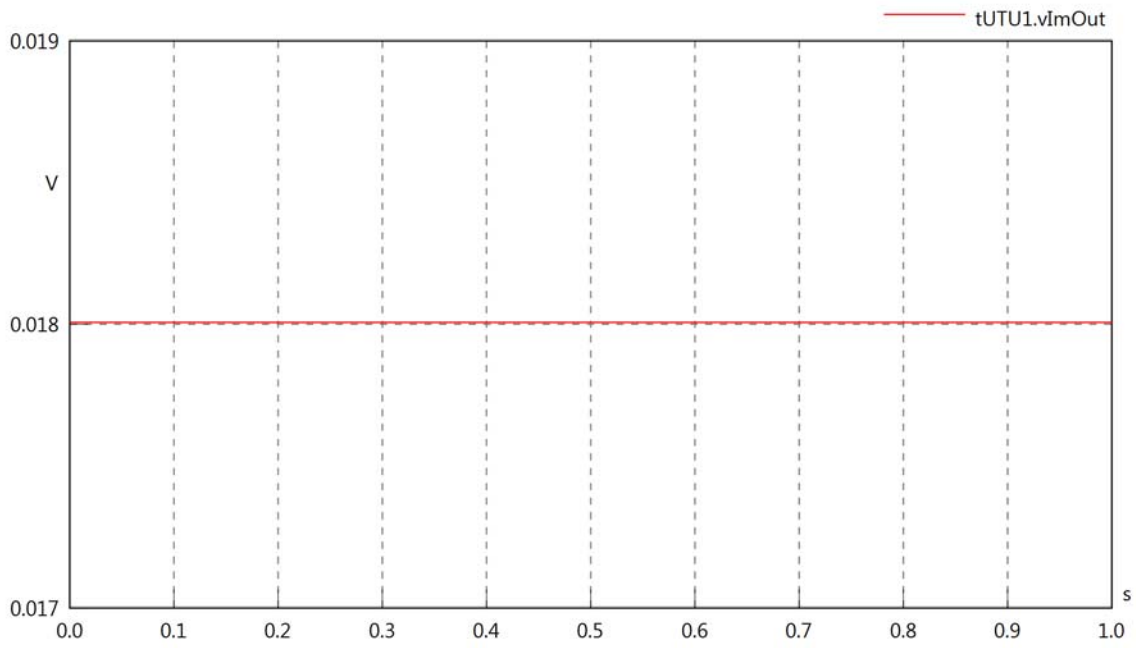

tUTU1.Vrms

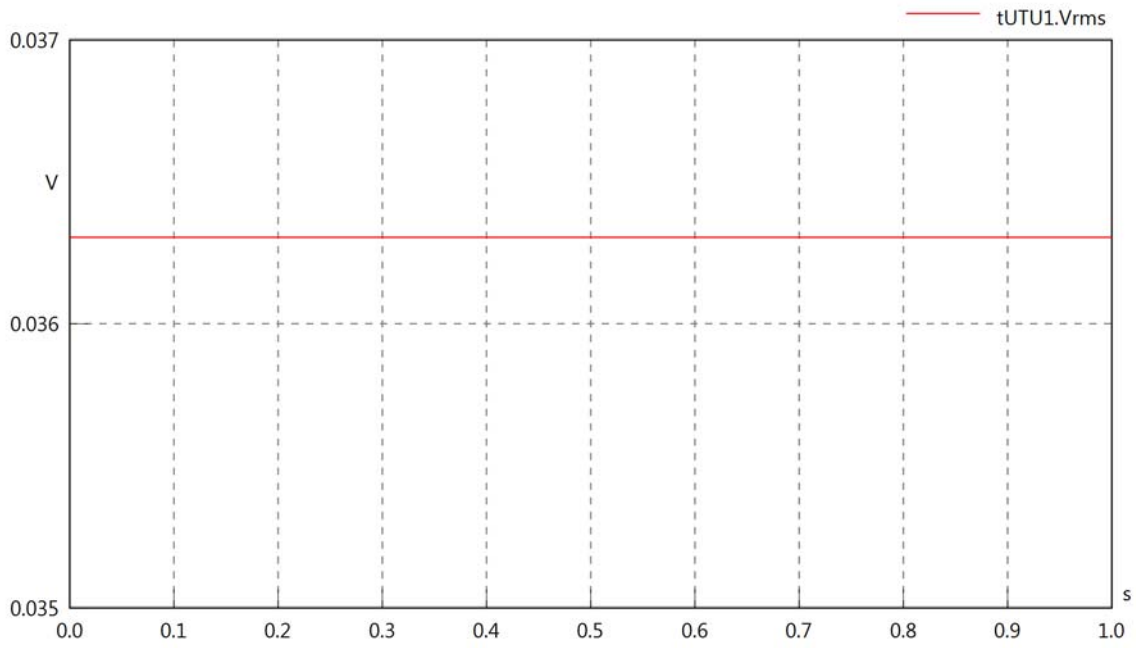

tUTU1.vRe

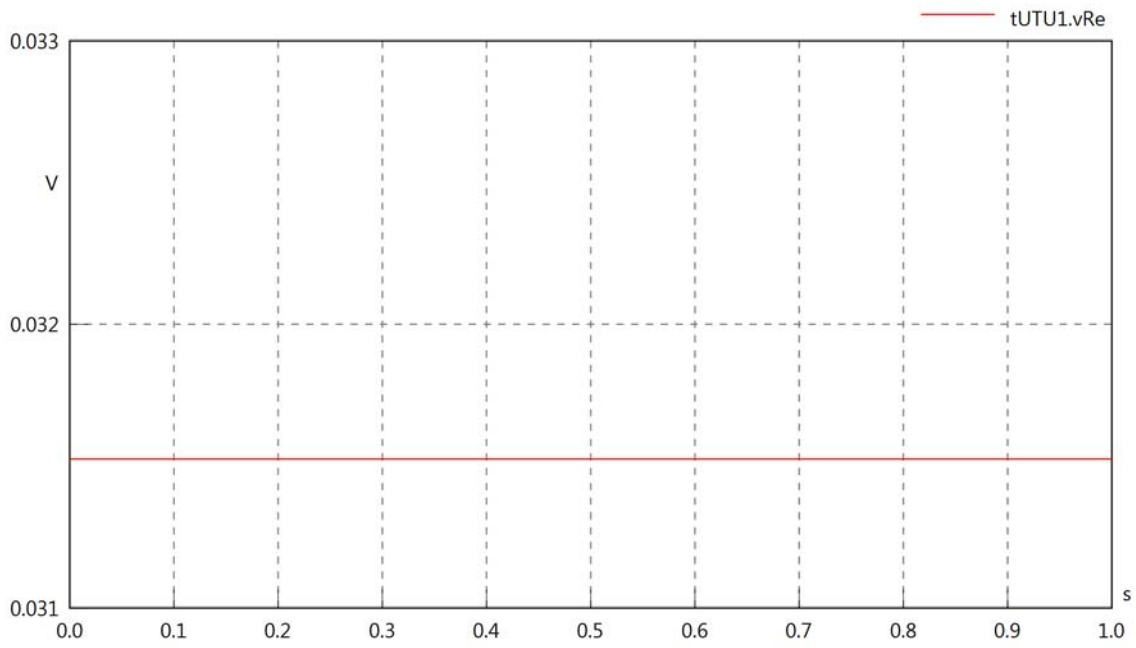

tUTU1.vIm

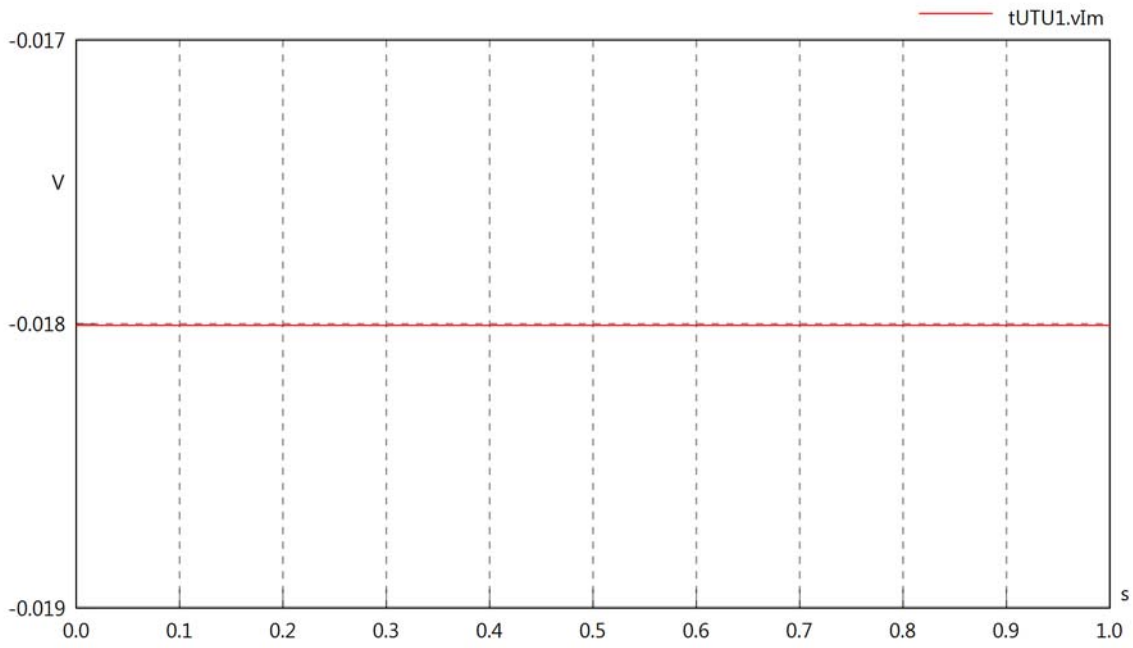

tUTU1.IrmsIn

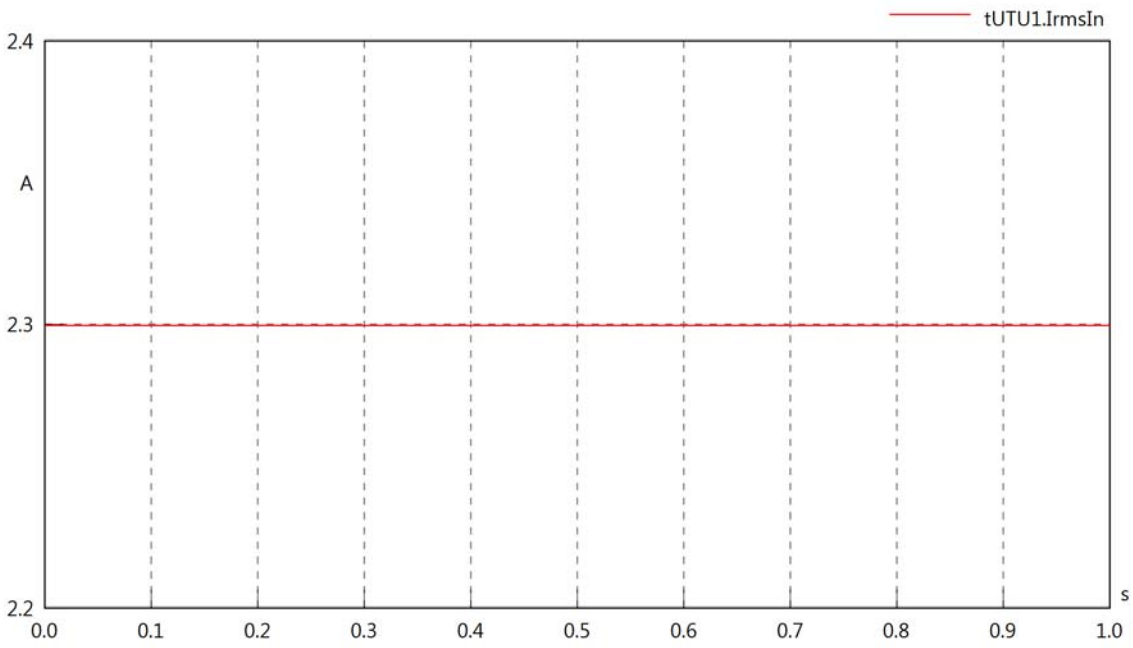

tUTU1.iReIn

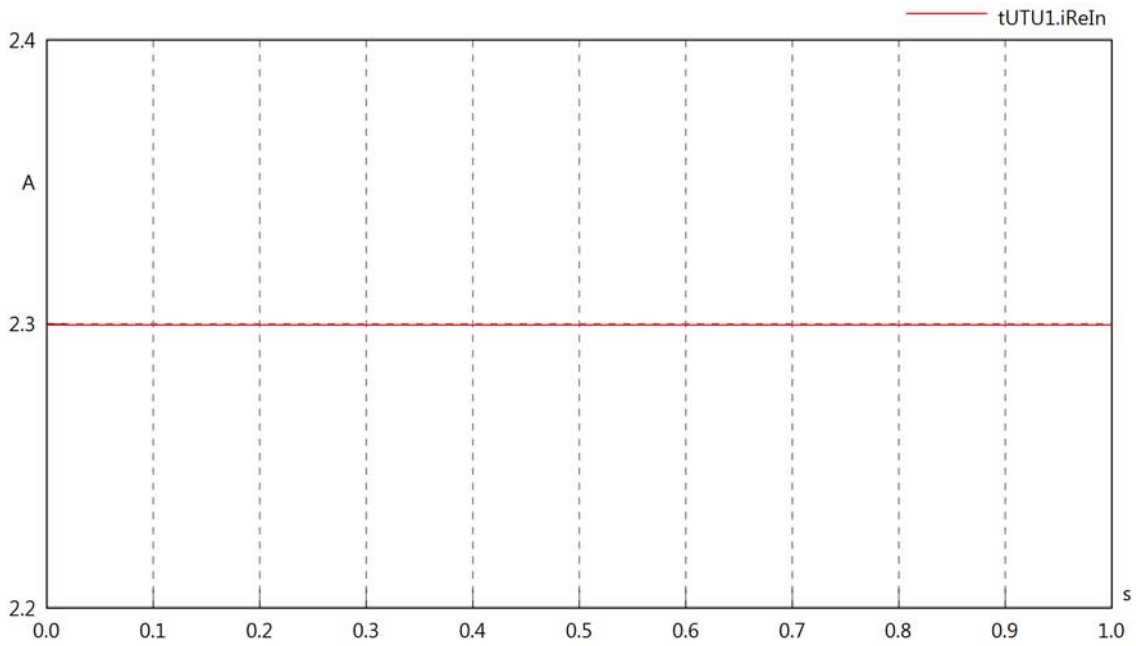

tUTU1.iImIn

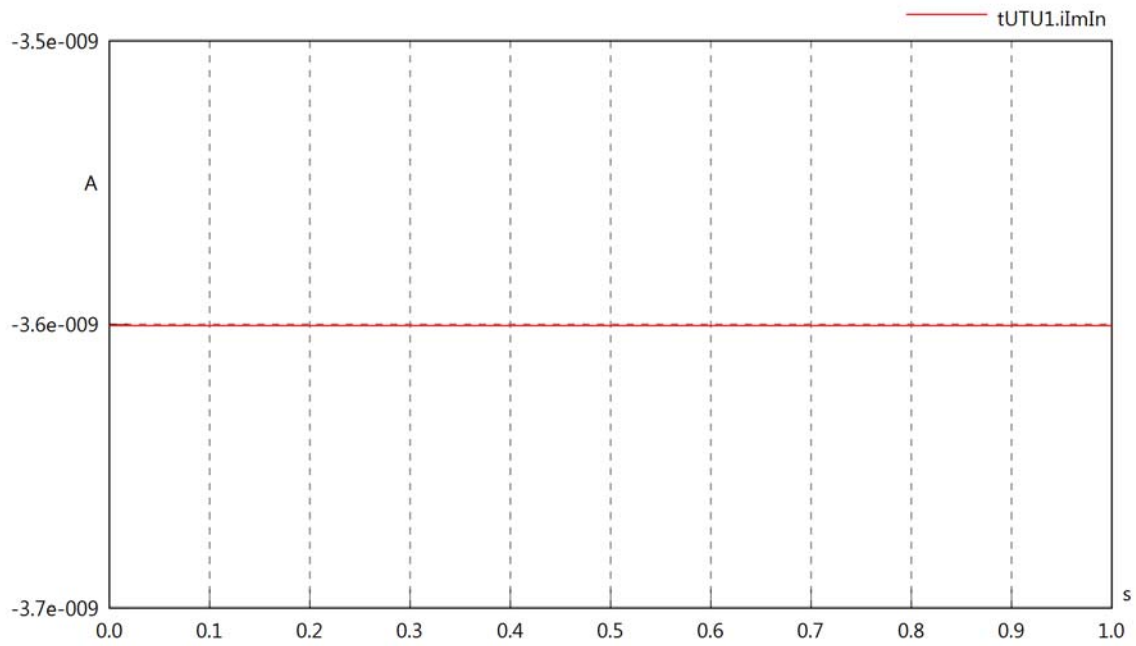

tUTU1.IrmsOut

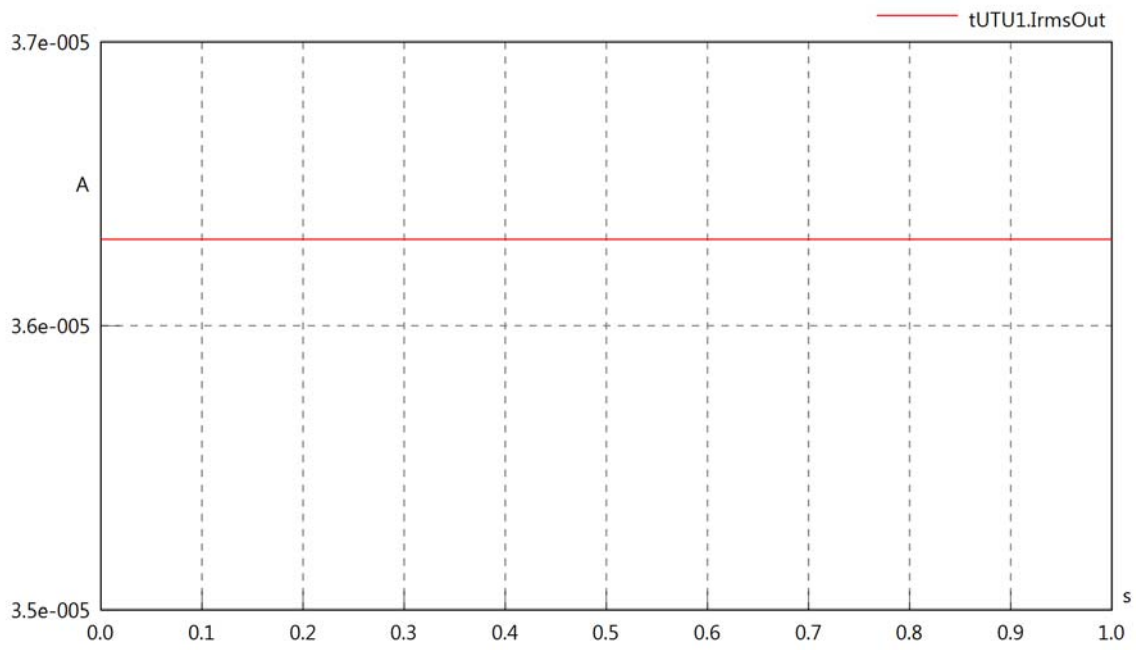

tUTU1.iReOut

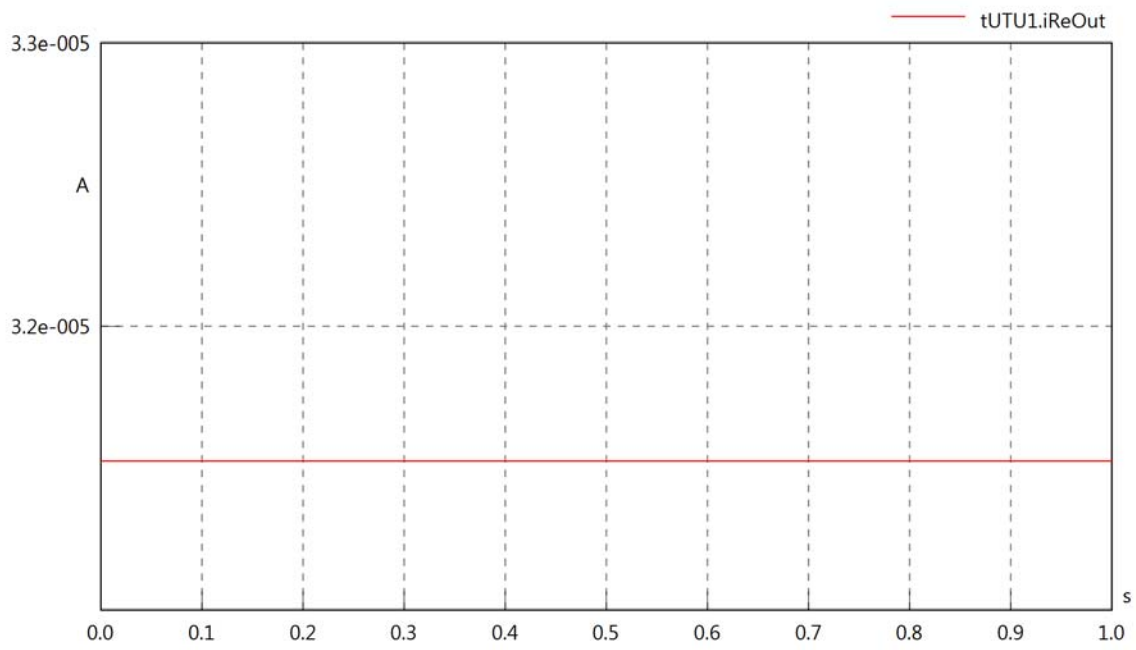

tUTU1.iImOut

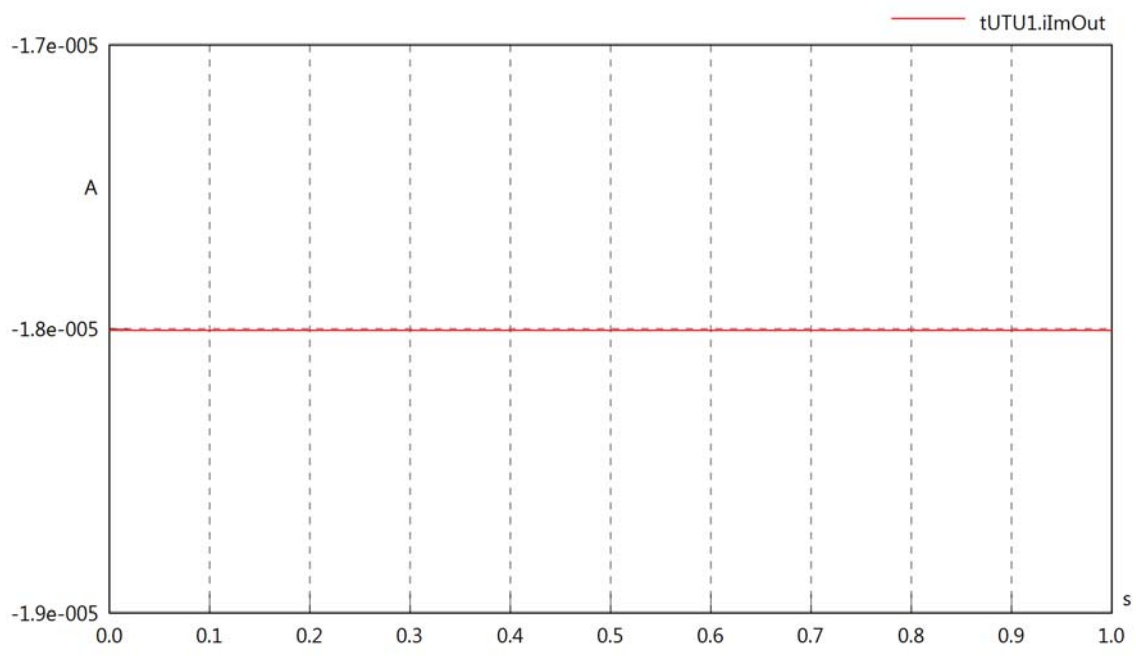

tUTU1.phiVIn

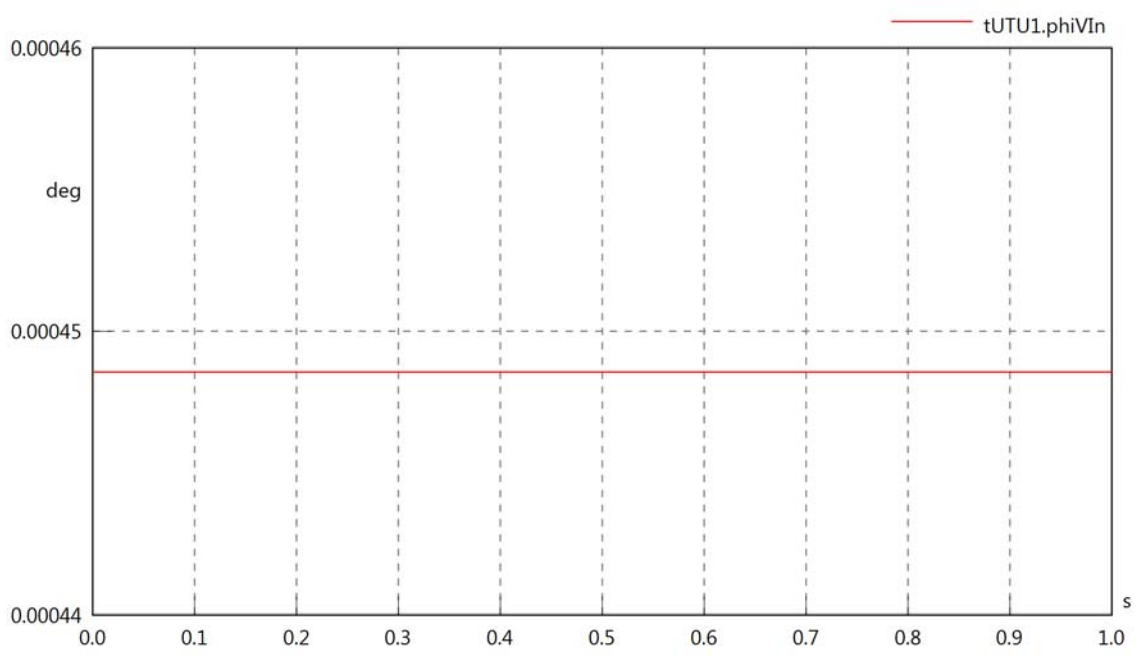

tUTU1.phiIIIn

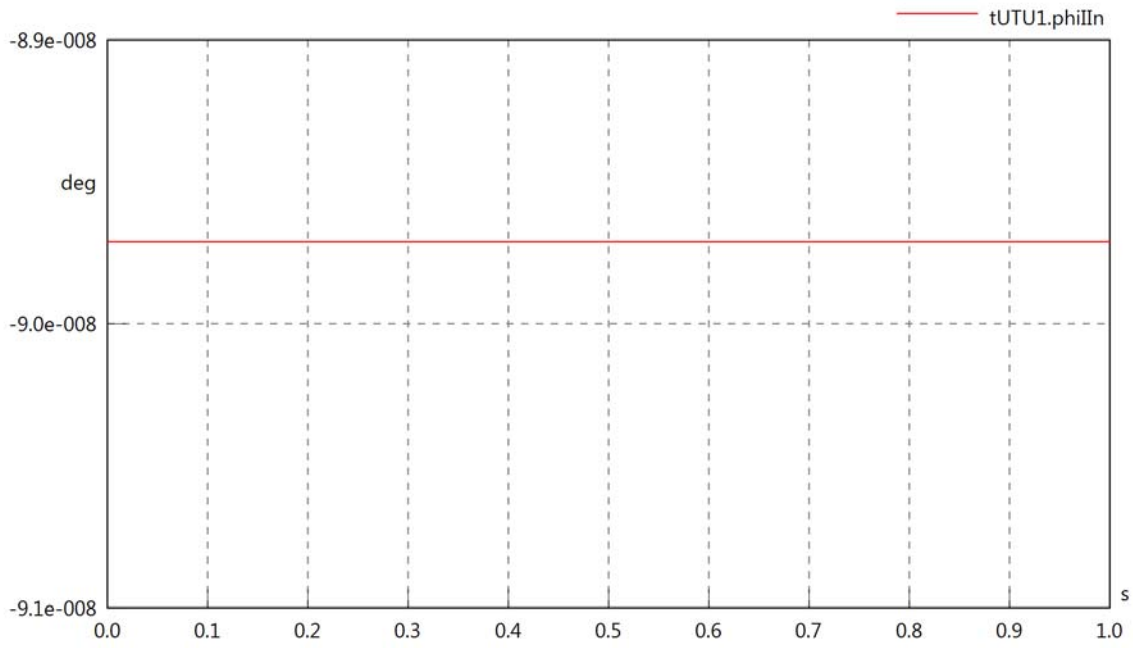

tUTU1.phiIVIn

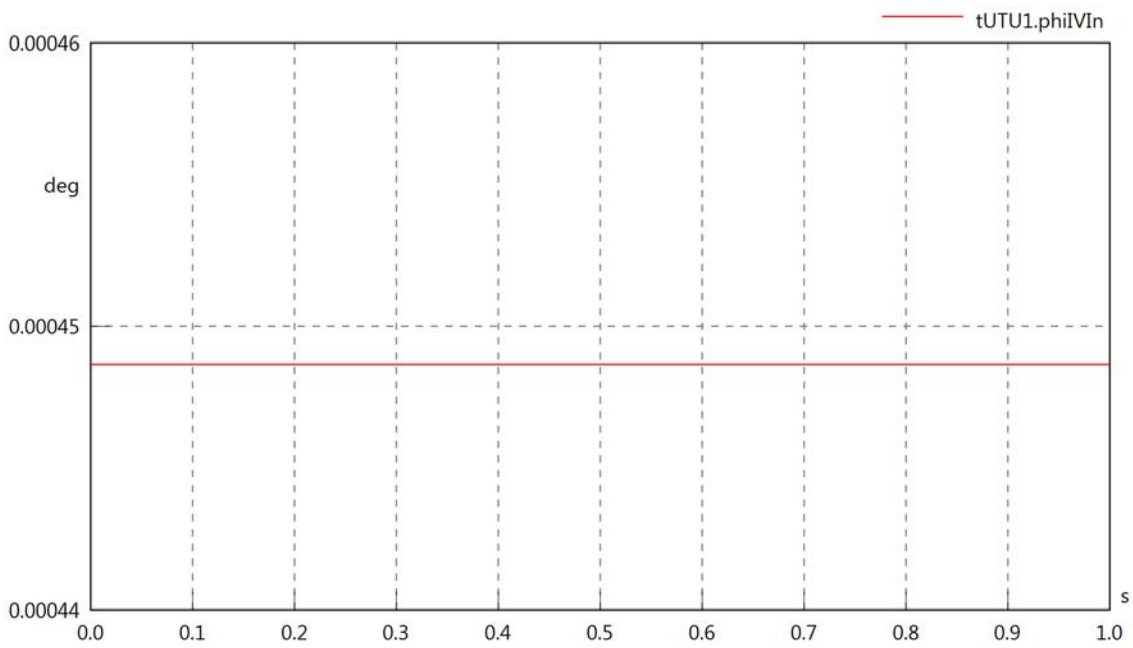

tUTU1.phiVOut

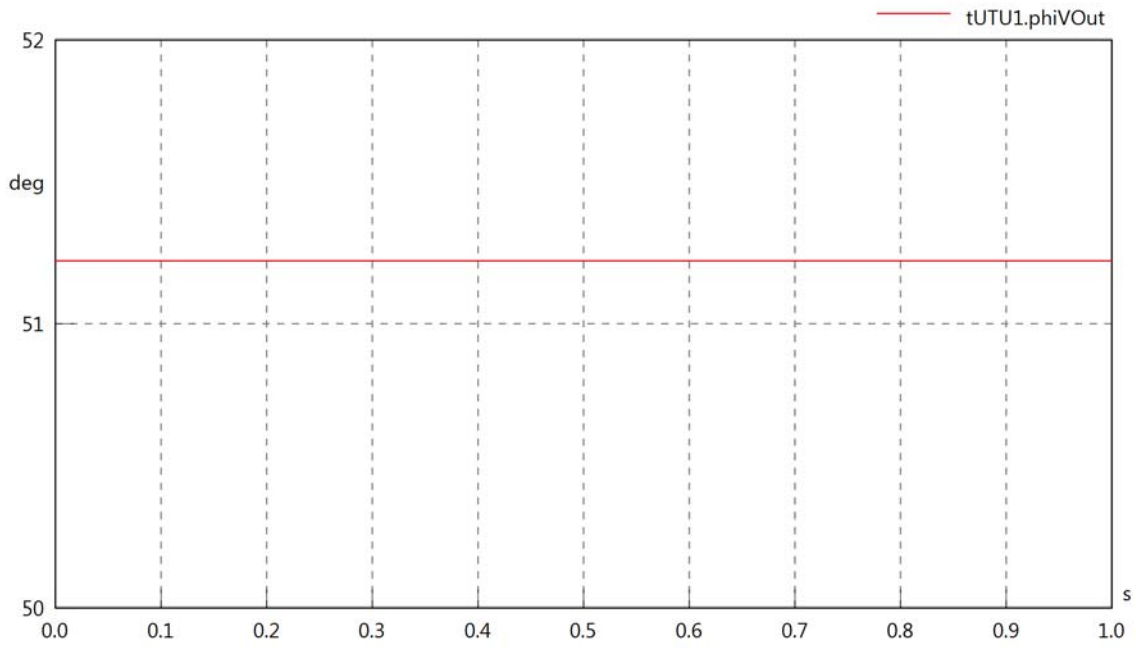

tUTU1.phiIOut

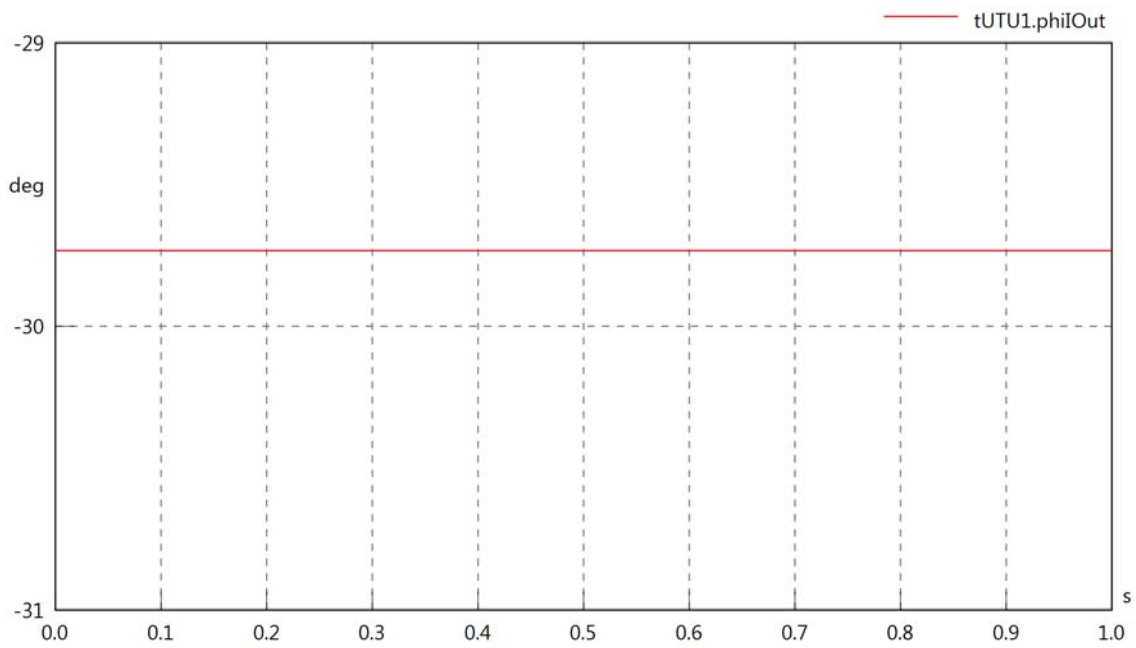

tUTU1.phiIVOut

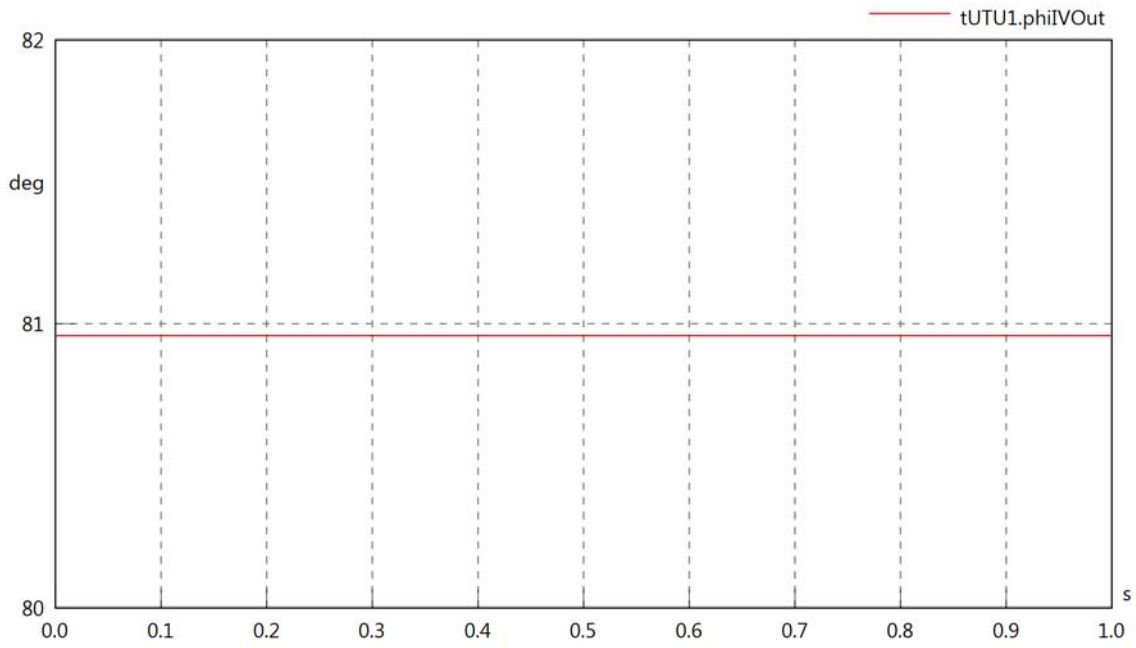

tUTU1.PReIn

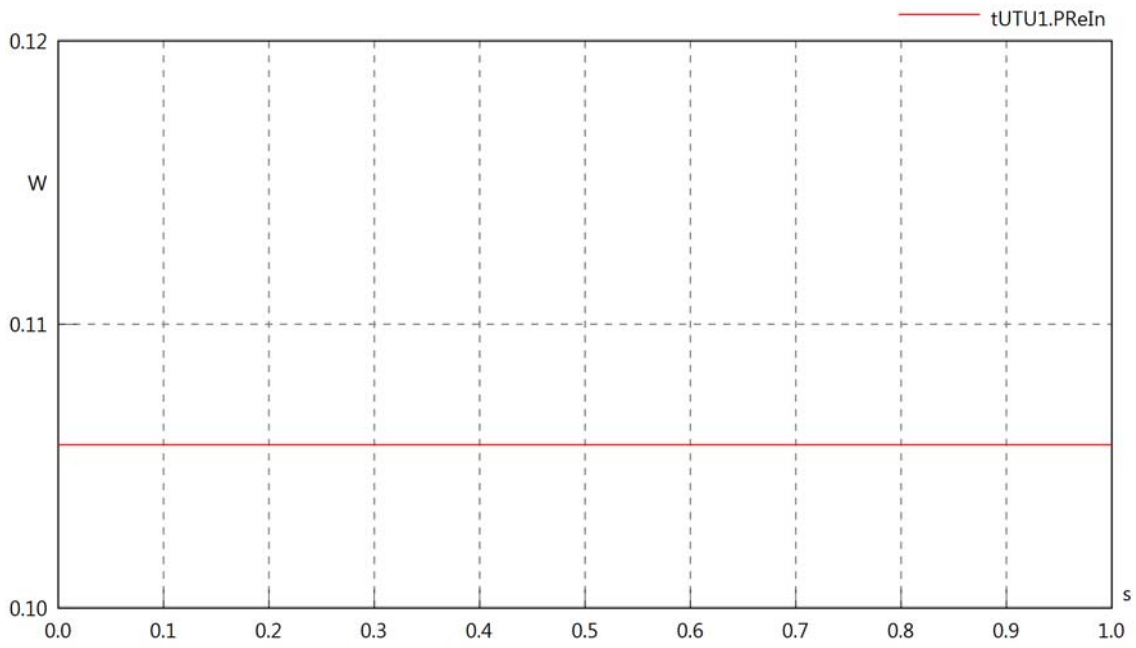

tUTU1.PImIn

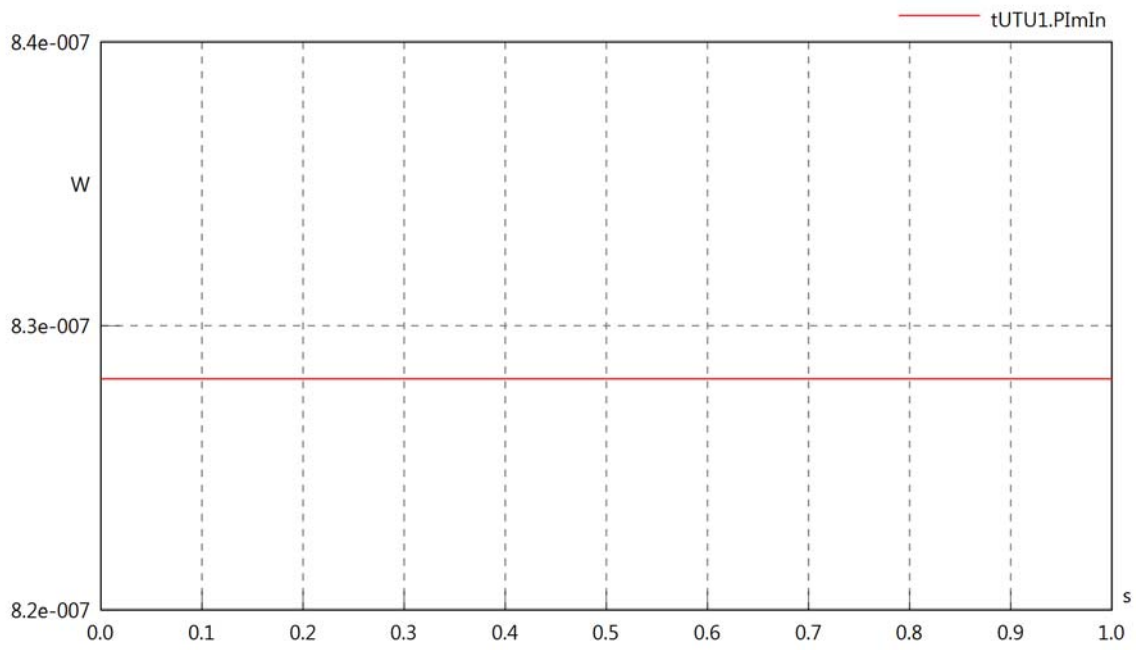

tUTU1.SIn

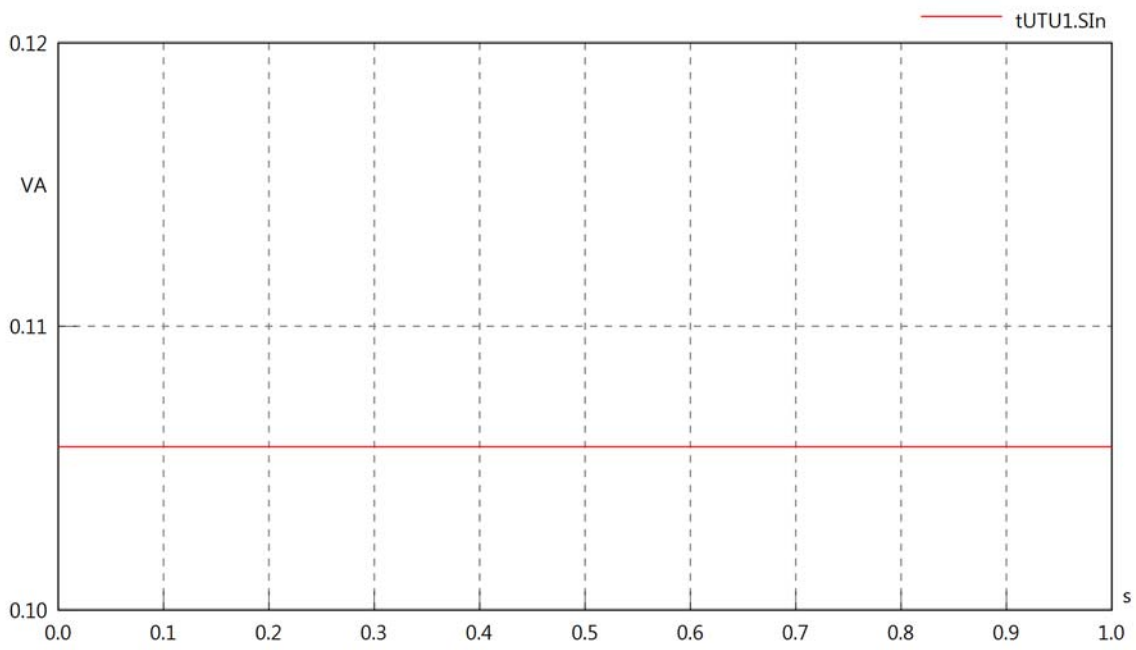

tUTU1.PReOut

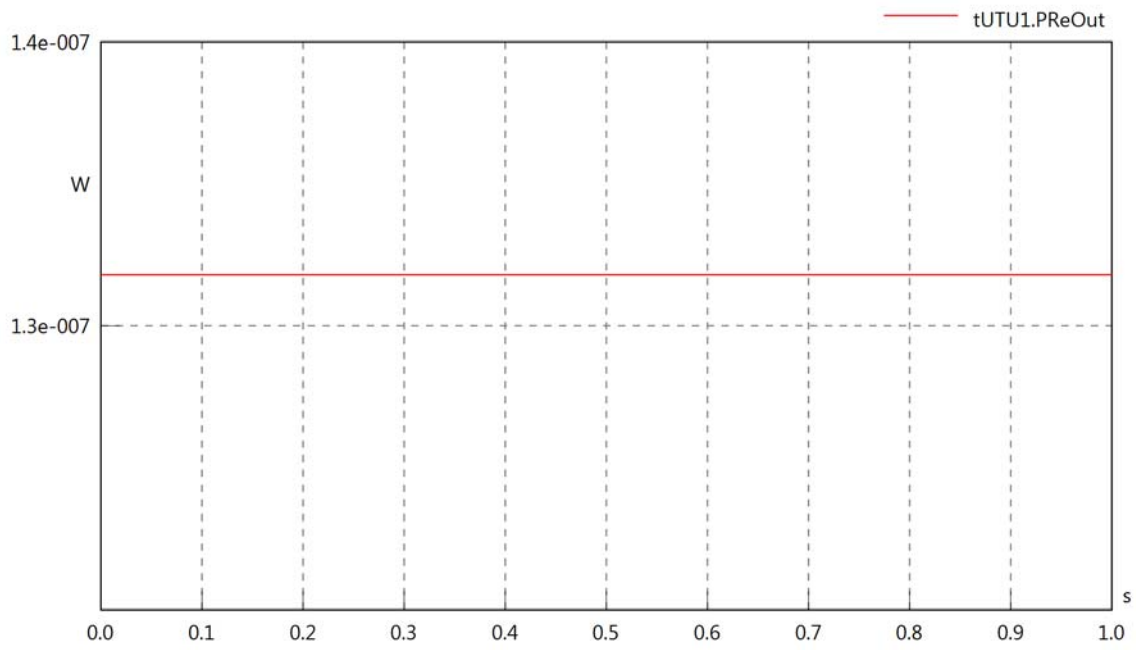

tUTU1.PImOut

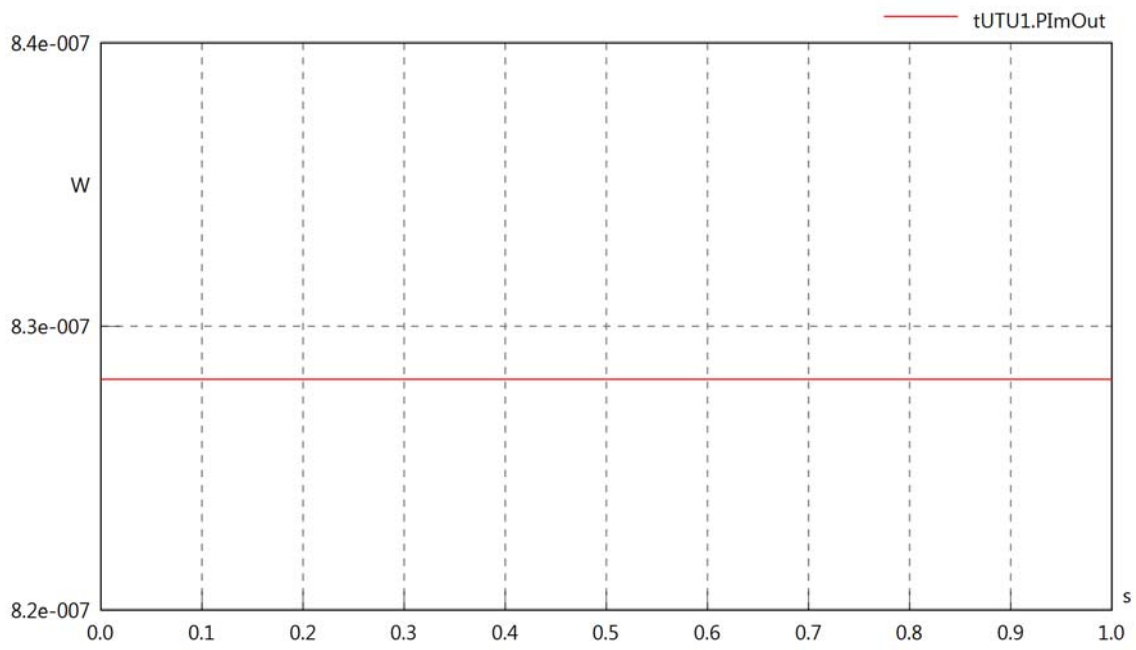

tUTU1.SOut

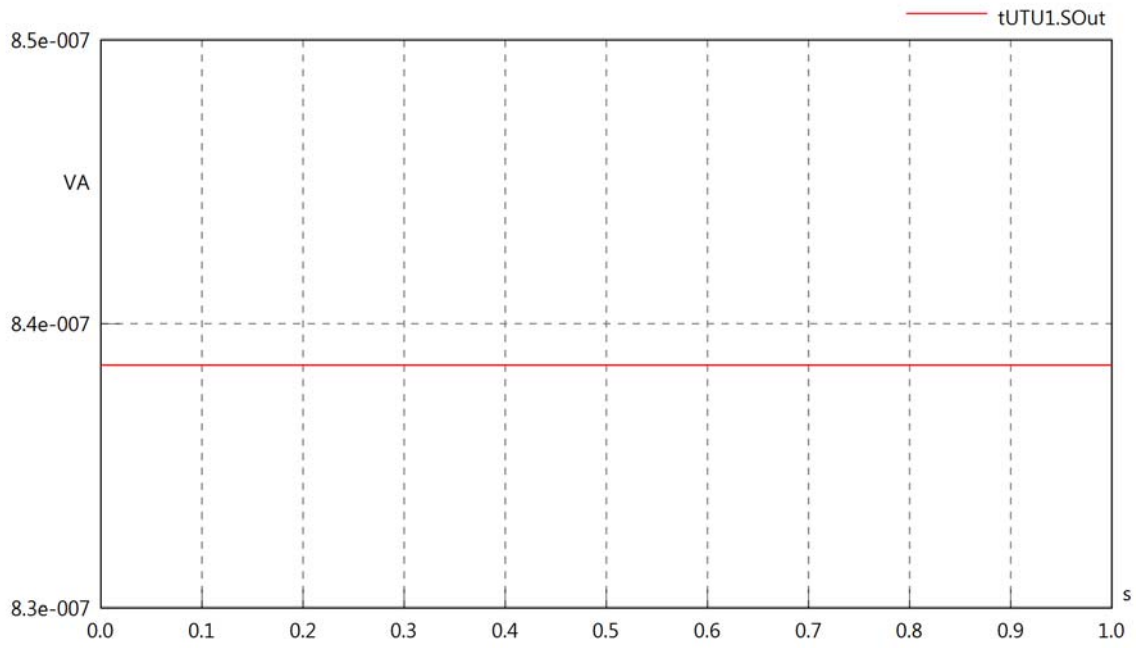
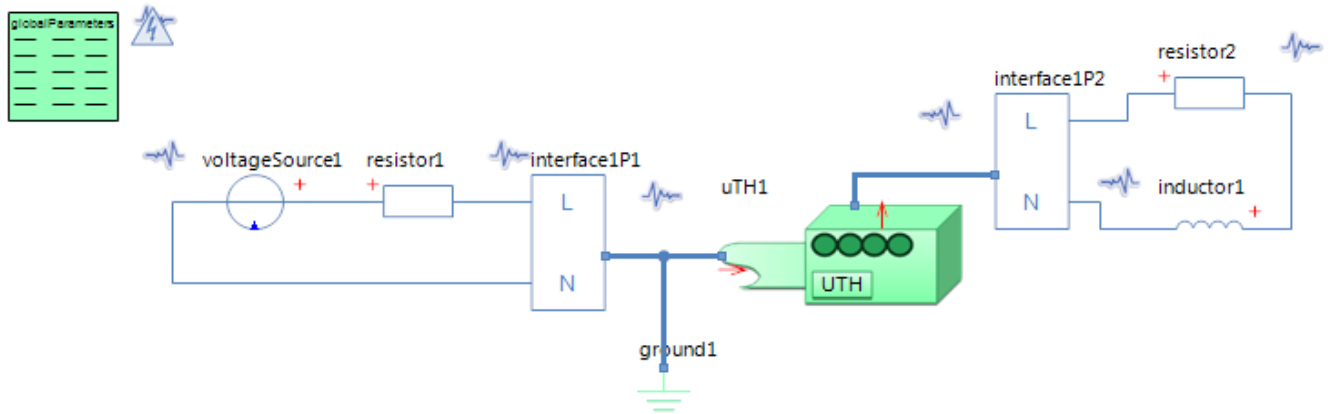

Diagram View



GlobalParameters globalParameters
Parameters

Comment	Name	Current Value	Unit
Type of Calculation	eCalculationKind	Signal Calculation	
Description of Frequency	eFrequencyKind	Linear	
Minimum Frequency	fMin	60	[Hz]
Maximum Frequency	fMax	60	[Hz]

Voltage Source voltageSource1
Parameters

Comment	Name	Current Value	Unit
Voltage RMS	VrmsSrc	230	[V]
Phase	phi	0	[deg]

Resistor resistor1
Parameters

Comment	Name	Current Value	Unit
Resistance	R	100	[Ohm]

Resistor resistor2
Parameters

Comment	Name	Current Value	Unit
Resistance	R	100	[Ohm]

Inductor inductor1
Parameters

Comment	Name	Current Value	Unit
Inductance	L	5	[mH]

Umbilical Termination Head uTH1
Parameters

Comment	Name	Current Value	Unit
Poor or failing L1 connection	bL1	false	

uTH1.VrmsIn

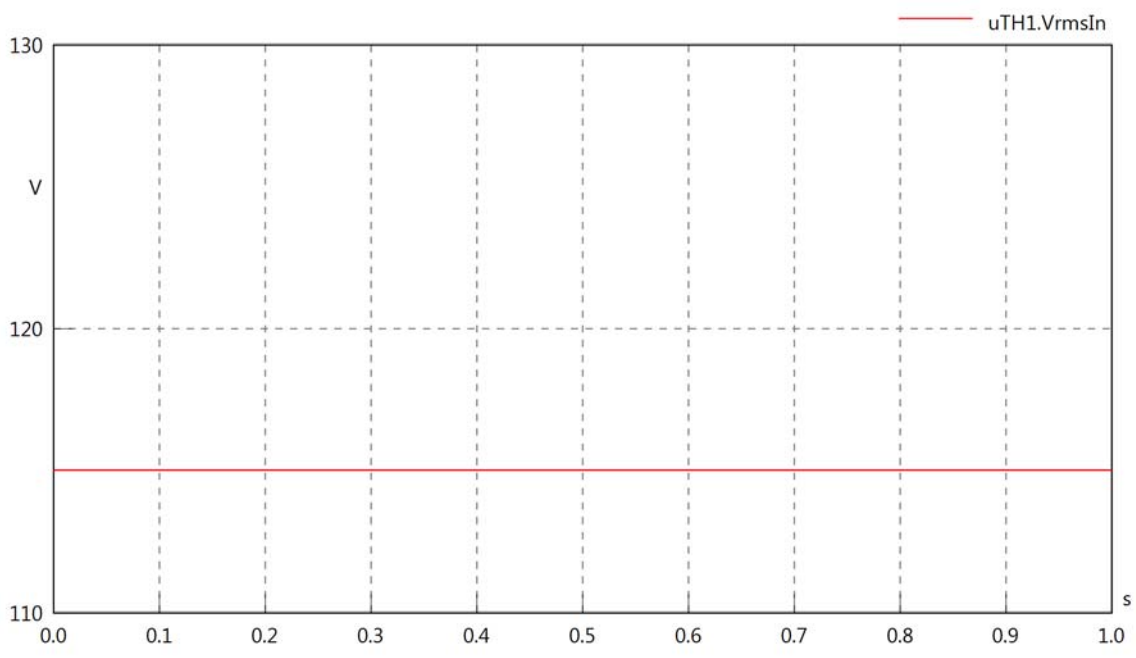

uTH1.vReIn

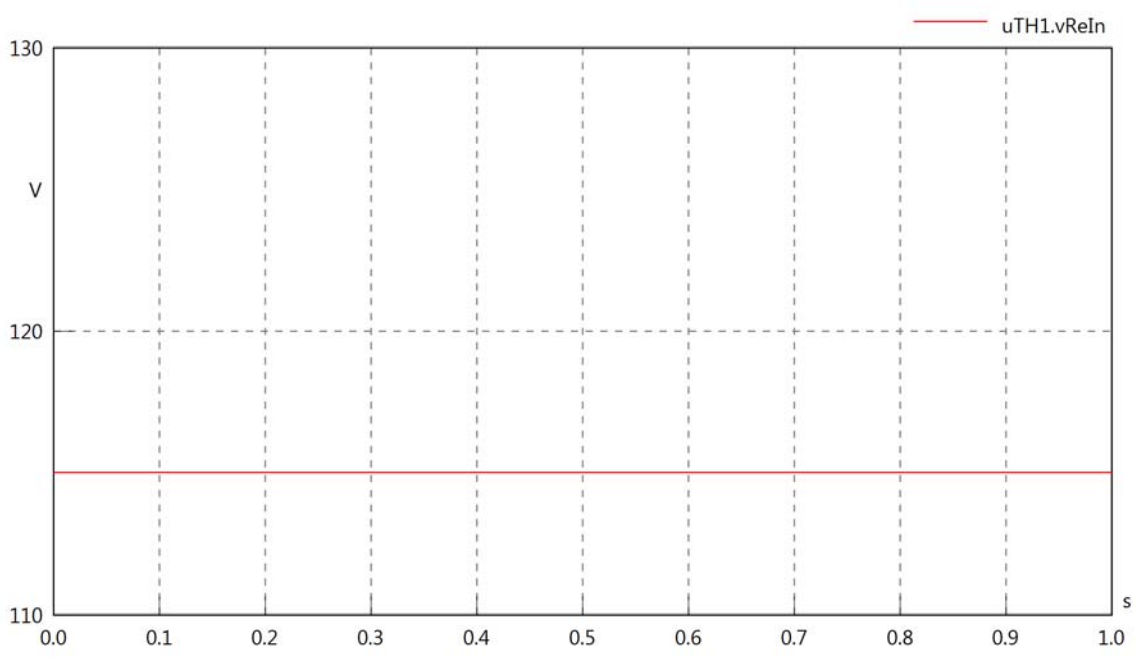

uTH1.vImIn

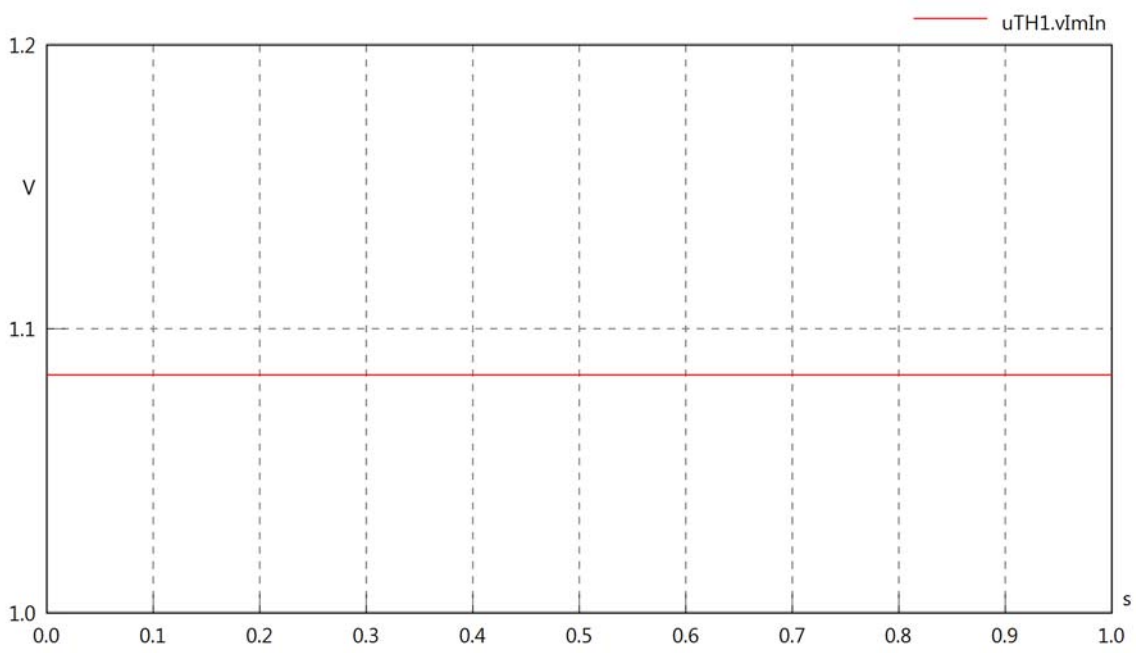

uTH1.VrmsOut

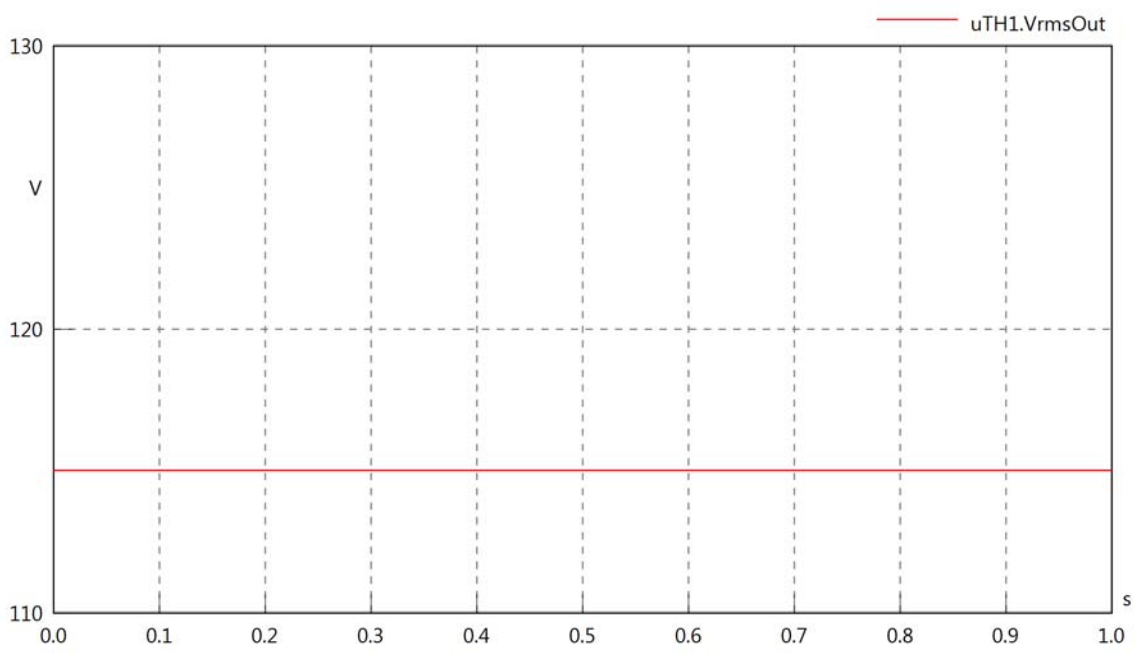

uTH1.vReOut

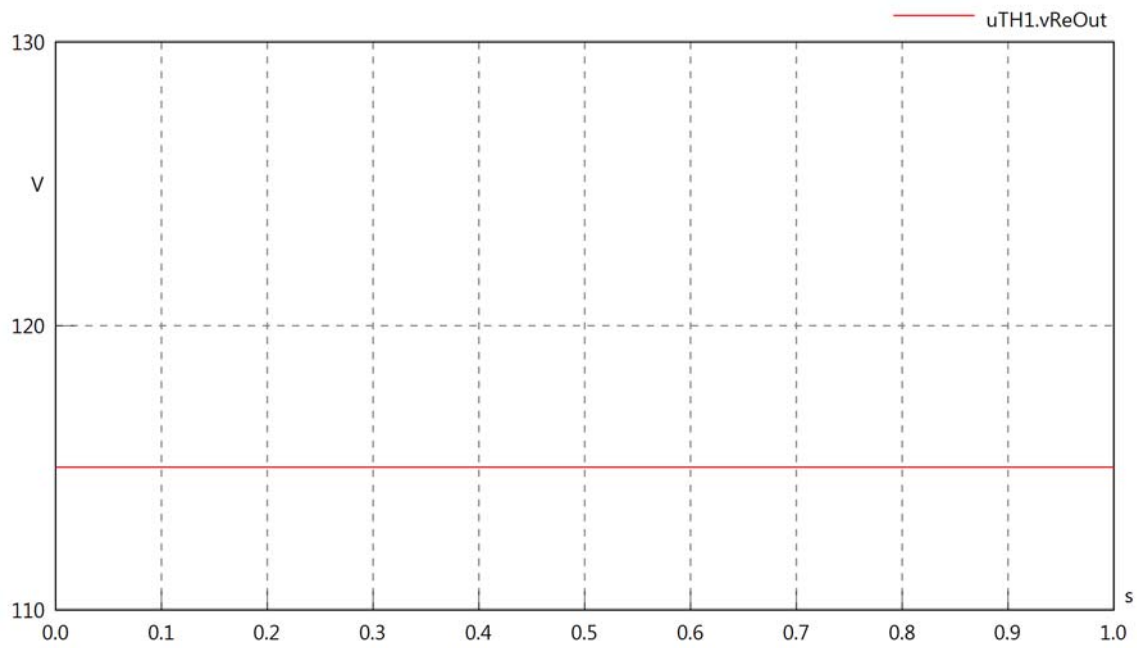

uTH1.vImOut

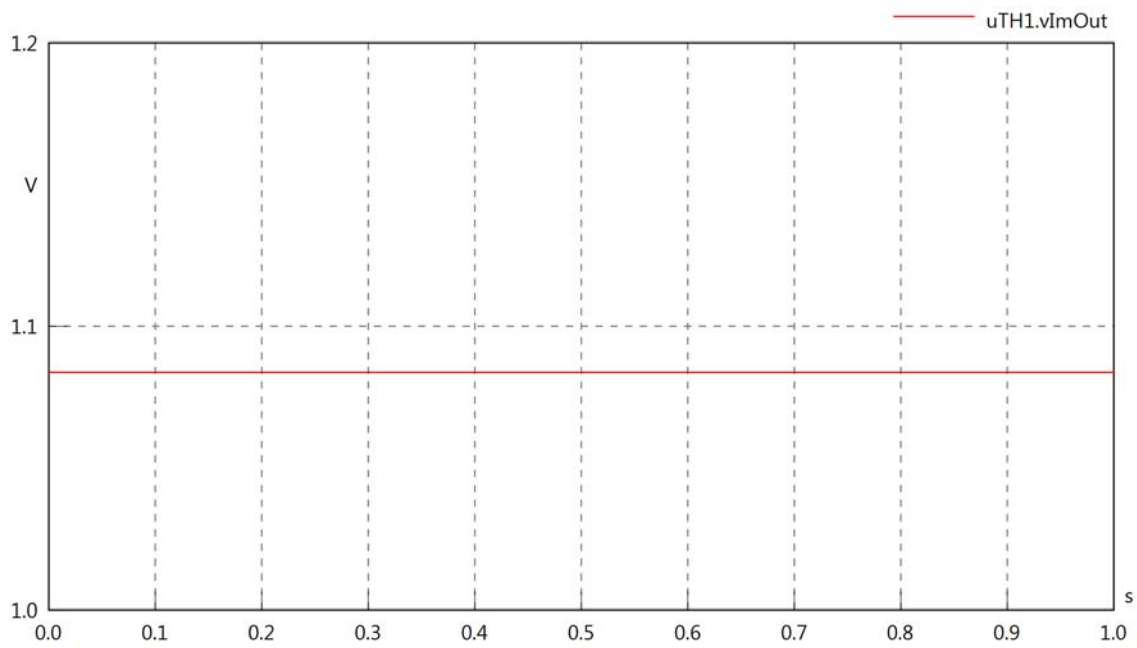

uTH1.Vrms

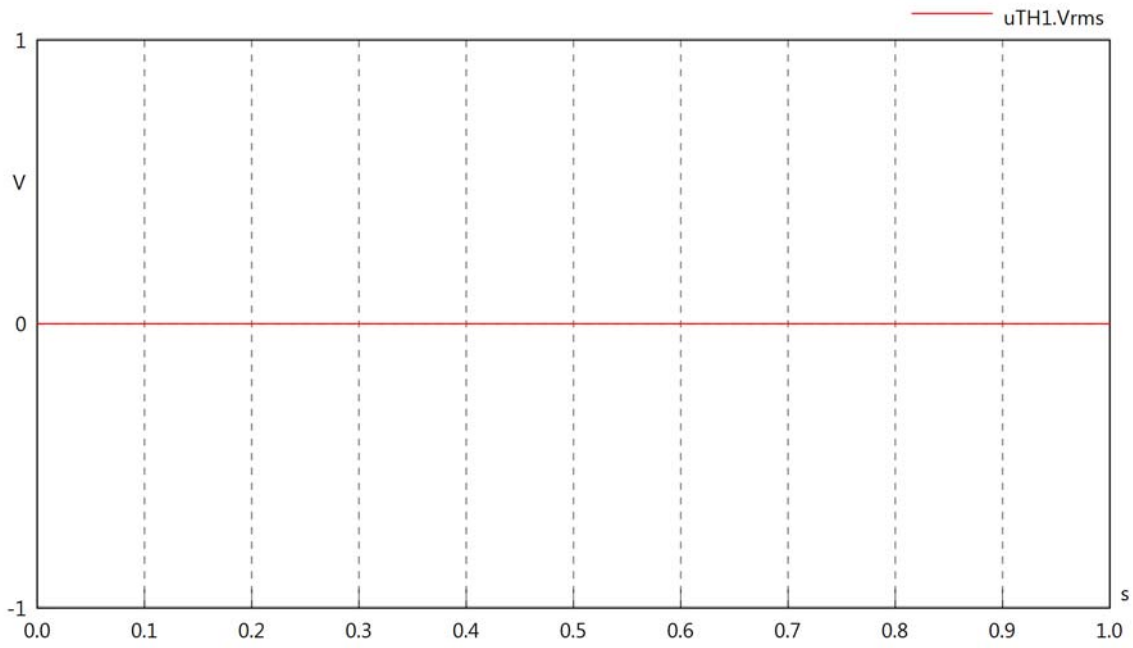

uTH1.vRe

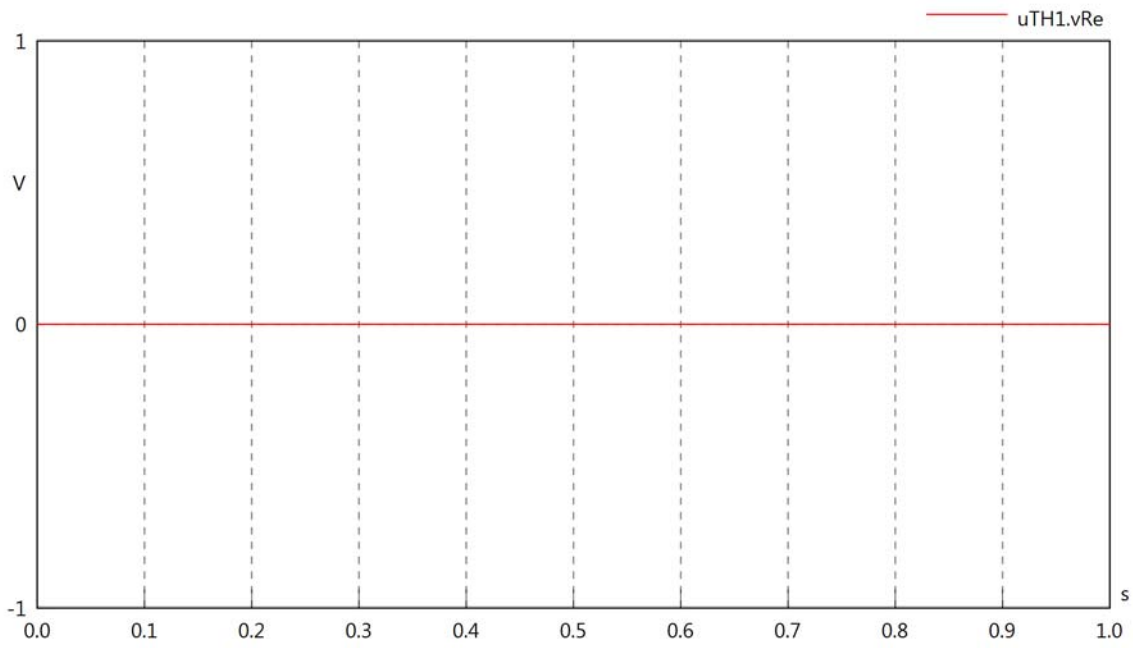

uTH1.vIm

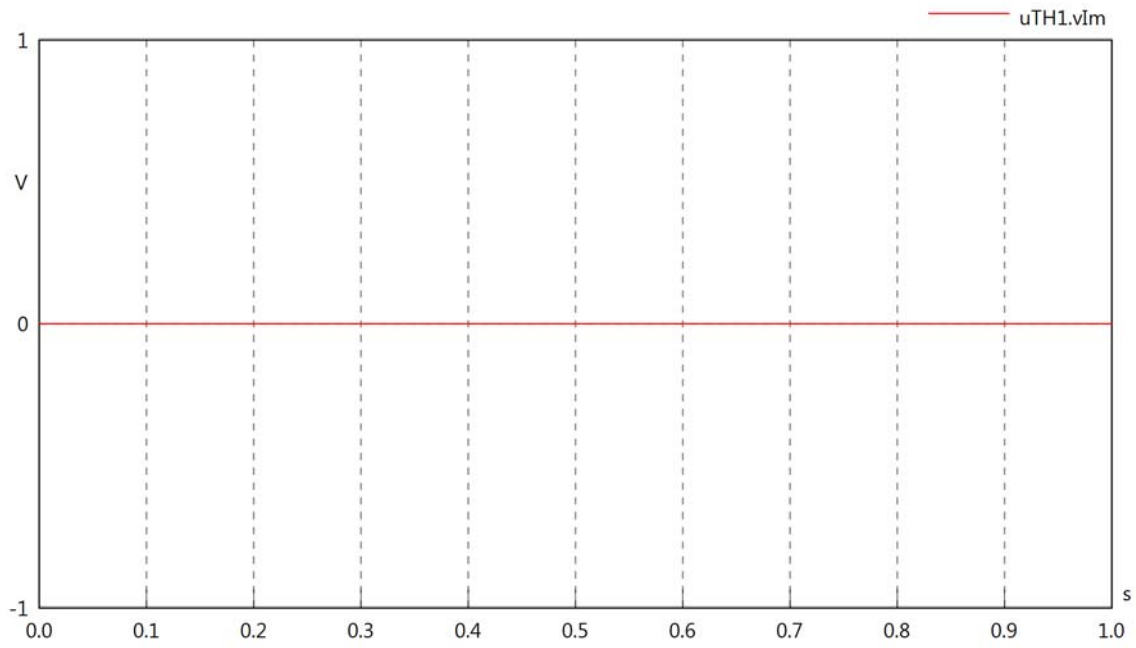

uTH1.IrmsIn

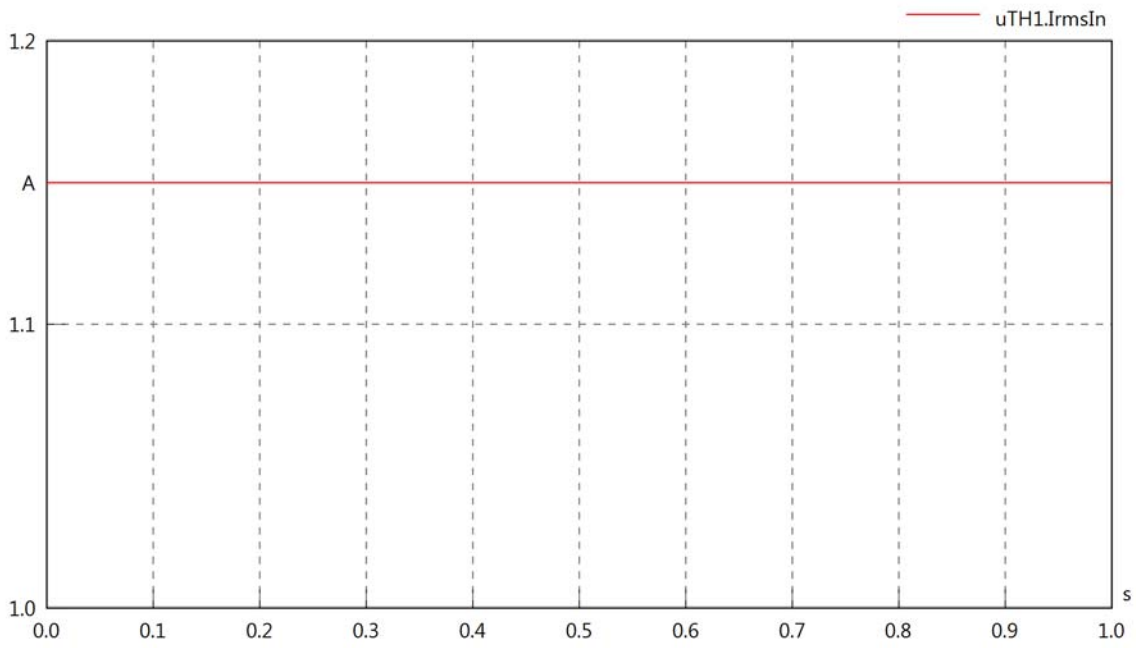

uTH1.iReIn

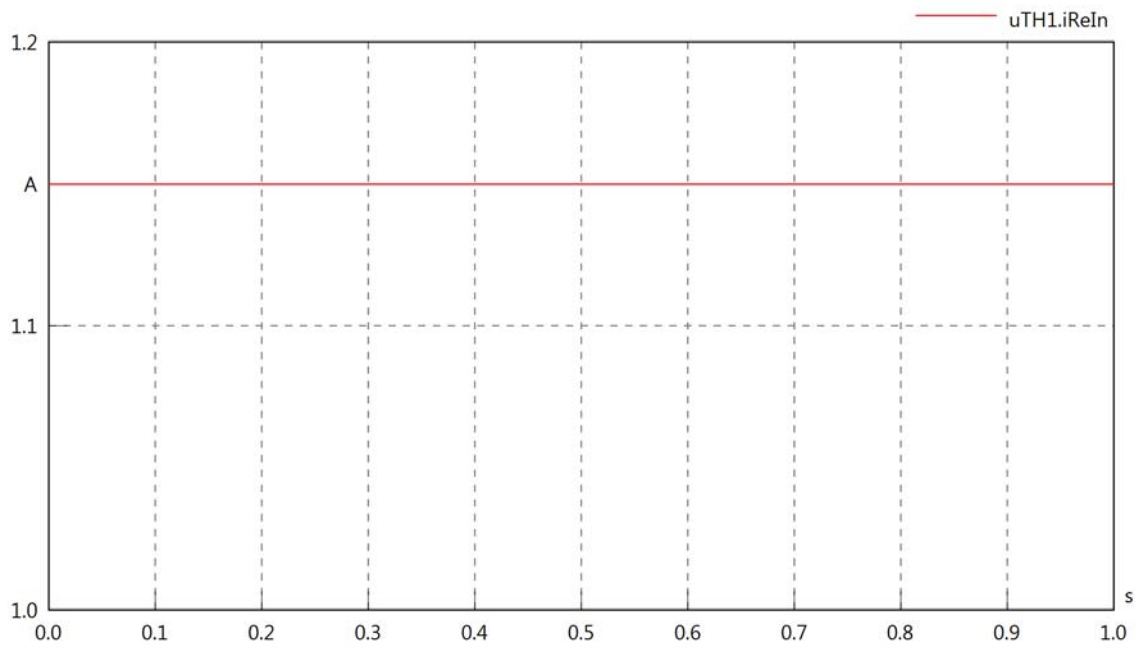

uTH1.ilmIn

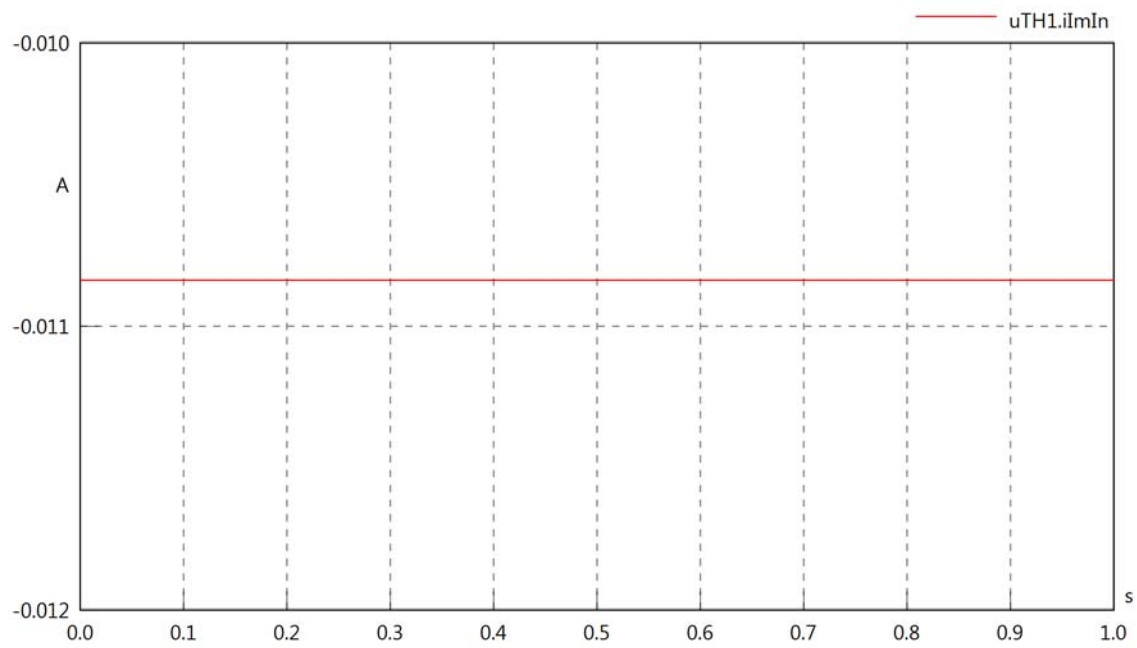

uTH1.IrmsOut

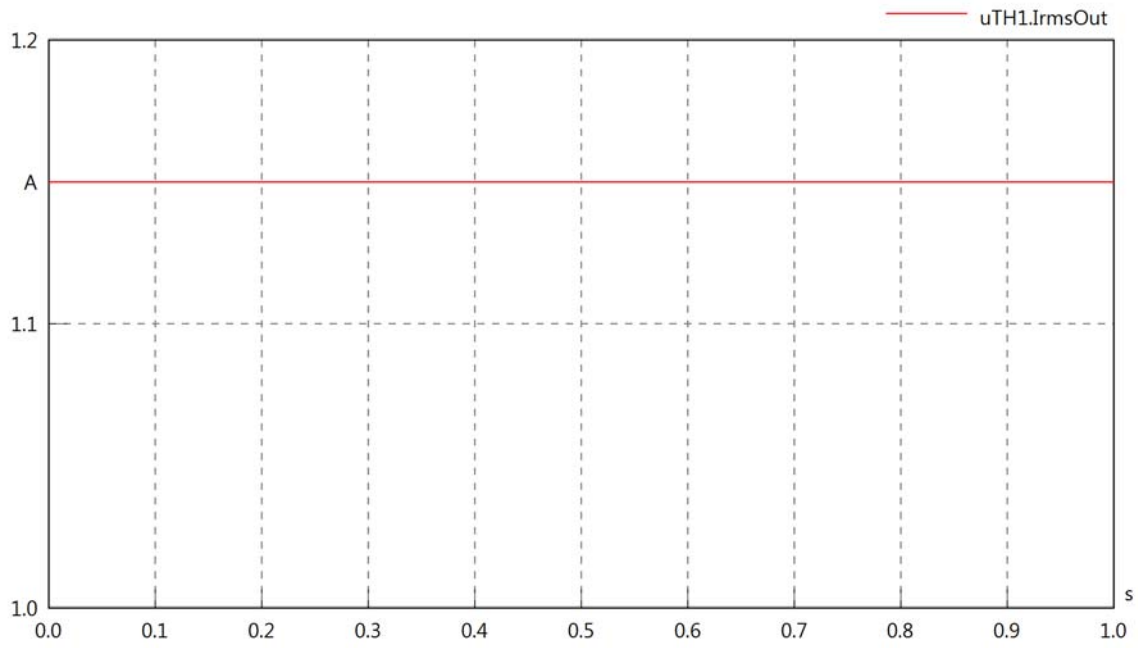

uTH1.iReOut

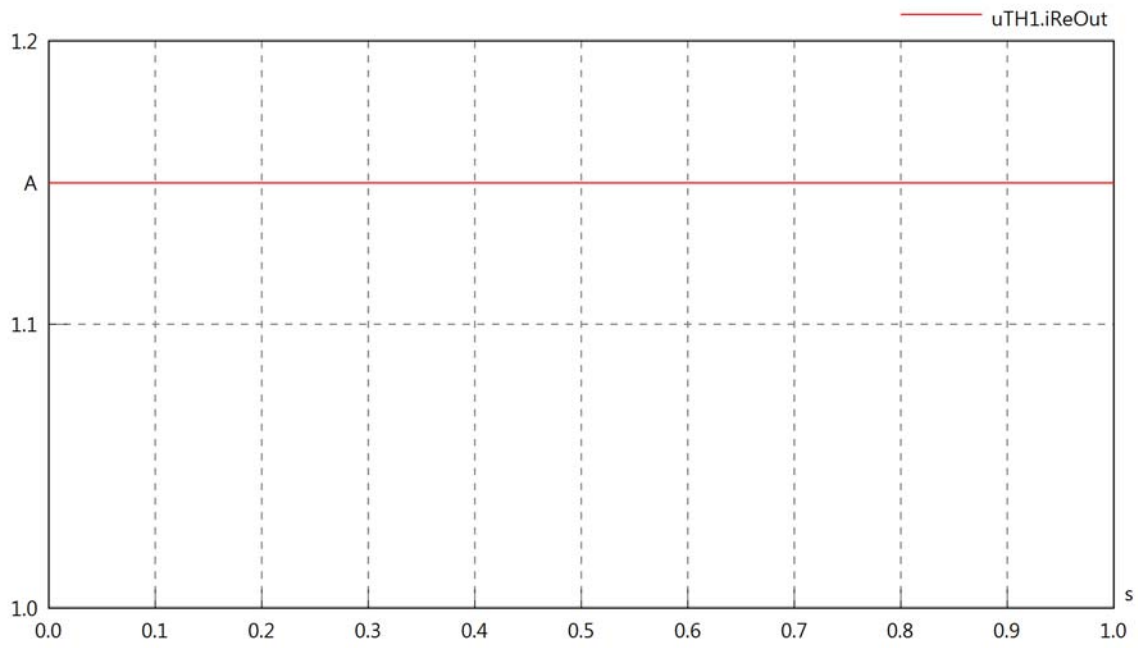

uTH1.iImOut

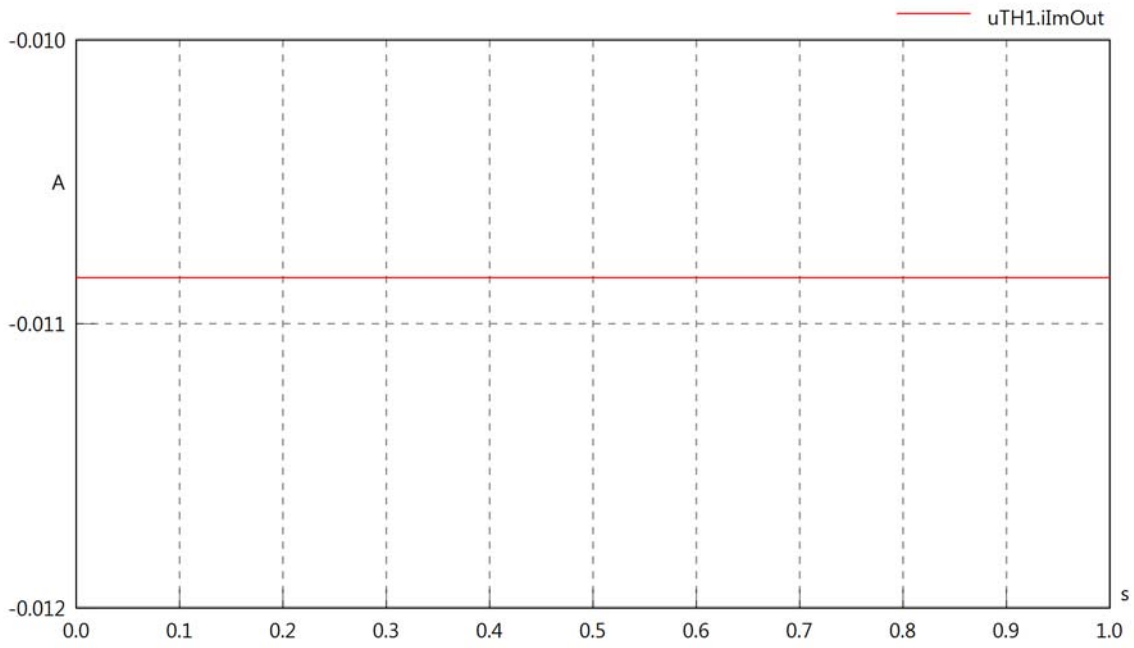

uTH1.phiVIn

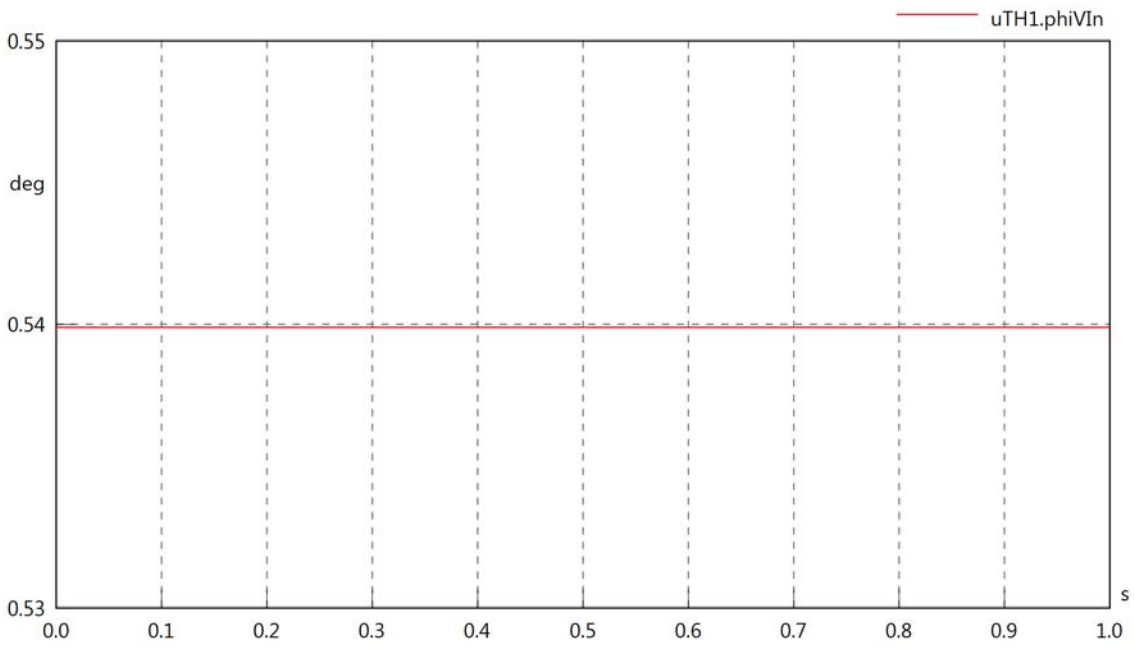

uTH1.philIn

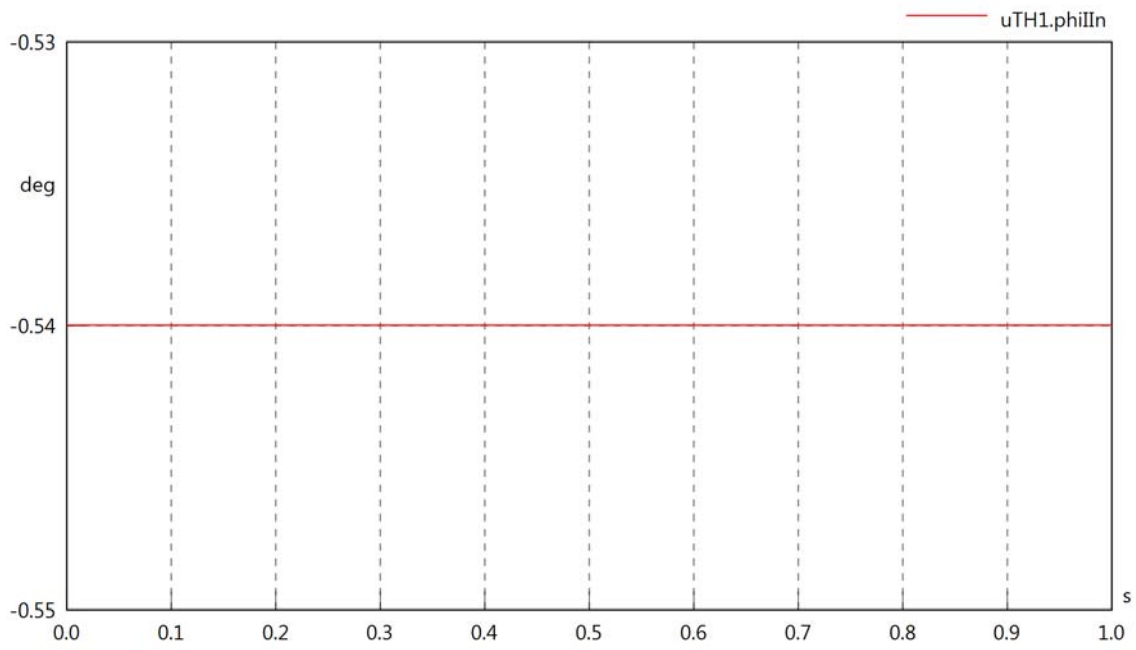

uTH1.philVIn

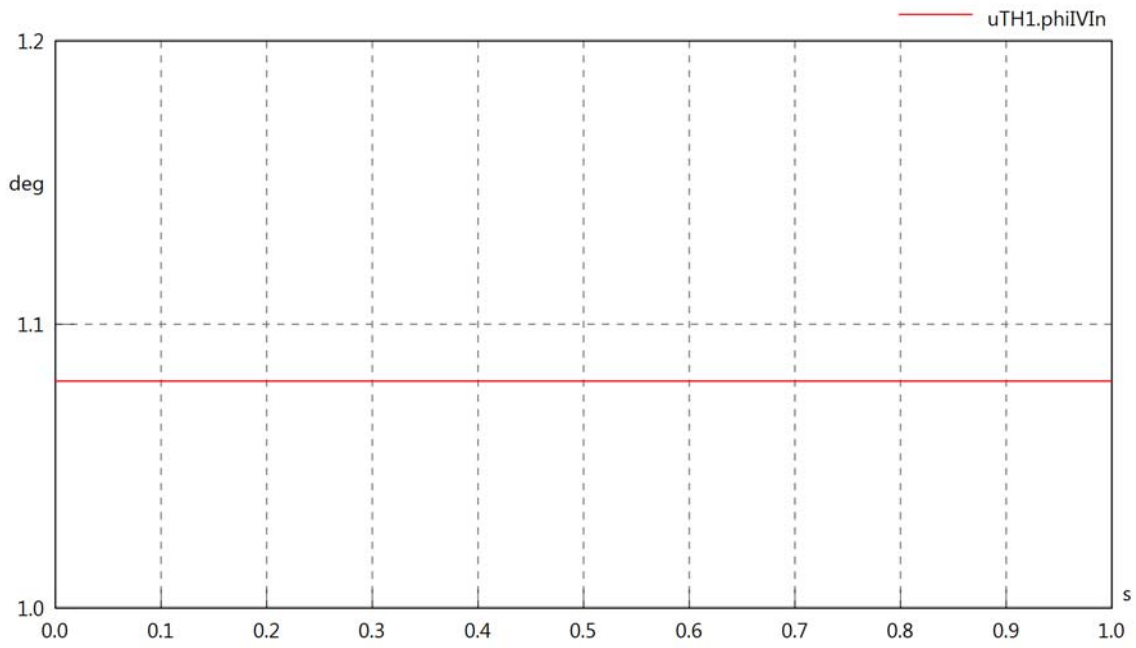

uTH1.phiVOut

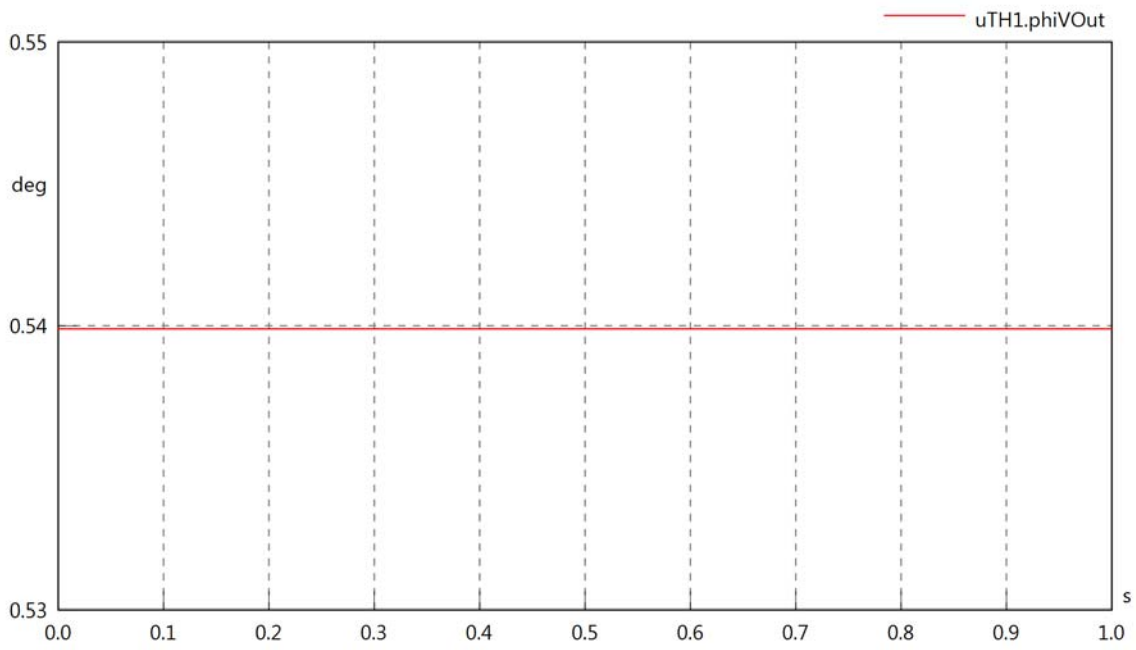

uTH1.philOut

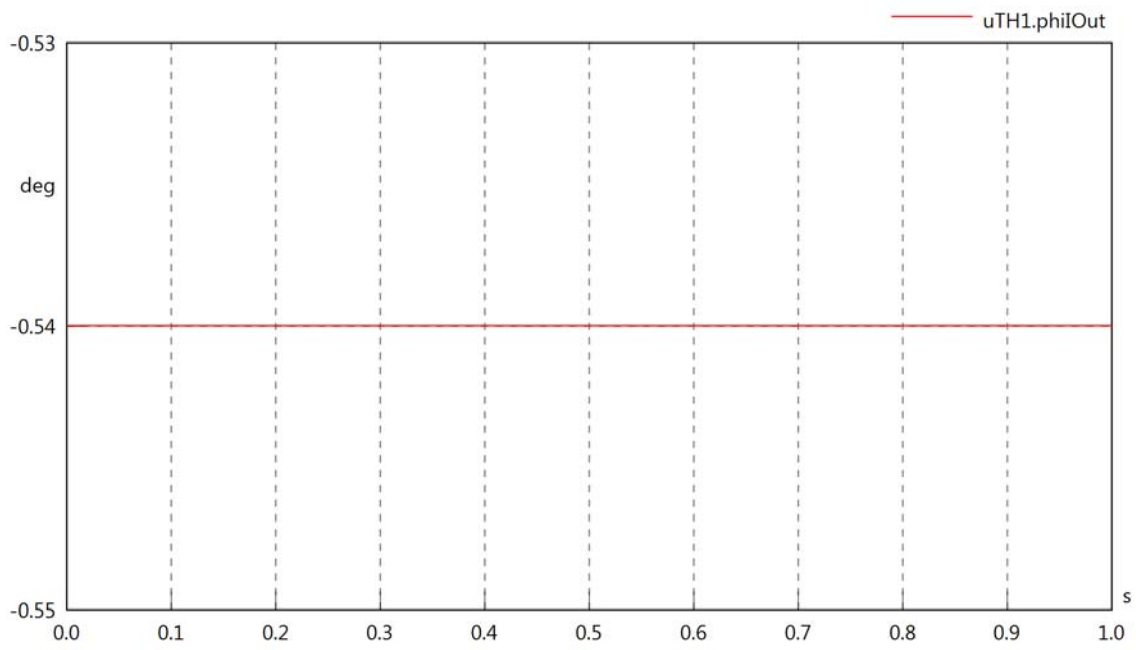

uTH1.philVOut

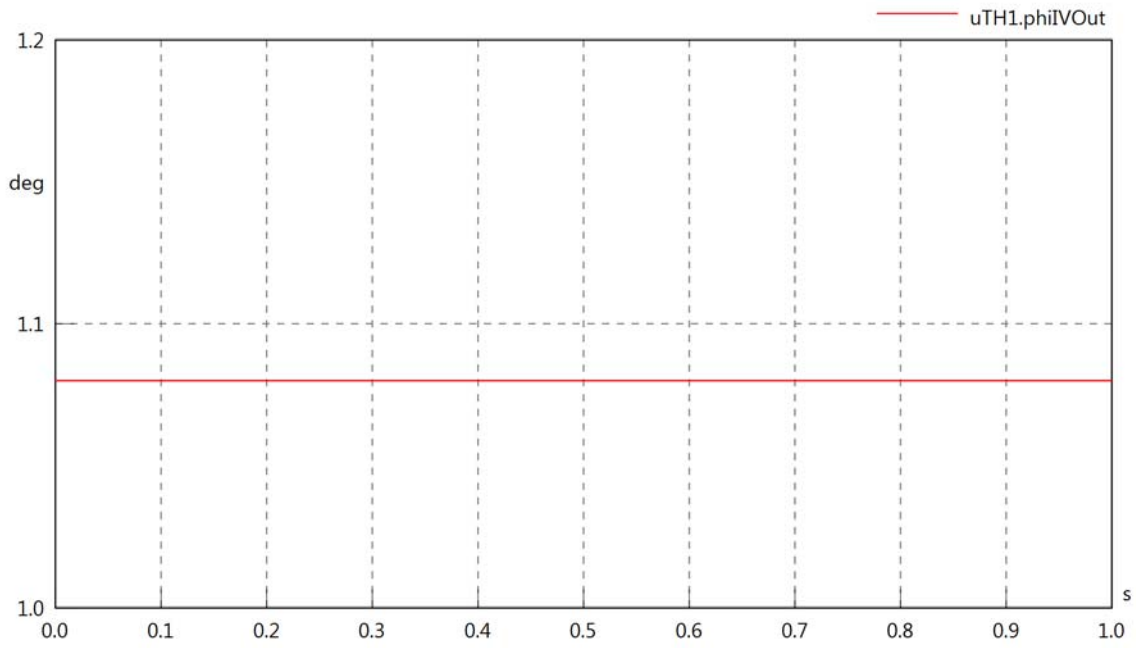

uTH1.PReIn

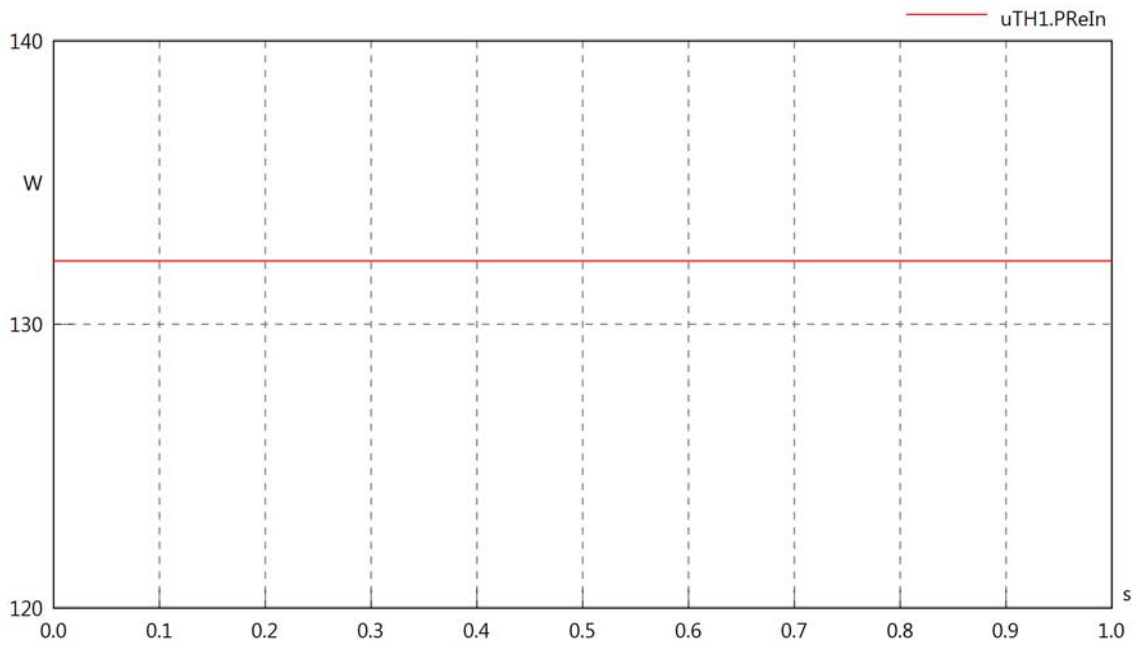

uTH1.PImIn

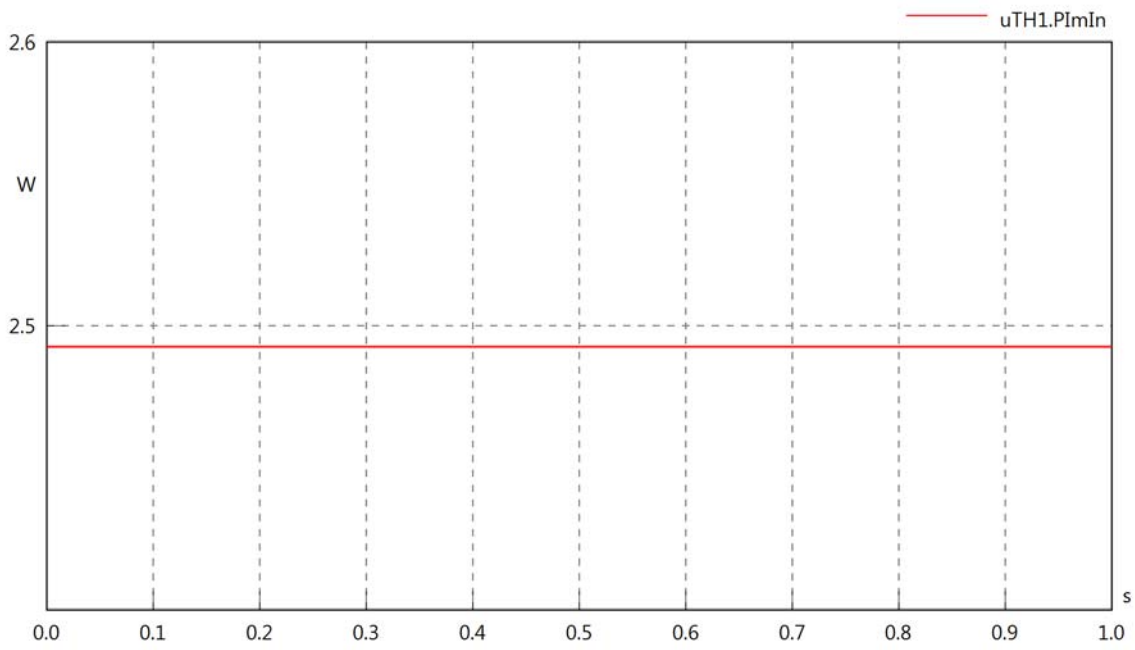

uTH1.SIn

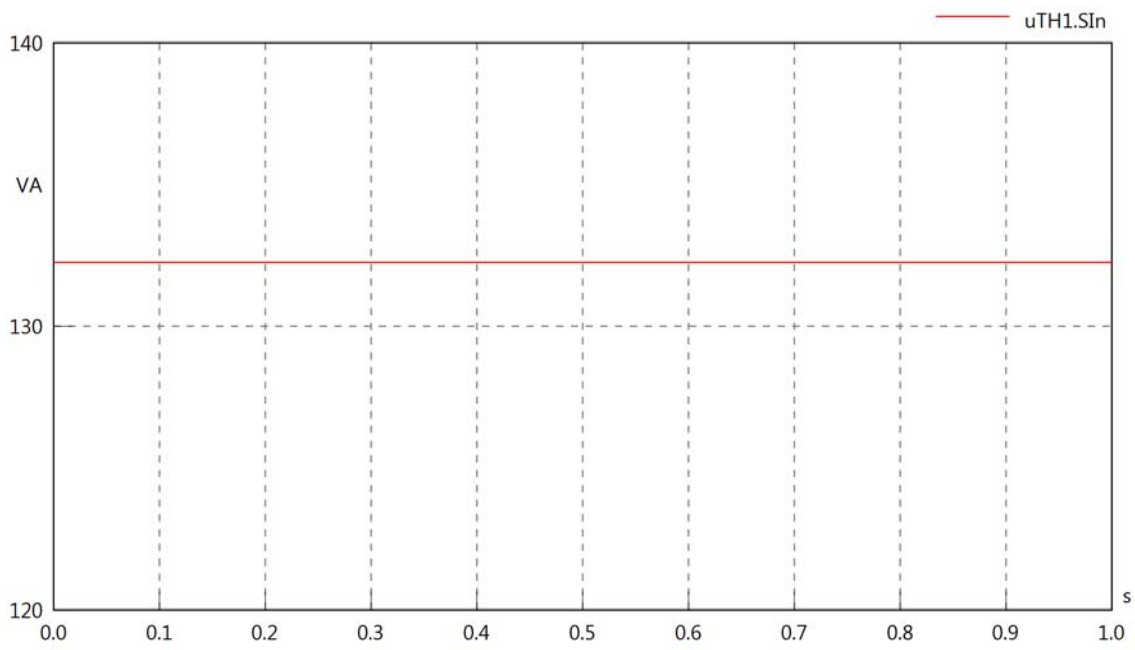

uTH1.PReOut

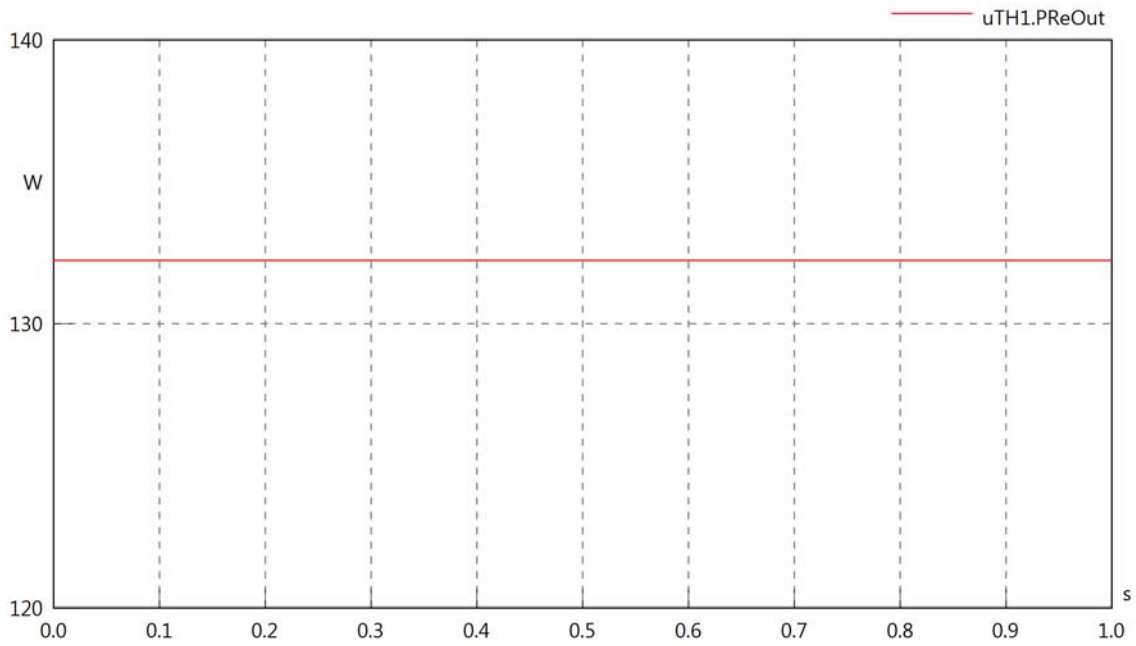

uTH1.PImOut

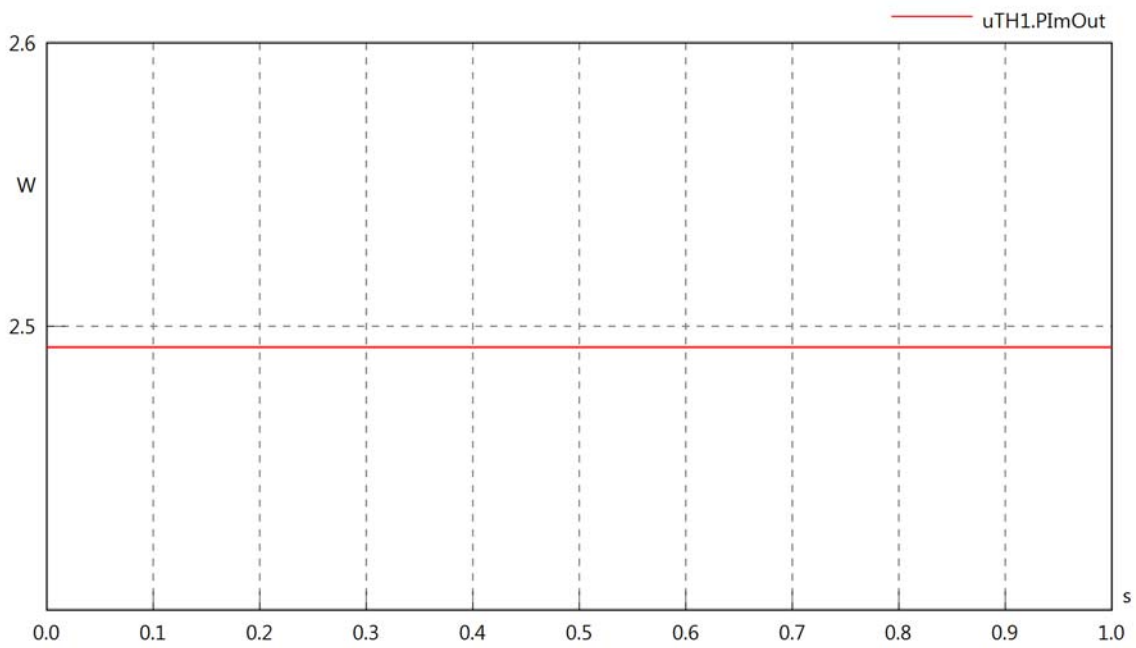

uTH1.SOut

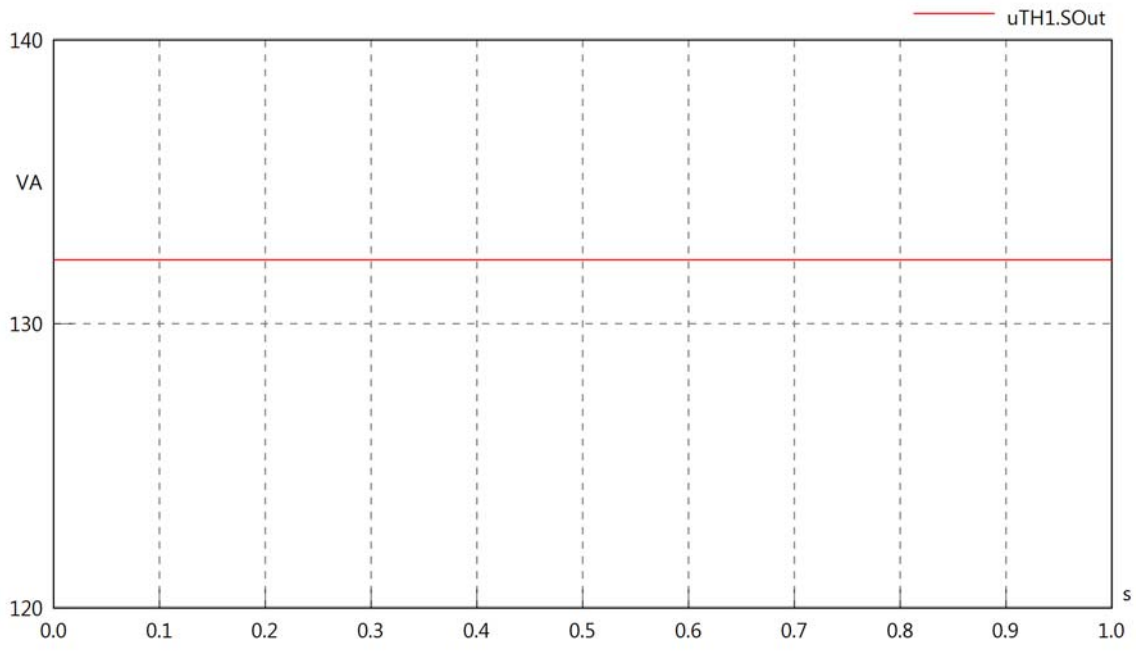
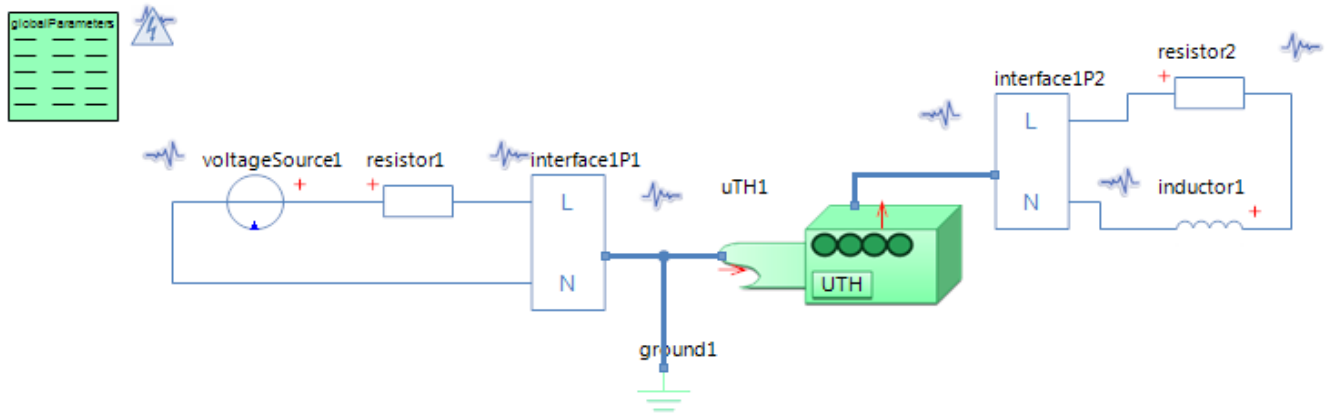

Diagram View



GlobalParameters globalParameters
Parameters

Comment	Name	Current Value	Unit
Type of Calculation	eCalculationKind	Signal Calculation	
Description of Frequency	eFrequencyKind	Linear	
Minimum Frequency	fMin	4000	[Hz]
Maximum Frequency	fMax	4000	[Hz]

Voltage Source voltageSource1
Parameters

Comment	Name	Current Value	Unit
Voltage RMS	VrmsSrc	230	[V]
Phase	phi	0	[deg]

Resistor resistor1
Parameters

Comment	Name	Current Value	Unit
Resistance	R	100	[Ohm]

Resistor resistor2
Parameters

Comment	Name	Current Value	Unit
Resistance	R	100	[Ohm]

Inductor inductor1
Parameters

Comment	Name	Current Value	Unit
Inductance	L	5	[mH]

Umbilical Termination Head uTH1
Parameters

Comment	Name	Current Value	Unit
Poor or failing L1 connection	bL1	false	

uTH1.VrmsIn

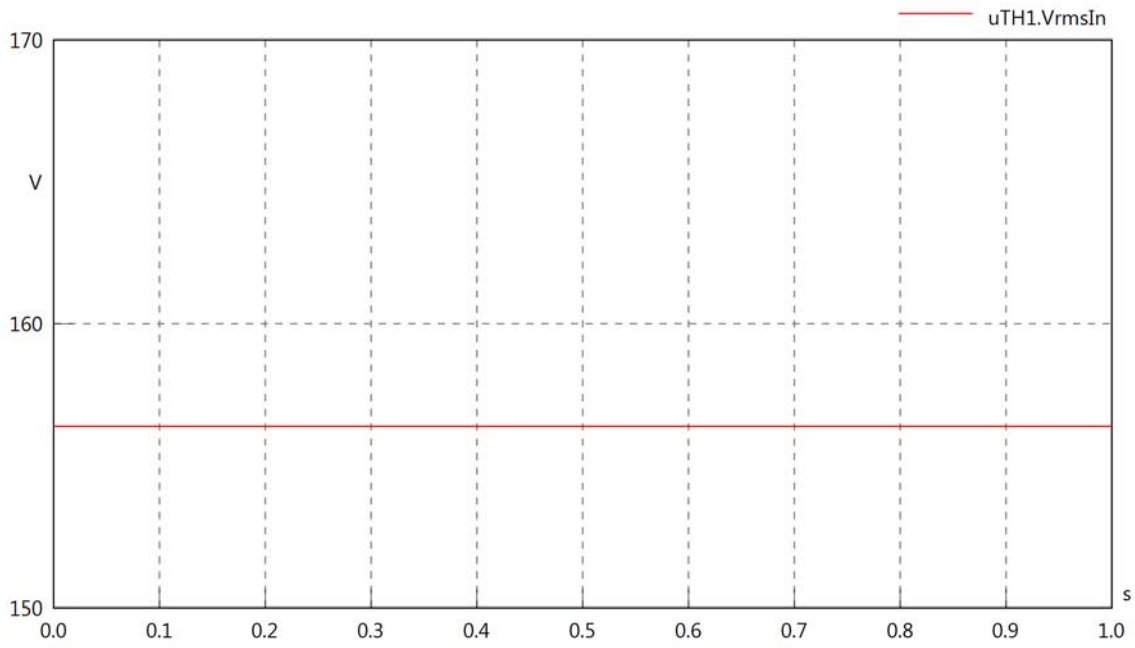

uTH1.vReIn

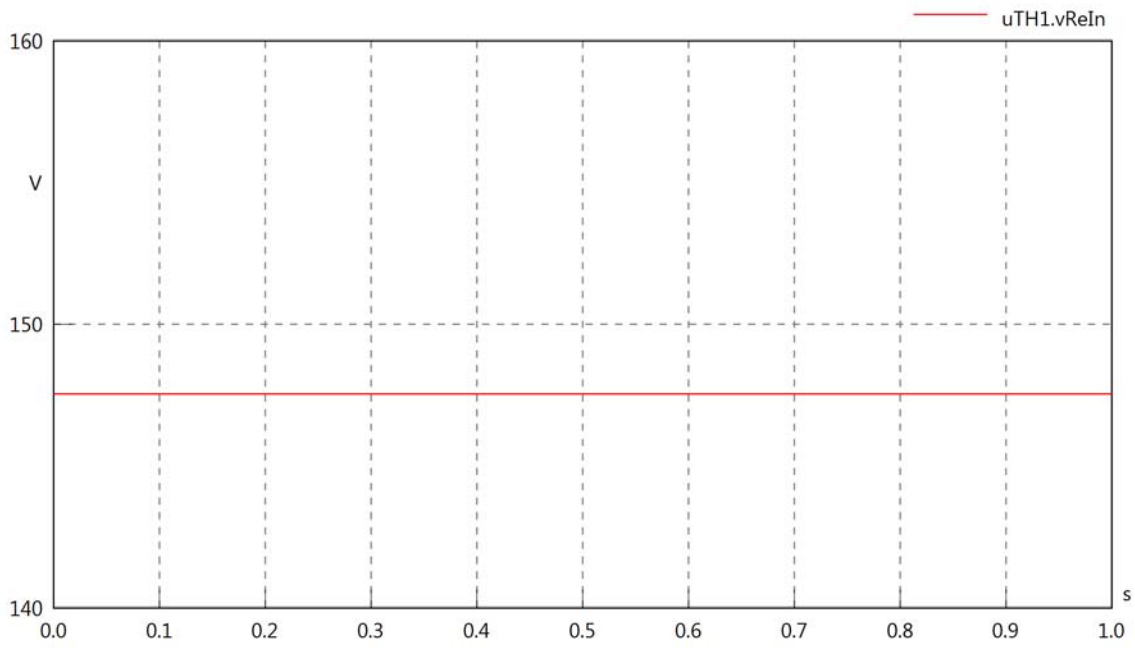

uTH1.vImIn

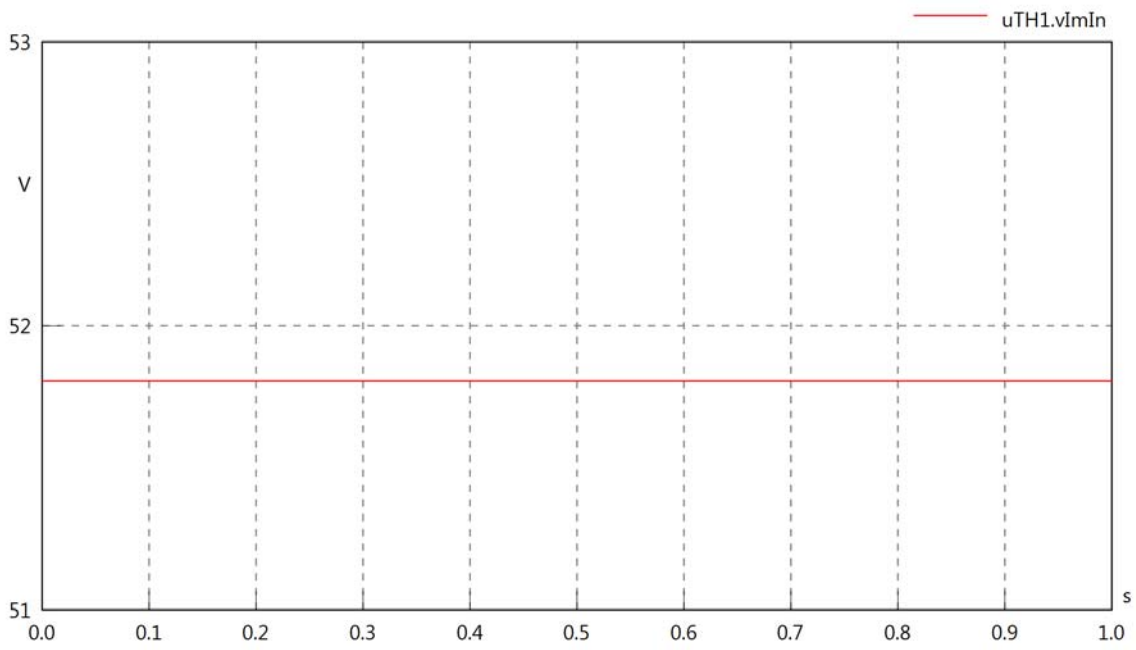

uTH1.VrmsOut

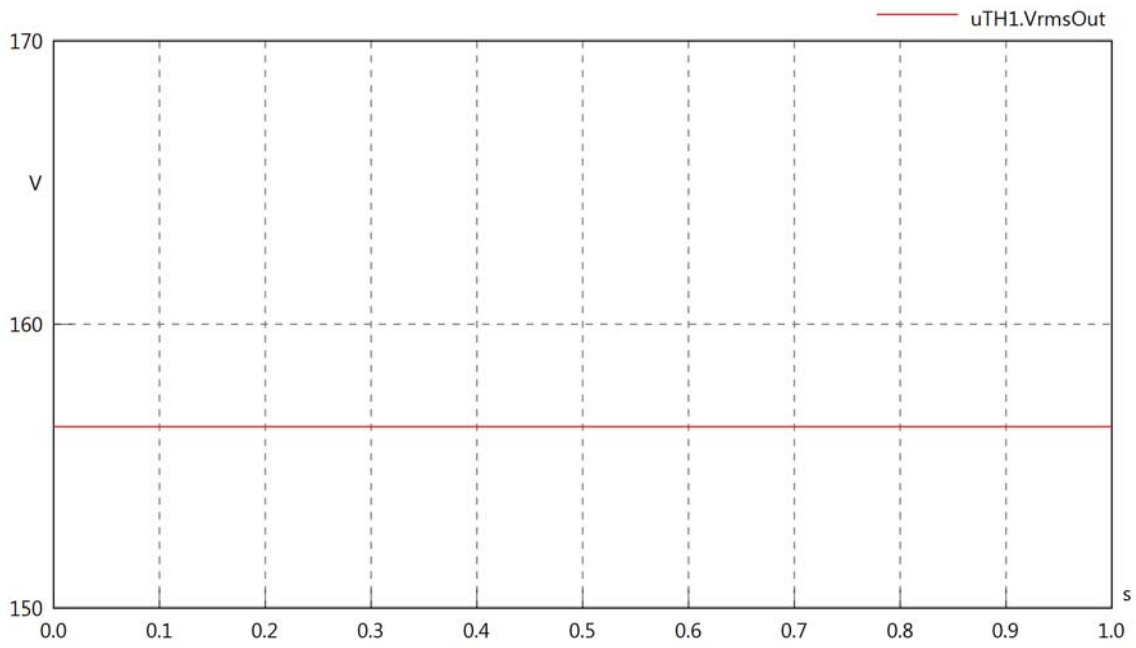

uTH1.vReOut

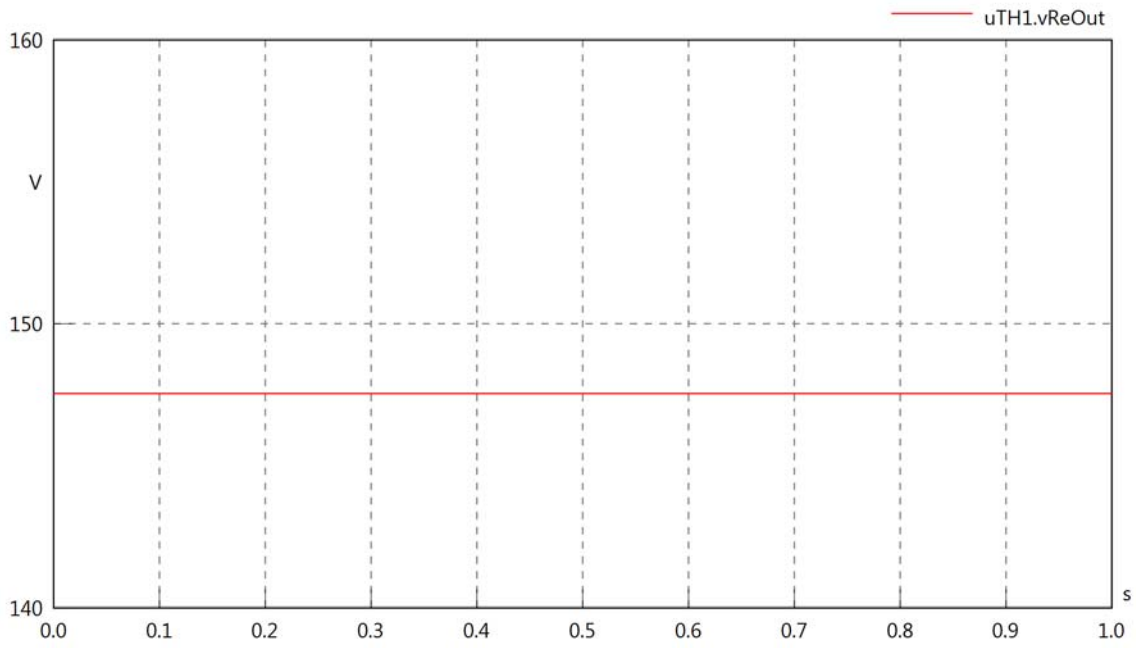

uTH1.vImOut

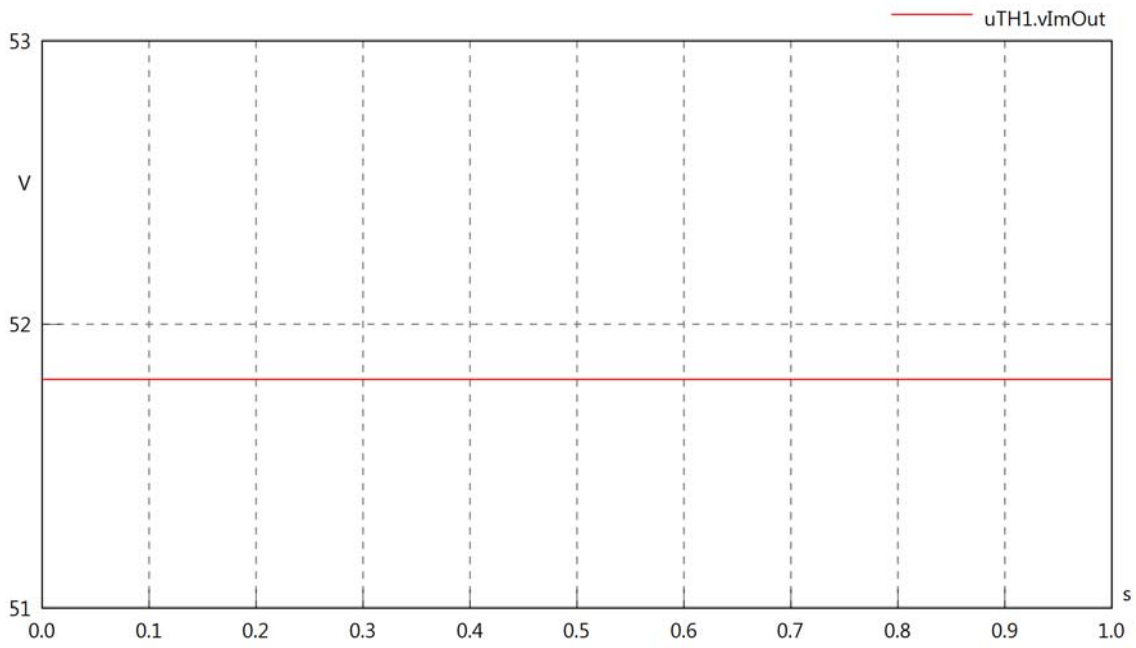

uTH1.Vrms

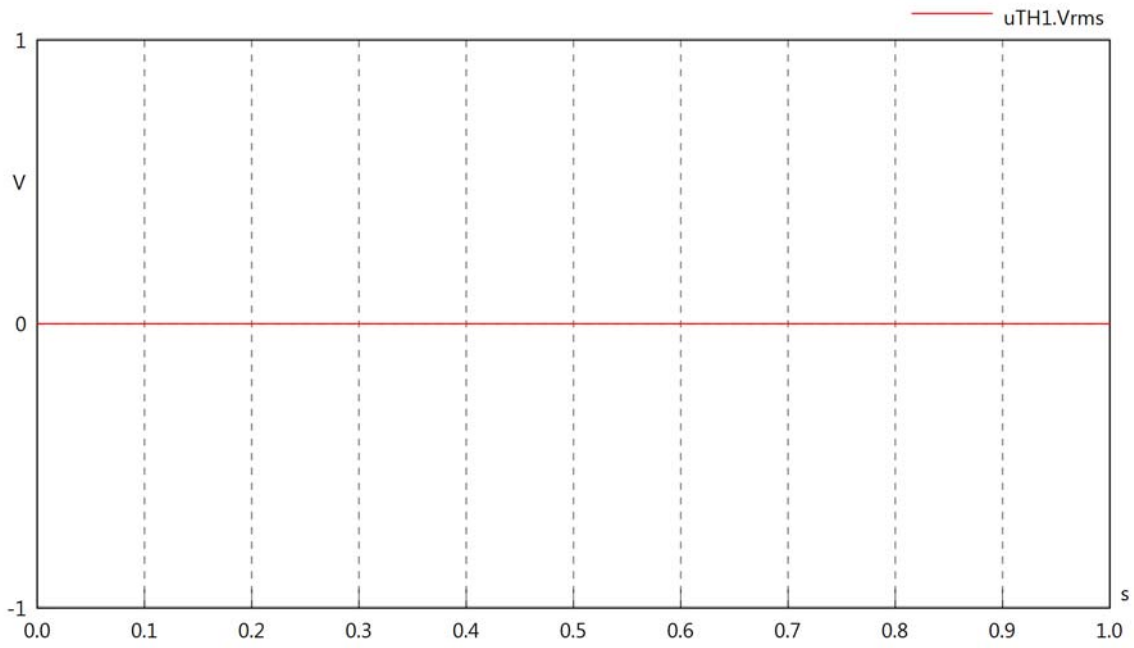

uTH1.vRe

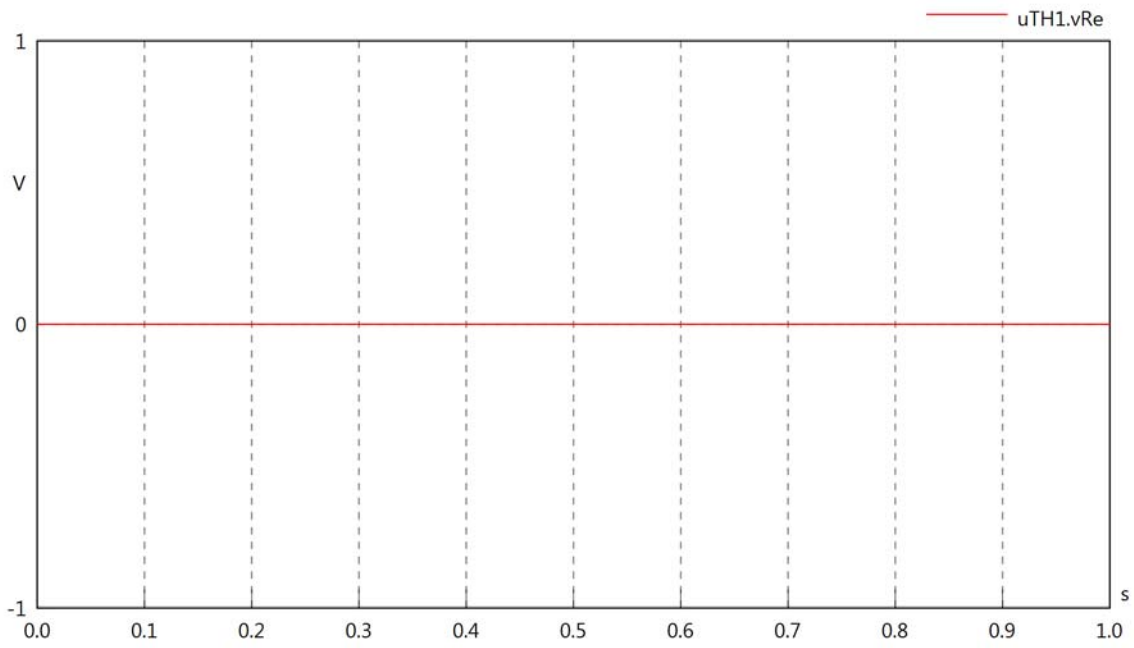

uTH1.vIm

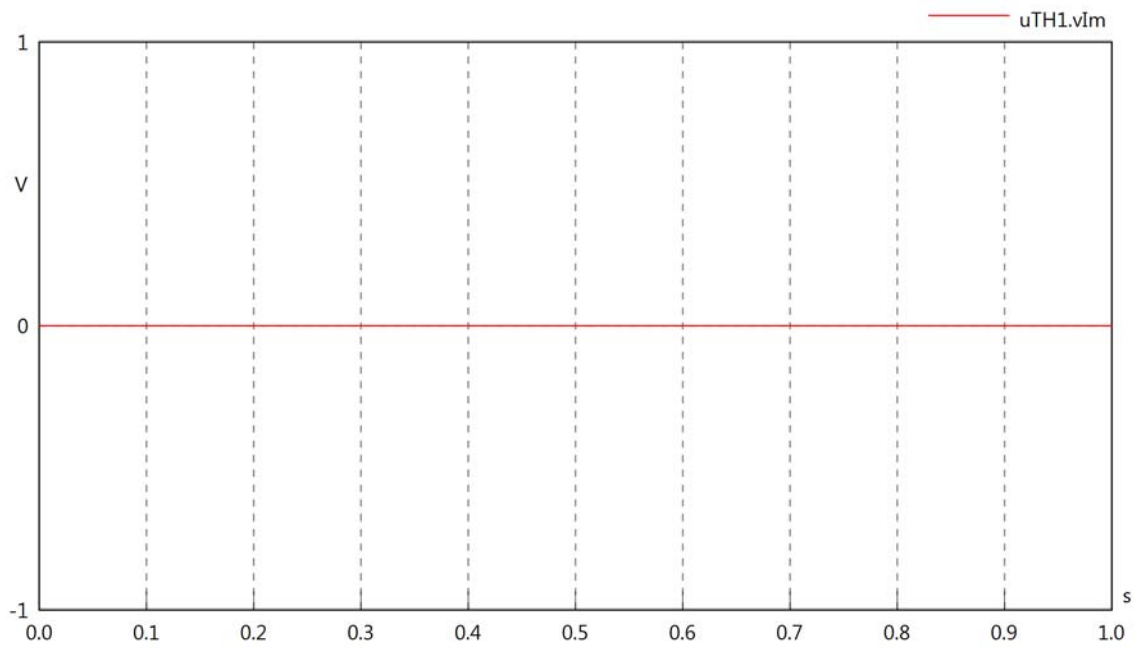

uTH1.IrmsIn

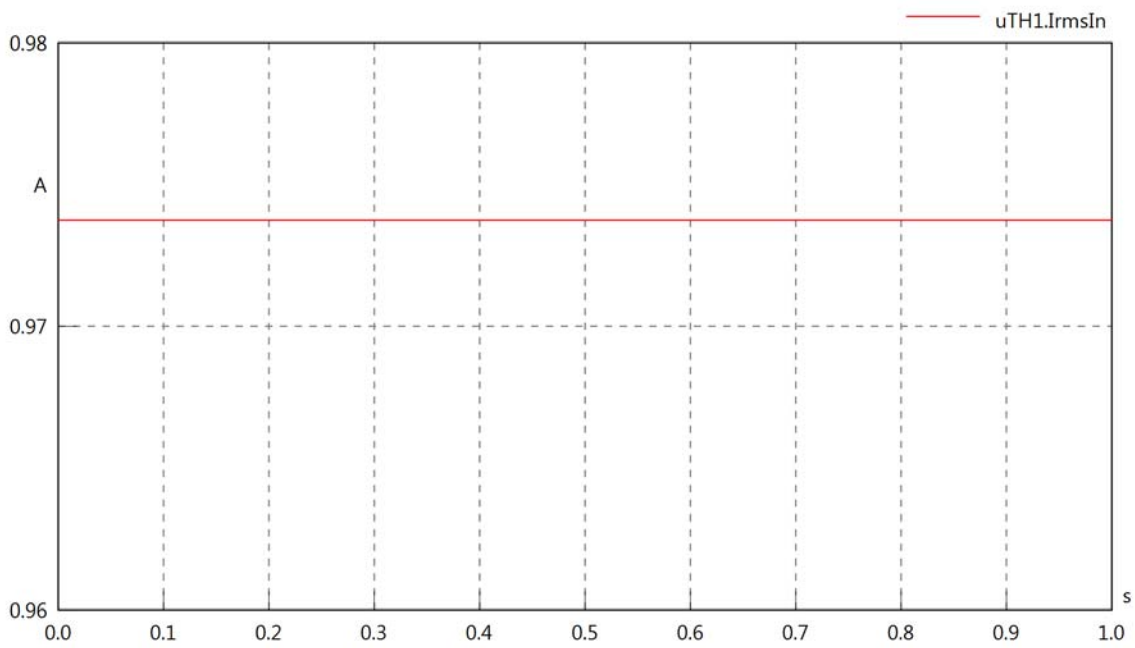

uTH1.iReIn

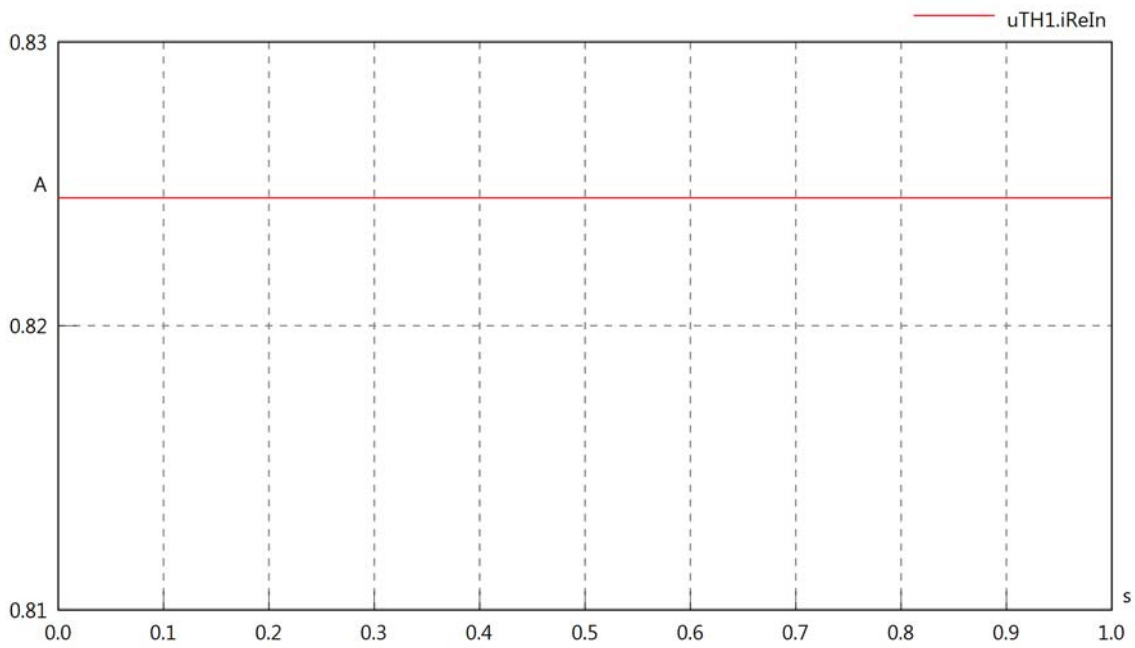

uTH1.ilmIn

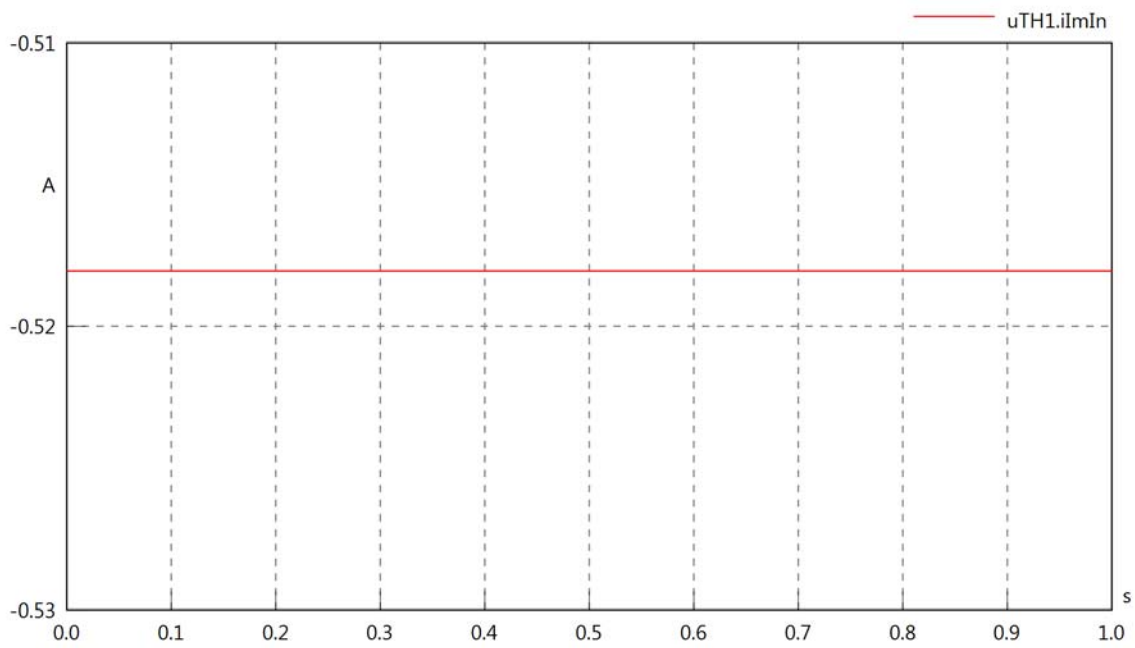

uTH1.IrmsOut

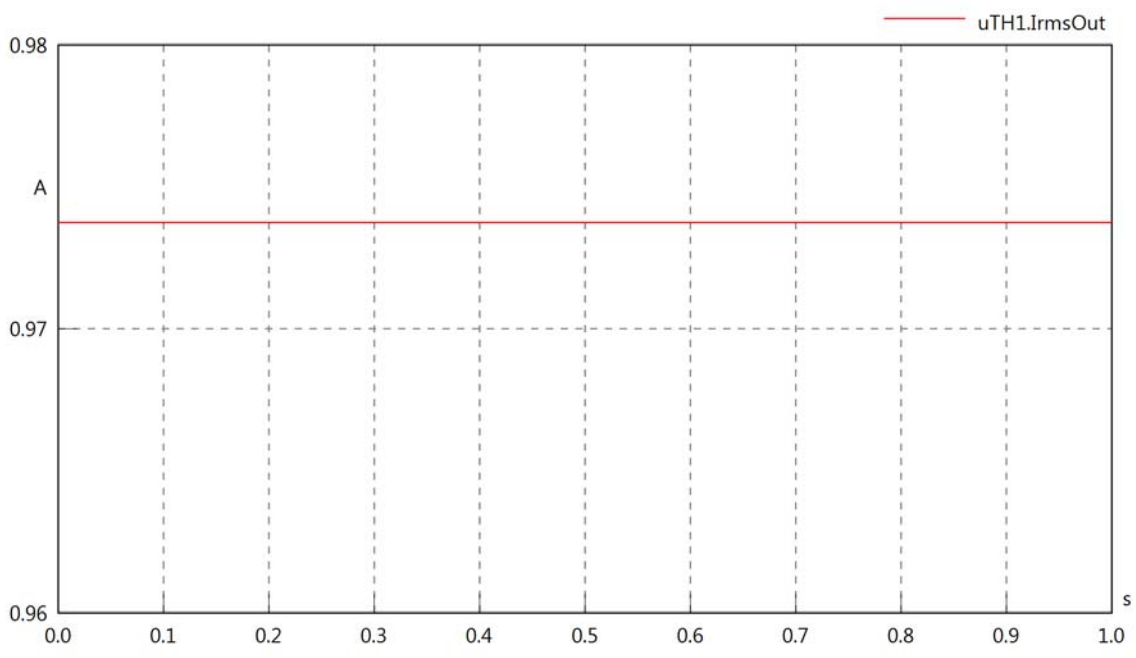

uTH1.iReOut

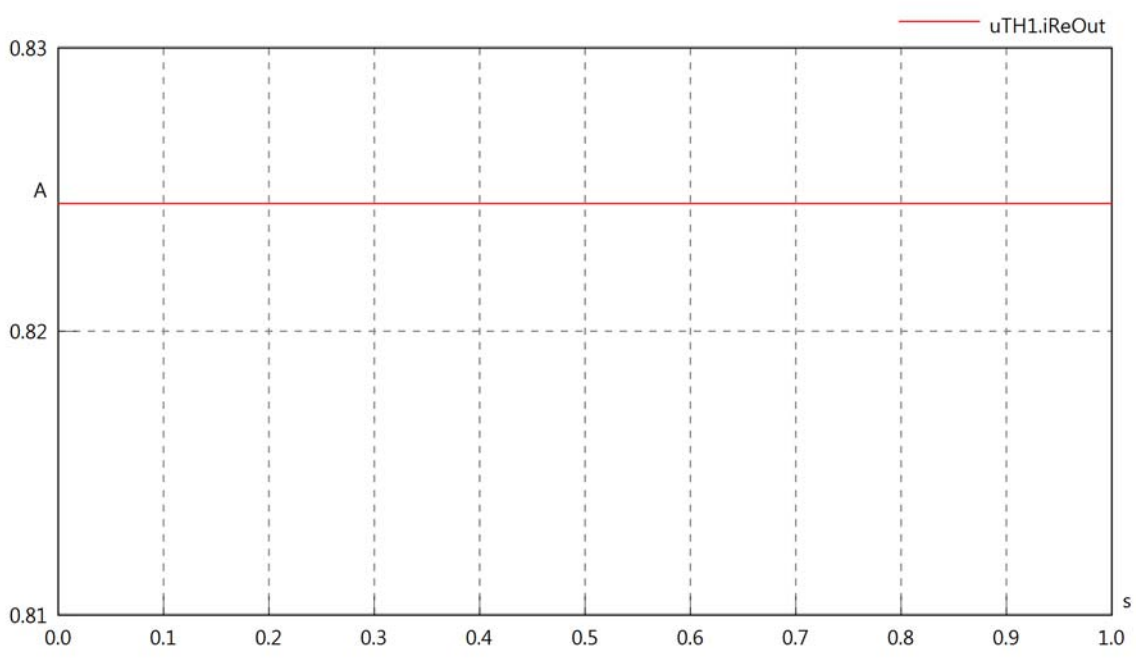

uTH1.iImOut

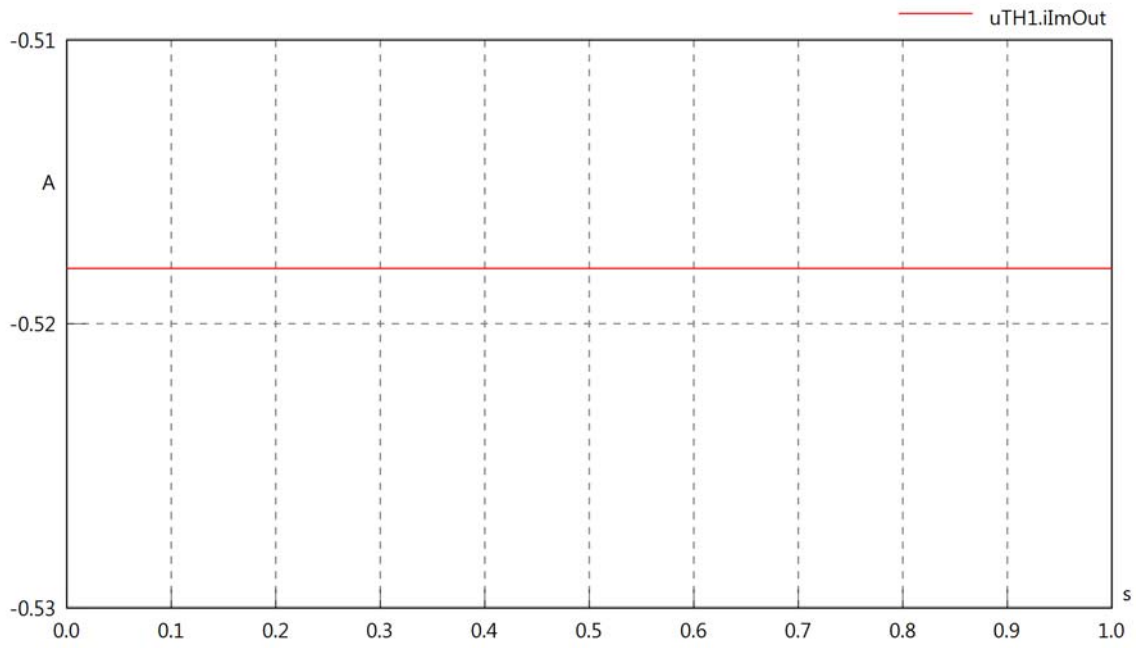

uTH1.phiVIn

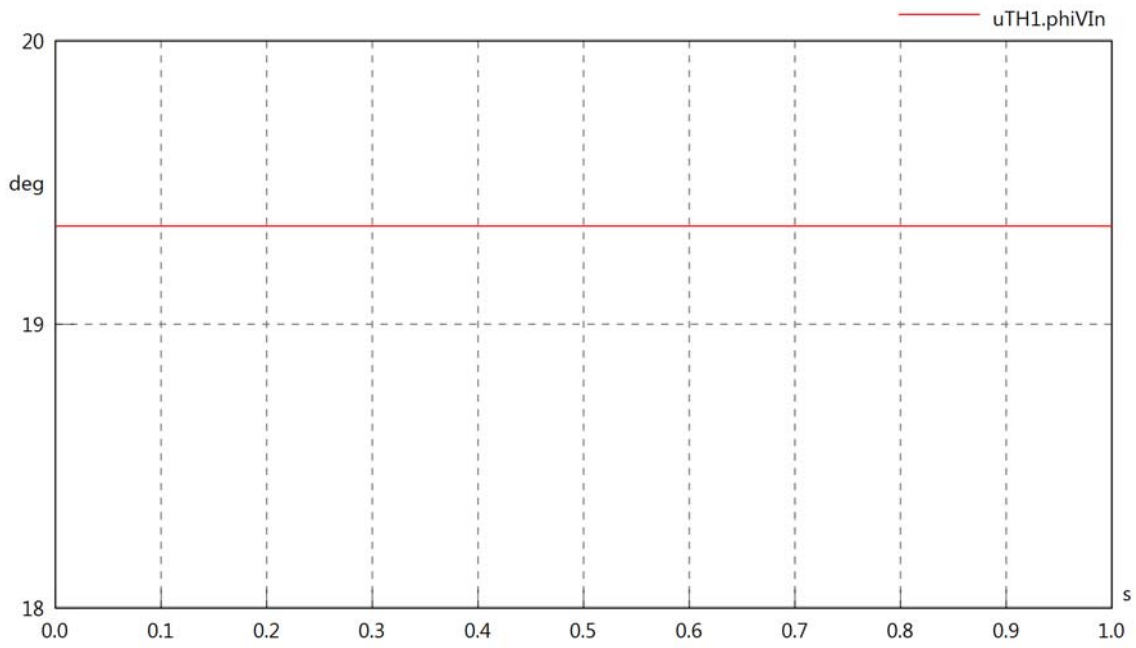

uTH1.philIn

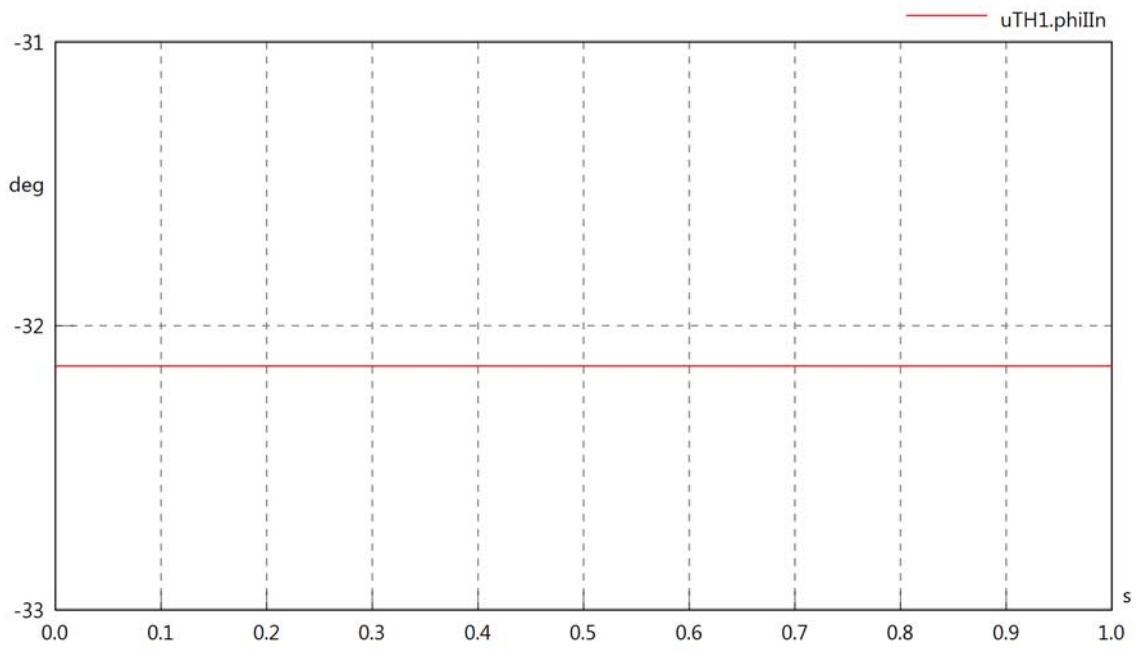

uTH1.philVIn

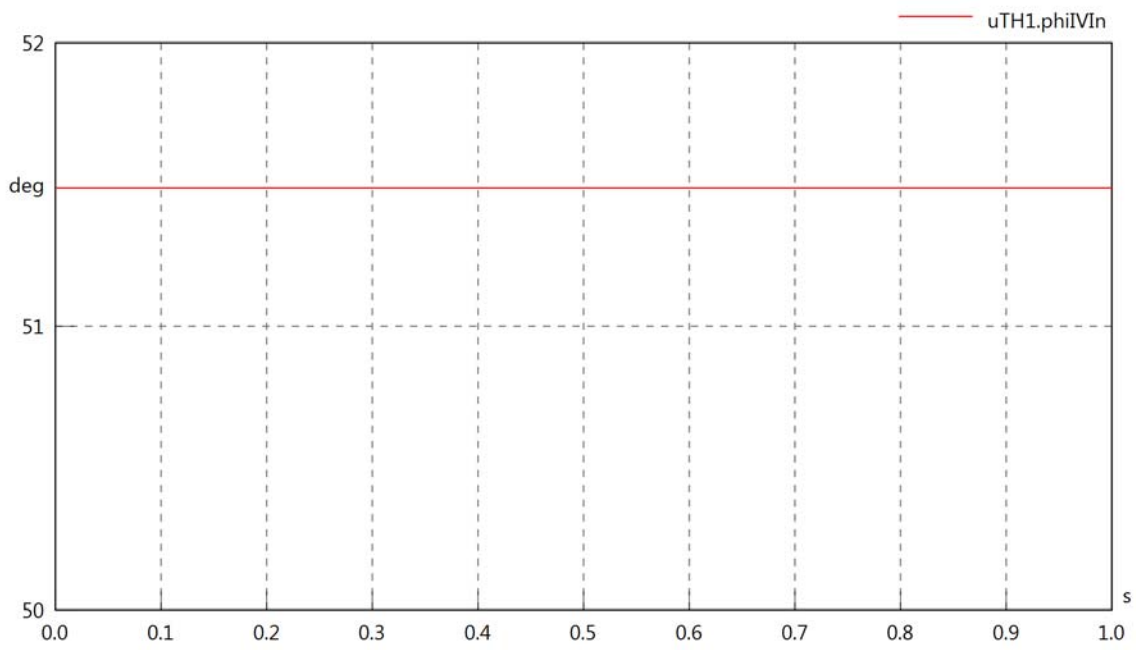

uTH1.phiVOut

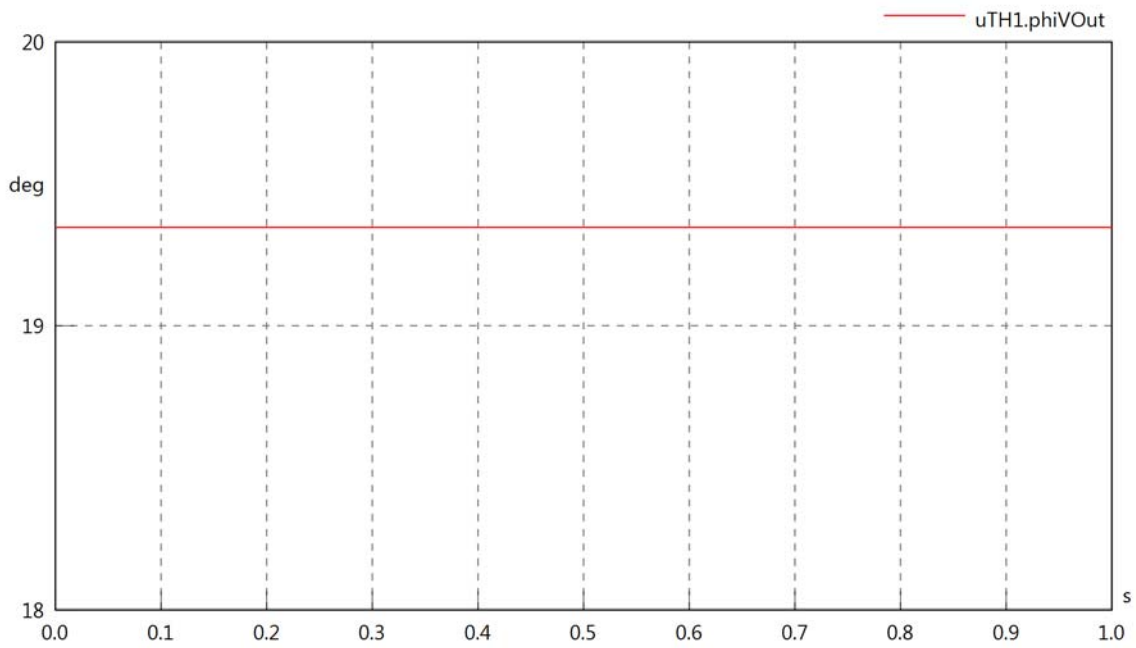

uTH1.philOut

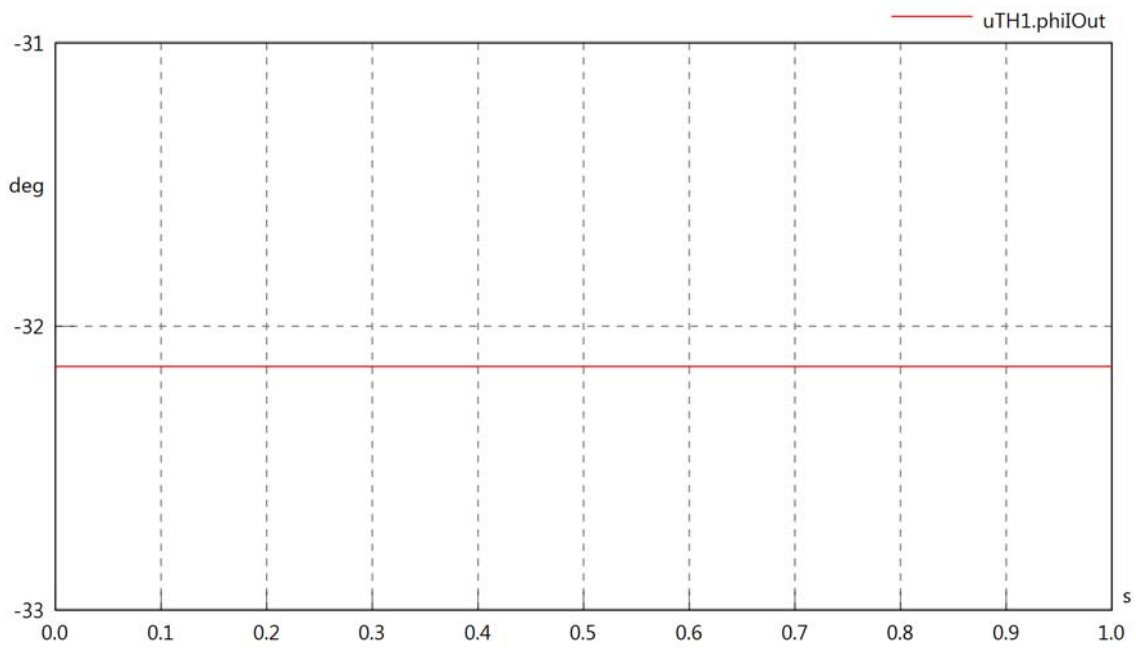

uTH1.philVOut

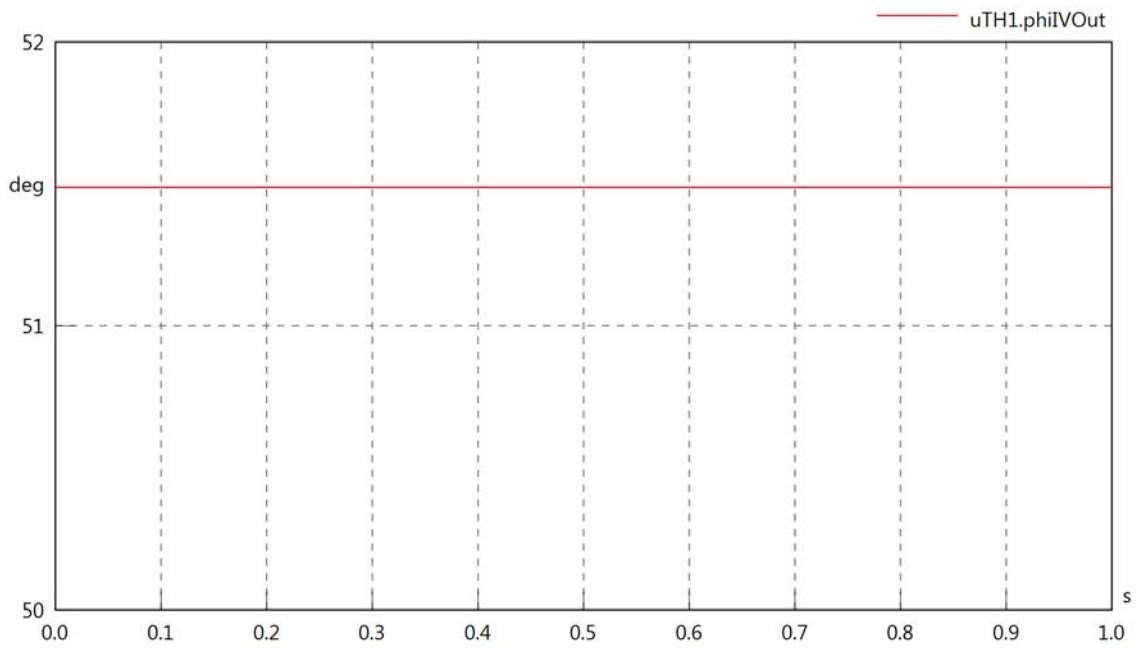

uTH1.PReIn

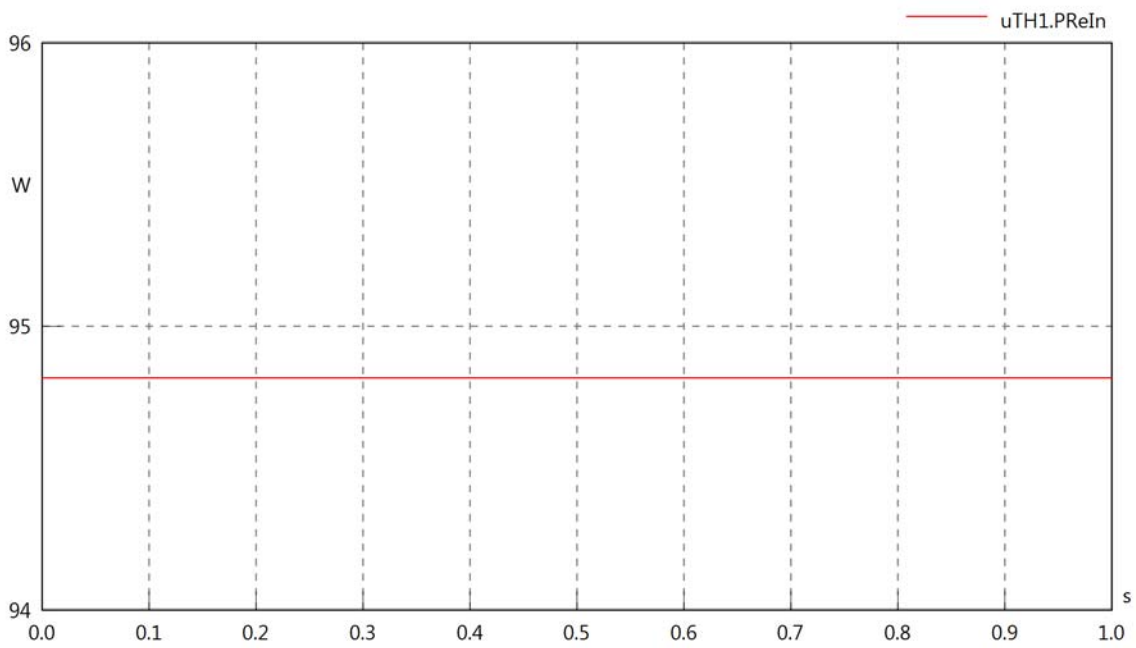

uTH1.PImIn

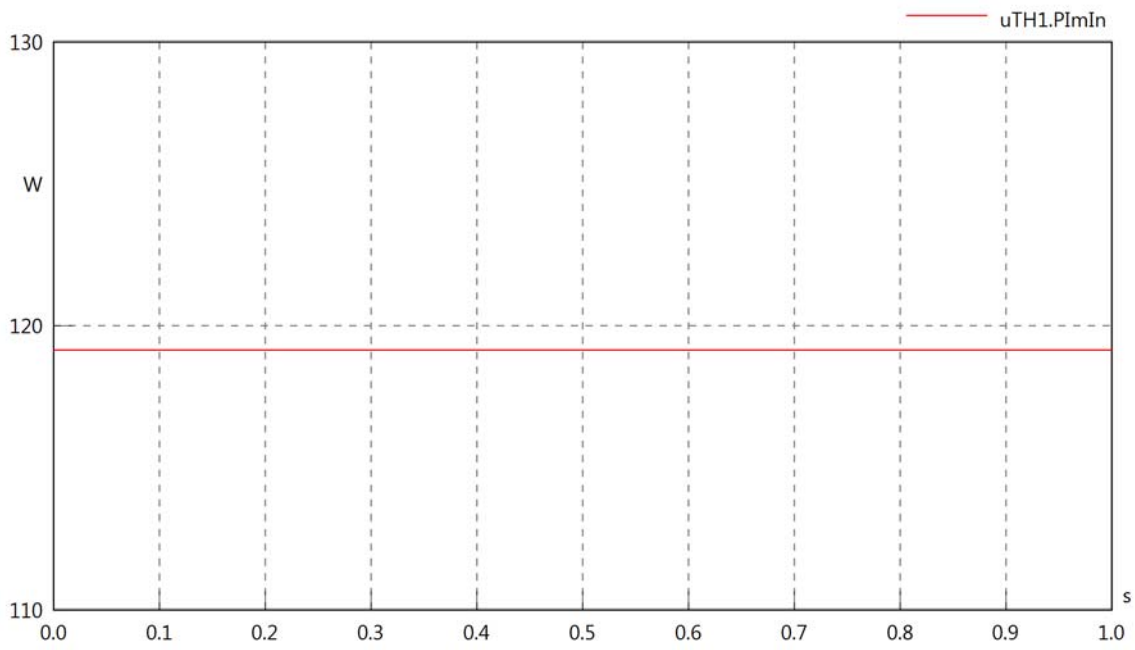

uTH1.SIn

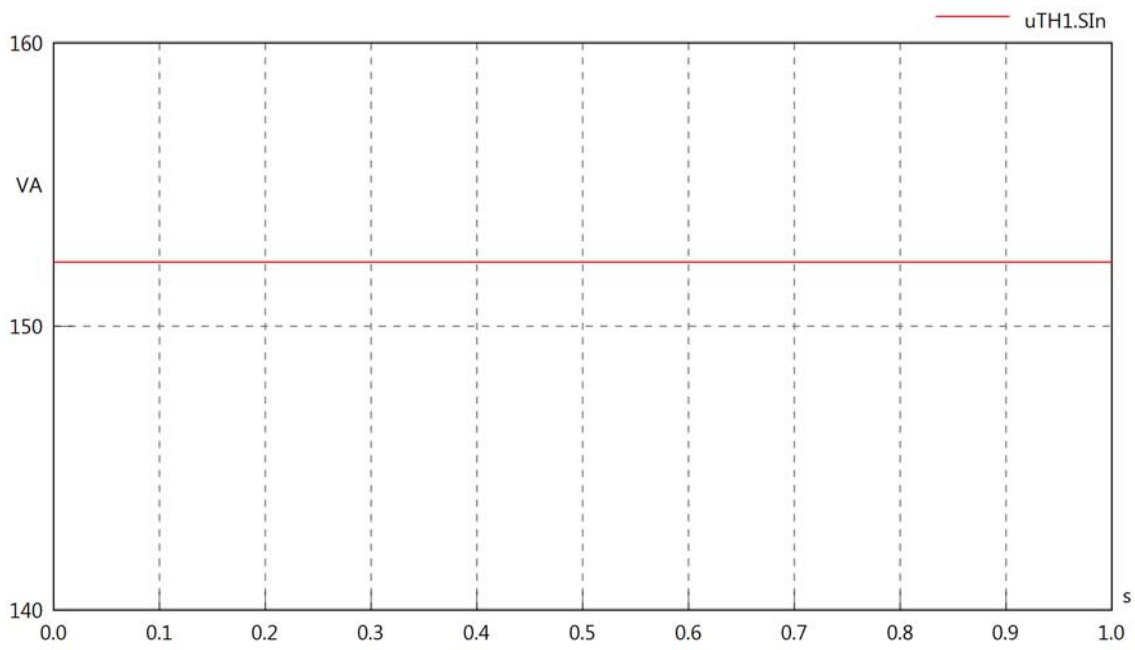

uTH1.PReOut

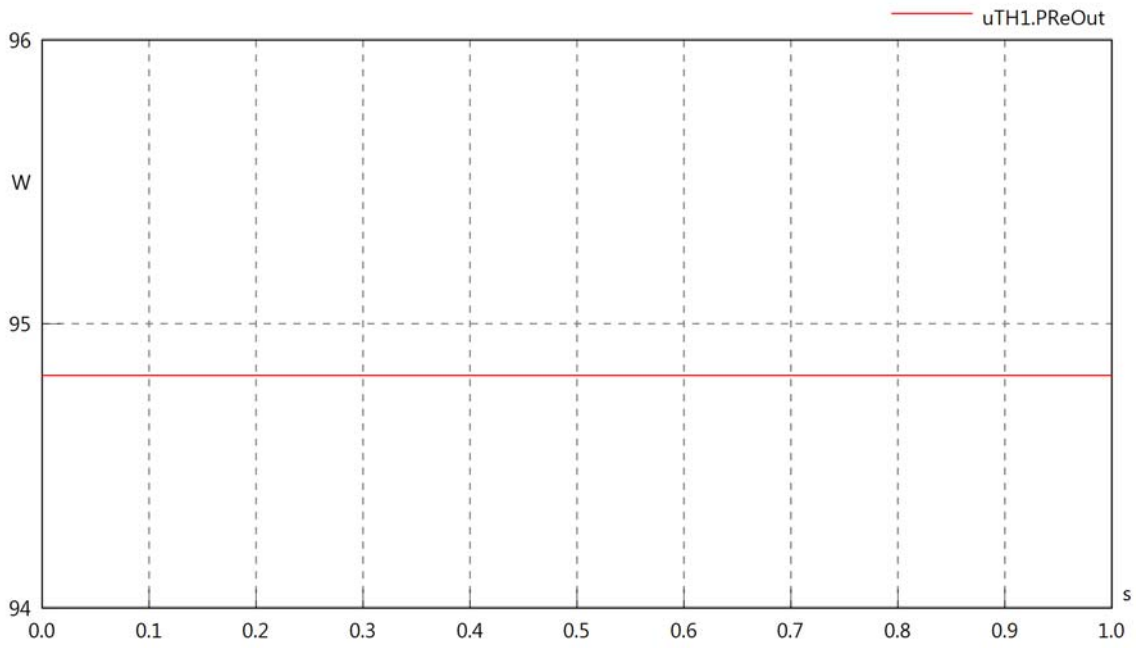

uTH1.PImOut

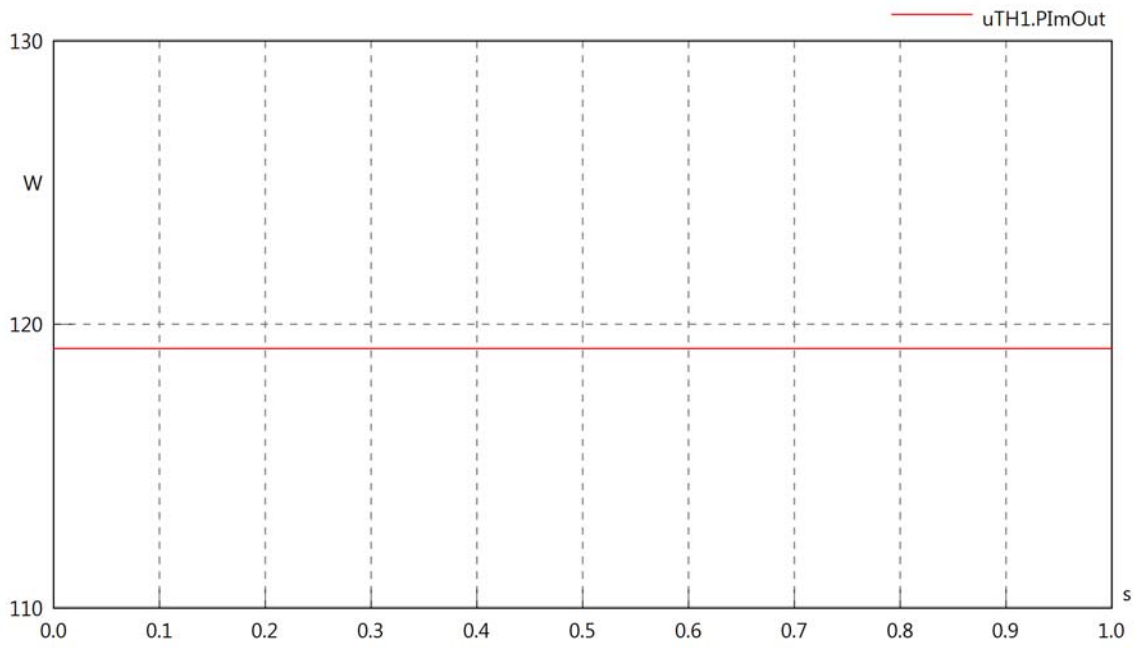

uTH1.SOut

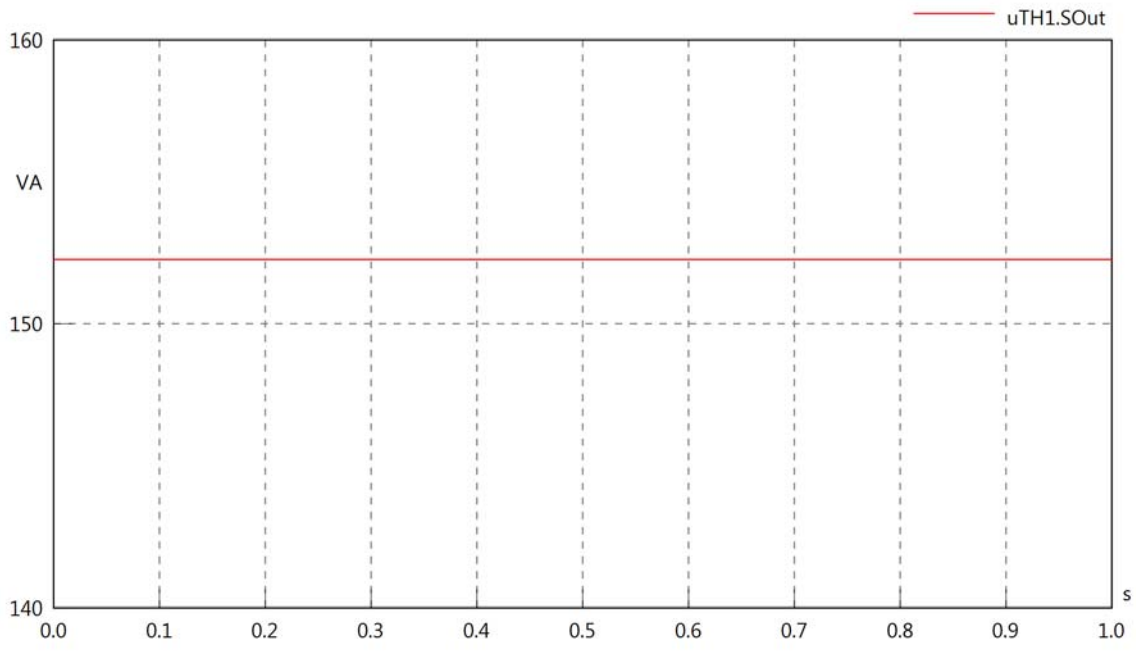
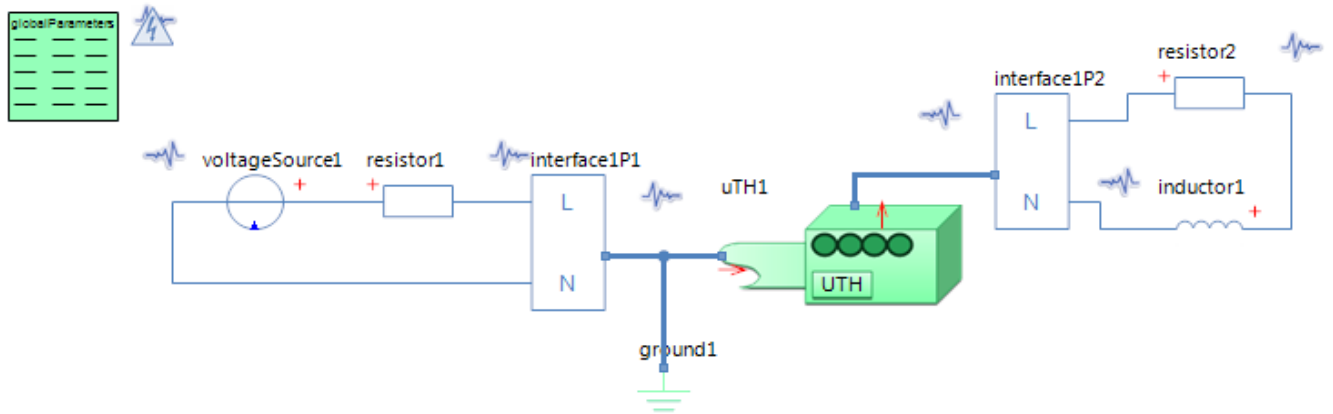

Diagram View



GlobalParameters globalParameters
Parameters

Comment	Name	Current Value	Unit
Type of Calculation	eCalculationKind	Signal Calculation	
Description of Frequency	eFrequencyKind	Linear	
Minimum Frequency	fMin	20000	[Hz]
Maximum Frequency	fMax	20000	[Hz]

Voltage Source voltageSource1
Parameters

Comment	Name	Current Value	Unit
Voltage RMS	VrmsSrc	230	[V]
Phase	phi	0	[deg]

Resistor resistor1
Parameters

Comment	Name	Current Value	Unit
Resistance	R	100	[Ohm]

Resistor resistor2
Parameters

Comment	Name	Current Value	Unit
Resistance	R	100	[Ohm]

Inductor inductor1
Parameters

Comment	Name	Current Value	Unit
Inductance	L	5	[mH]

Umbilical Termination Head uTH1
Parameters

Comment	Name	Current Value	Unit
Poor or failing L1 connection	bL1	false	

uTH1.VrmsIn

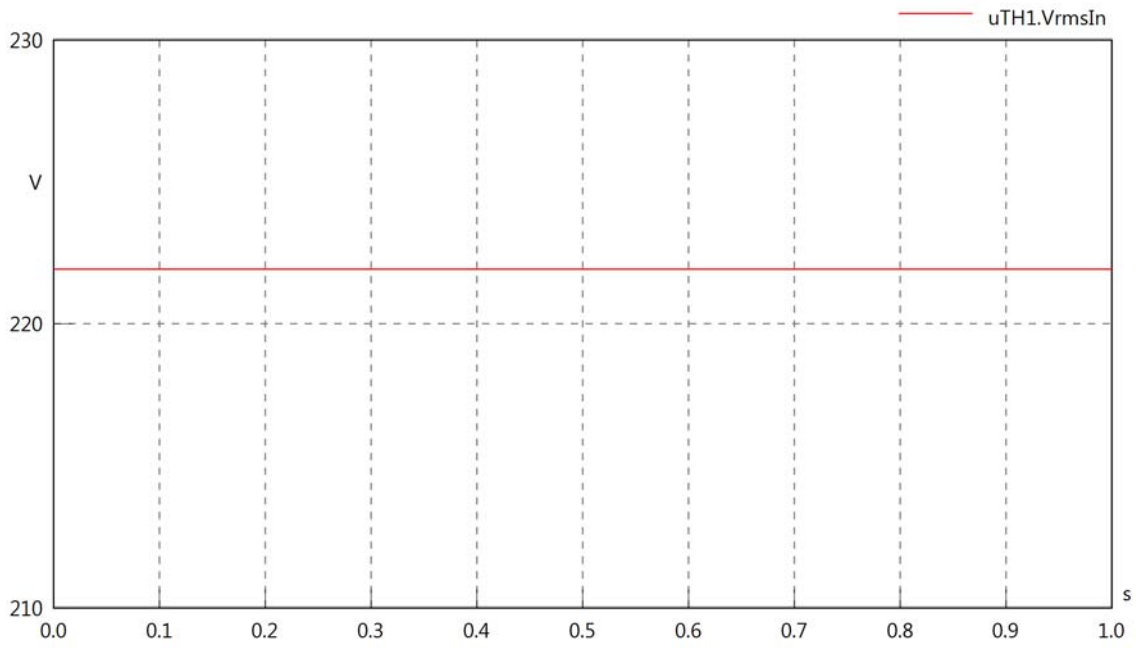

uTH1.vReIn

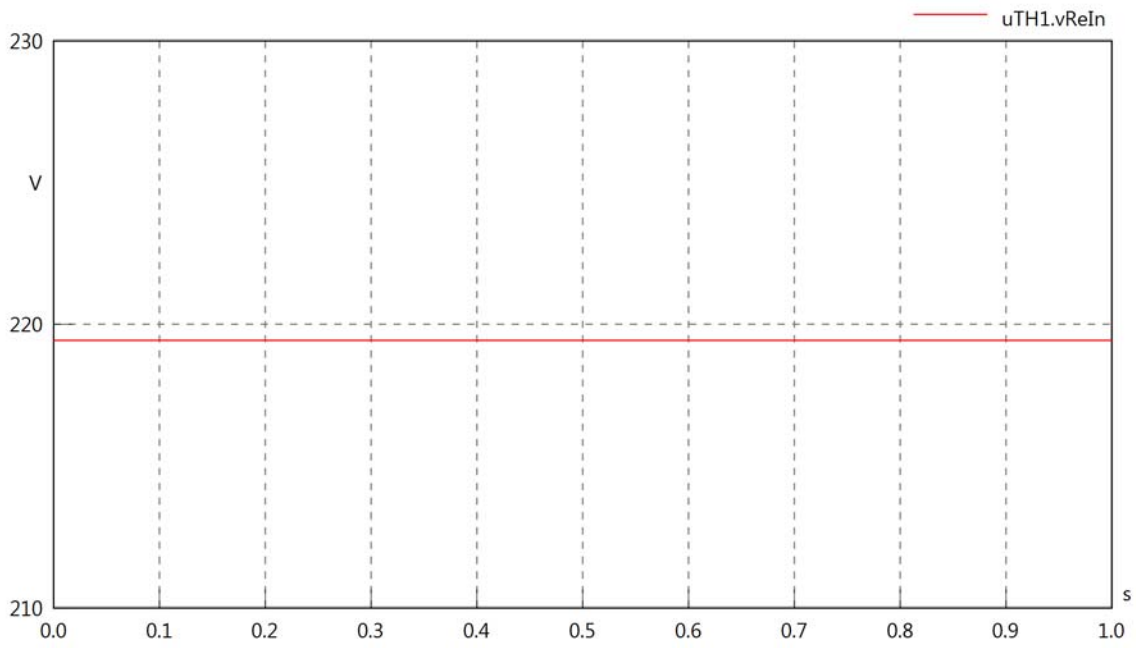

uTH1.vImIn

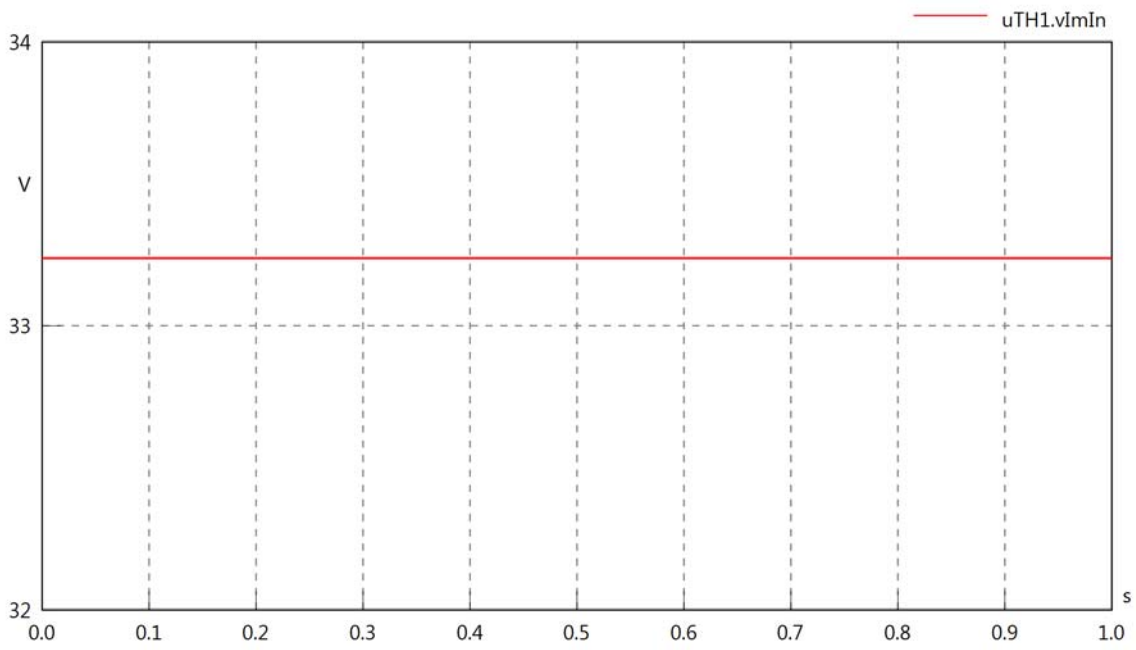

uTH1.VrmsOut

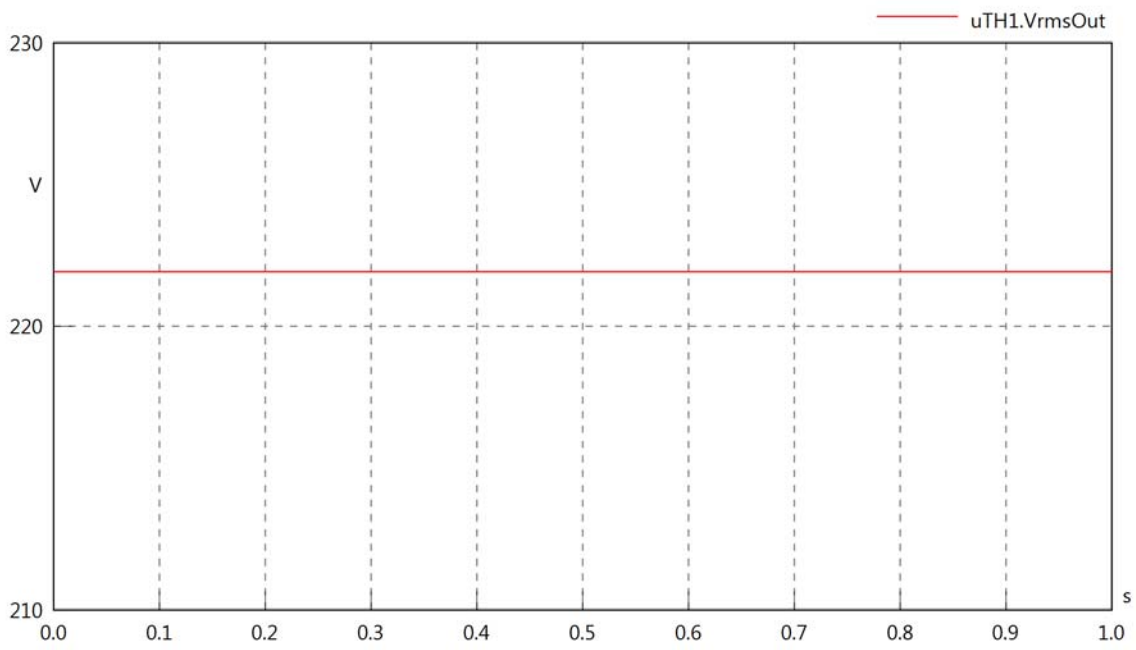

uTH1.vReOut

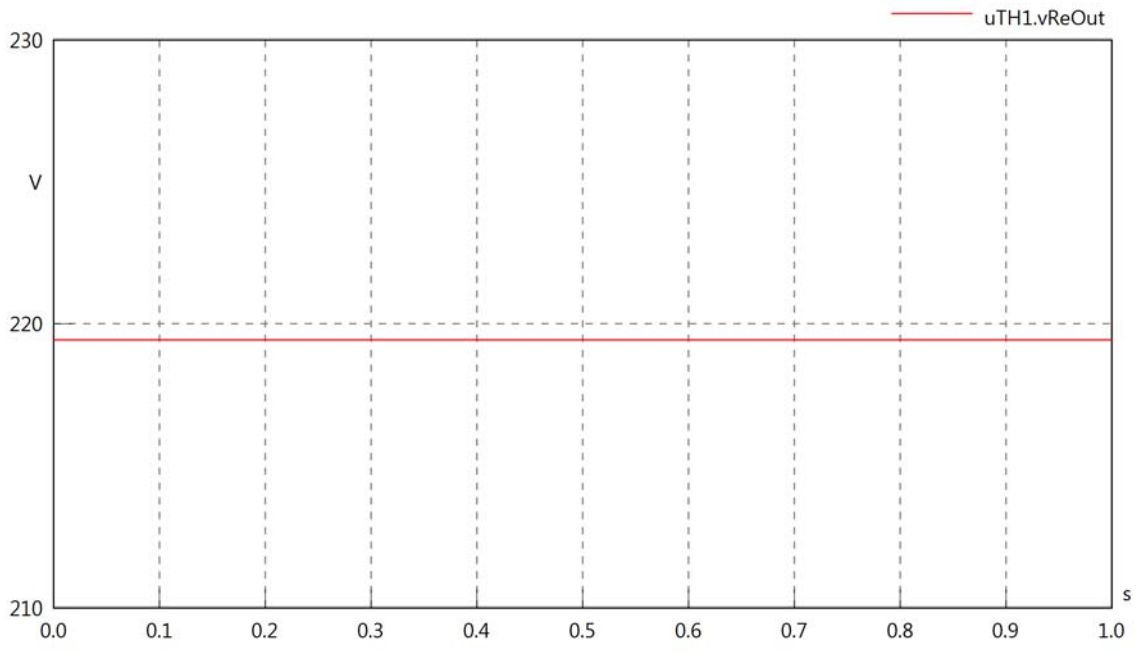

uTH1.vImOut

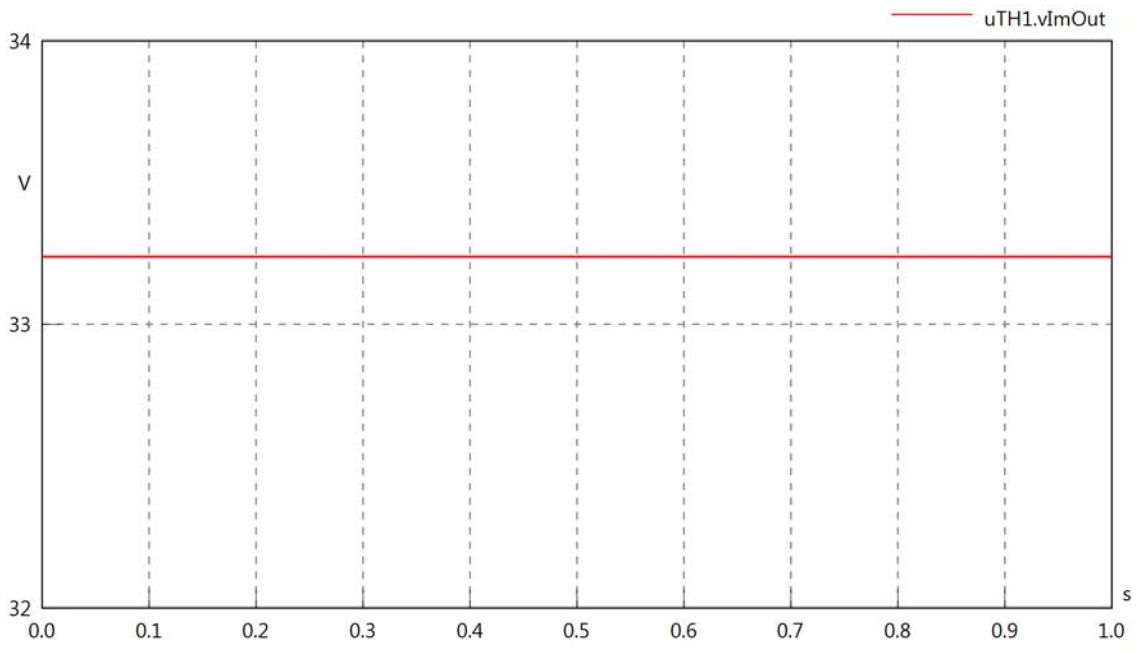

uTH1.Vrms

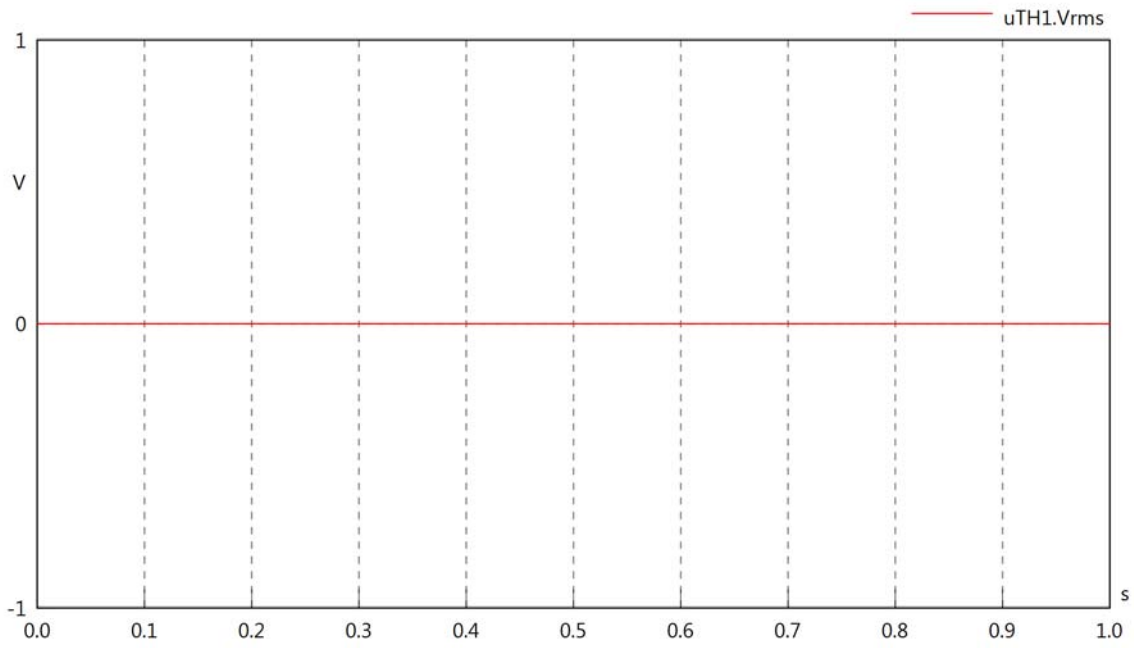

uTH1.vRe

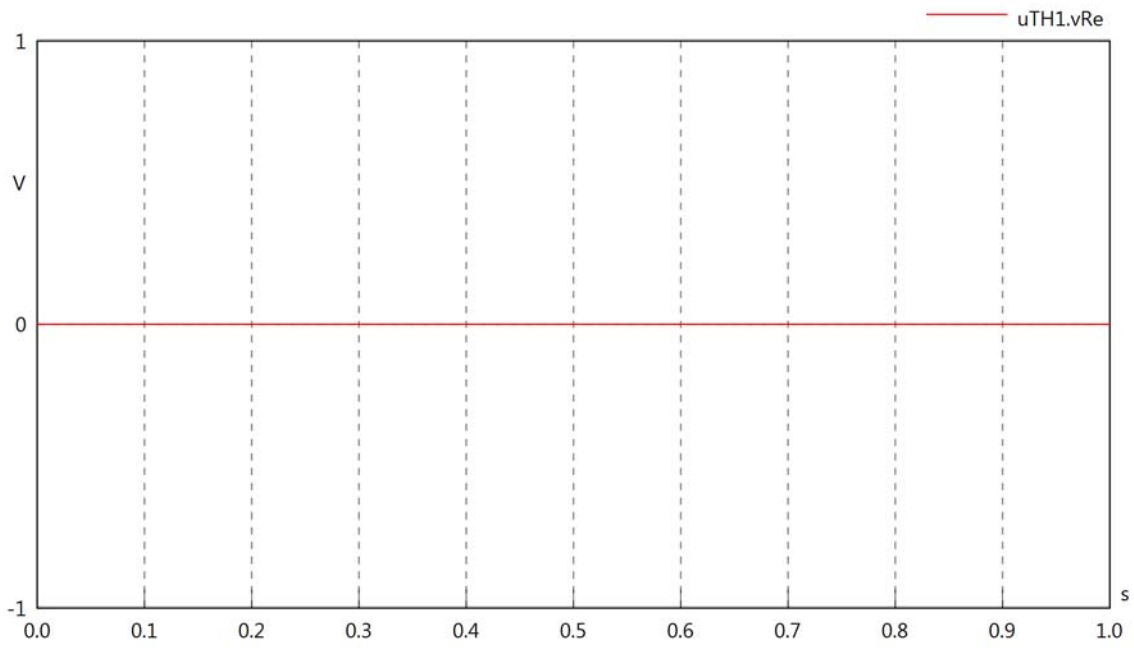

uTH1.vIm

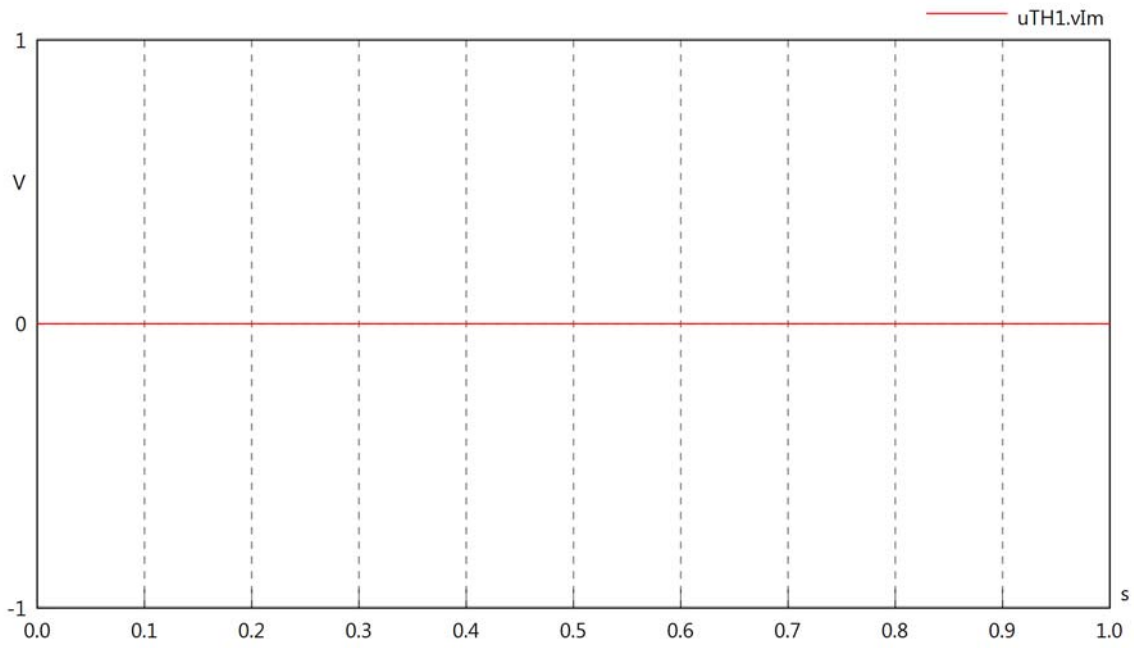

uTH1.IrmsIn

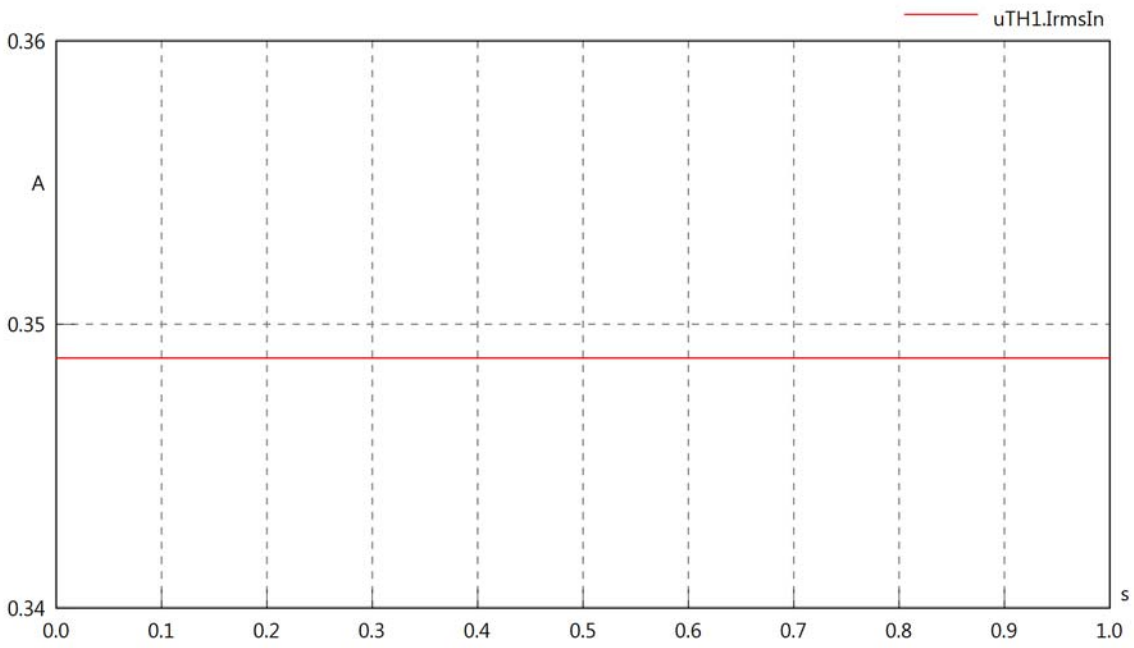

uTH1.iReIn

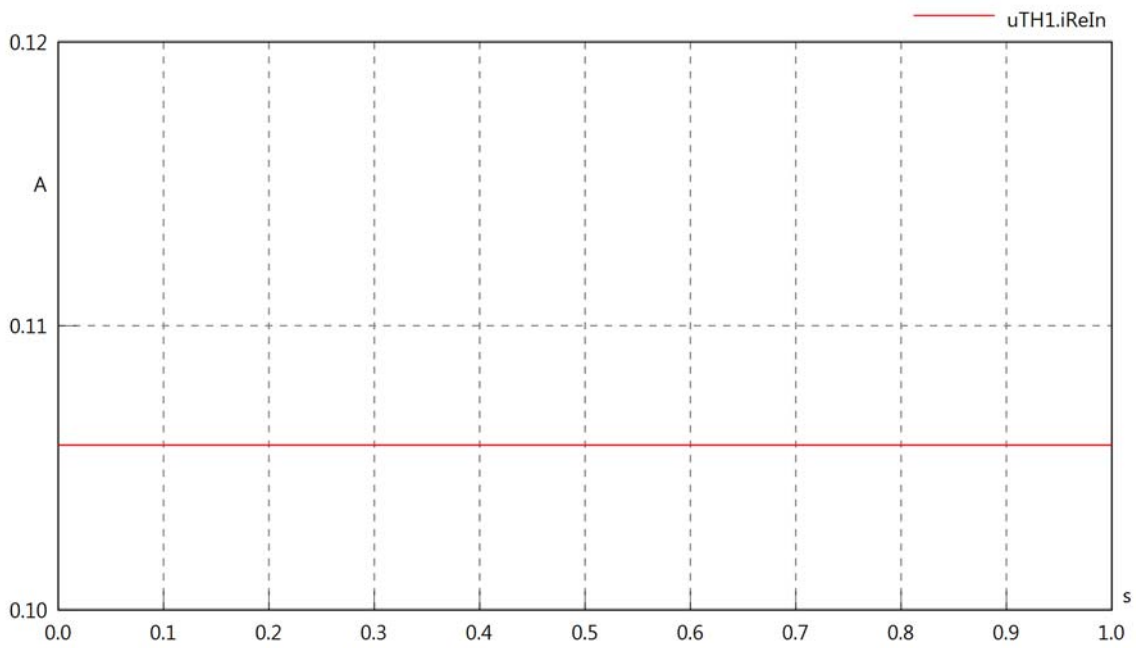

uTH1.ilmIn

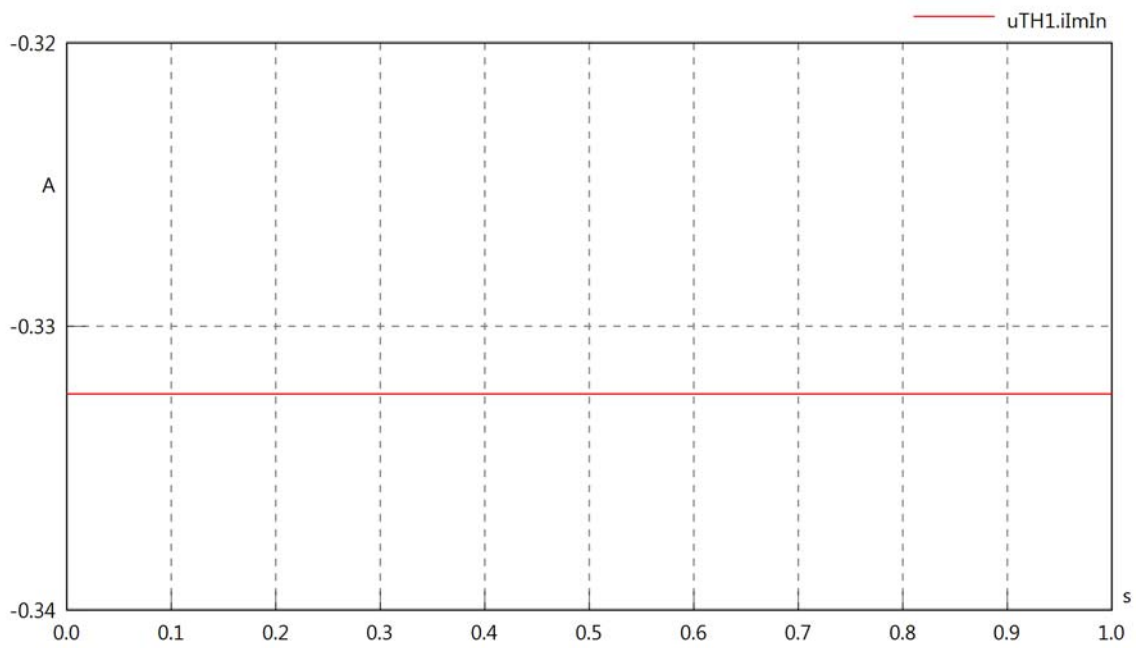

uTH1.IrmsOut

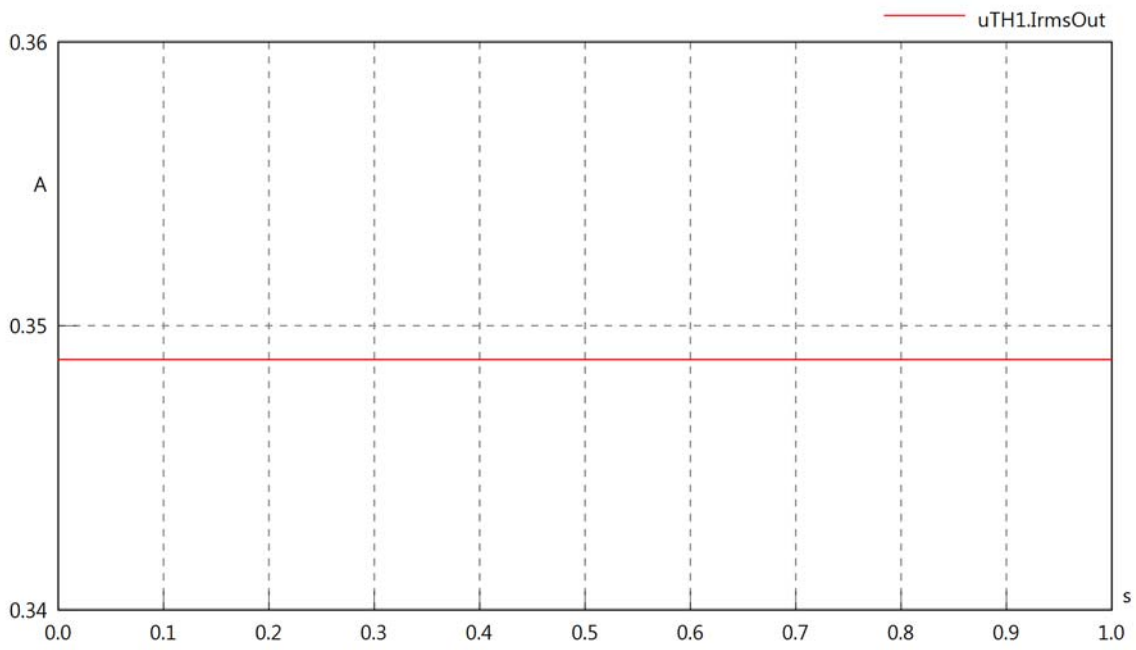

uTH1.iReOut

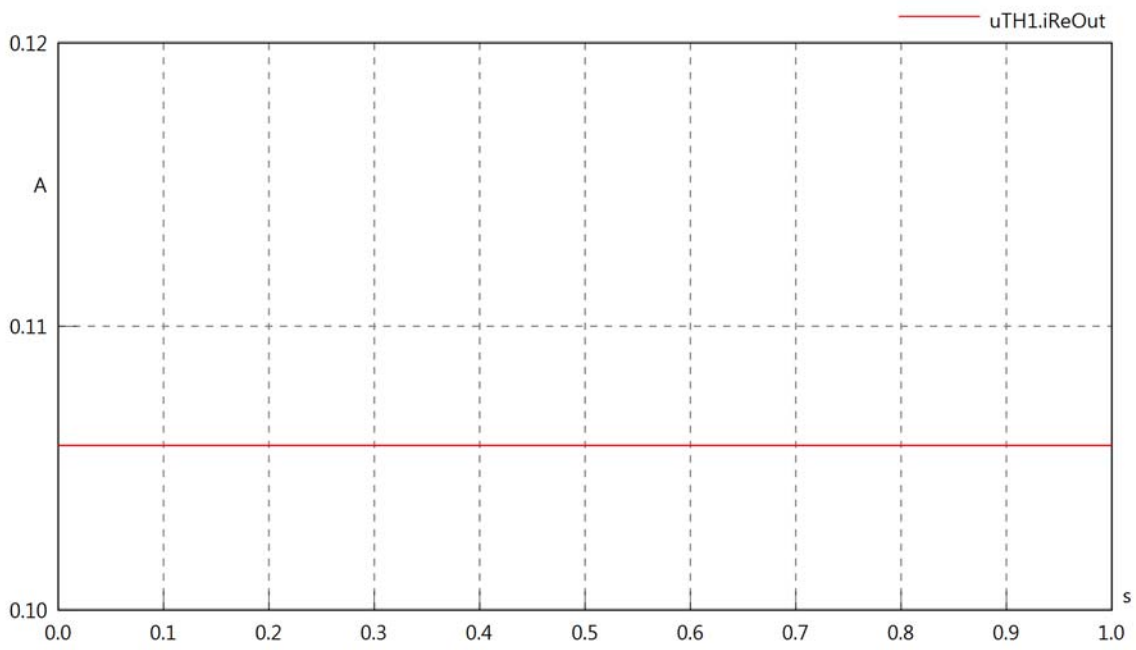

uTH1.iImOut

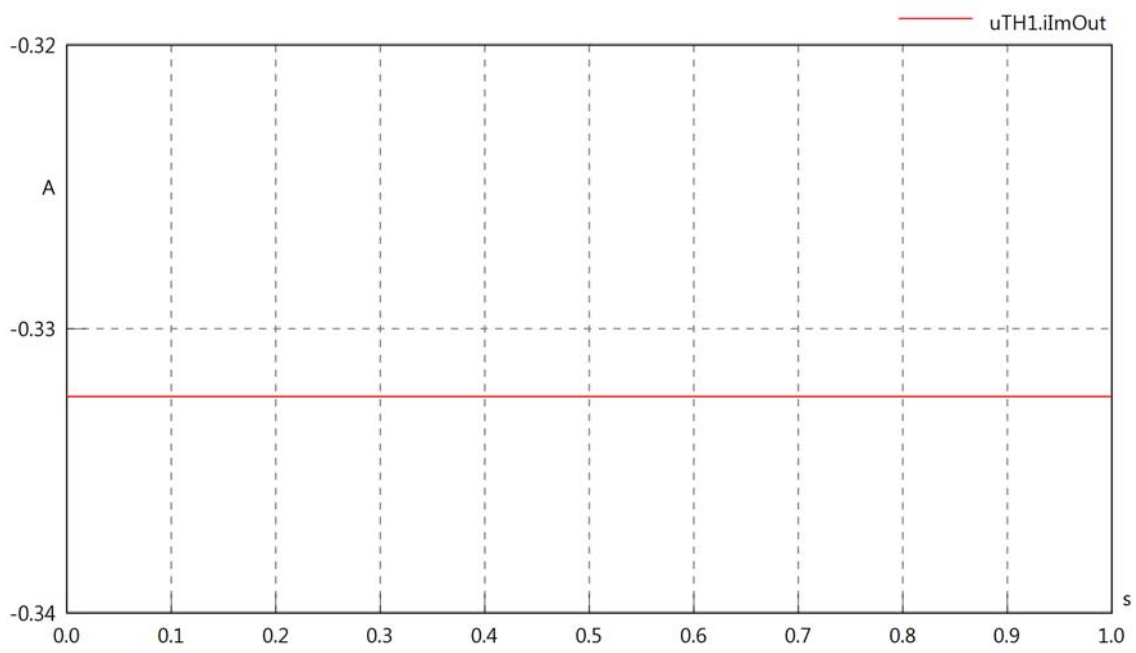

uTH1.phiVIn

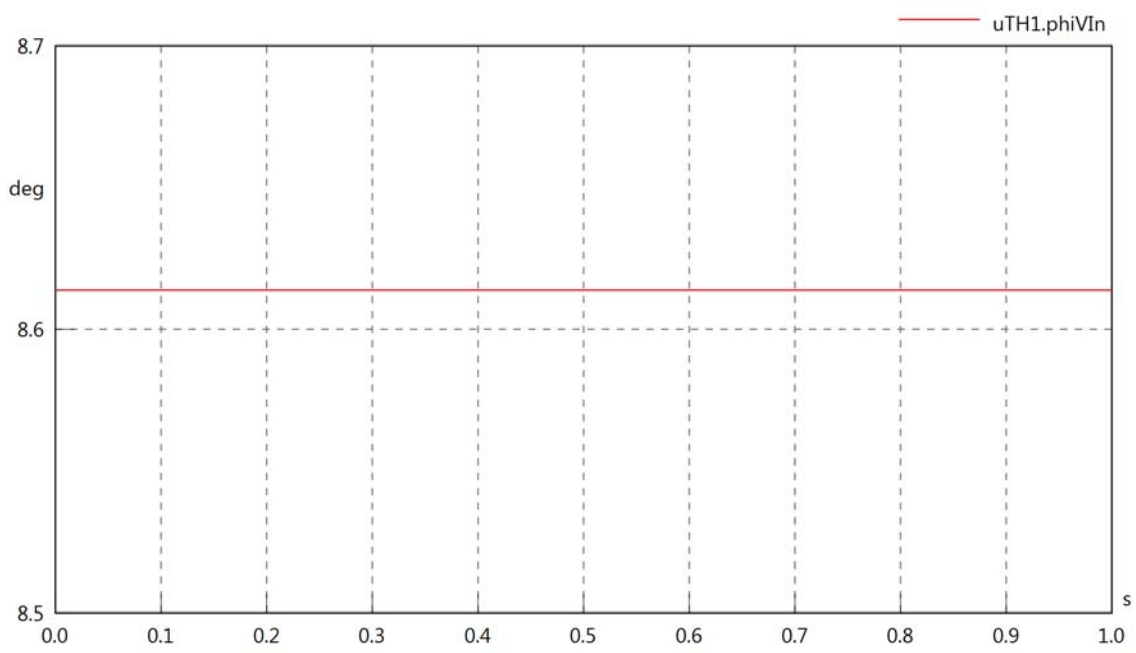

uTH1.philIn

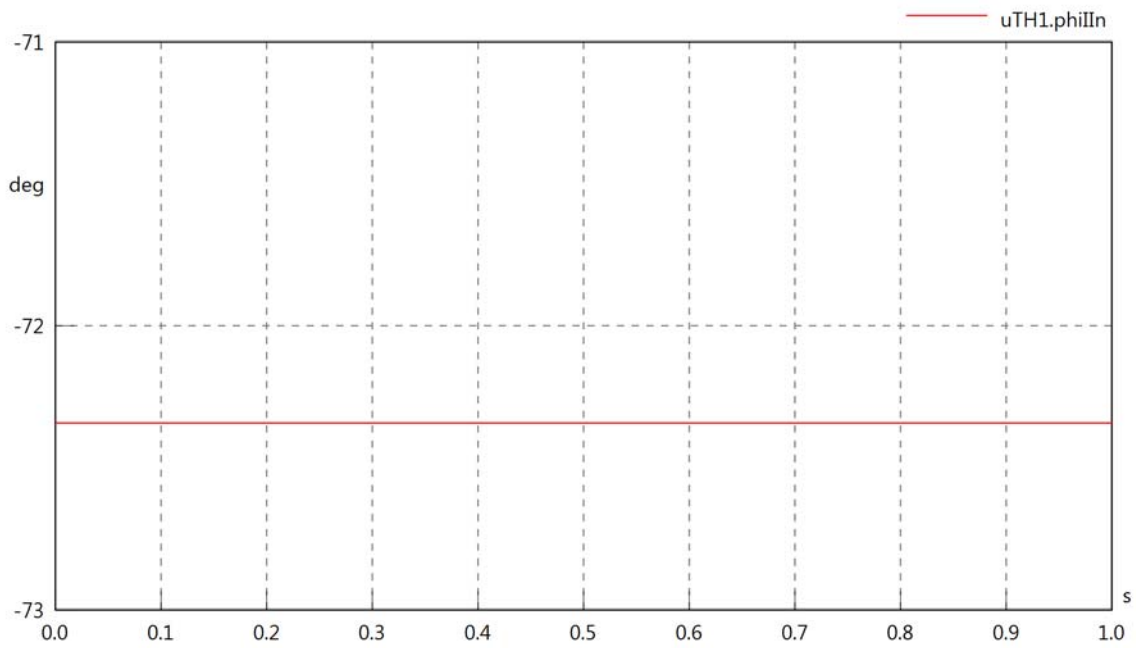

uTH1.philVIn

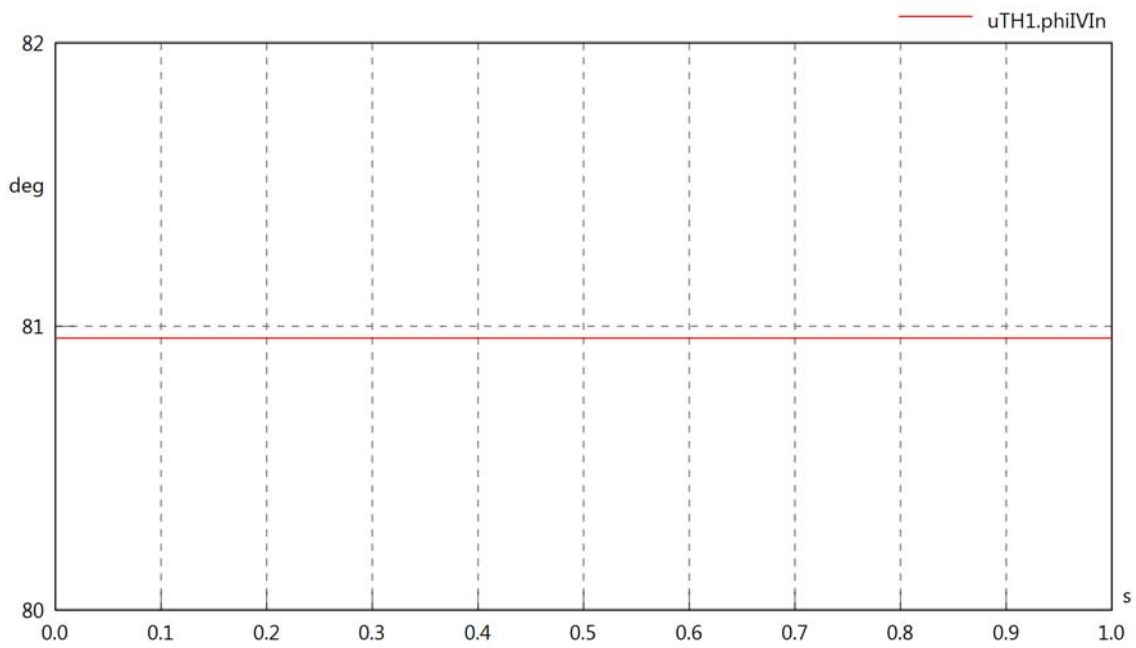

uTH1.phiVOut

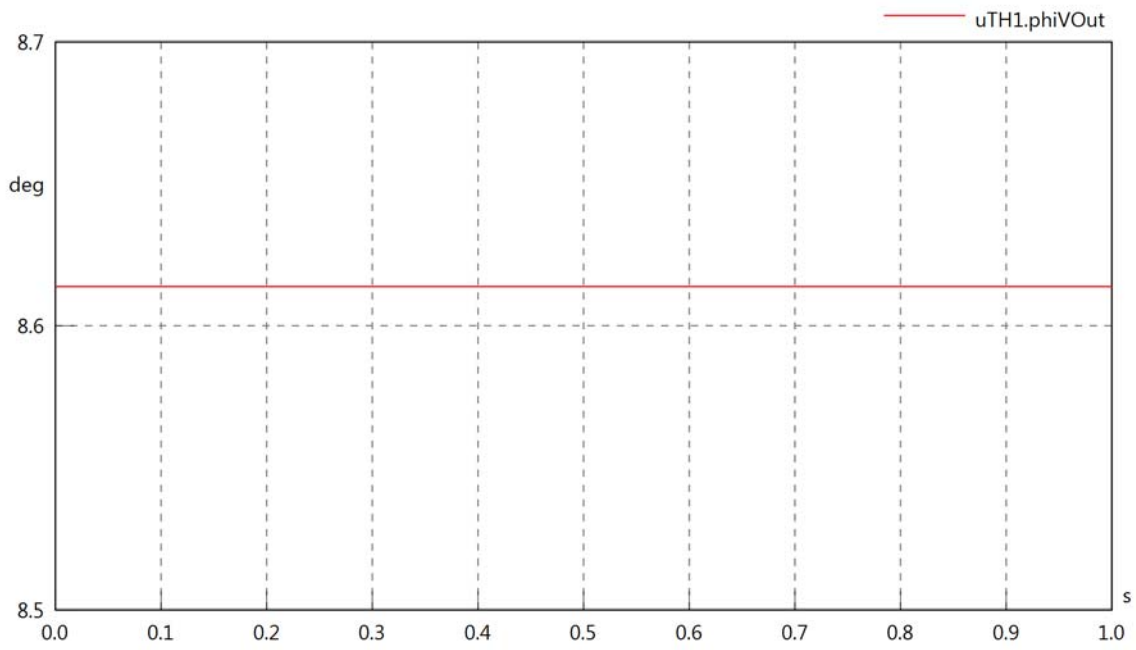

uTH1.philOut

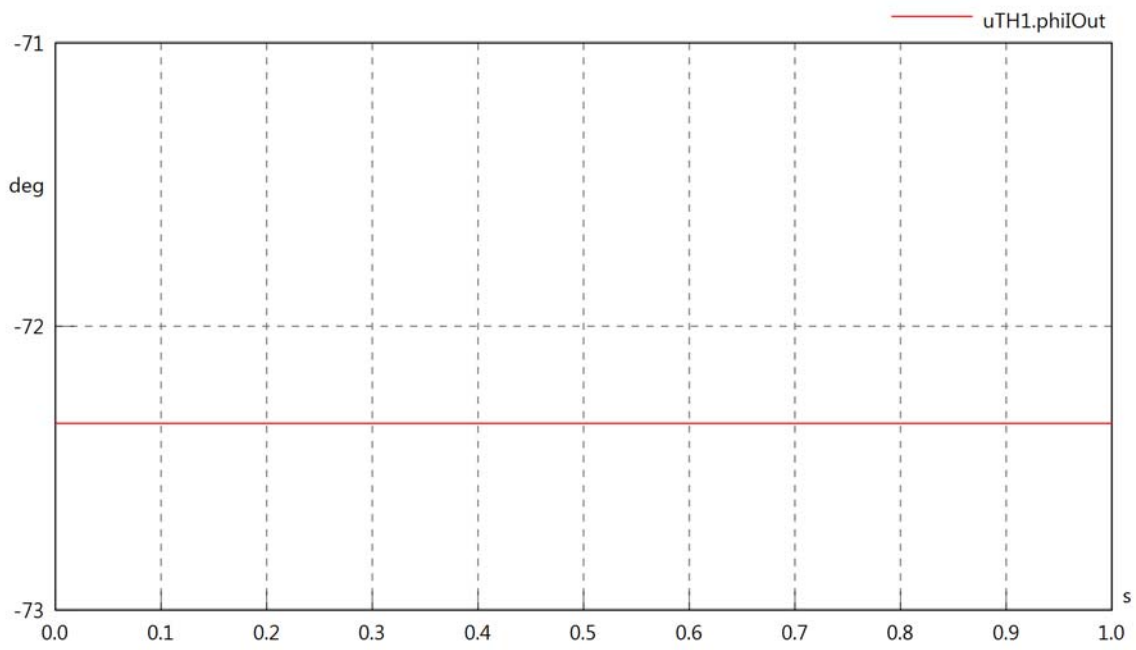

uTH1.philVOut

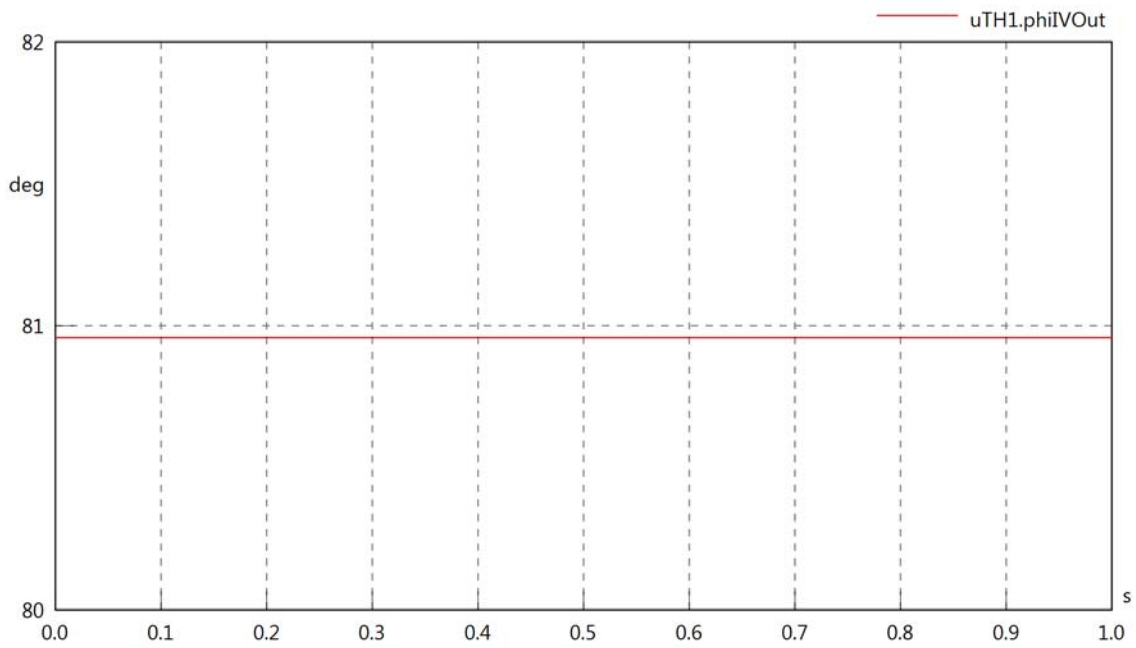

uTH1.PReIn

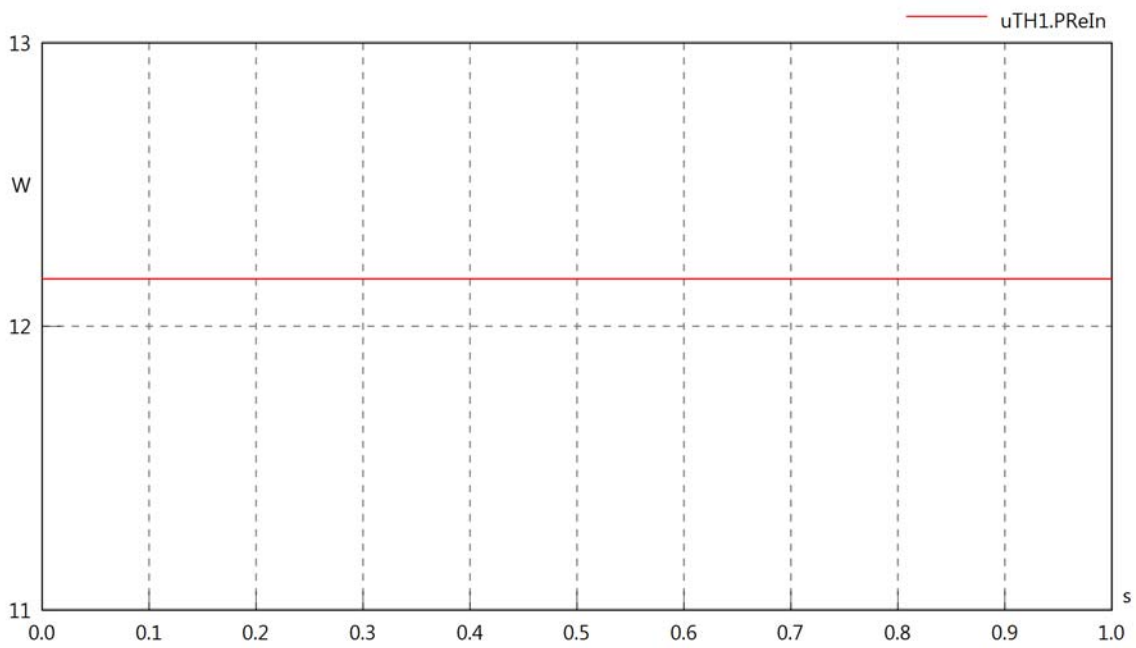

uTH1.PImIn

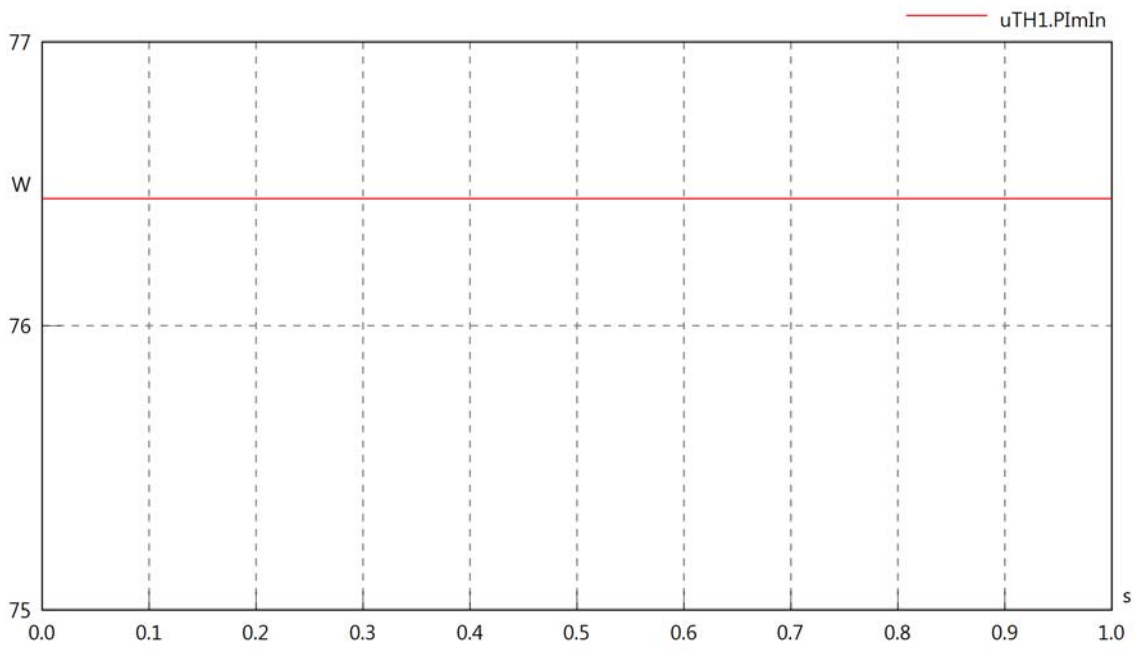

uTH1.SIn

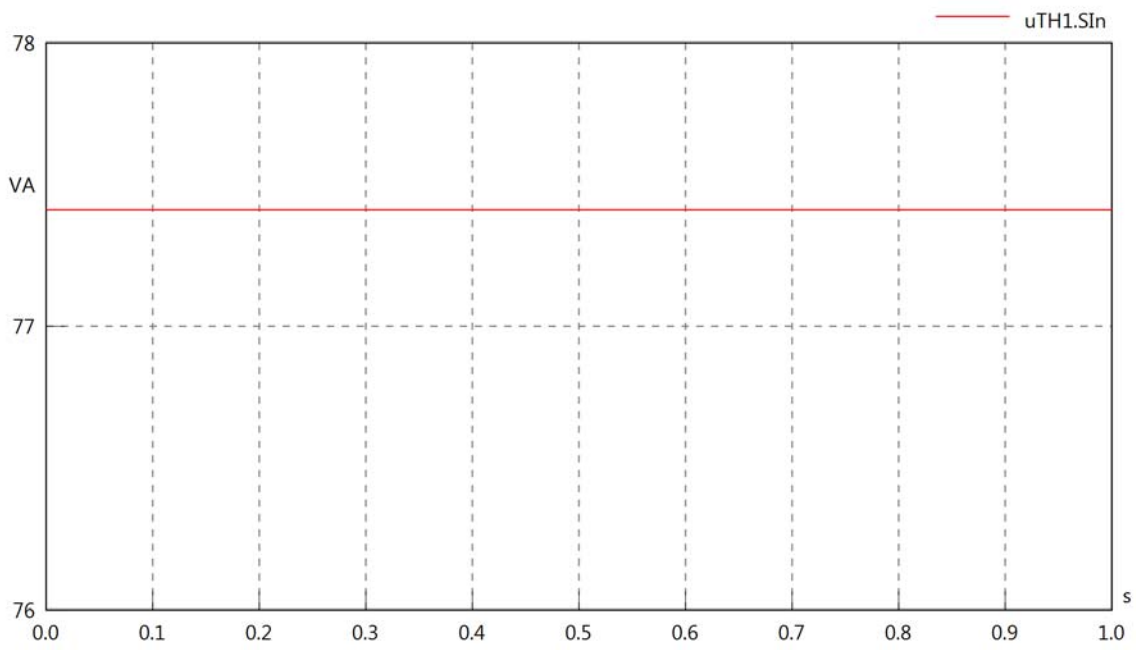

uTH1.PReOut

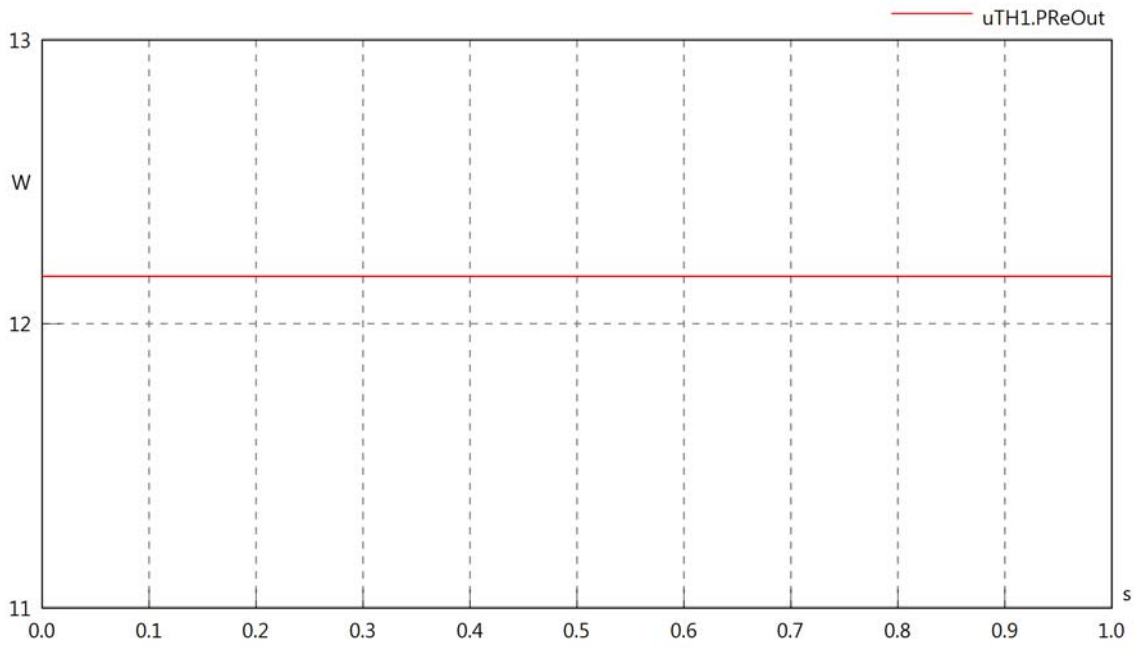

uTH1.PImOut

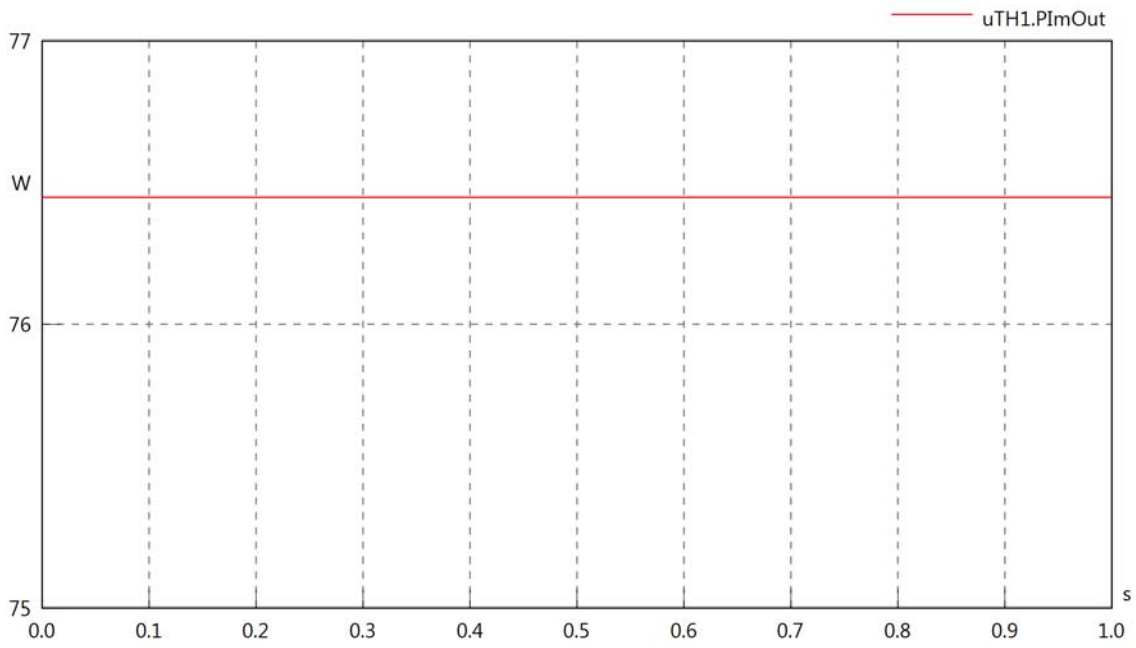

uTH1.SOut

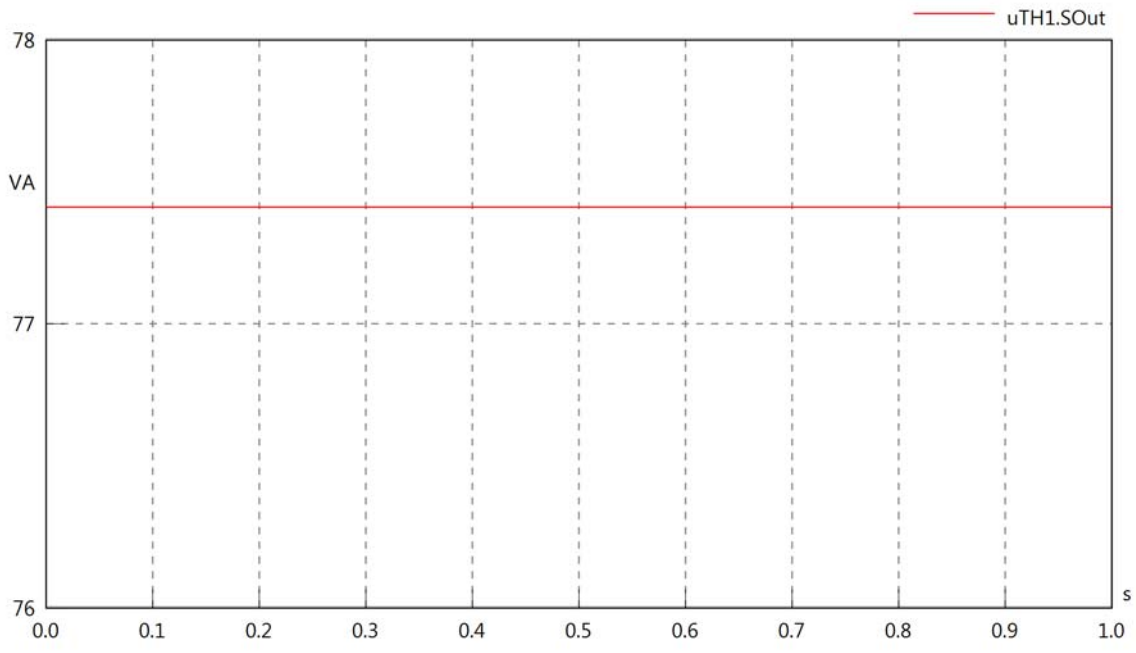
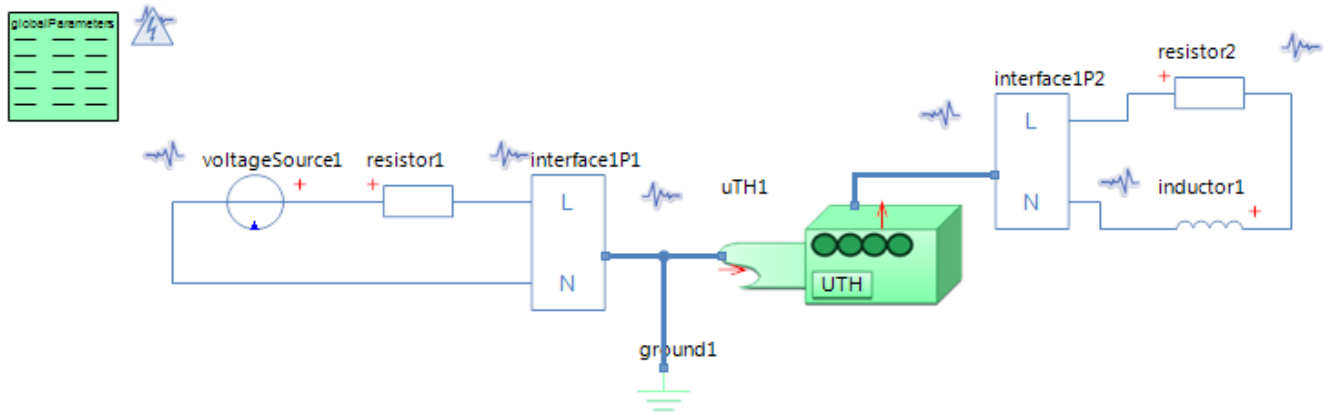

Diagram View



GlobalParameters globalParameters
Parameters

Comment	Name	Current Value	Unit
Type of Calculation	eCalculationKind	Signal Calculation	
Description of Frequency	eFrequencyKind	Linear	
Minimum Frequency	fMin	60	[Hz]
Maximum Frequency	fMax	60	[Hz]

Voltage Source voltageSource1
Parameters

Comment	Name	Current Value	Unit
Voltage RMS	VrmsSrc	230	[V]
Phase	phi	0	[deg]

Resistor resistor1
Parameters

Comment	Name	Current Value	Unit
Resistance	R	100	[Ohm]

Resistor resistor2
Parameters

Comment	Name	Current Value	Unit
Resistance	R	100	[Ohm]

Inductor inductor1
Parameters

Comment	Name	Current Value	Unit
Inductance	L	5	[mH]

Umbilical Termination Head uTH1
Parameters

Comment	Name	Current Value	Unit
Poor or failing L1 connection	bL1	true	
Resistance in L1 connection	rL1	1	[kOhm]
Conductance between L1 and N	G	50	[1/Ohm]

uTH1.VrmsIn

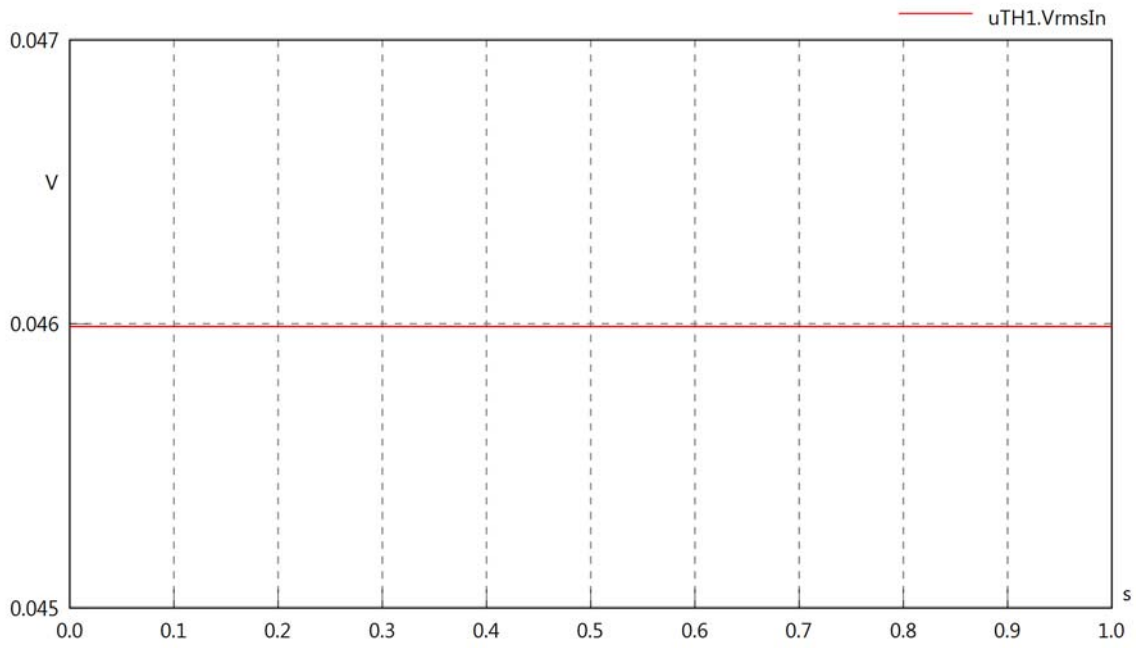

uTH1.vReIn

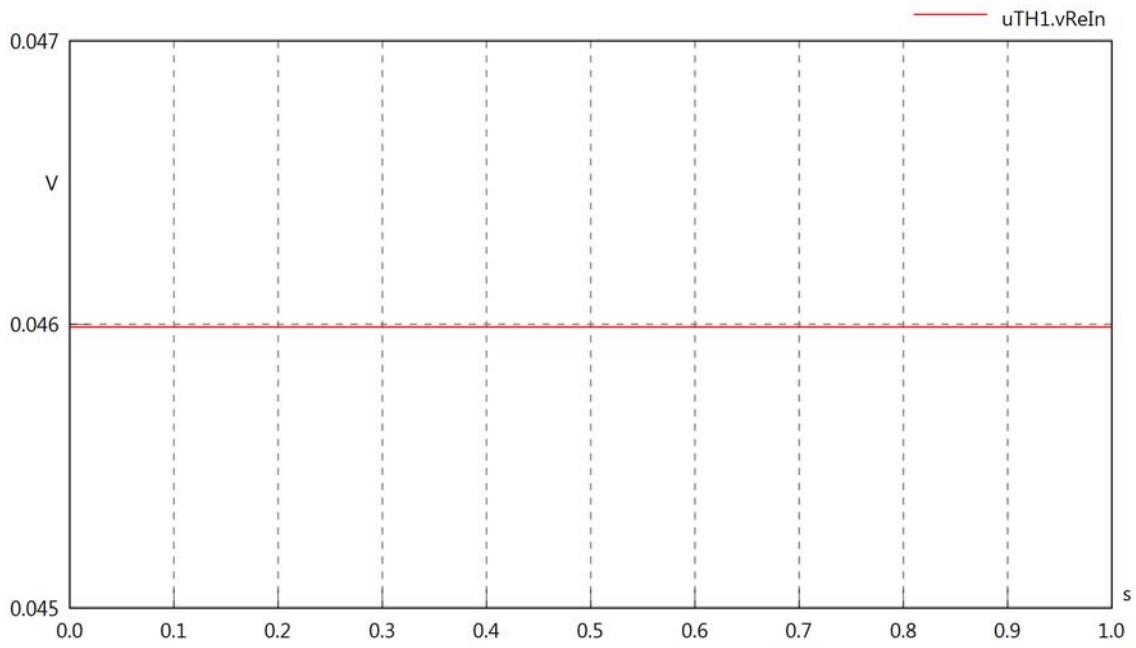

uTH1.vImIn

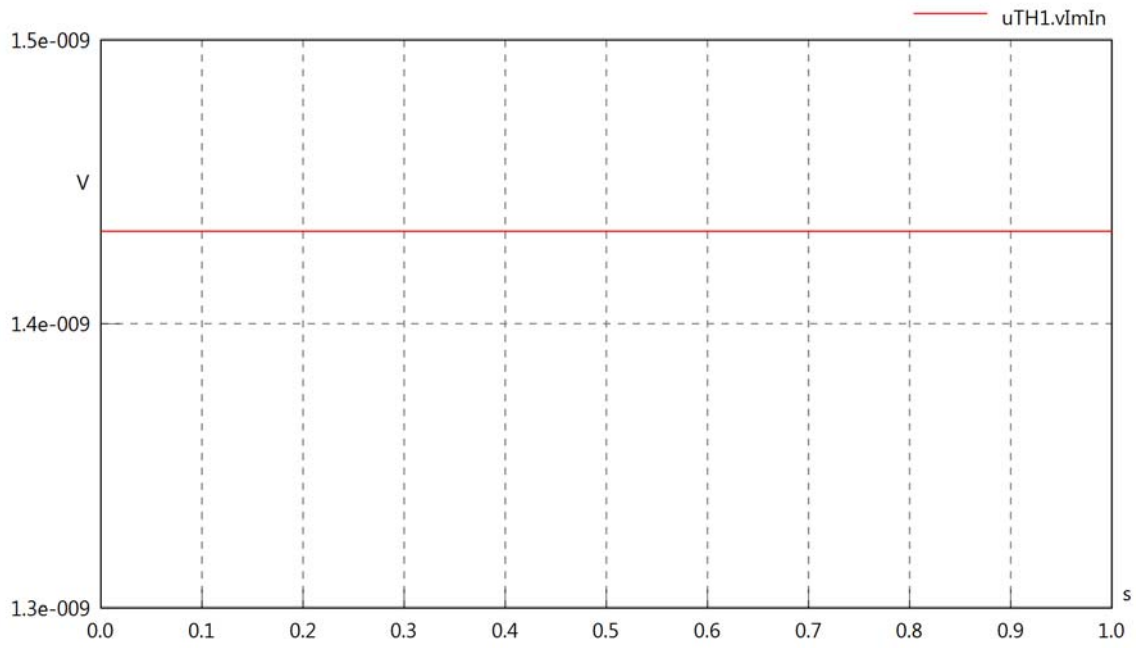

uTH1.VrmsOut

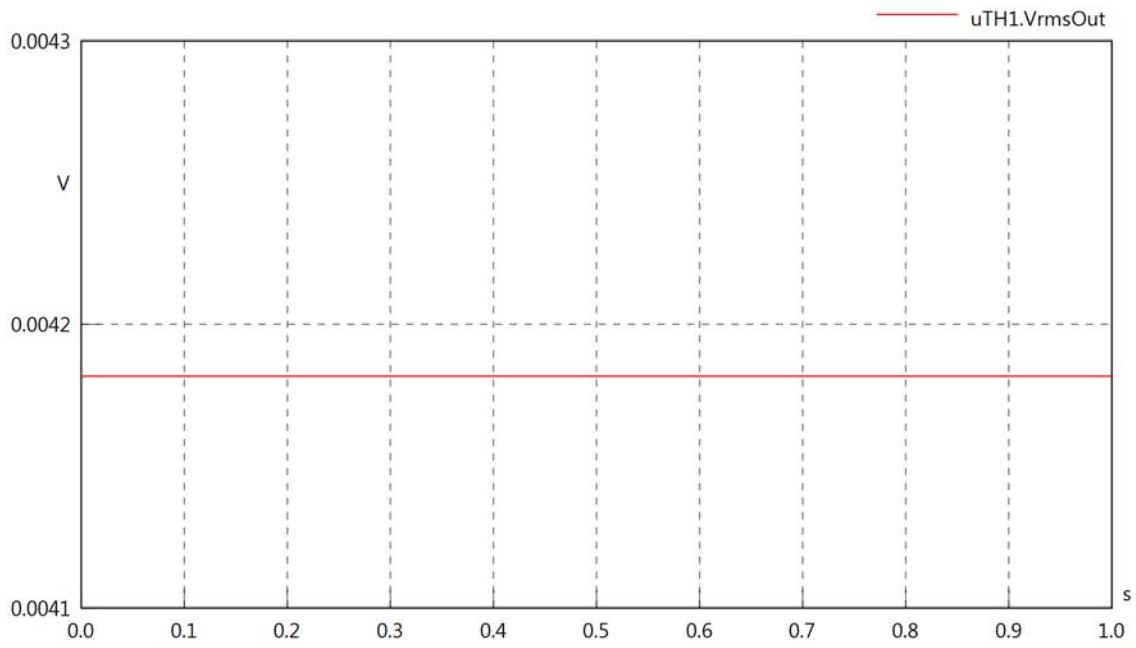

uTH1.vReOut

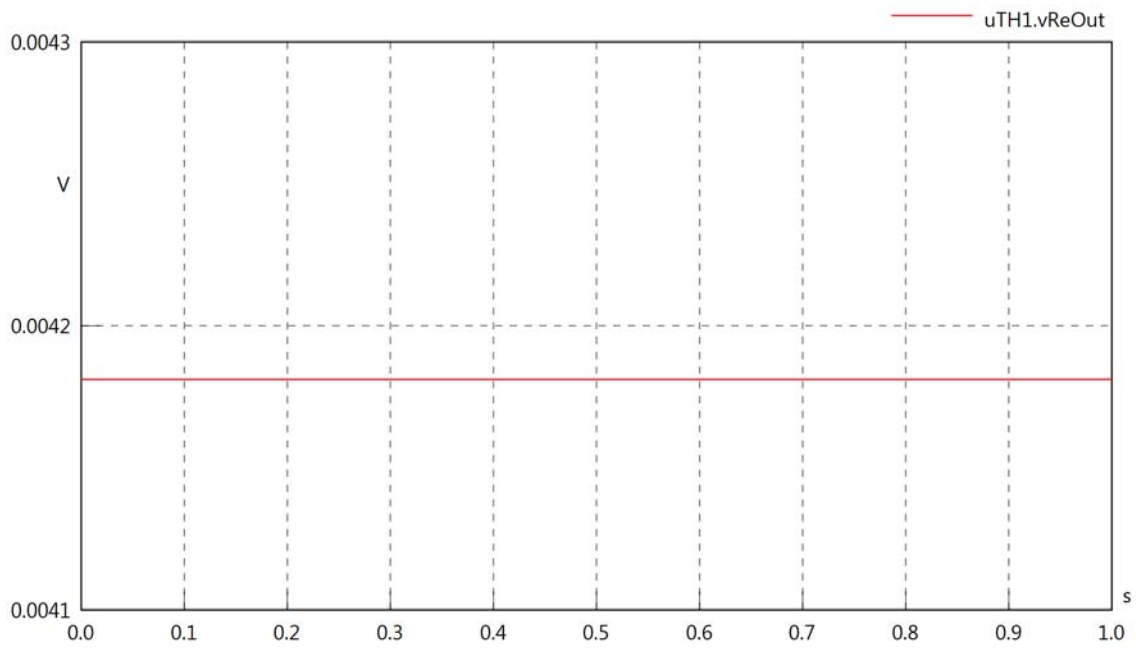

uTH1.vImOut

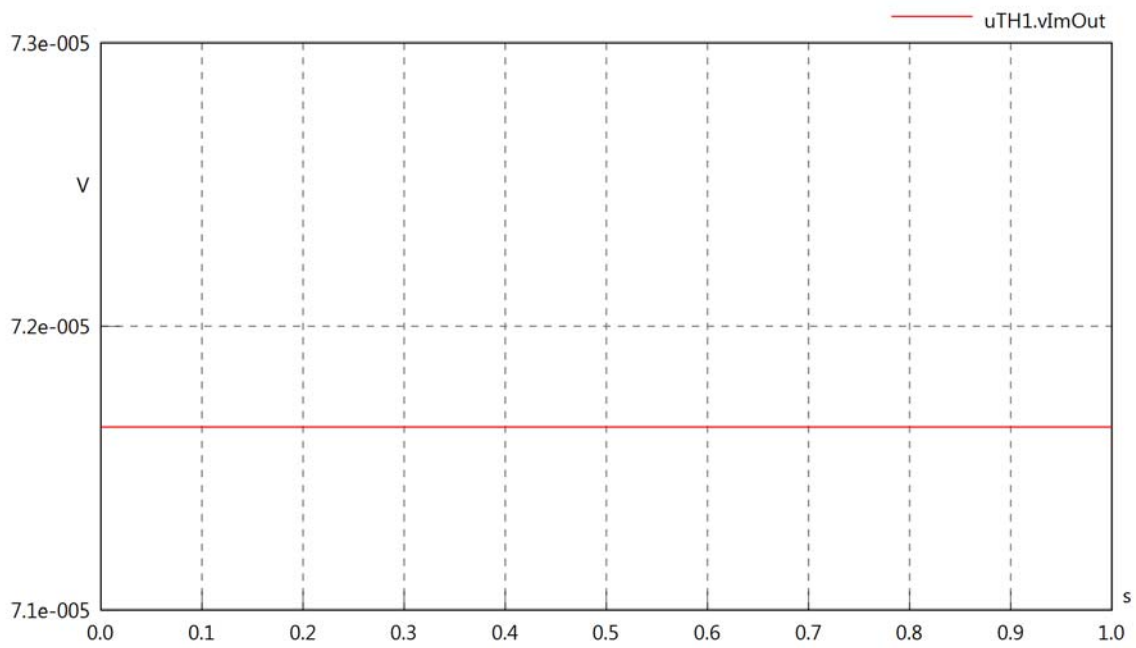

uTH1.Vrms

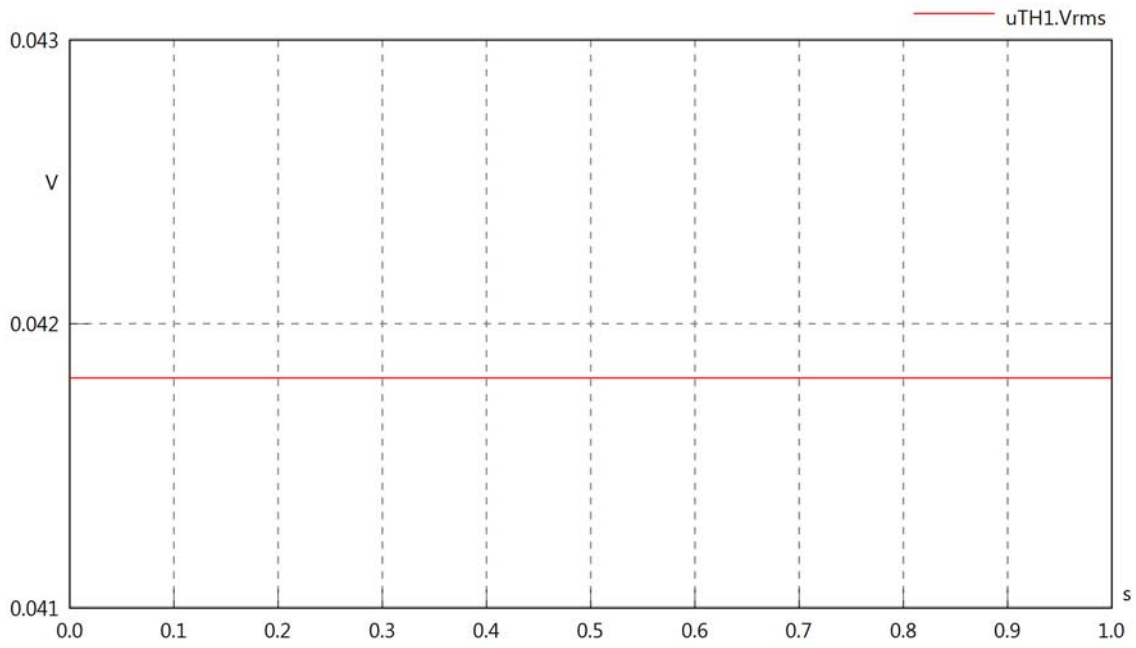

uTH1.vRe

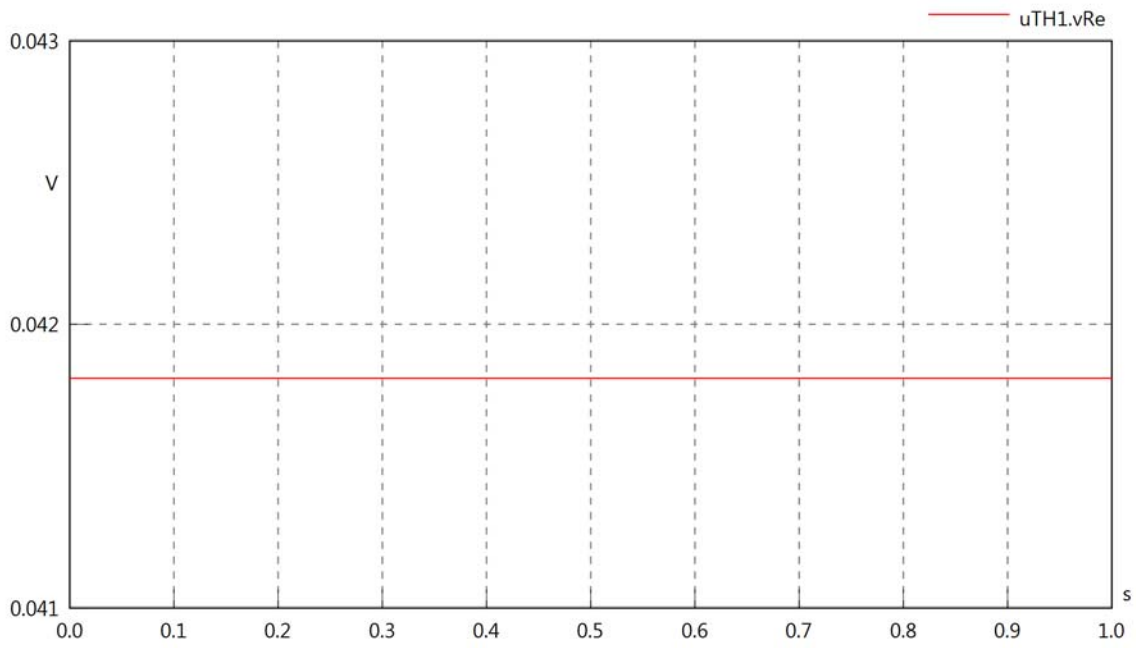

uTH1.vIm

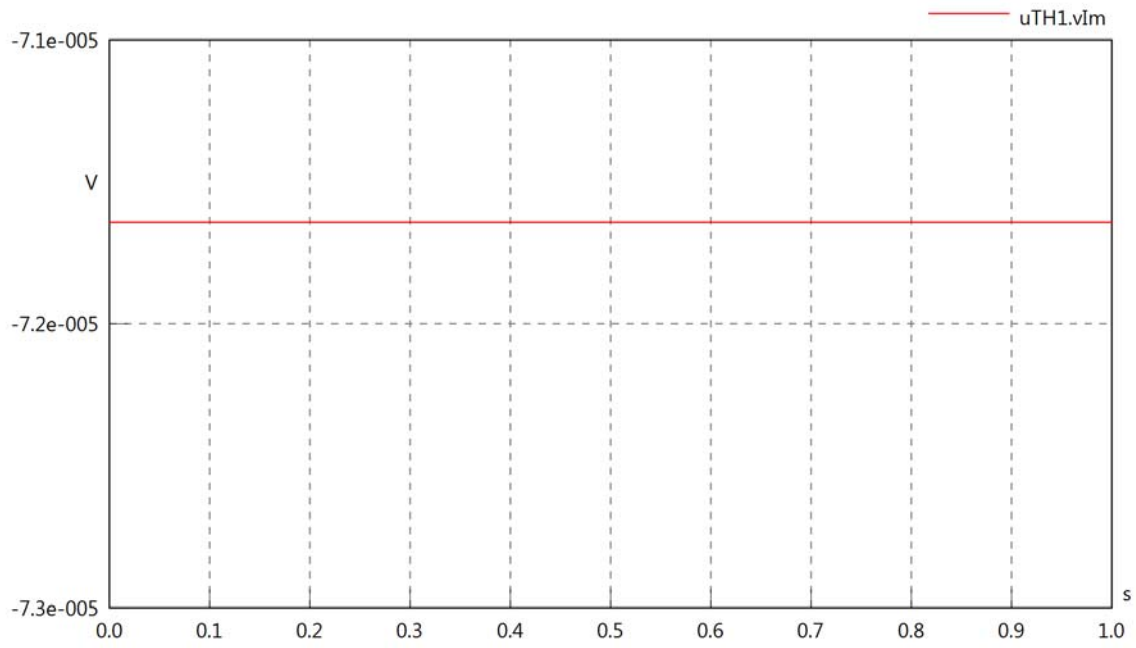

uTH1.IrmsIn

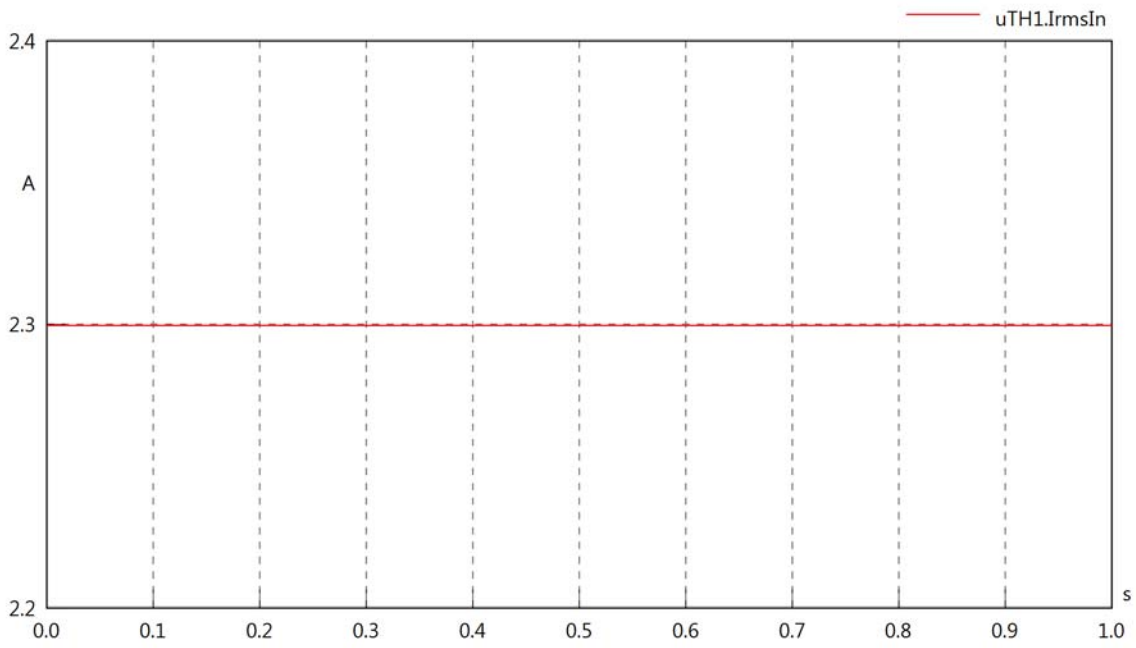

uTH1.iReIn

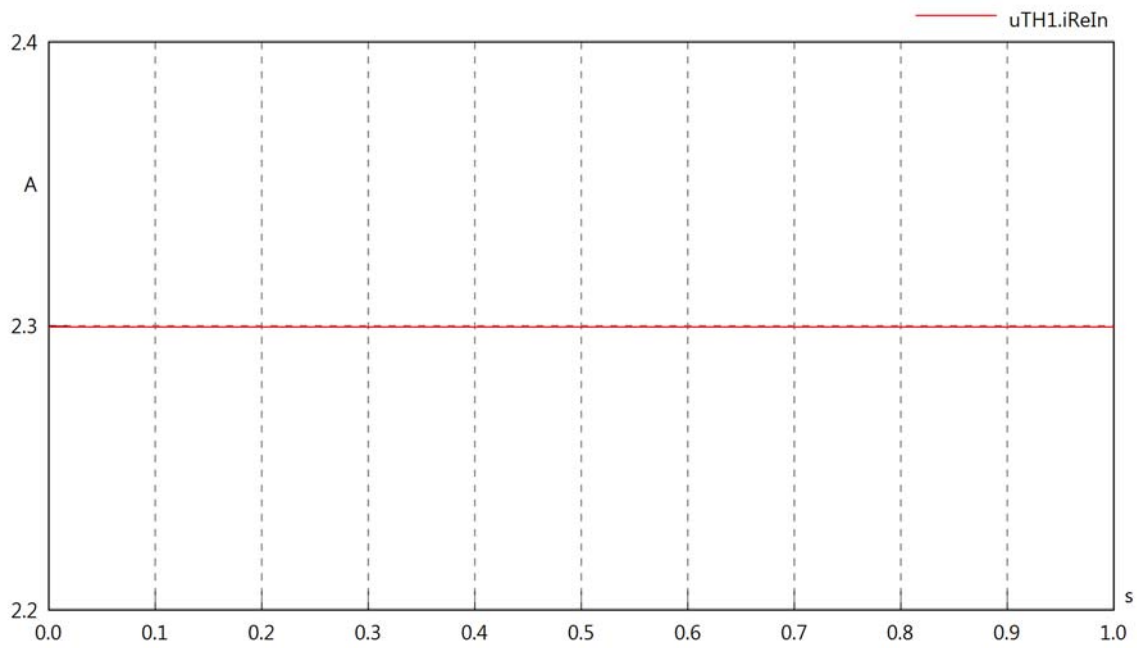

uTH1.ilmIn

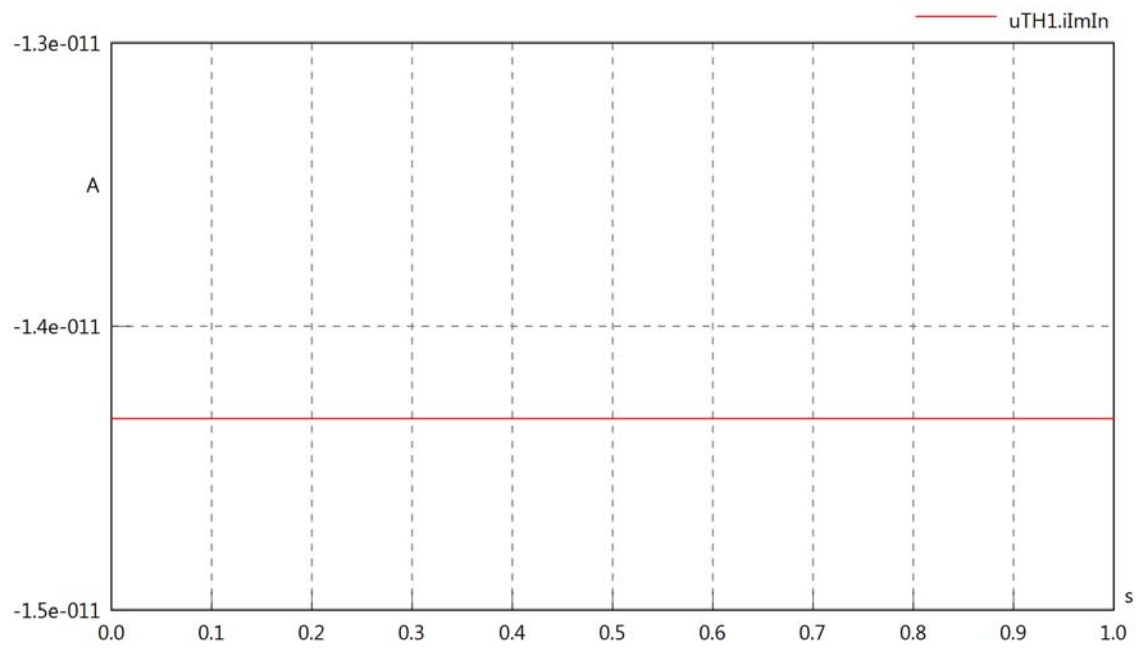

uTH1.IrmsOut

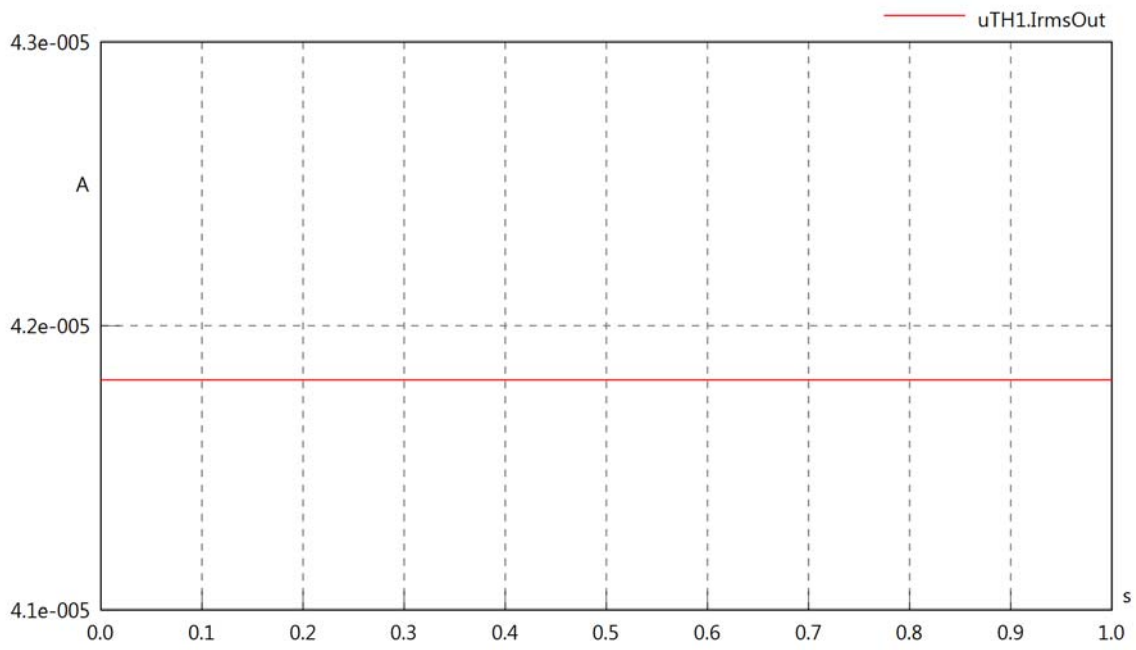

uTH1.iReOut

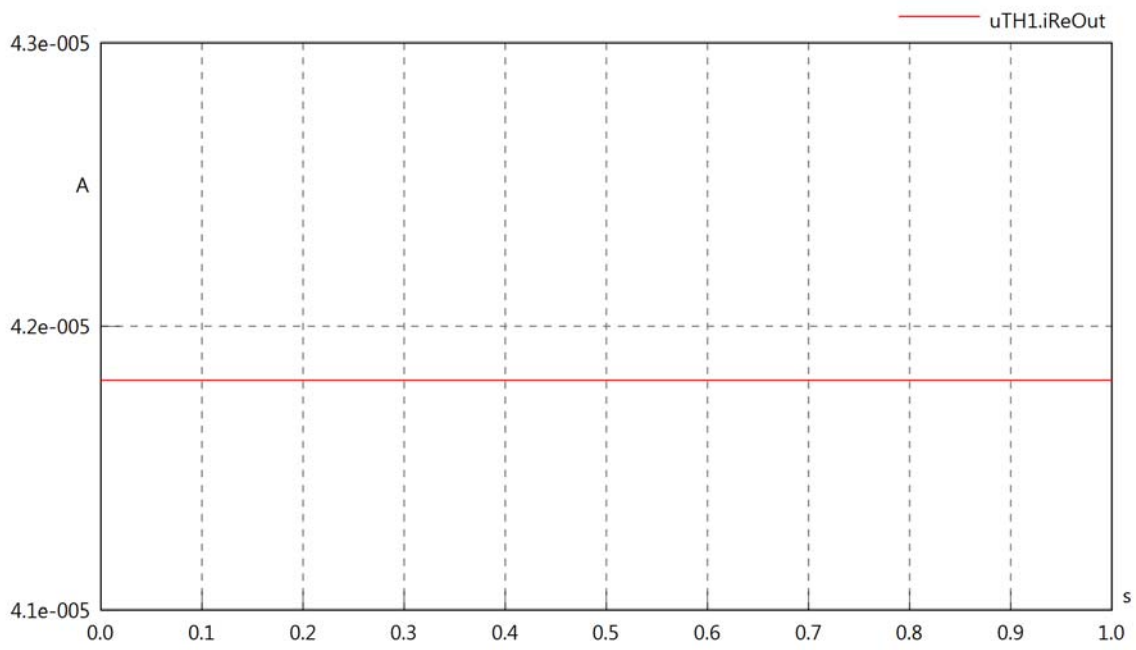

uTH1.iImOut

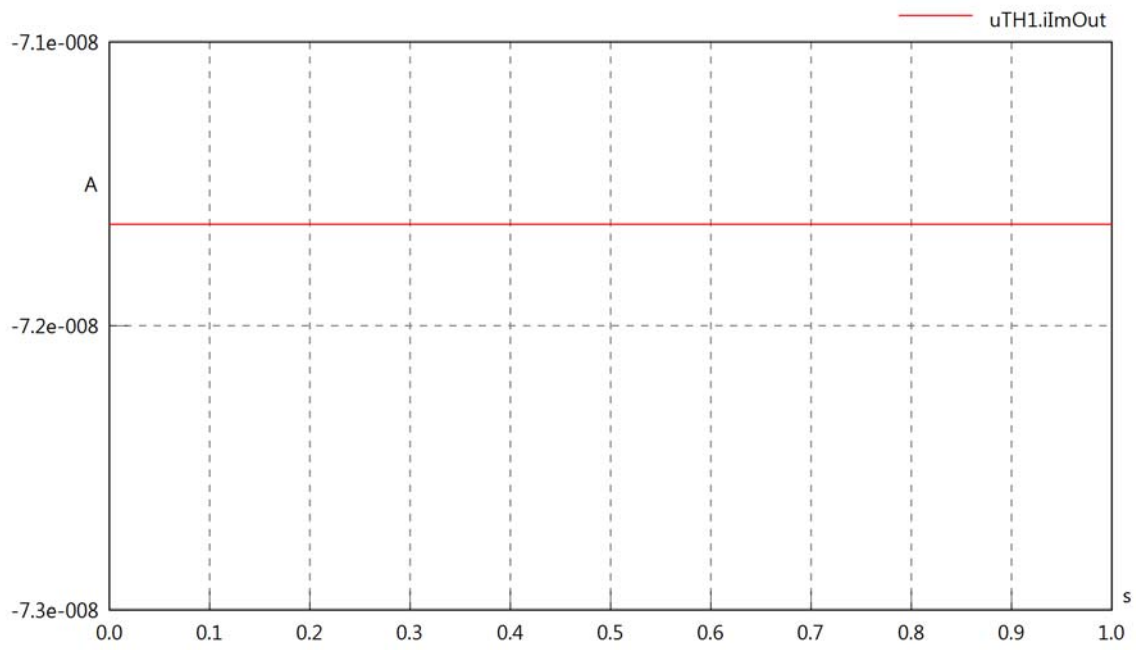

uTH1.phiVIn

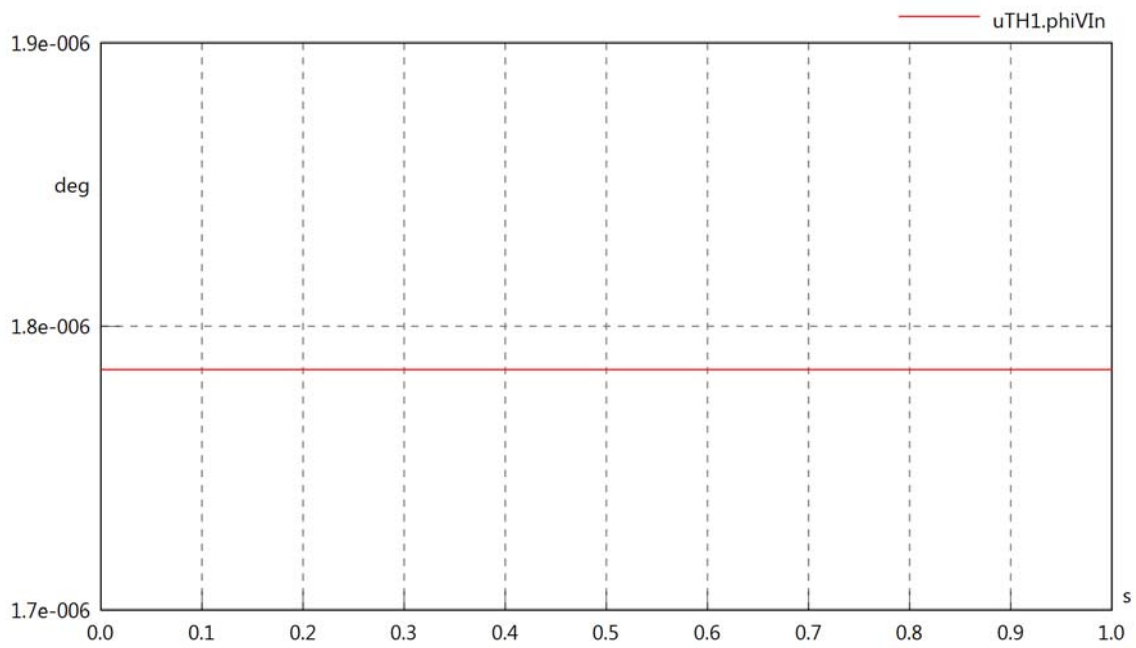

uTH1.philIn

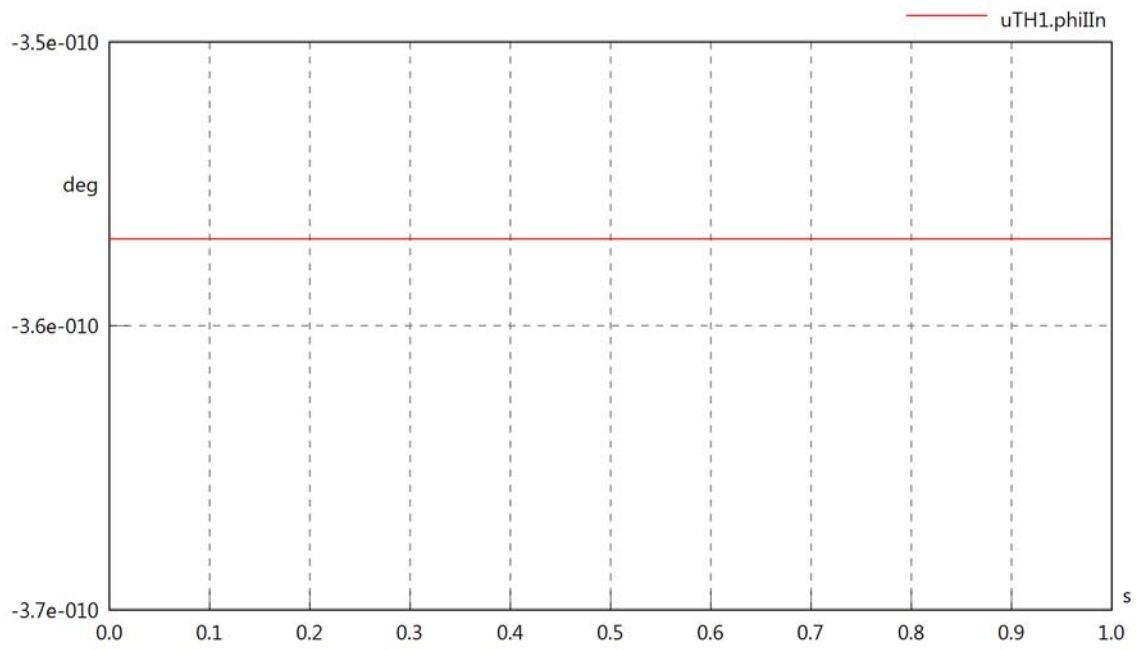

uTH1.philVIn

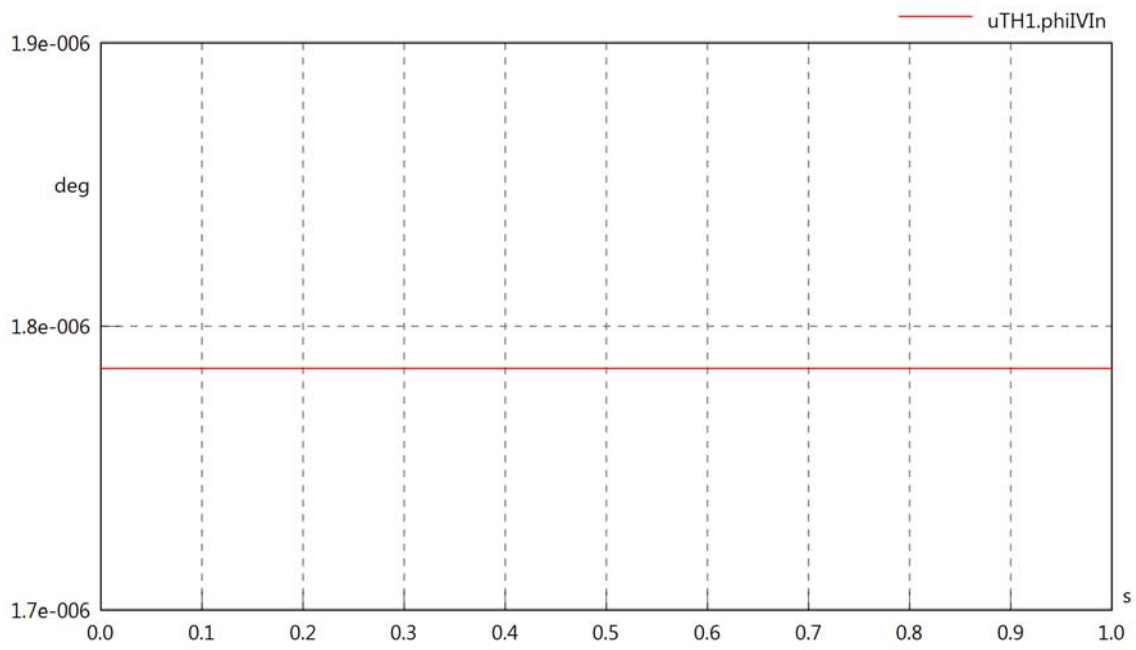

uTH1.phiVOut

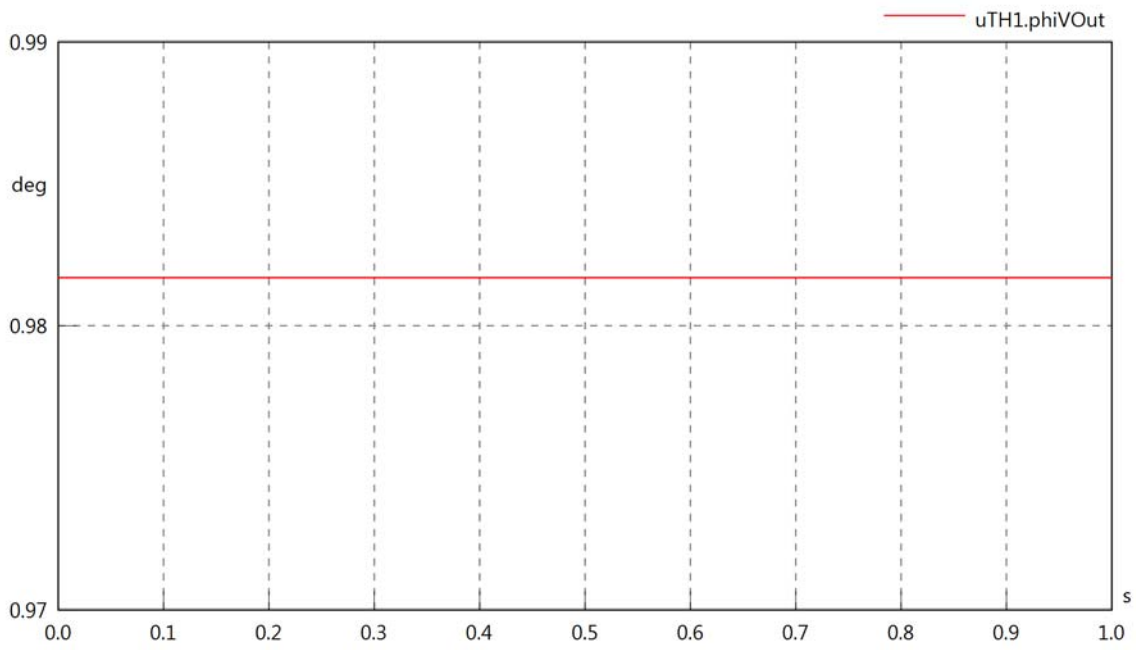

uTH1.philOut

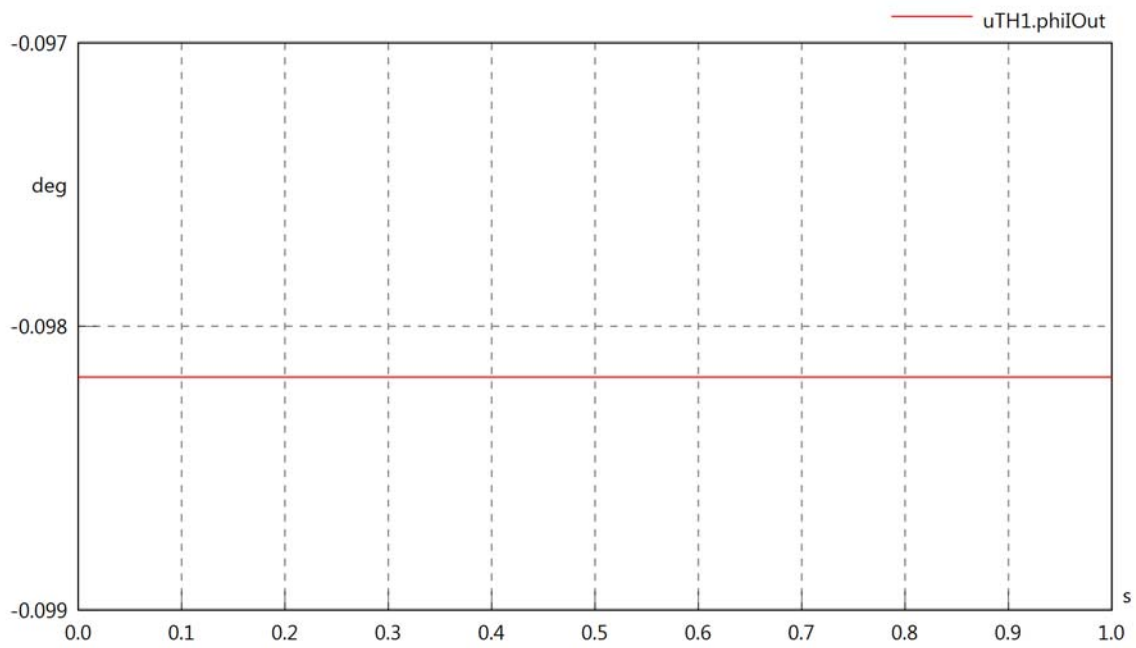

uTH1.philVOut

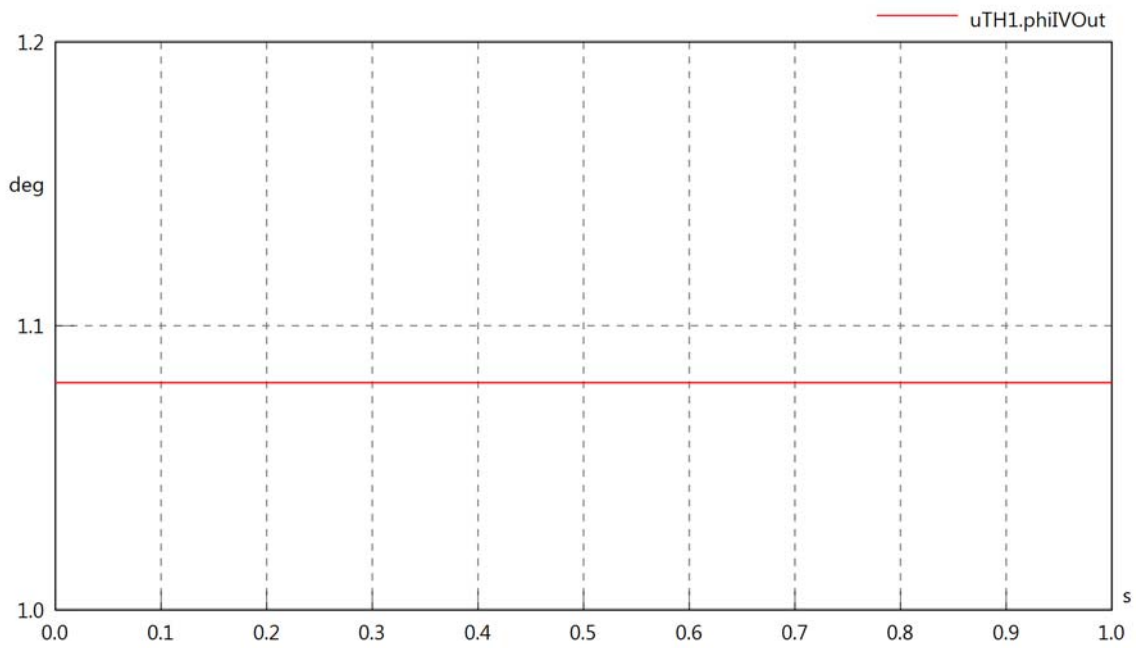

uTH1.PReIn

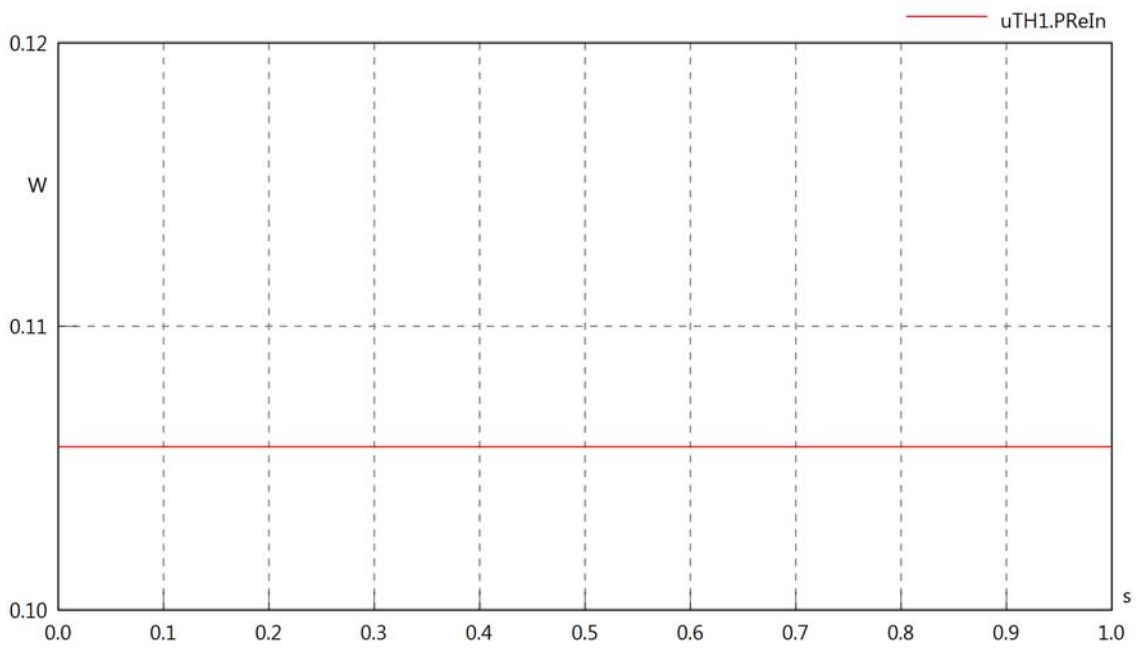

uTH1.PImIn

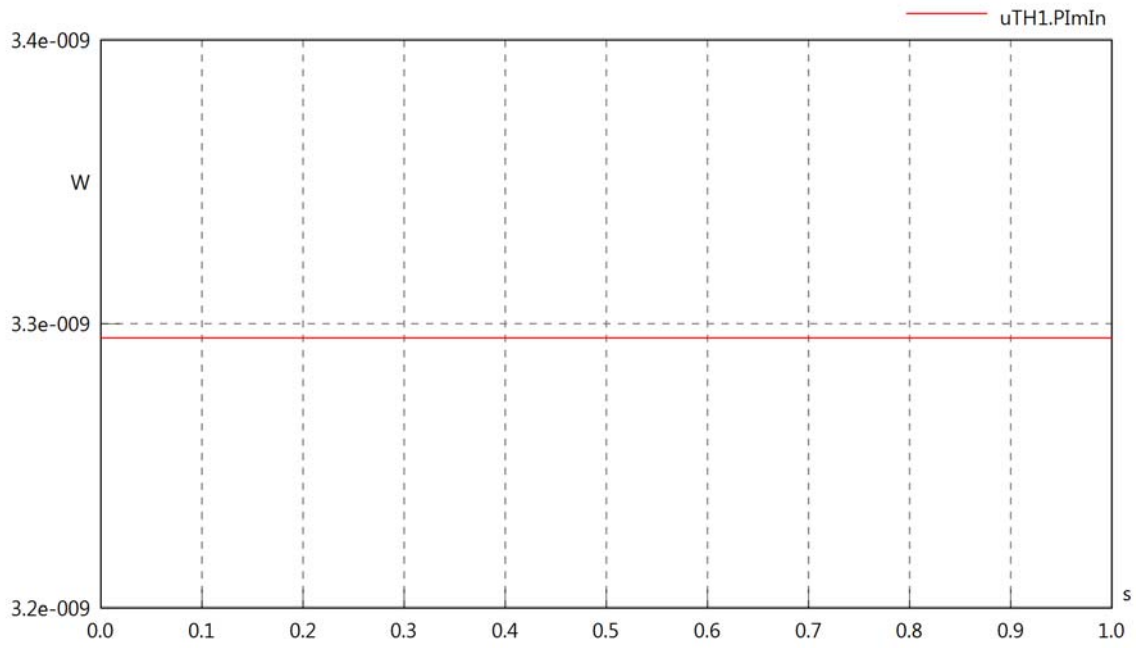

uTH1.SIn

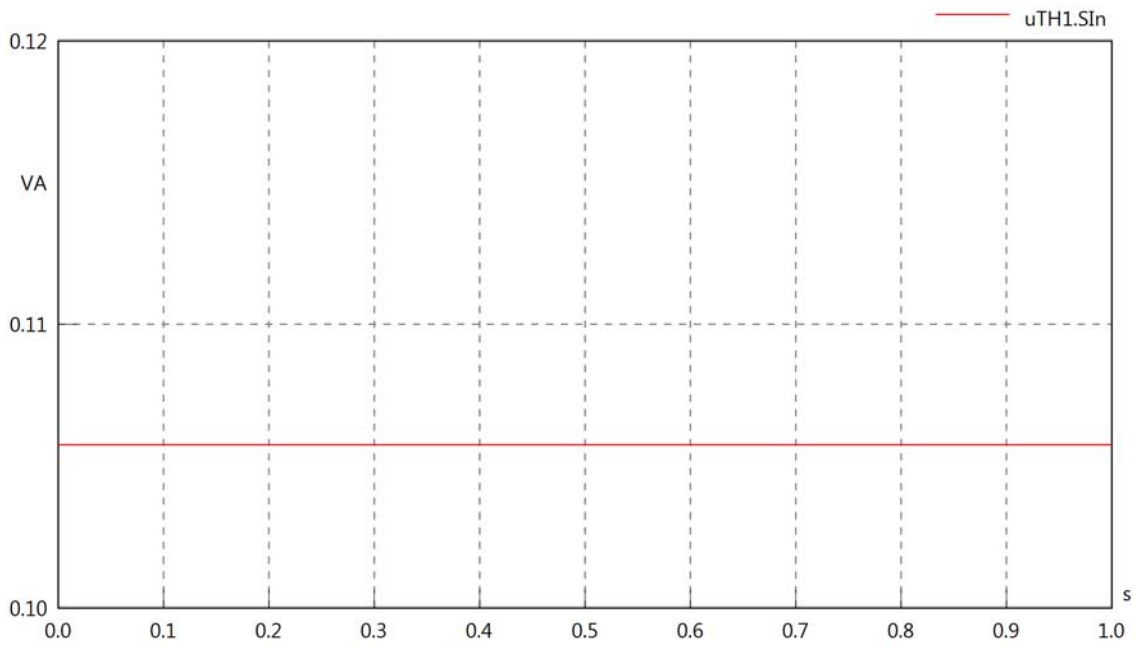

uTH1.PReOut

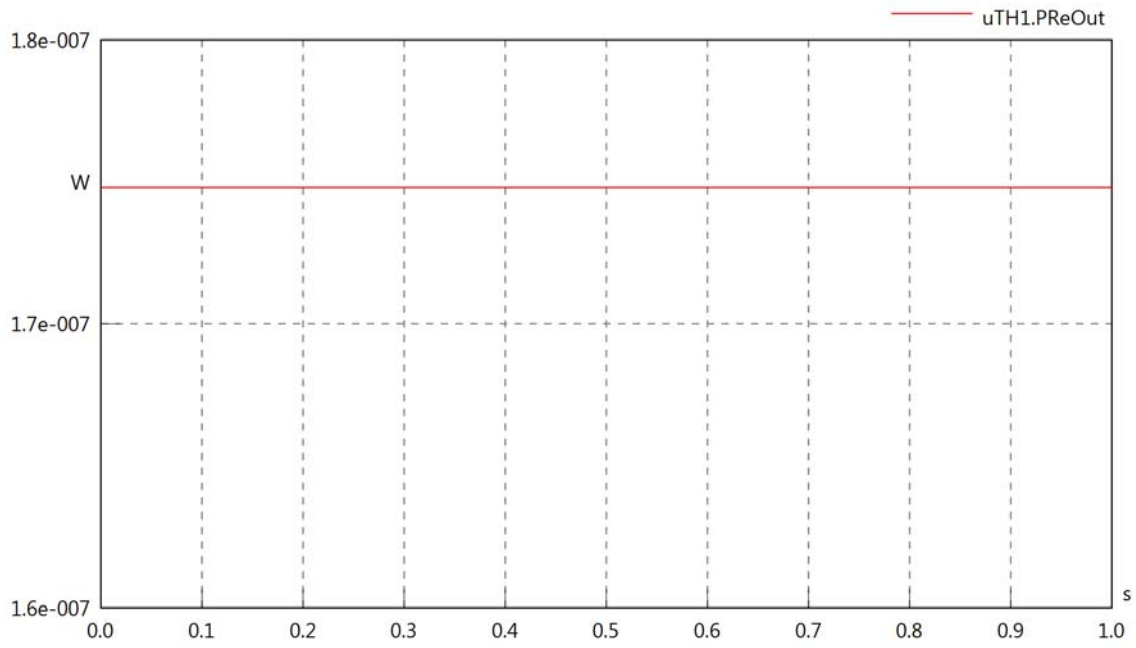

uTH1.PImOut

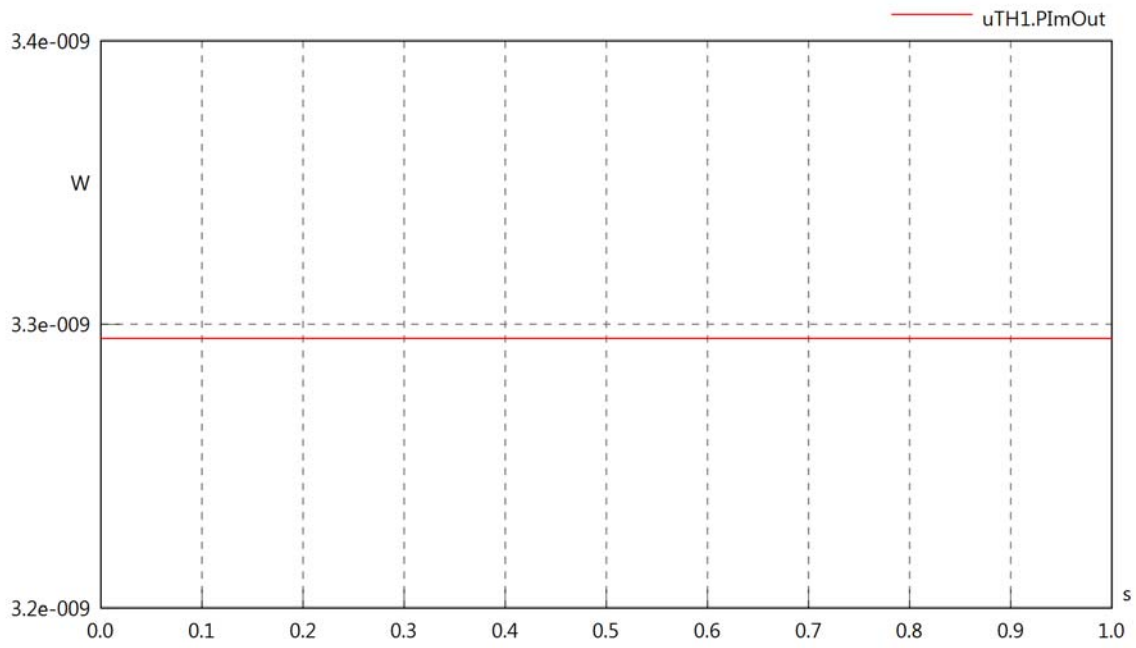

uTH1.SOut

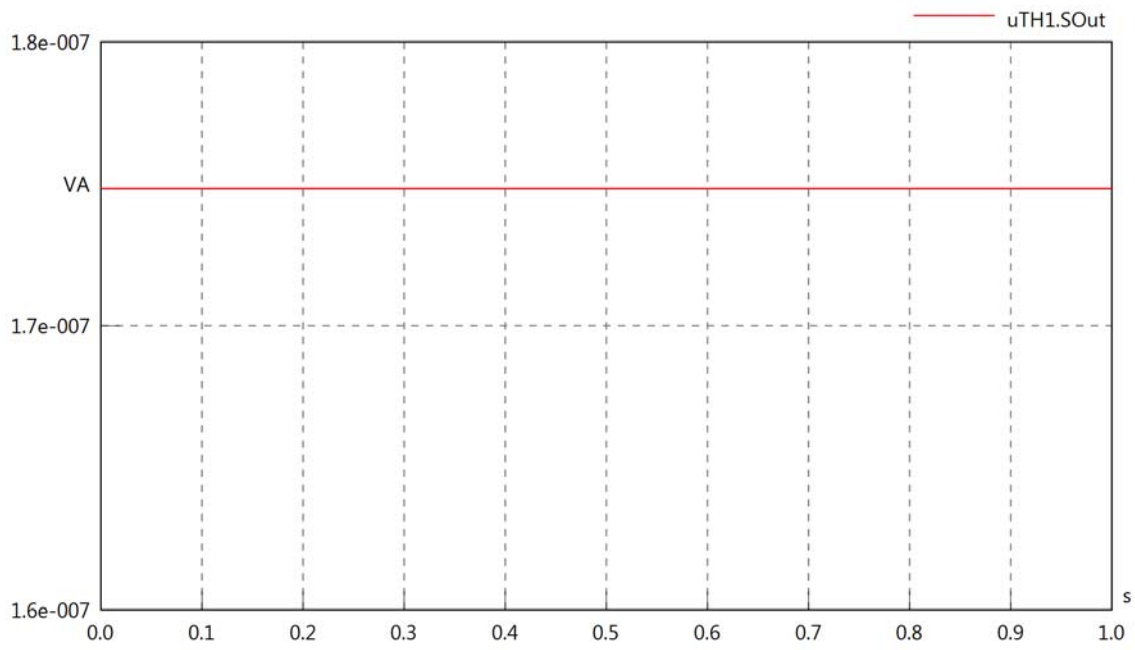
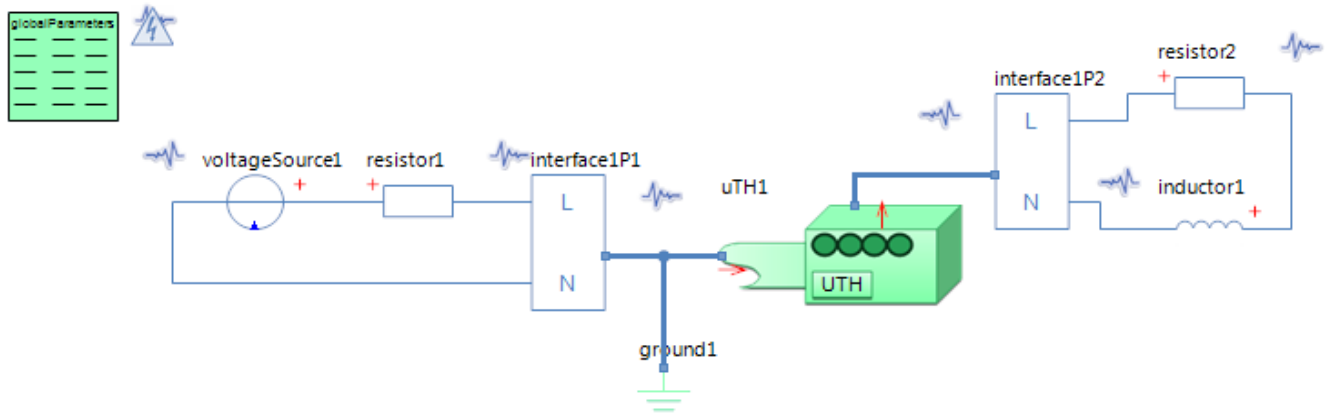

Diagram View



GlobalParameters globalParameters
Parameters

Comment	Name	Current Value	Unit
Type of Calculation	eCalculationKind	Signal Calculation	
Description of Frequency	eFrequencyKind	Linear	
Minimum Frequency	fMin	4000	[Hz]
Maximum Frequency	fMax	4000	[Hz]

Voltage Source voltageSource1
Parameters

Comment	Name	Current Value	Unit
Voltage RMS	VrmsSrc	230	[V]
Phase	phi	0	[deg]

Resistor resistor1
Parameters

Comment	Name	Current Value	Unit
Resistance	R	100	[Ohm]

Resistor resistor2
Parameters

Comment	Name	Current Value	Unit
Resistance	R	100	[Ohm]

Inductor inductor1
Parameters

Comment	Name	Current Value	Unit
Inductance	L	5	[mH]

Umbilical Termination Head uTH1
Parameters

Comment	Name	Current Value	Unit
Poor or failing L1 connection	bL1	true	
Resistance in L1 connection	rL1	1	[kOhm]
Conductance between L1 and N	G	50	[1/Ohm]

uTH1.VrmsIn

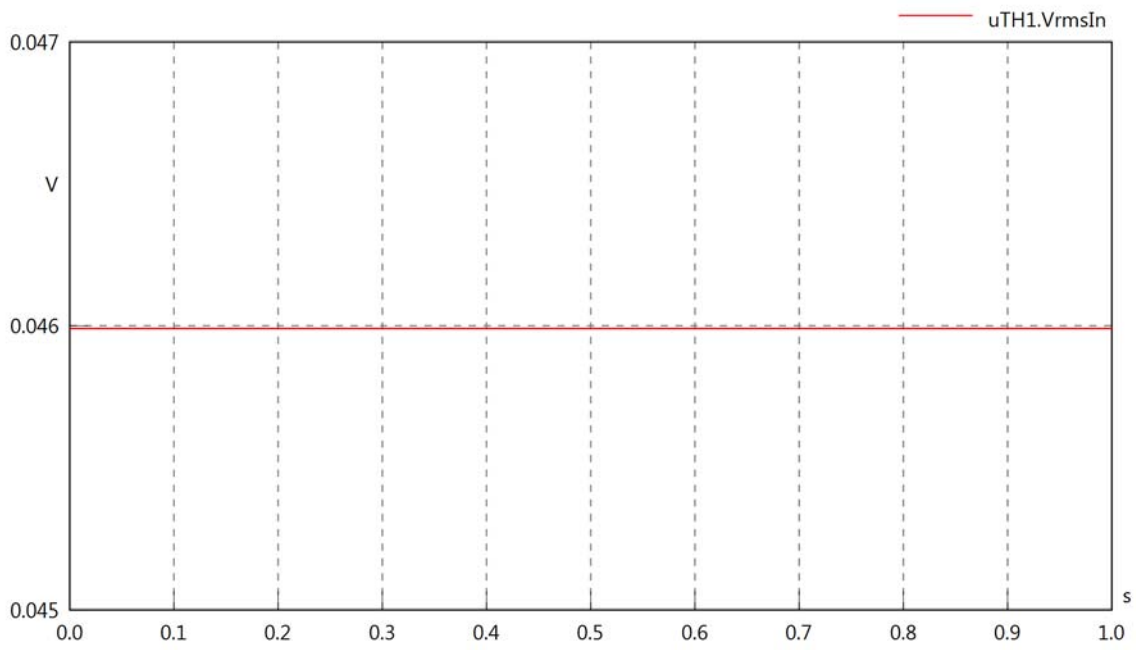

uTH1.vReIn

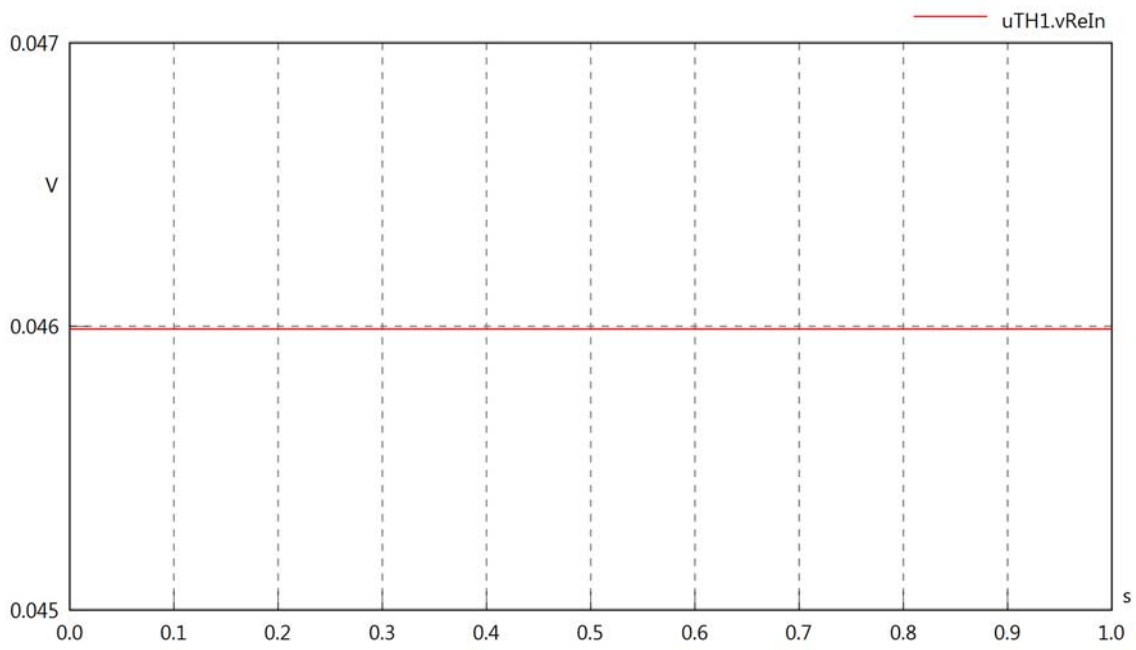

uTH1.vImIn

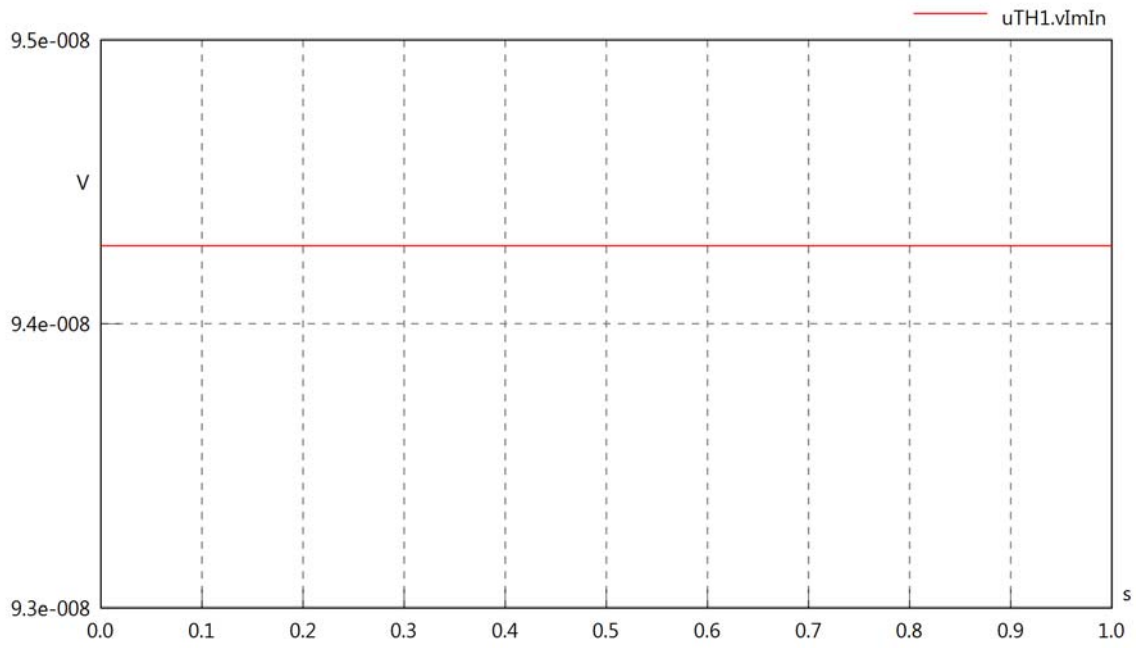

uTH1.VrmsOut

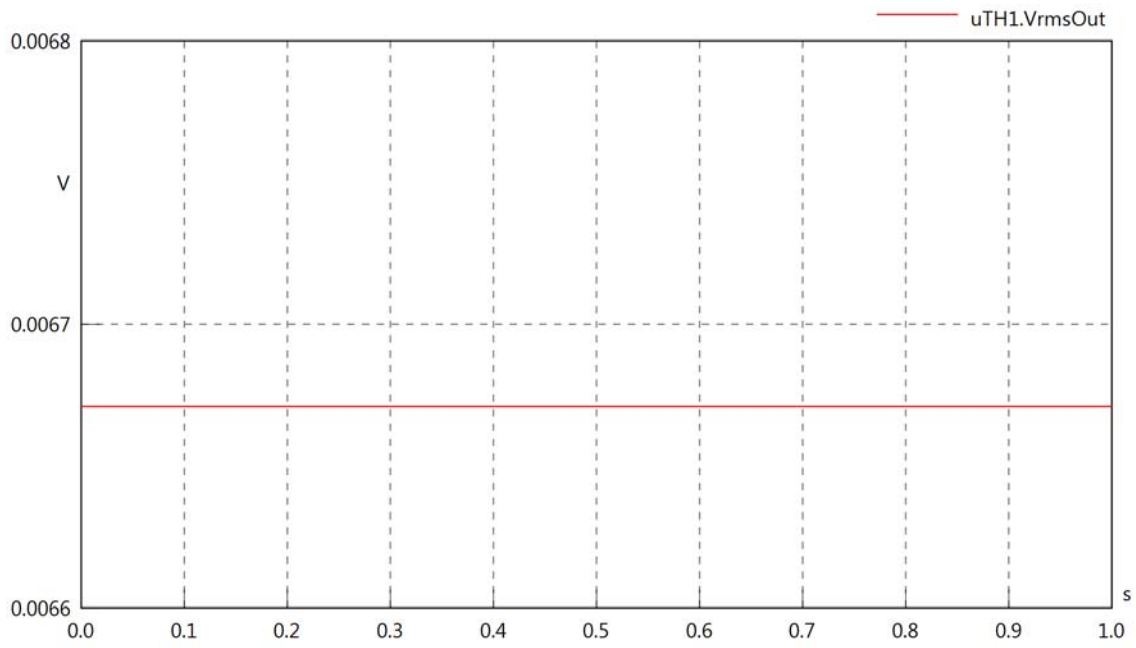

uTH1.vReOut

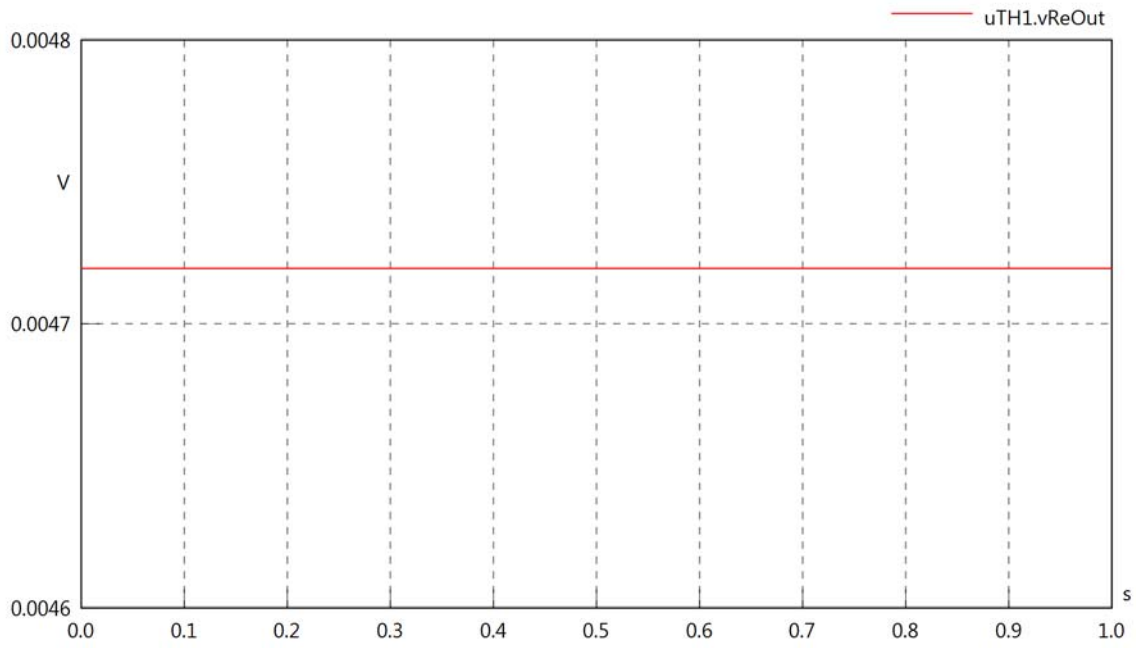

uTH1.vImOut

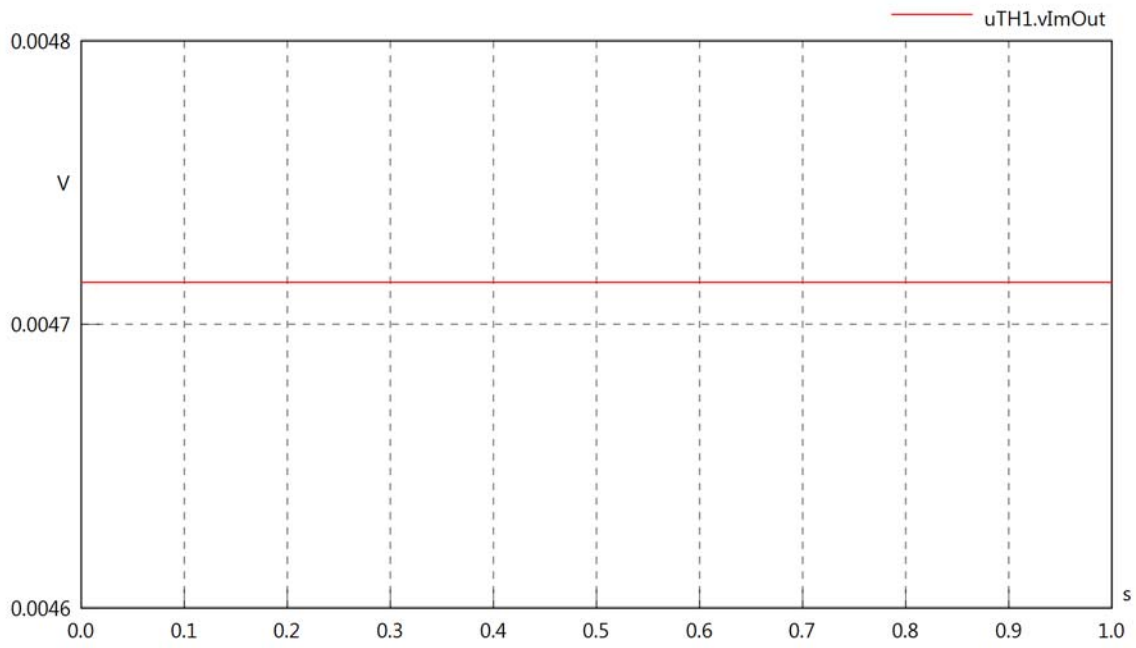

uTH1.Vrms

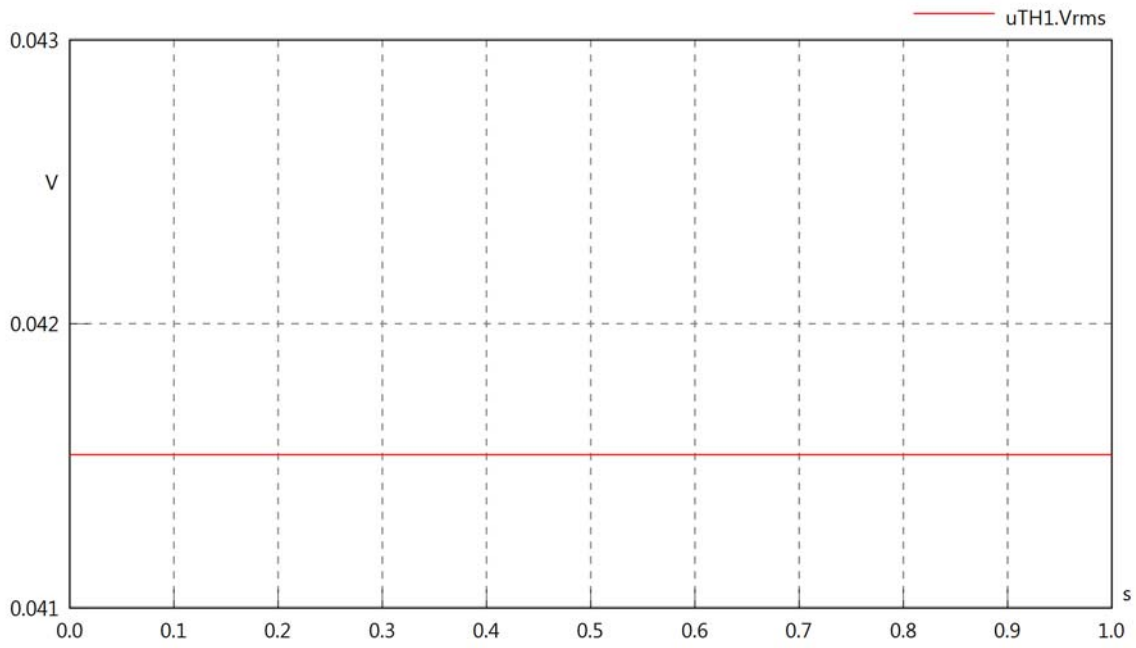

uTH1.vRe

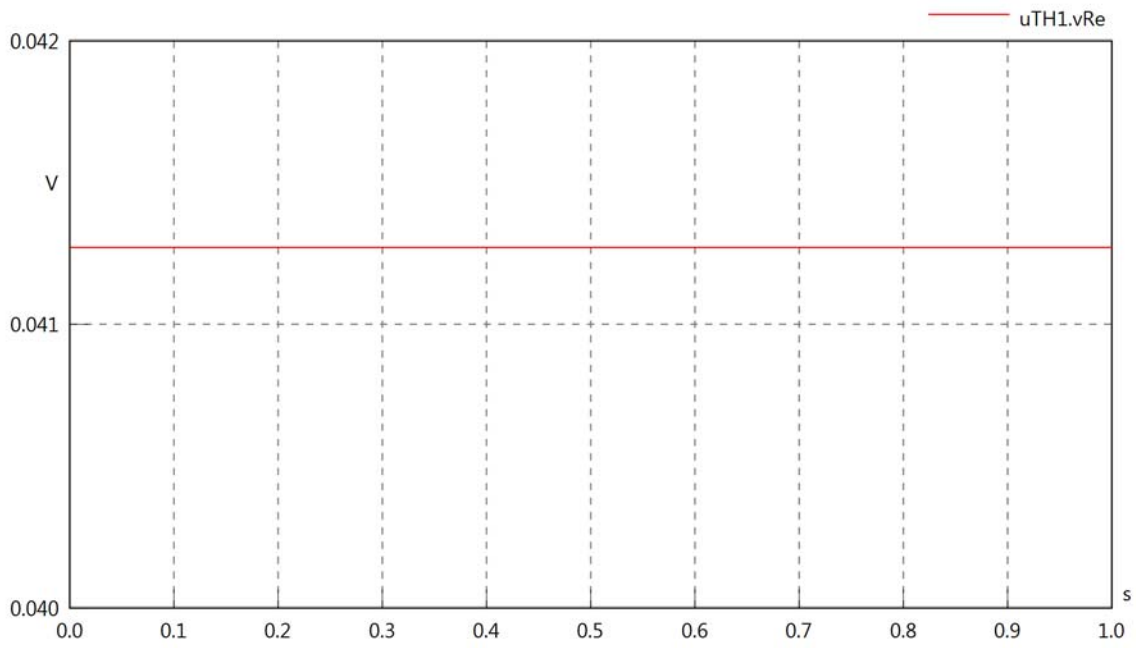

uTH1.vIm

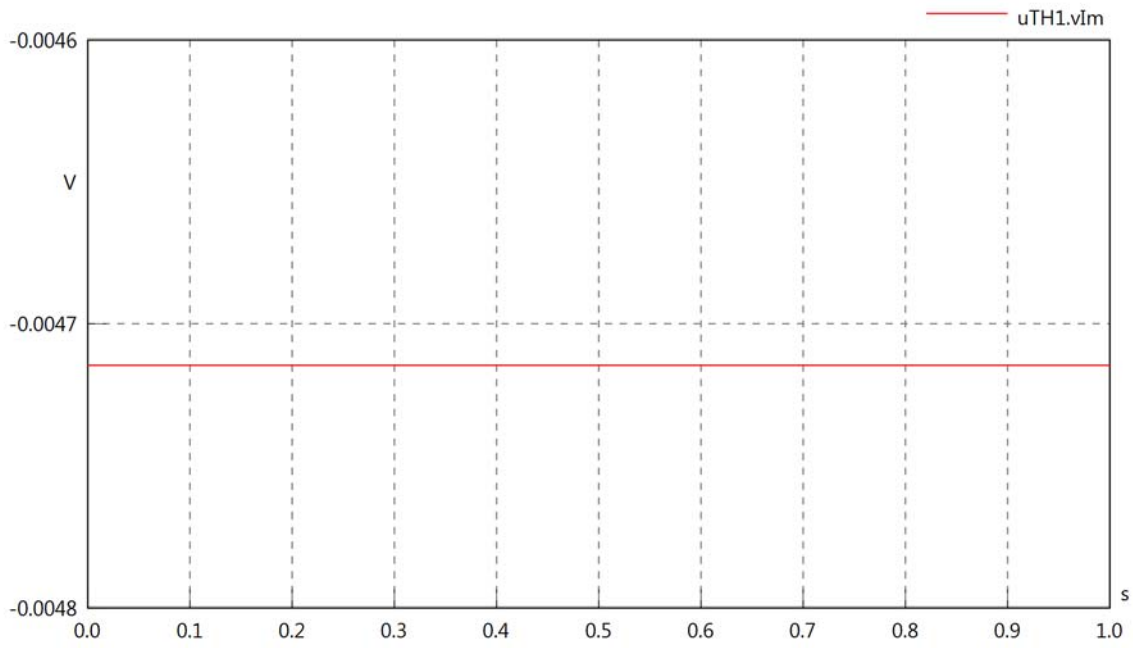

uTH1.IrmsIn

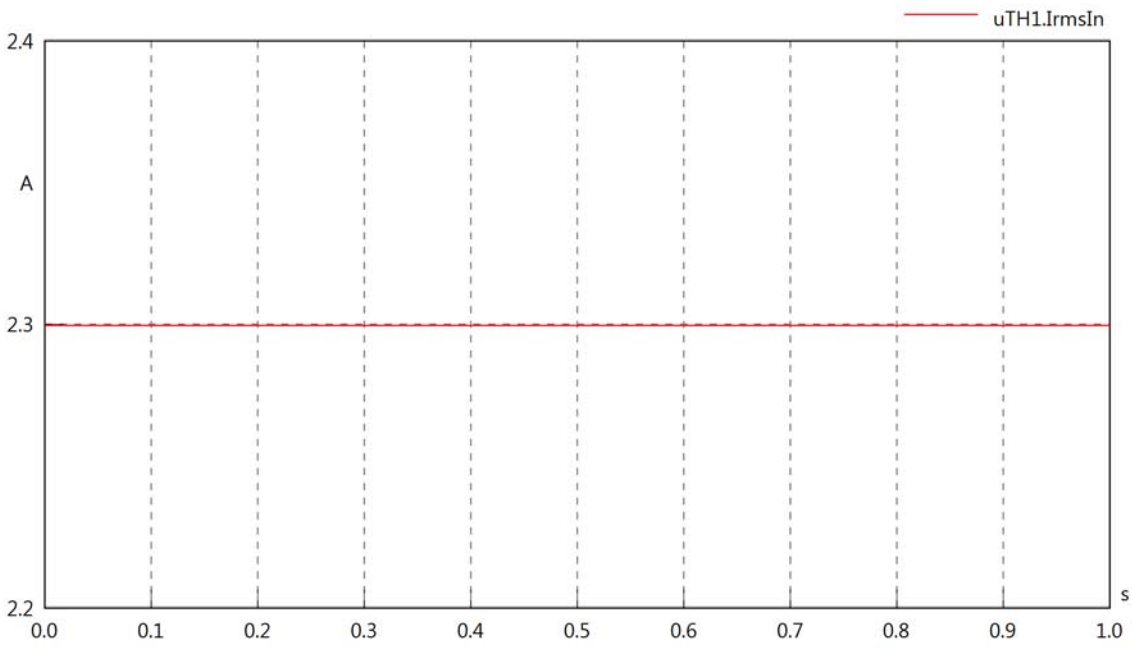

uTH1.iReIn

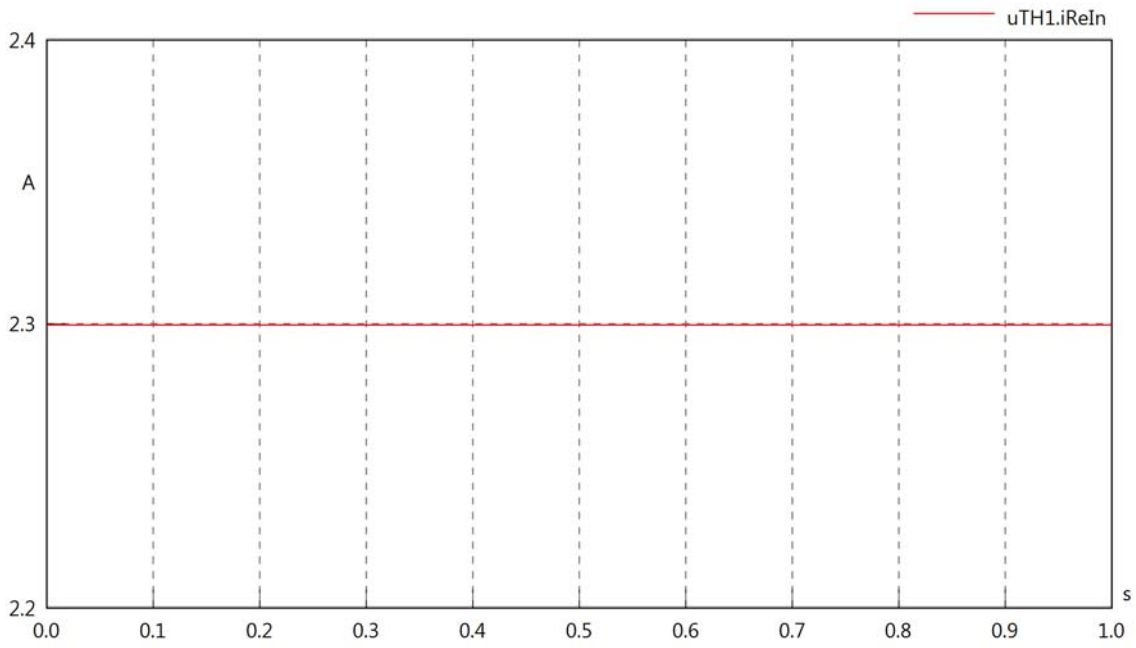

uTH1.iImIn

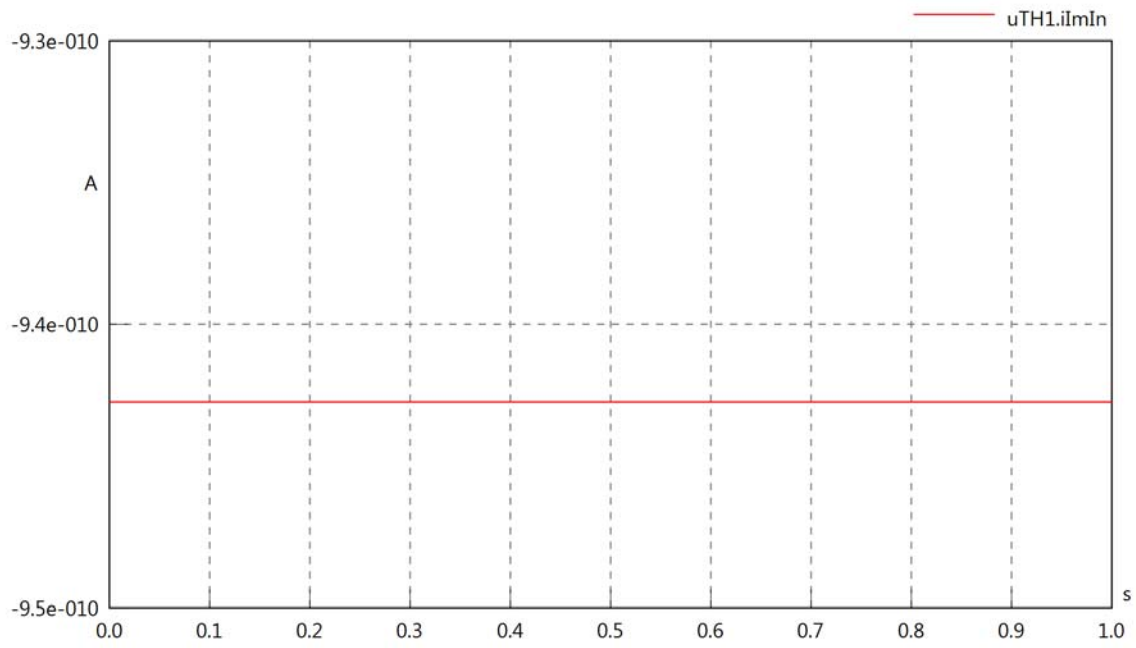

uTH1.IrmsOut

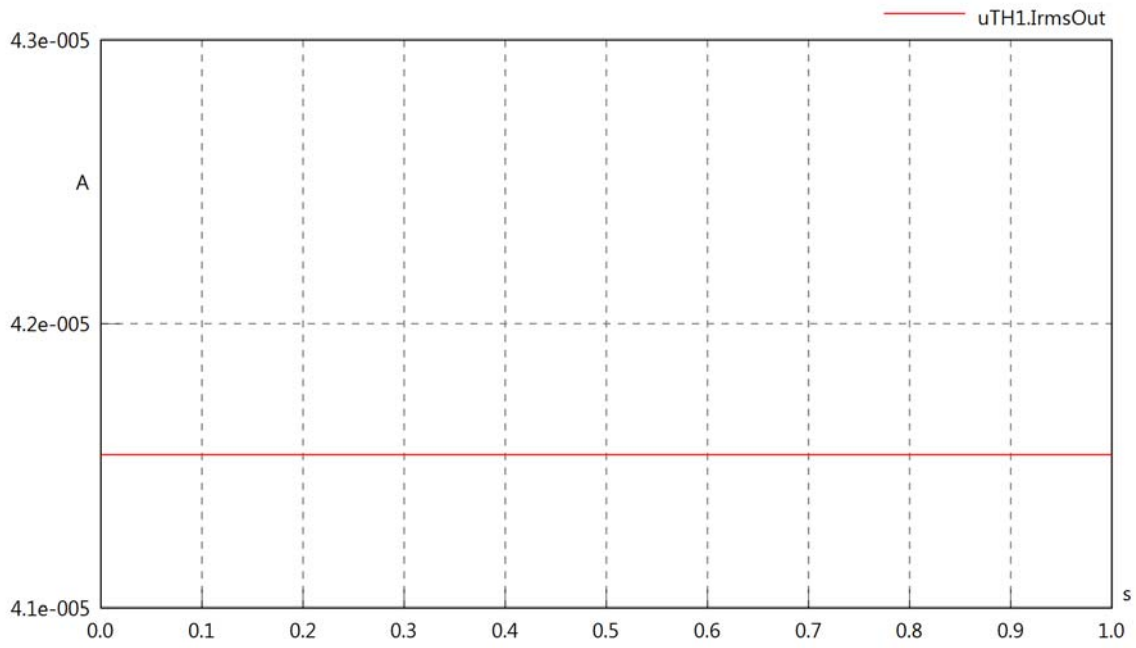

uTH1.iReOut

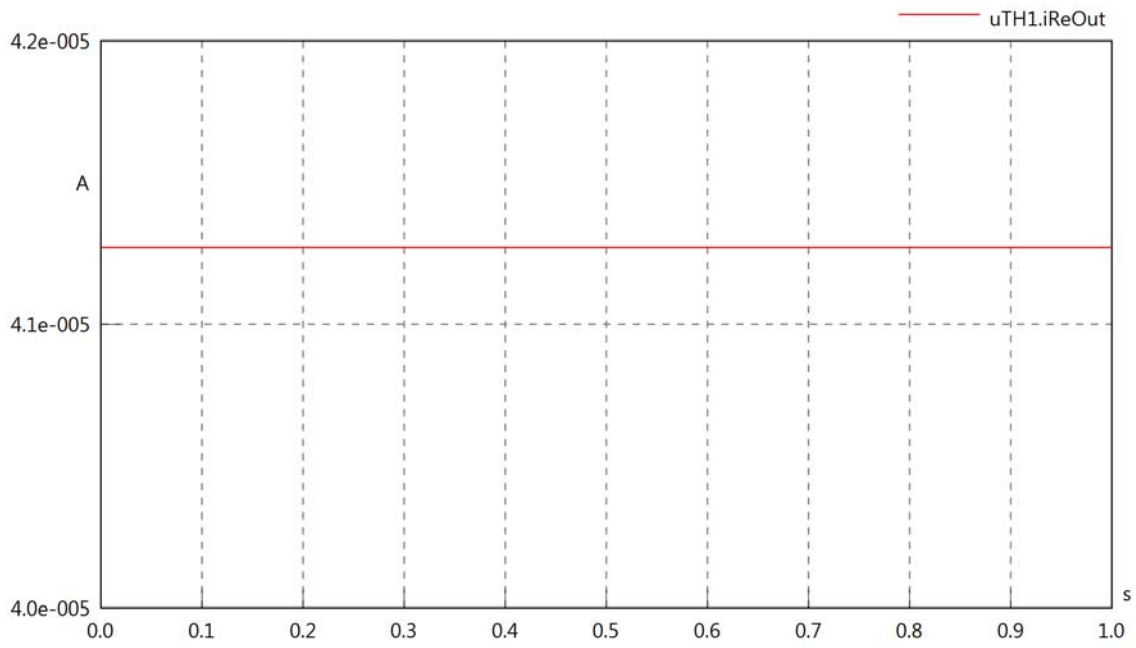

uTH1.iImOut

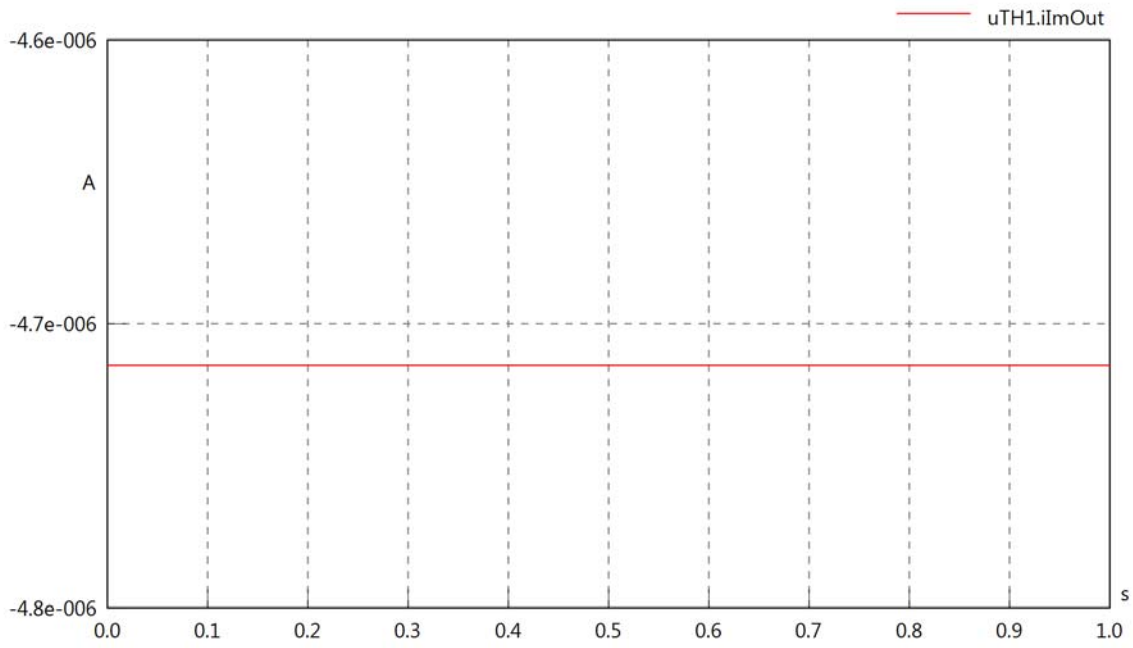

uTH1.phiVIn

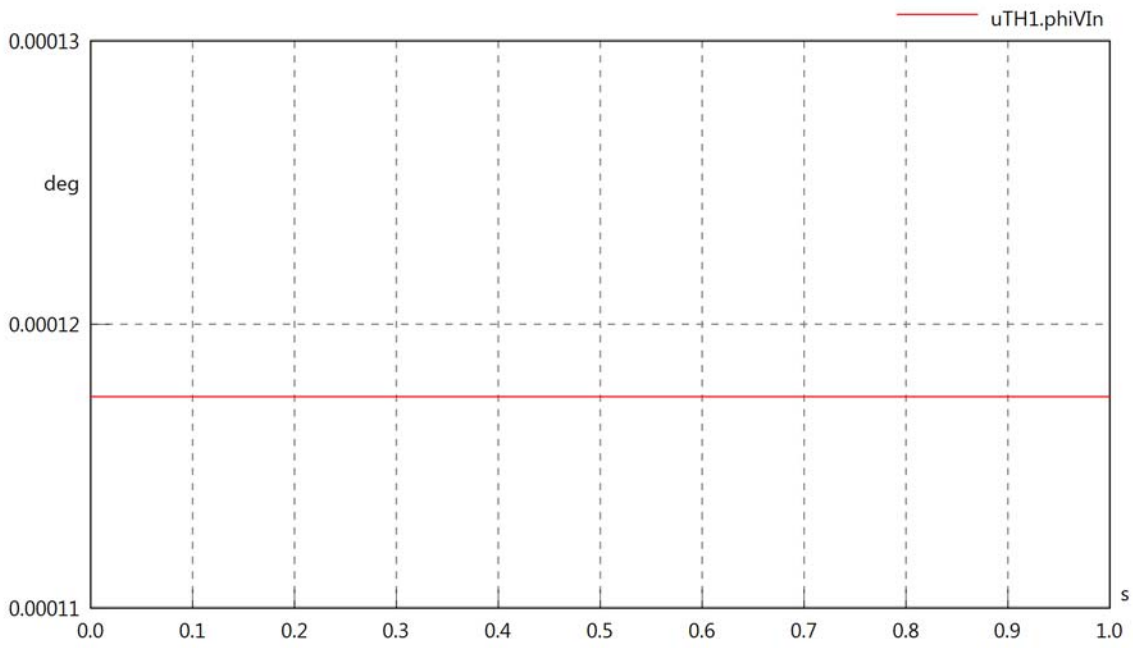

uTH1.philIn

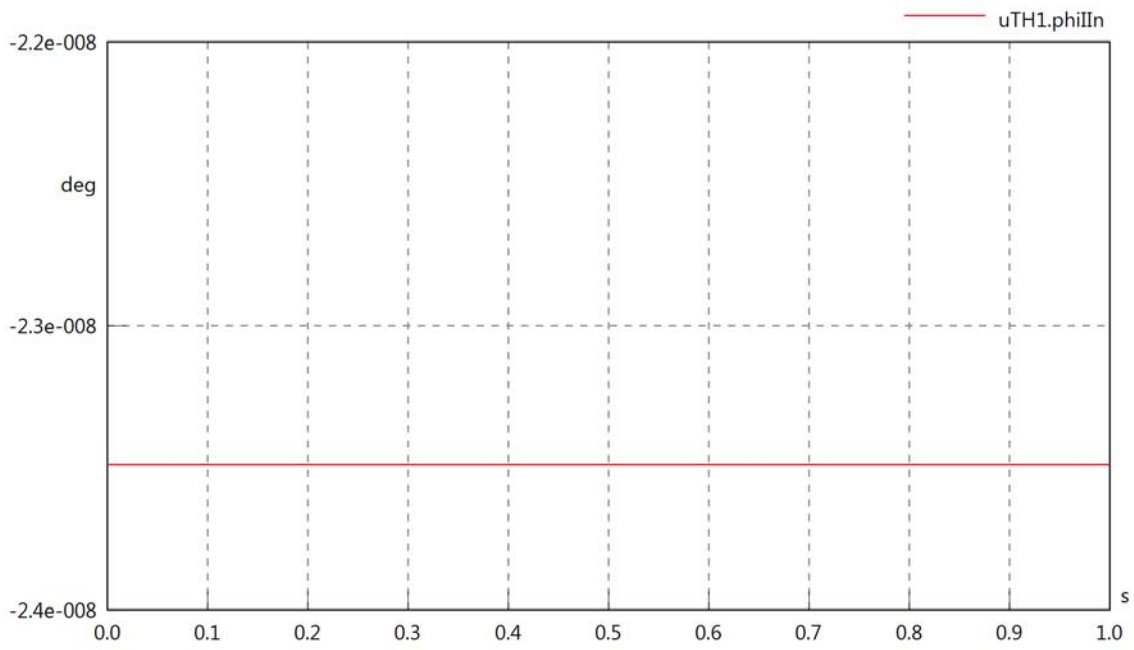

uTH1.philVIn

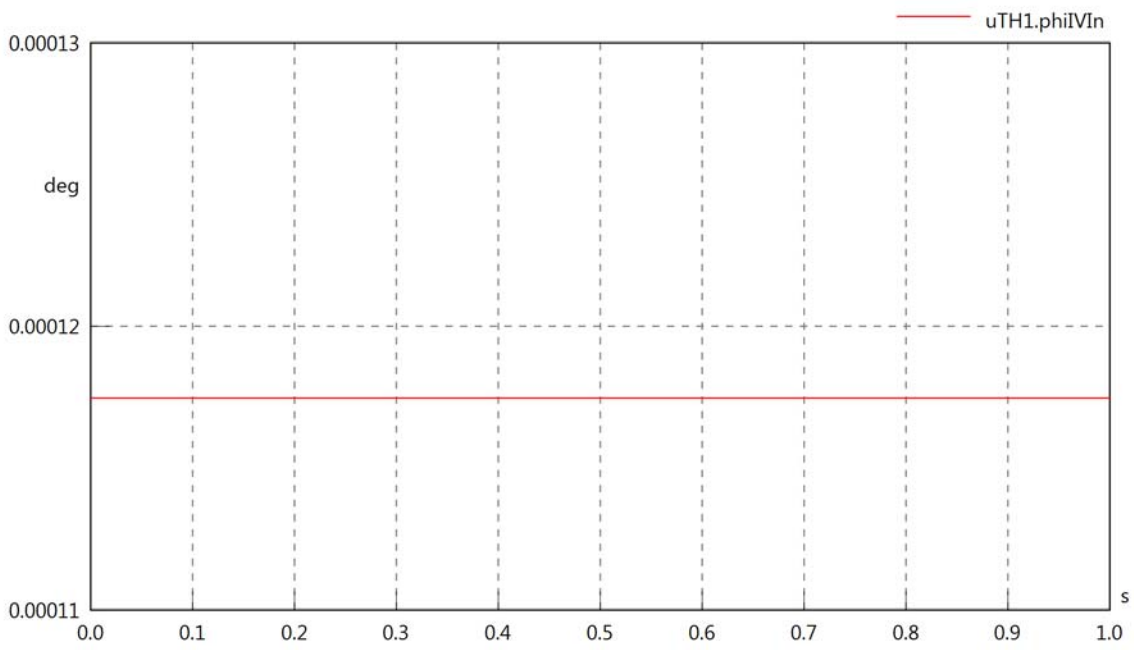

uTH1.phiVOut

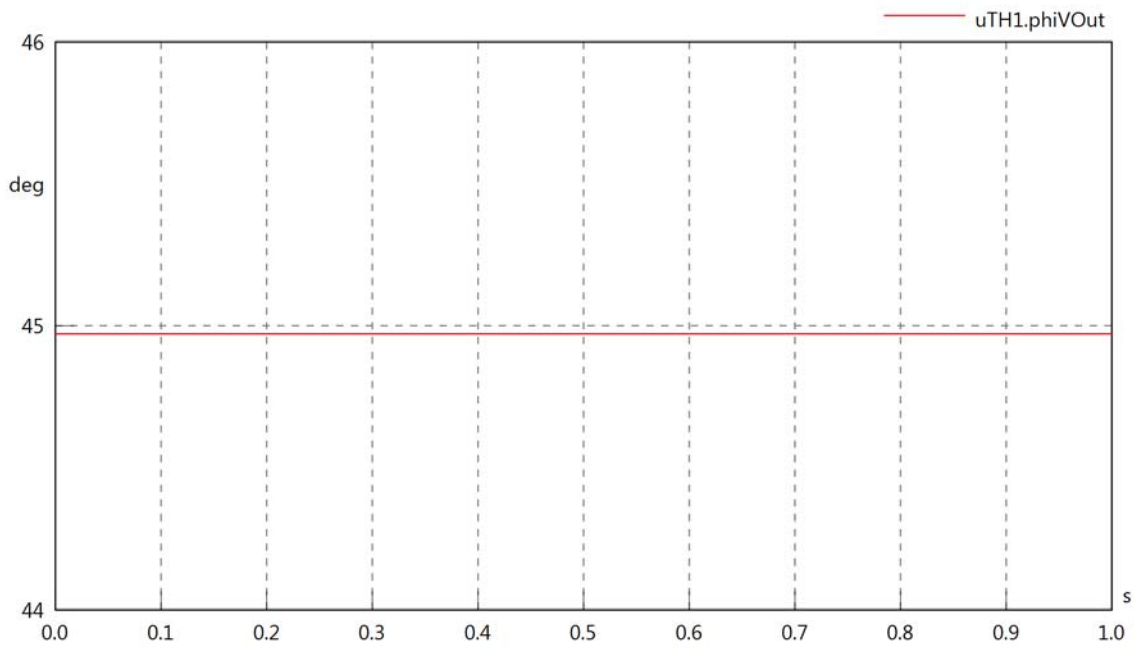

uTH1.philOut

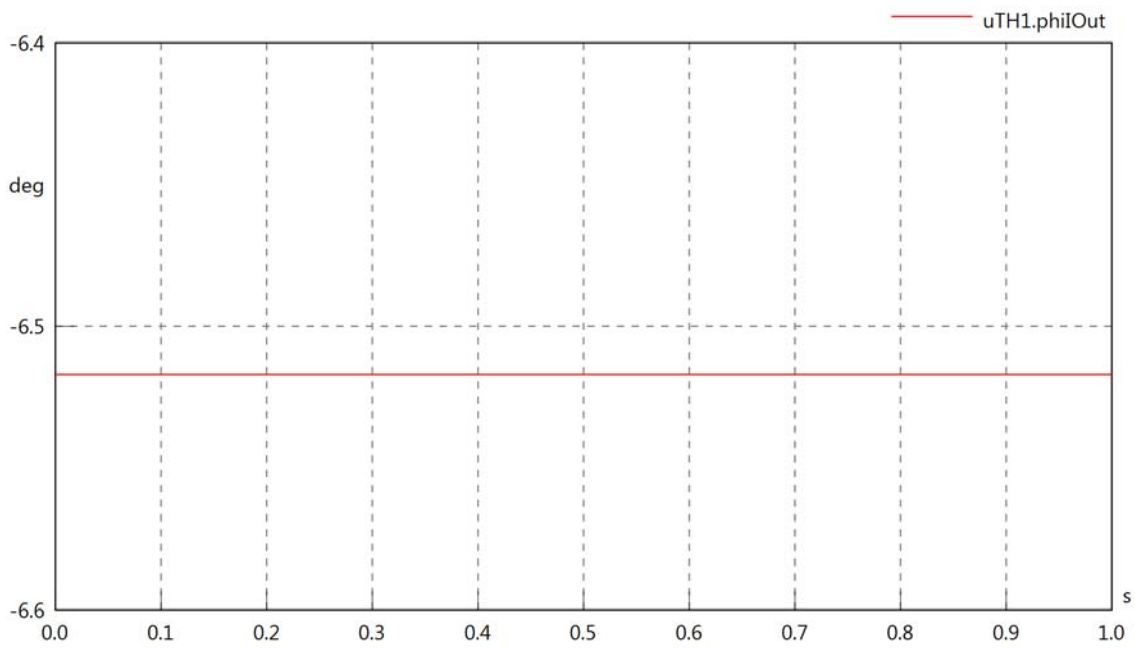

uTH1.philVOut

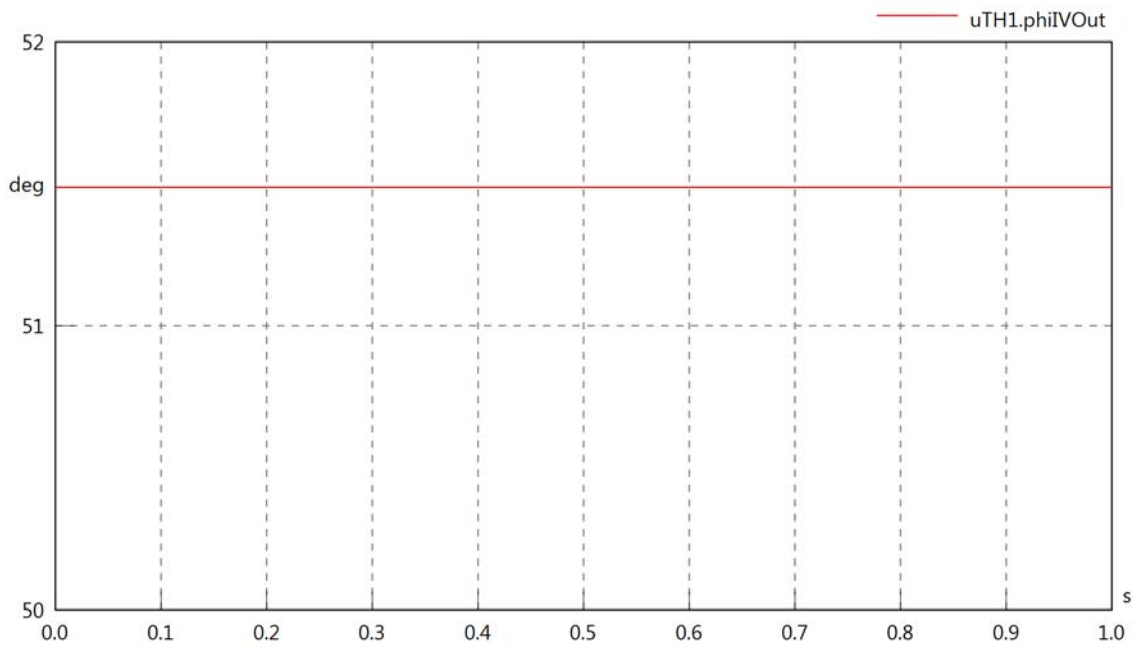

uTH1.PReIn

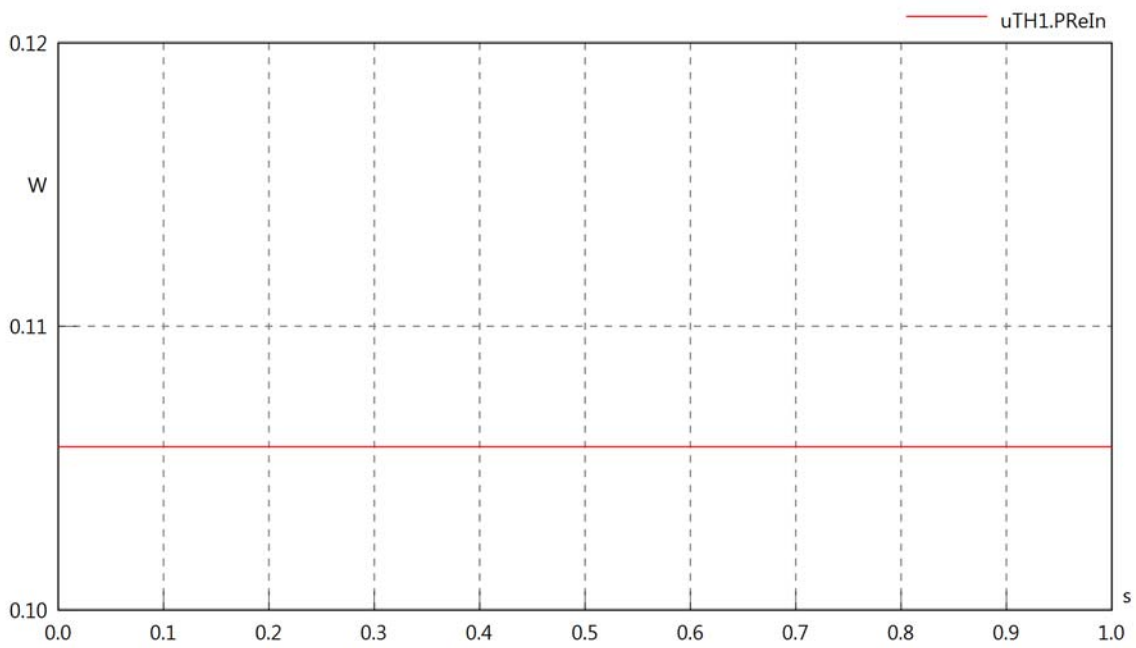

uTH1.PImIn

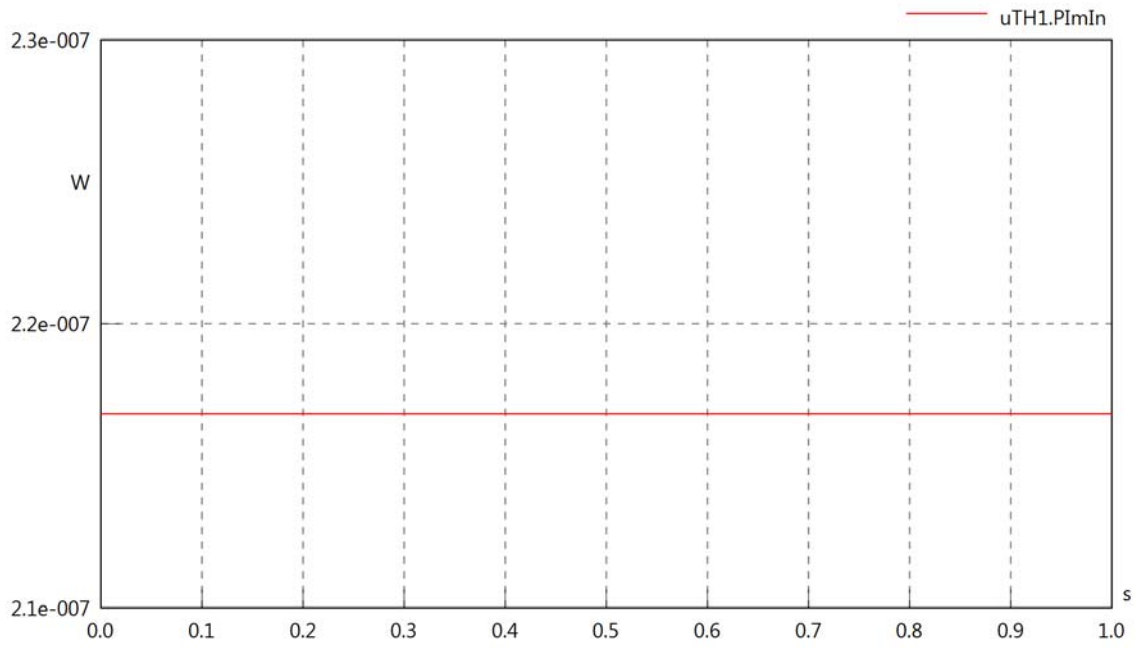

uTH1.SIn

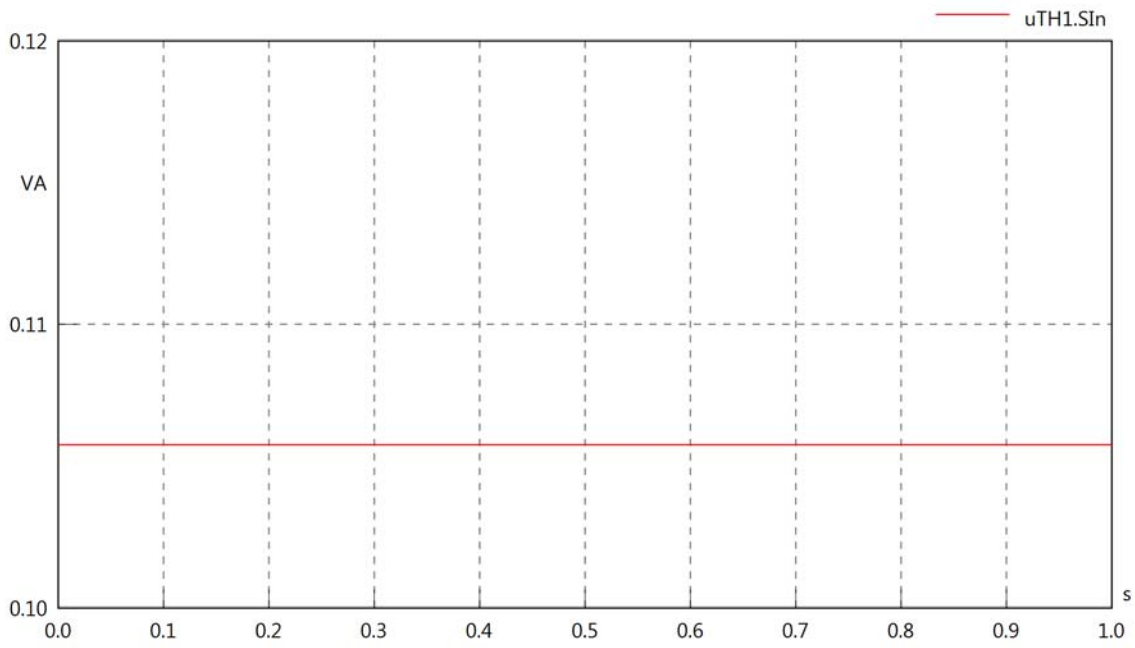

uTH1.PReOut

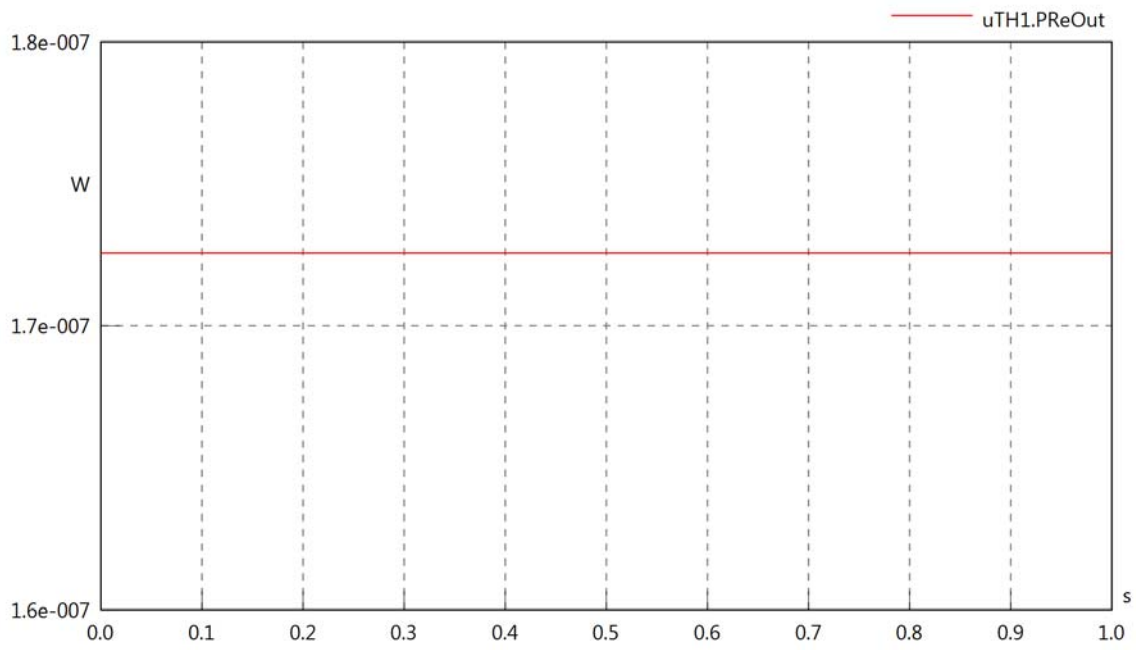

uTH1.PImOut

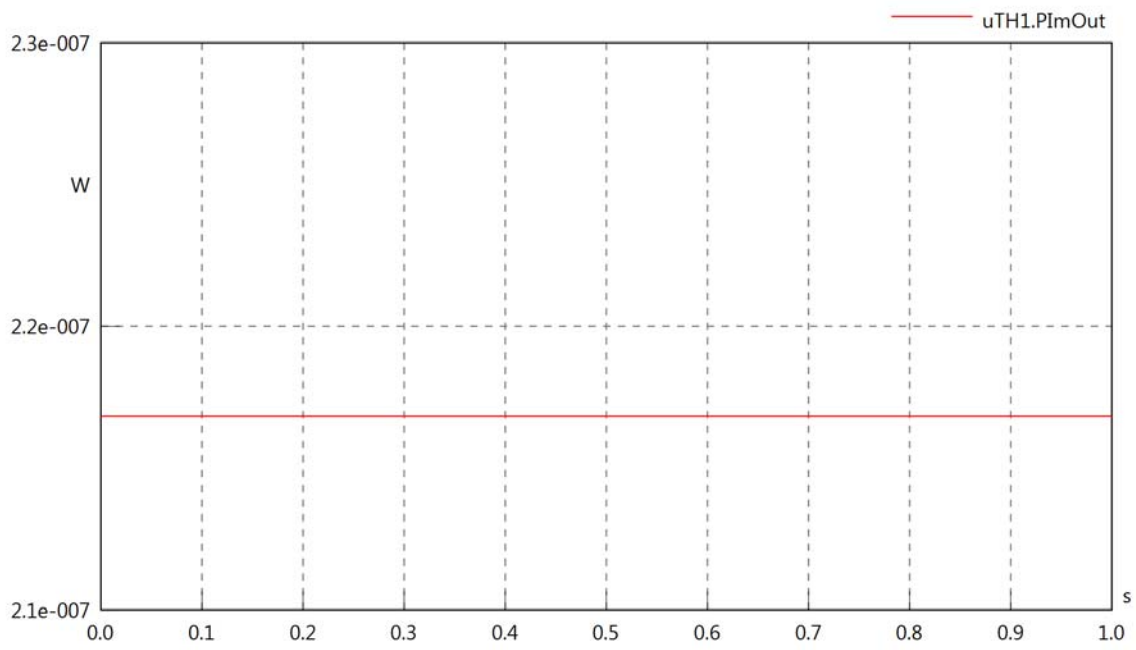

uTH1.SOut

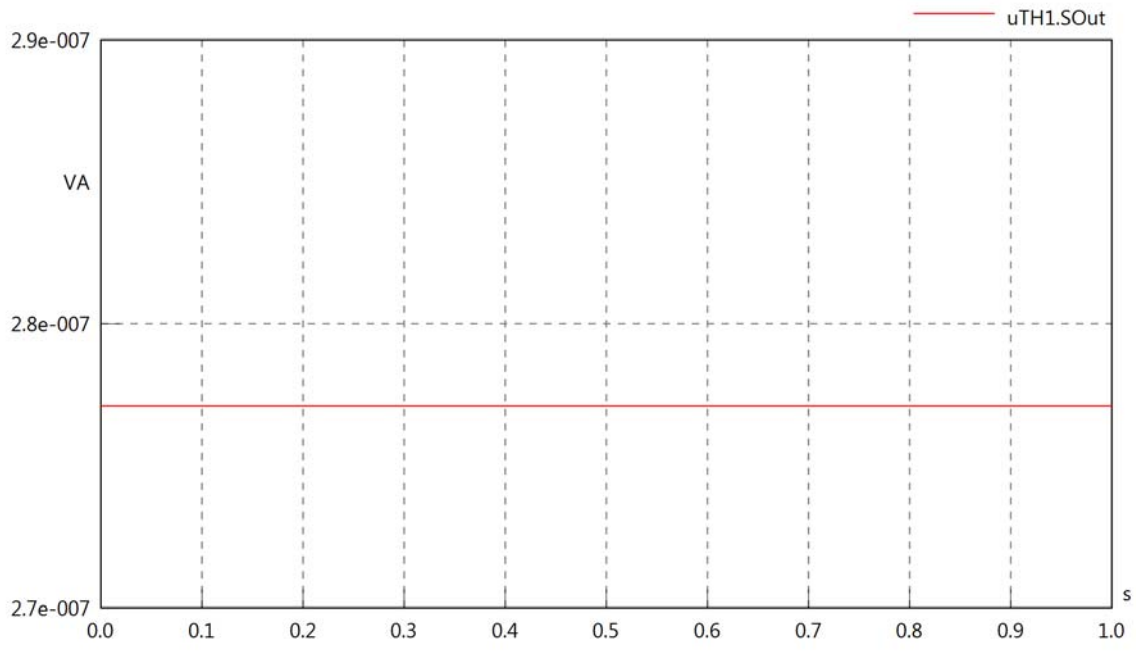
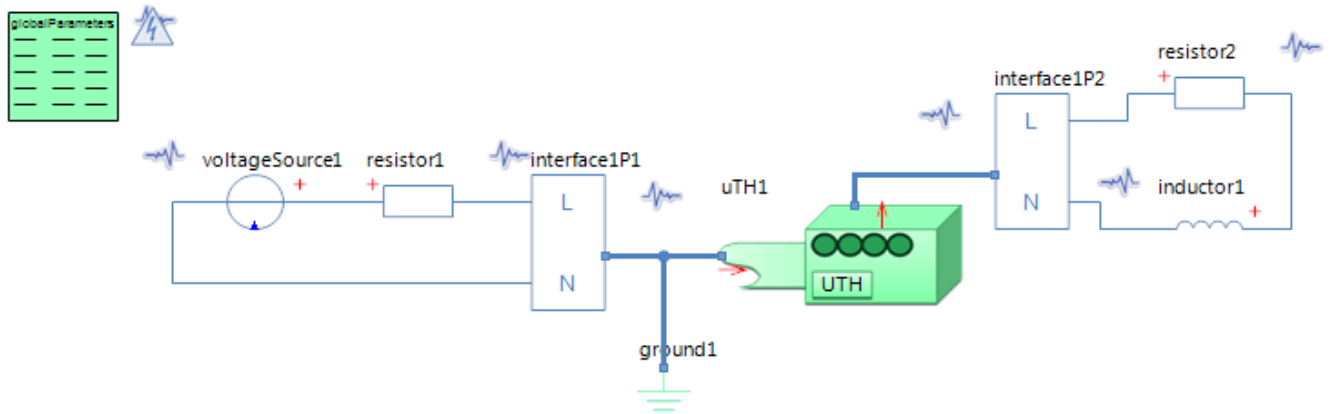

Diagram View



GlobalParameters globalParameters
Parameters

Comment	Name	Current Value	Unit
Type of Calculation	eCalculationKind	Signal Calculation	
Description of Frequency	eFrequencyKind	Linear	
Minimum Frequency	fMin	20000	[Hz]
Maximum Frequency	fMax	20000	[Hz]

Voltage Source voltageSource1
Parameters

Comment	Name	Current Value	Unit
Voltage RMS	VrmsSrc	230	[V]
Phase	phi	0	[deg]

Resistor resistor1
Parameters

Comment	Name	Current Value	Unit
Resistance	R	100	[Ohm]

Resistor resistor2
Parameters

Comment	Name	Current Value	Unit
Resistance	R	100	[Ohm]

Inductor inductor1
Parameters

Comment	Name	Current Value	Unit
Inductance	L	5	[mH]

Umbilical Termination Head uTH1
Parameters

Comment	Name	Current Value	Unit
Poor or failing L1 connection	bL1	true	
Resistance in L1 connection	rL1	1	[kOhm]
Conductance between L1 and N	G	50	[1/Ohm]

uTH1.VrmsIn

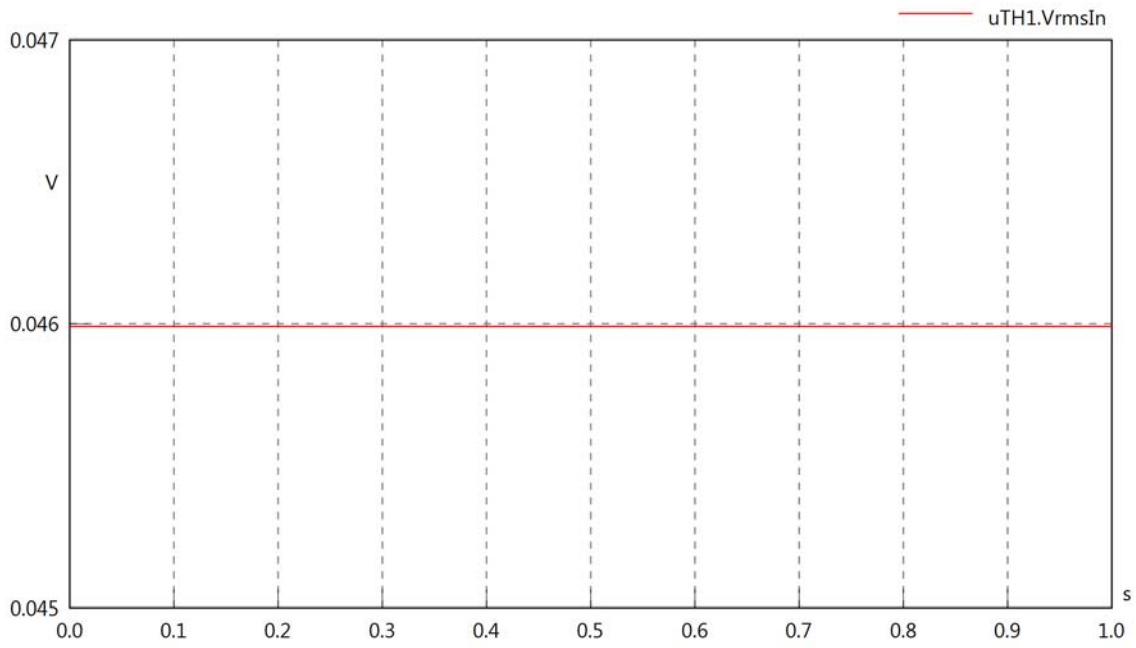

uTH1.vReIn

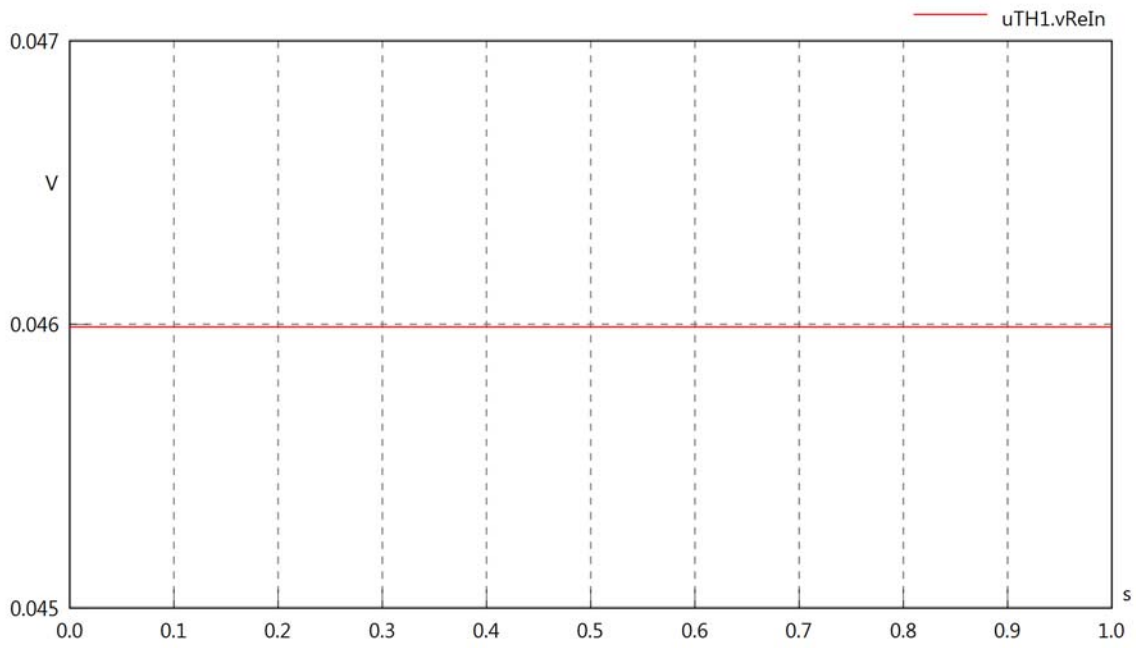

uTH1.vImIn

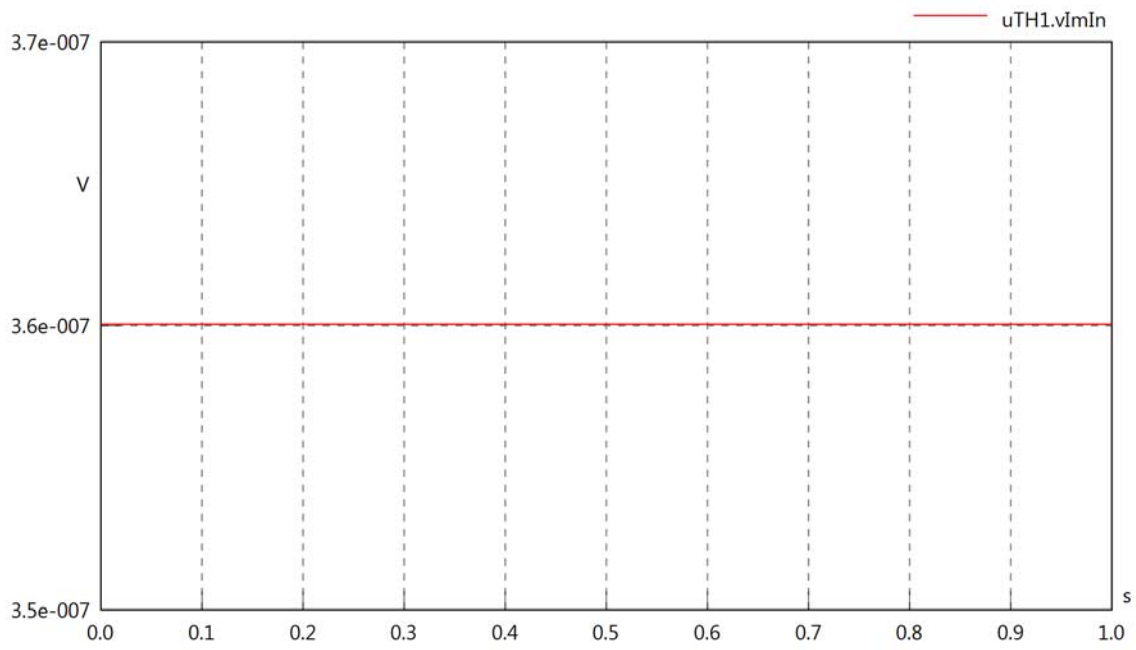

uTH1.VrmsOut

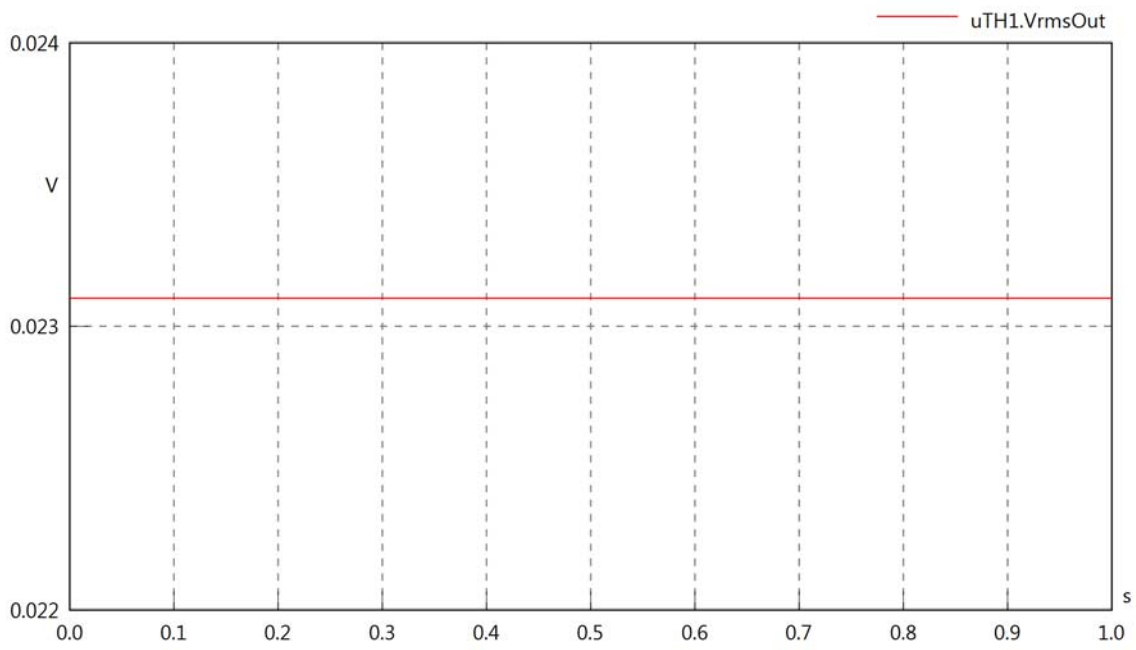

uTH1.vReOut

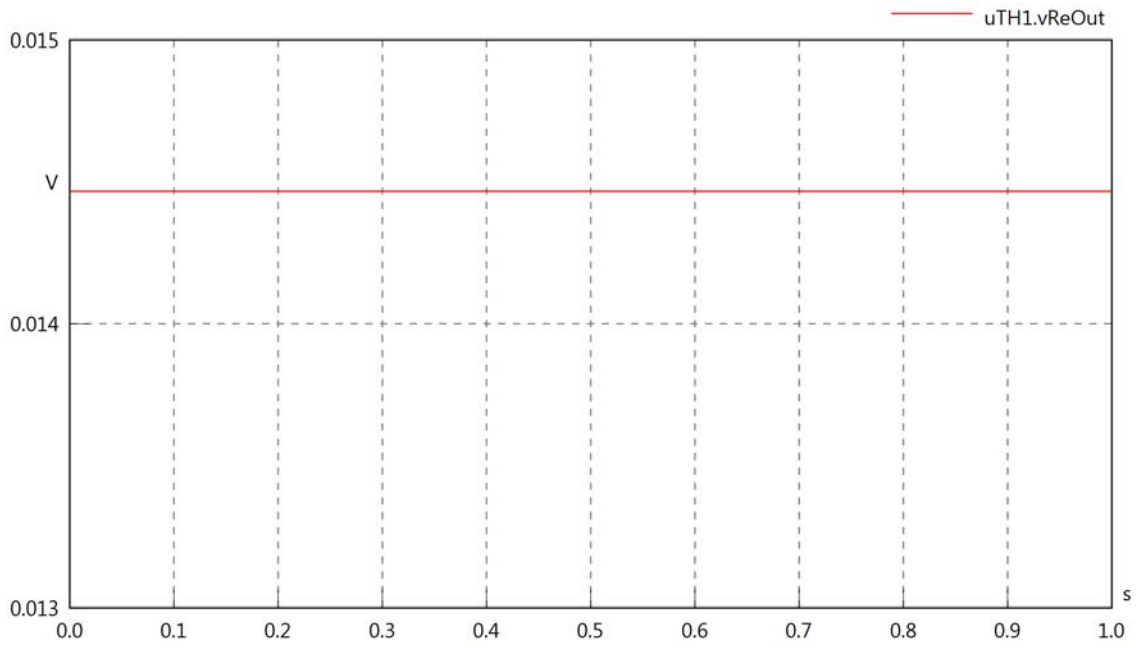

uTH1.vImOut

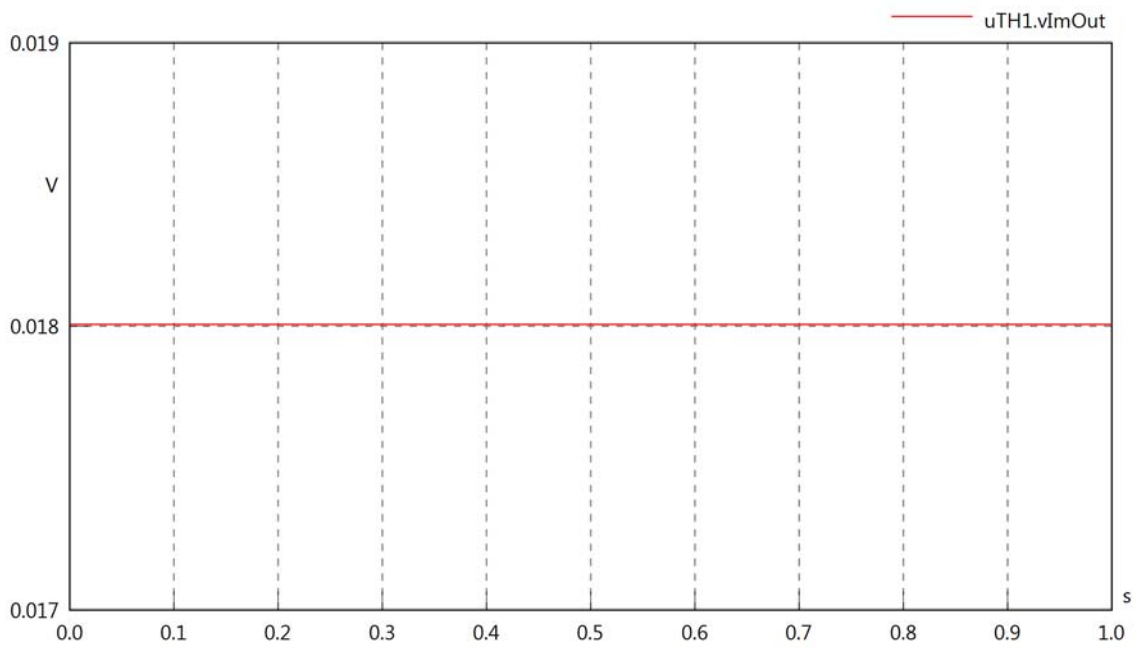

uTH1.Vrms

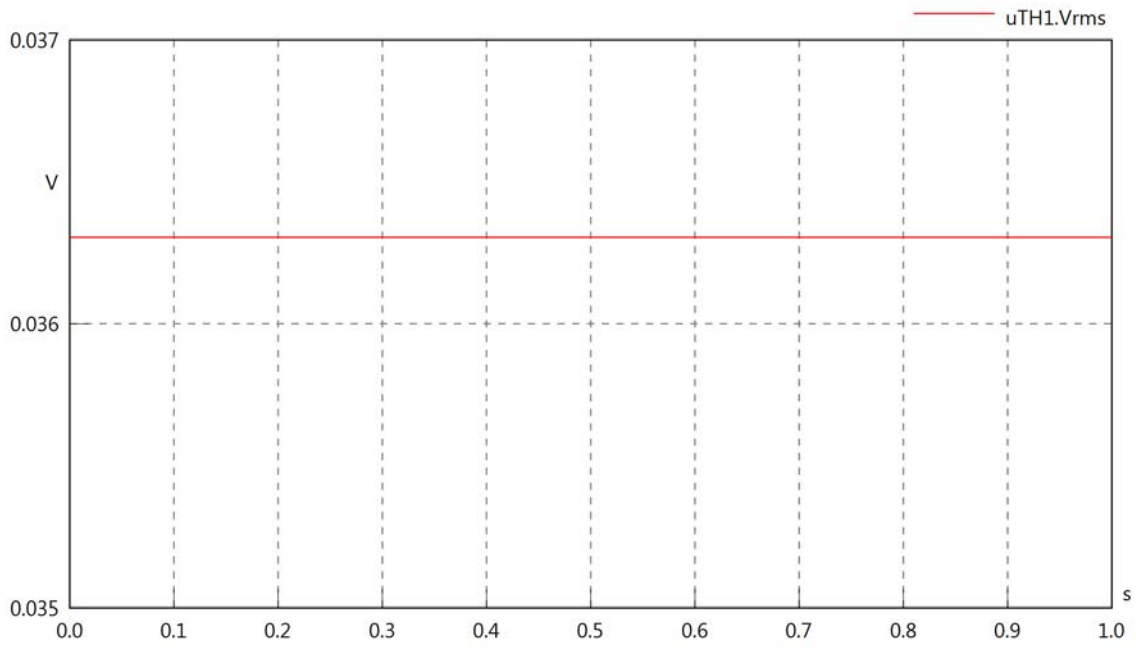

uTH1.vRe

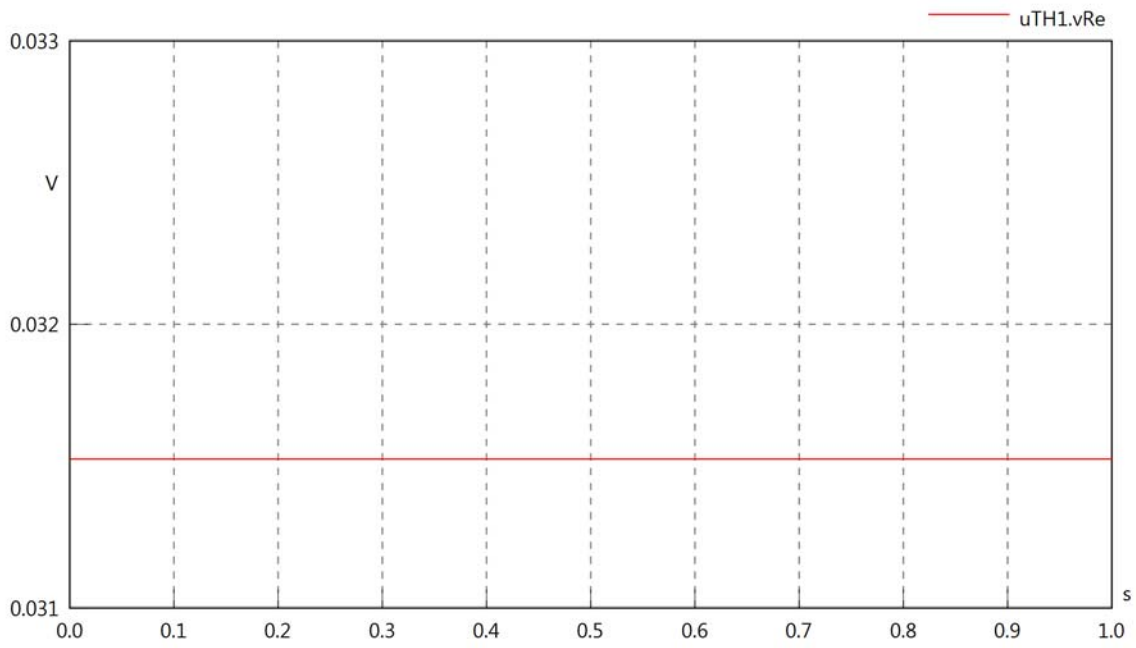

uTH1.vIm

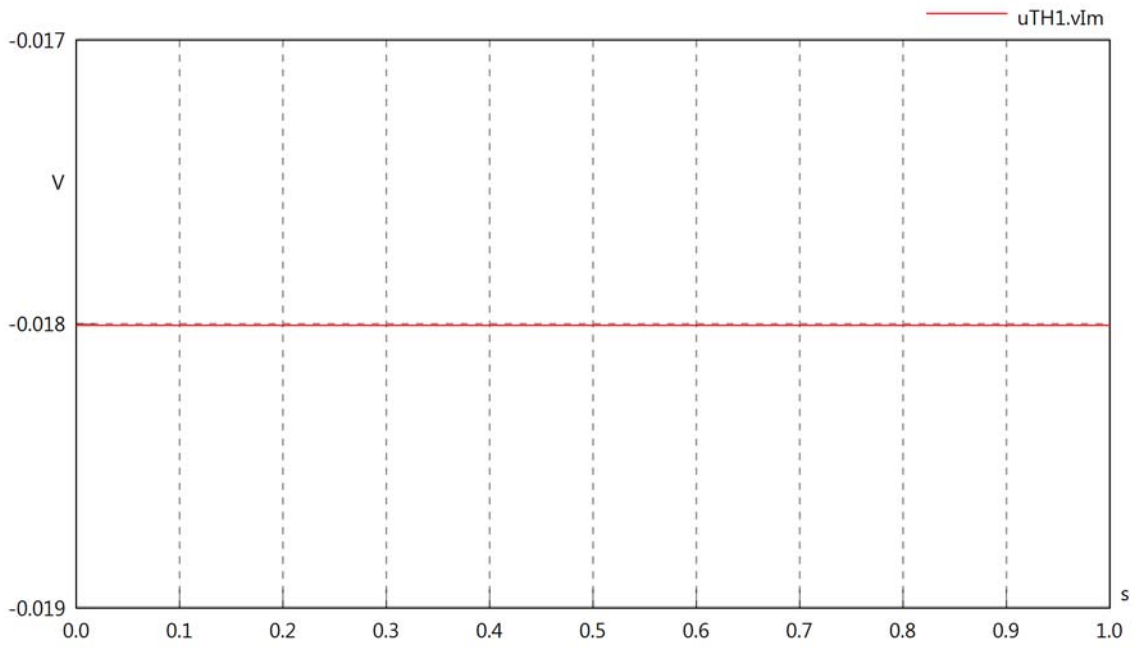

uTH1.IrmsIn

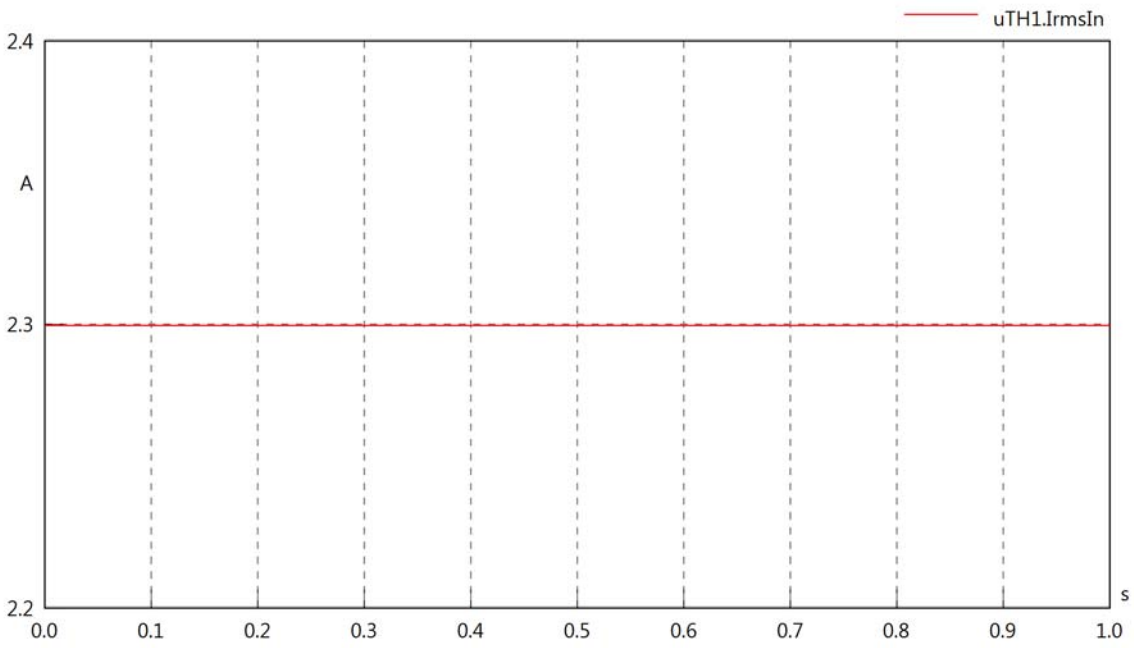

uTH1.iReIn

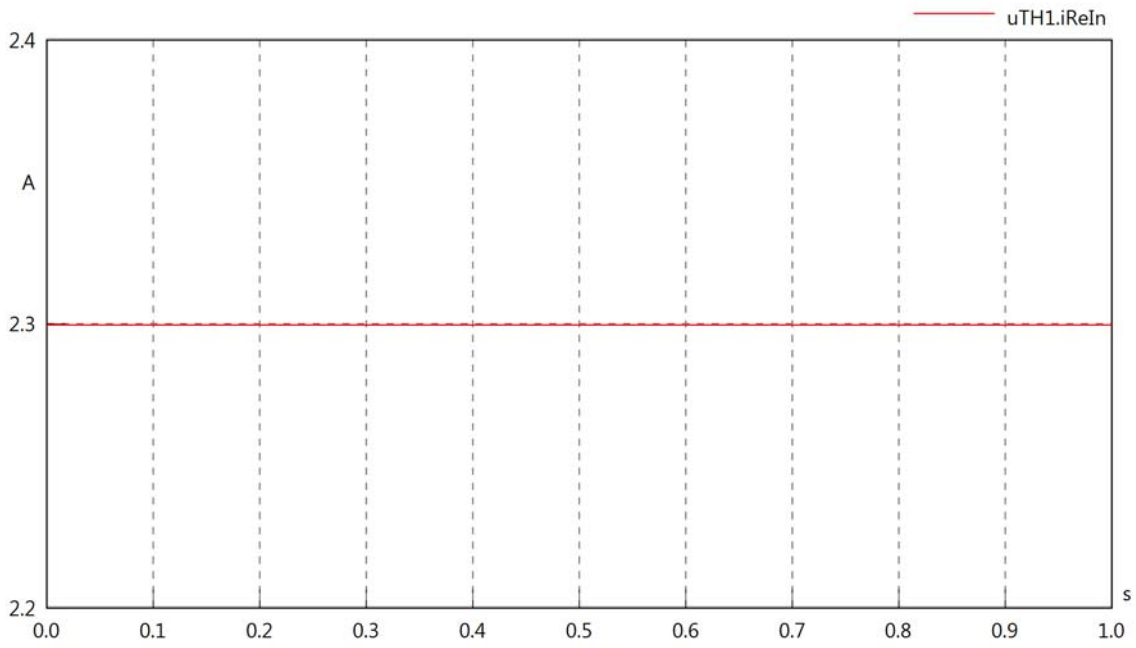

uTH1.iImIn

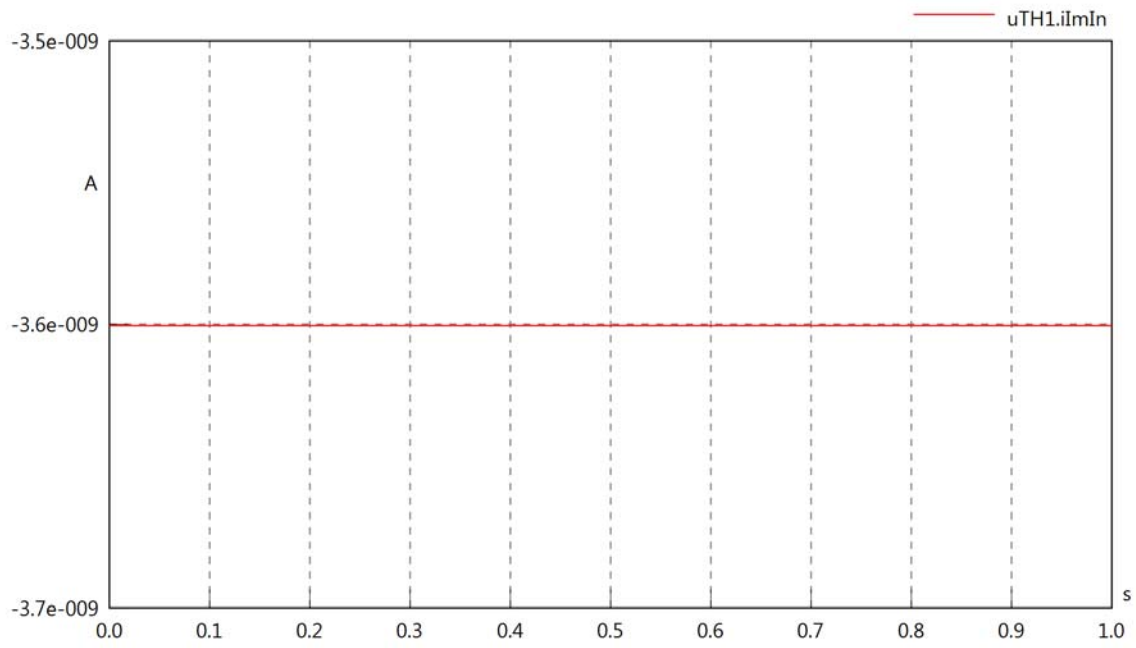

uTH1.IrmsOut

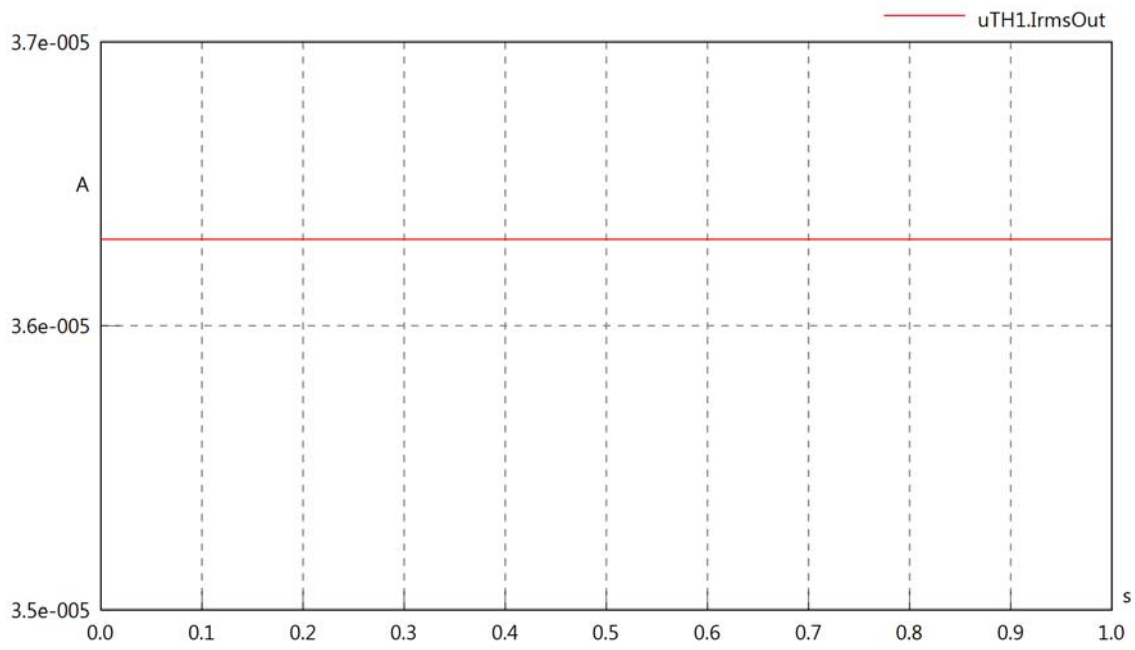

uTH1.iReOut

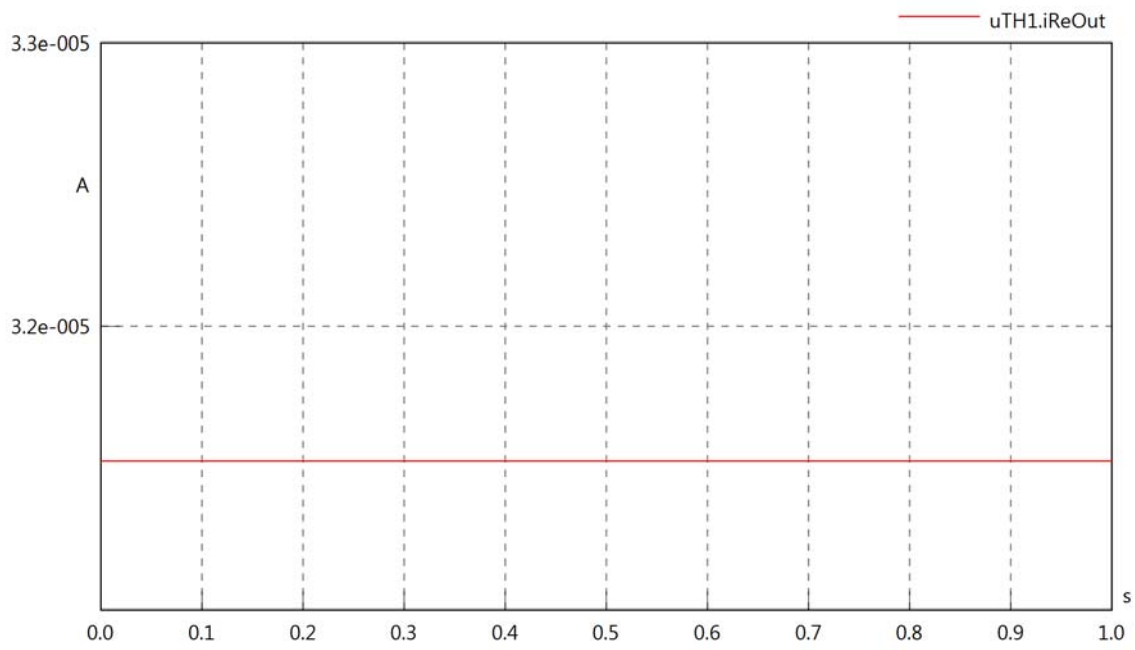

uTH1.iImOut

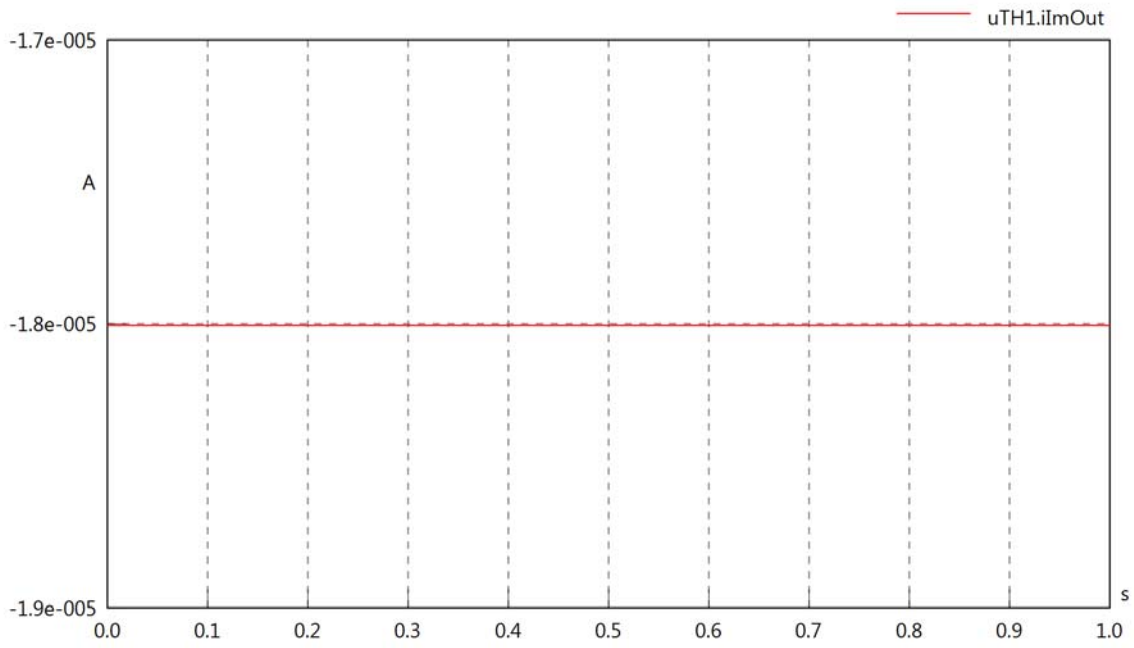

uTH1.phiVIn

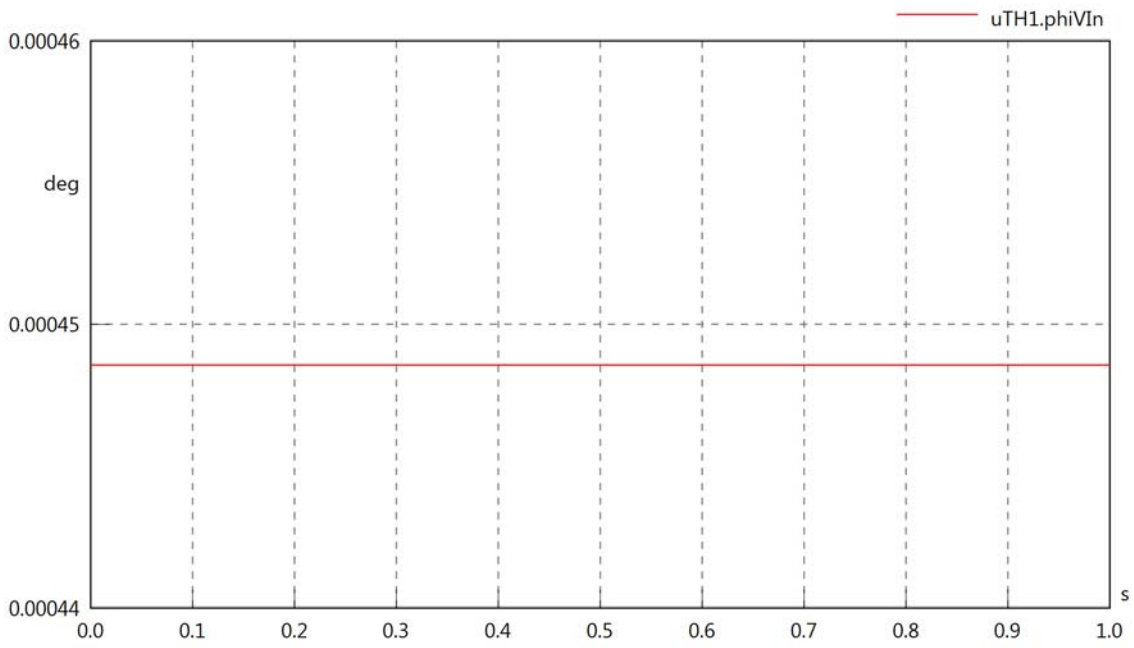

uTH1.philIn

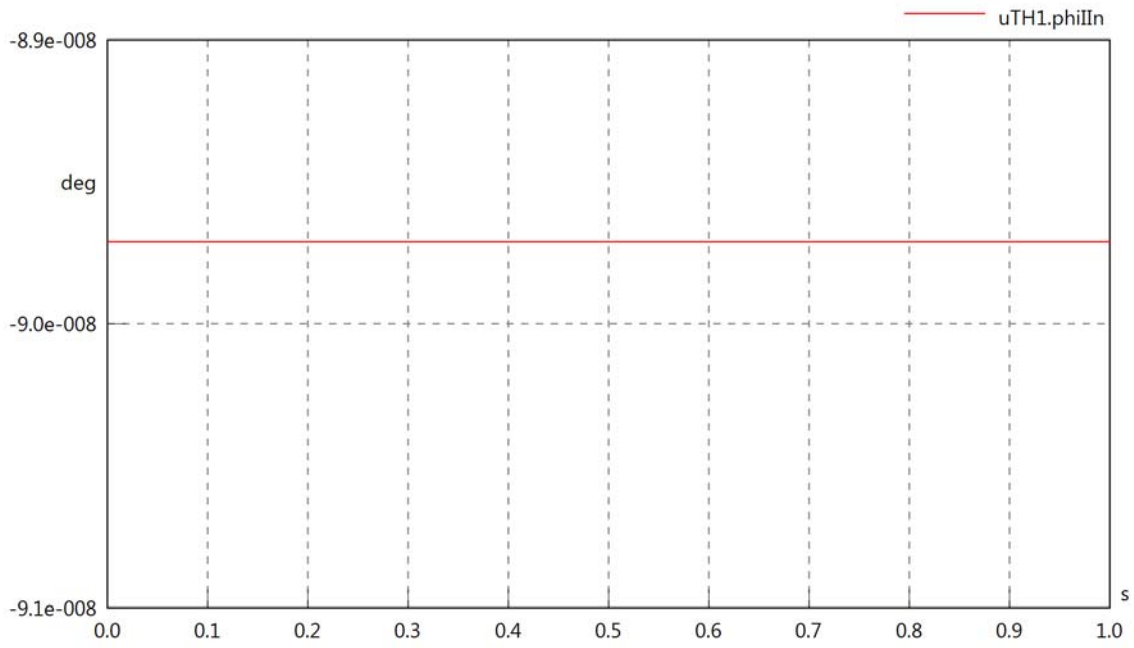

uTH1.philVIn

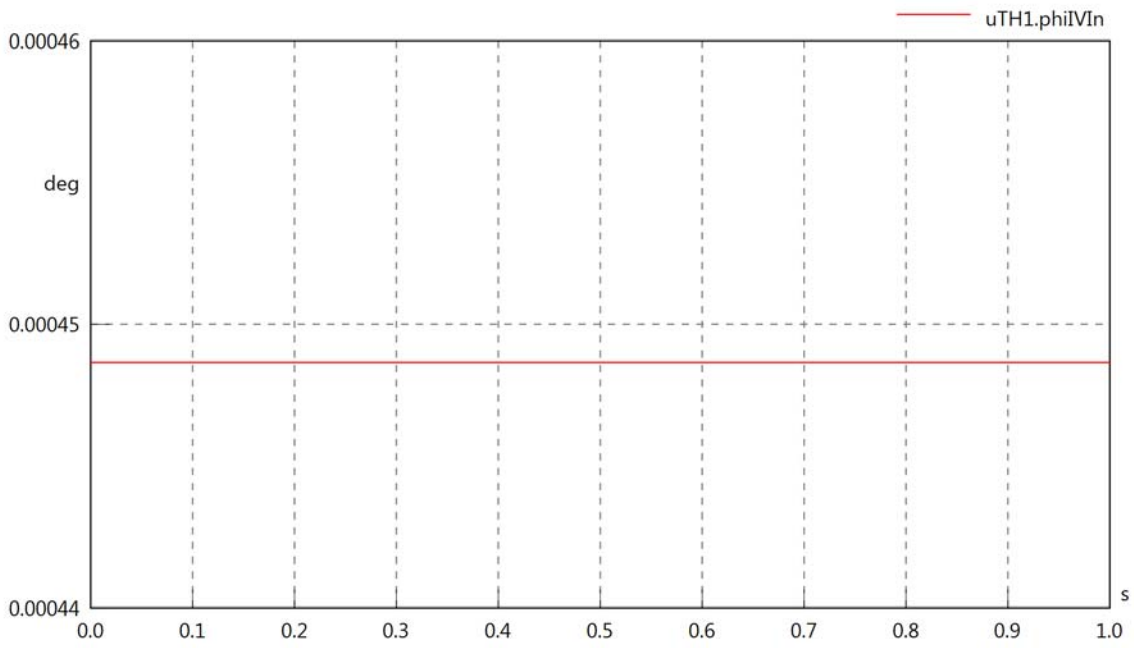

uTH1.phiVOut

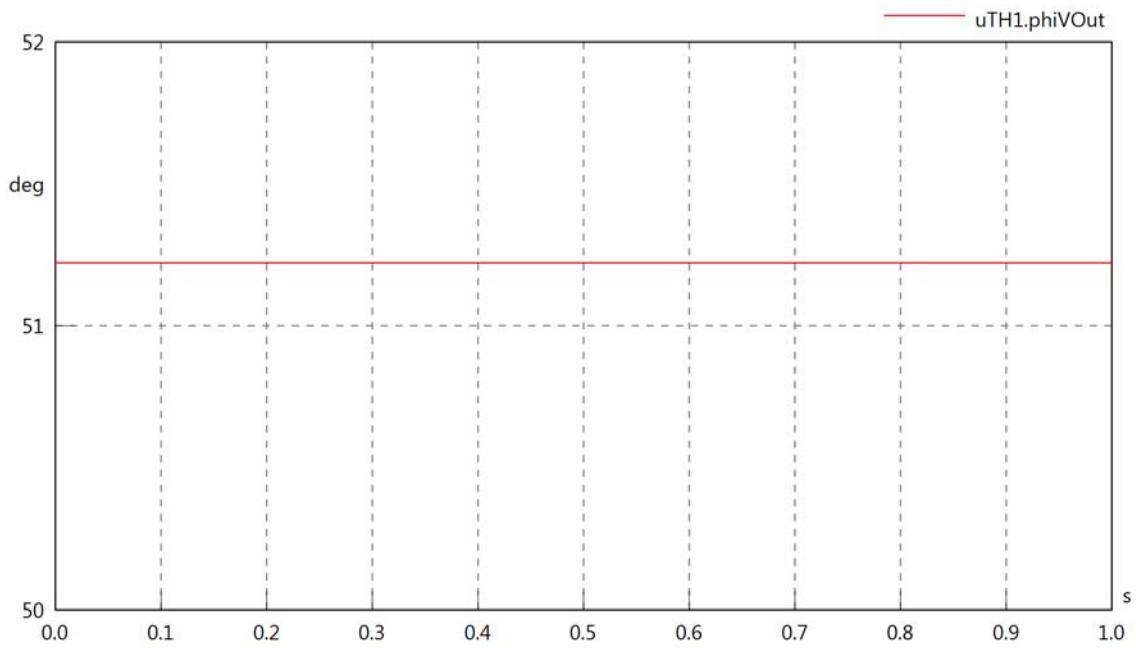

uTH1.philOut

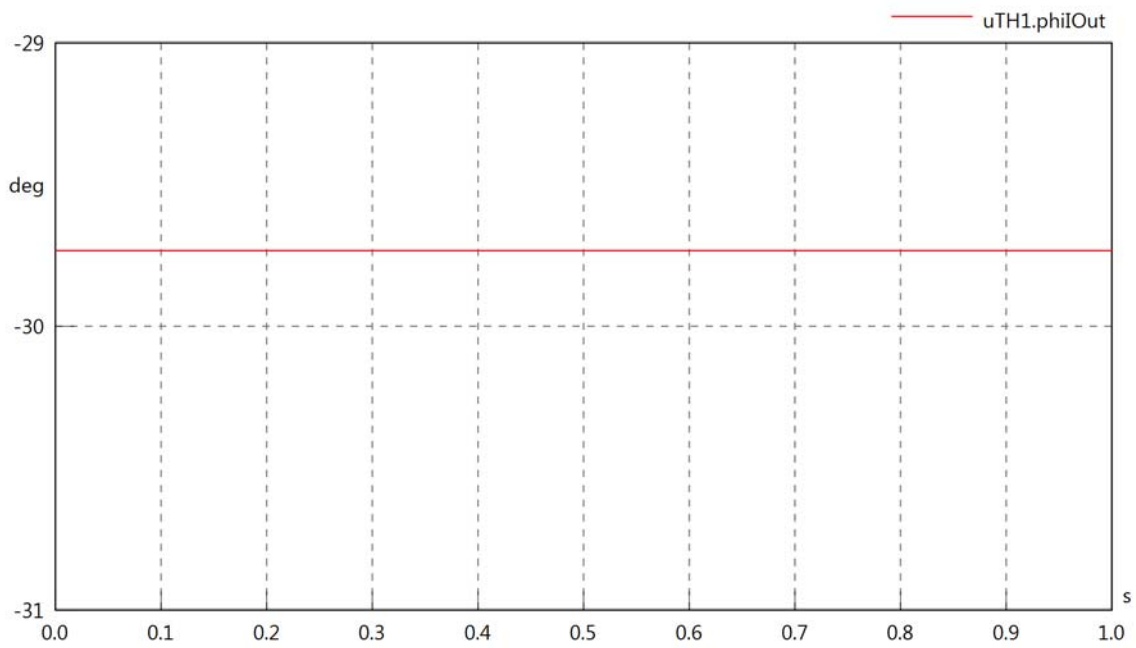

uTH1.philVOut

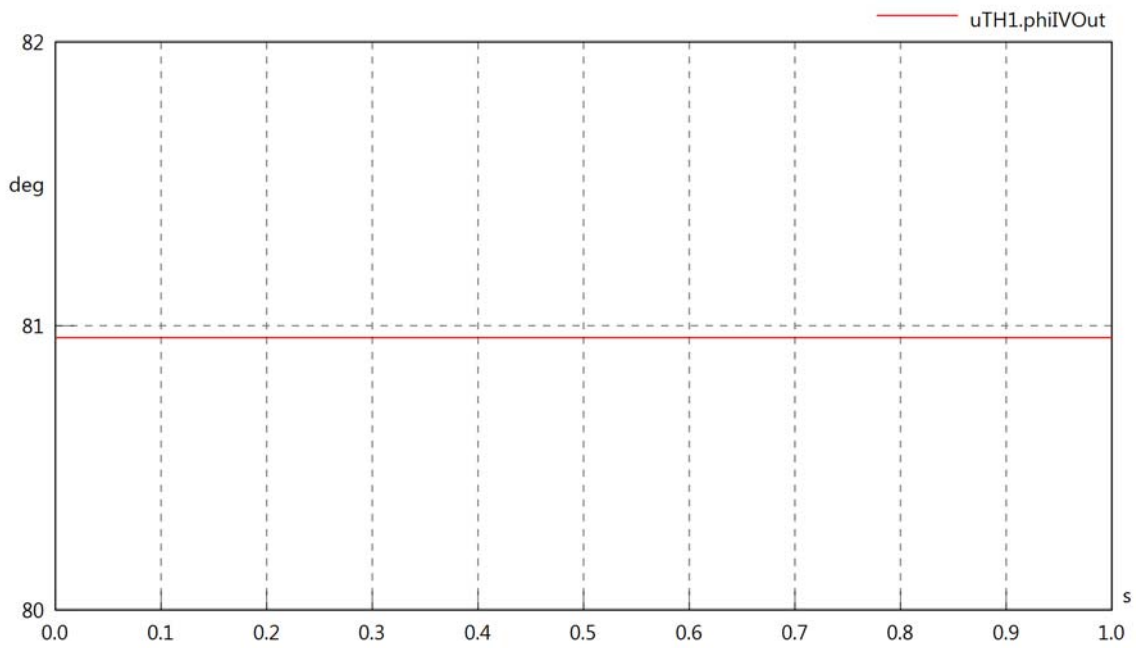

uTH1.PReIn

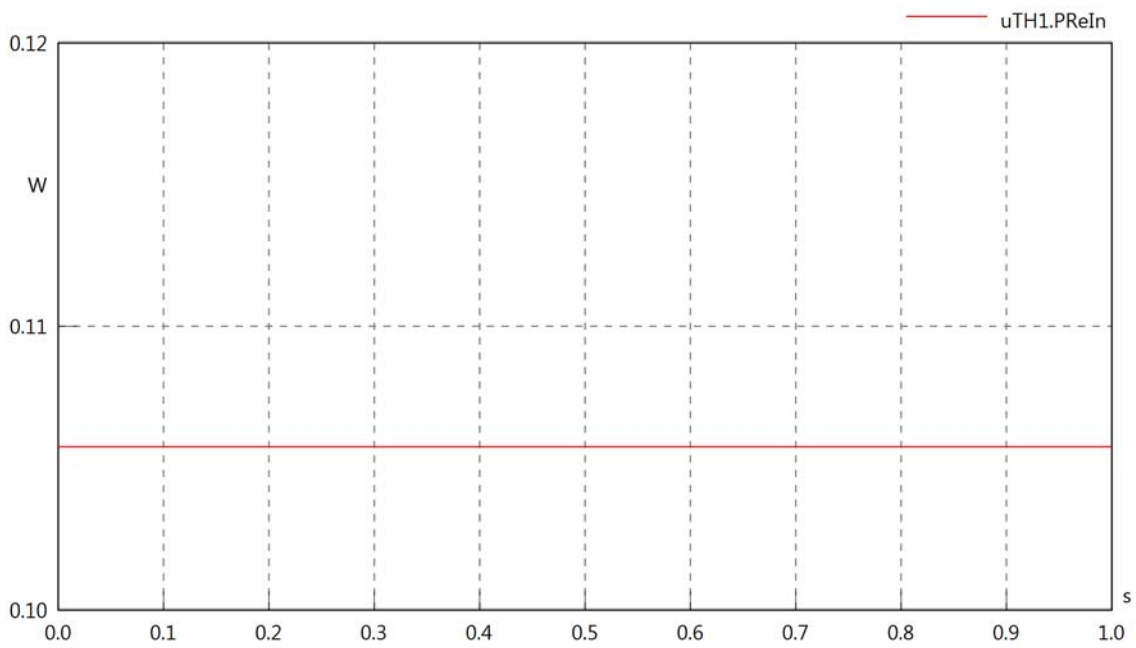

uTH1.PImIn

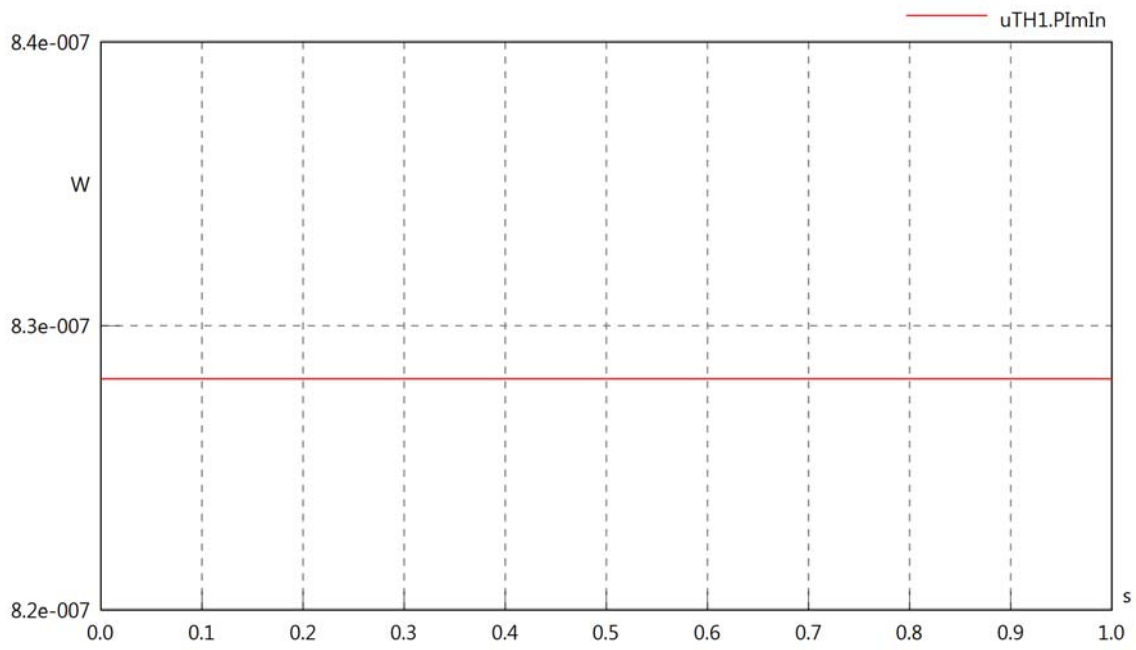

uTH1.SIn

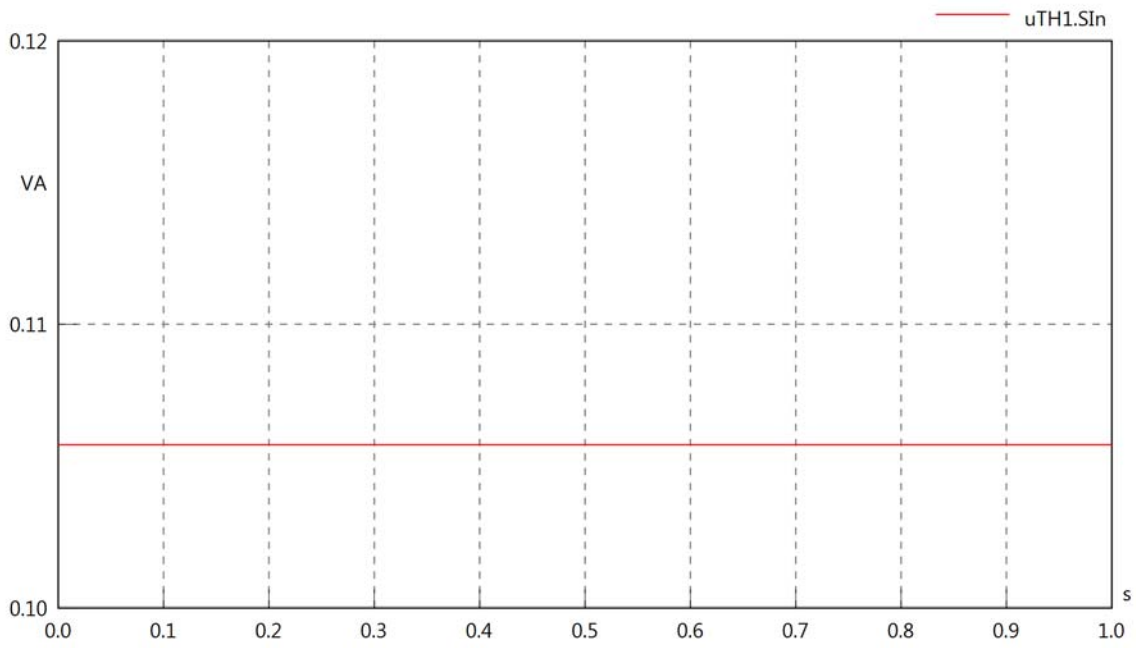

uTH1.PReOut

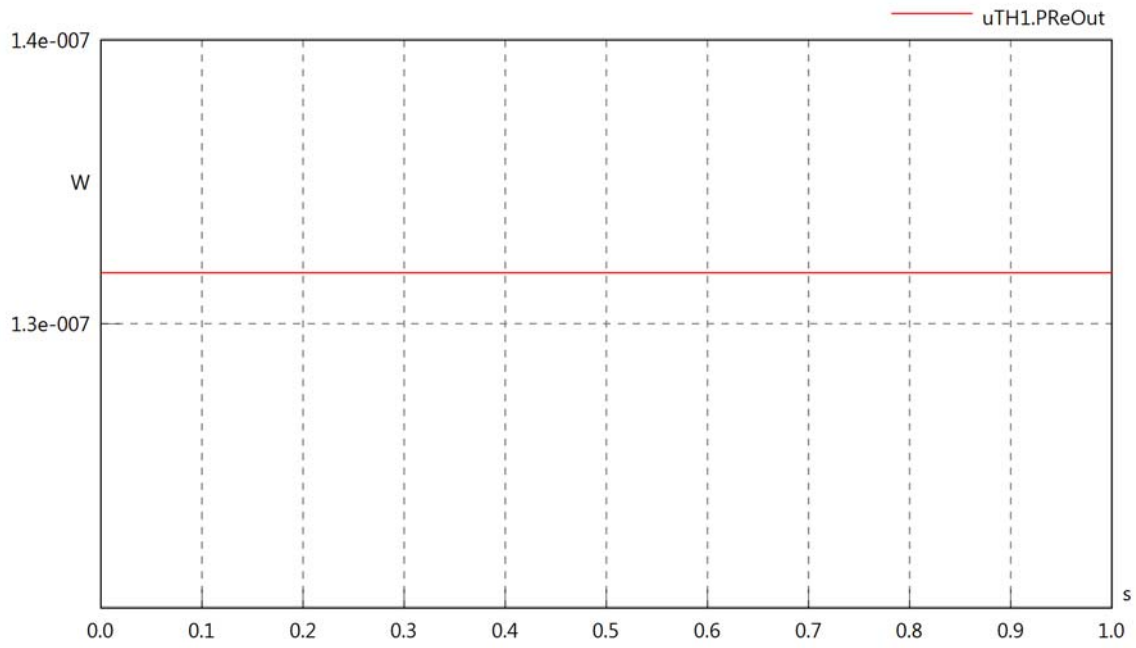

uTH1.PImOut

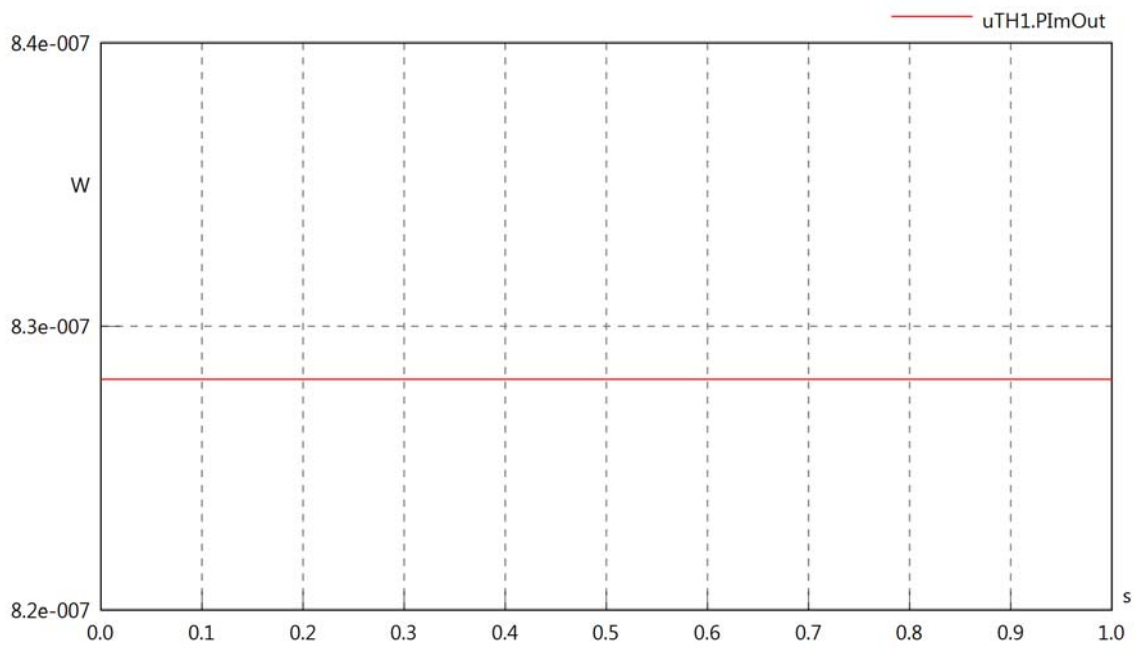

uTH1.SOut

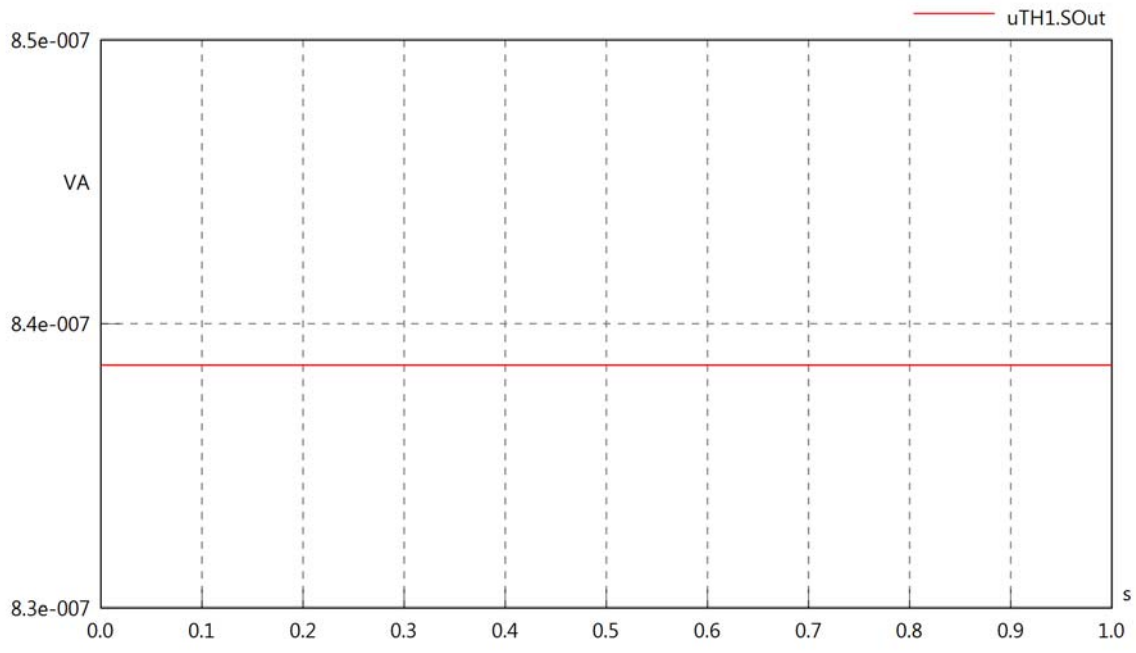
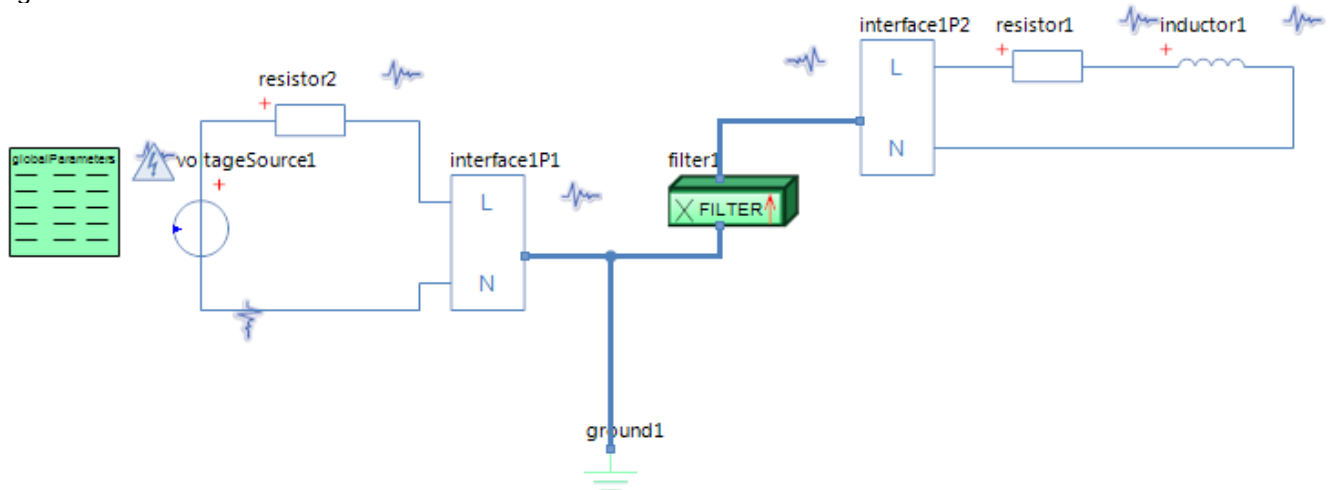

Diagram View



GlobalParameters globalParameters
Parameters

Comment	Name	Current Value	Unit
Type of Calculation	eCalculationKind	Signal Calculation	
Description of Frequency	eFrequencyKind	Linear	
Minimum Frequency	fMin	60	[Hz]
Maximum Frequency	fMax	60	[Hz]

Voltage Source voltageSource1
Parameters

Comment	Name	Current Value	Unit
Voltage RMS	VrmsSrc	5	[V]
Phase	phi	0	[deg]

Filter filter1
Parameters

Comment	Name	Current Value	Unit
Conductance between L1 and N Power side	G	1e-3	[1/Ohm]
EPU or Modem sending on system	sType	EPU sending	

Inductor inductor1
Parameters

Comment	Name	Current Value	Unit
Inductance	L	5	[mH]

Resistor resistor1
Parameters

Comment	Name	Current Value	Unit
Resistance	R	100	[Ohm]

Resistor resistor2
Parameters

Comment	Name	Current Value	Unit
Resistance	R	10	[Ohm]

filter1.VrmsIn

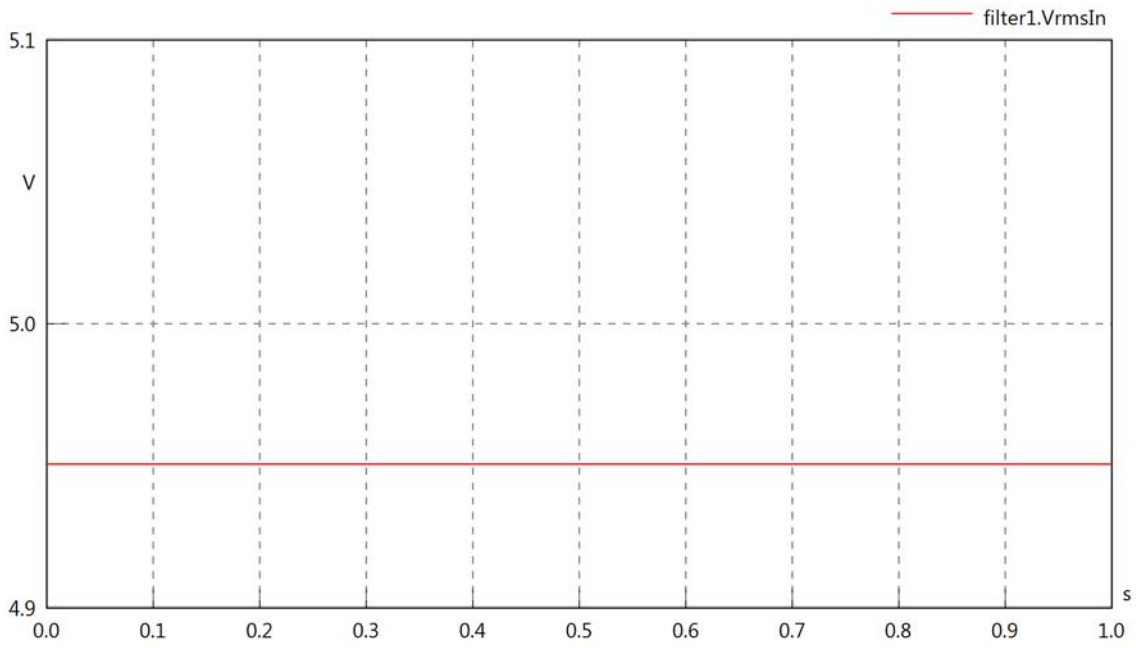

filter1.vReIn

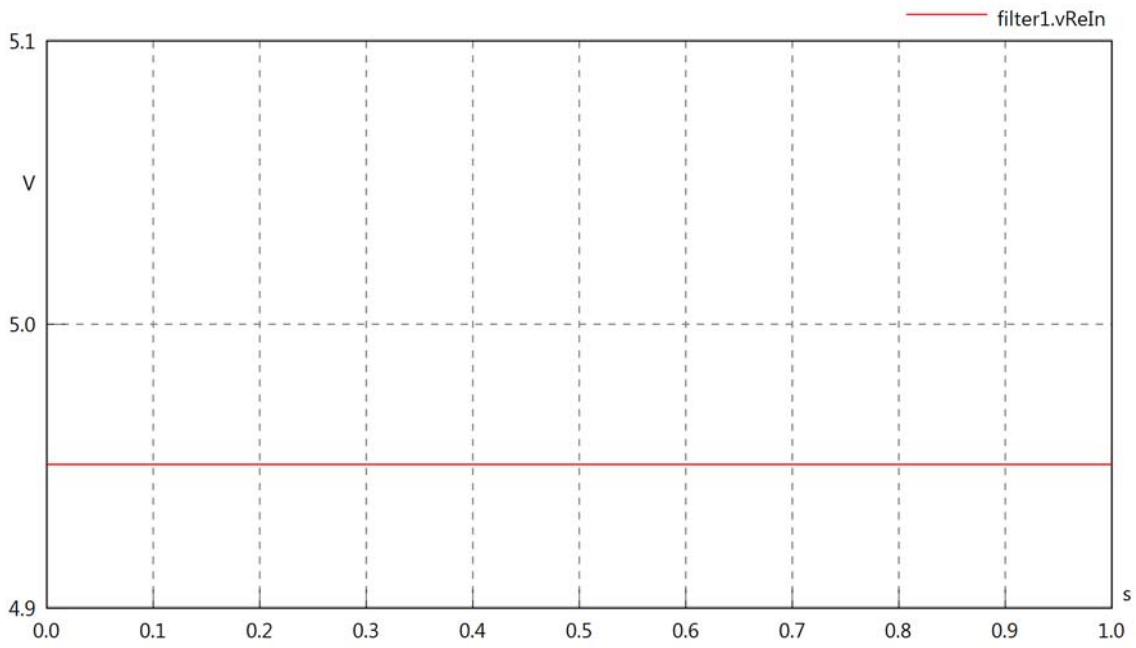

filter1.vImIn

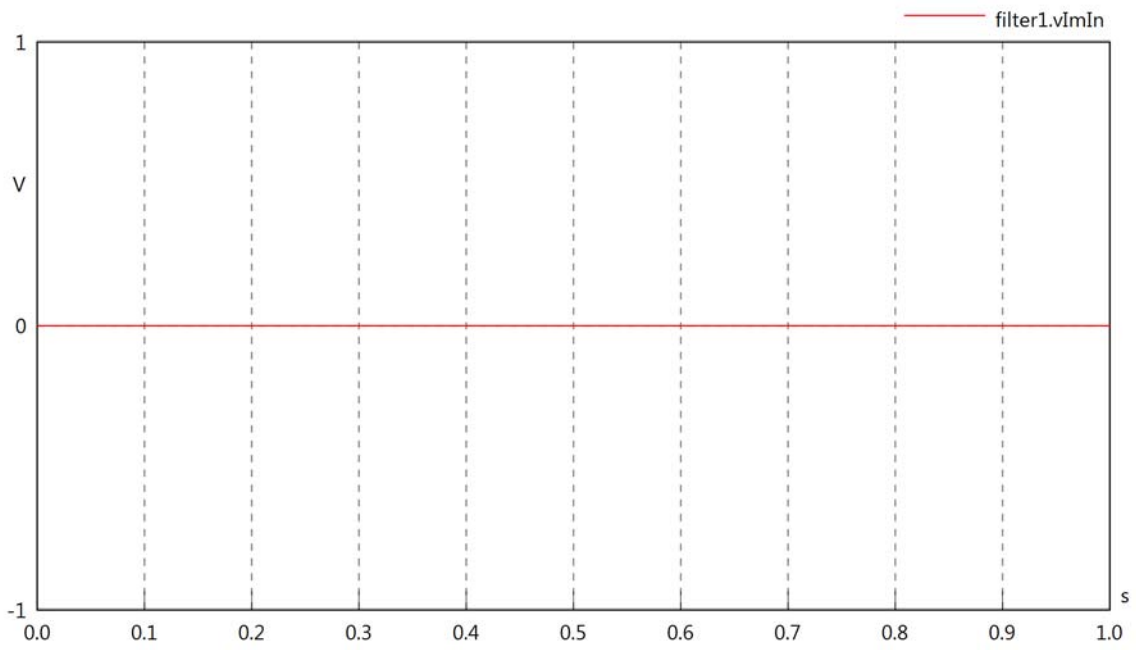

filter1.IrmsIn

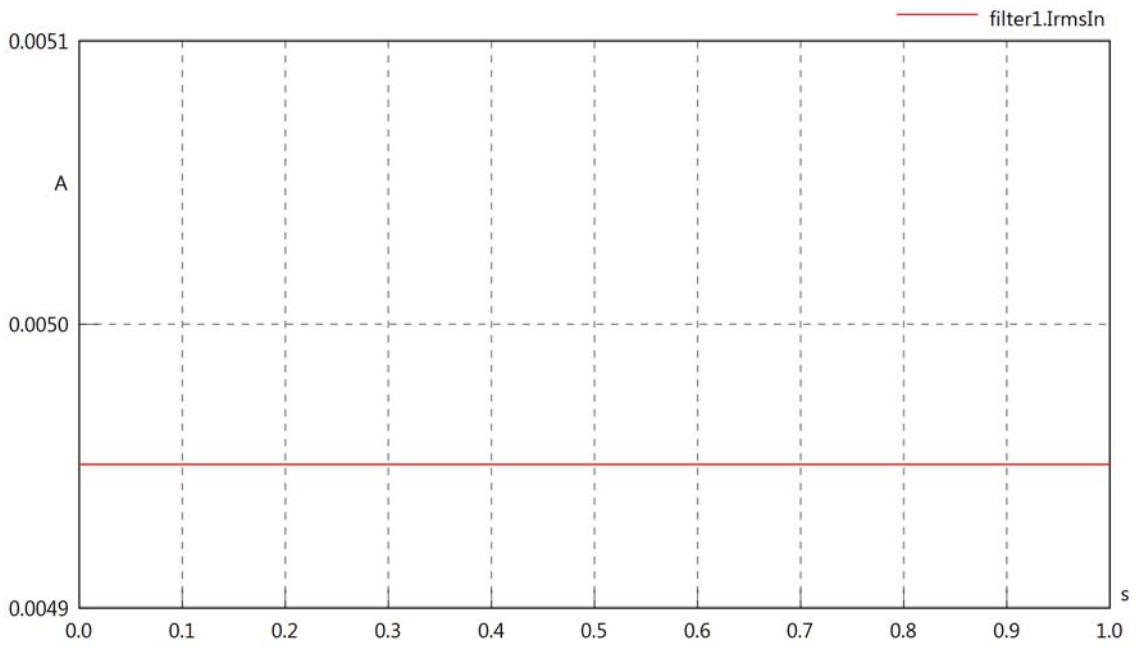

filter1.iReIn

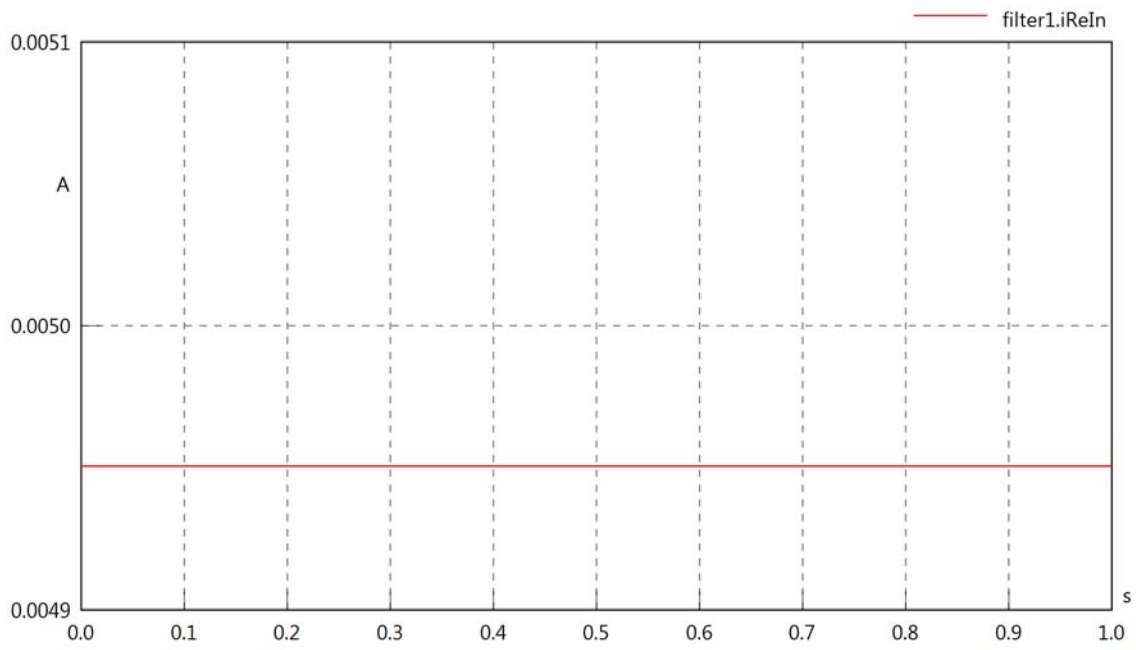

filter1.iImIn

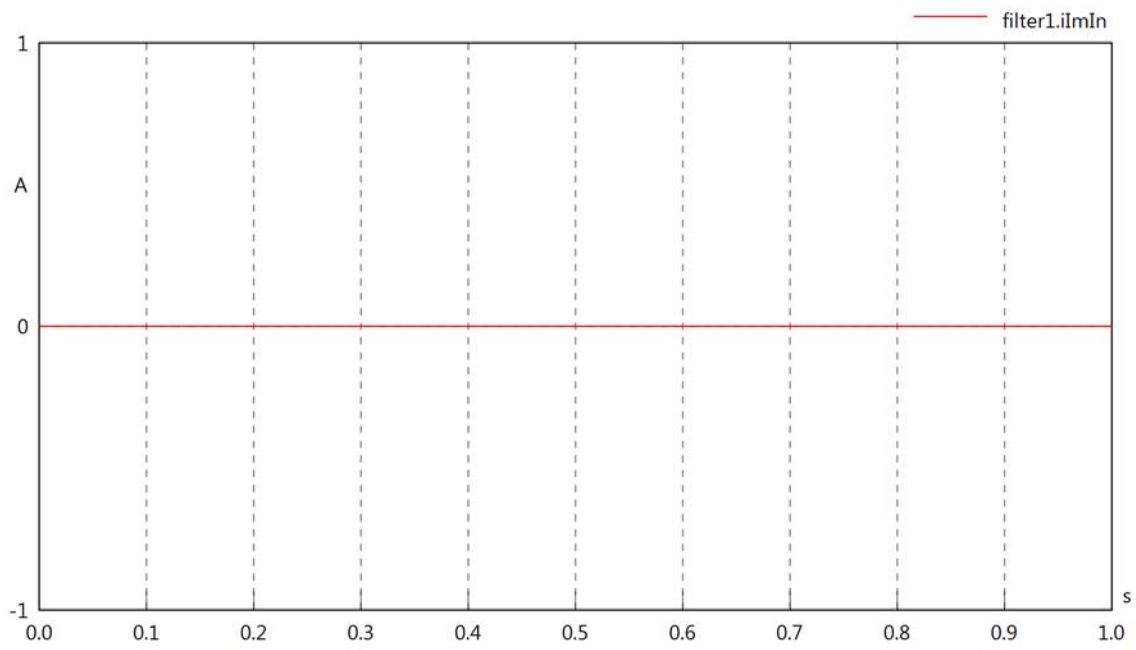

filter1.phiVIn

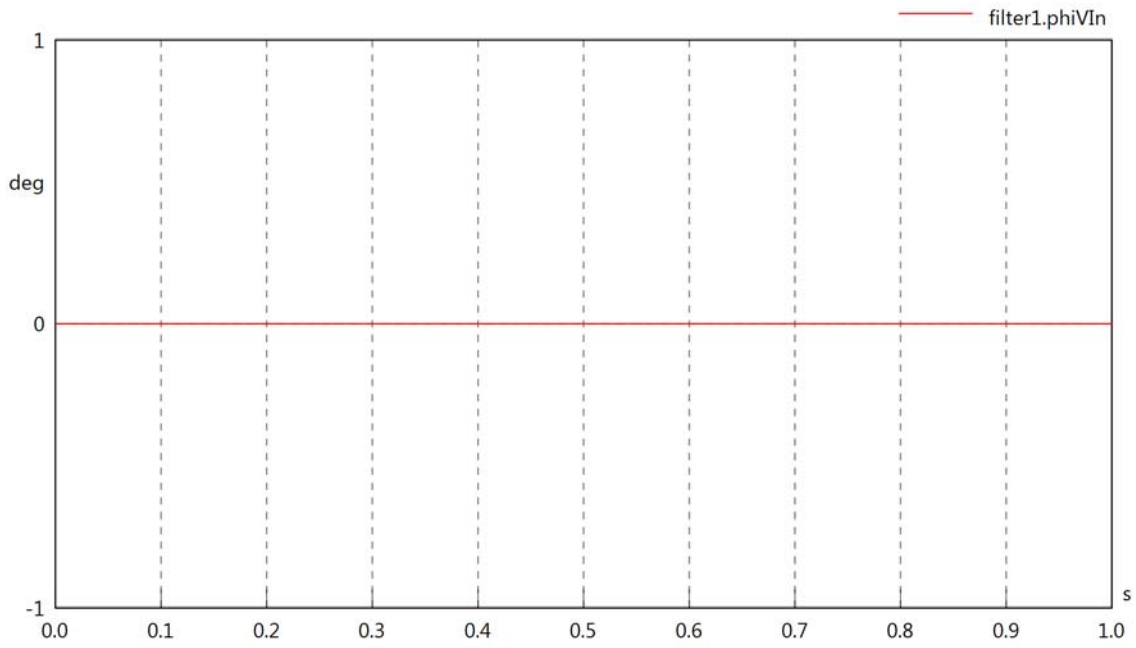

filter1.phiIn

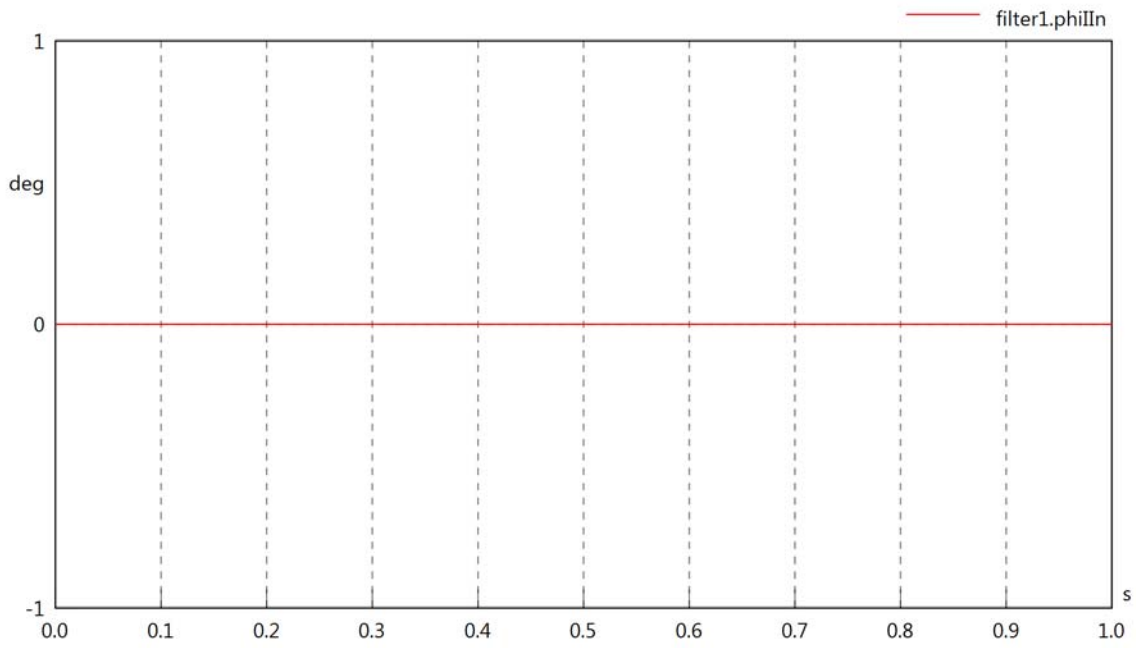

filter1.phiIVIn

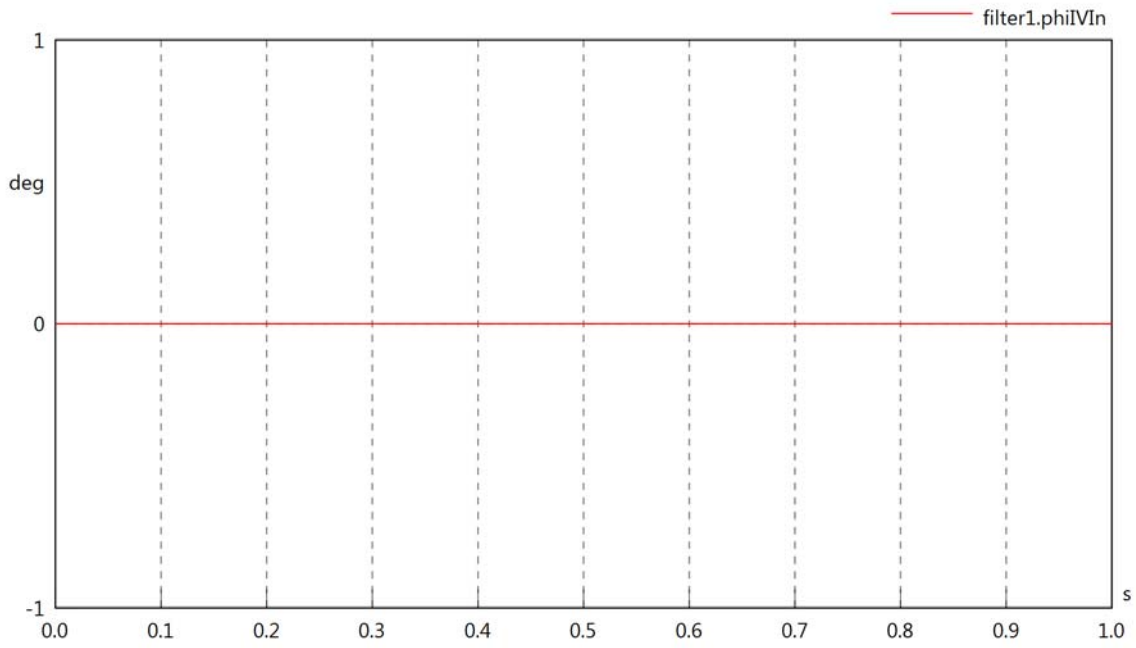

filter1.PReIn

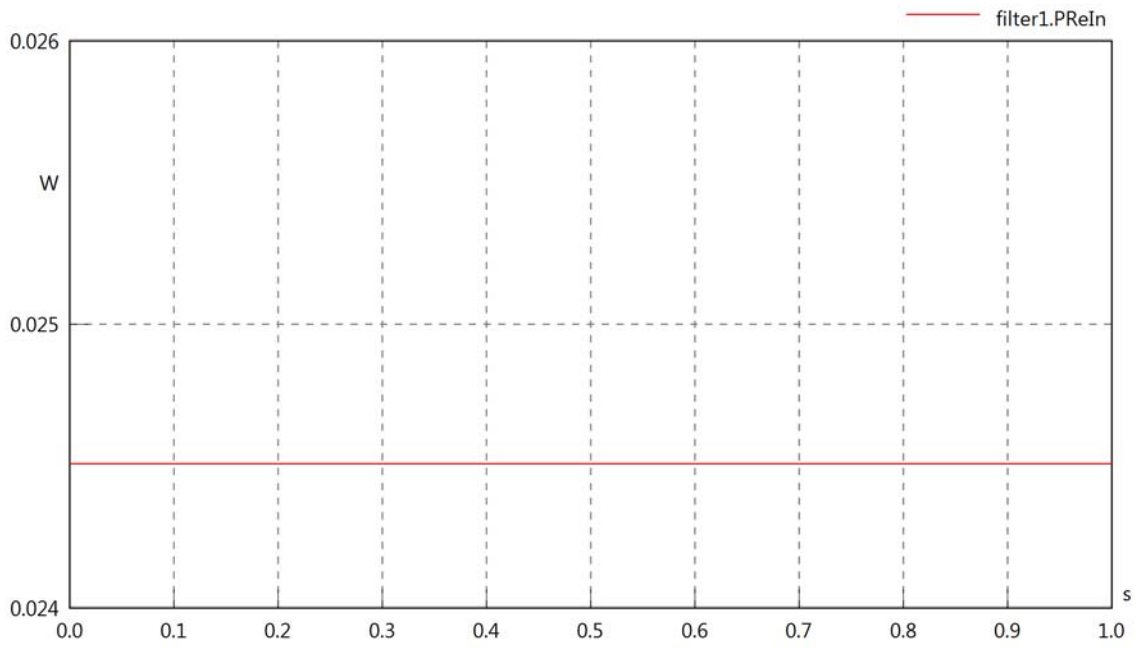

filter1.PImIn

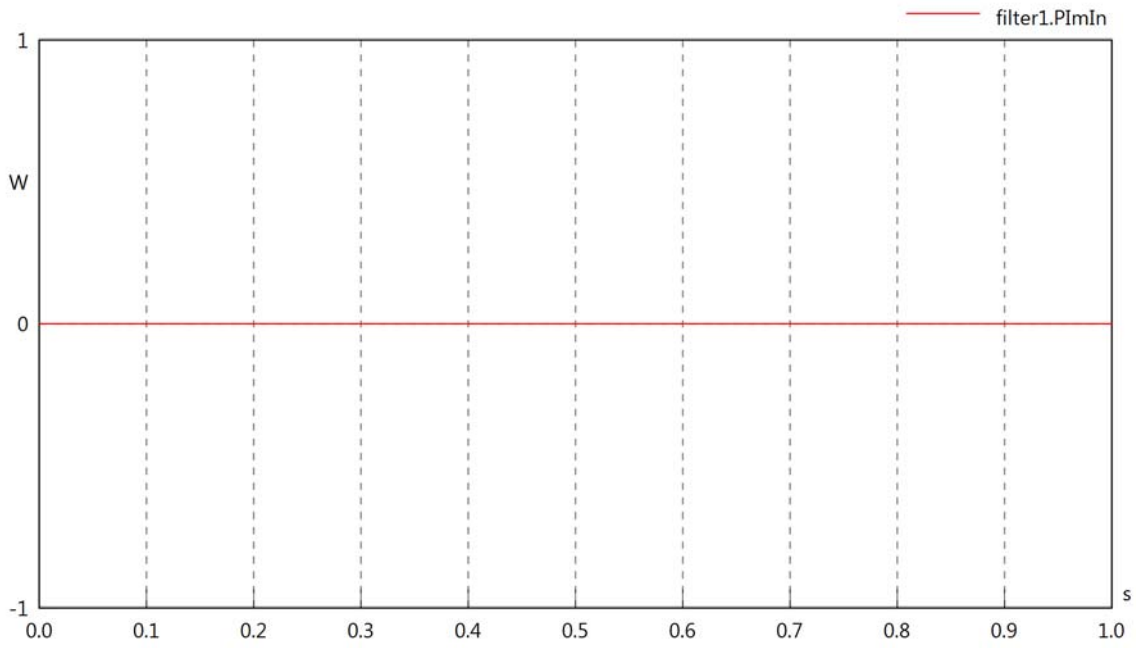

filter1.SIn

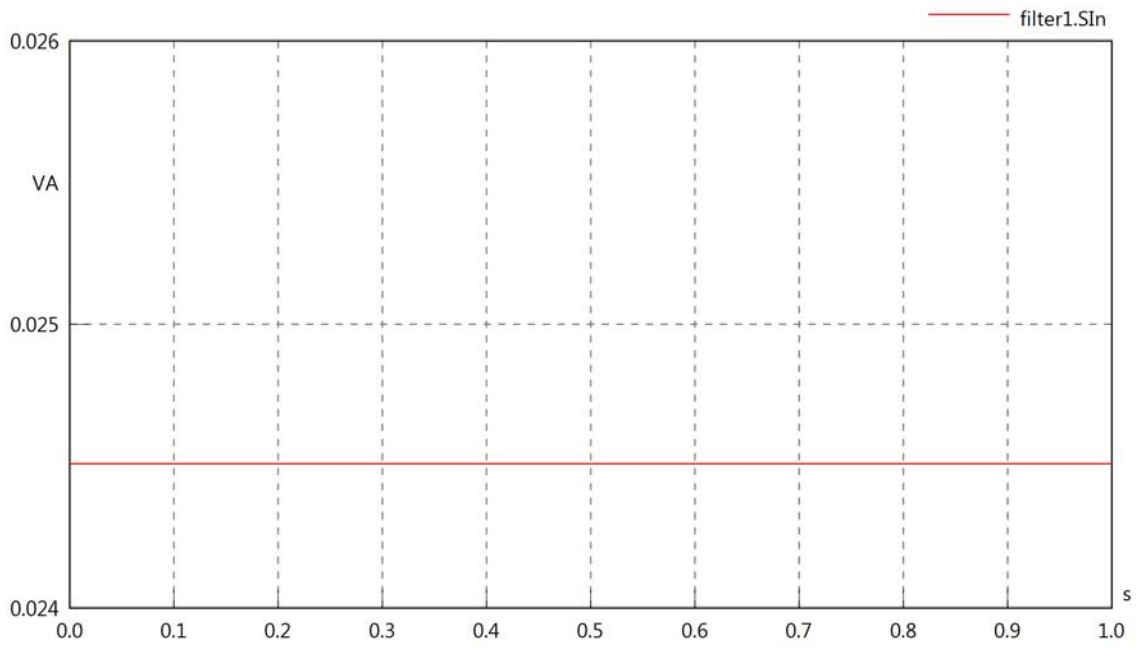

filter1.VrmsOut

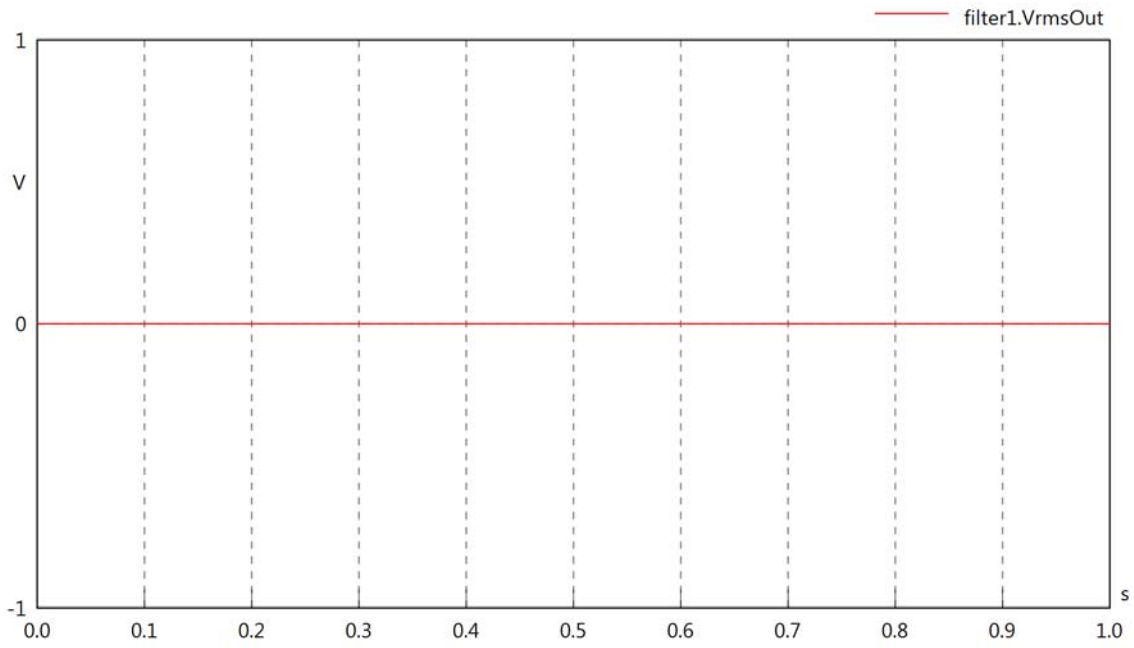

filter1.vReOut

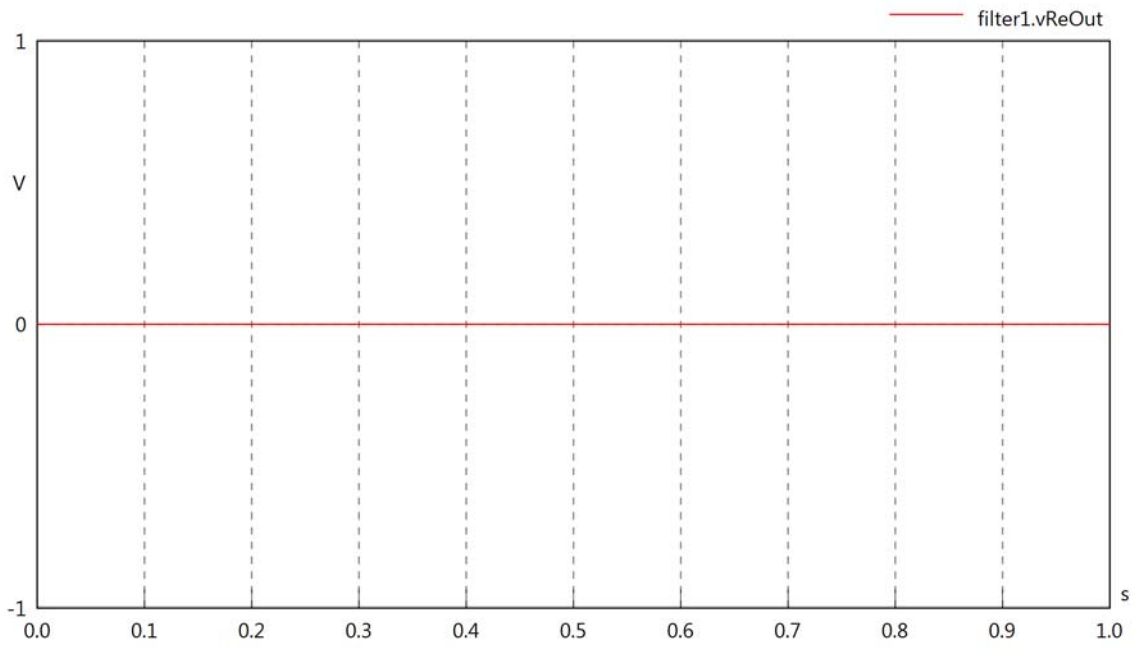

filter1.vImOut

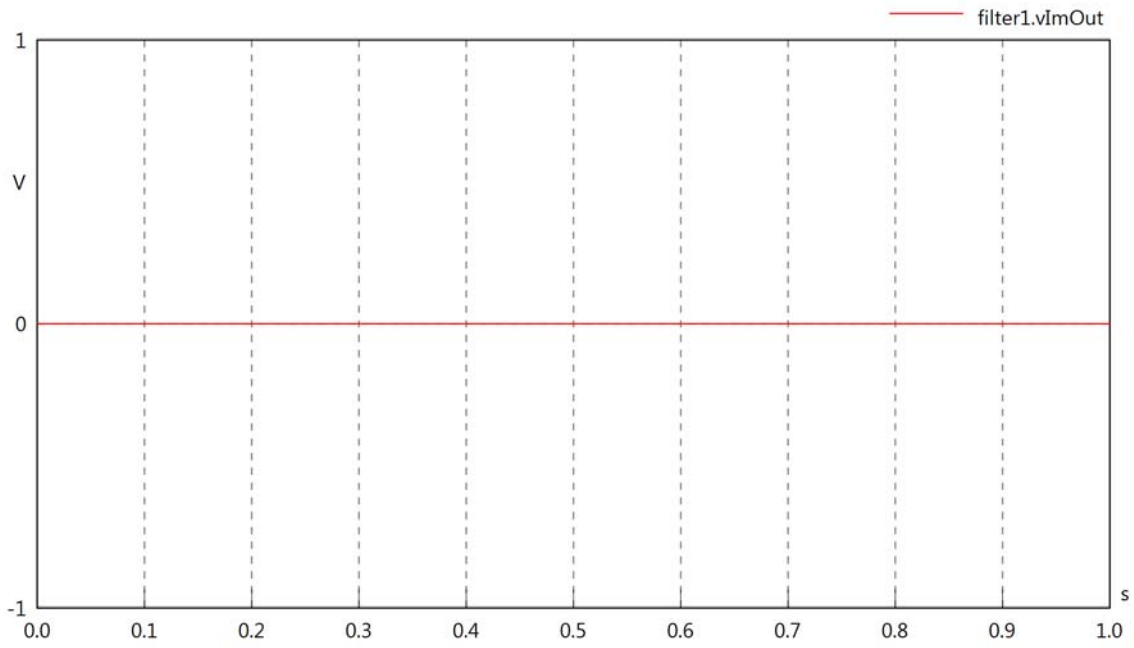

filter1.IrmsOut

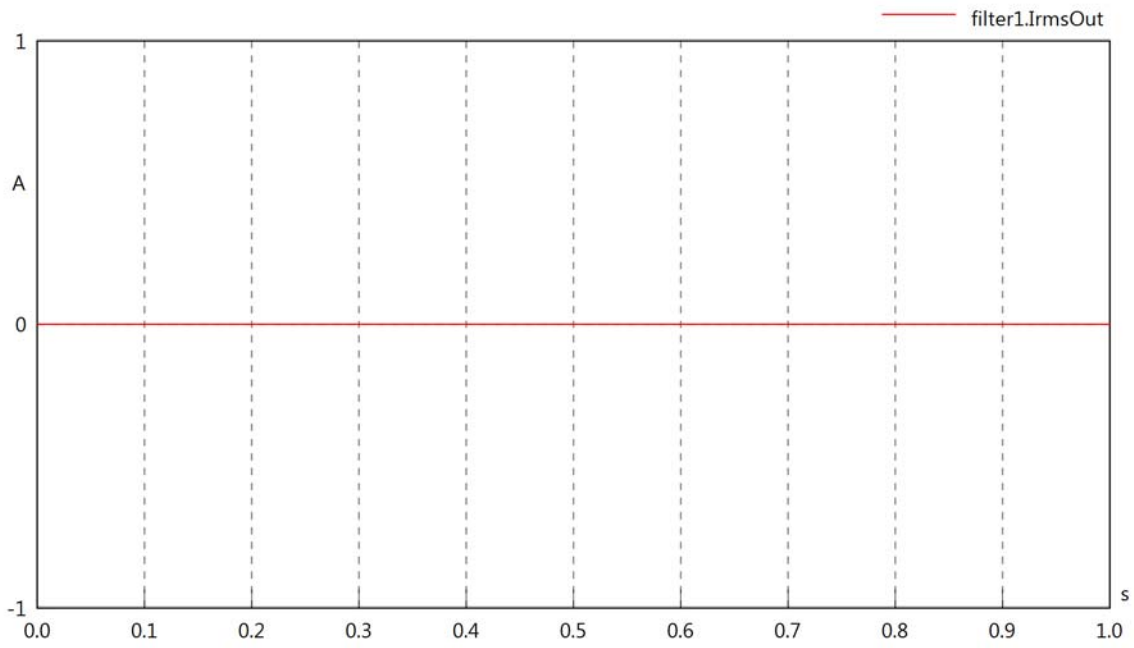

filter1.iReOut

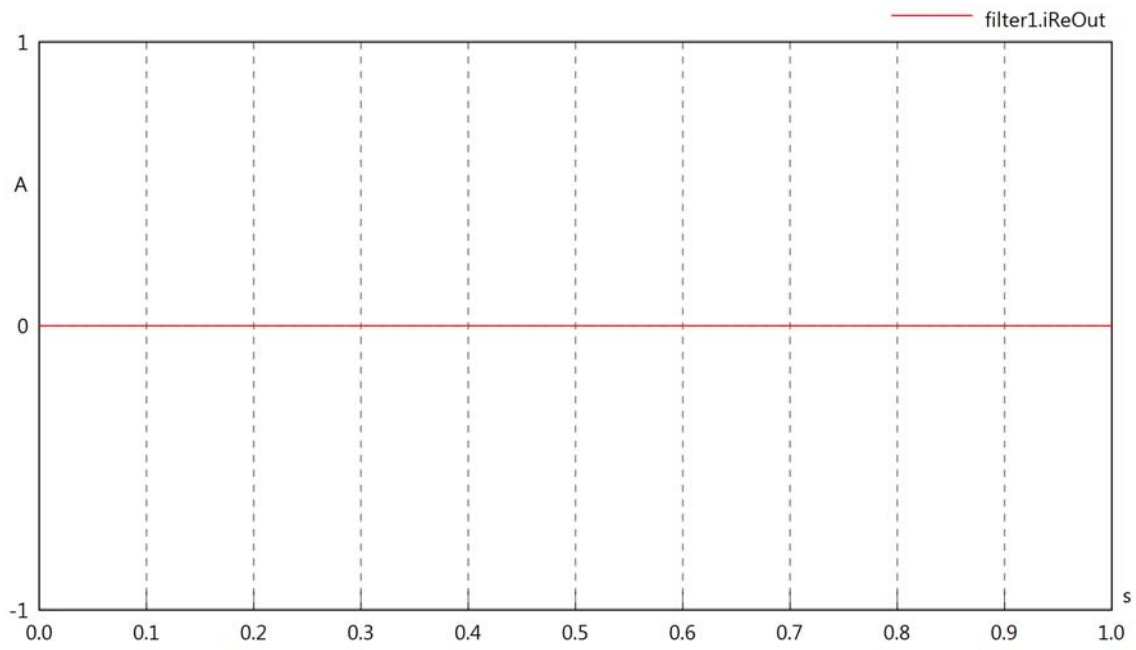

filter1.iImOut

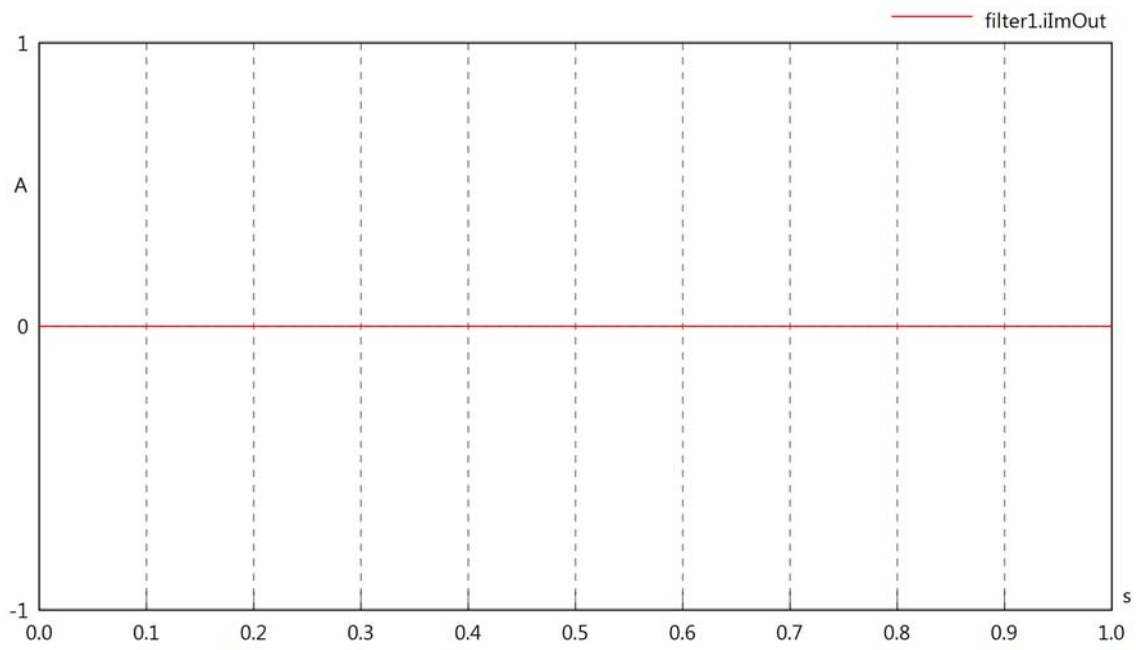

filter1.phiVOut

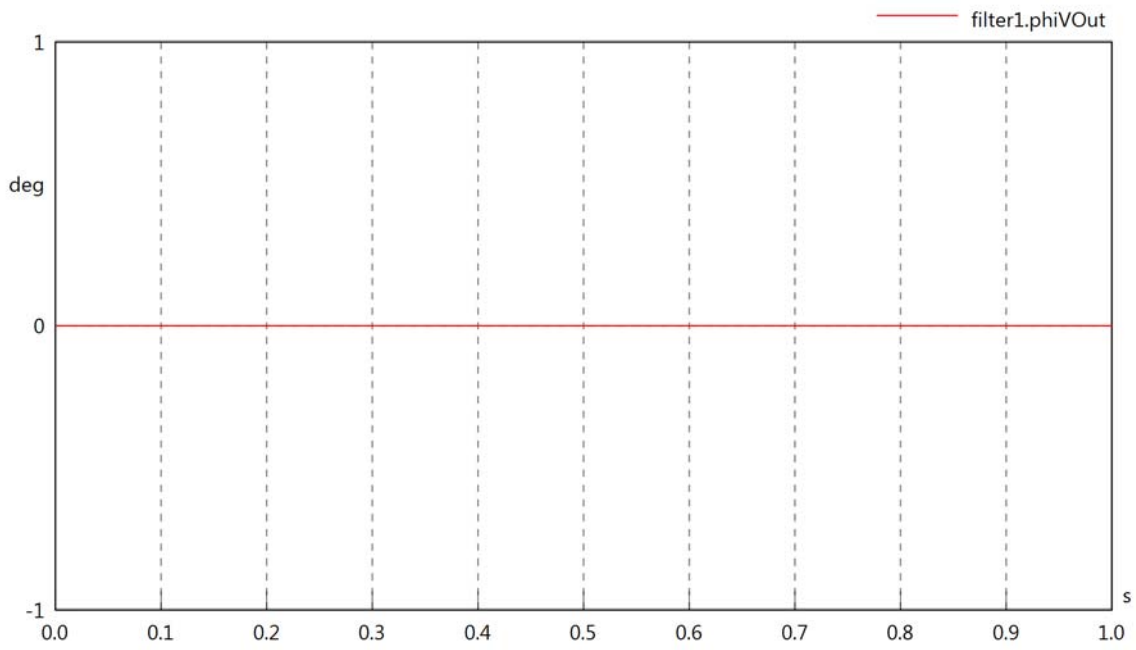

filter1.phiIOut

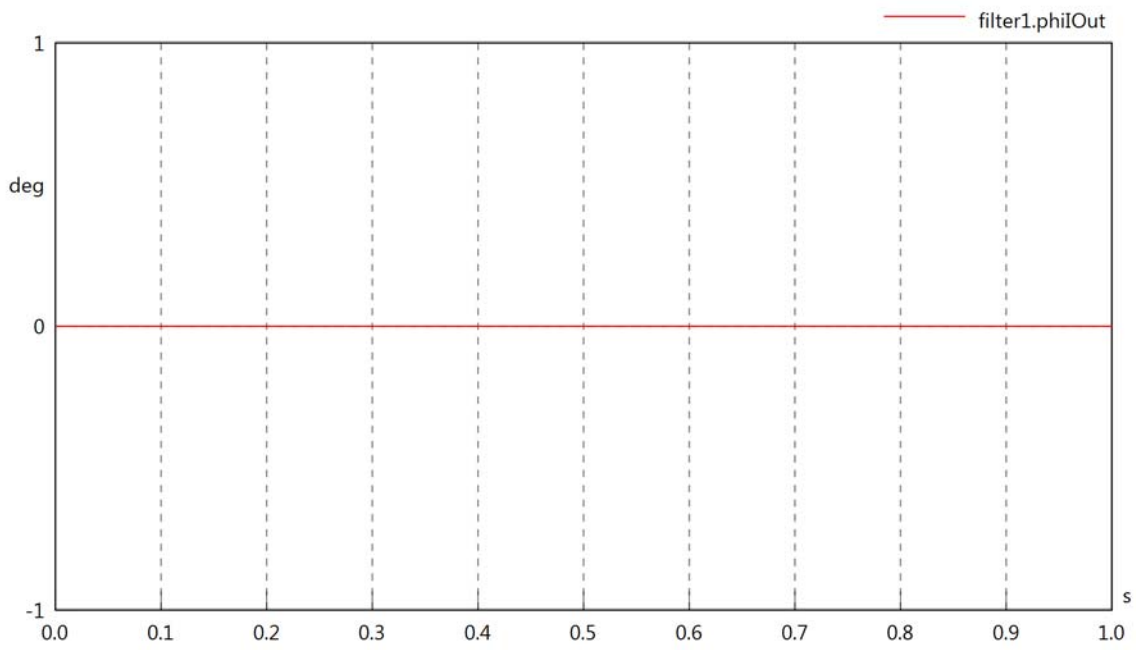

filter1.phiIVOut

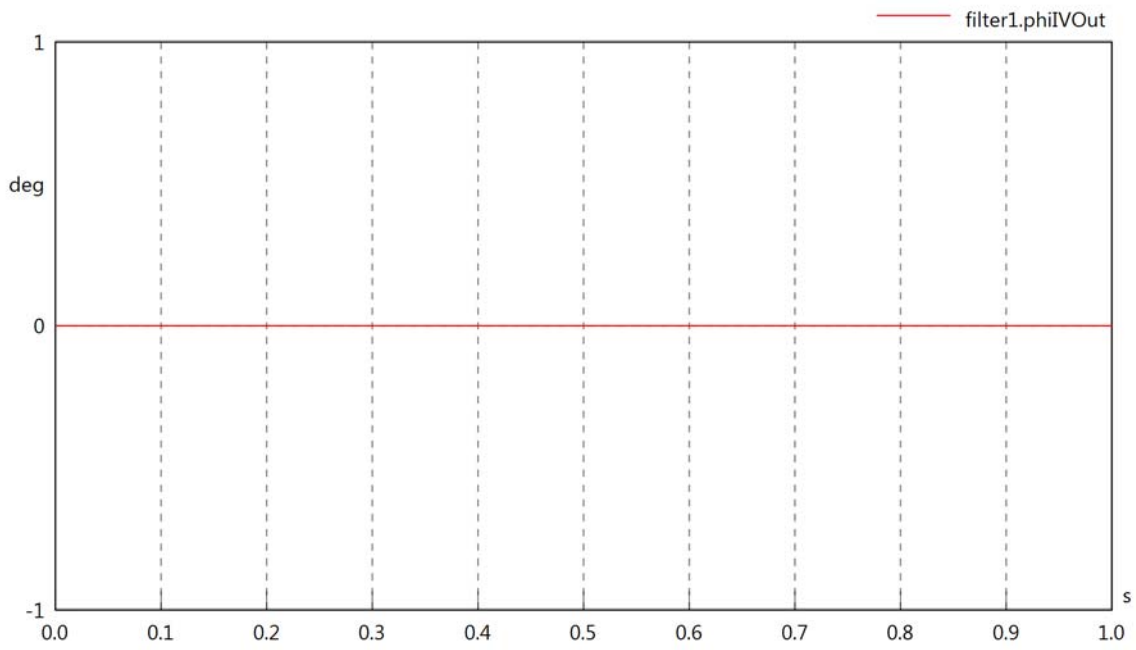

filter1.PReOut

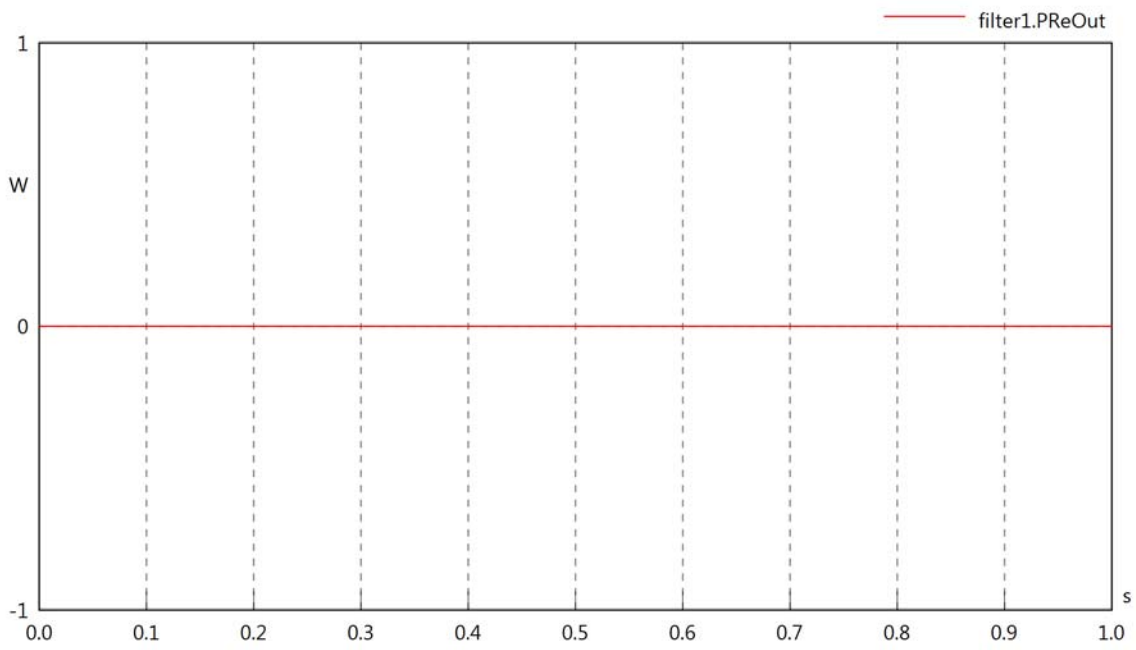

filter1.PImOut

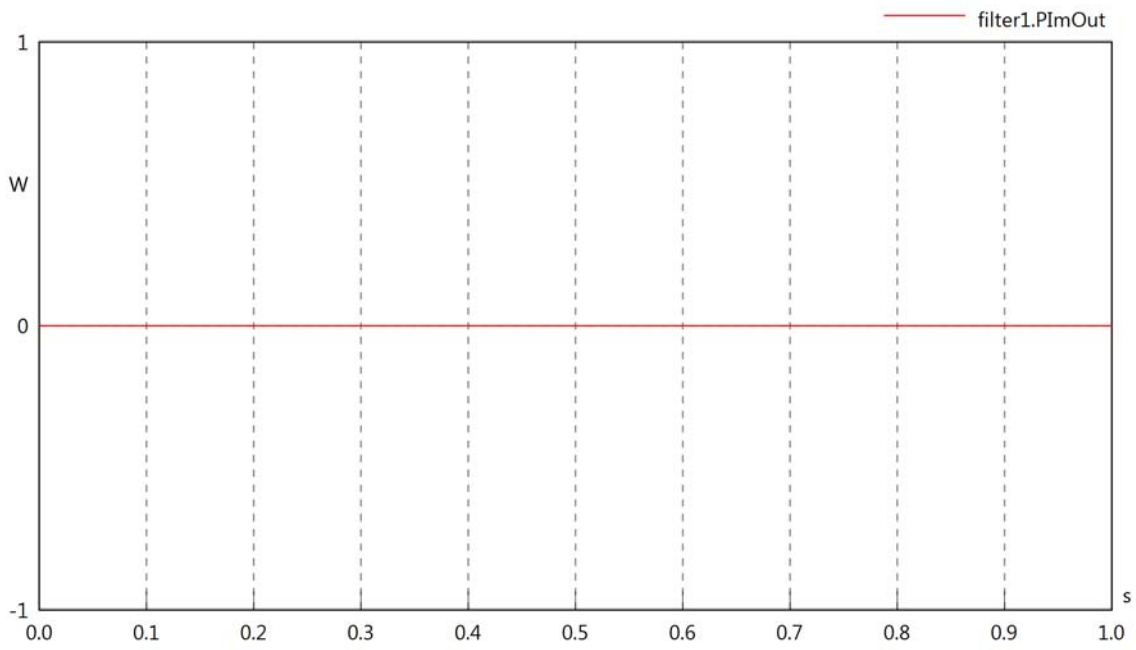

filter1.SOut

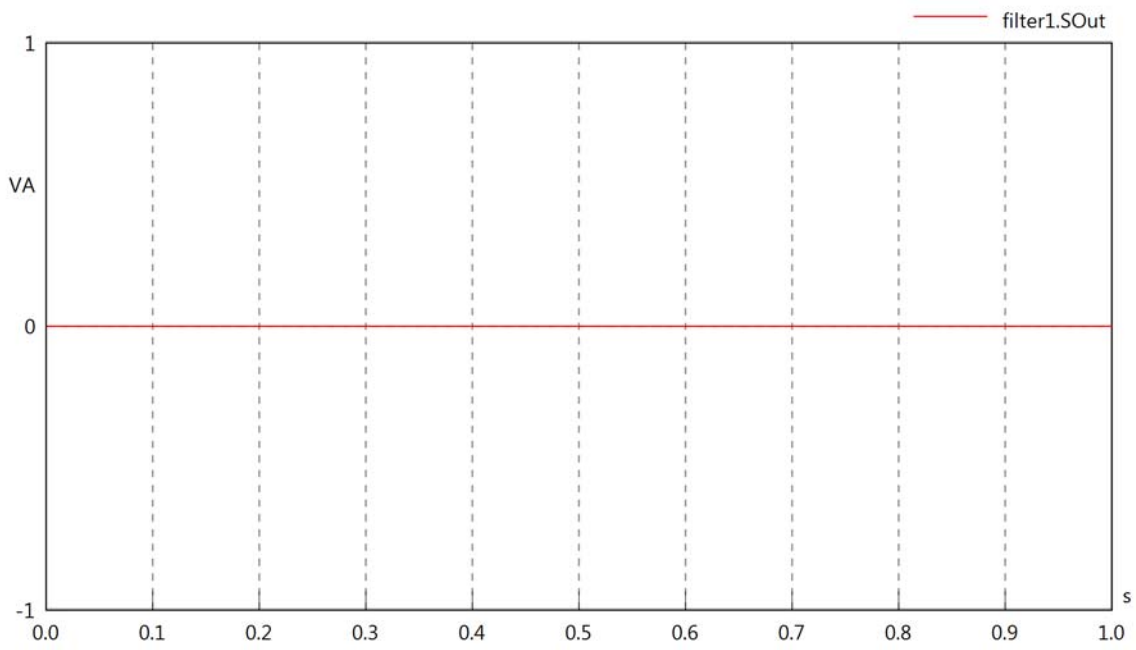
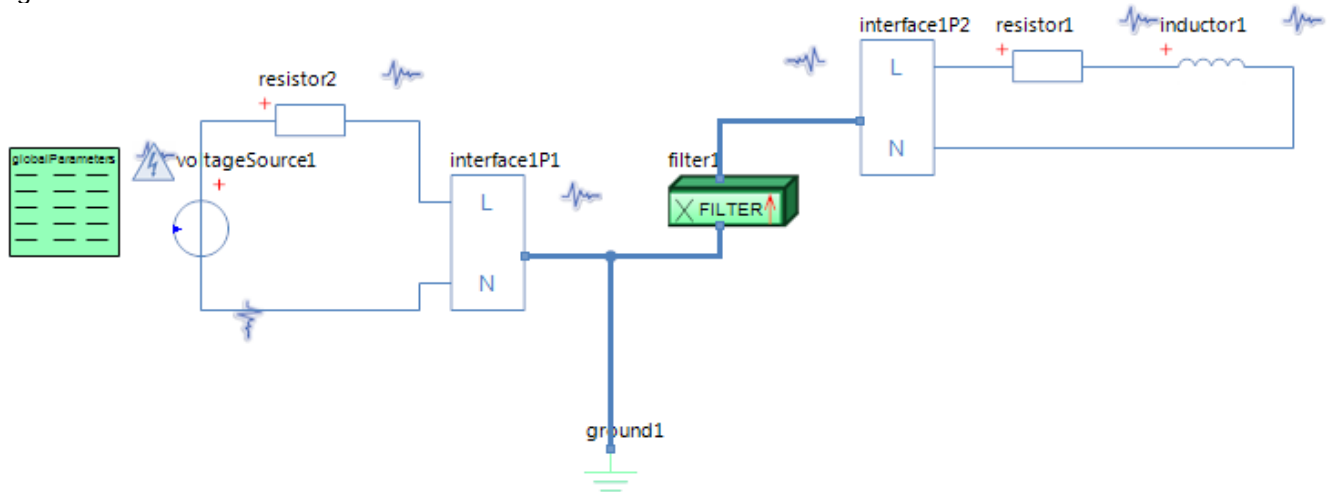

Diagram View



GlobalParameters globalParameters
Parameters

Comment	Name	Current Value	Unit
Type of Calculation	eCalculationKind	Signal Calculation	
Description of Frequency	eFrequencyKind	Linear	
Minimum Frequency	fMin	4000	[Hz]
Maximum Frequency	fMax	4000	[Hz]

Voltage Source voltageSource1
Parameters

Comment	Name	Current Value	Unit
Voltage RMS	VrmsSrc	5	[V]
Phase	phi	0	[deg]

Filter filter1
Parameters

Comment	Name	Current Value	Unit
Conductance between L1 and N Power side	G	1e-3	[1/Ohm]
EPU or Modem sending on system	sType	EPU sending	

Inductor inductor1
Parameters

Comment	Name	Current Value	Unit
Inductance	L	5	[mH]

Resistor resistor1
Parameters

Comment	Name	Current Value	Unit
Resistance	R	100	[Ohm]

Resistor resistor2
Parameters

Comment	Name	Current Value	Unit
Resistance	R	10	[Ohm]

filter1.VrmsIn

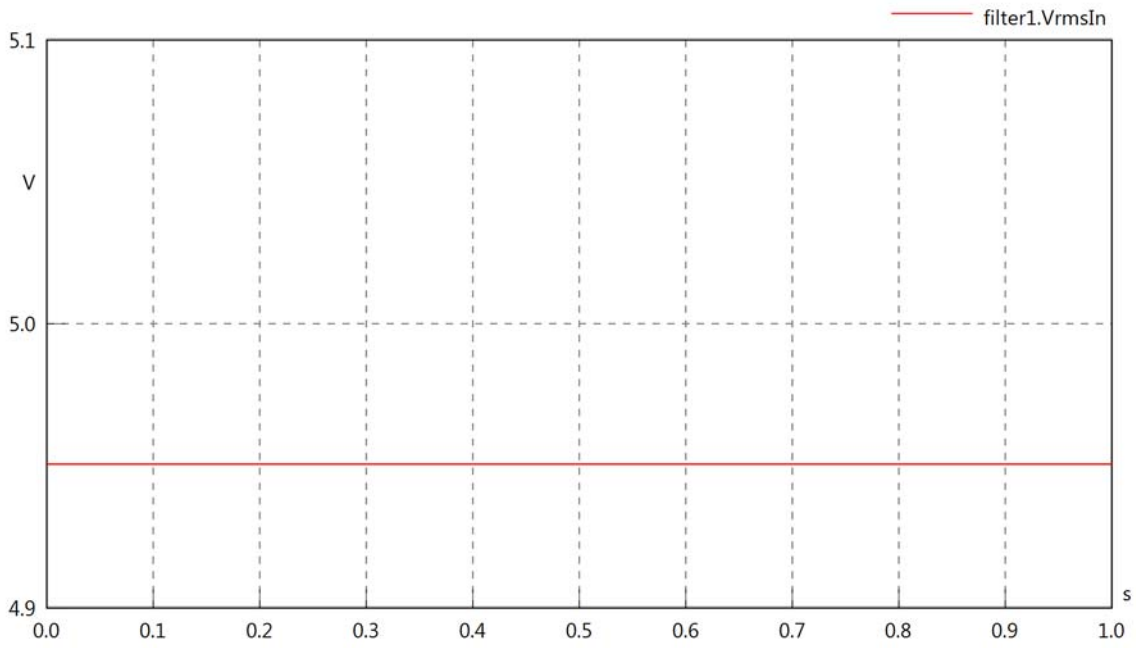

filter1.vReIn

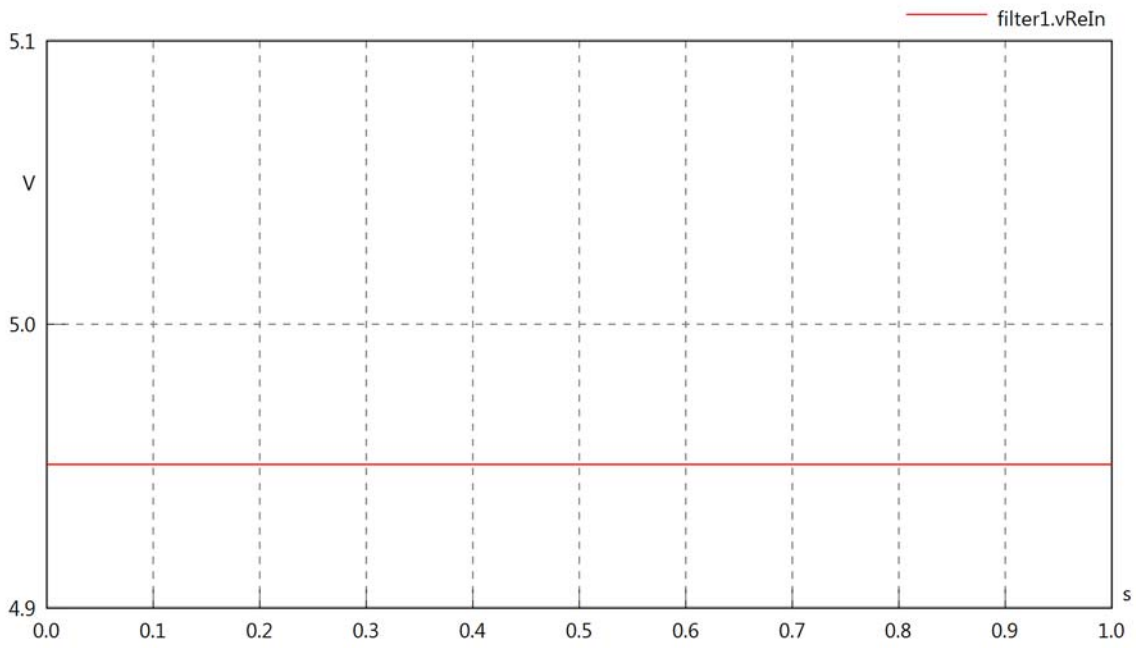

filter1.vImIn

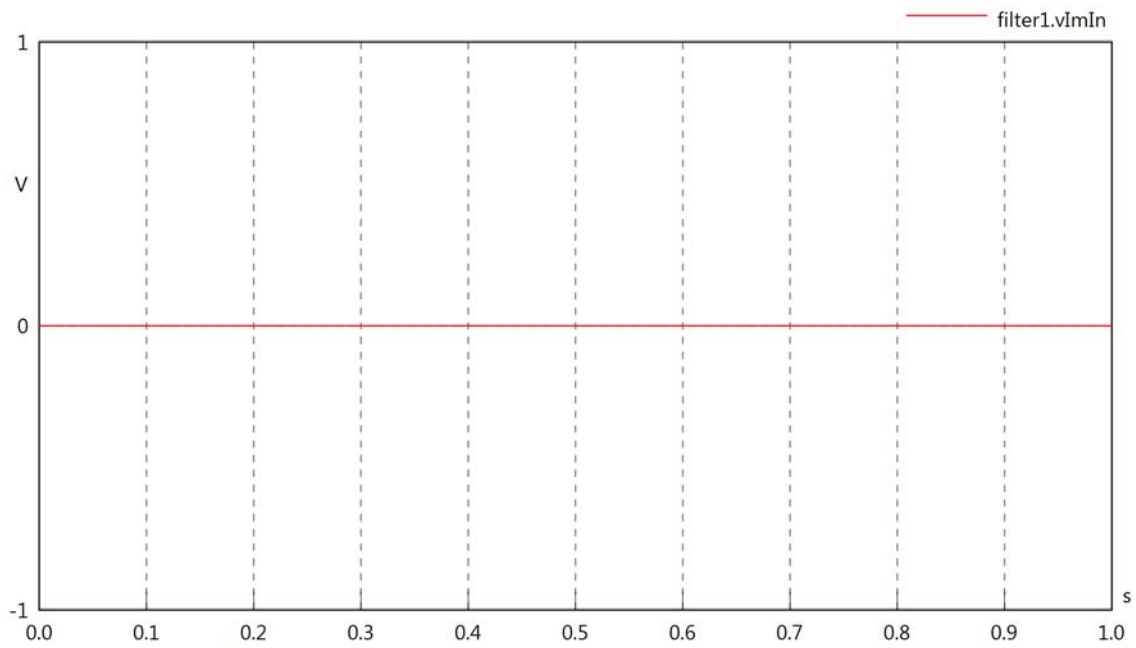

filter1.IrmsIn

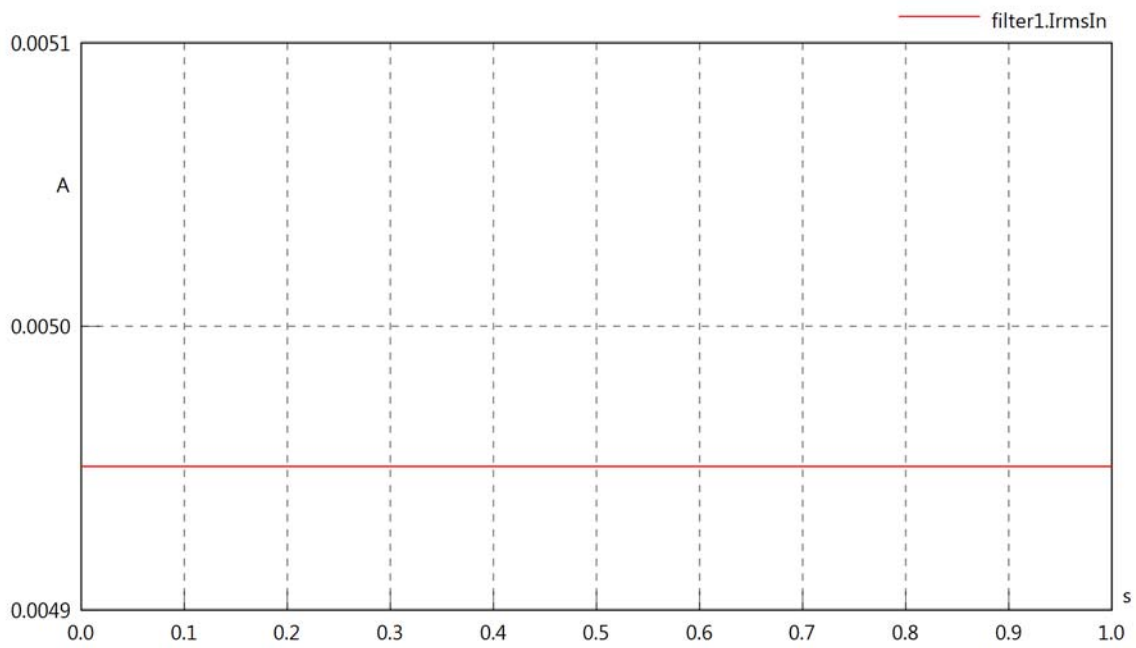

filter1.iReIn

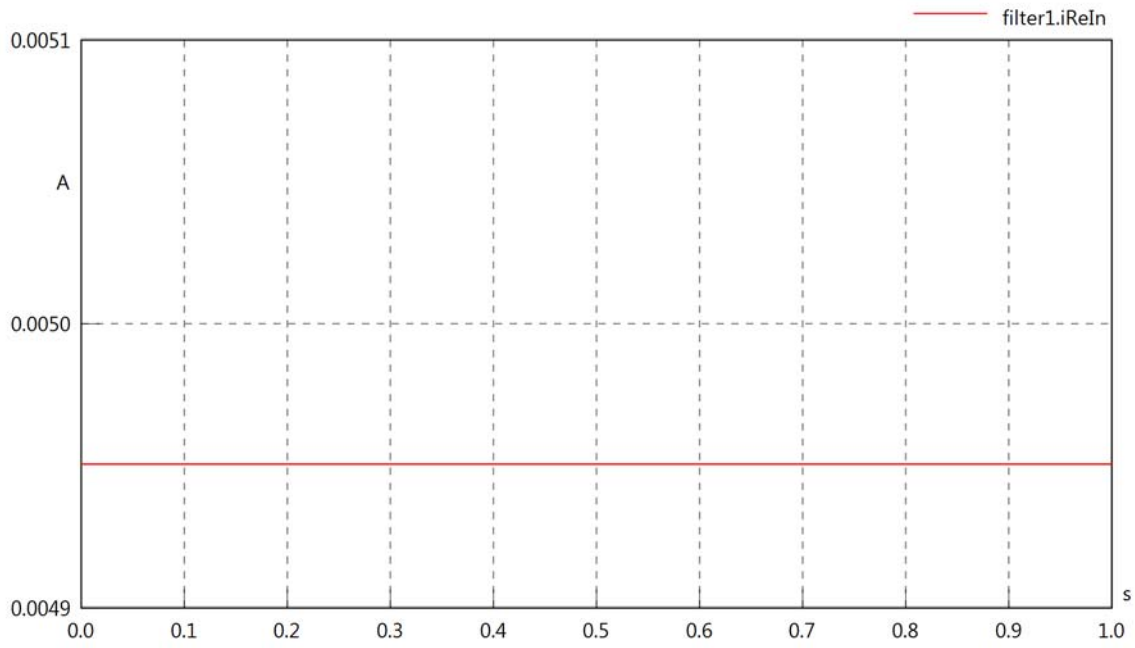

filter1.iImIn

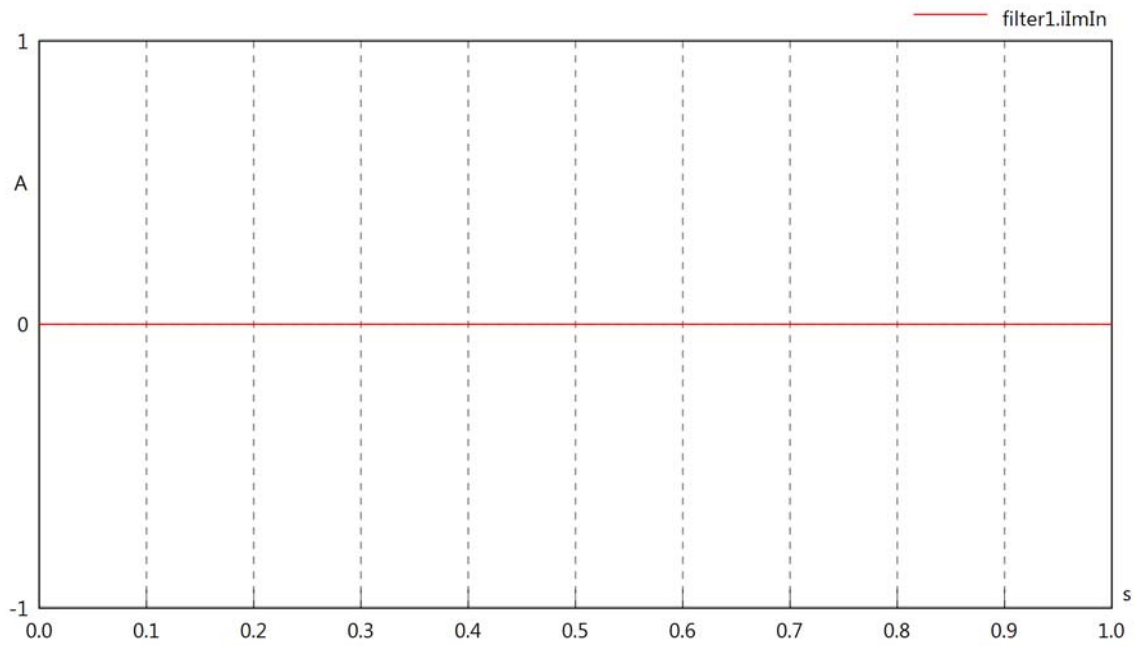

filter1.phiVIn

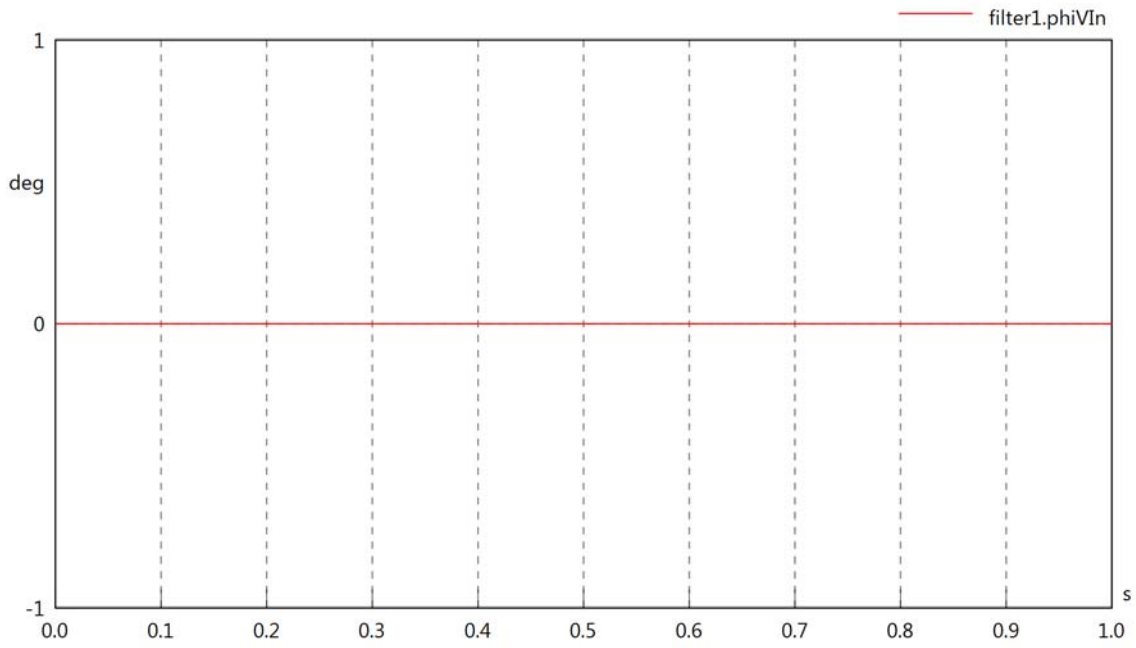

filter1.phiIn

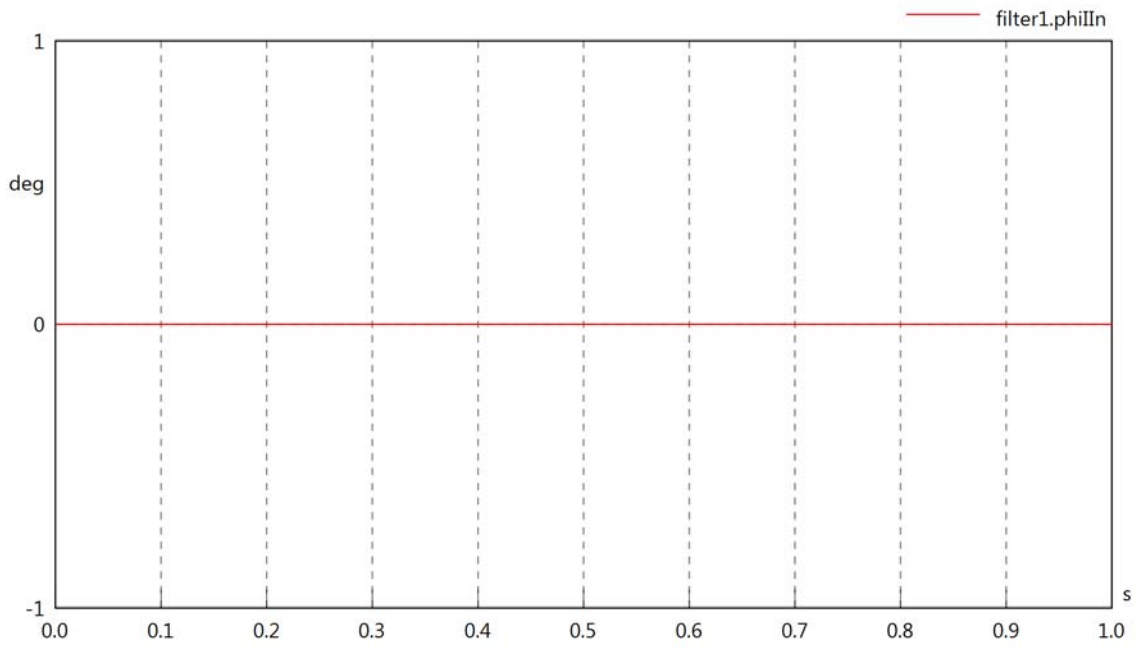

filter1.phiIVIn

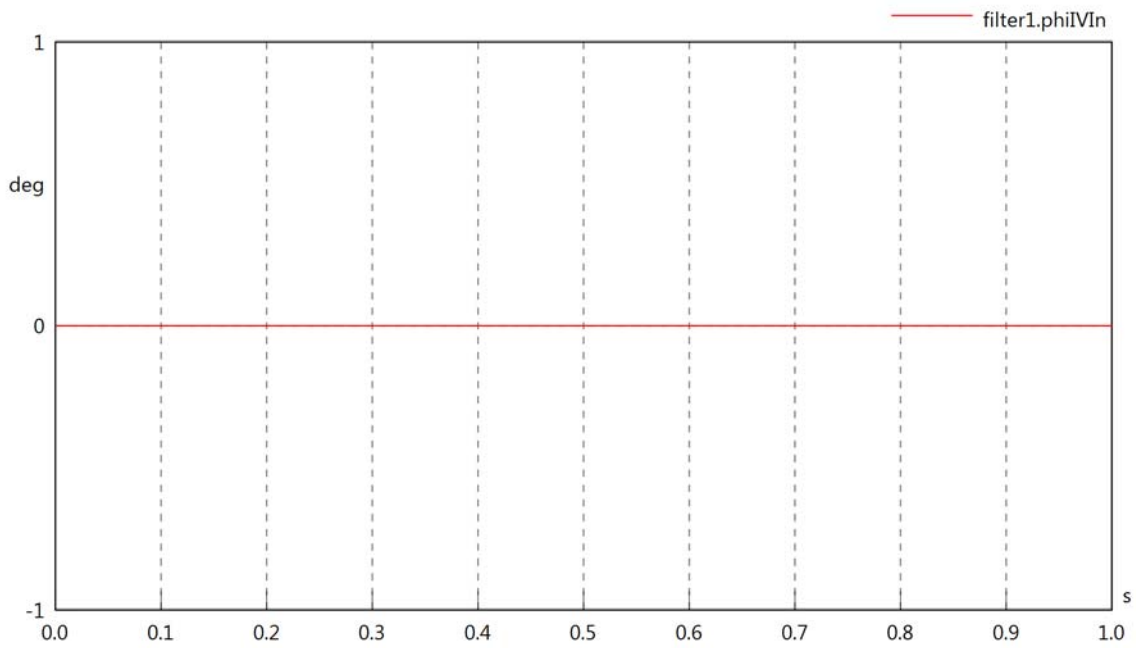

filter1.PReIn

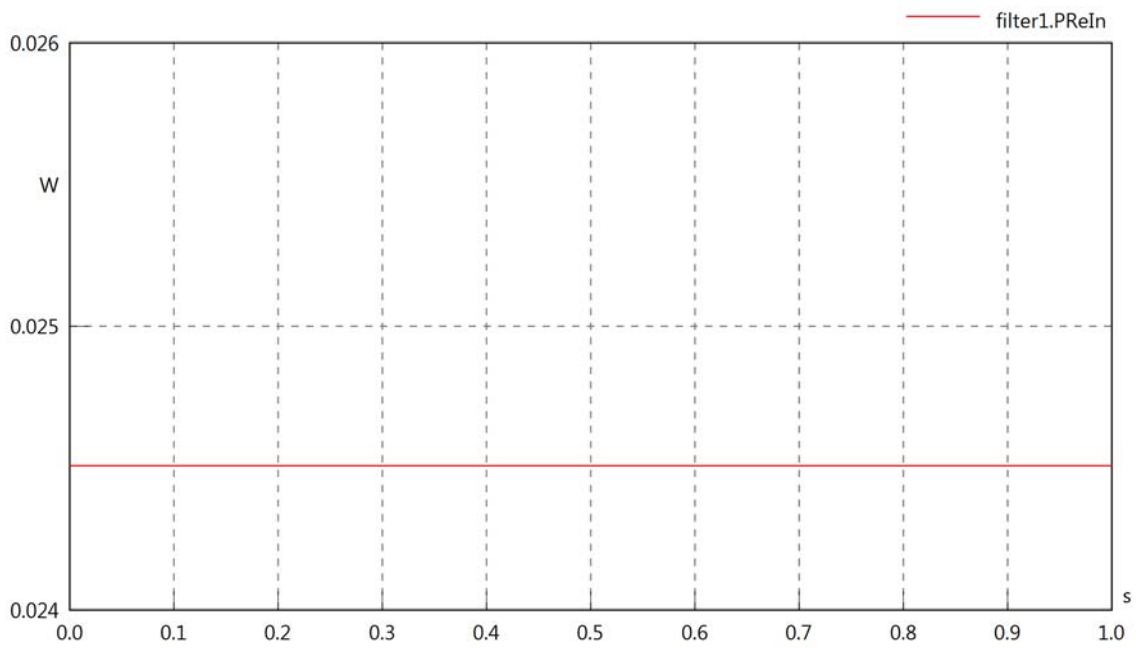

filter1.PImIn

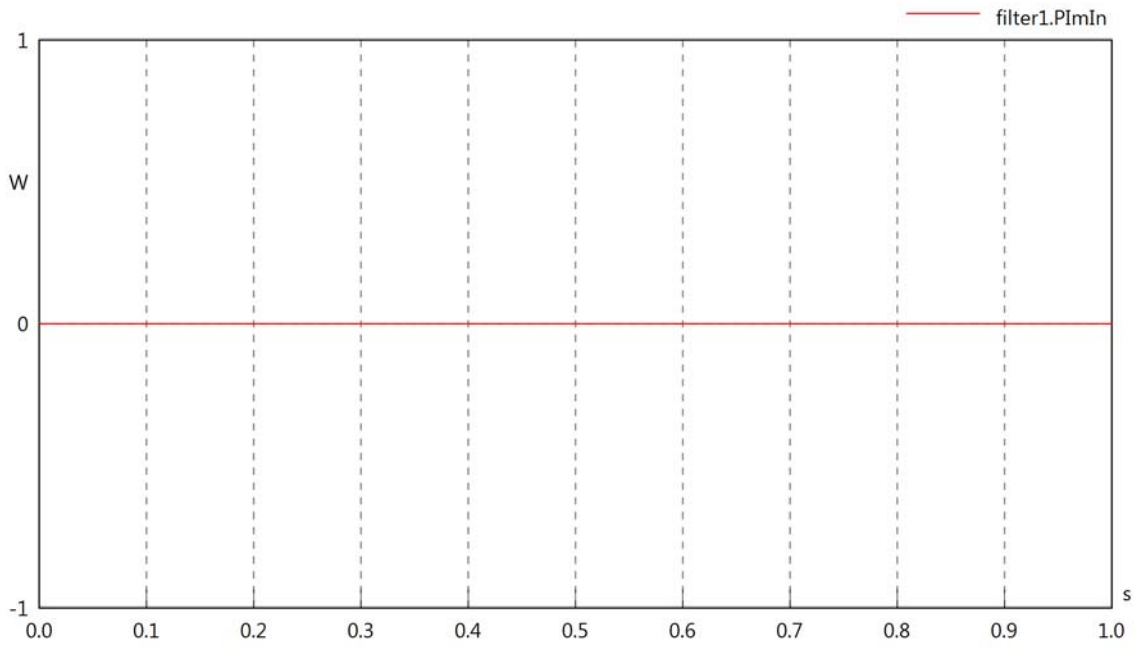

filter1.SIn

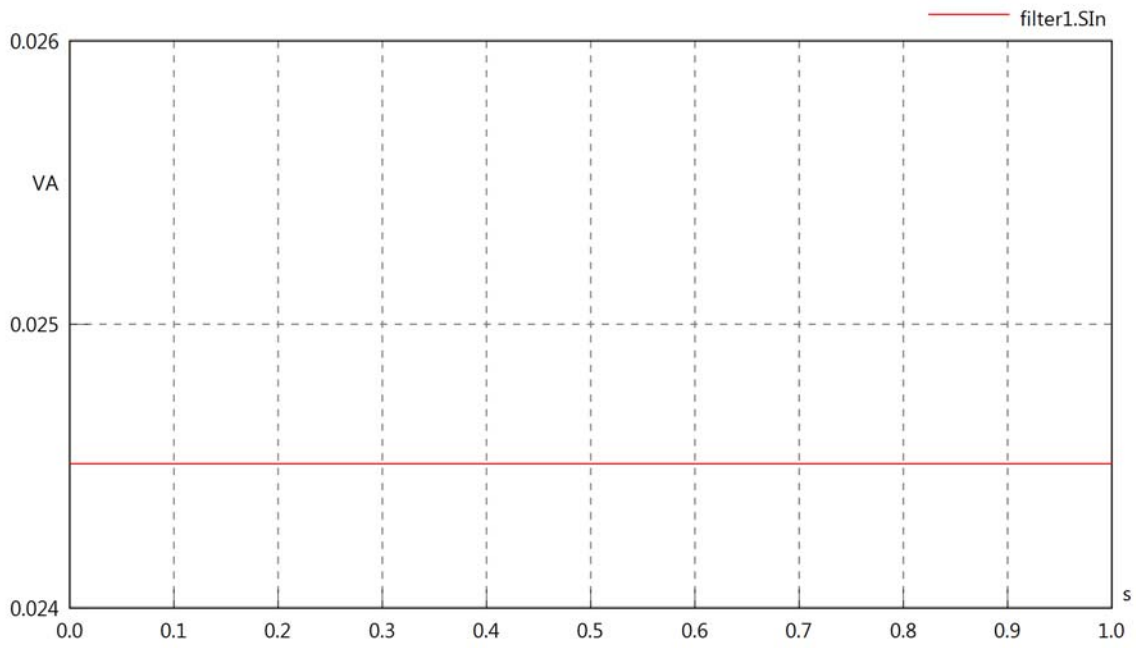

filter1.VrmsOut

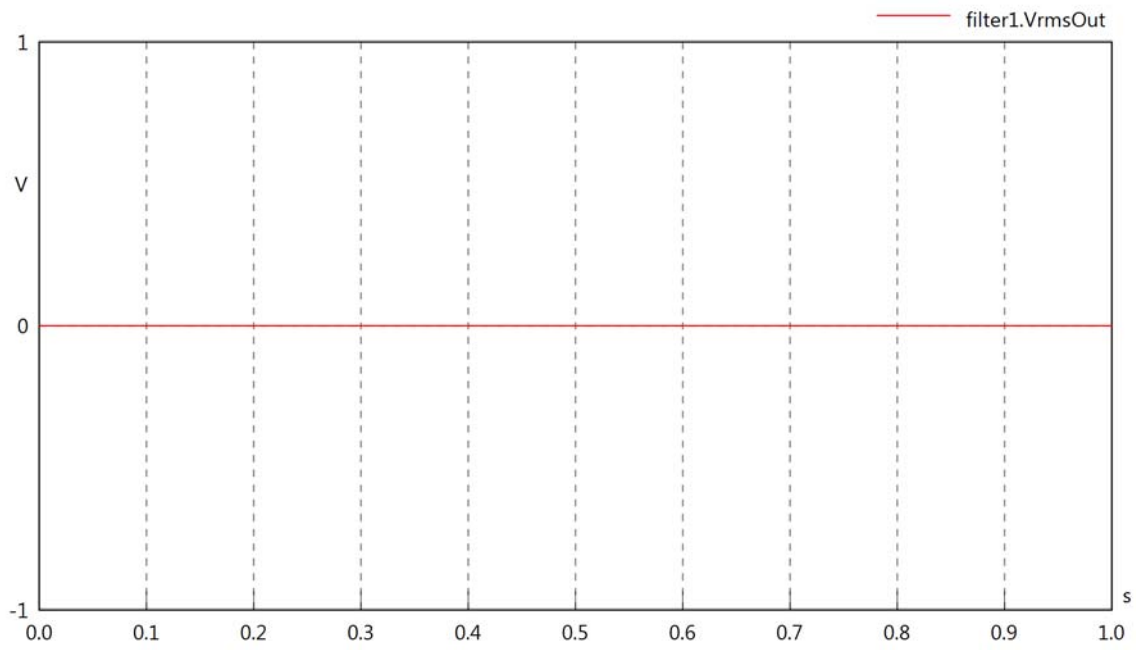

filter1.vReOut

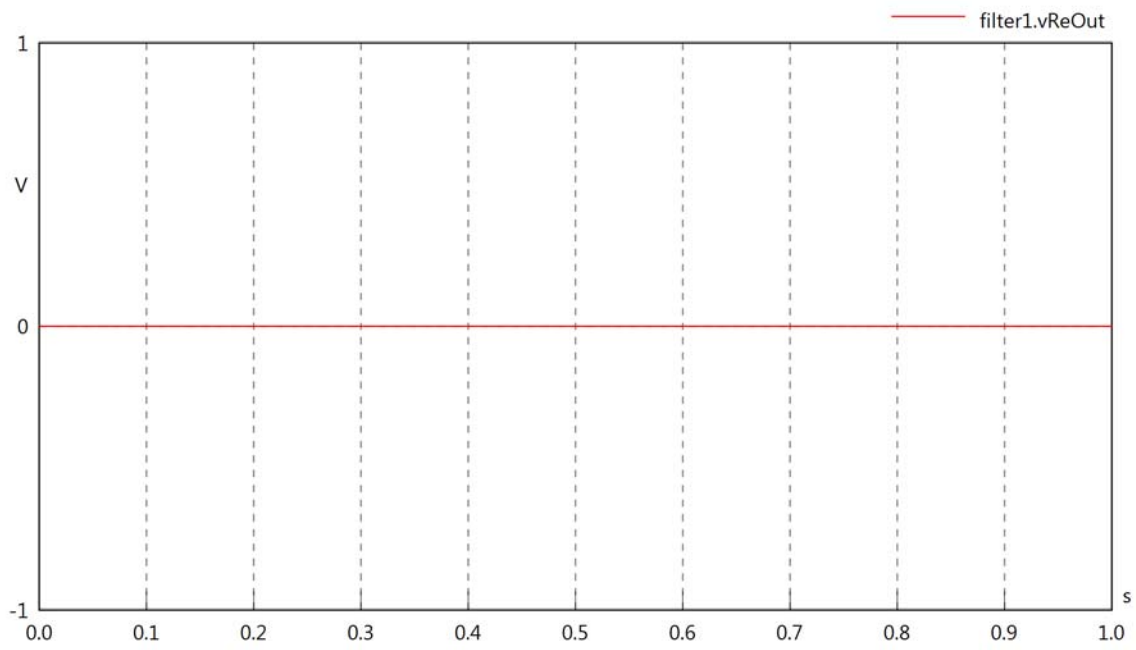

filter1.vImOut

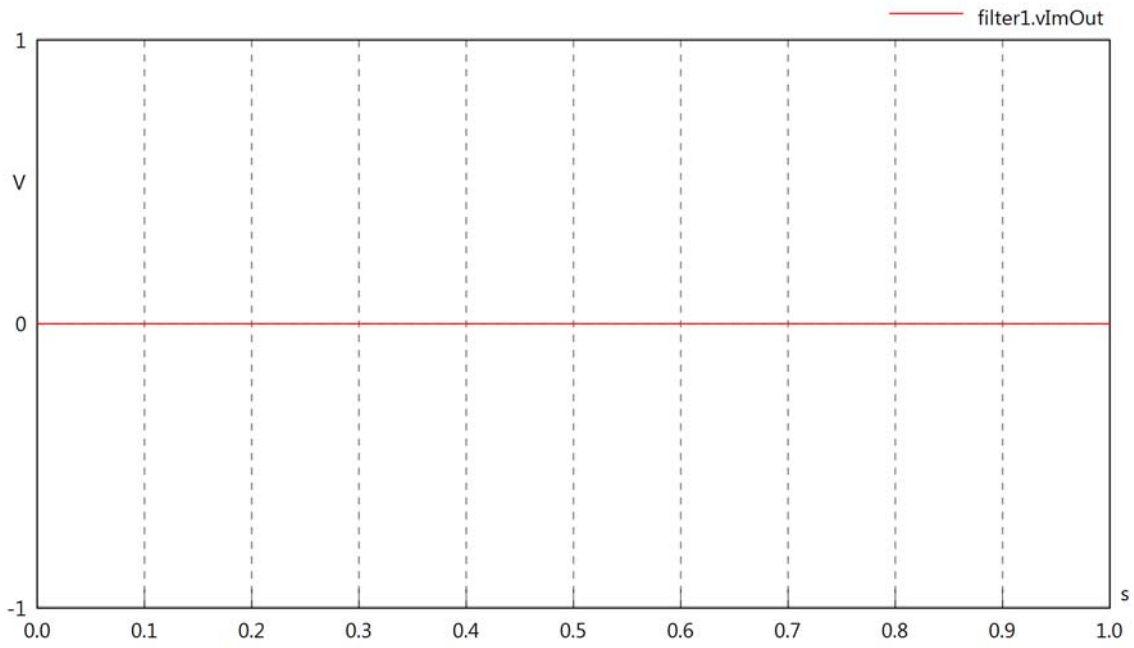

filter1.IrmsOut

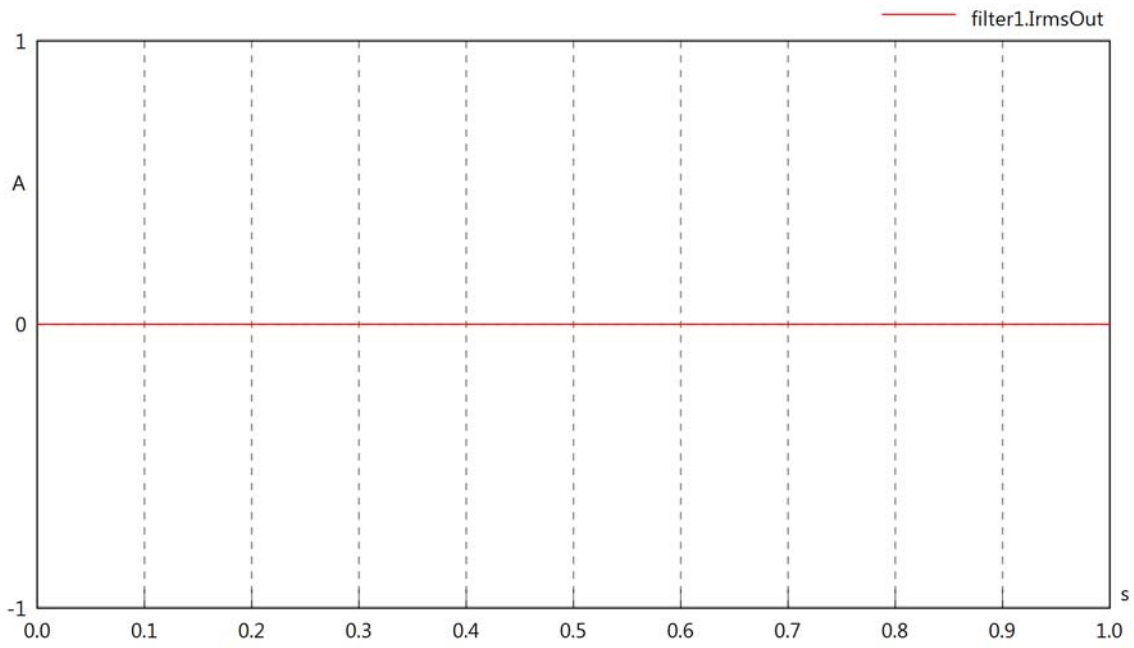

filter1.iReOut

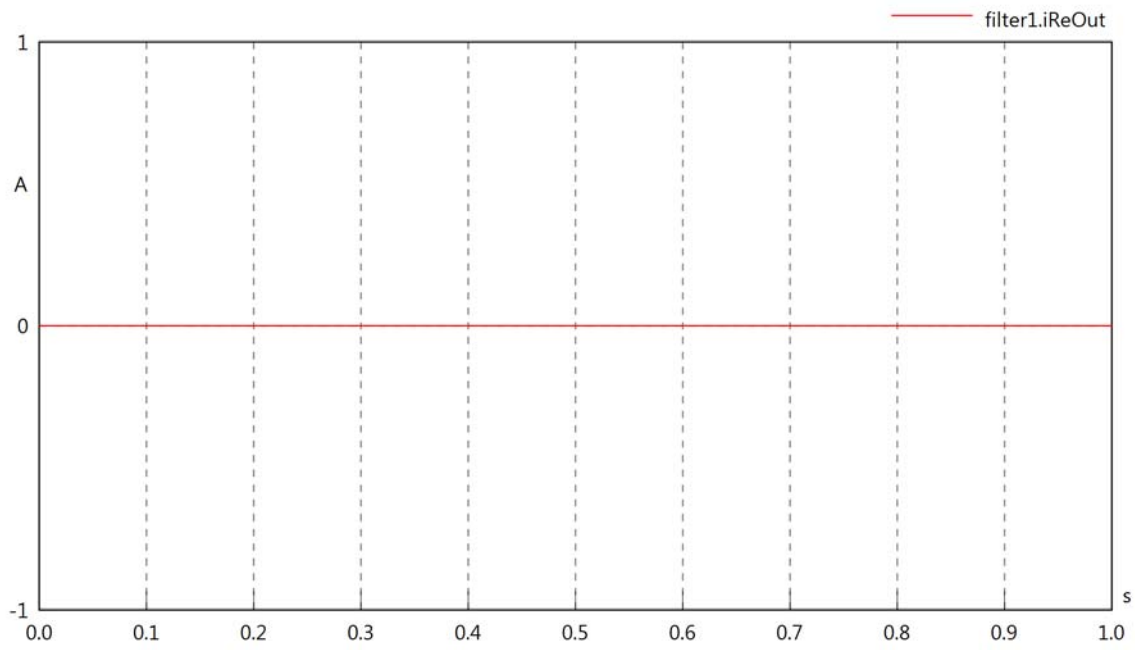

filter1.iImOut

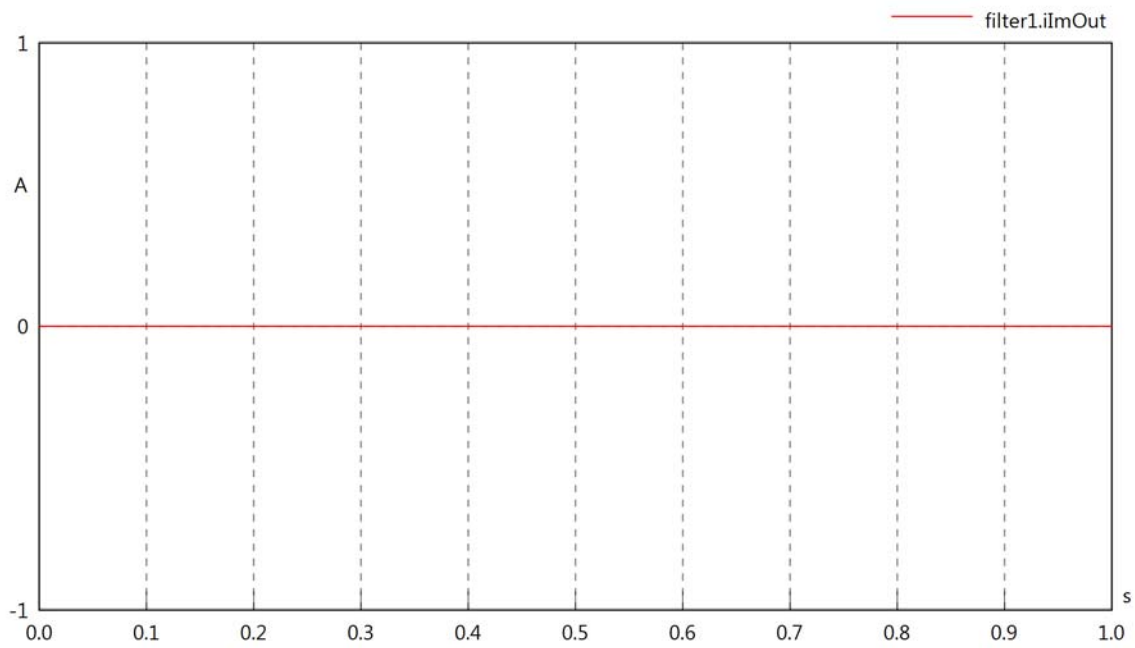

filter1.phiVOut

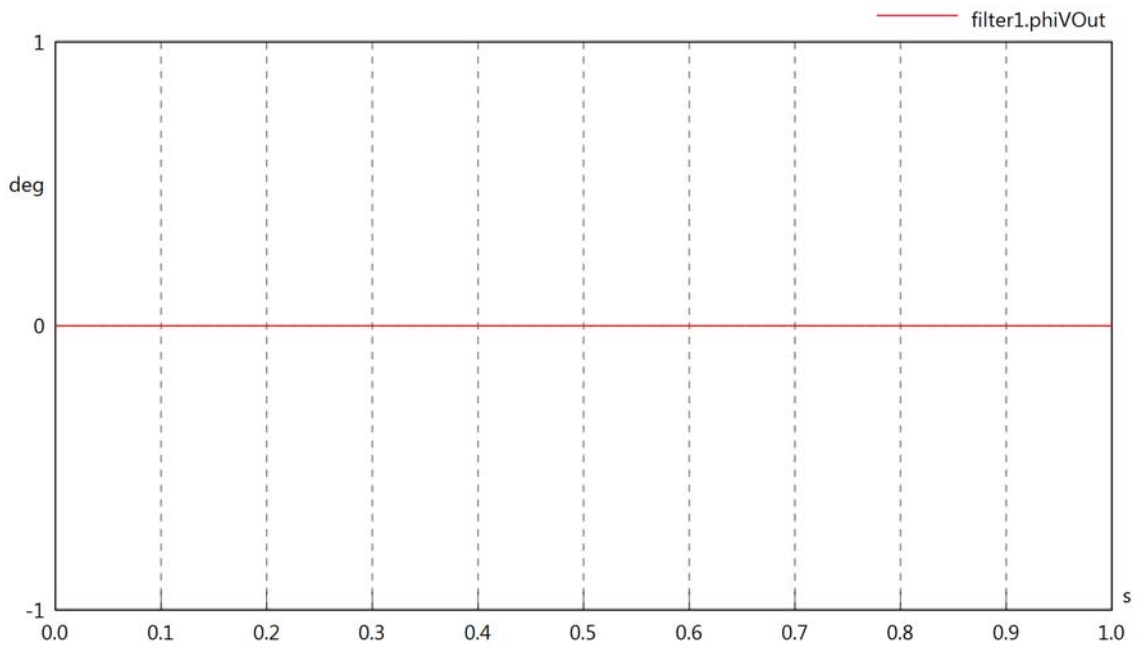

filter1.phiIOut

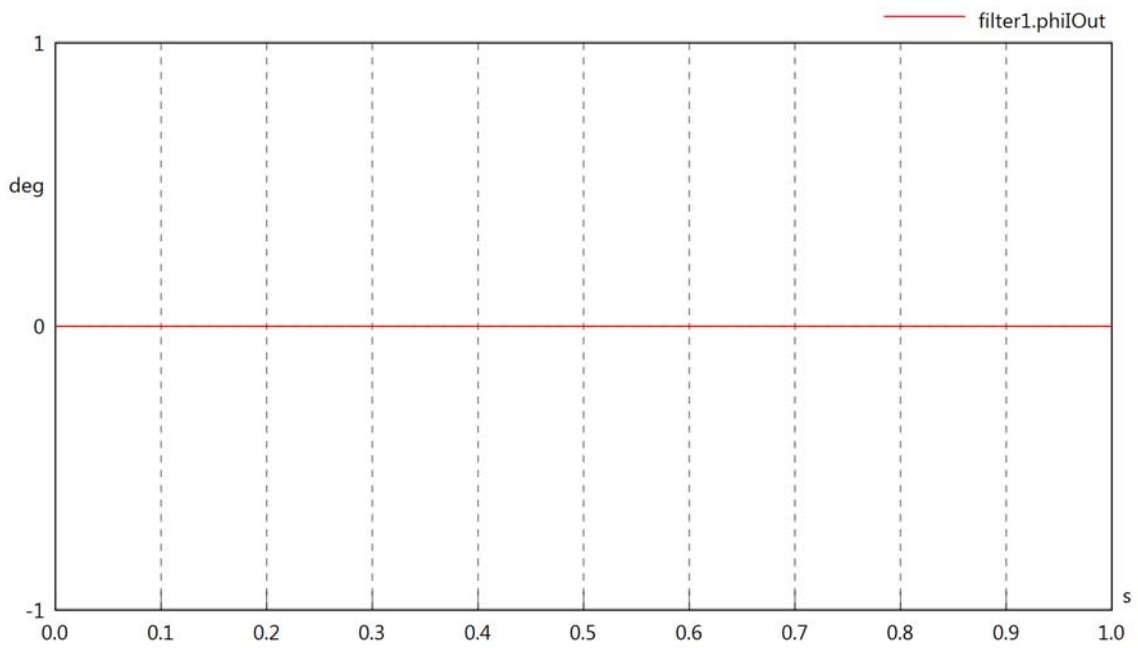

filter1.phiIVOut

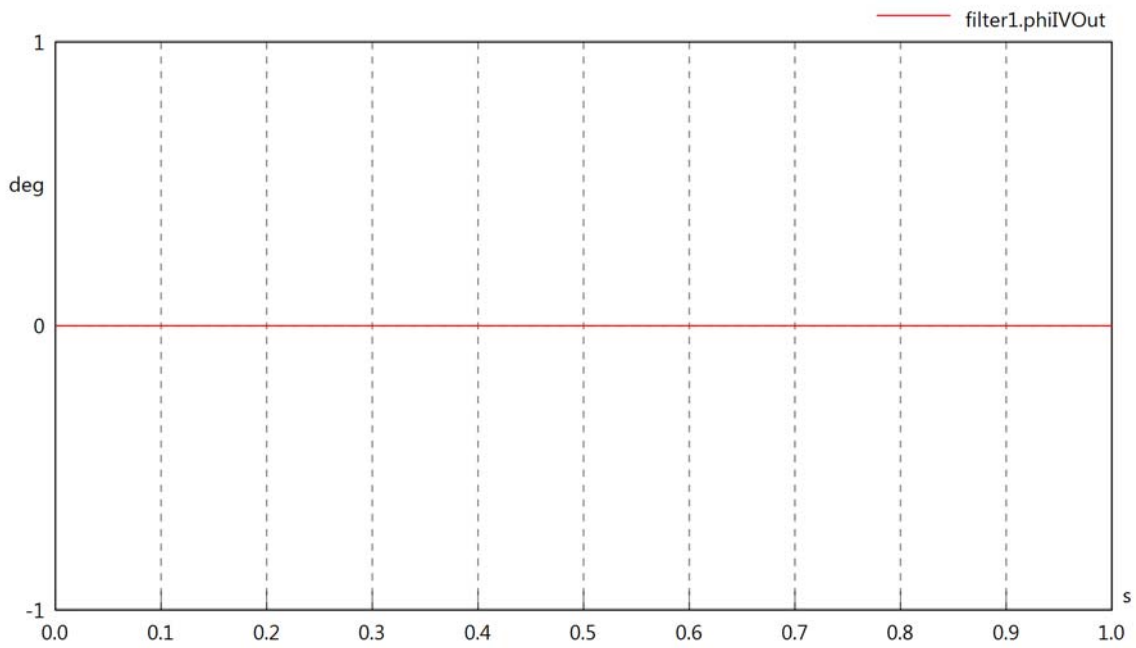

filter1.PReOut

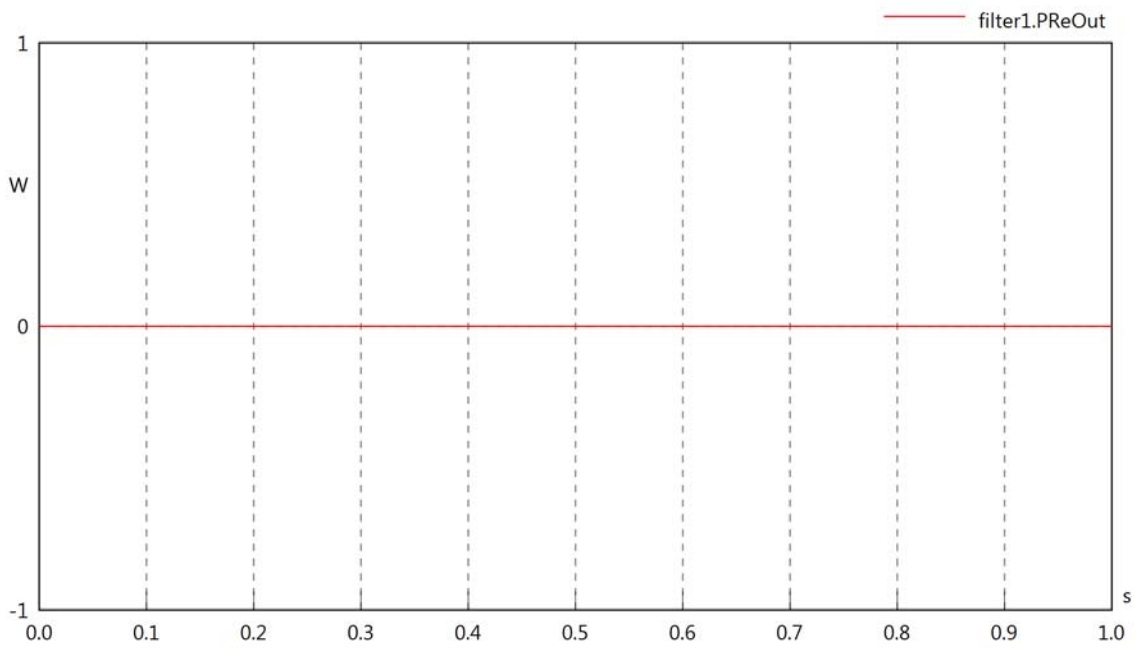

filter1.PImOut

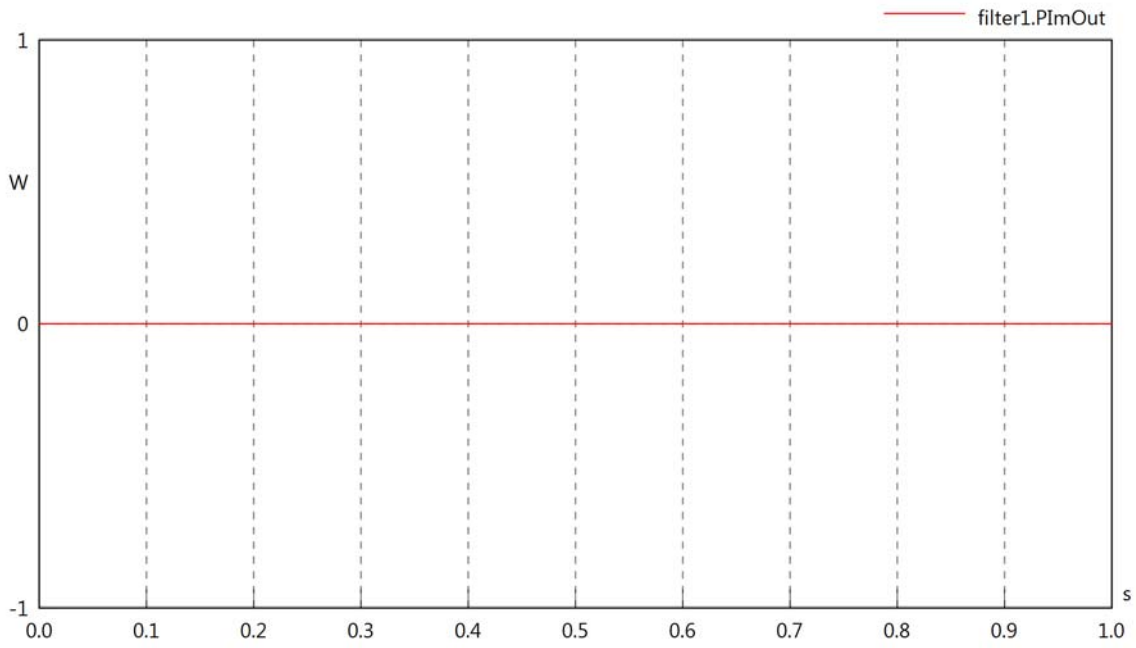

filter1.SOut

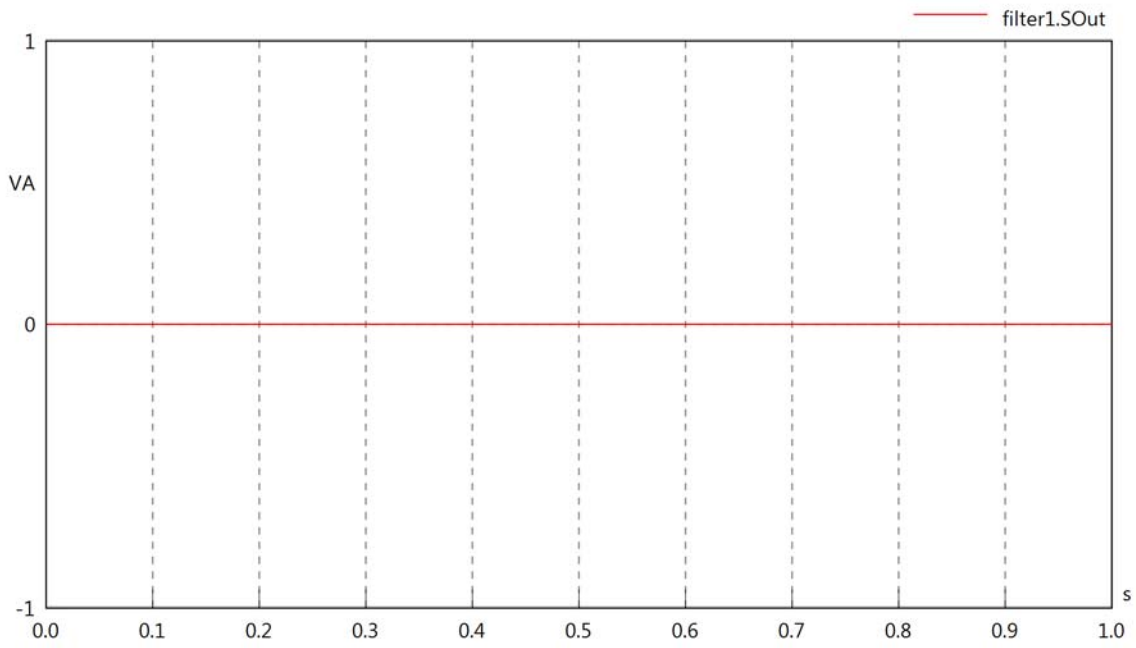
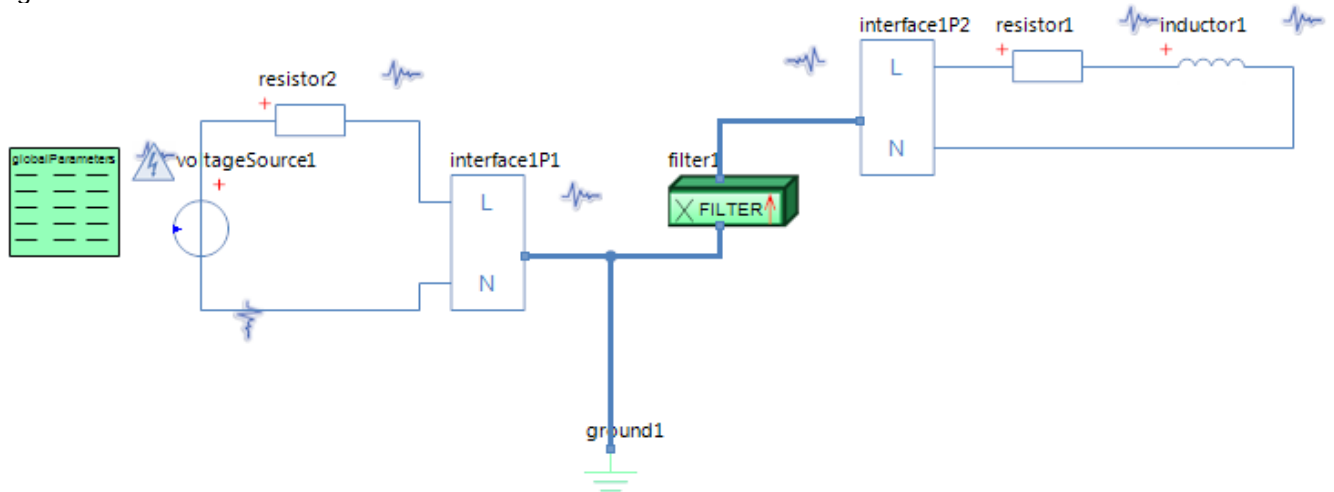

Diagram View



GlobalParameters globalParameters
Parameters

Comment	Name	Current Value	Unit
Type of Calculation	eCalculationKind	Signal Calculation	
Description of Frequency	eFrequencyKind	Linear	
Minimum Frequency	fMin	100	[kHz]
Maximum Frequency	fMax	100	[kHz]

Voltage Source voltageSource1
Parameters

Comment	Name	Current Value	Unit
Voltage RMS	VrmsSrc	5	[V]
Phase	phi	0	[deg]

Filter filter1
Parameters

Comment	Name	Current Value	Unit
Conductance between L1 and N Power side	G	1e-3	[1/Ohm]
EPU or Modem sending on system	sType	EPU sending	

Inductor inductor1
Parameters

Comment	Name	Current Value	Unit
Inductance	L	5	[mH]

Resistor resistor1
Parameters

Comment	Name	Current Value	Unit
Resistance	R	100	[Ohm]

Resistor resistor2
Parameters

Comment	Name	Current Value	Unit
Resistance	R	10	[Ohm]

filter1.VrmsIn

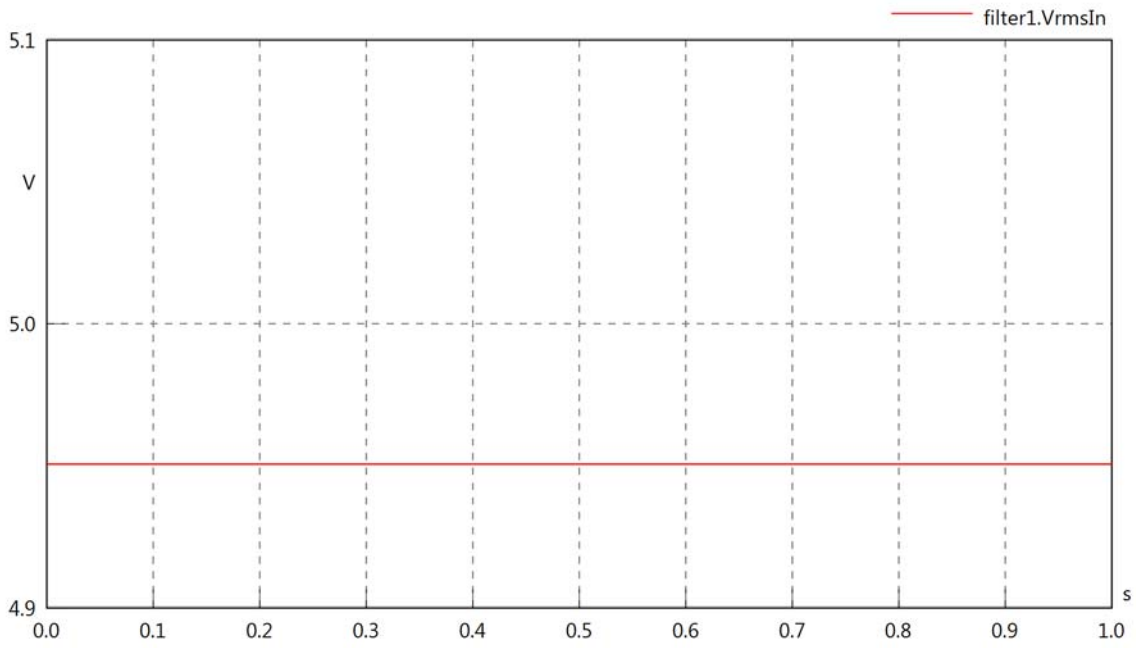

filter1.vReIn

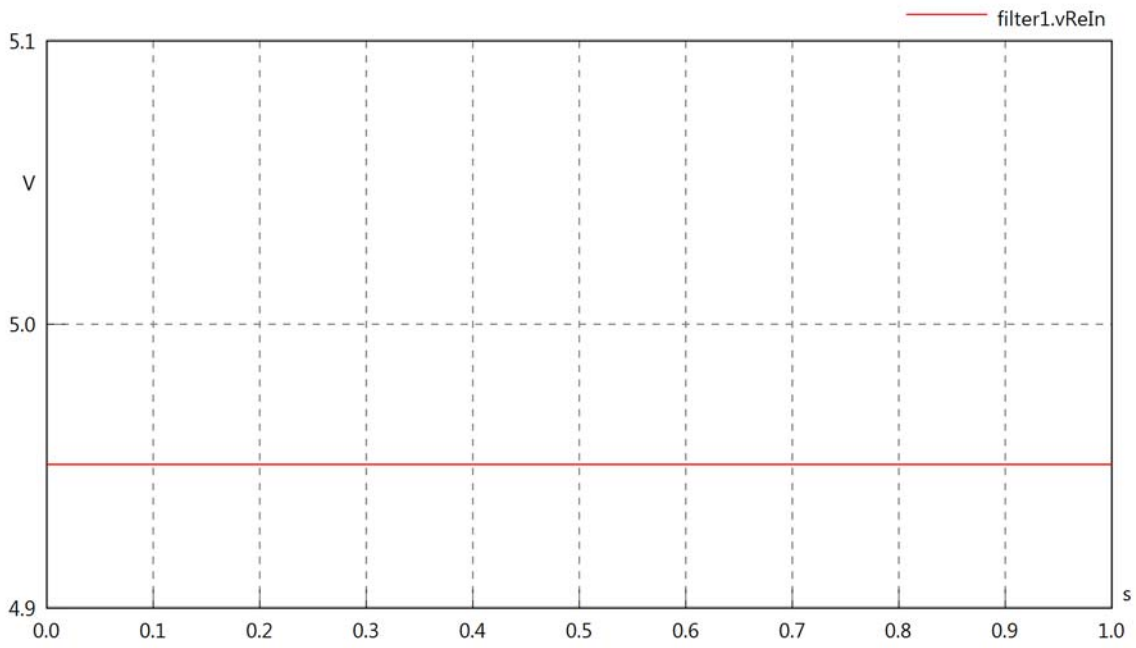

filter1.vImIn

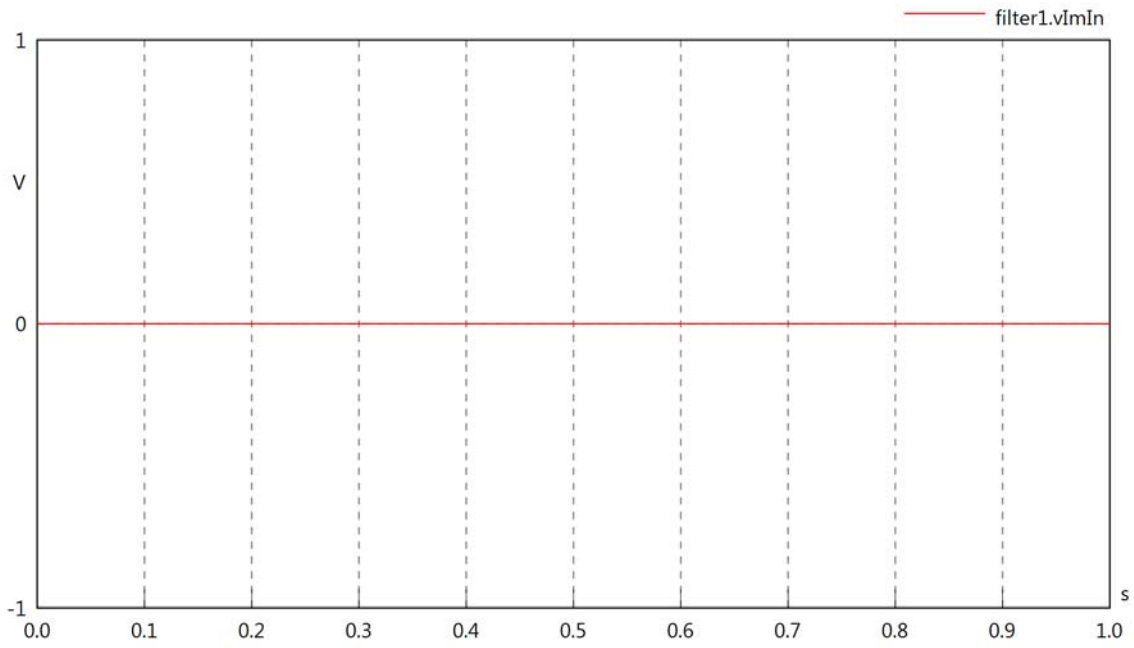

filter1.IrmsIn

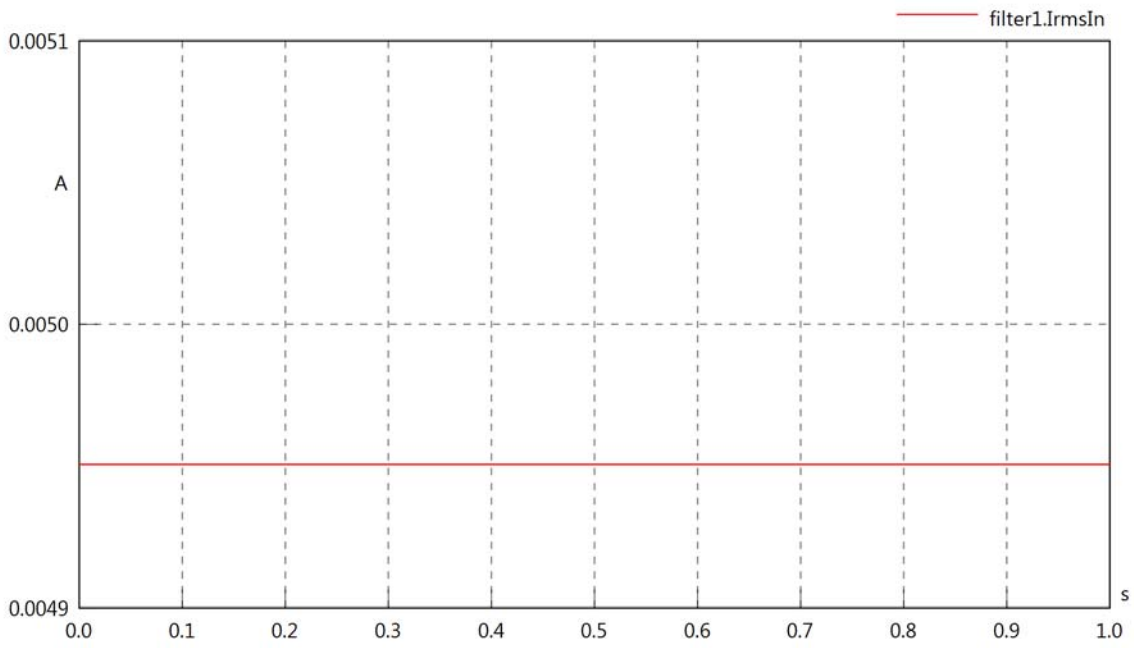

filter1.iReIn

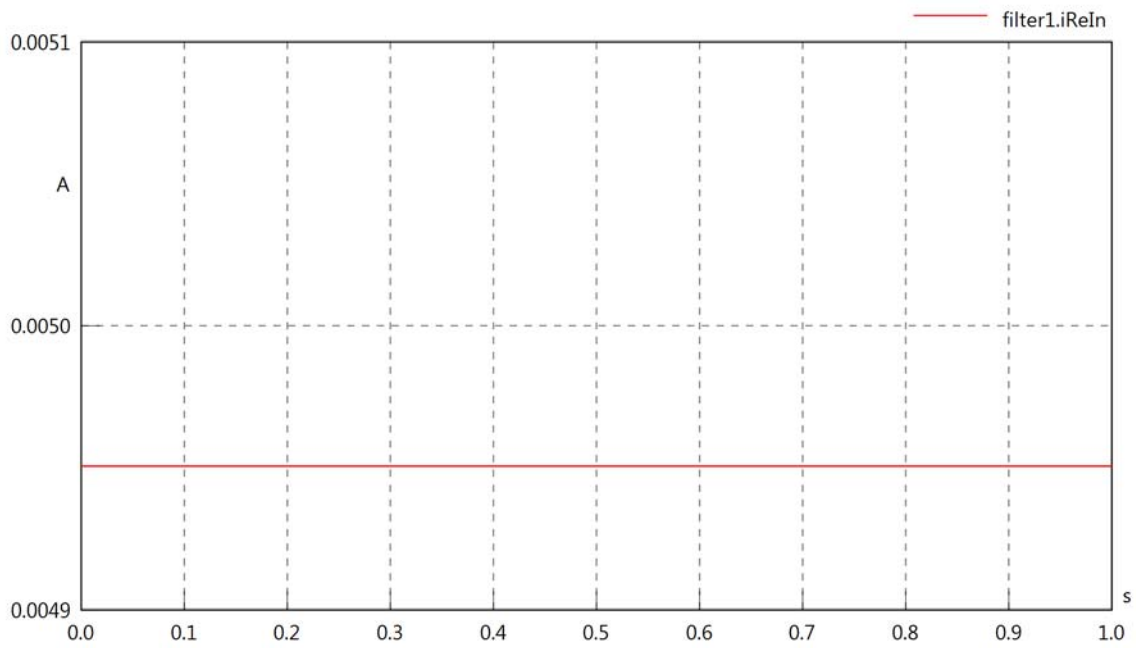

filter1.iImIn

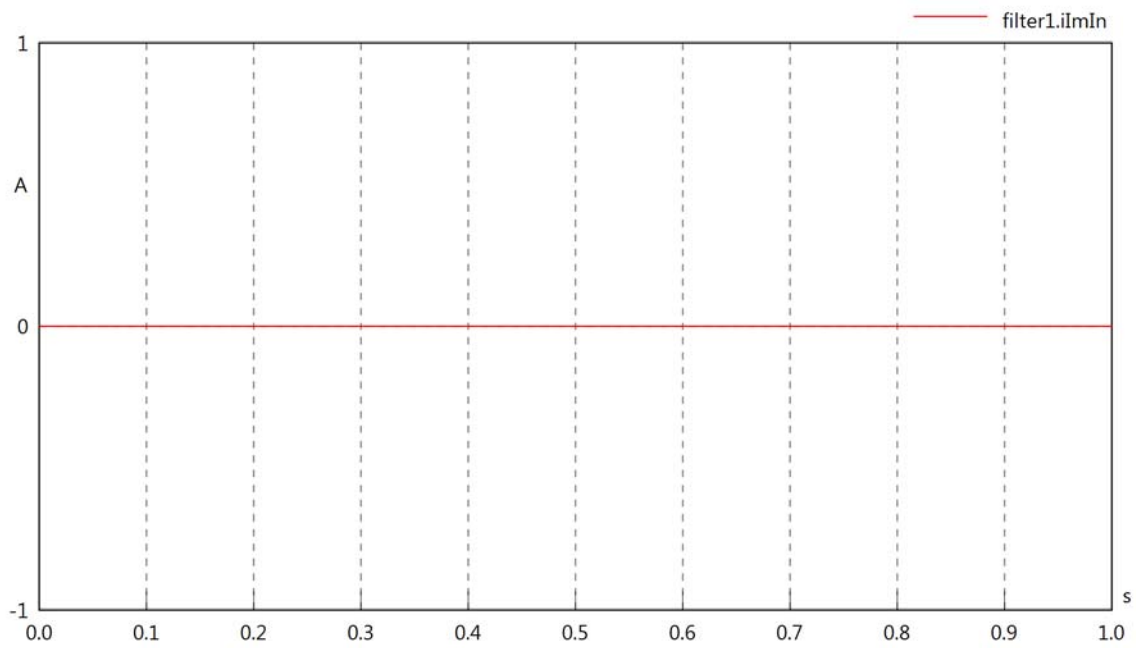

filter1.phiVIn

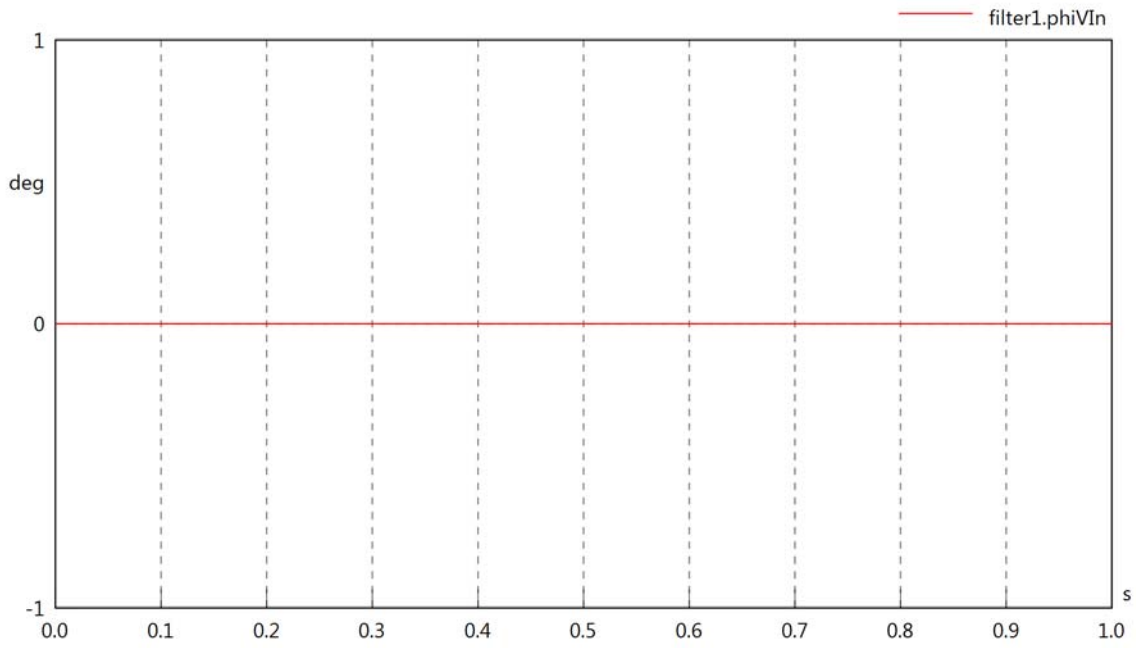

filter1.phiIn

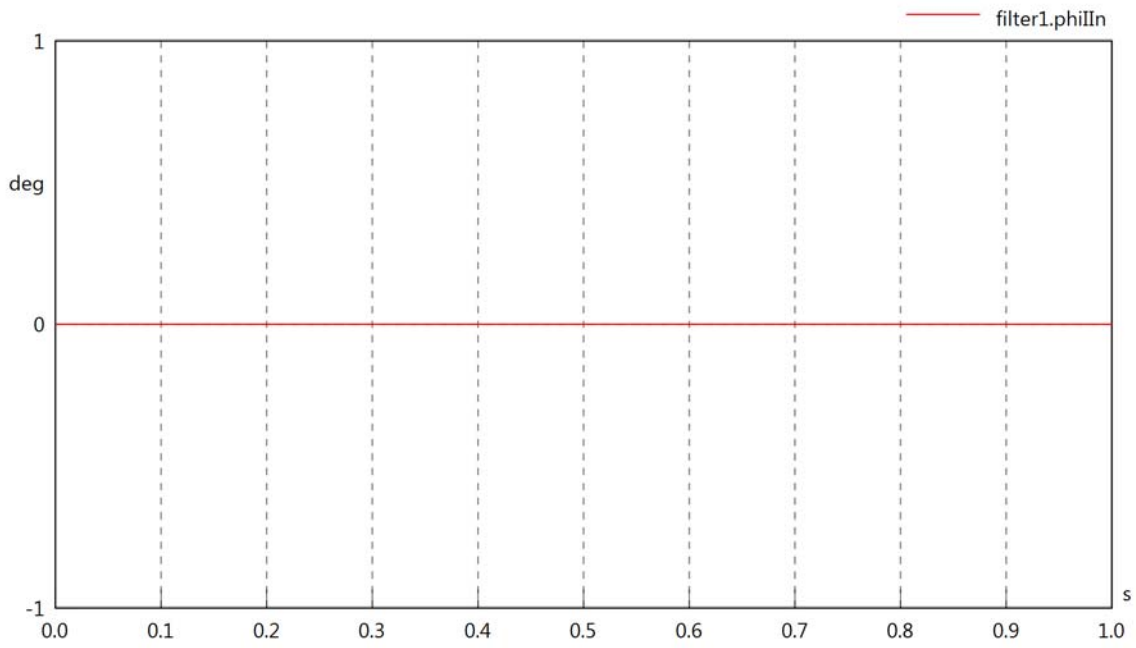

filter1.phiIVIn

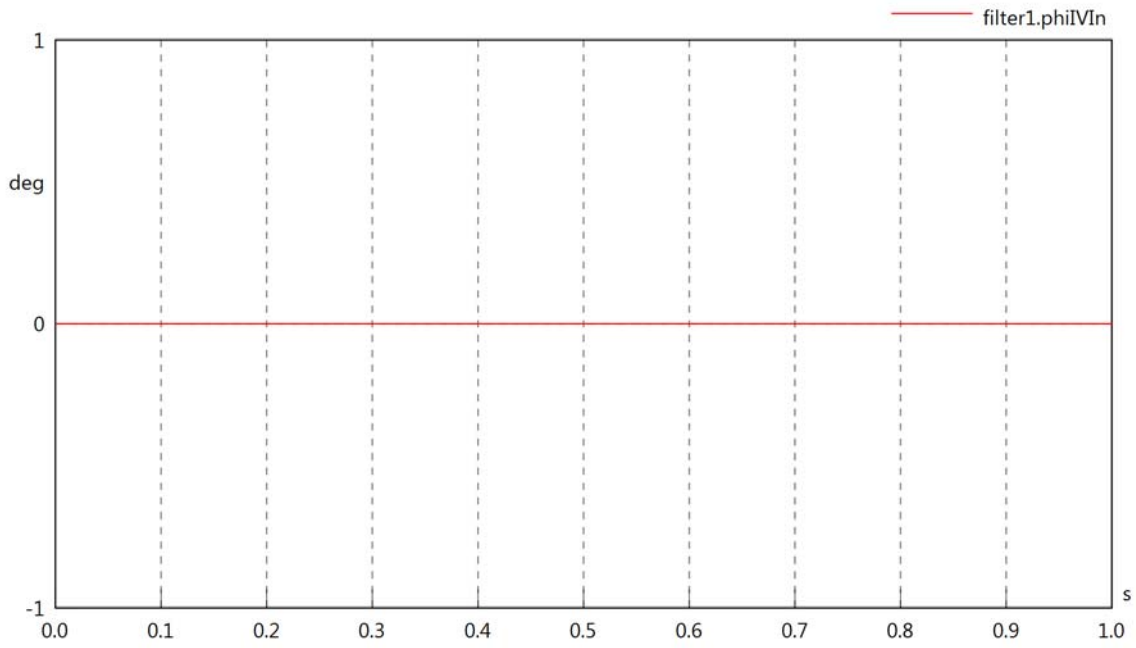

filter1.PReIn

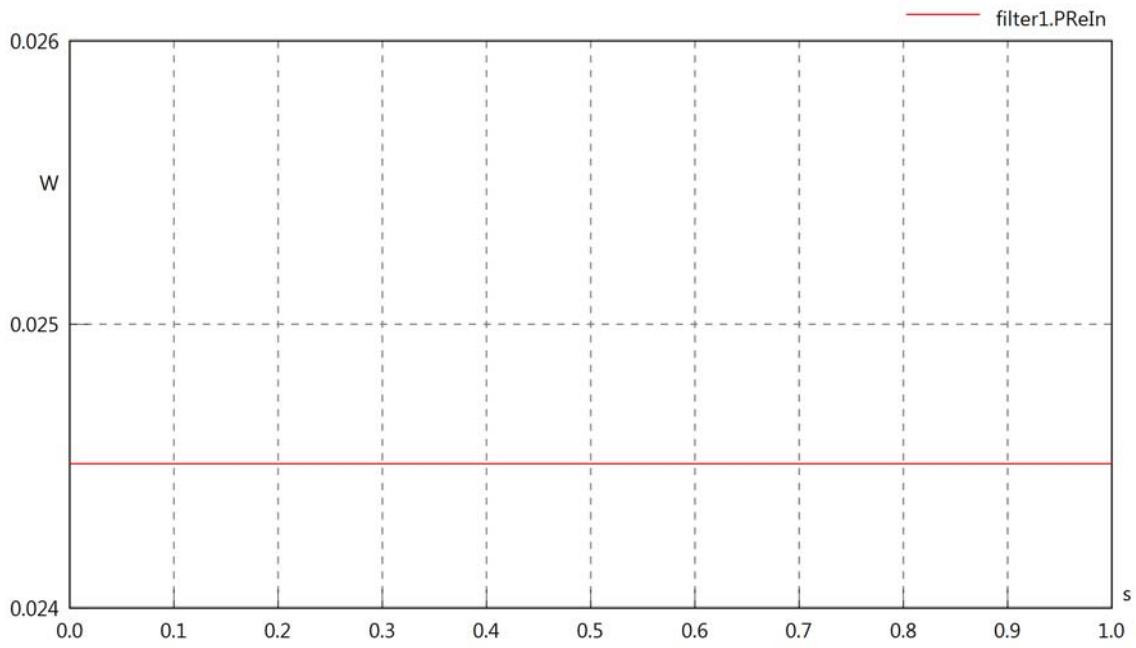

filter1.PImIn

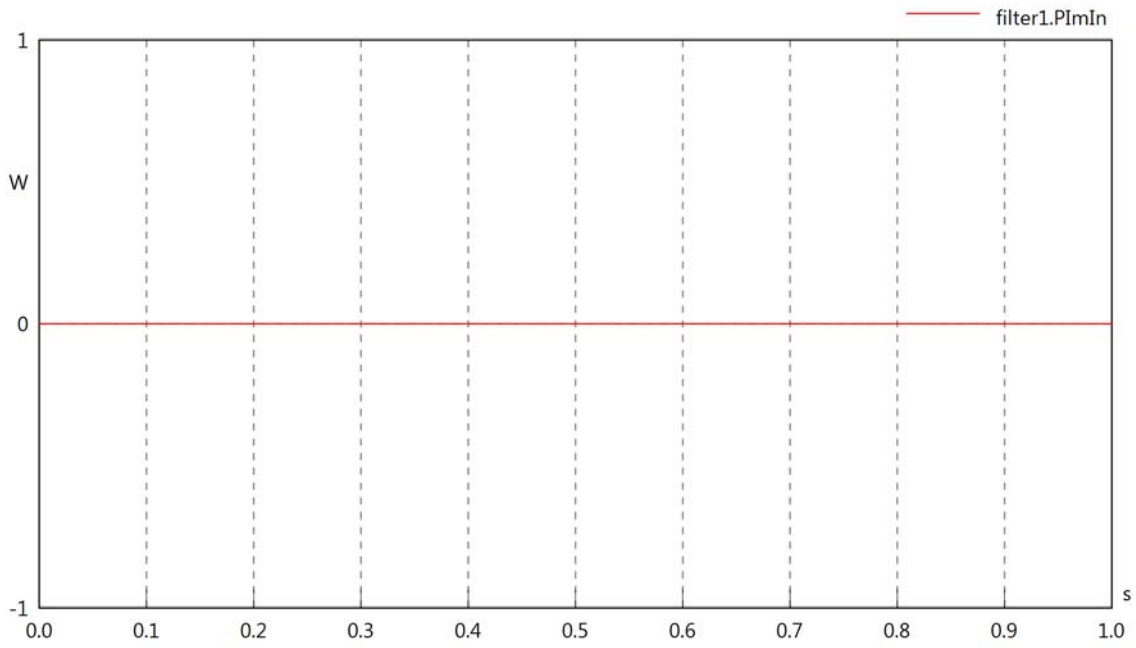

filter1.SIn

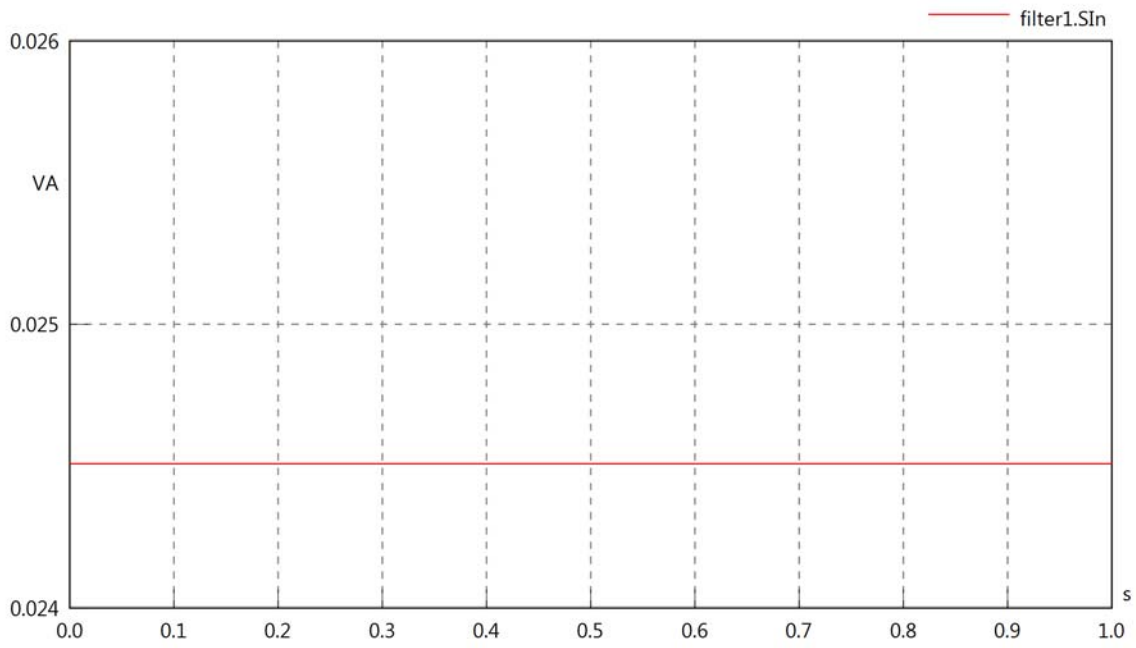

filter1.VrmsOut

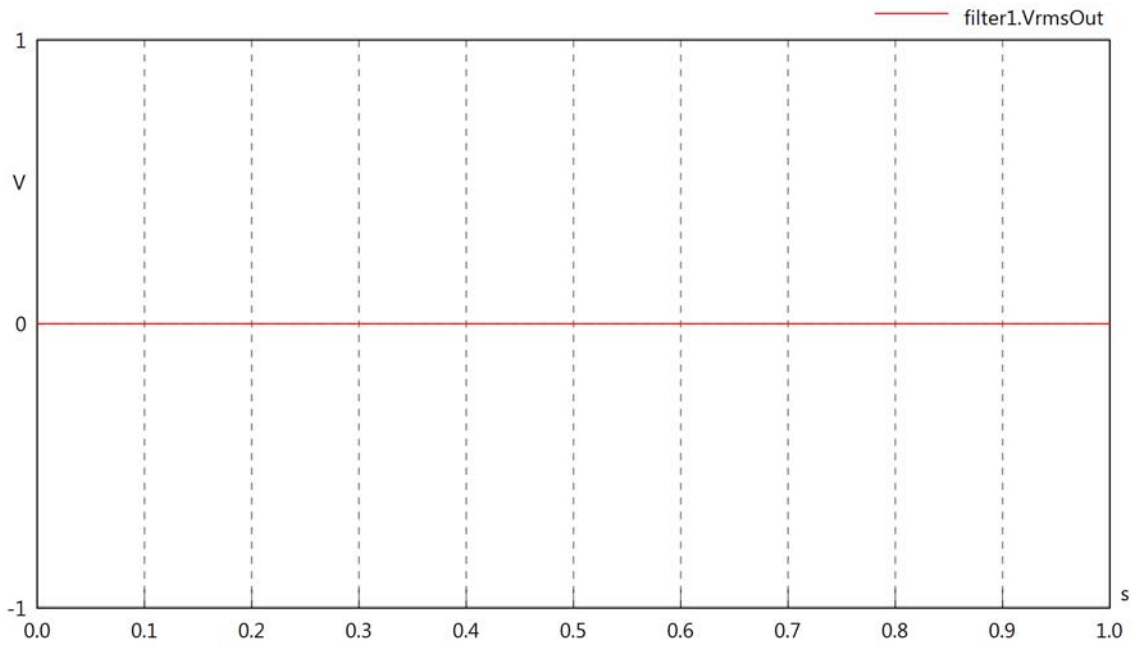

filter1.vReOut

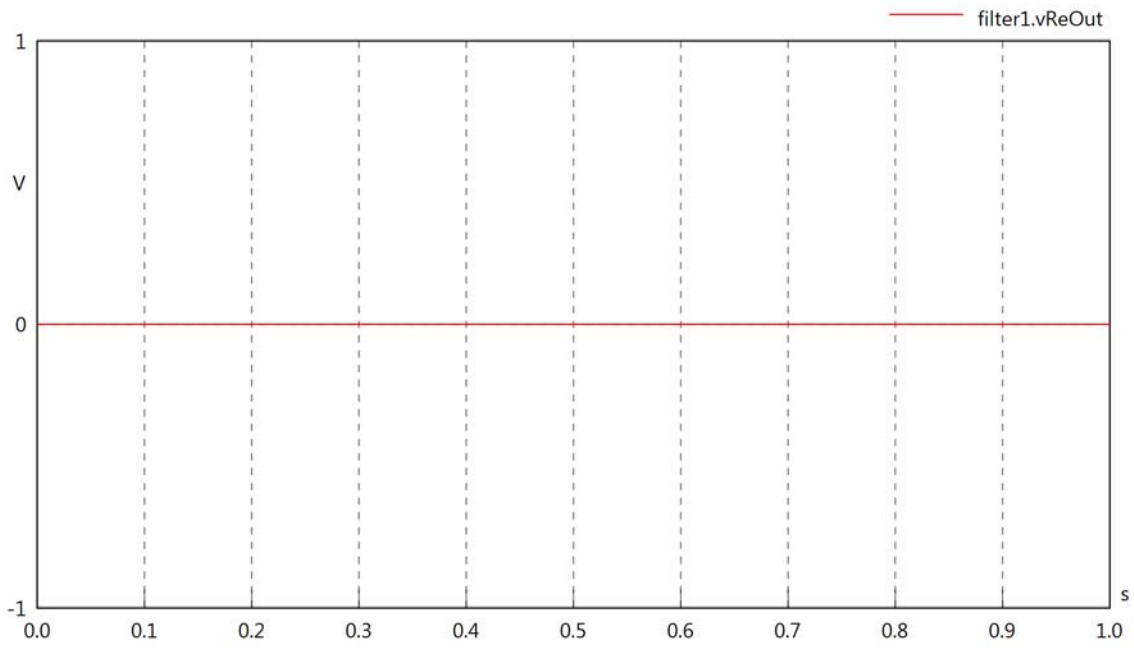

filter1.vImOut

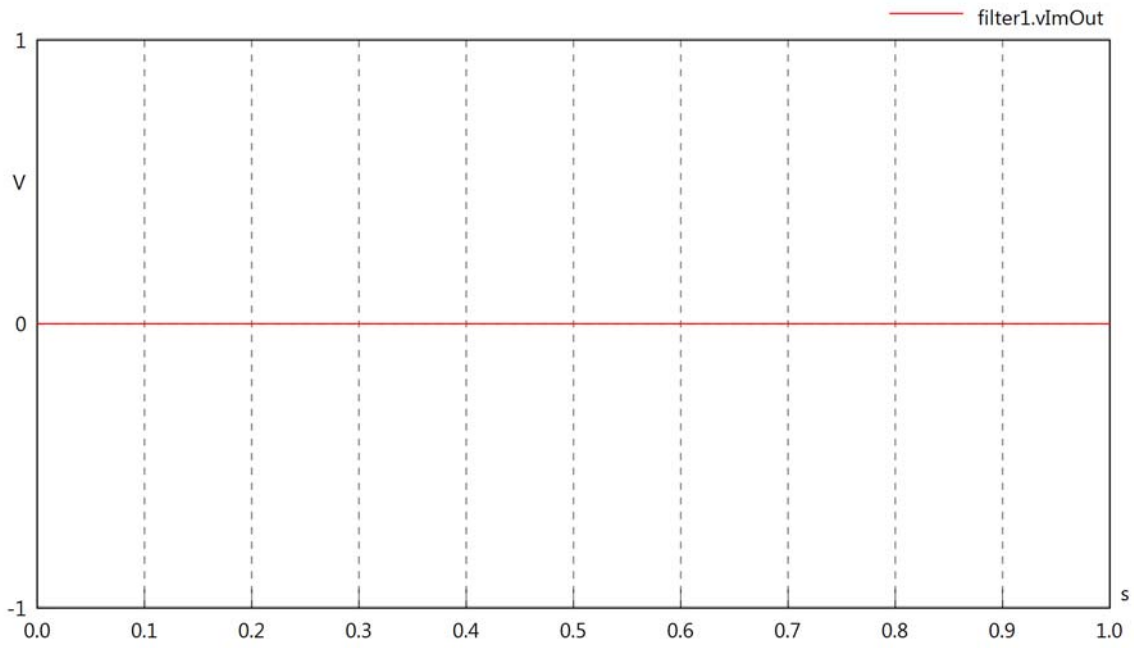

filter1.IrmsOut

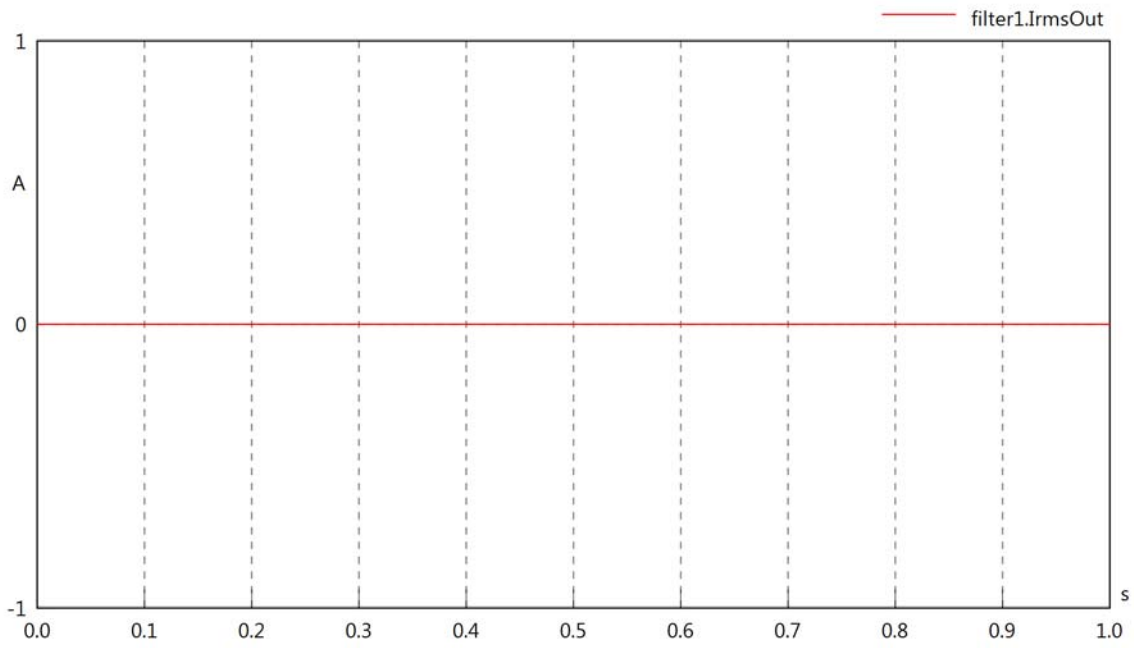

filter1.iReOut

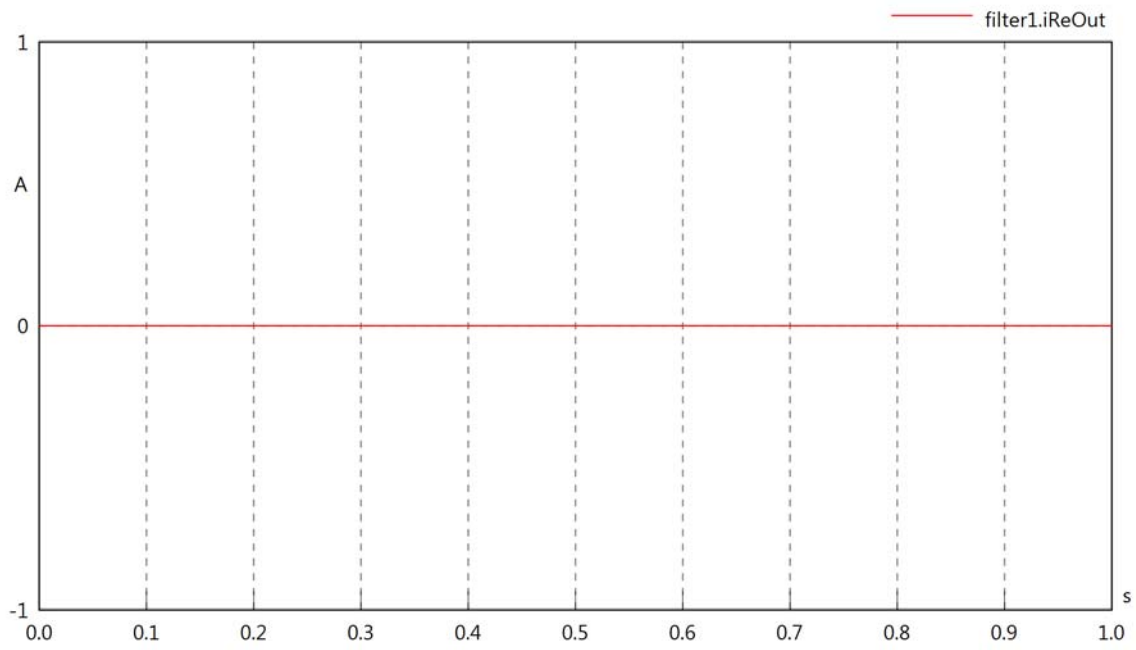

filter1.iImOut

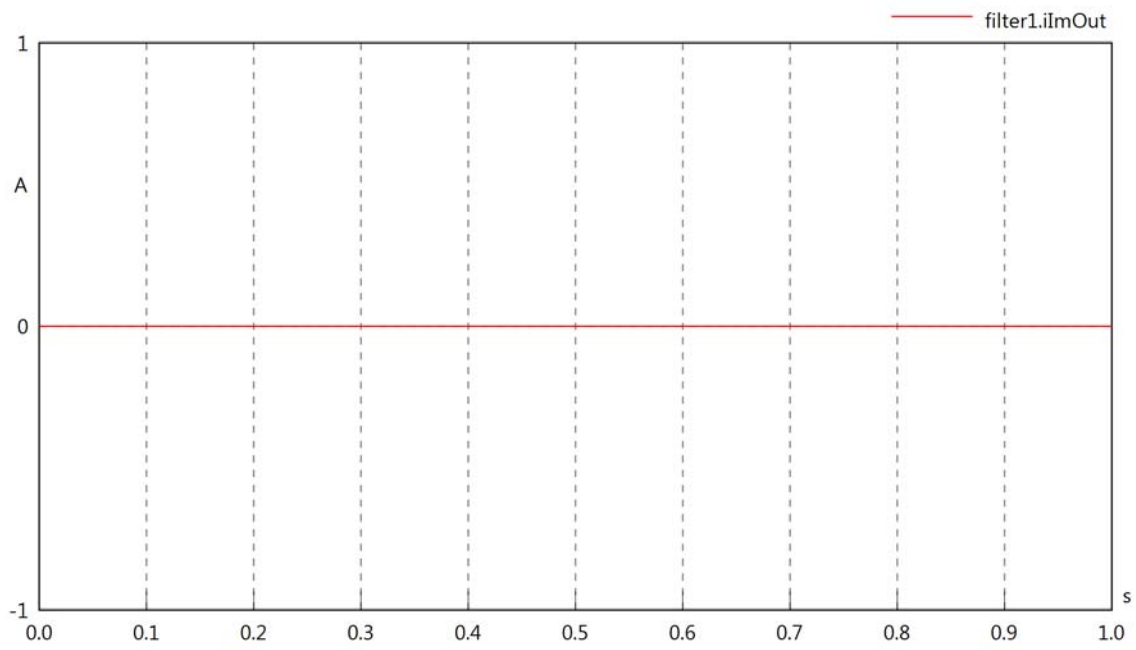

filter1.phiVOut

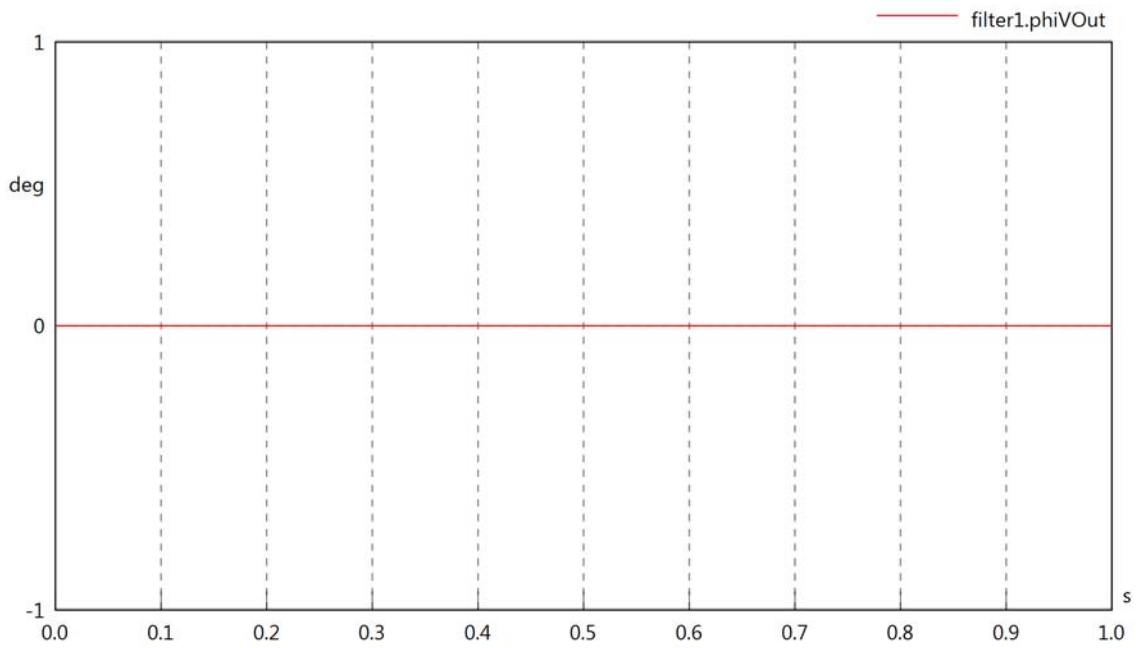

filter1.phiIOut

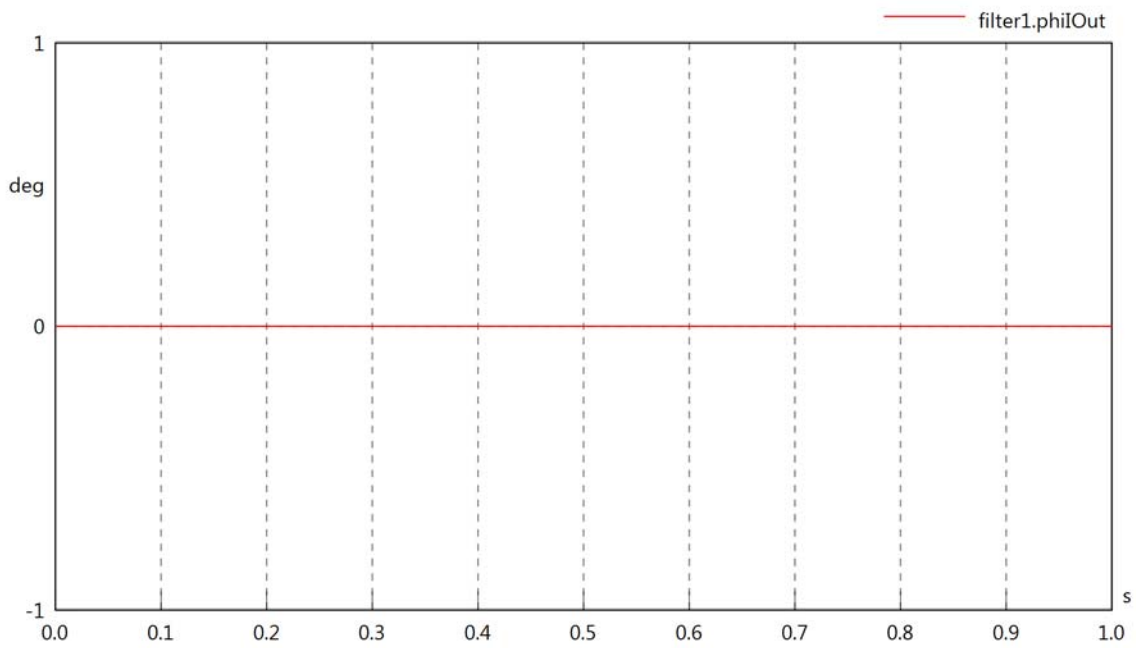

filter1.phiIVOut

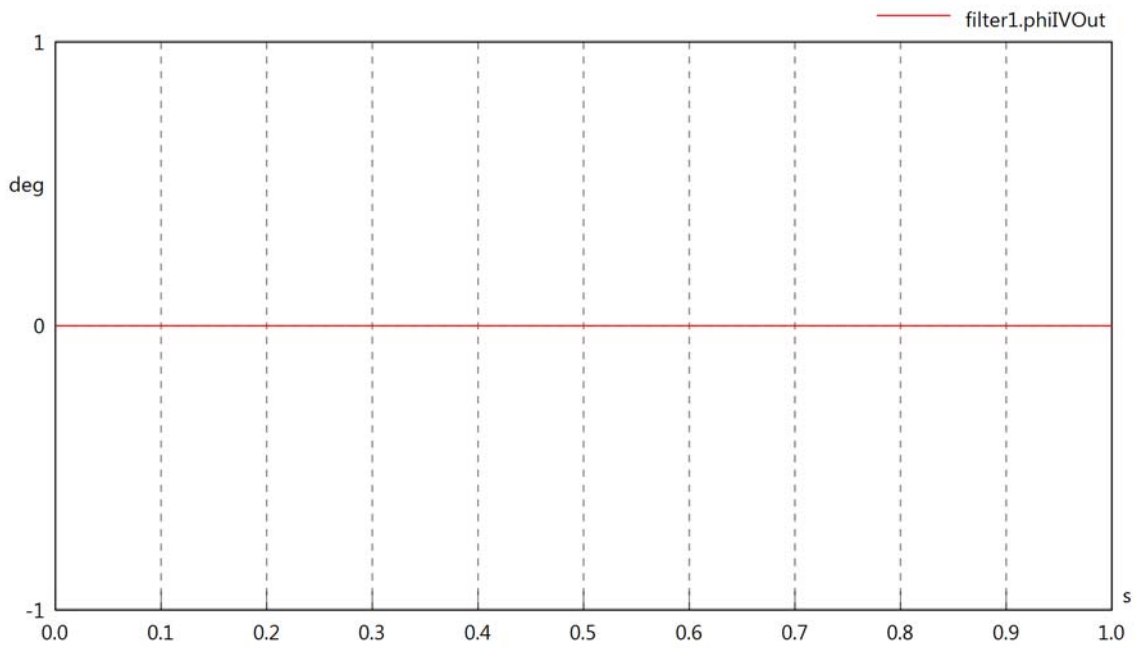

filter1.PReOut

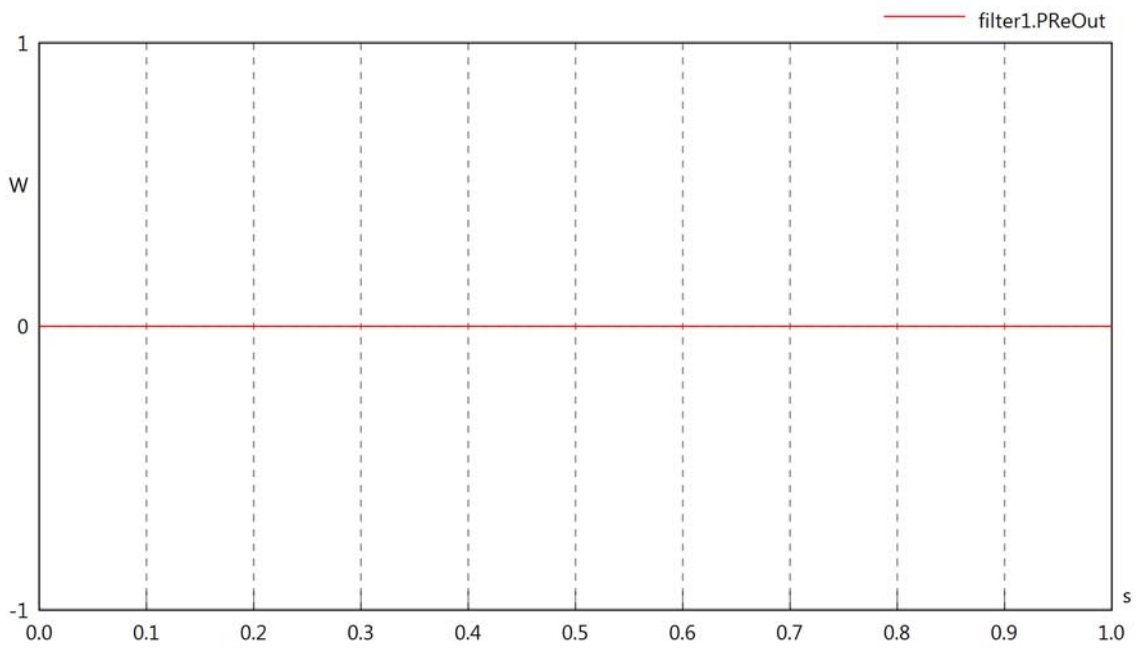

filter1.PImOut

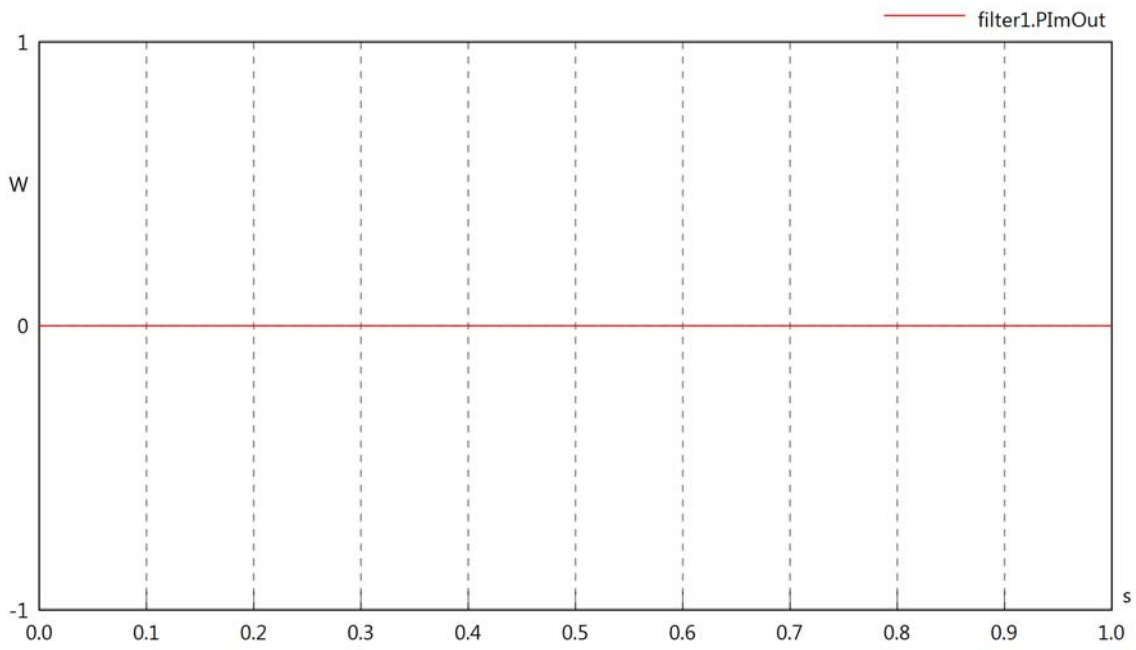

filter1.SOut

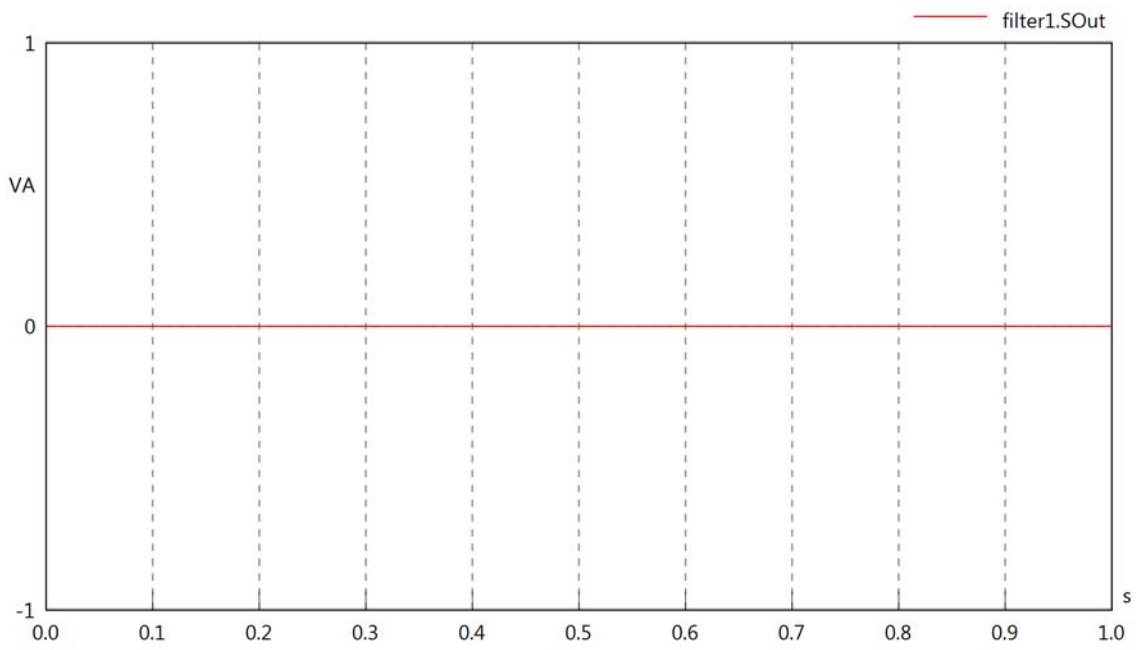
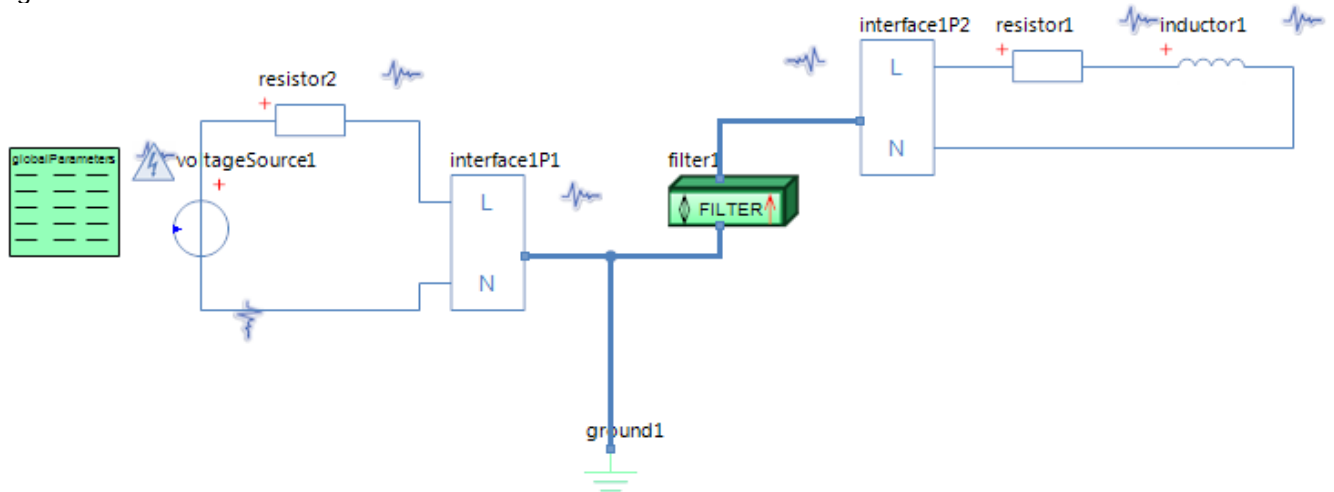

Diagram View



GlobalParameters globalParameters
Parameters

Comment	Name	Current Value	Unit
Type of Calculation	eCalculationKind	Signal Calculation	
Description of Frequency	eFrequencyKind	Linear	
Minimum Frequency	fMin	60	[Hz]
Maximum Frequency	fMax	60	[Hz]

Voltage Source voltageSource1
Parameters

Comment	Name	Current Value	Unit
Voltage RMS	VrmsSrc	5	[V]
Phase	phi	0	[deg]

Filter filter1
Parameters

Comment	Name	Current Value	Unit
Conductance between L1 and N Power side	G	1e-3	[1/Ohm]
EPU or Modem sending on system	sType	Modem sending	

Inductor inductor1
Parameters

Comment	Name	Current Value	Unit
Inductance	L	5	[mH]

Resistor resistor1
Parameters

Comment	Name	Current Value	Unit
Resistance	R	100	[Ohm]

Resistor resistor2
Parameters

Comment	Name	Current Value	Unit
Resistance	R	10	[Ohm]

filter1.VrmsIn

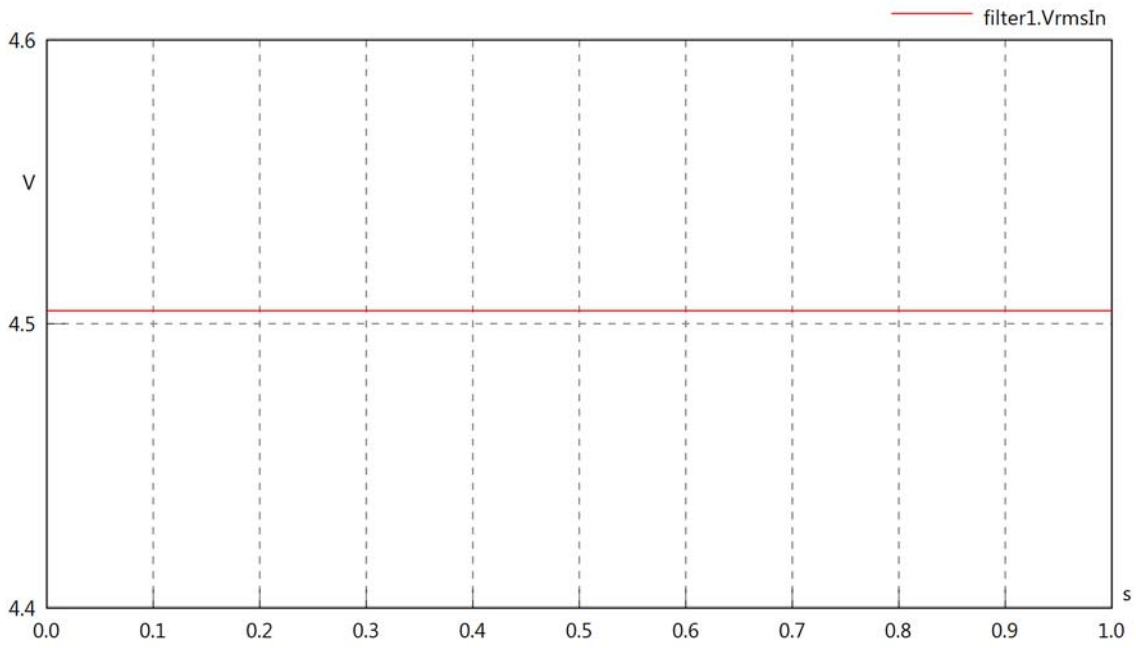

filter1.vReIn

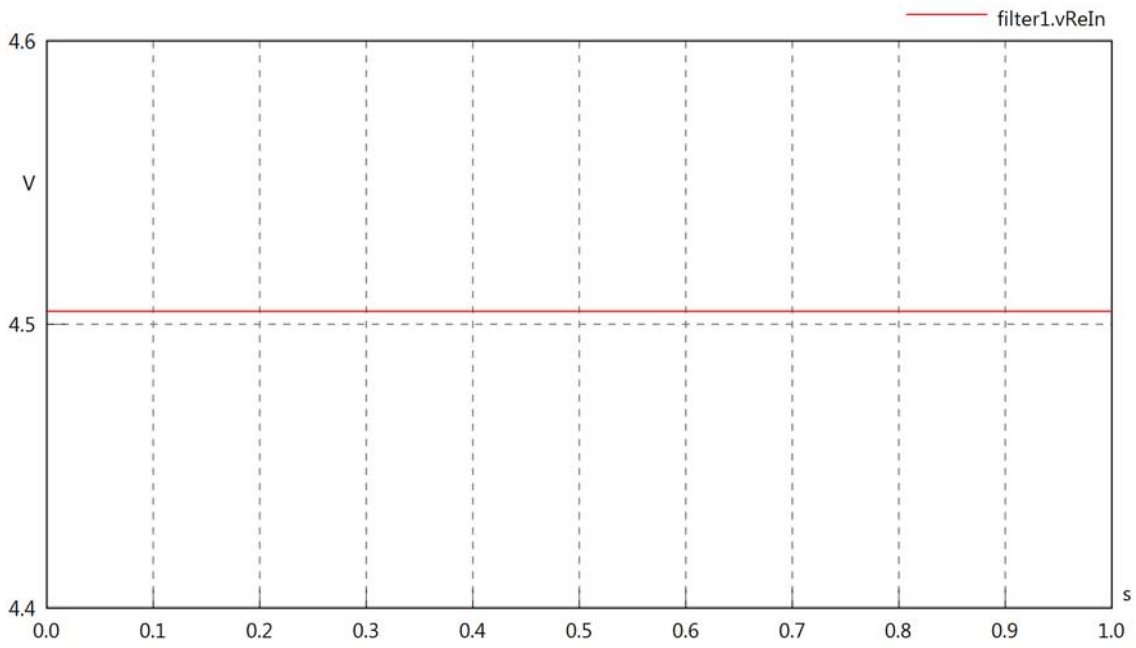

filter1.vImIn

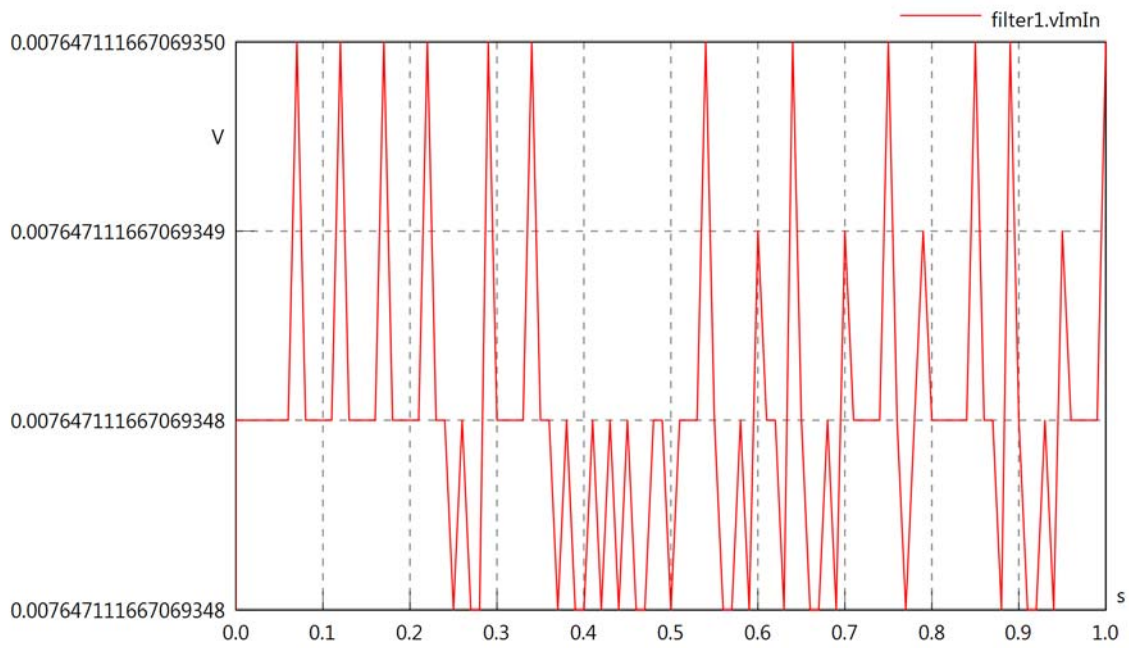

filter1.IrmsIn

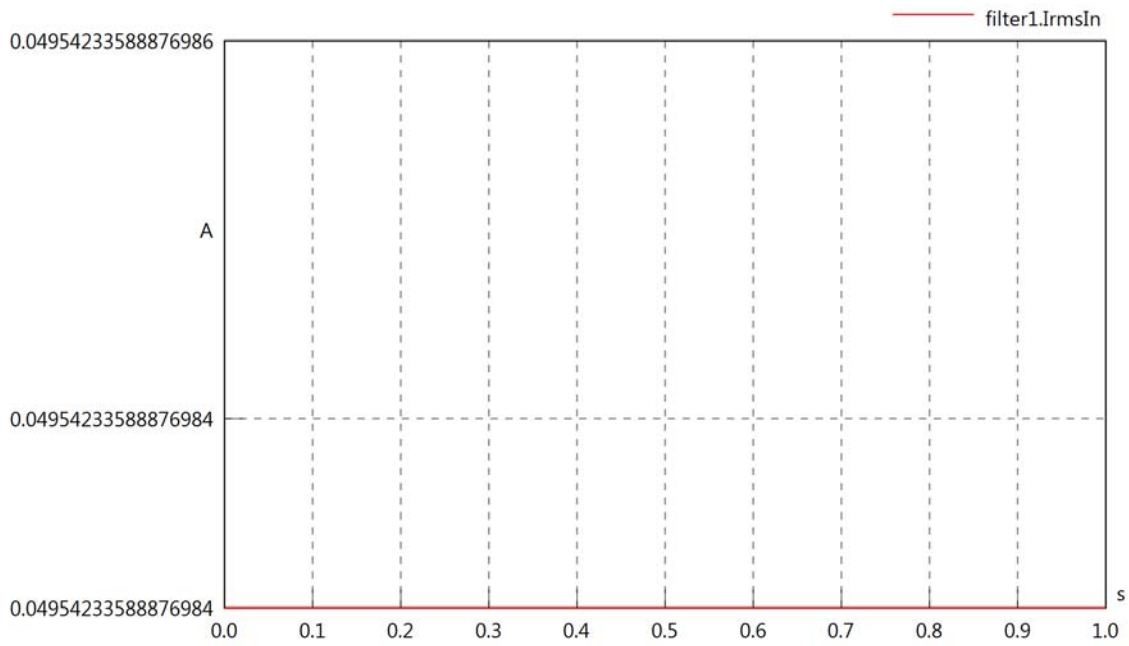

filter1.iReIn

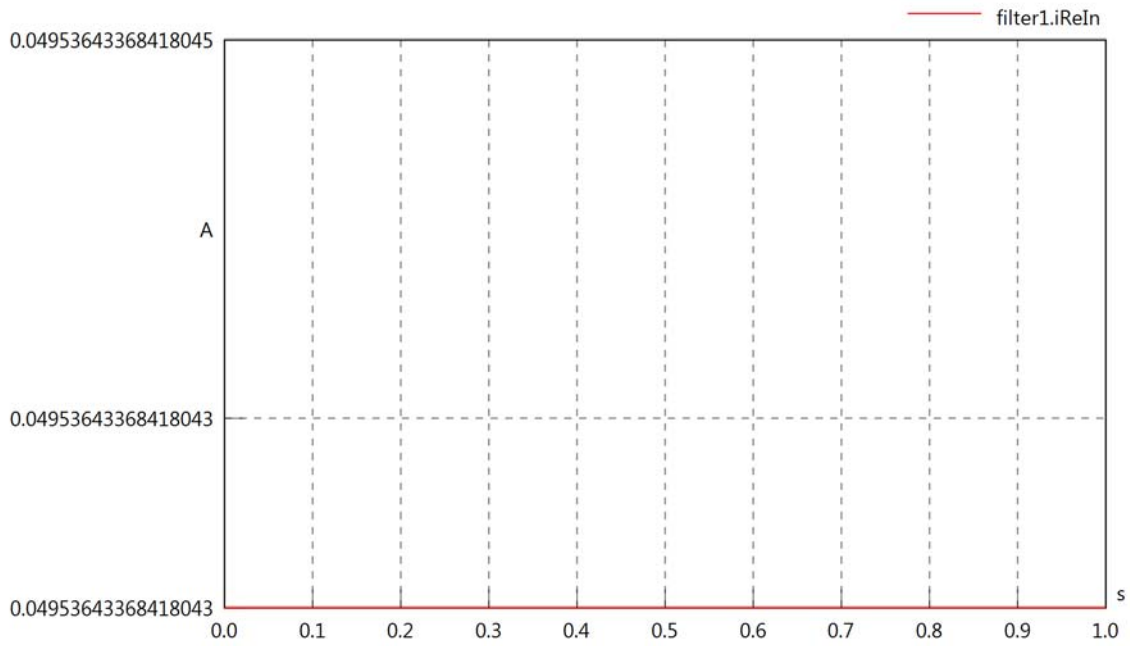

filter1.iImIn

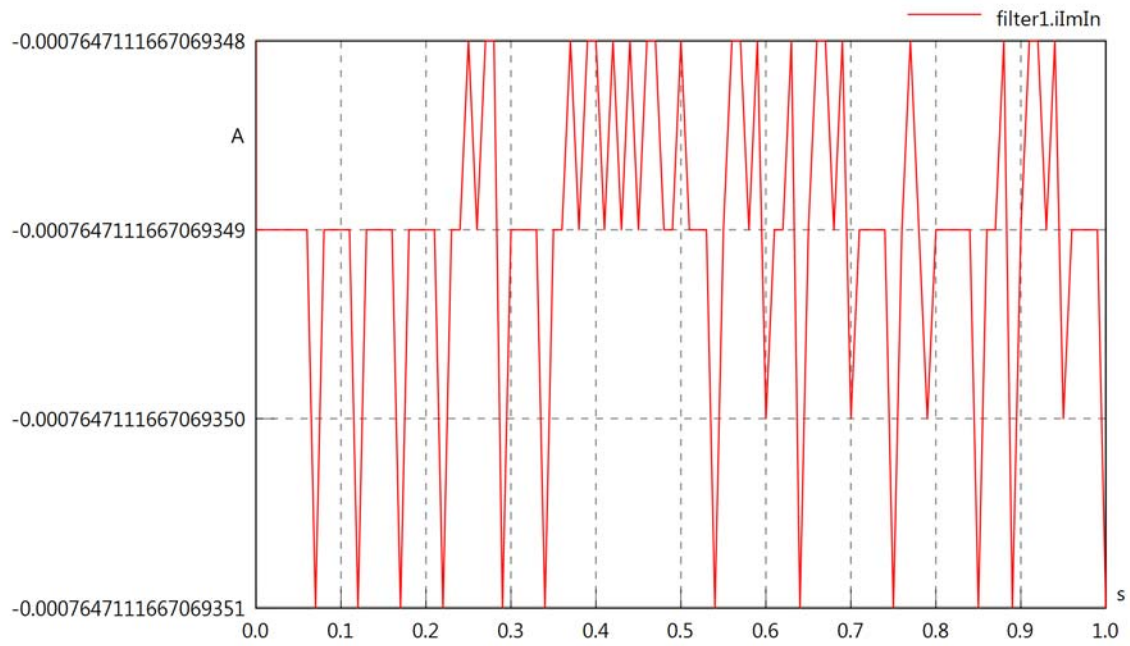

filter1.phiVIn

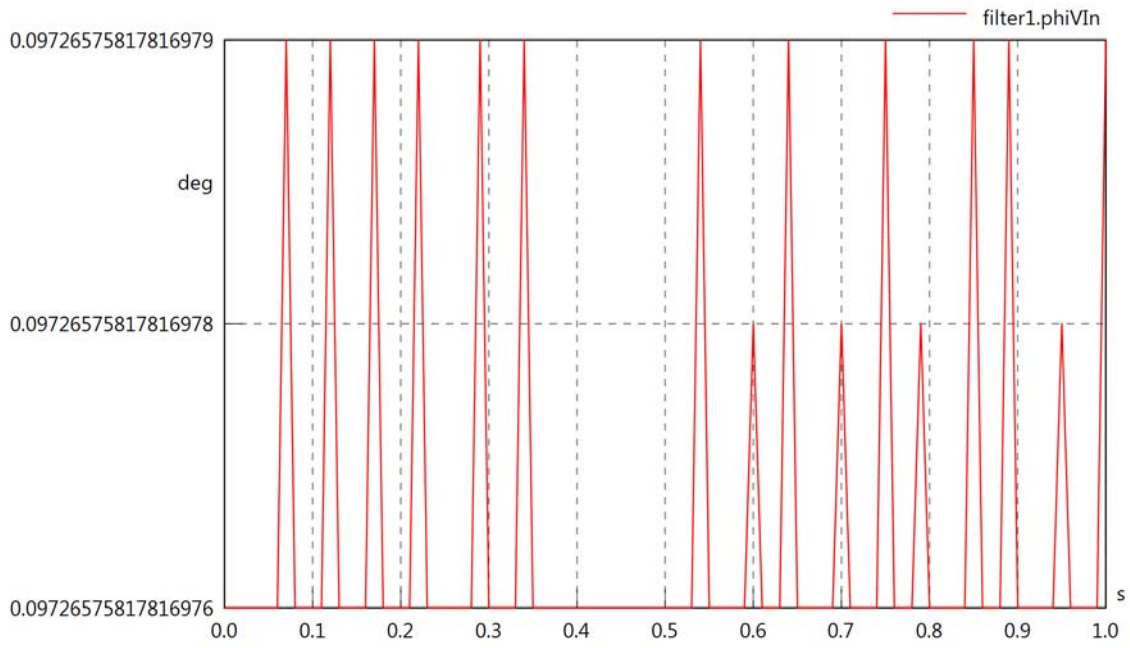

filter1.phiIn

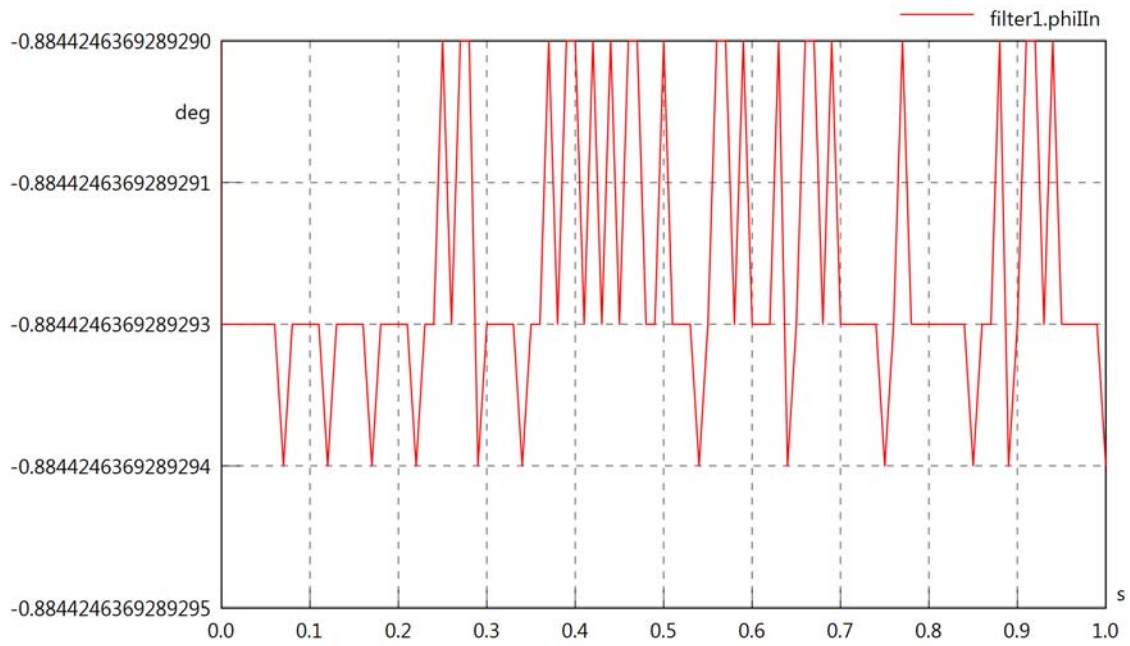

filter1.phiIVIn

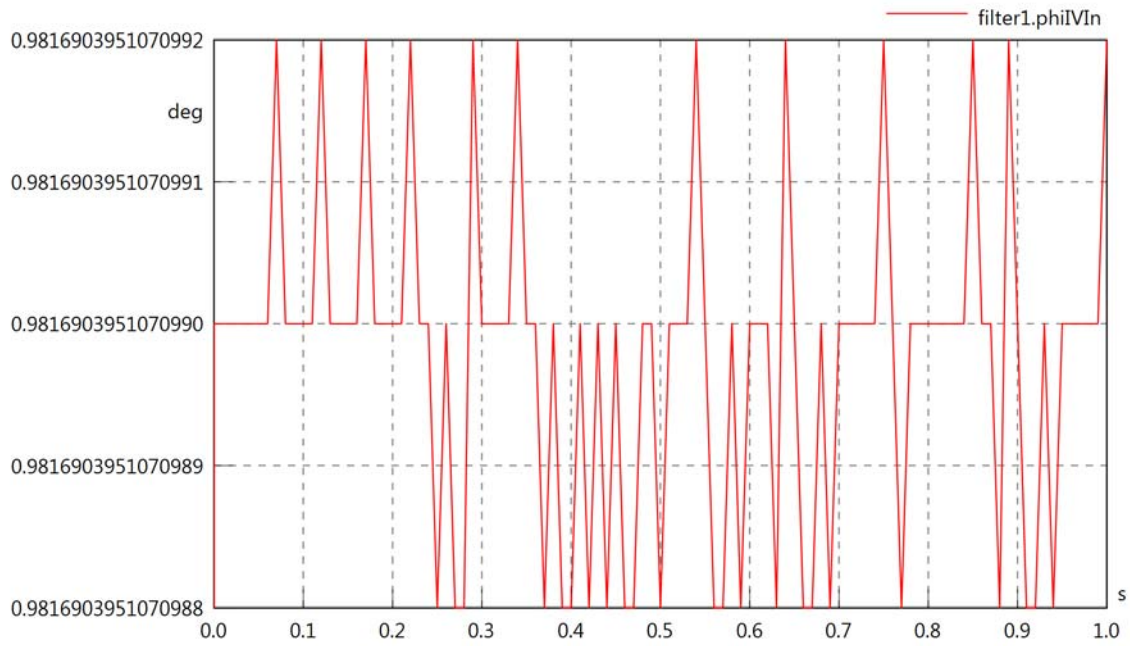

filter1.PReIn

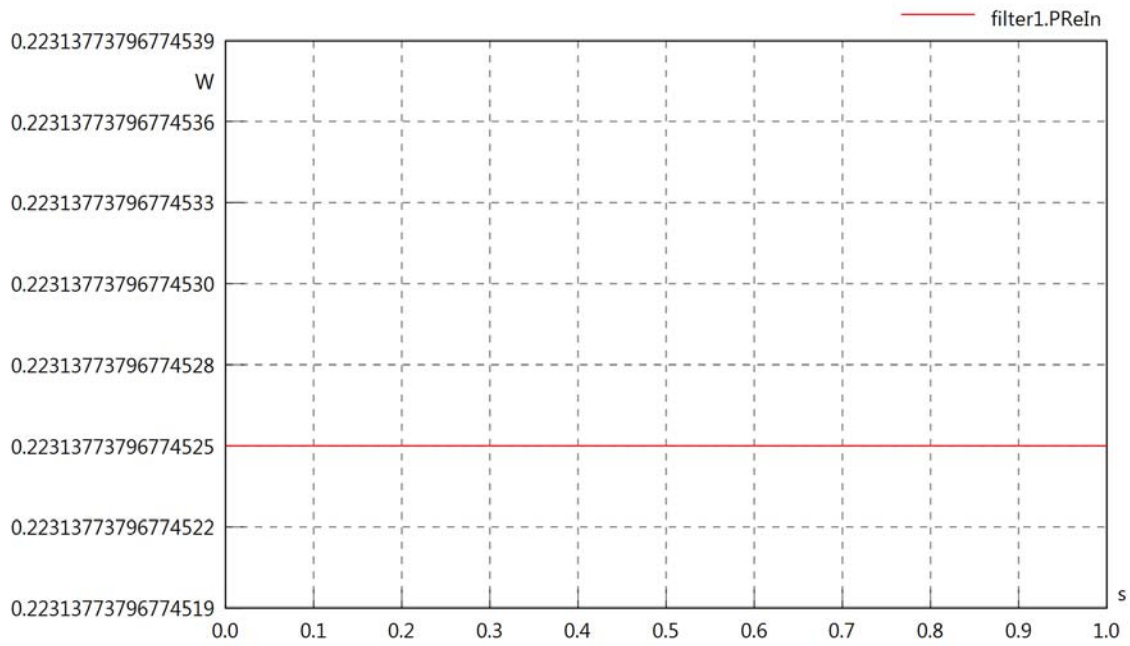

filter1.PImIn

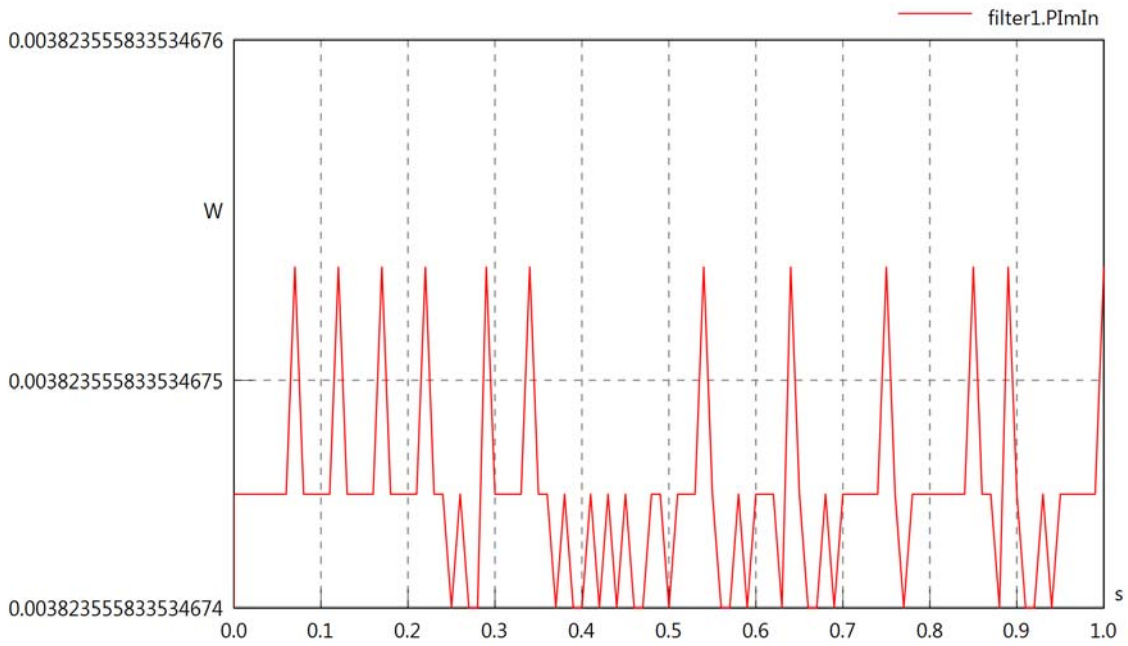

filter1.SIn

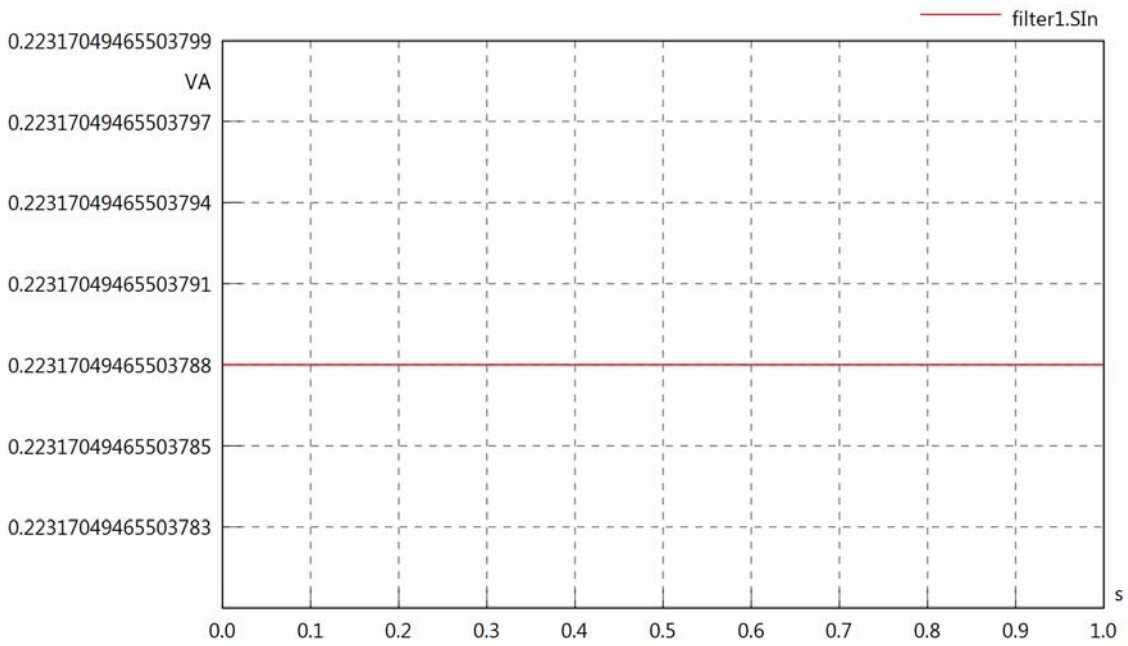

filter1.VrmsOut

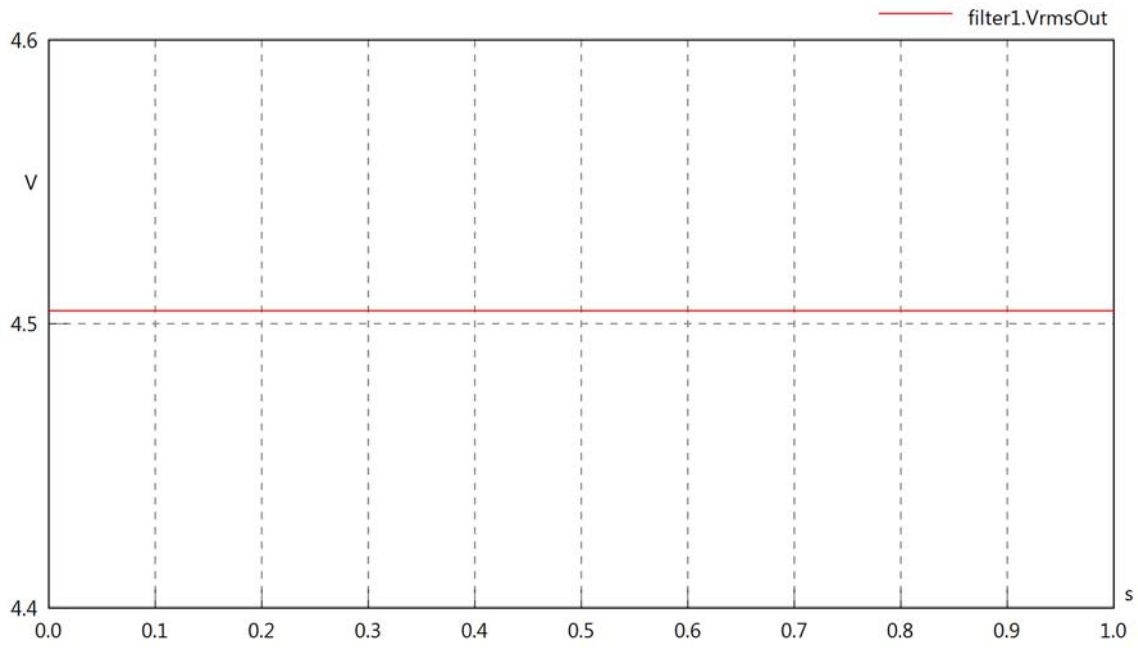

filter1.vReOut

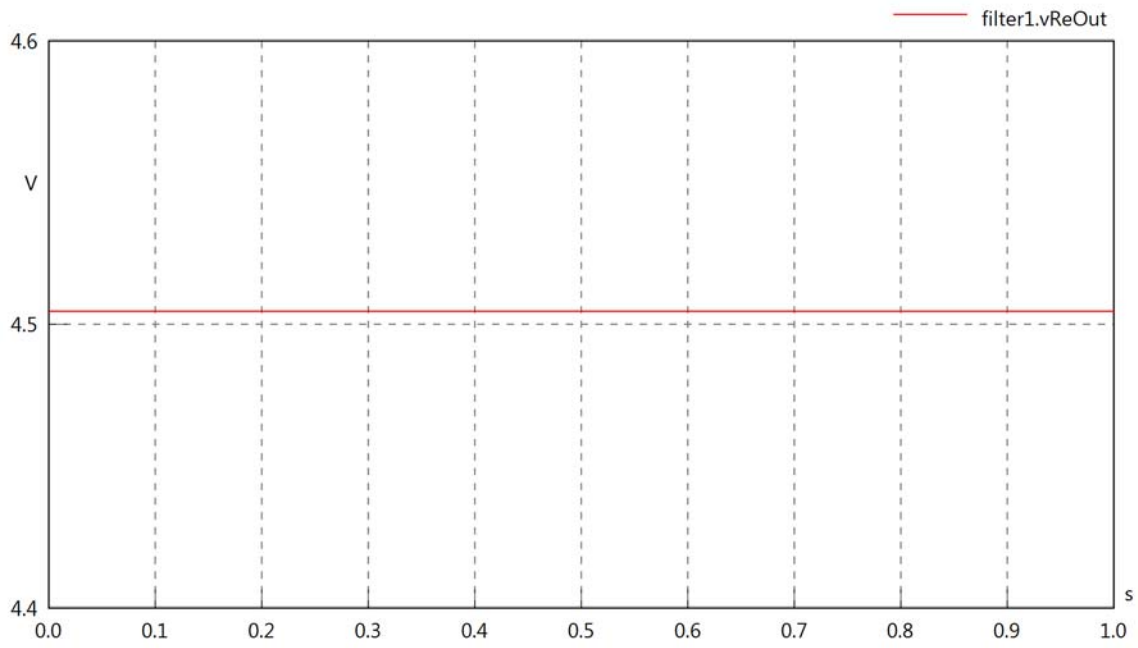

filter1.vImOut

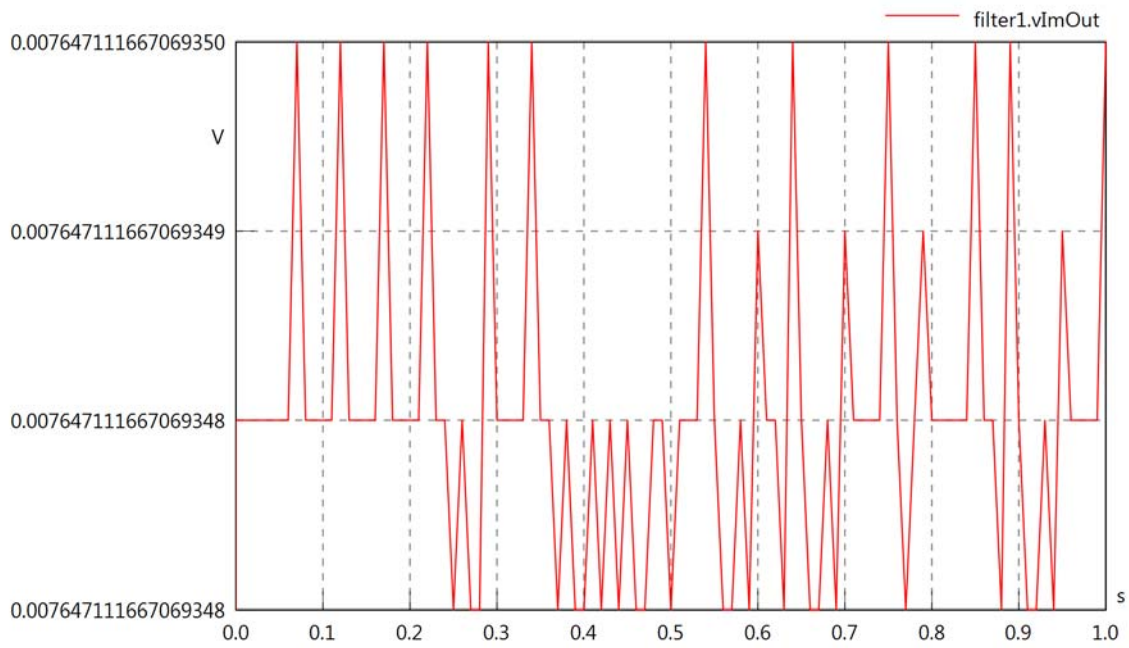

filter1.IrmsOut

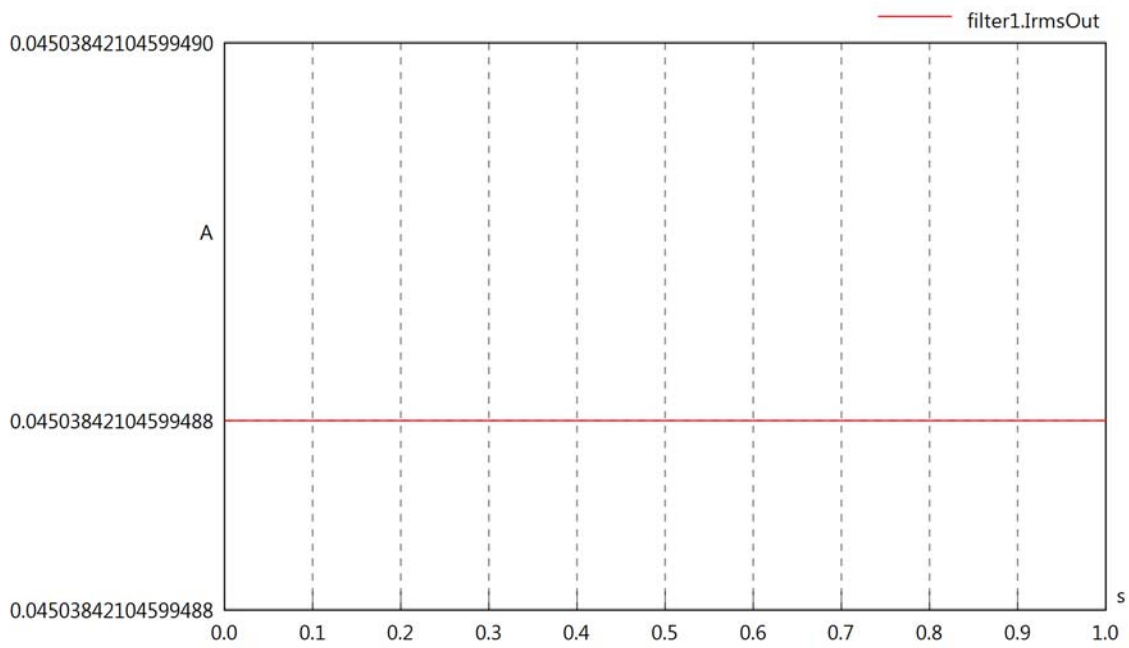

filter1.iReOut

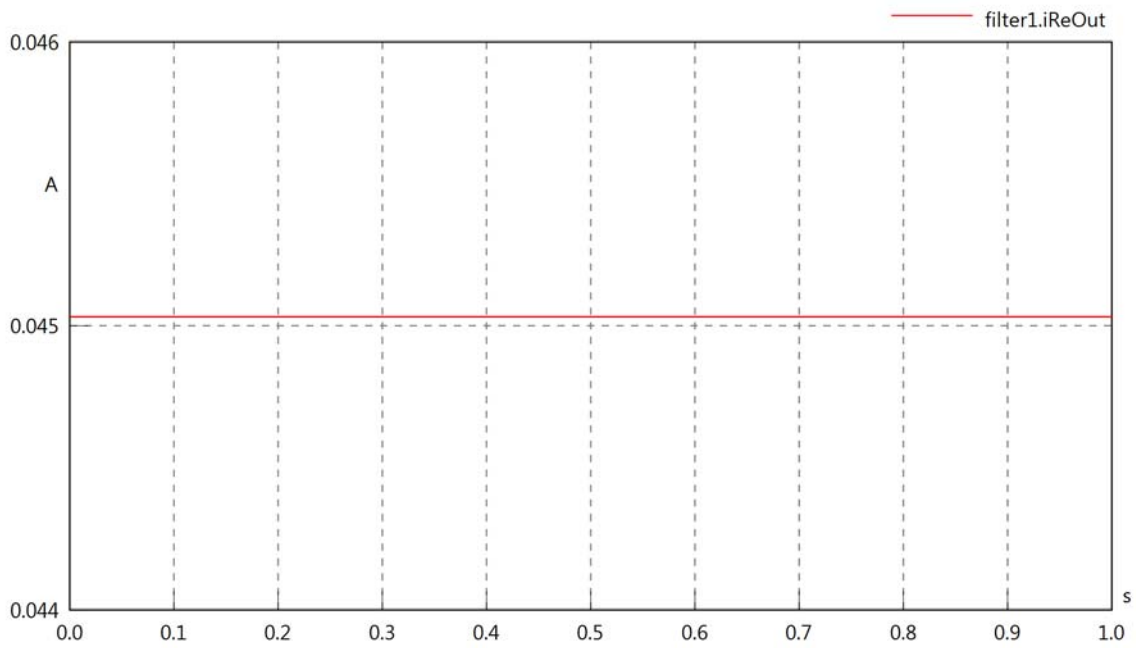

filter1.iImOut

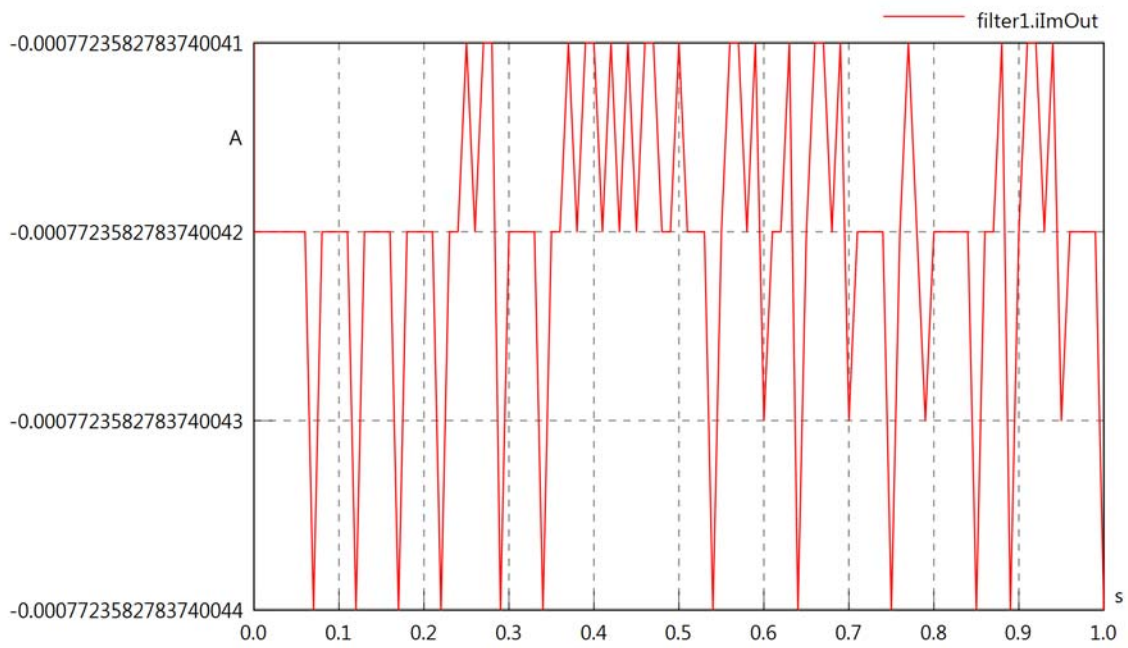

filter1.phiVOut

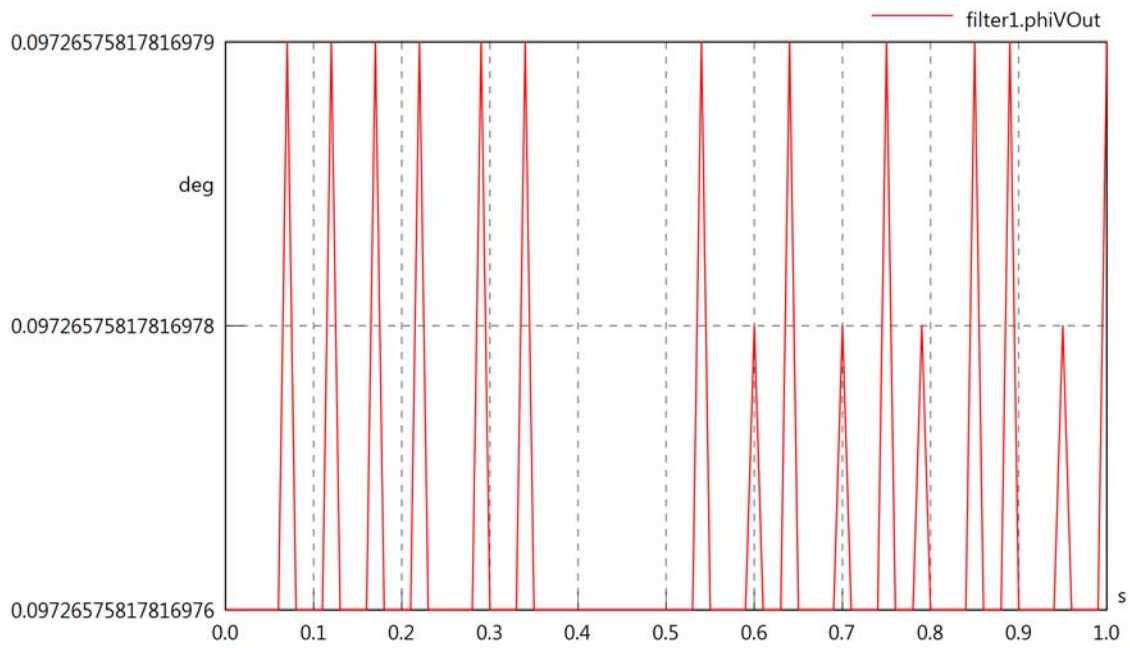

filter1.phiIOut

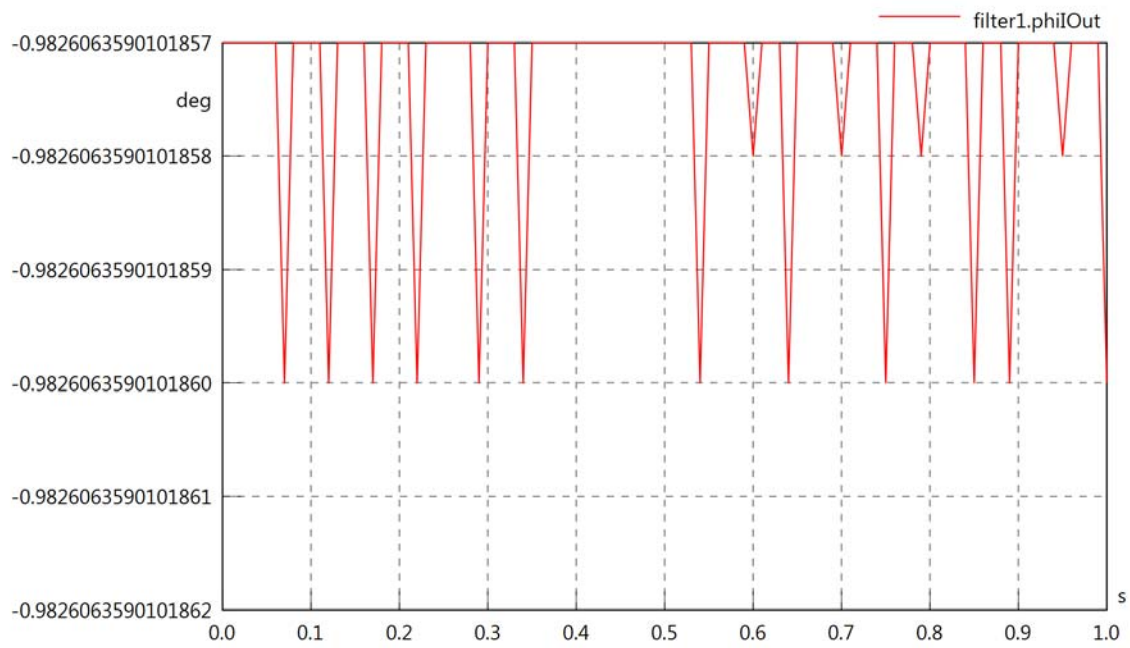

filter1.phiIVOut

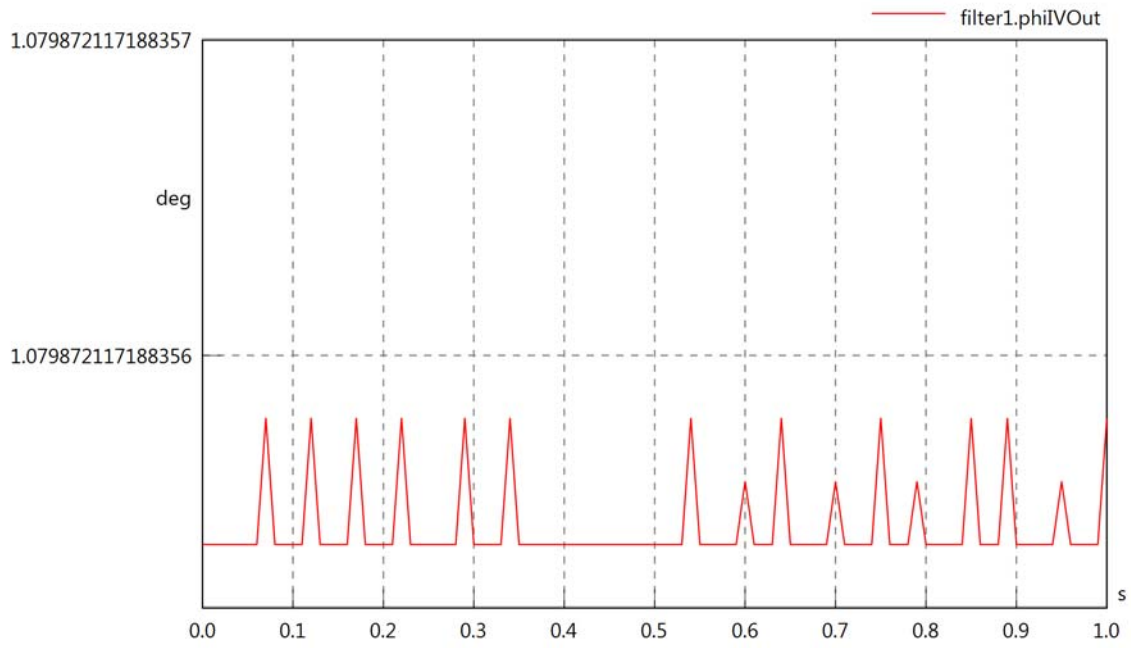

filter1.PReOut

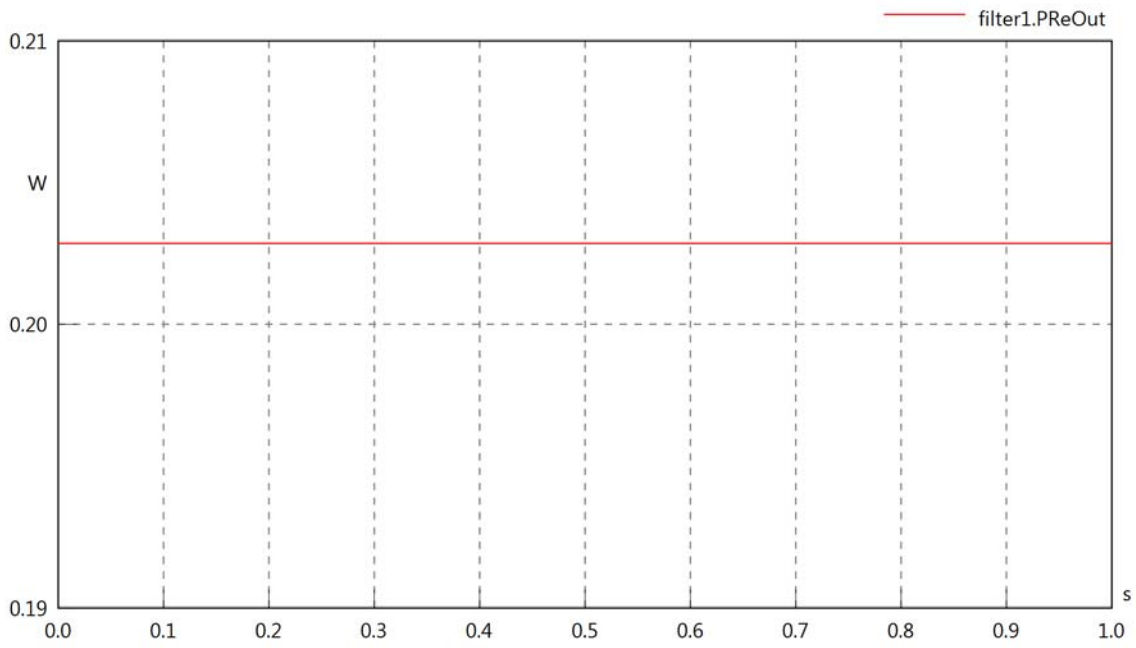

filter1.PImOut

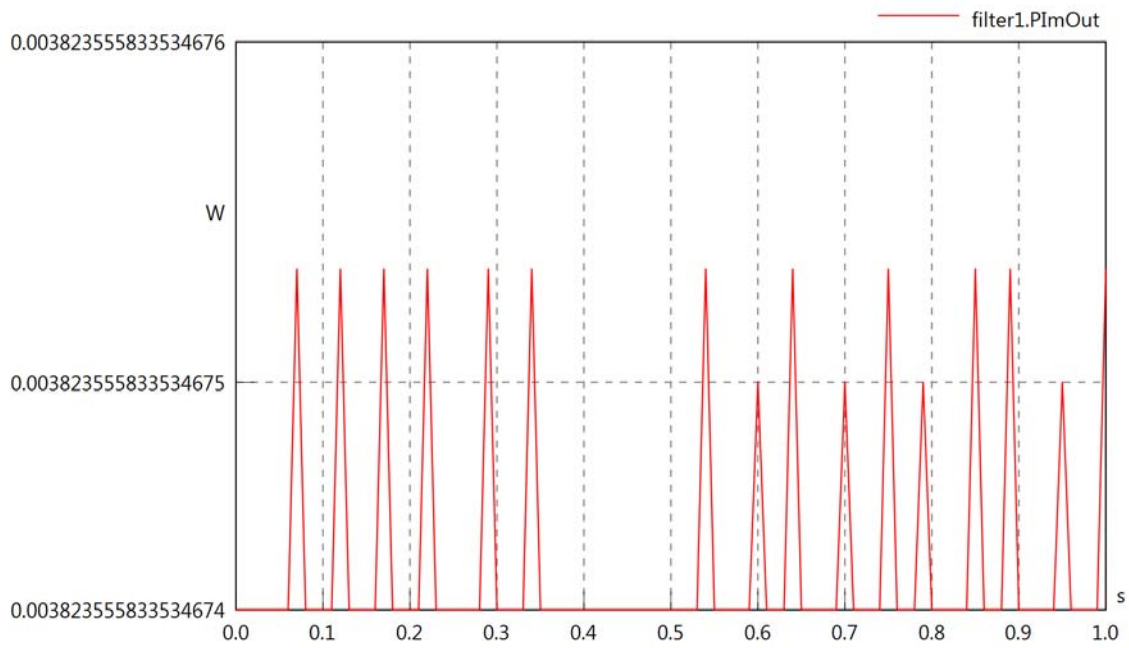

filter1.SOut

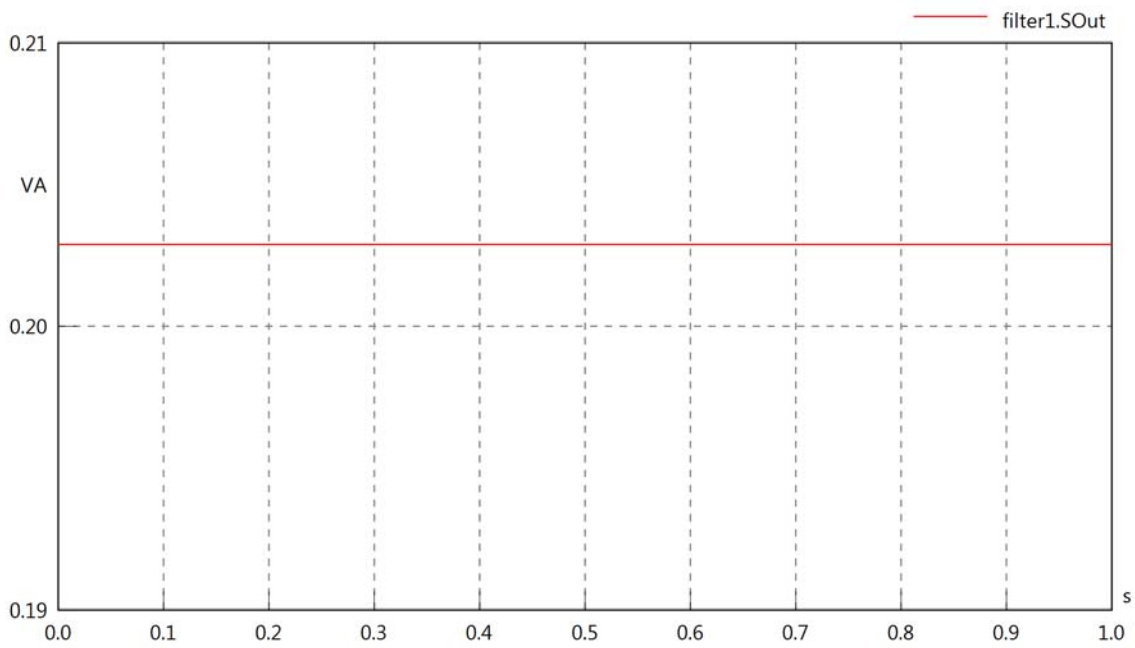
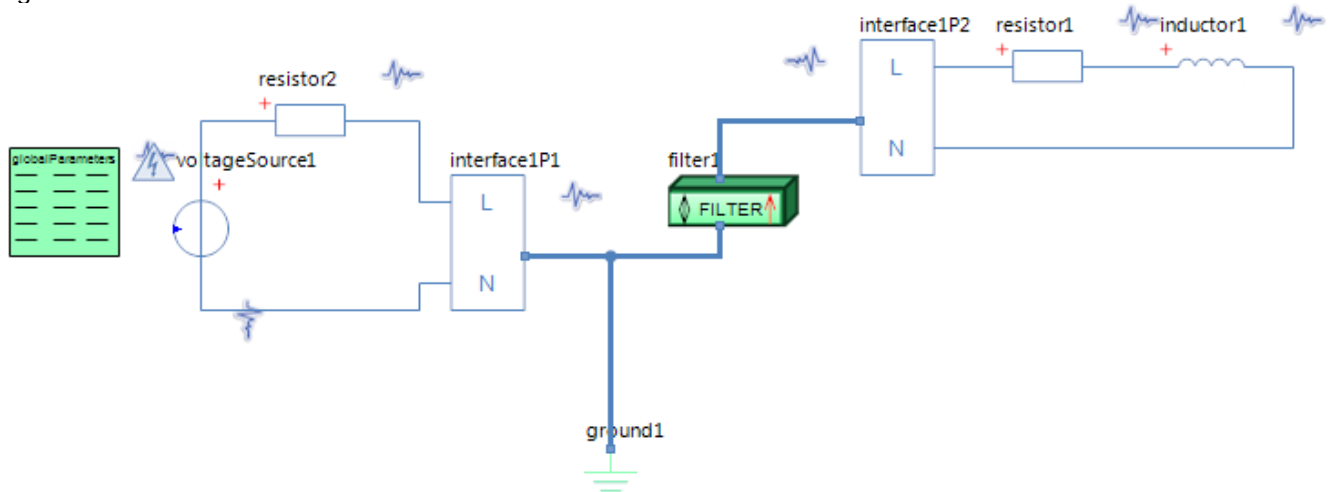

Diagram View



GlobalParameters globalParameters
Parameters

Comment	Name	Current Value	Unit
Type of Calculation	eCalculationKind	Signal Calculation	
Description of Frequency	eFrequencyKind	Linear	
Minimum Frequency	fMin	4000	[Hz]
Maximum Frequency	fMax	4000	[Hz]

Voltage Source voltageSource1
Parameters

Comment	Name	Current Value	Unit
Voltage RMS	VrmsSrc	5	[V]
Phase	phi	0	[deg]

Filter filter1
Parameters

Comment	Name	Current Value	Unit
Conductance between L1 and N Power side	G	1e-3	[1/Ohm]
EPU or Modem sending on system	sType	Modem sending	

Inductor inductor1
Parameters

Comment	Name	Current Value	Unit
Inductance	L	5	[mH]

Resistor resistor1
Parameters

Comment	Name	Current Value	Unit
Resistance	R	100	[Ohm]

Resistor resistor2
Parameters

Comment	Name	Current Value	Unit
Resistance	R	10	[Ohm]

filter1.VrmsIn

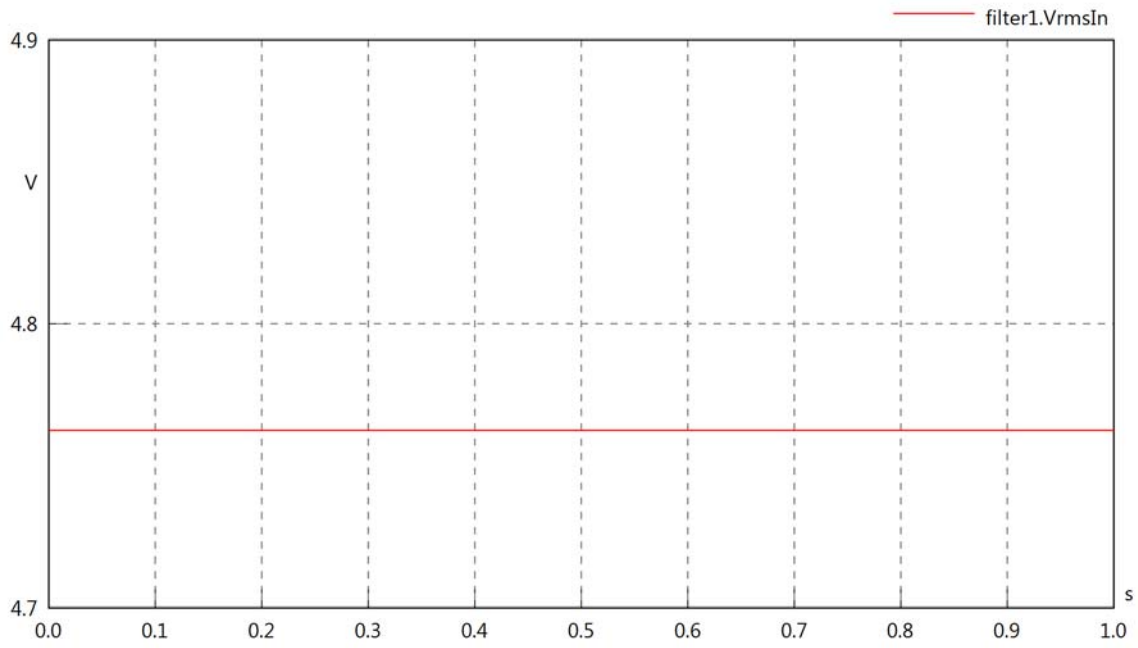

filter1.vReIn

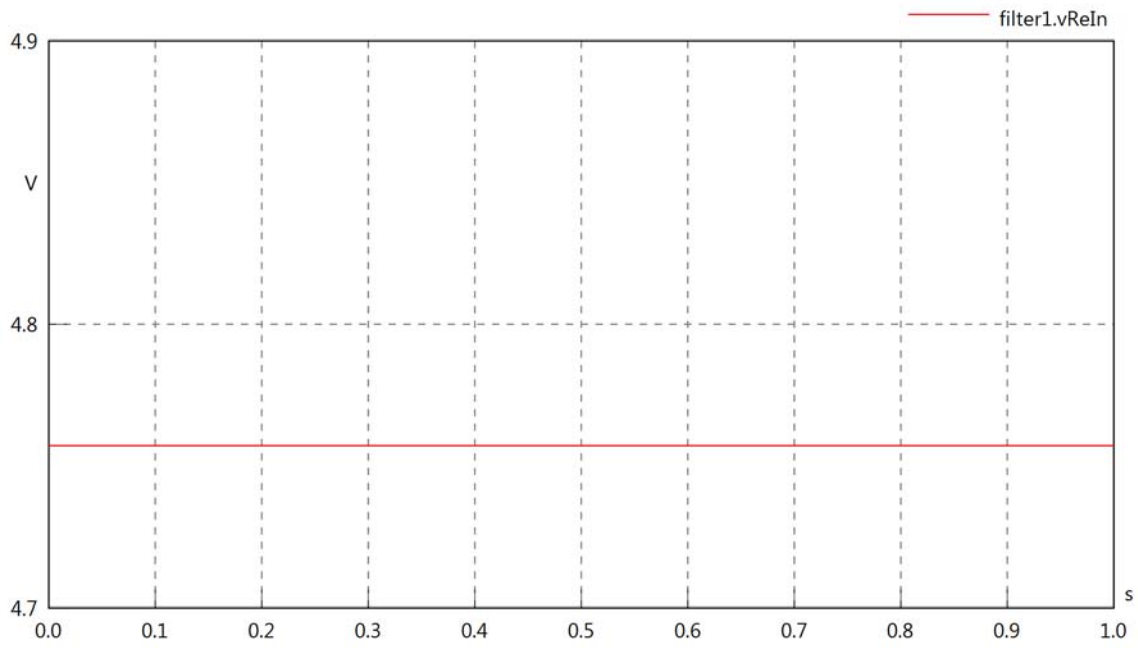

filter1.vImIn

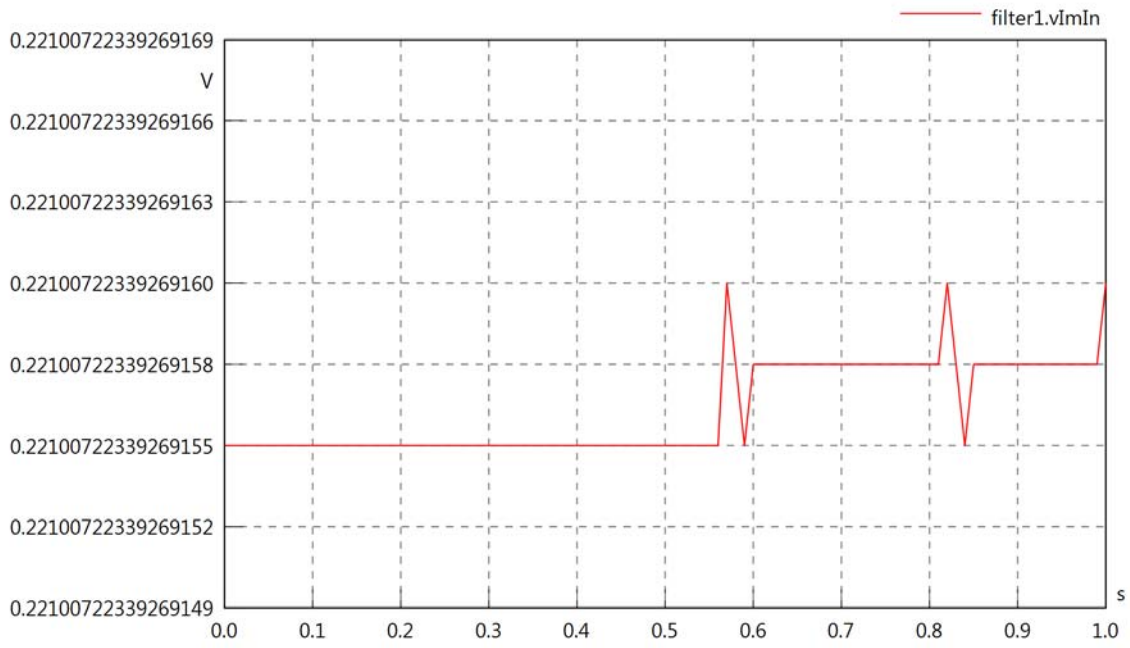

filter1.IrmsIn

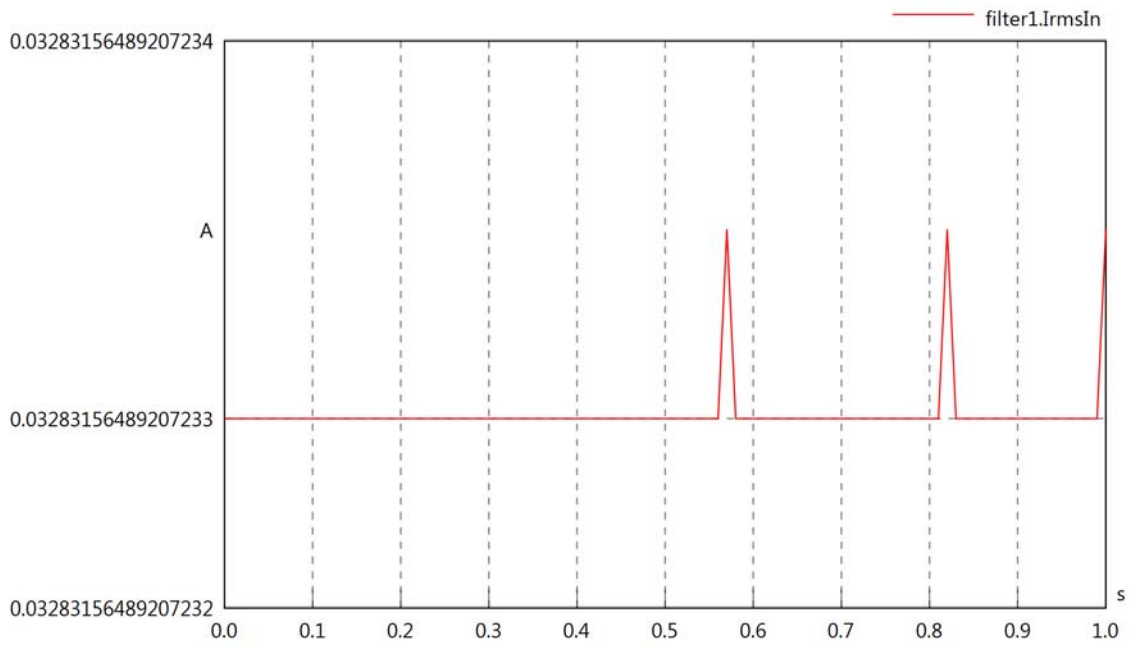

filter1.iReIn

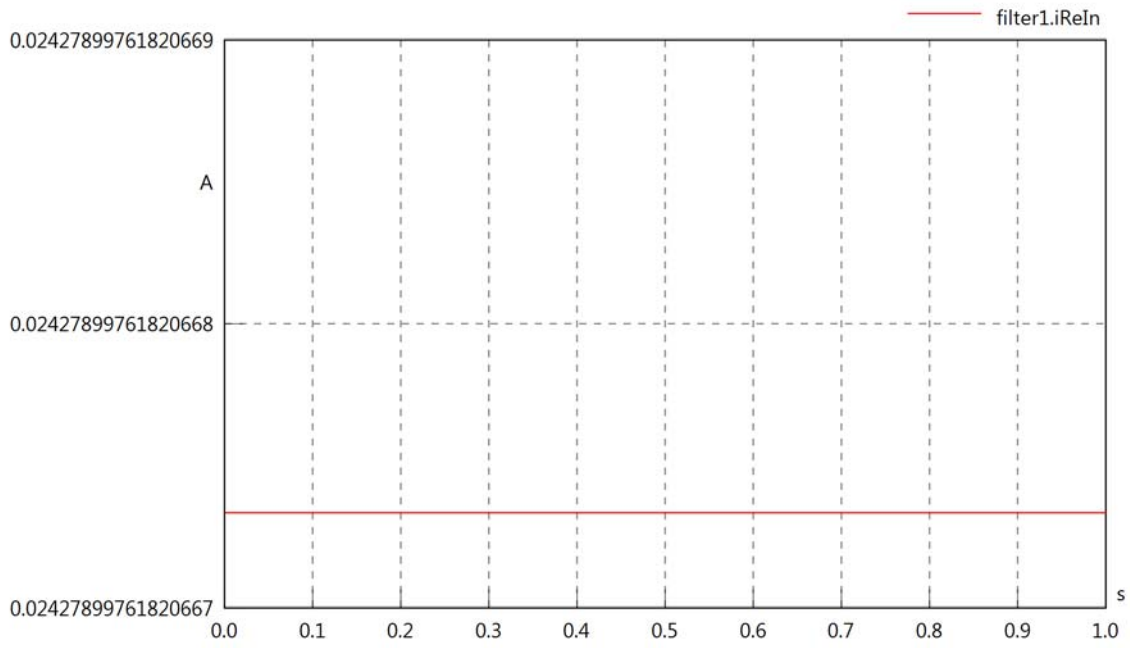

filter1.iImIn

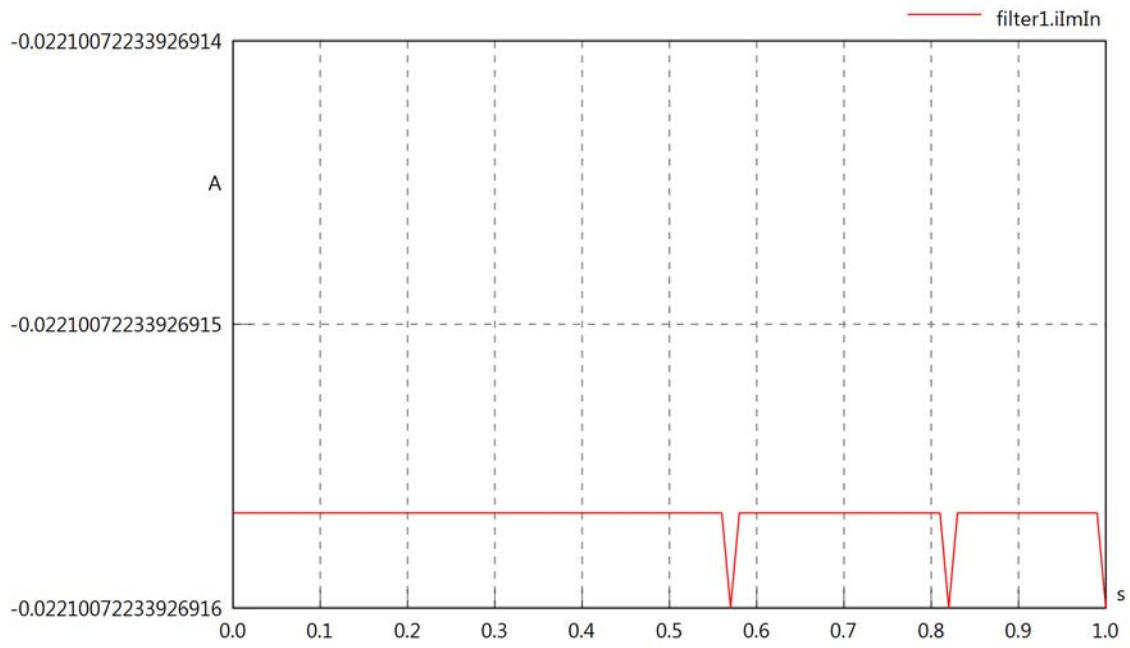

filter1.phiVIn

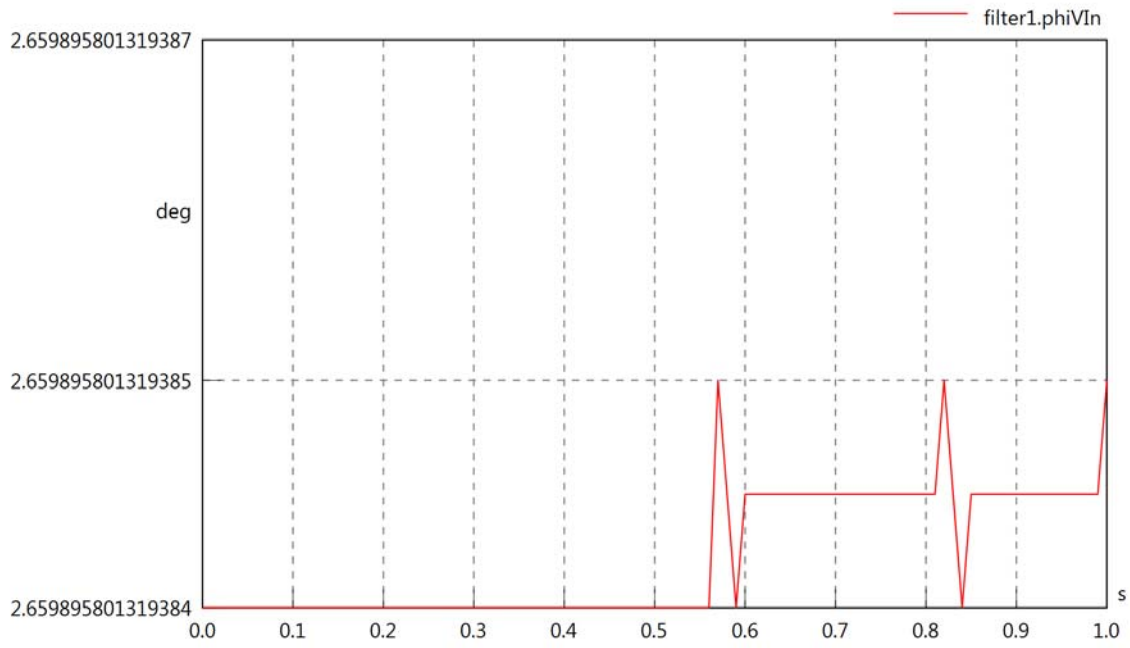

filter1.phiIIn

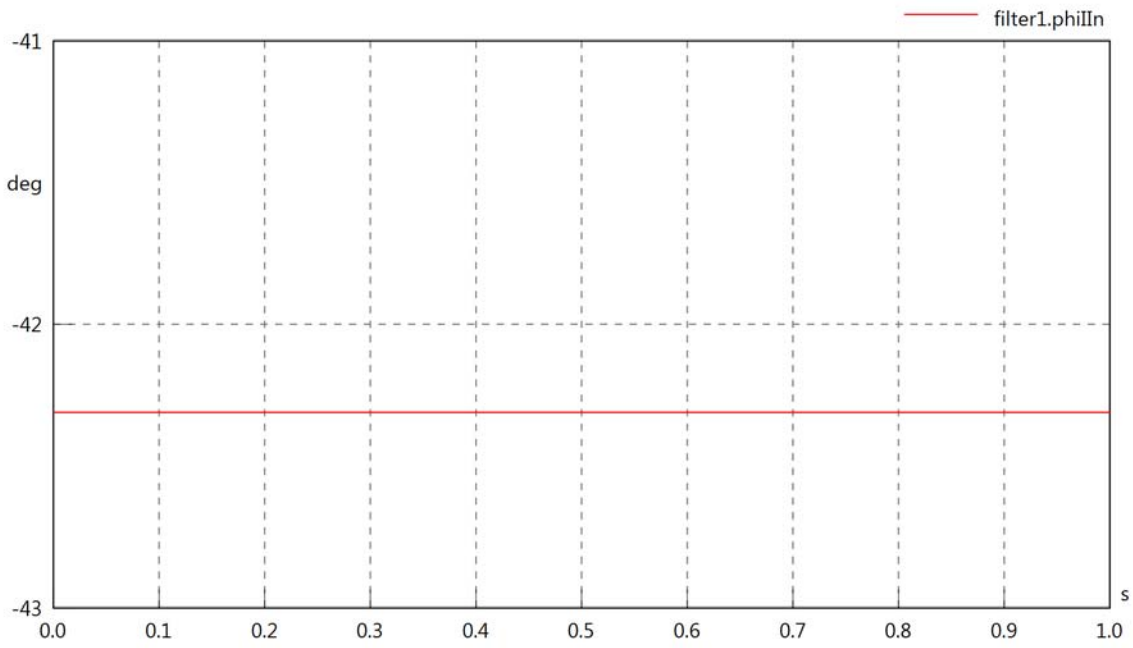

filter1.phiIVIn

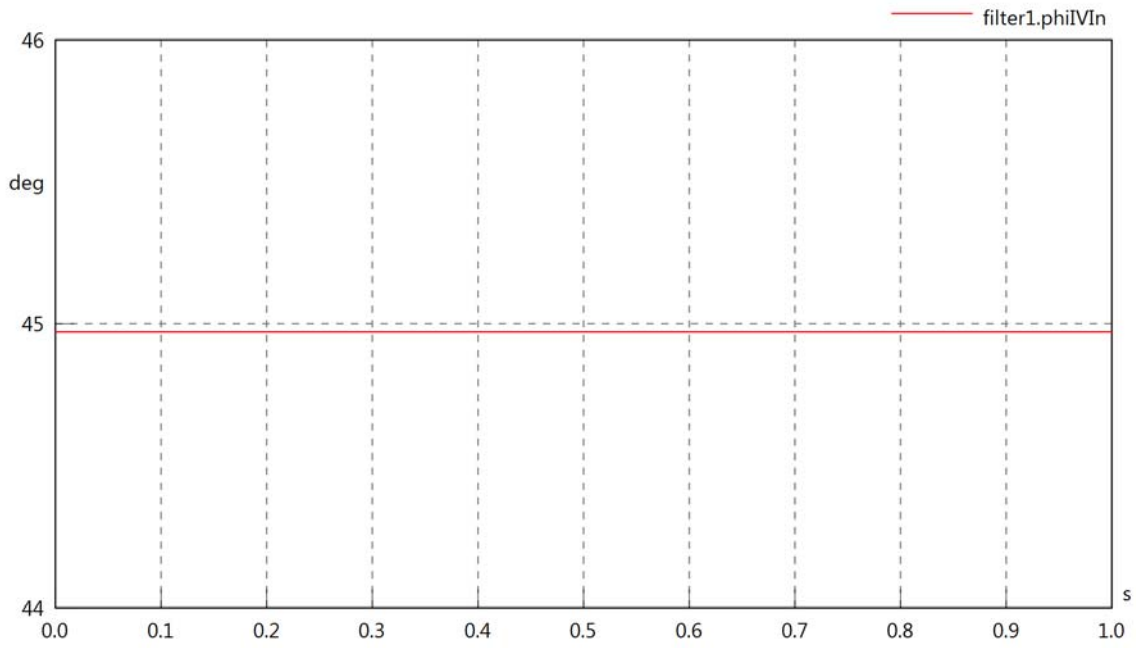

filter1.PReIn

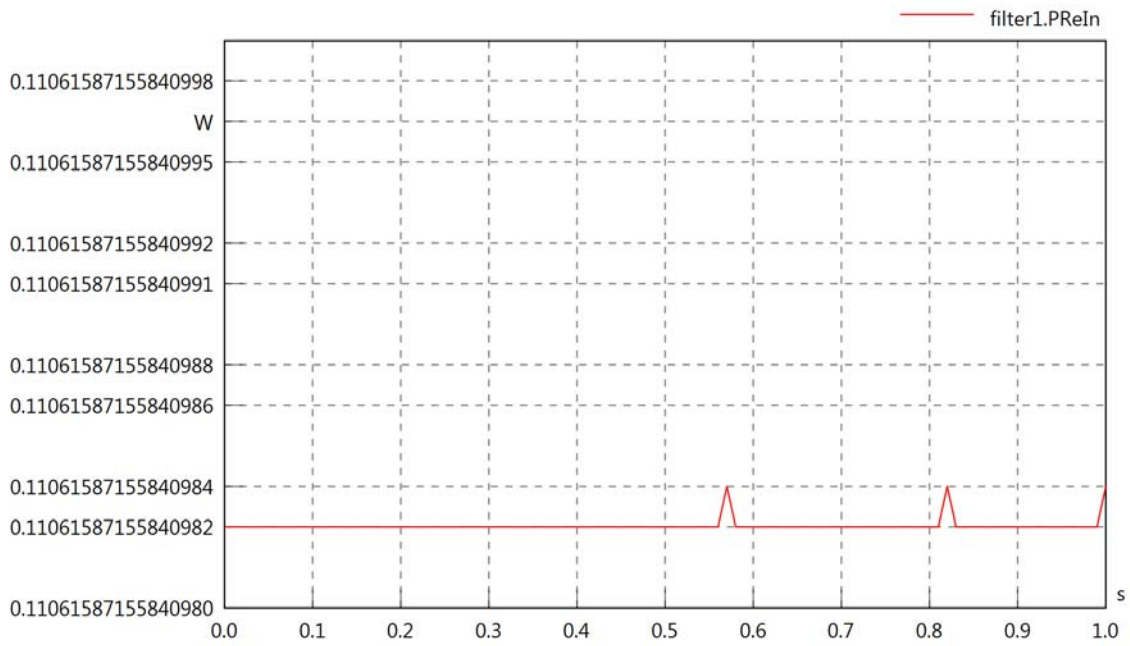

filter1.PImIn

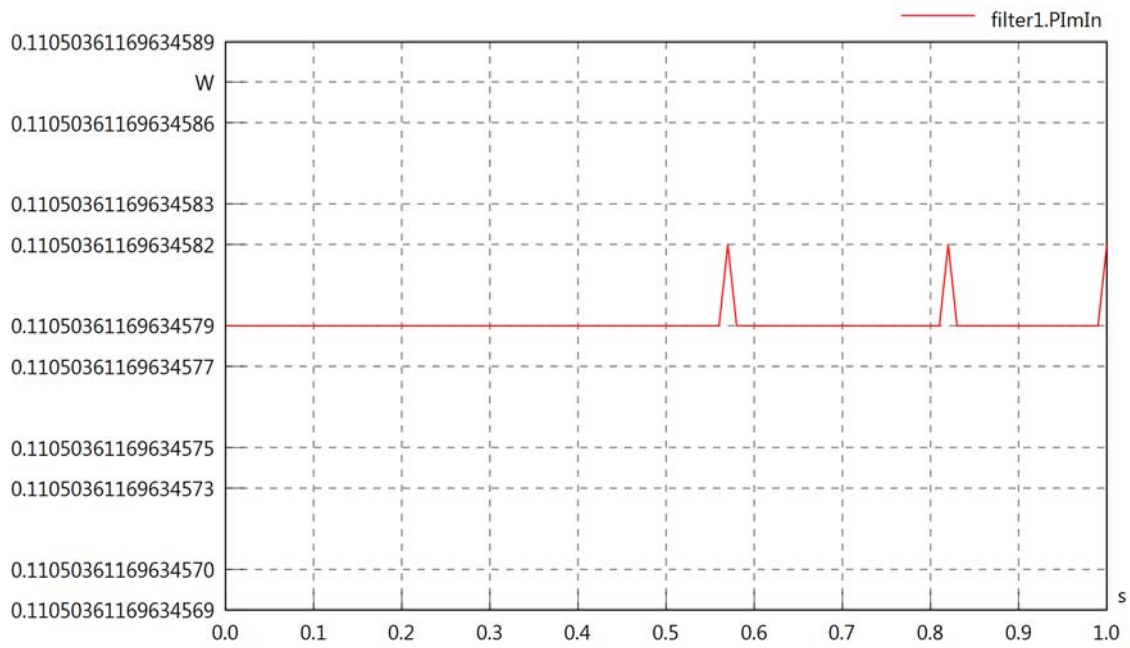

filter1.SIn

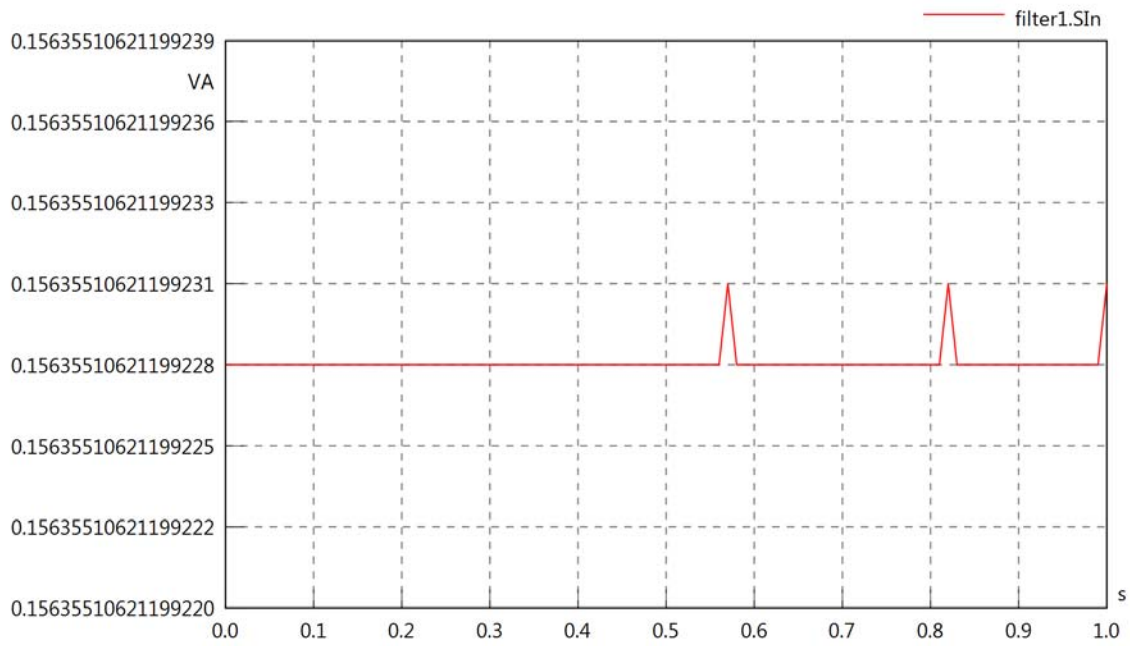

filter1.VrmsOut

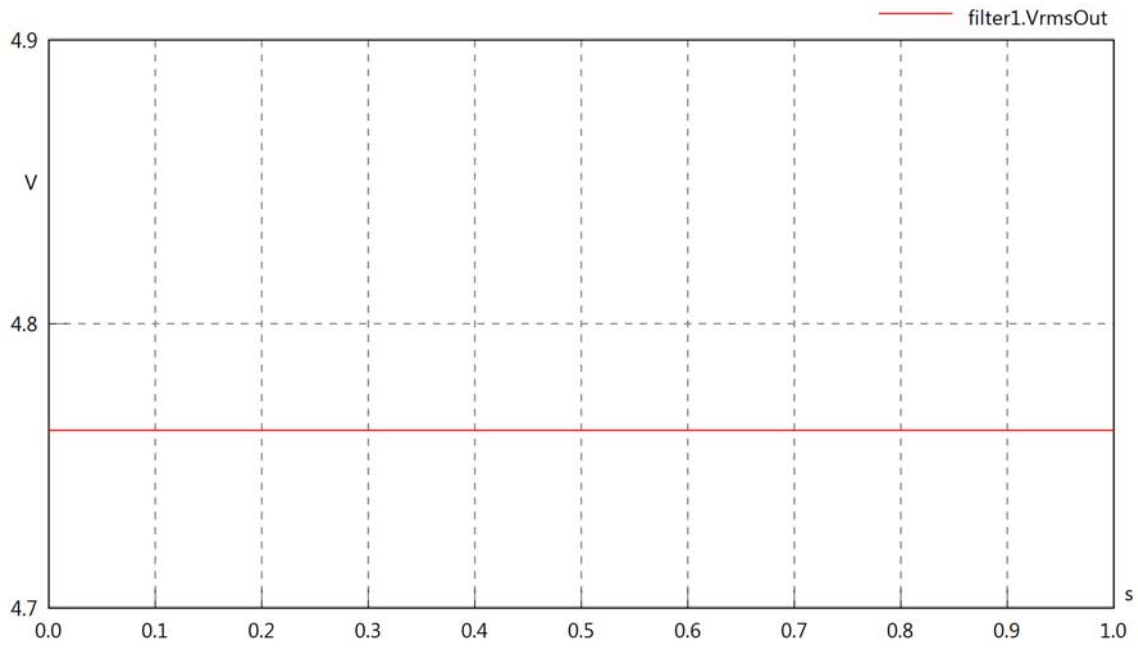

filter1.vReOut

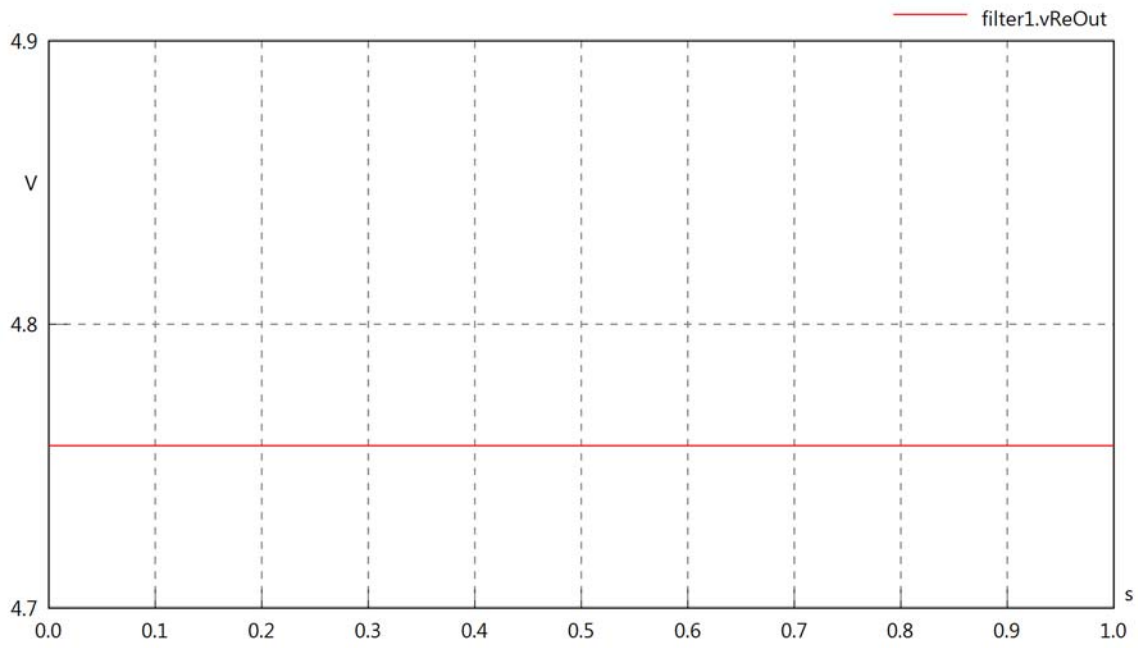

filter1.vImOut

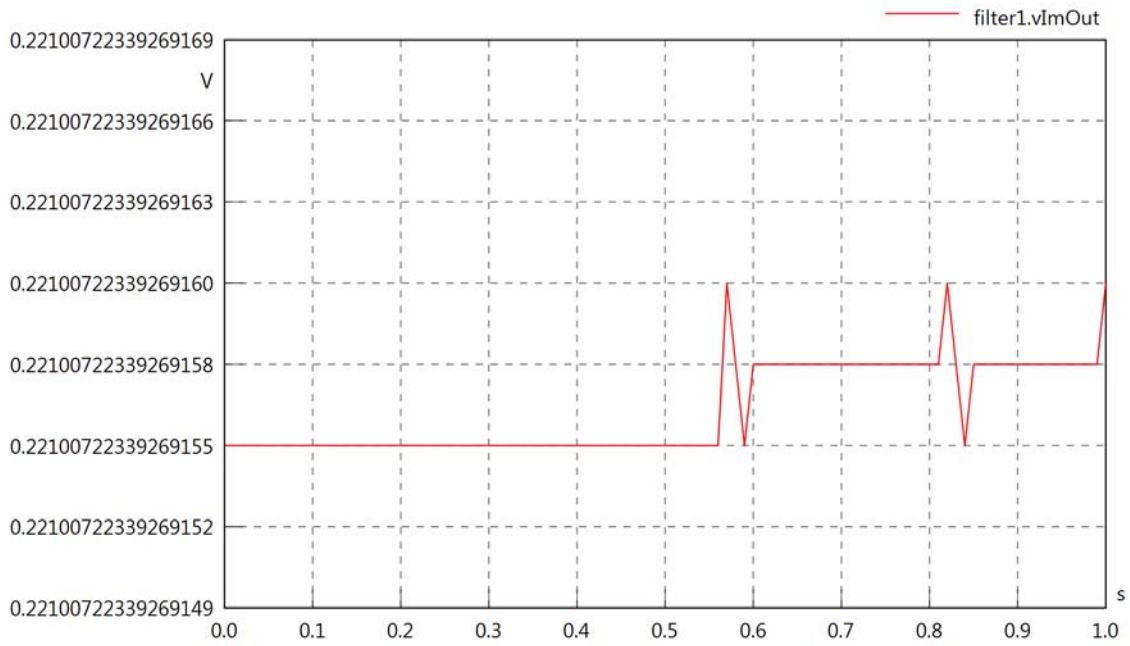

filter1.IrmsOut

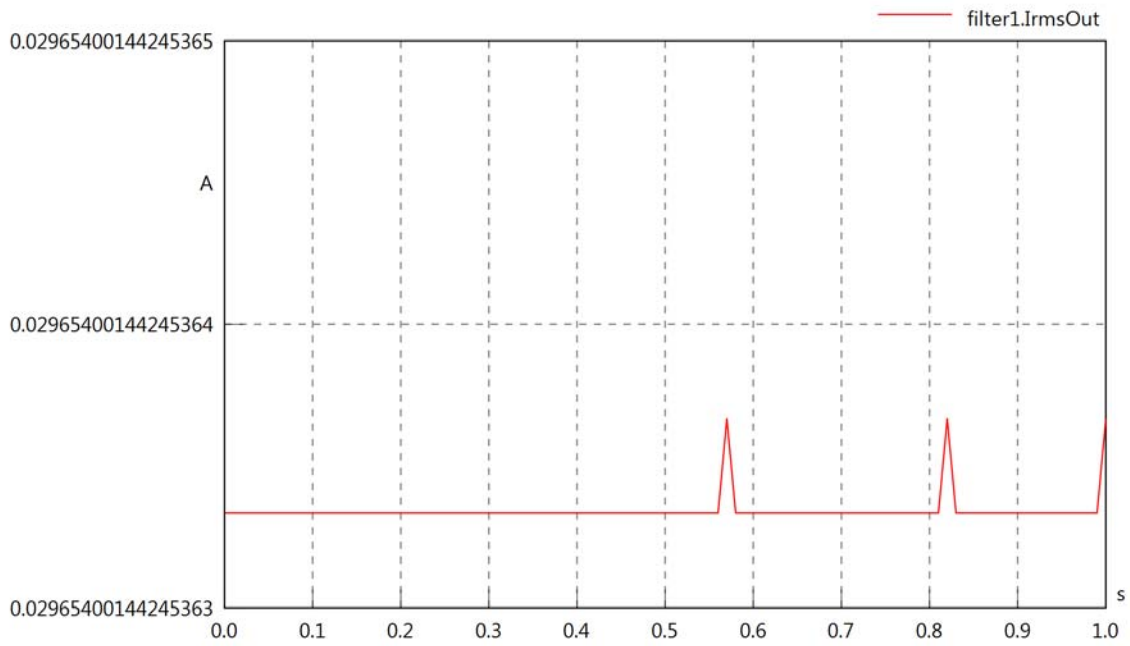

filter1.iReOut

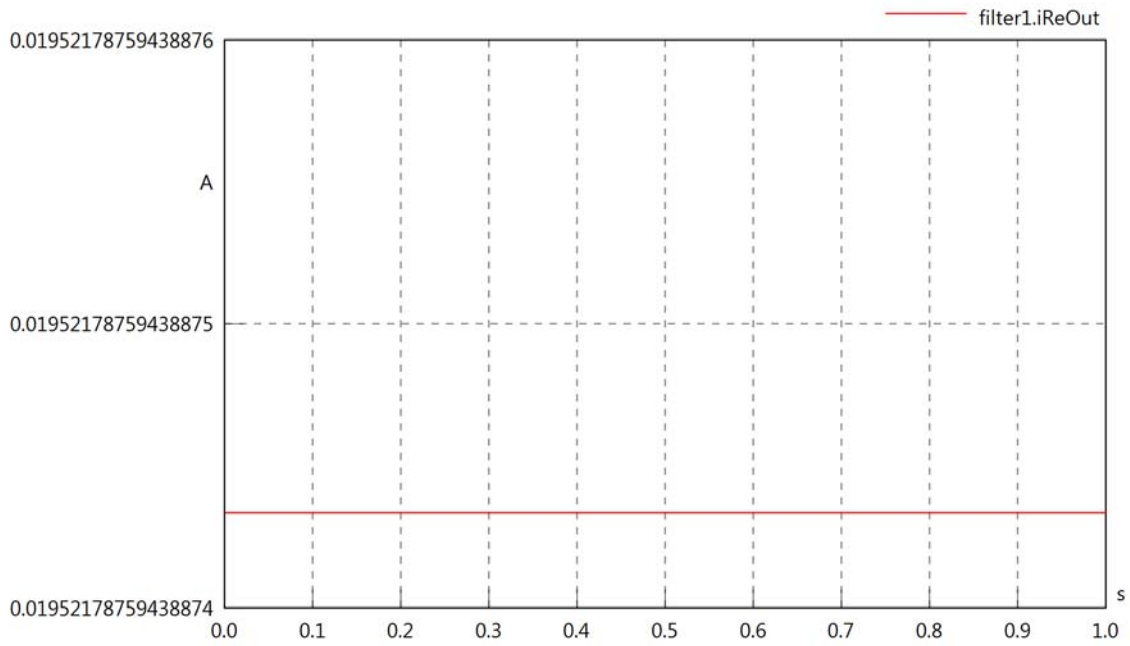

filter1.iImOut

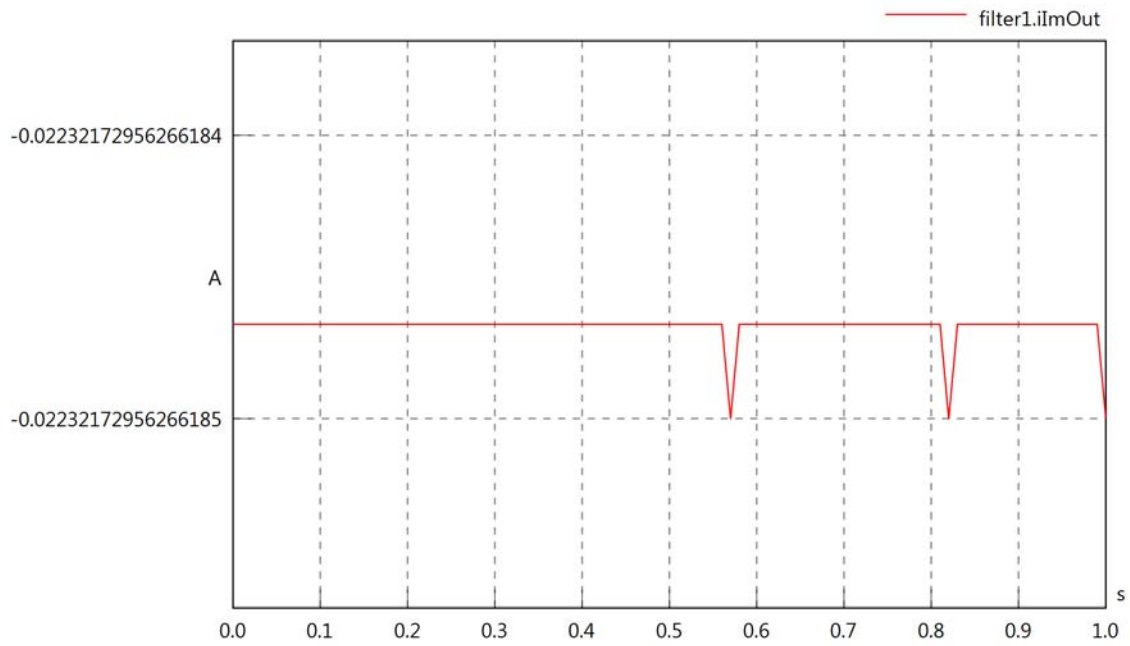

filter1.phiVOut

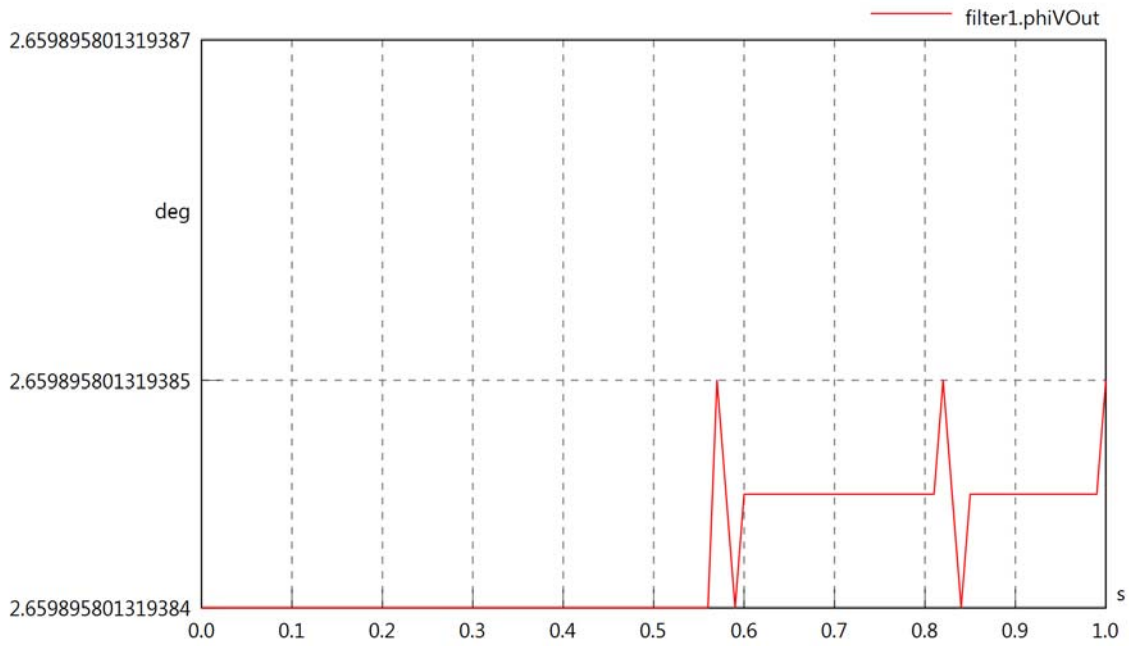

filter1.phiIOut

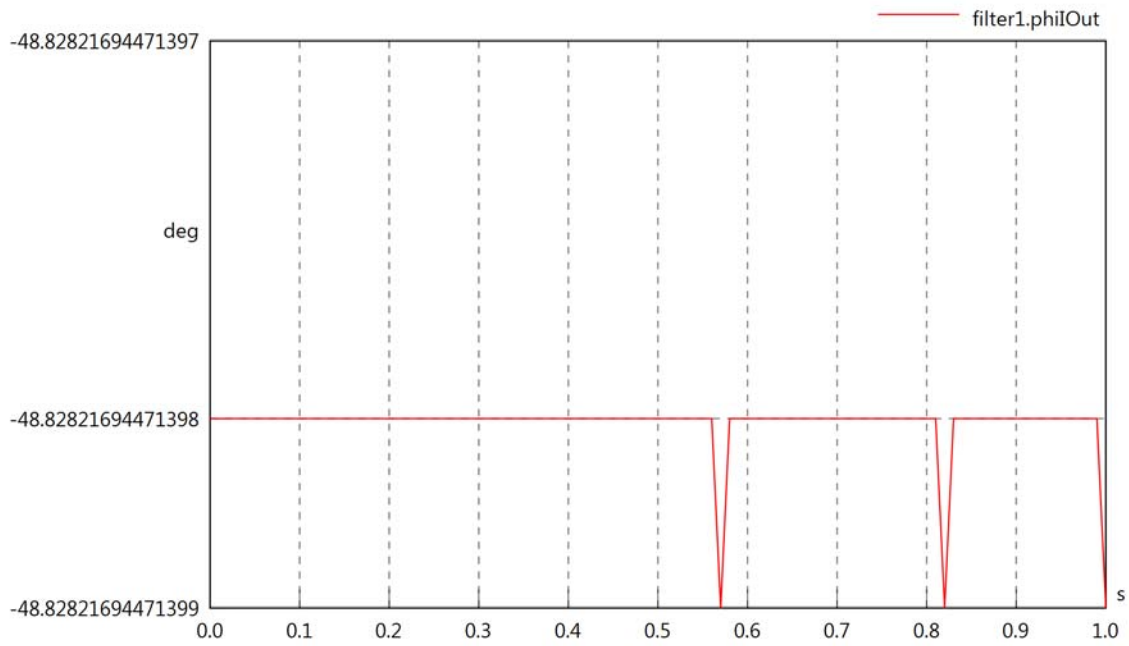

filter1.phiIVOut

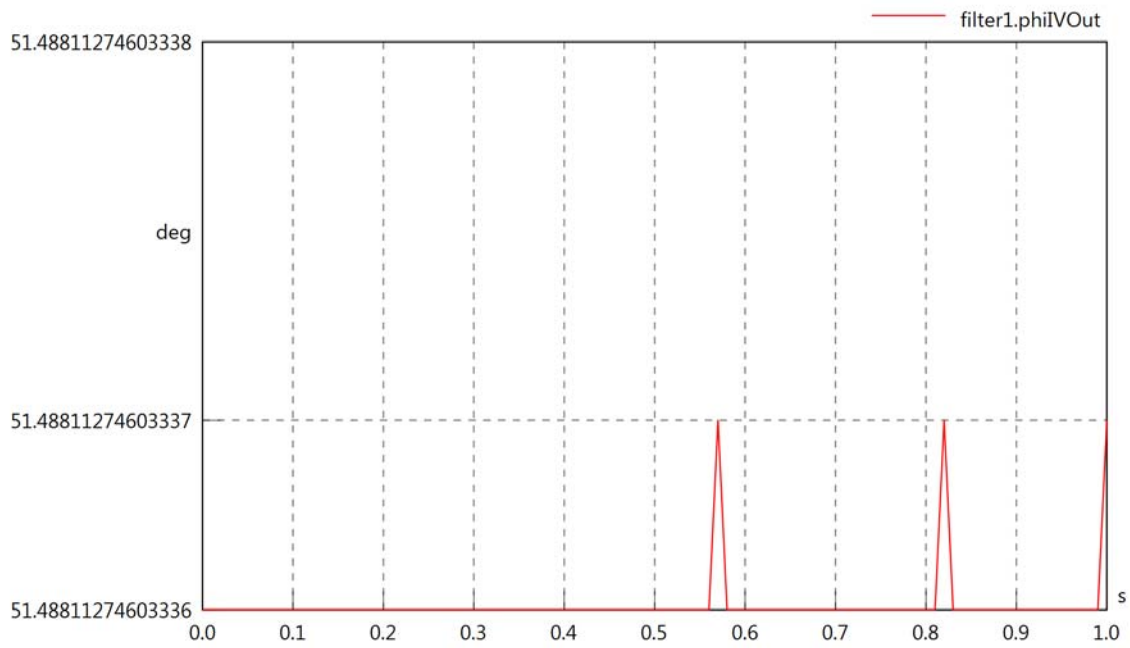

filter1.PReOut

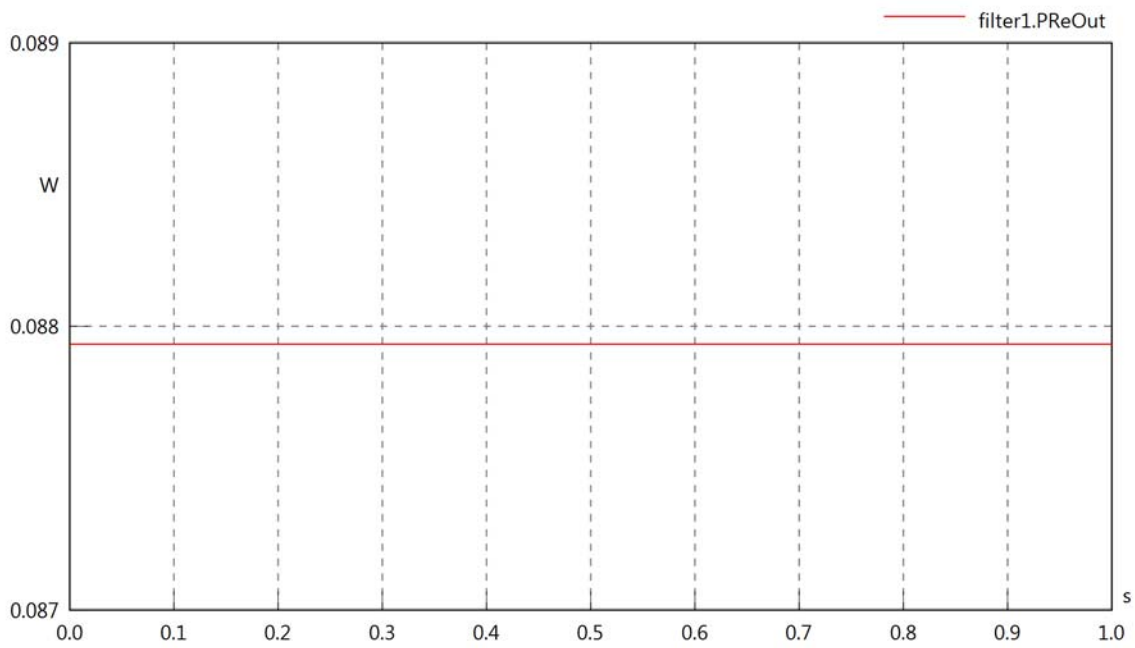

filter1.PImOut

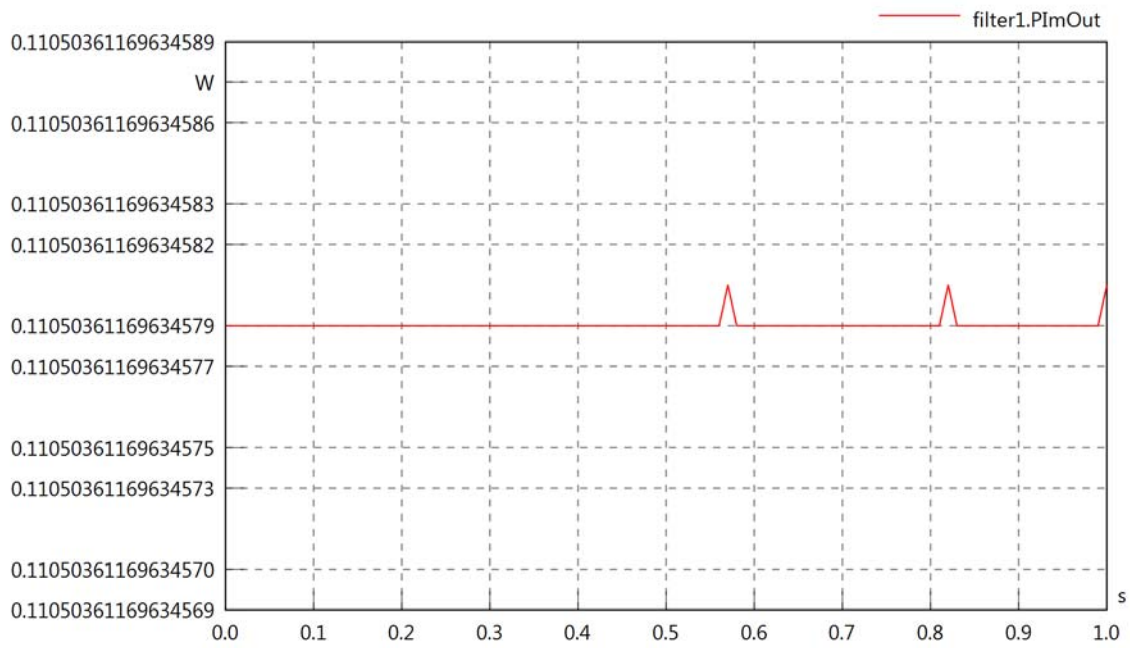

filter1.SOut

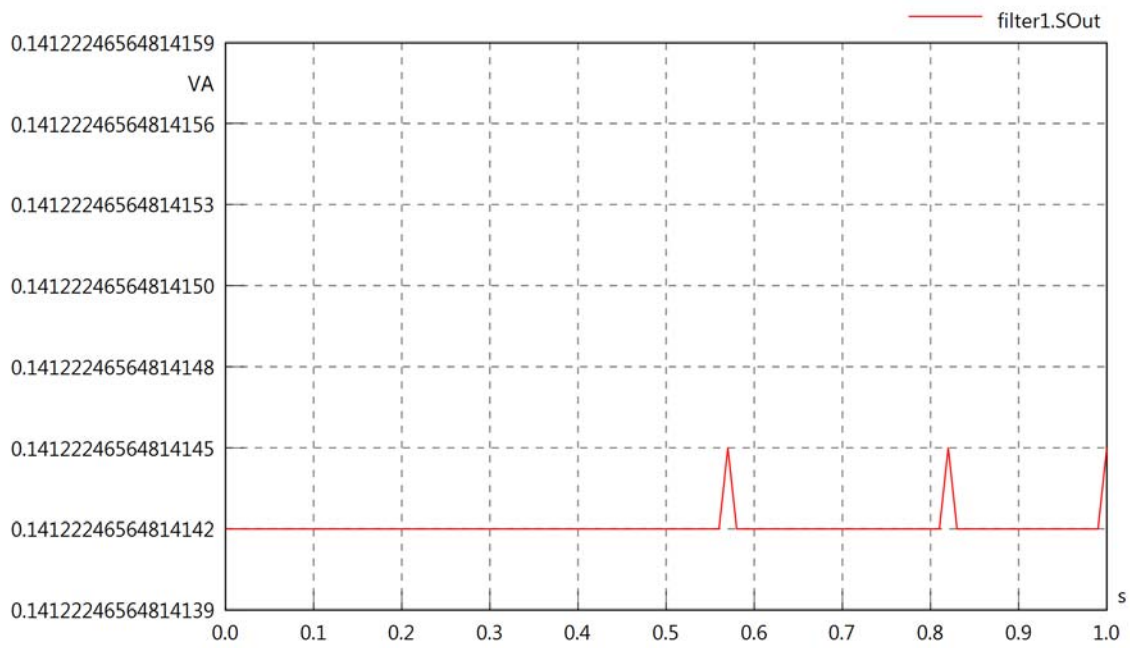
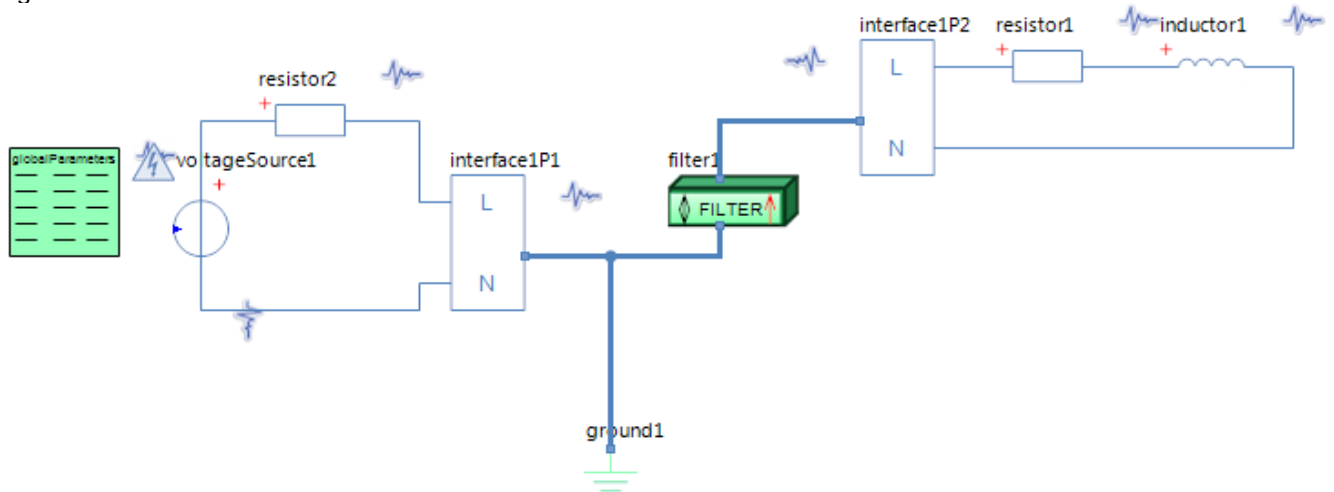

Diagram View



GlobalParameters globalParameters
Parameters

Comment	Name	Current Value	Unit
Type of Calculation	eCalculationKind	Signal Calculation	
Description of Frequency	eFrequencyKind	Linear	
Minimum Frequency	fMin	100	[kHz]
Maximum Frequency	fMax	100	[kHz]

Voltage Source voltageSource1
Parameters

Comment	Name	Current Value	Unit
Voltage RMS	VrmsSrc	5	[V]
Phase	phi	0	[deg]

Filter filter1
Parameters

Comment	Name	Current Value	Unit
Conductance between L1 and N Power side	G	1e-3	[1/Ohm]
EPU or Modem sending on system	sType	Modem sending	

Inductor inductor1
Parameters

Comment	Name	Current Value	Unit
Inductance	L	5	[mH]

Resistor resistor1
Parameters

Comment	Name	Current Value	Unit
Resistance	R	100	[Ohm]

Resistor resistor2
Parameters

Comment	Name	Current Value	Unit
Resistance	R	10	[Ohm]

filter1.VrmsIn

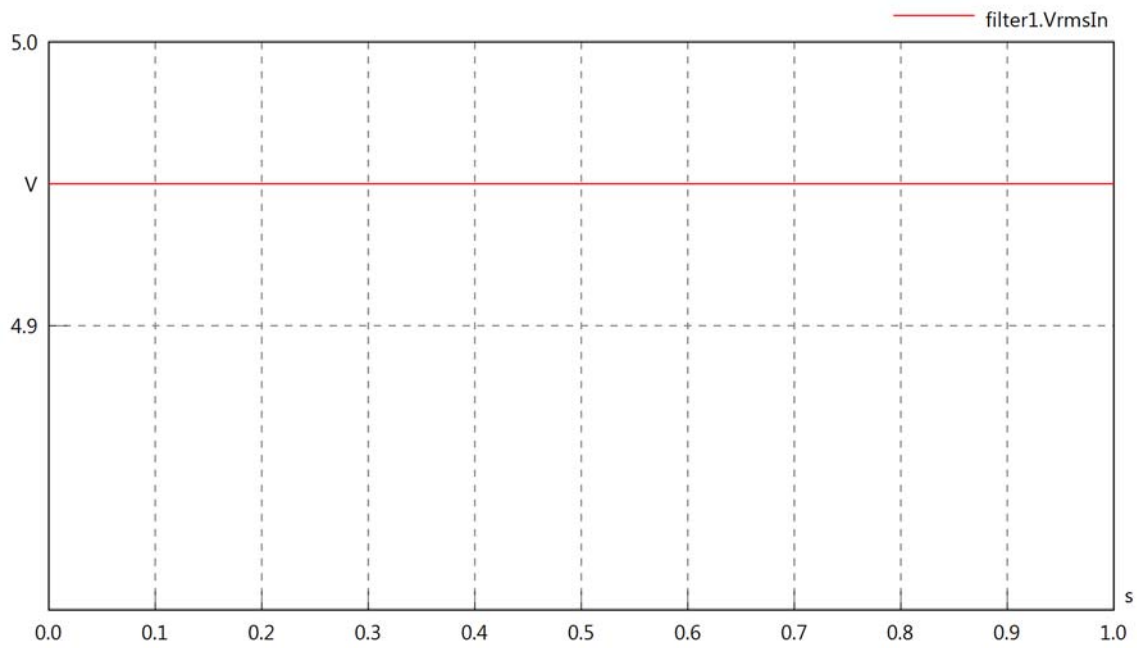

filter1.vReIn

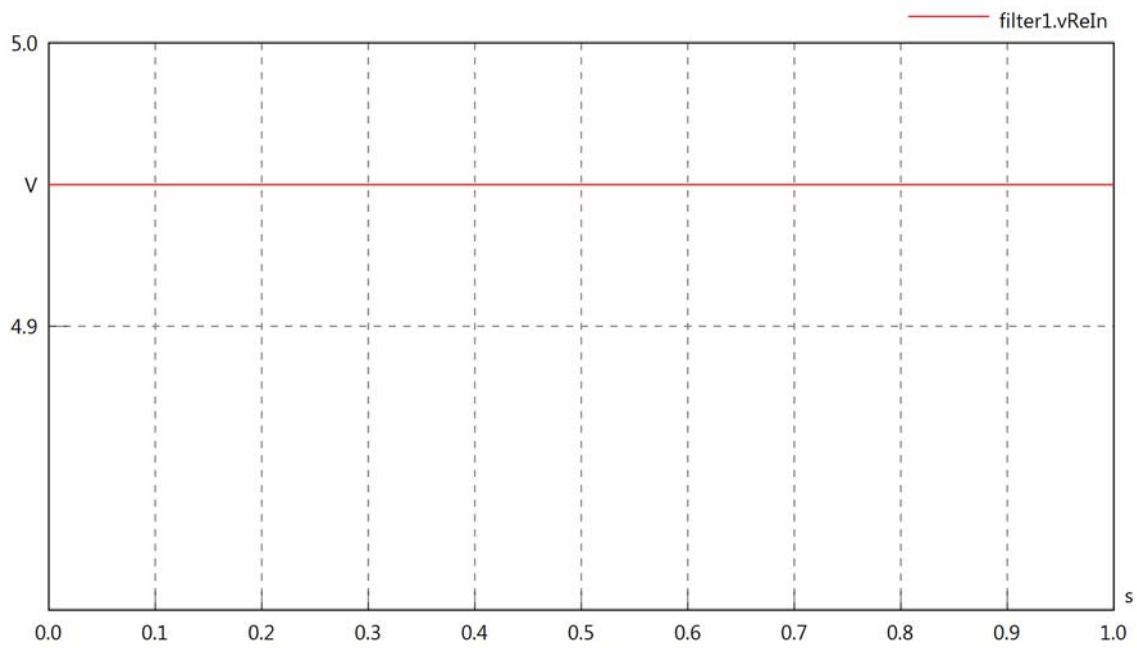

filter1.vImIn

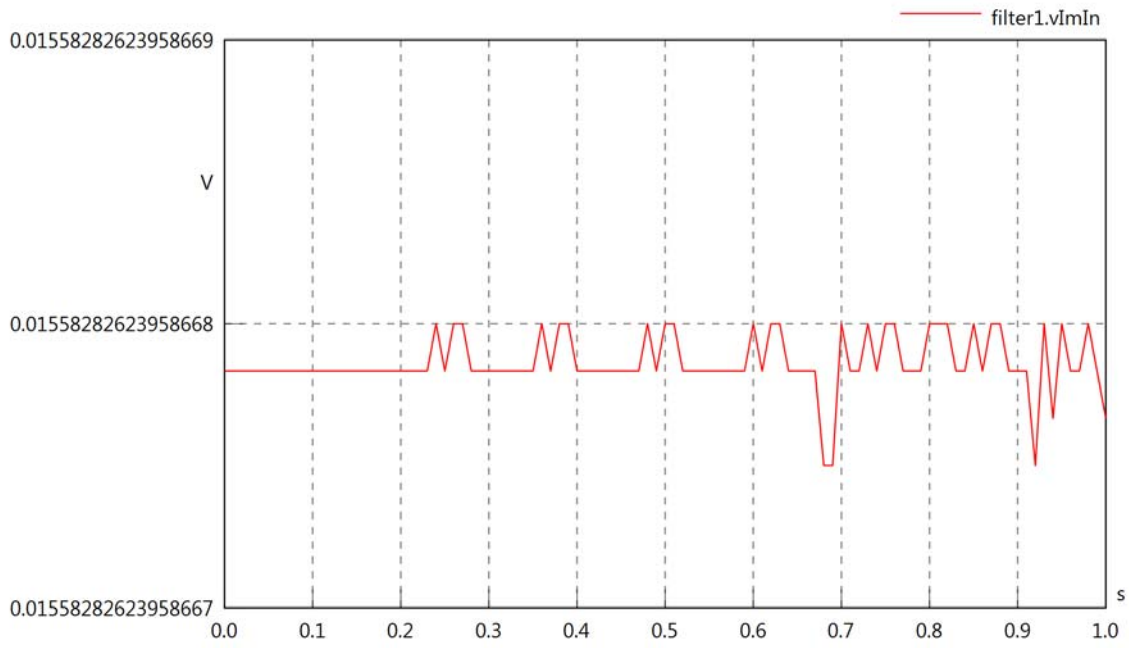

filter1.IrmsIn

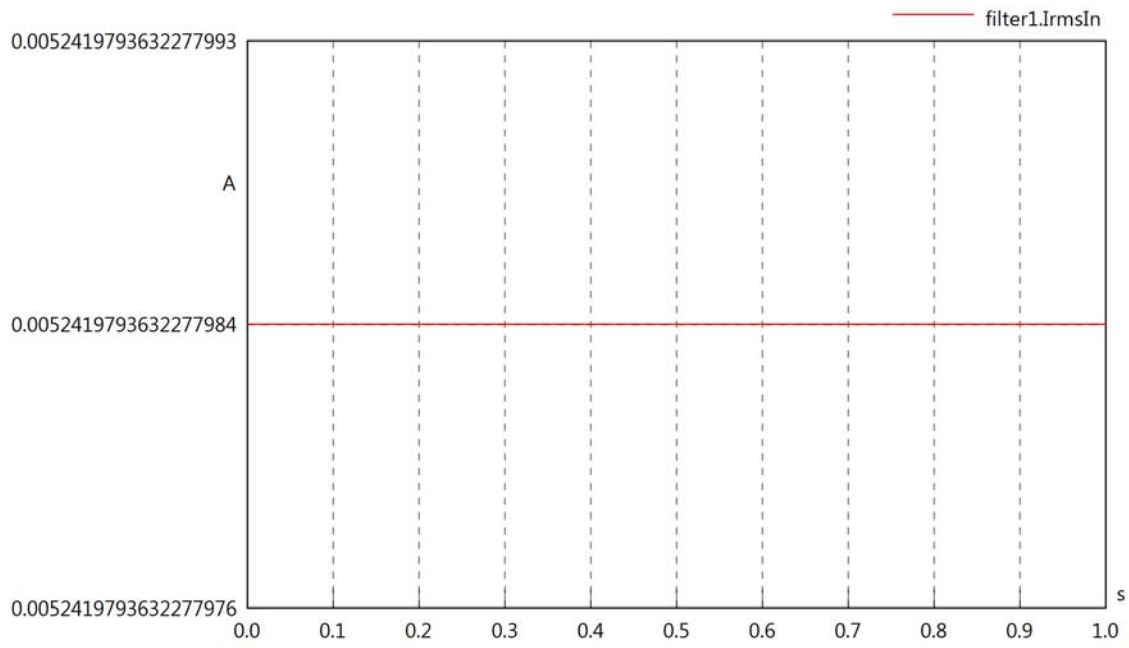

filter1.iReIn

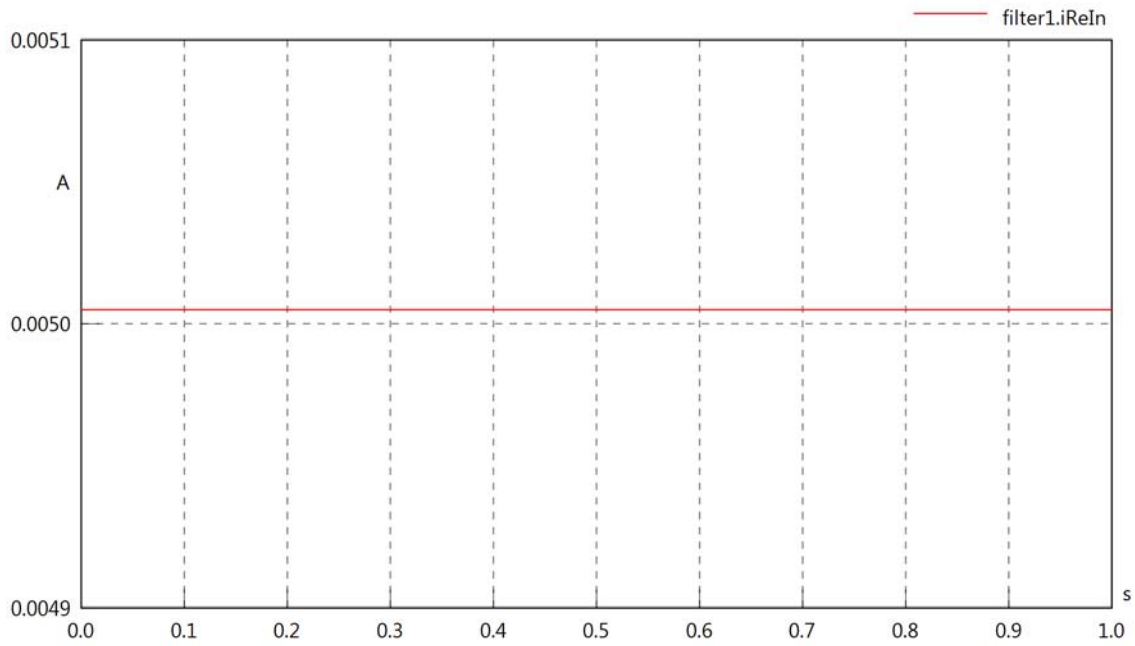

filter1.iImIn

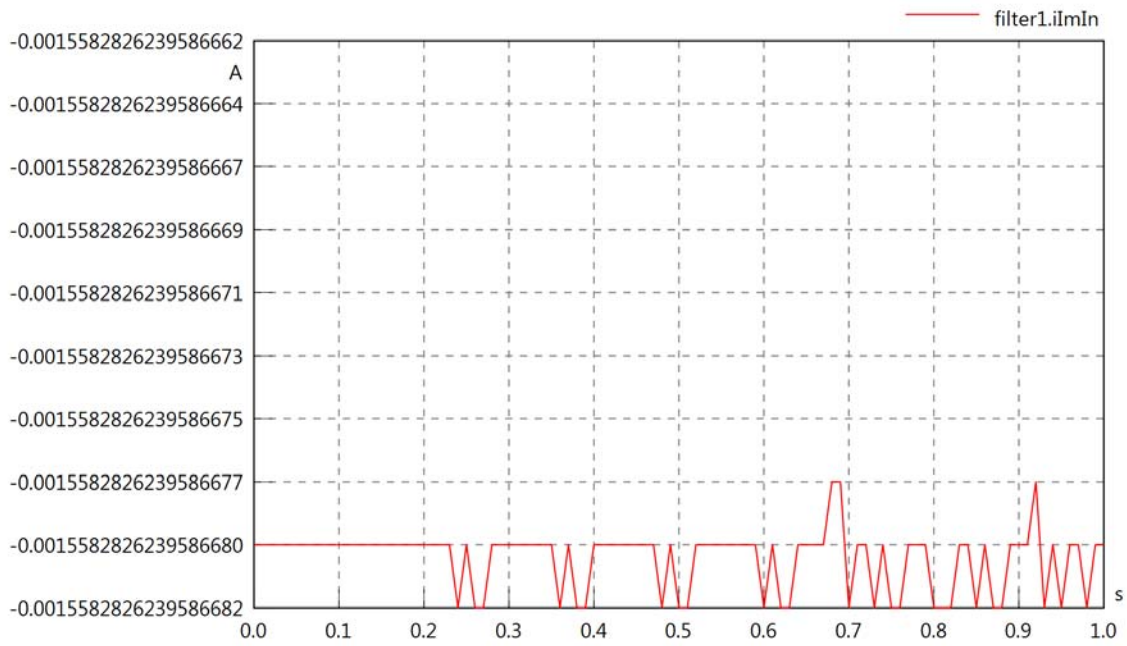

filter1.phiVIn

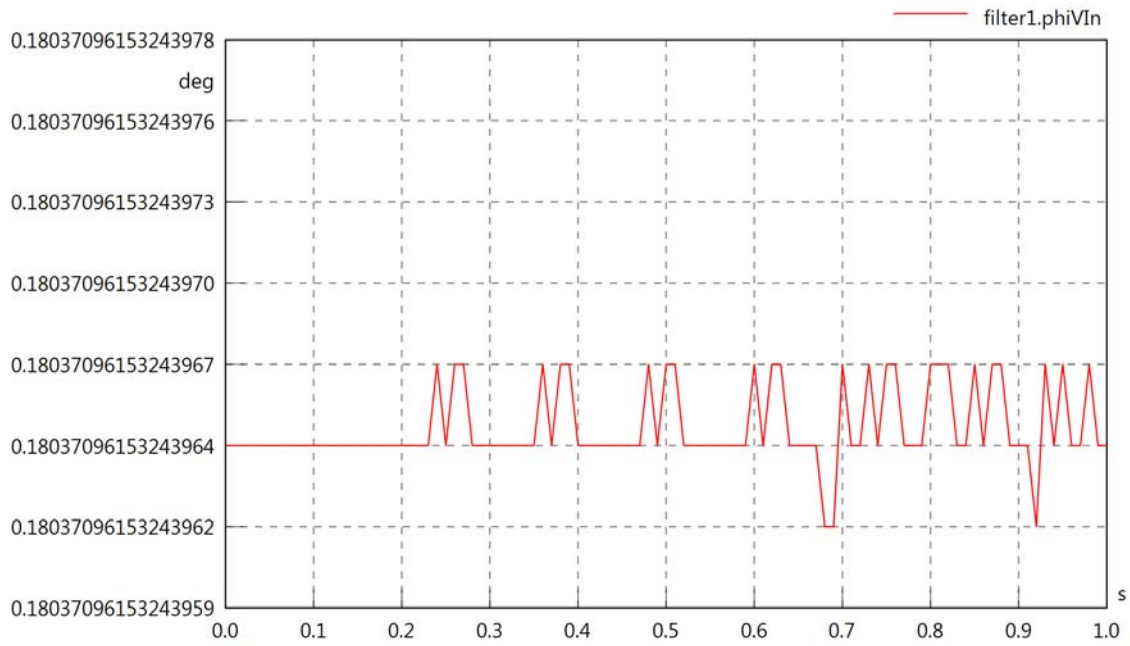

filter1.phiIIn

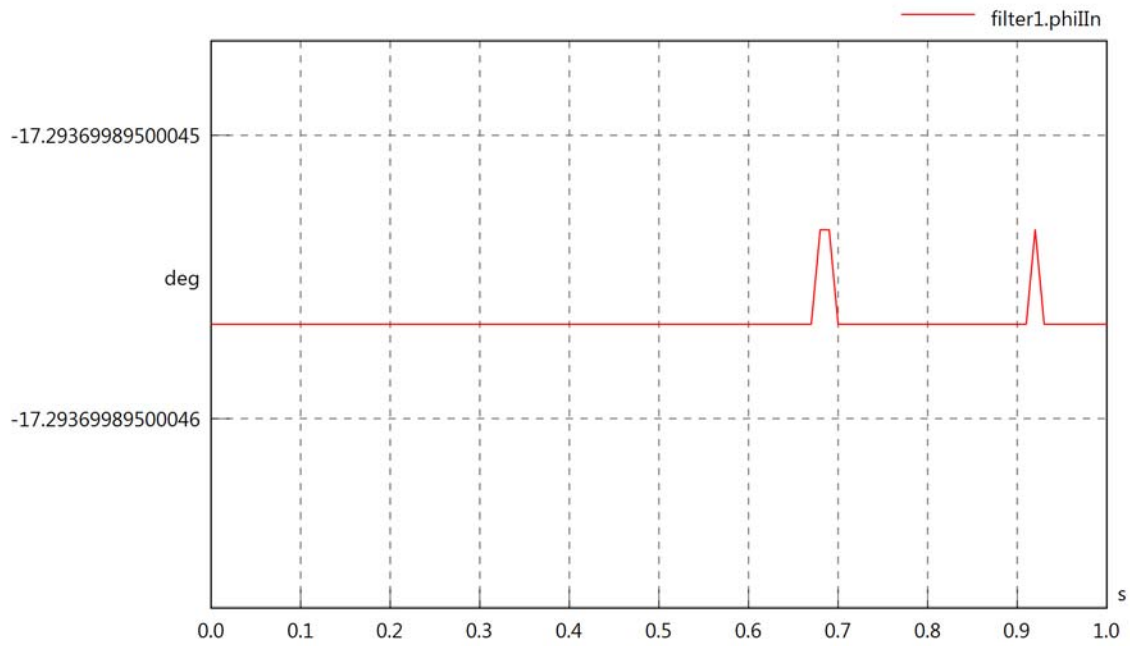

filter1.phiIVIn

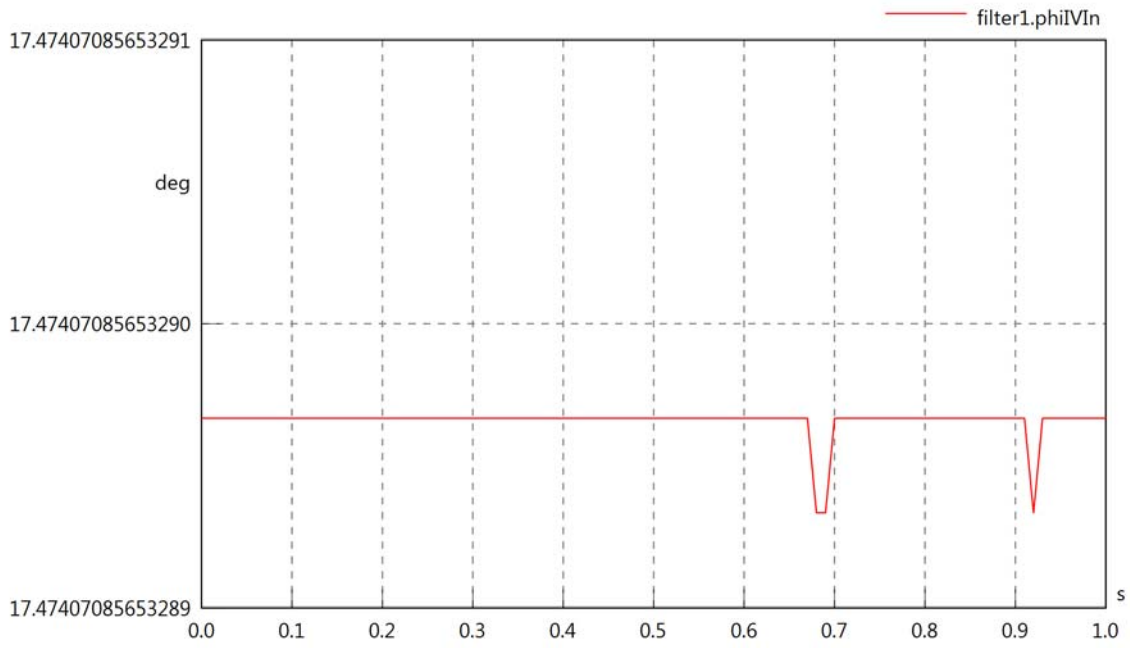

filter1.PReIn

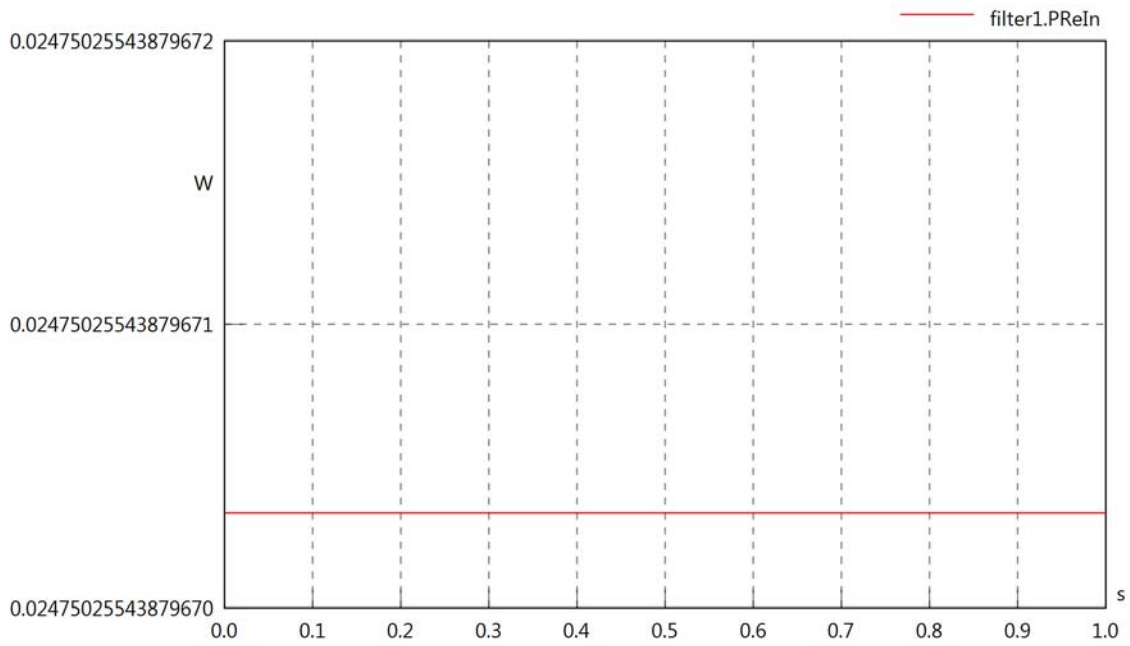

filter1.PImIn

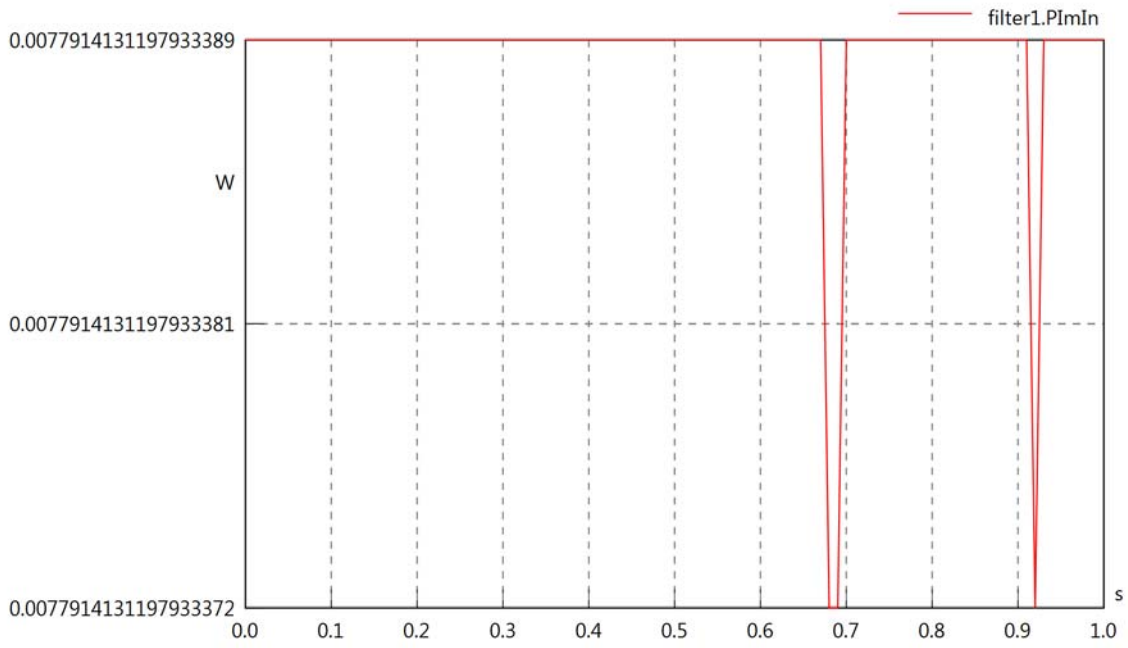

filter1.SIn

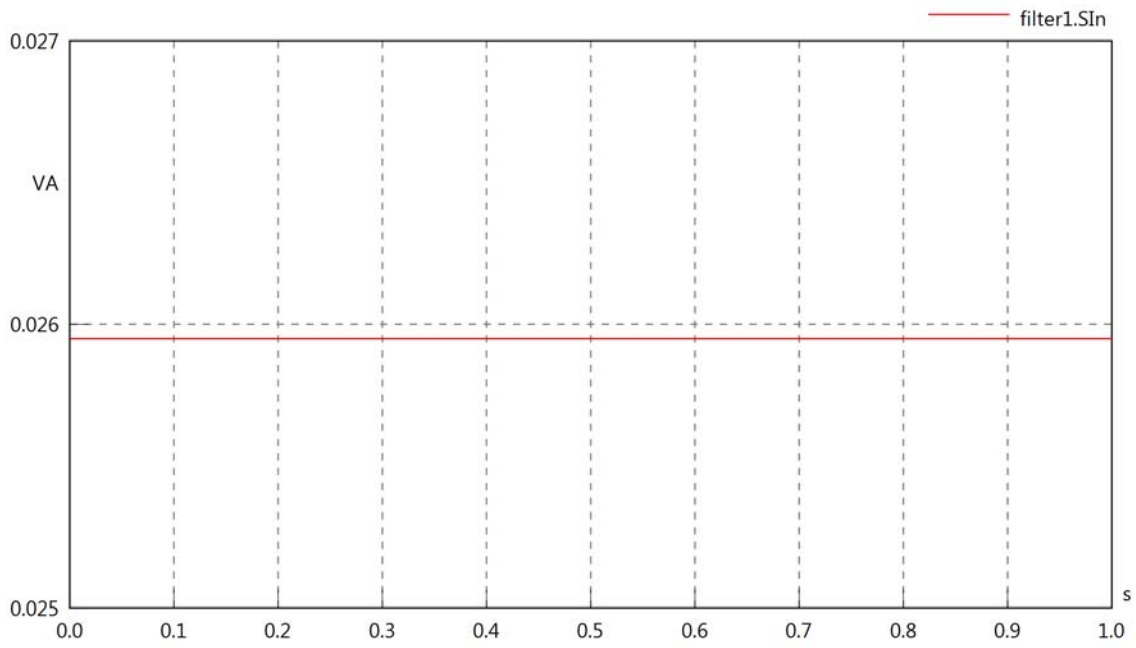

filter1.VrmsOut

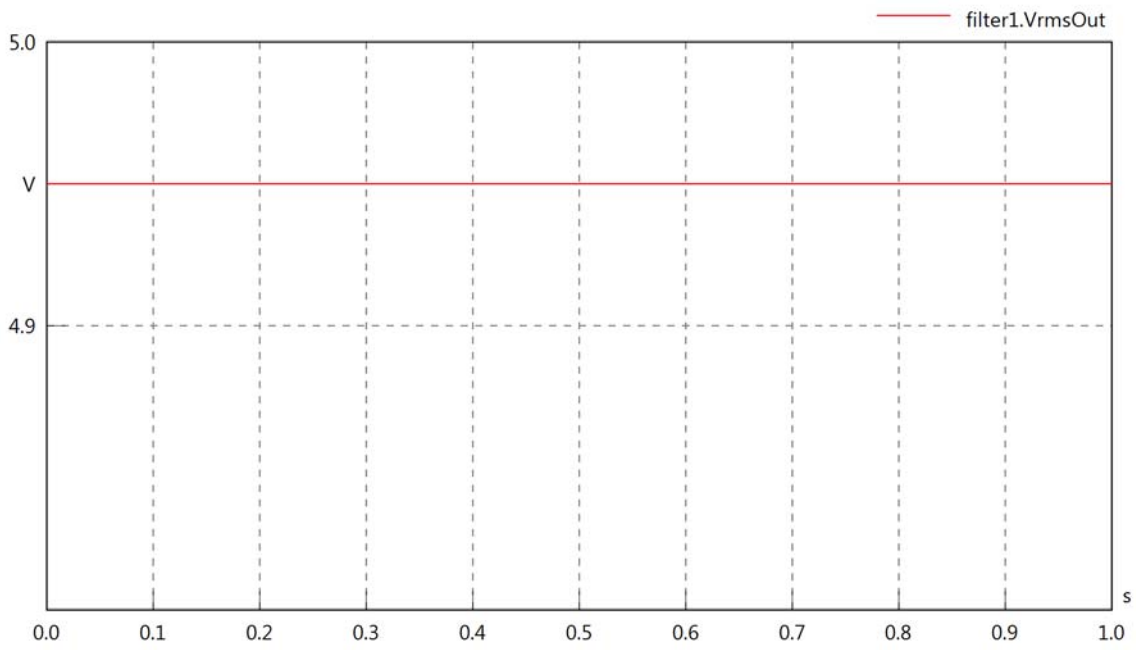

filter1.vReOut

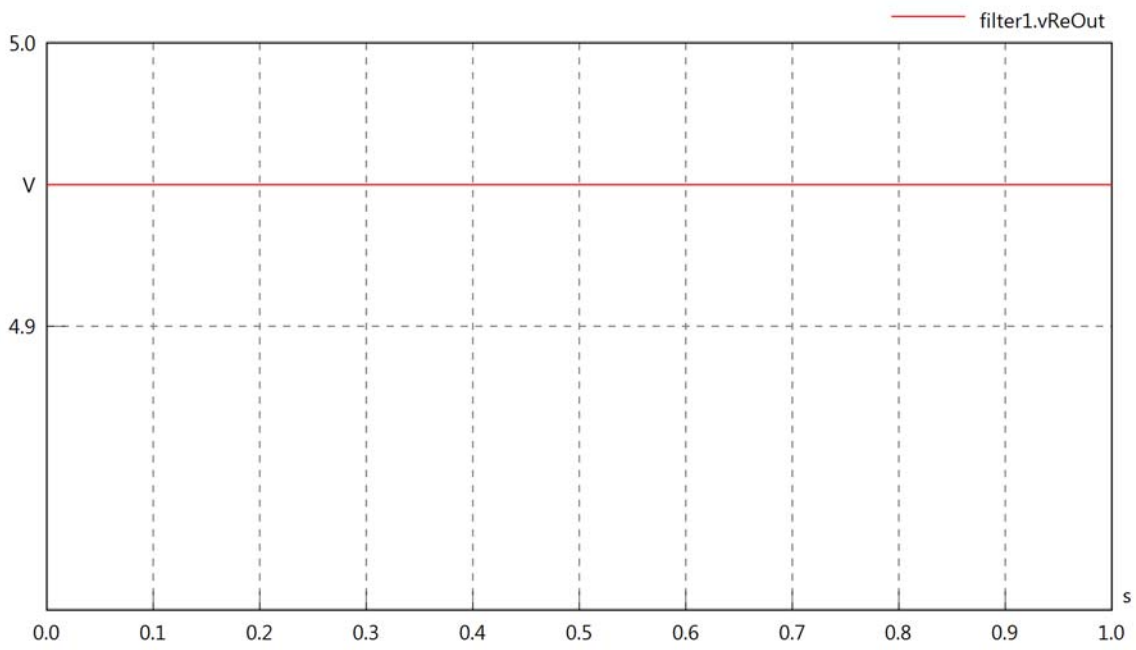

filter1.vImOut

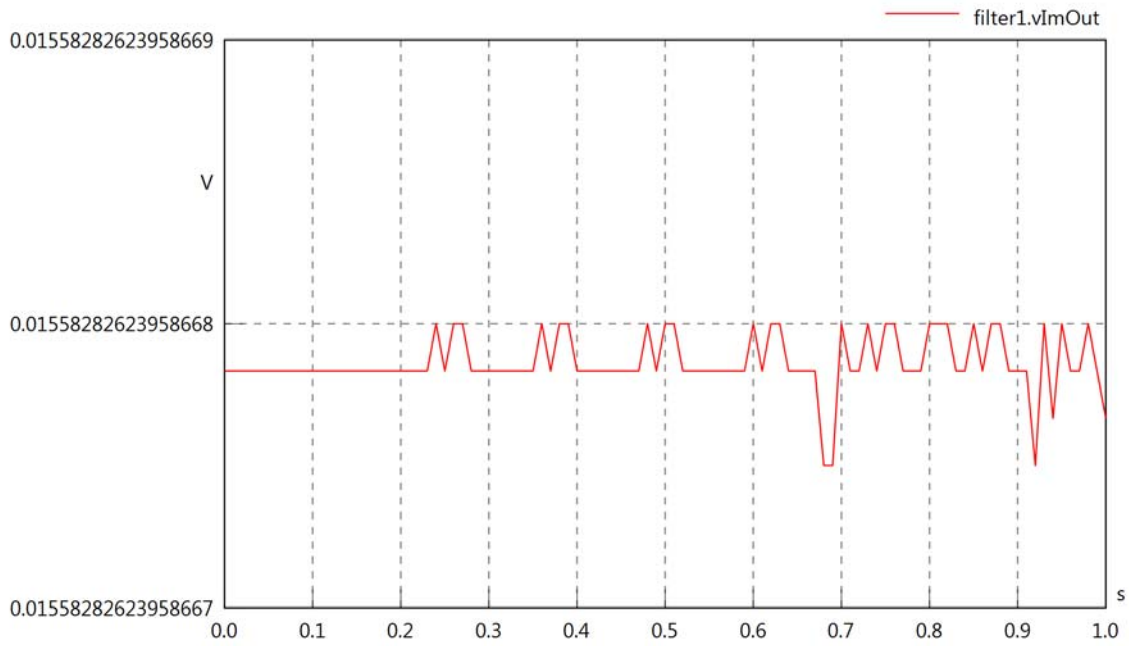

filter1.IrmsOut

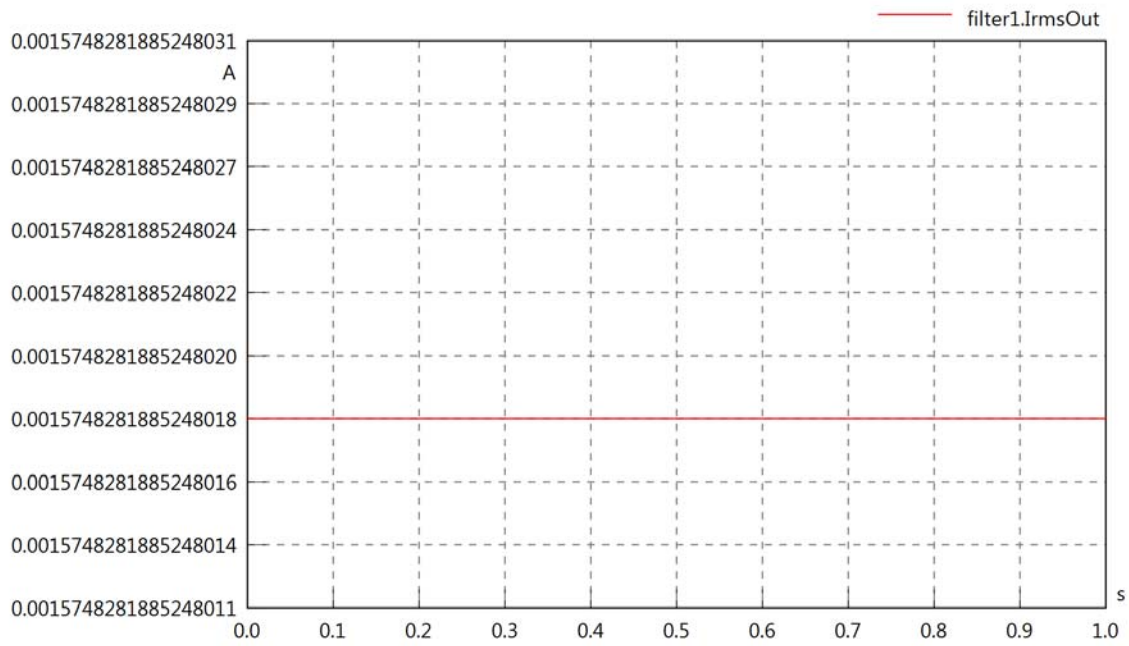

filter1.iReOut

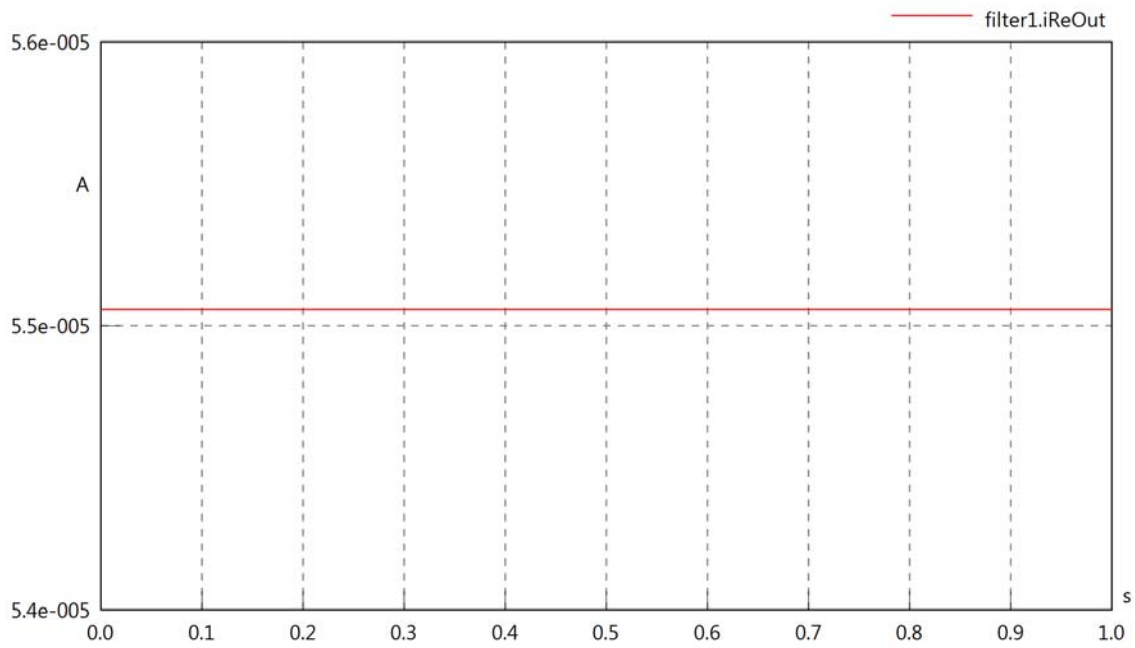

filter1.iImOut

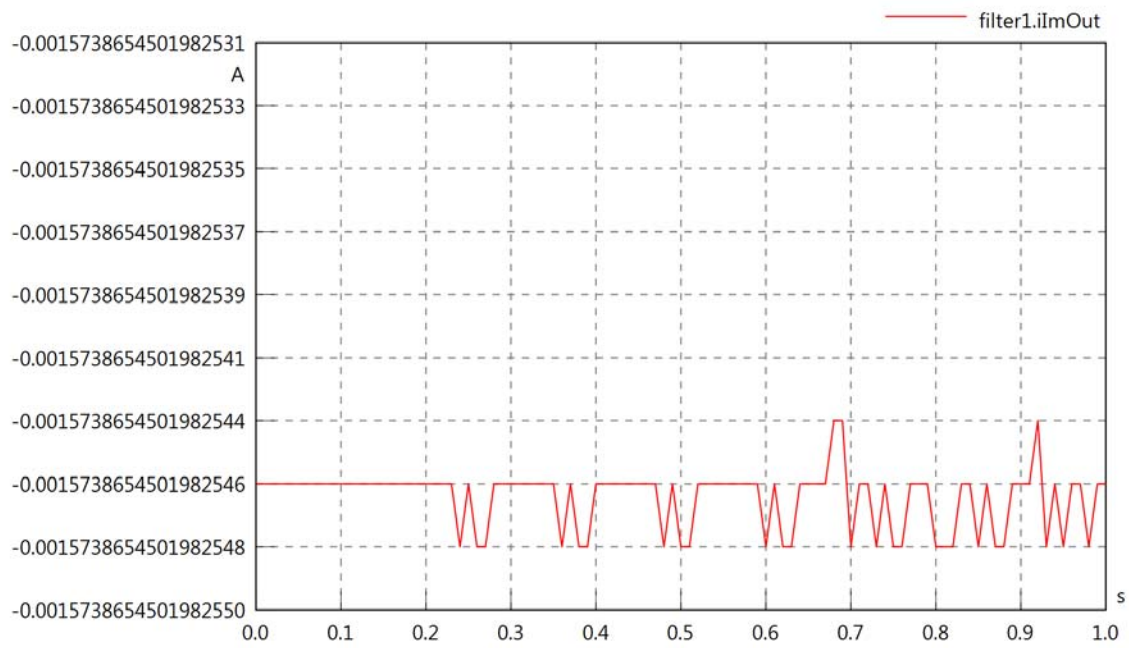

filter1.phiVOut

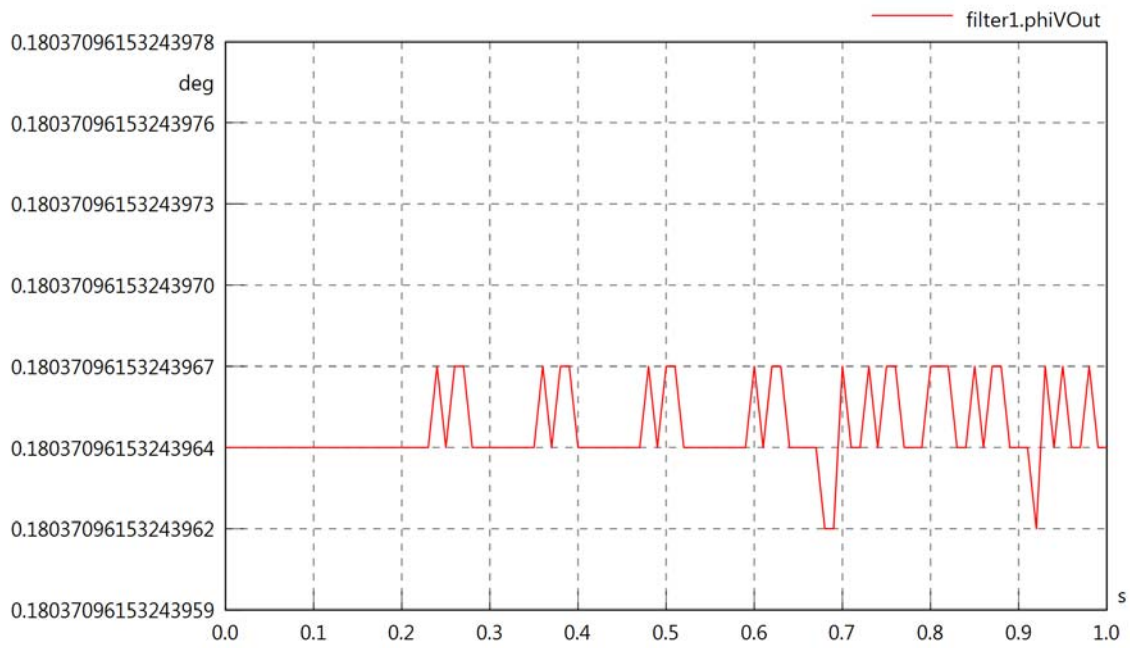

filter1.phiIOut

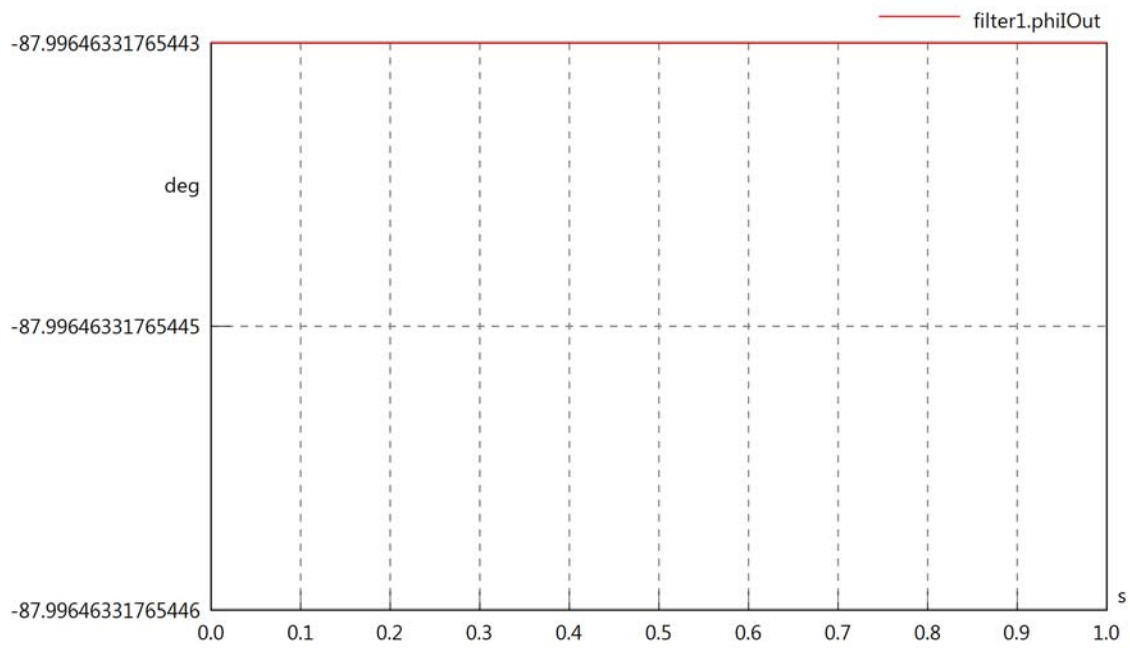

filter1.phiIVOut

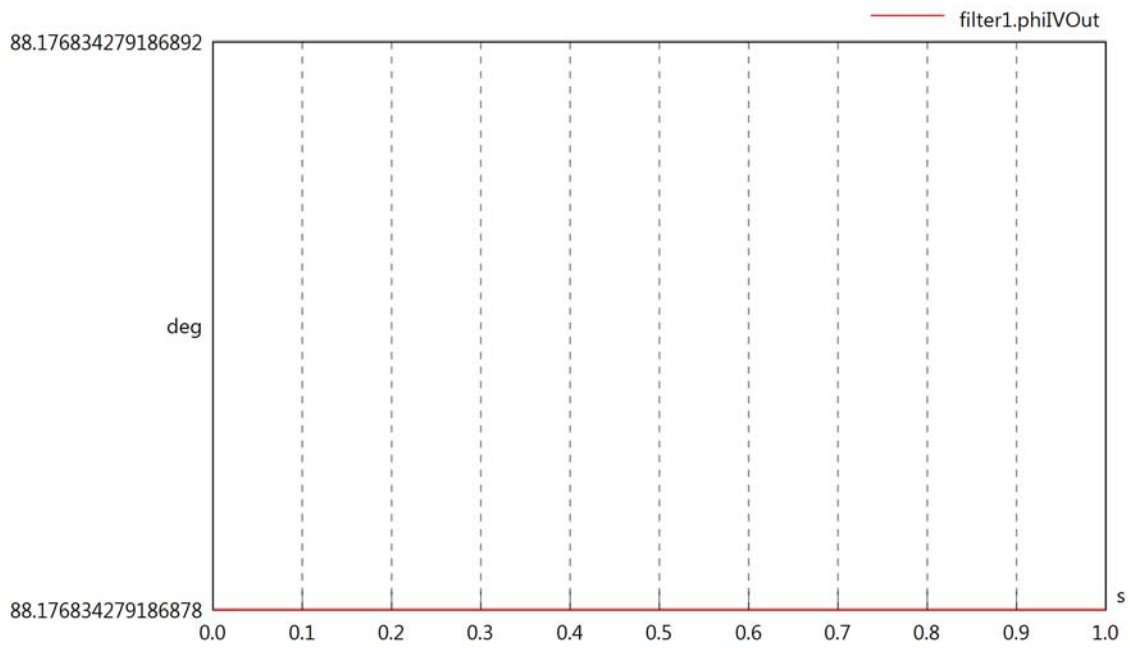

filter1.PReOut

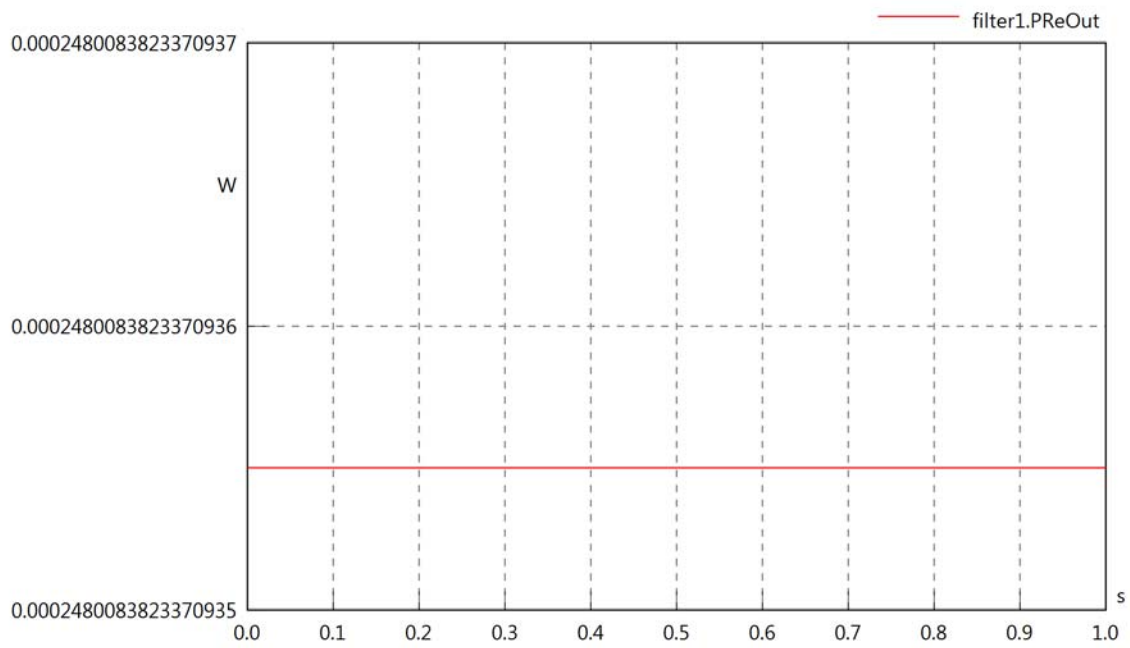

filter1.PImOut

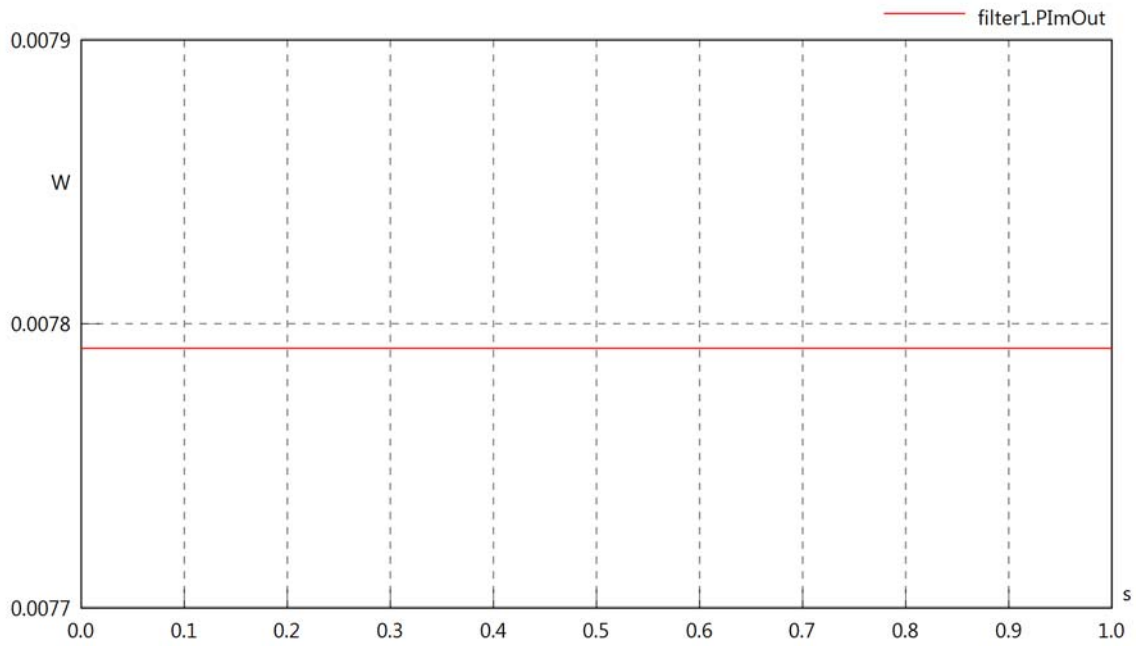

filter1.SOut

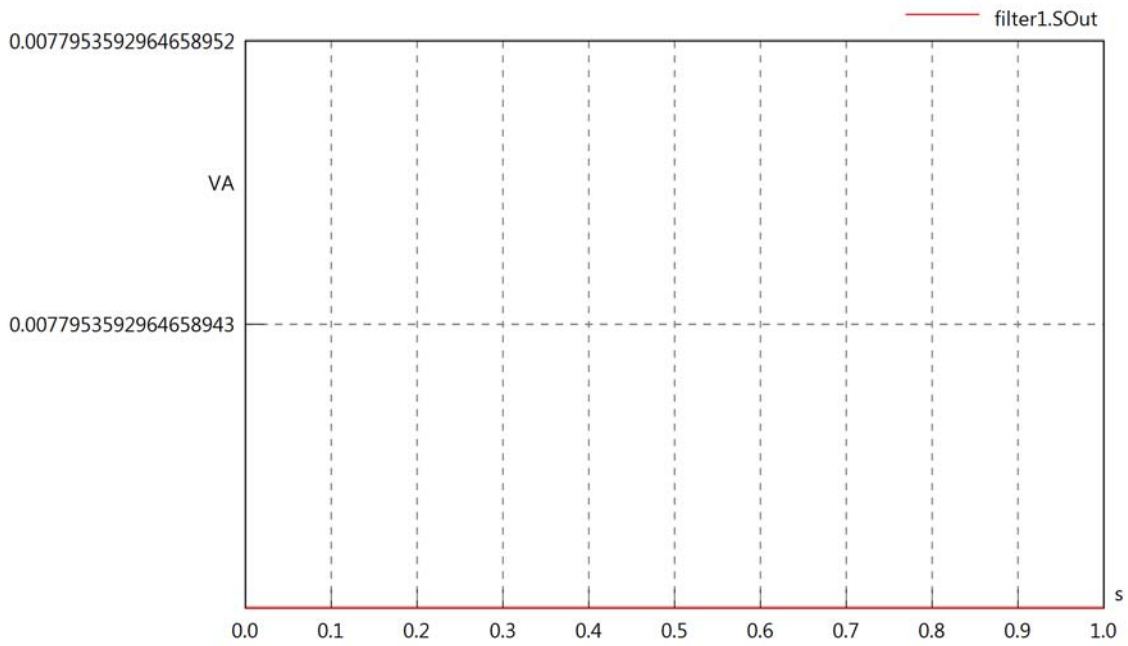
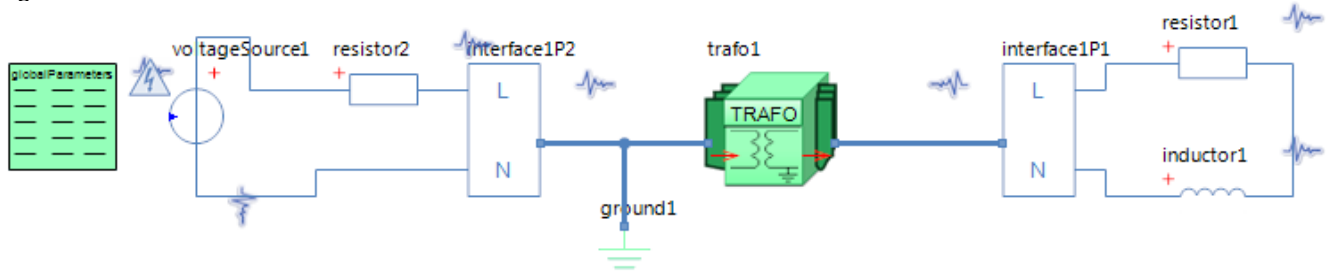

Diagram View



GlobalParameters globalParameters
Parameters

Comment	Name	Current Value	Unit
Type of Calculation	eCalculationKind	Signal Calculation	
Description of Frequency	eFrequencyKind	Linear	
Minimum Frequency	fMin	60	[Hz]
Maximum Frequency	fMax	60	[Hz]

Transformer trafo1
Parameters

Comment	Name	Current Value	Unit
Transformer Type	kind	Lossless Transformer	
Primary Inductance	L1	40	[mH]
Initial Value	i10	0 (Fixed)	[A]
Secondary Inductance	L2	80	[mH]
Initial Value	i20	0 (Fixed)	[A]
Mutual Coupling Inductance	M	$0.75 \cdot \sqrt{L1 \cdot L2}$	[H]

Voltage Source voltageSource1
Parameters

Comment	Name	Current Value	Unit
Voltage RMS	VrmsSrc	230	[V]
Phase	phi	0	[deg]

Resistor resistor1
Parameters

Comment	Name	Current Value	Unit
Resistance	R	50	[Ohm]

Inductor inductor1
Parameters

Comment	Name	Current Value	Unit
Inductance	L	5	[mH]

Resistor resistor2
Parameters

Comment	Name	Current Value	Unit
Resistance	R	10	[Ohm]

trafo1.n

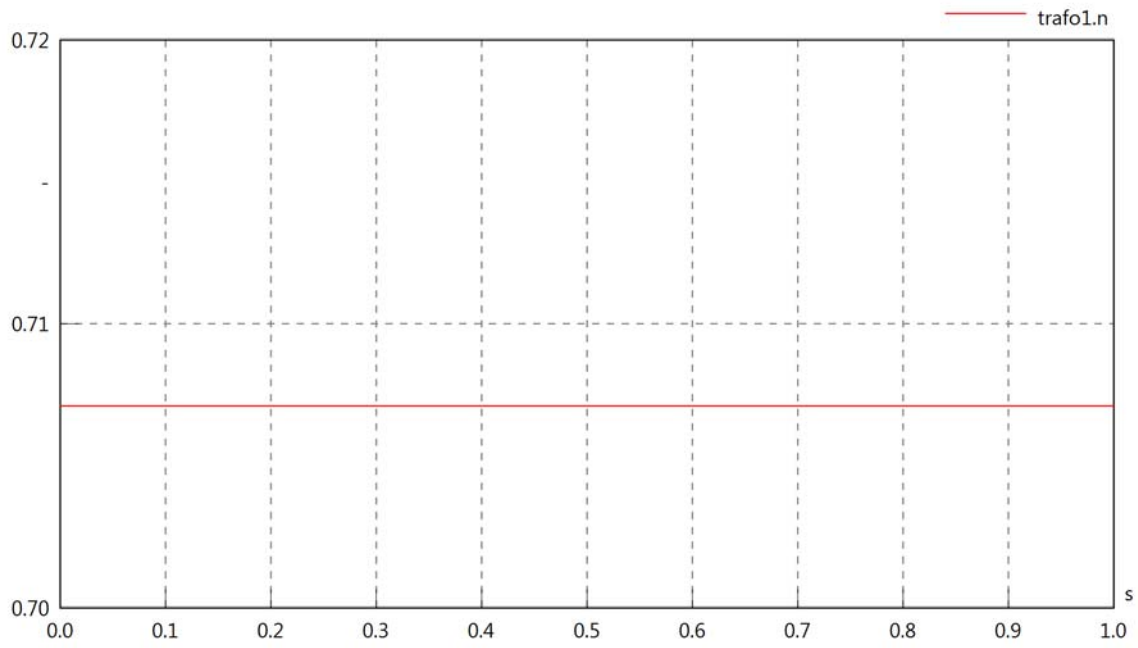

trafo1.k

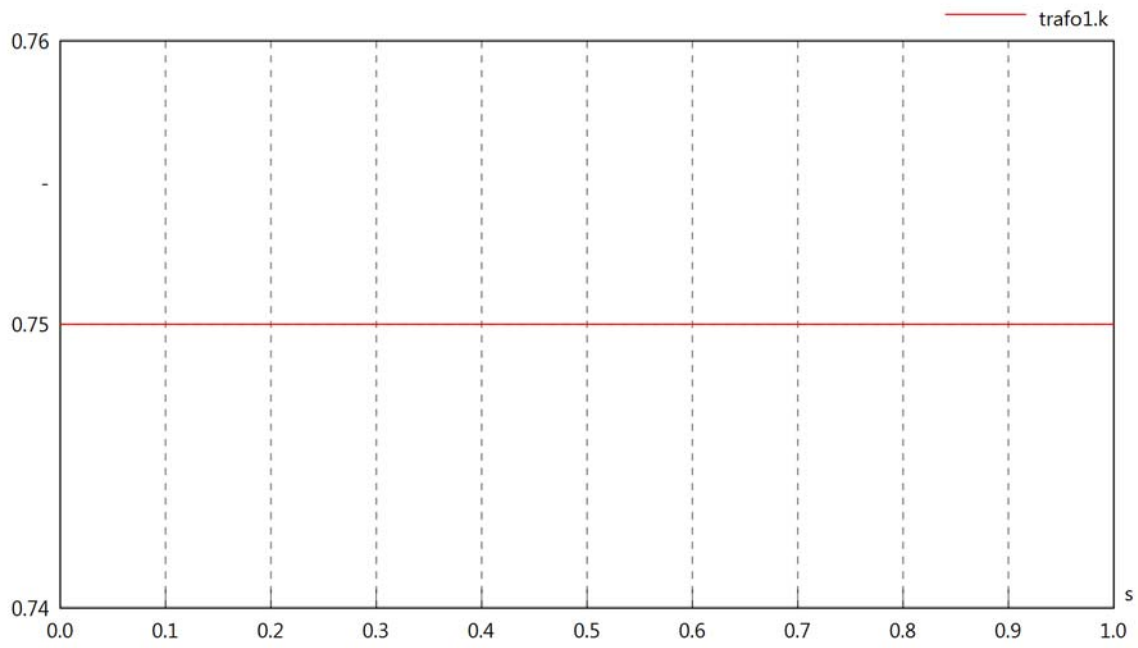

trafo1.VrmsIn

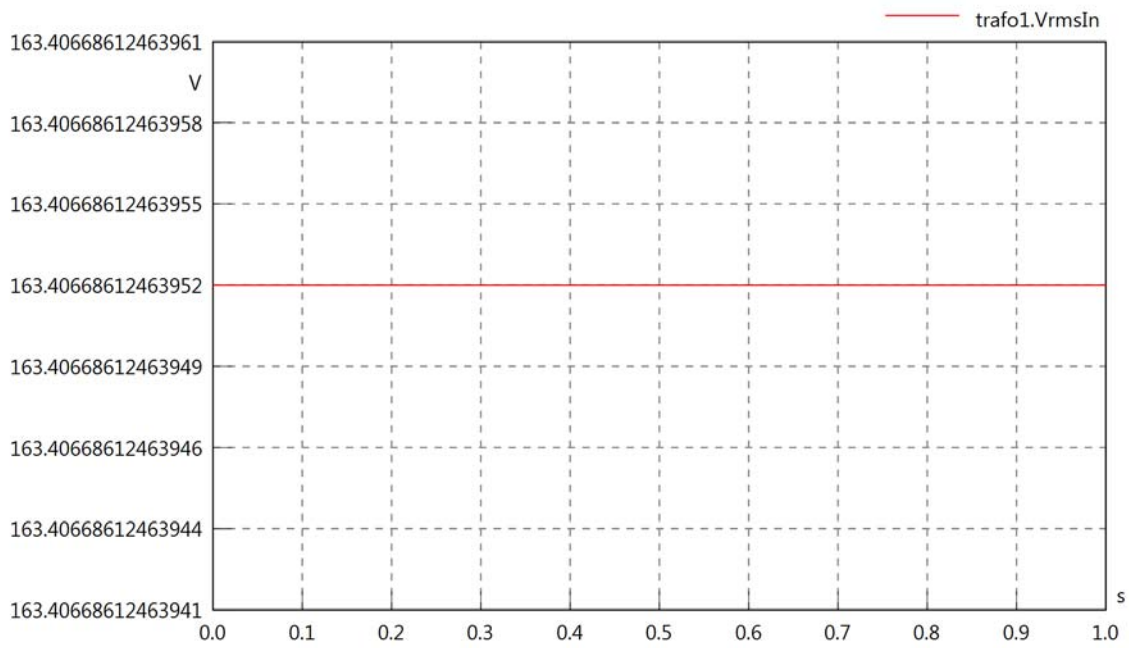

trafo1.vReIn

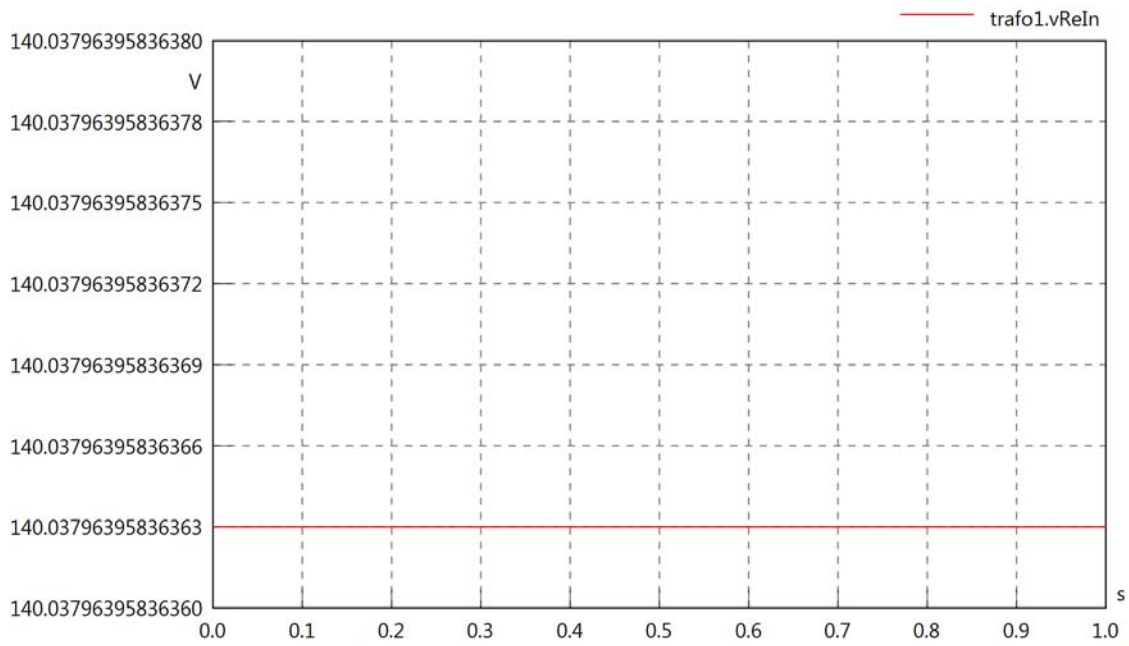

trafo1.vImIn

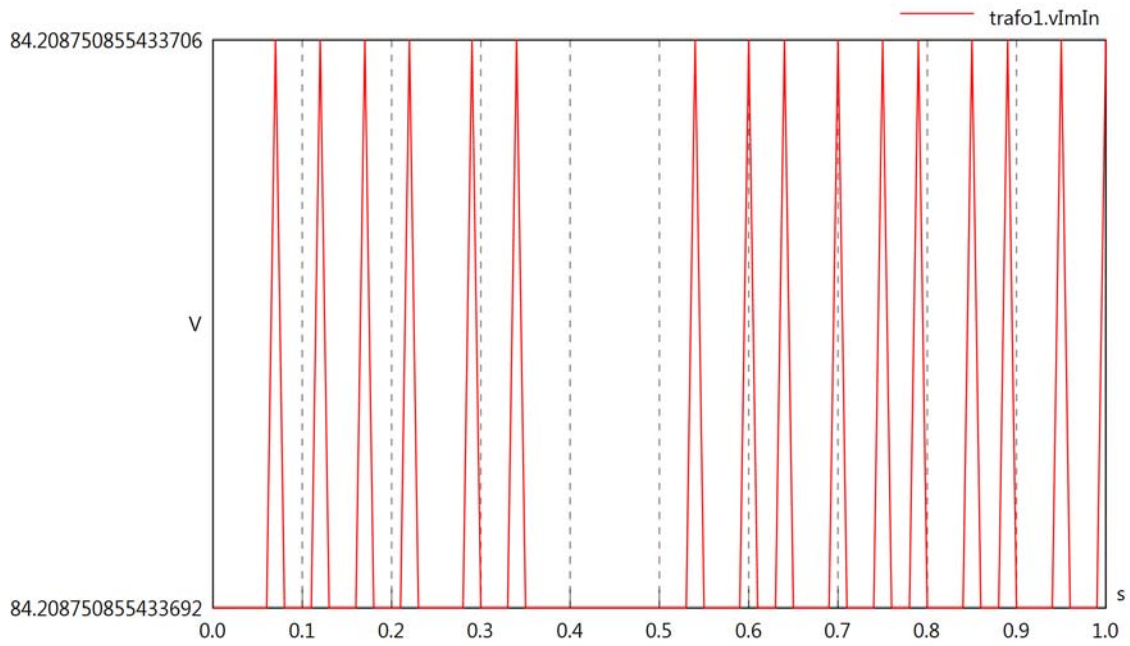

trafo1.IrmsIn

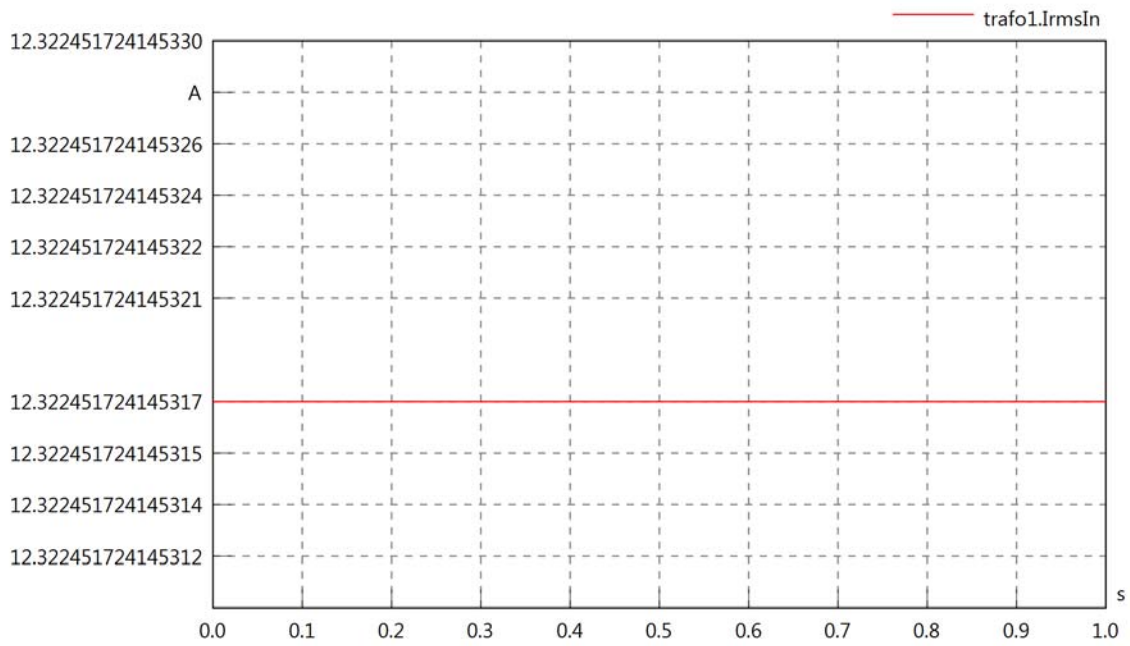

trafo1.iReIn

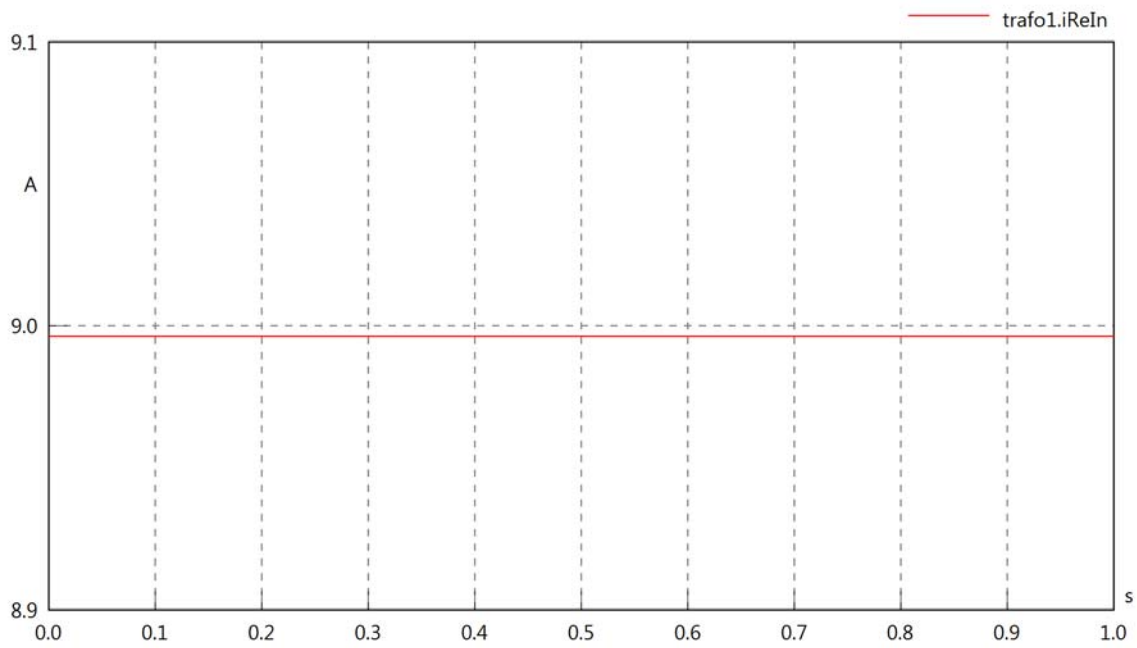

trafo1.iImIn

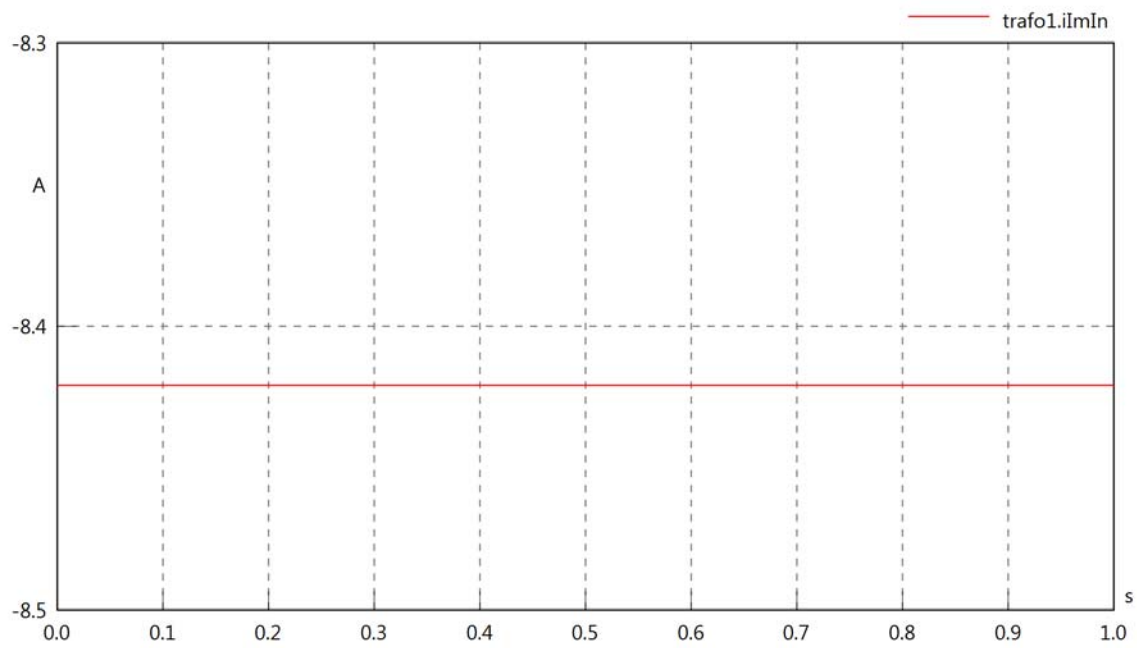

trafo1.phiVIn

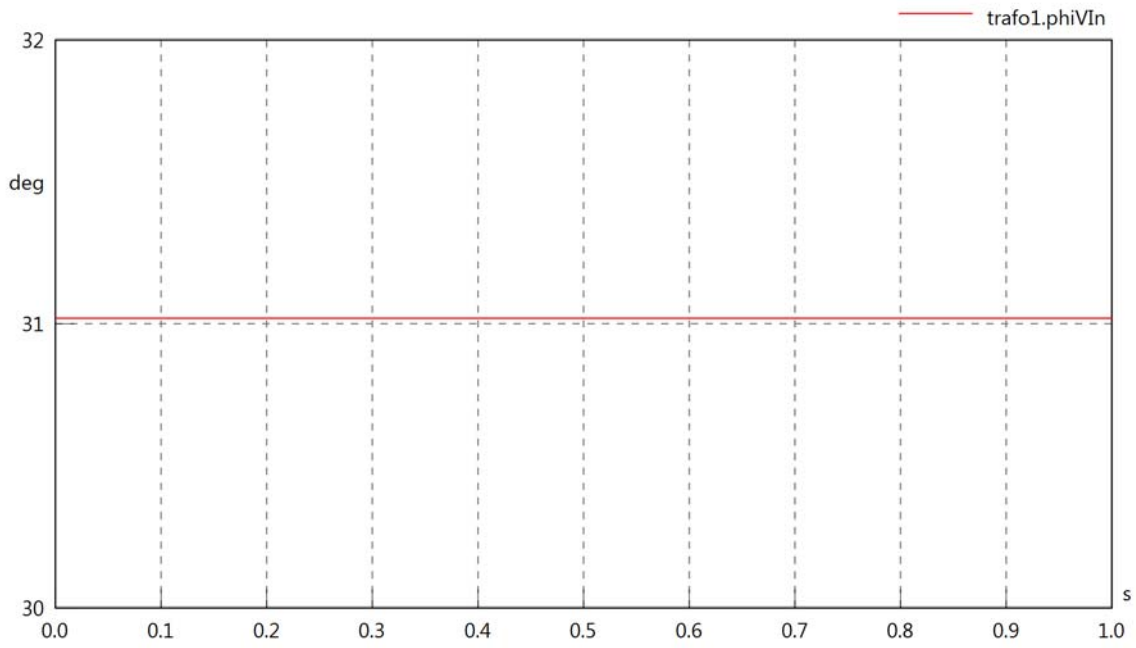

trafo1.phiIn

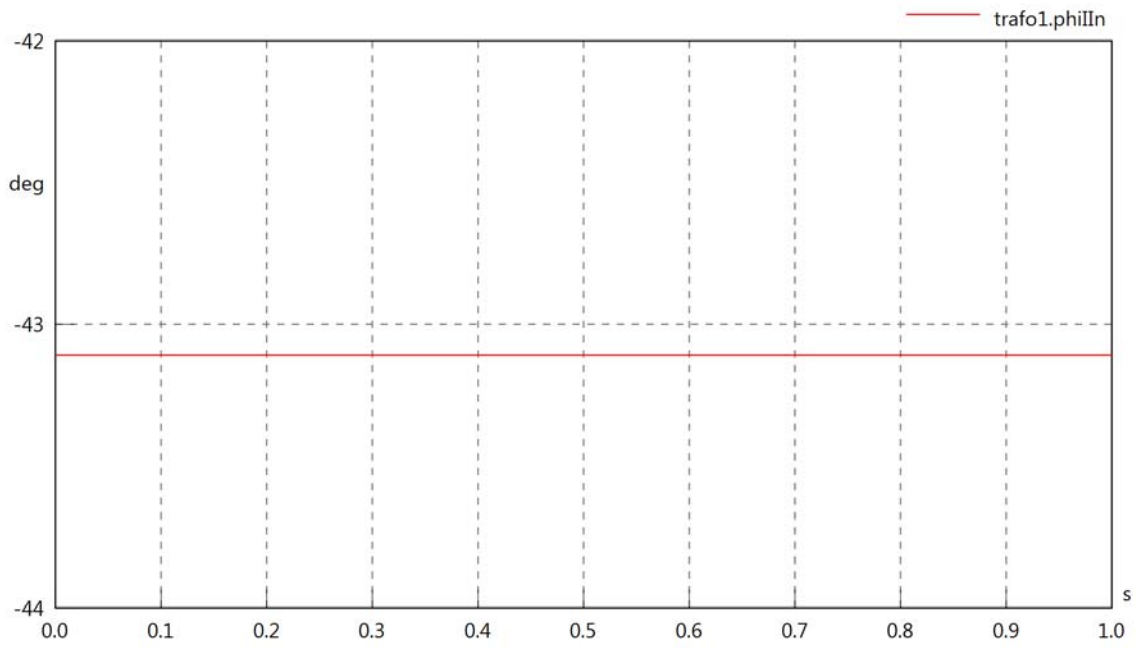

trafo1.phiIVIn

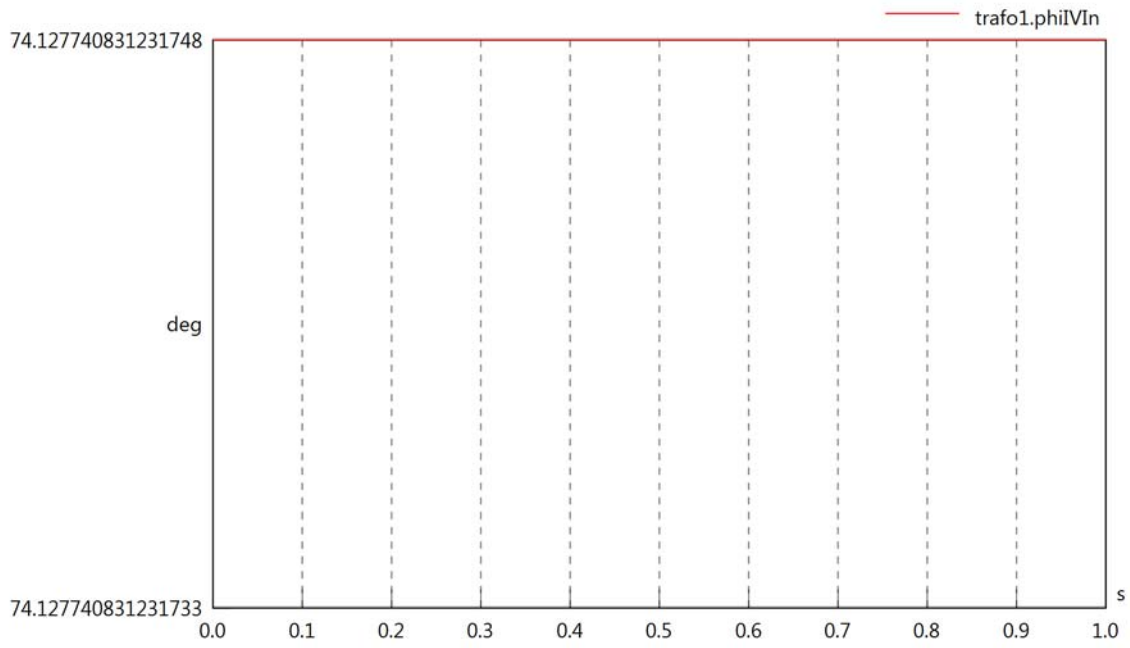

trafo1.PReIn

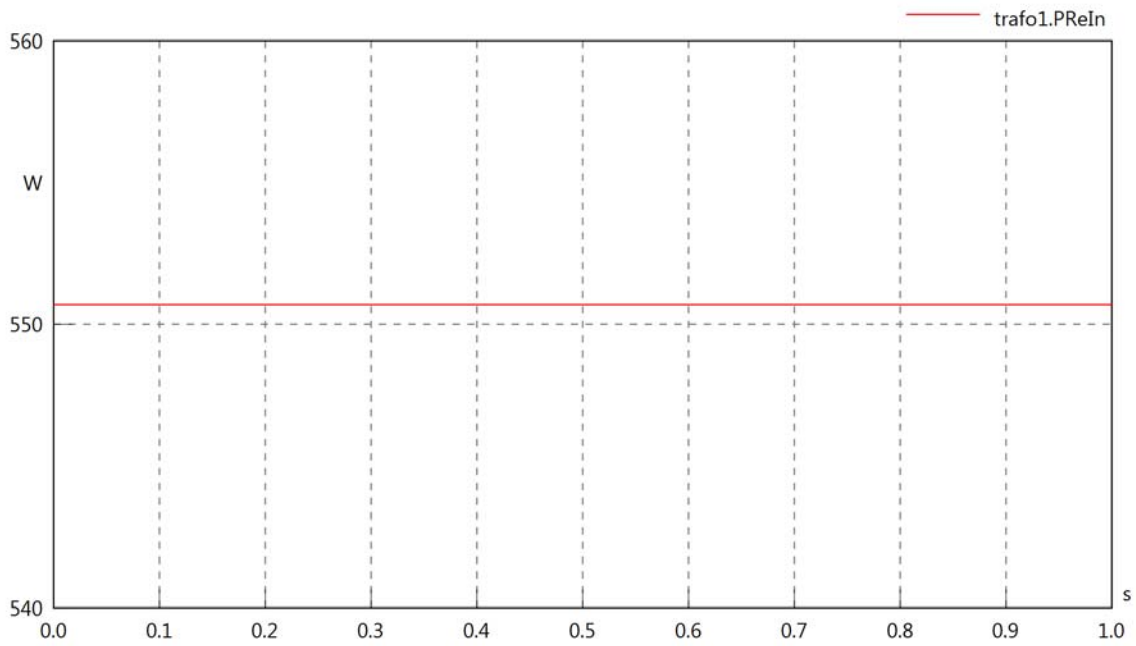

trafo1.PImIn

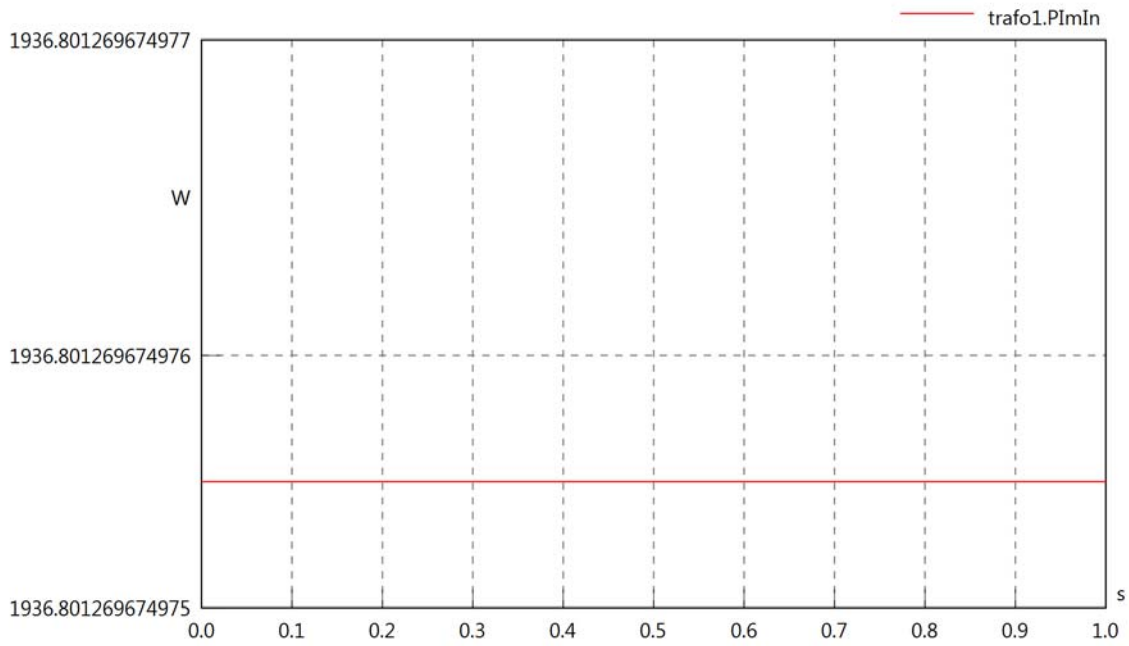

trafo1.SIn

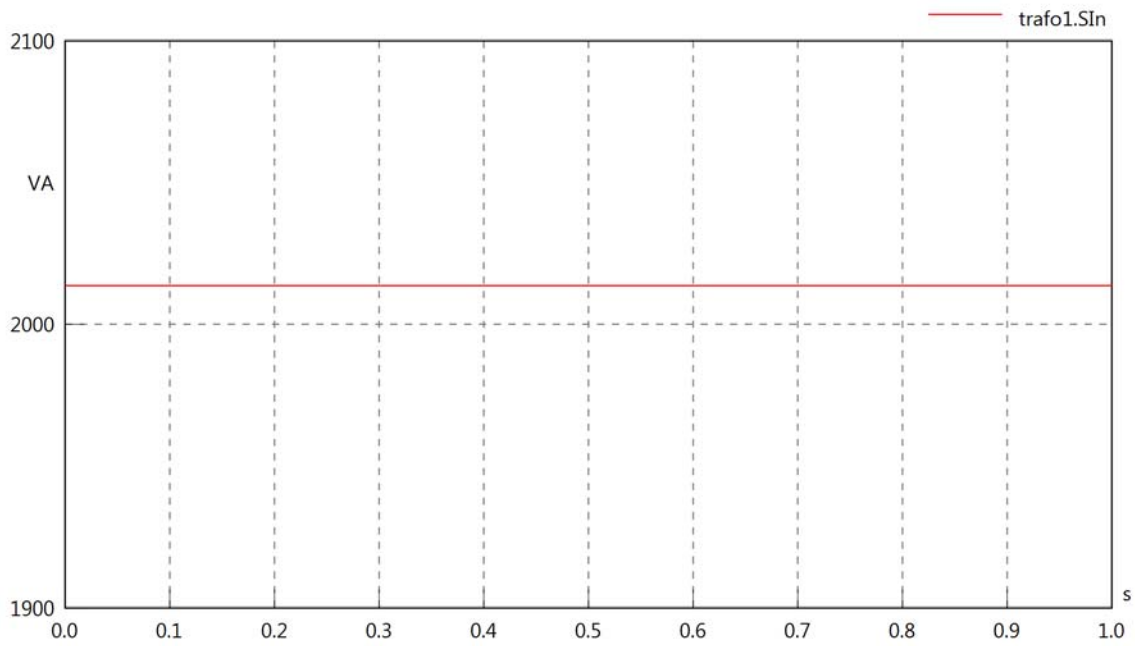

trafo1.pfIn

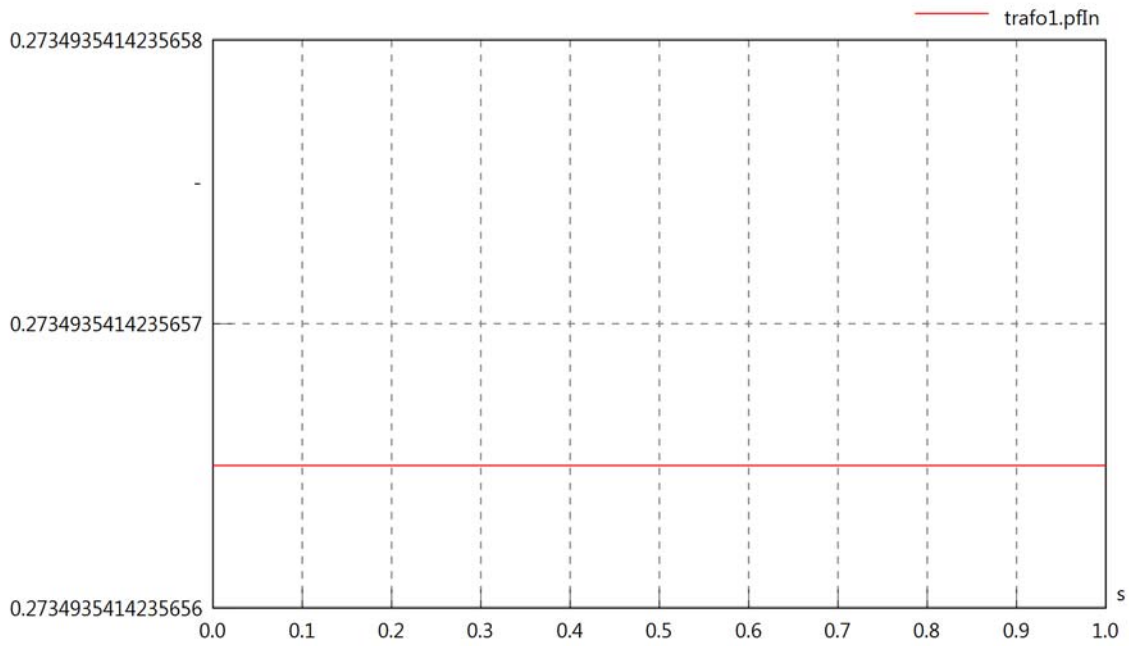

trafo1.VrmsOut

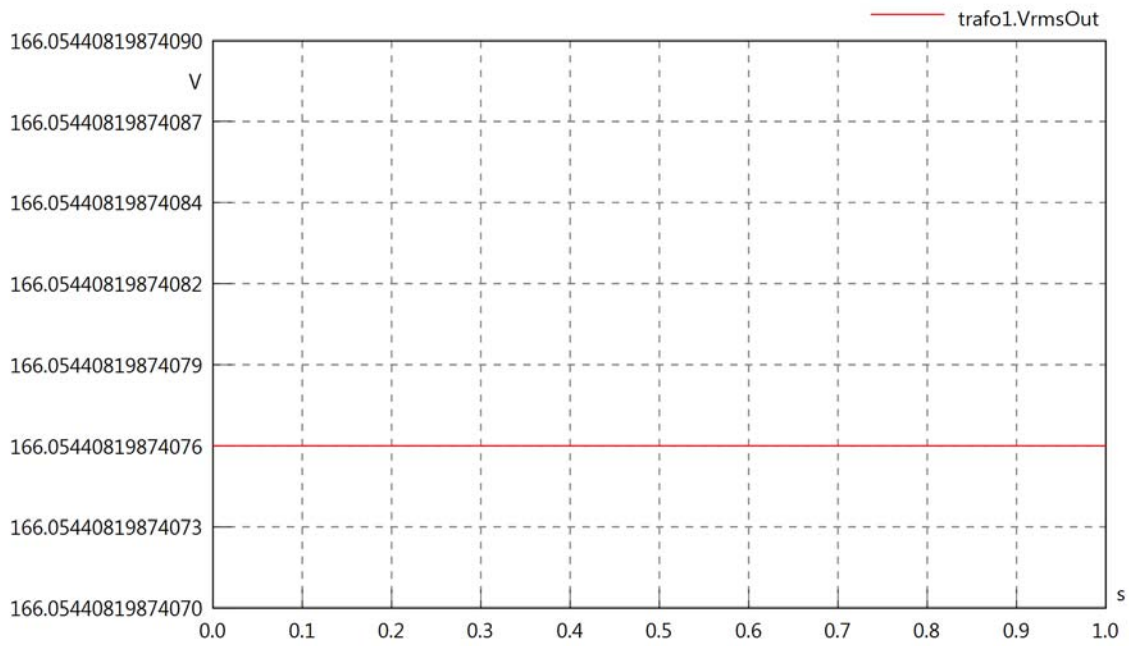

trafo1.vReOut

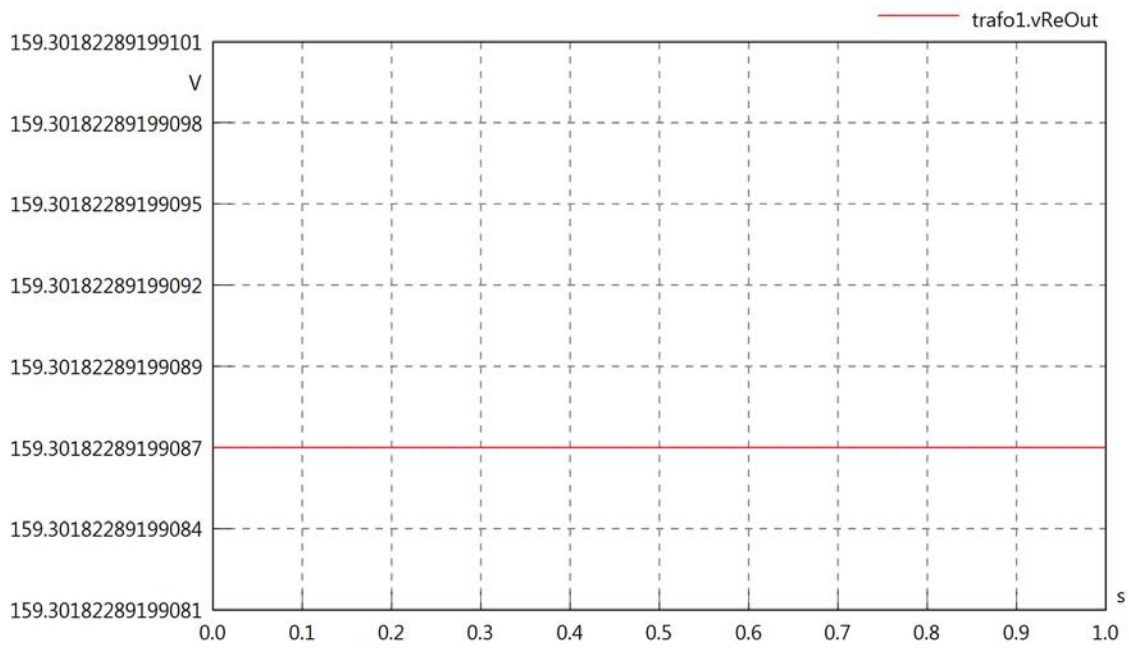

trafo1.vImOut

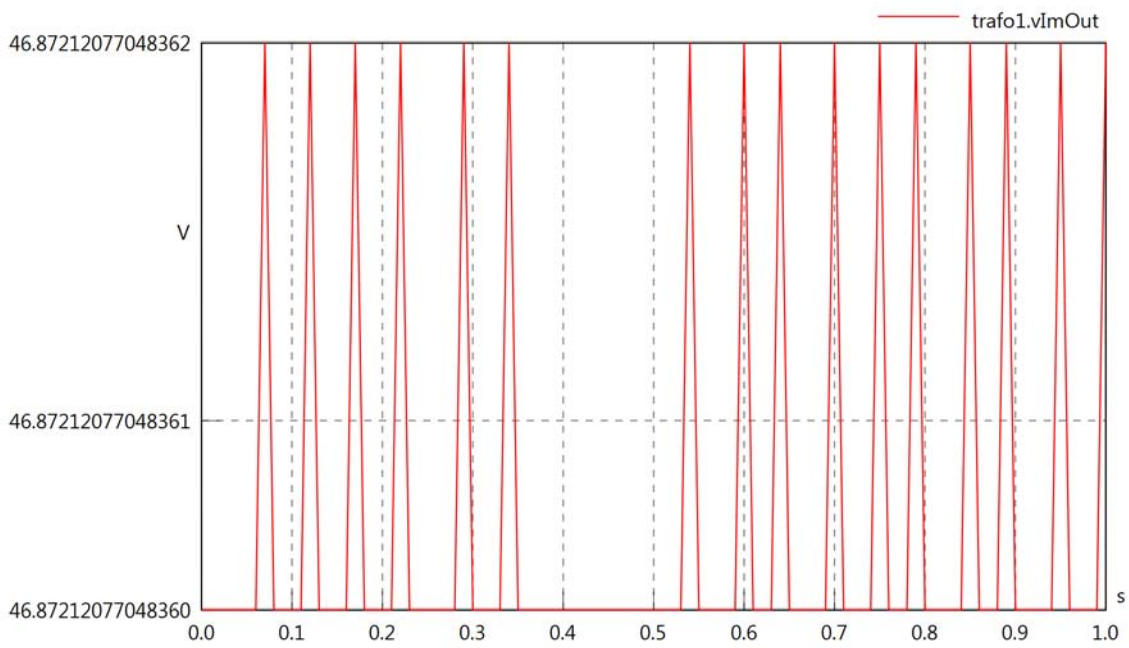

trafo1.IrmsOut

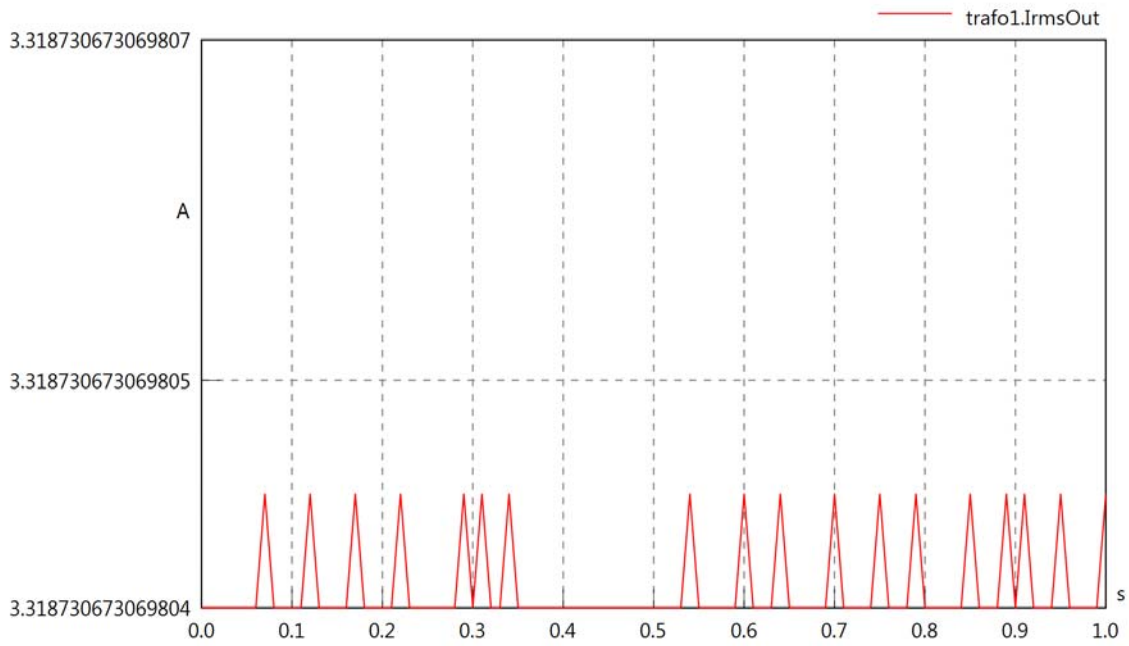

trafo1.iReOut

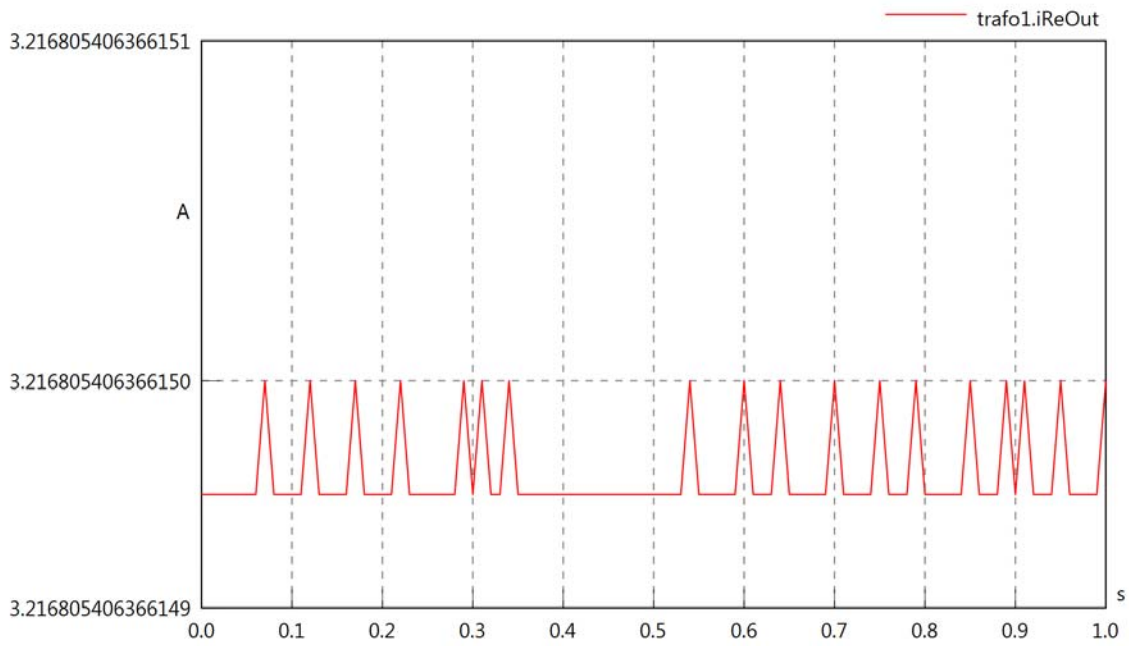

trafo1.iImOut

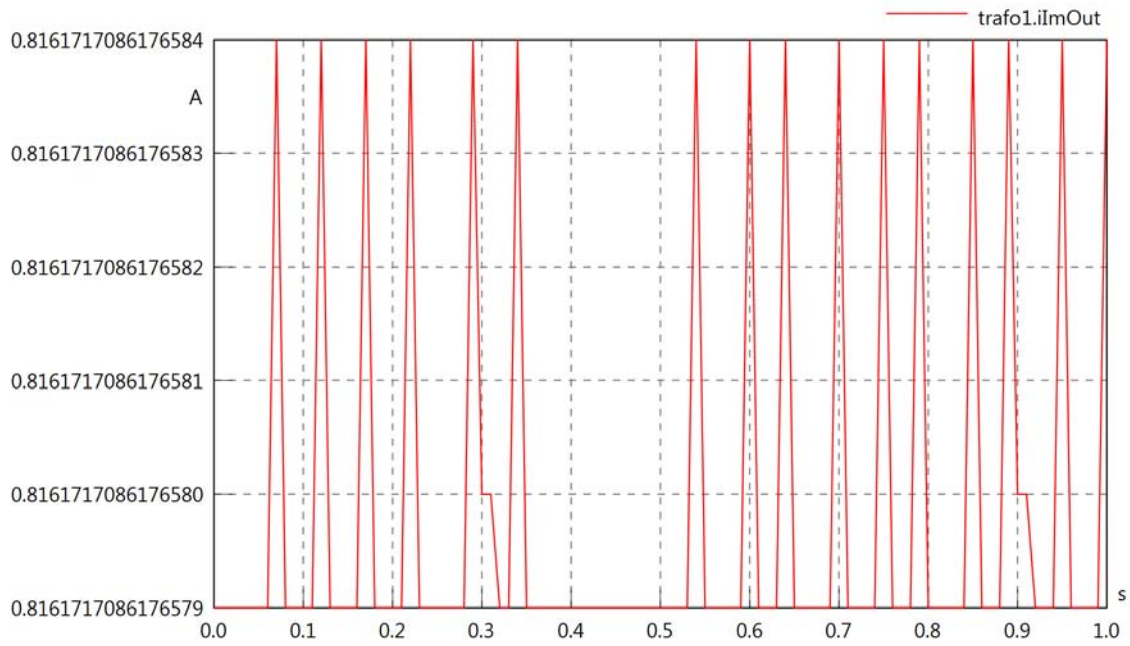

trafo1.phiVOut

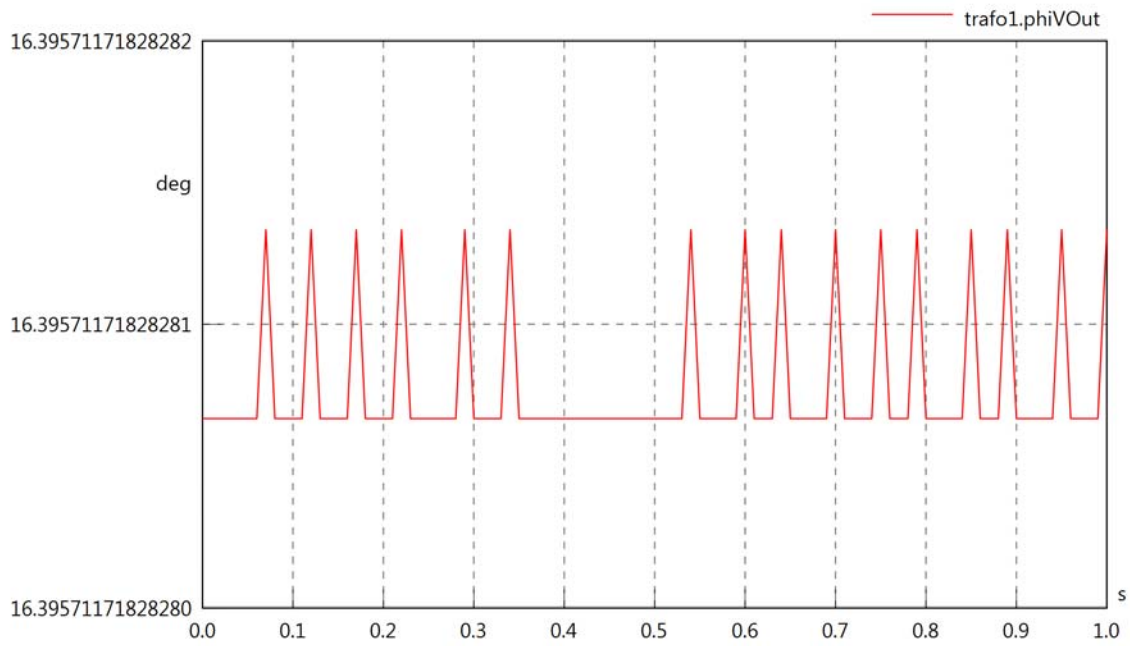

trafo1.phiIOut

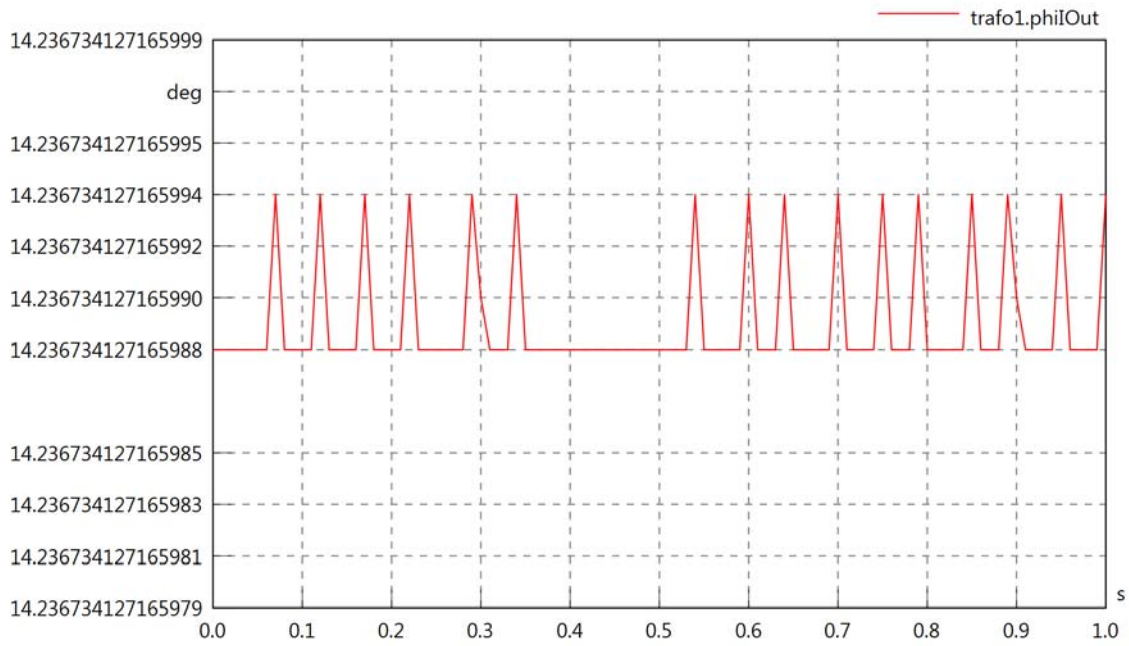

trafo1.phiIVOut

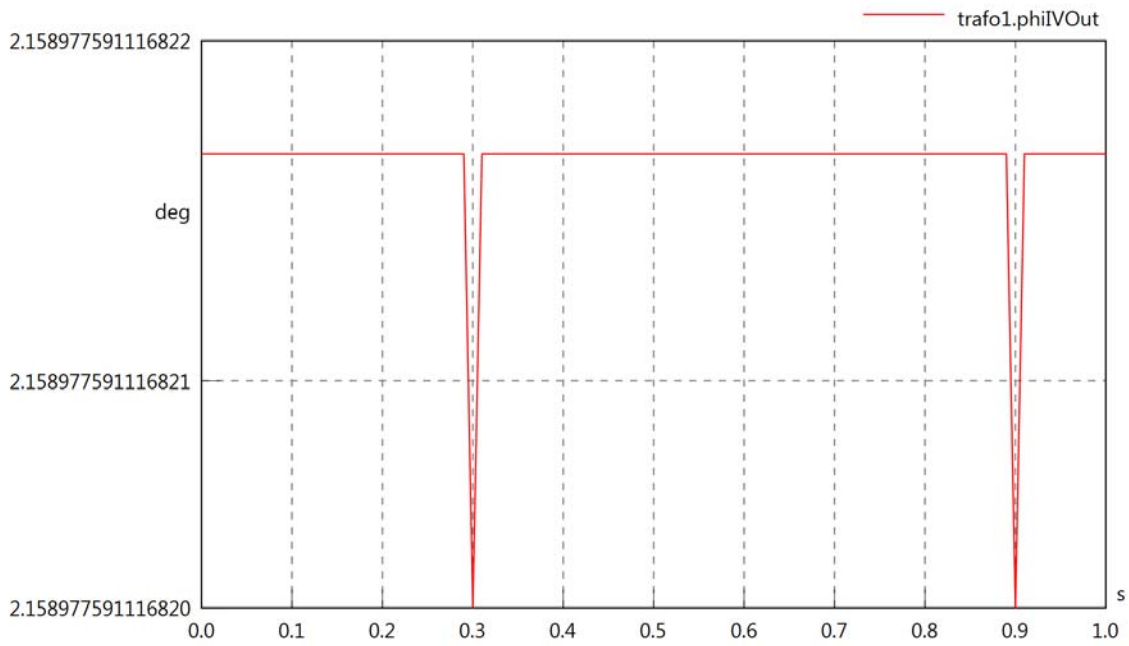

trafo1.PReOut

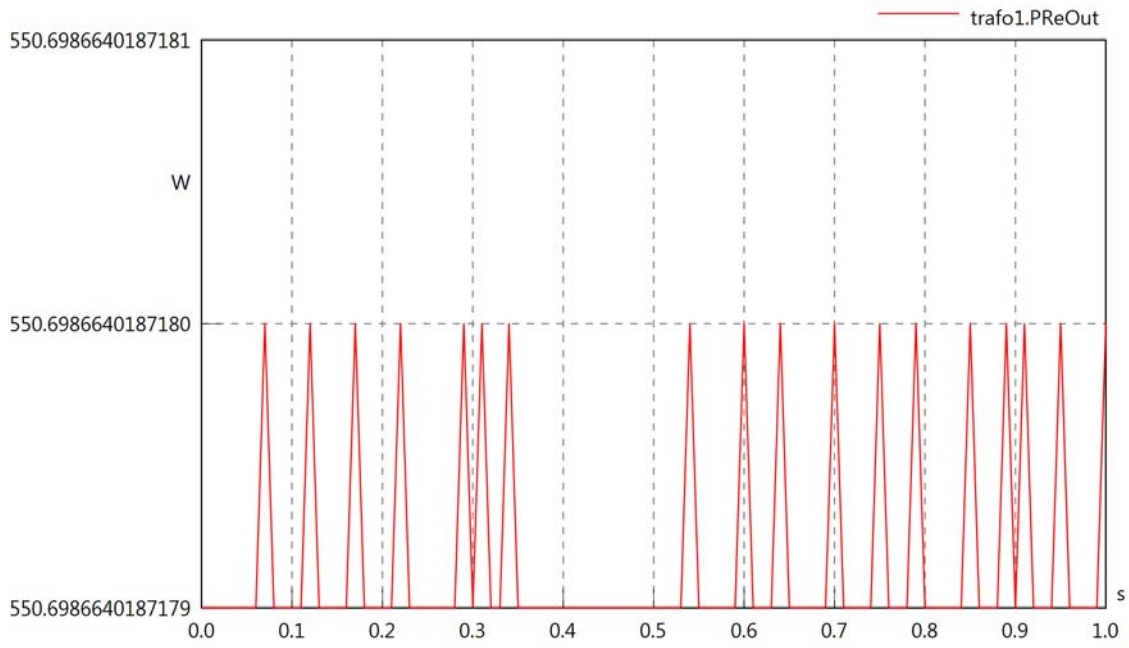

trafo1.PImOut

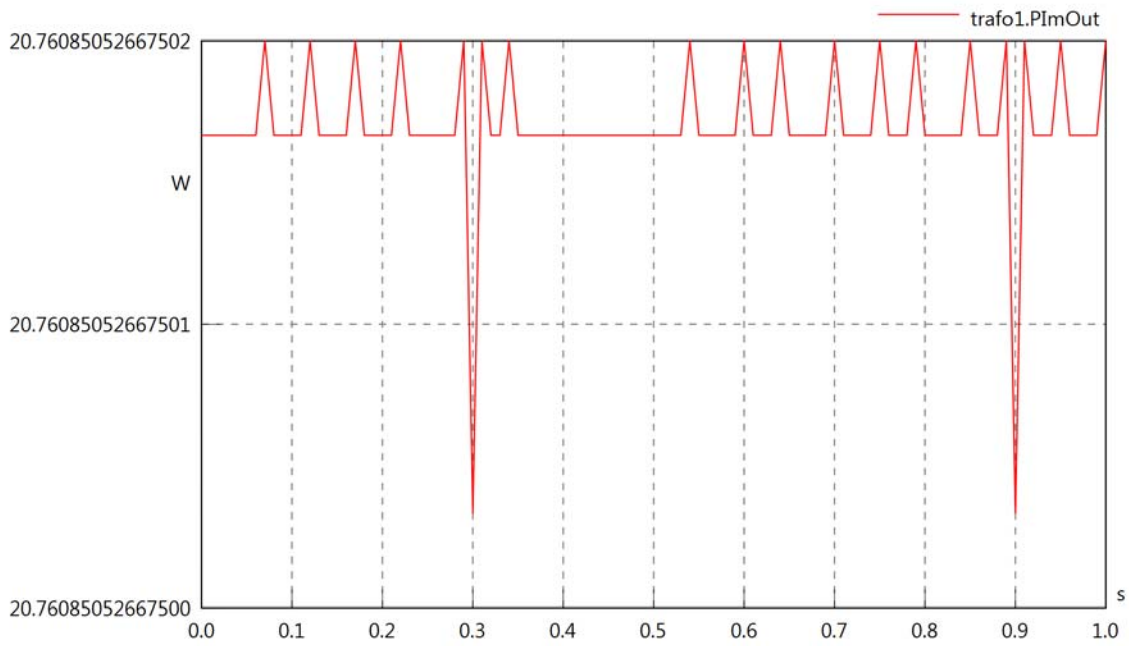

trafo1.SOut

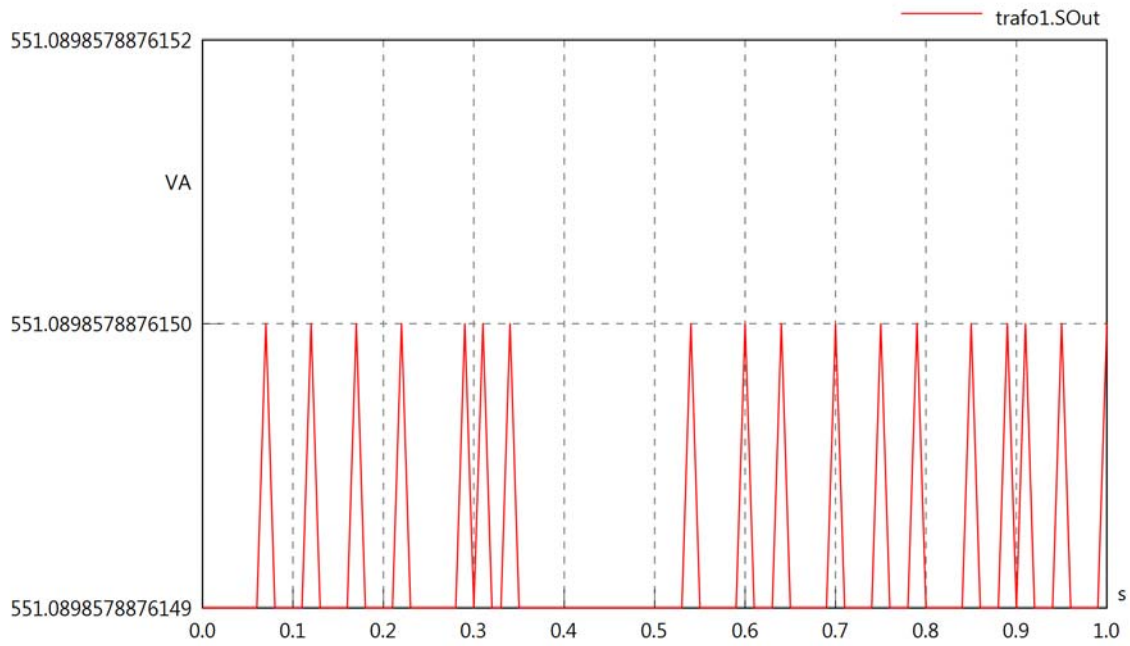

trafo1.pfOut

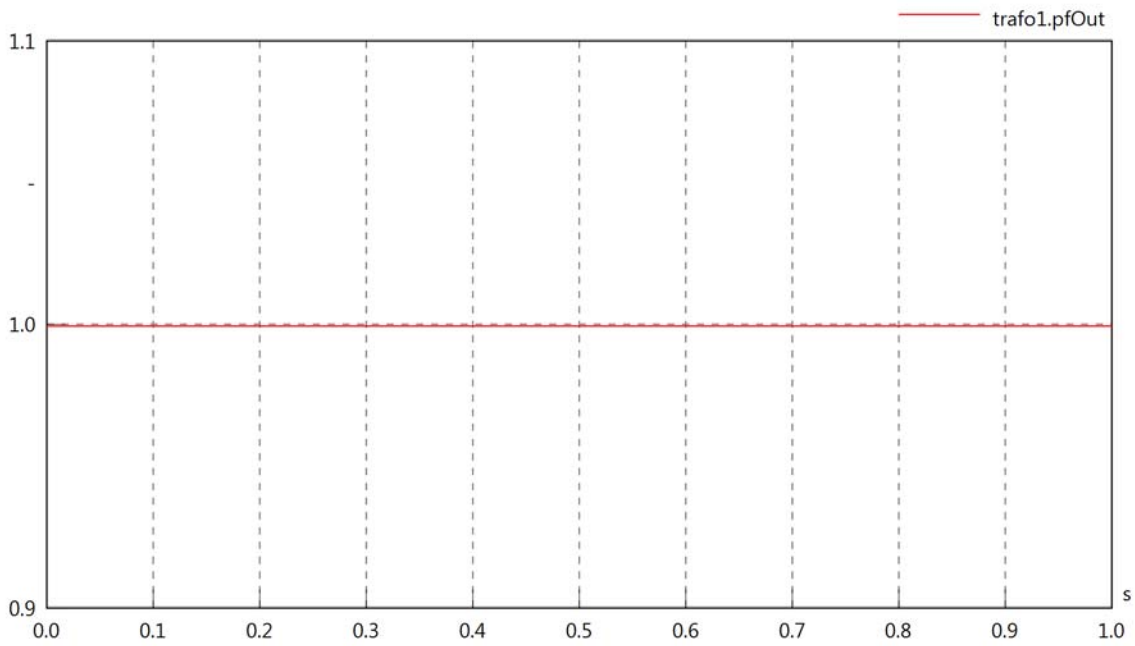
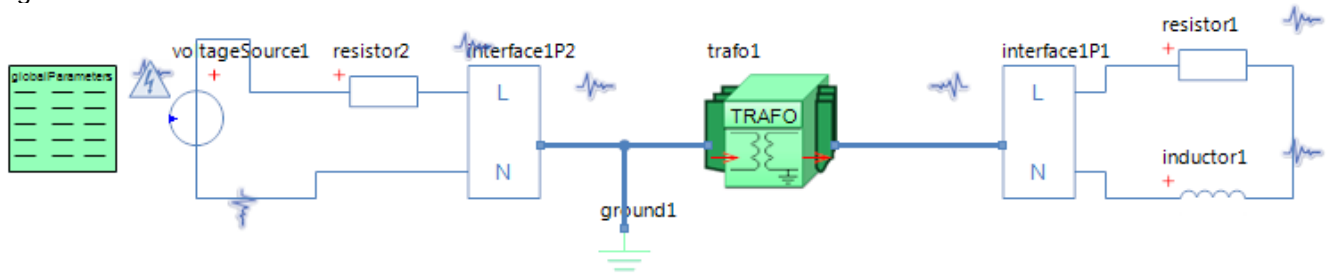

Diagram View



GlobalParameters globalParameters
Parameters

Comment	Name	Current Value	Unit
Type of Calculation	eCalculationKind	Signal Calculation	
Description of Frequency	eFrequencyKind	Linear	
Minimum Frequency	fMin	4000	[Hz]
Maximum Frequency	fMax	4000	[Hz]

Transformer trafo1
Parameters

Comment	Name	Current Value	Unit
Transformer Type	kind	Lossless Transformer	
Primary Inductance	L1	40	[mH]
Initial Value	i10	0 (Fixed)	[A]
Secondary Inductance	L2	80	[mH]
Initial Value	i20	0 (Fixed)	[A]
Mutual Coupling Inductance	M	$0.75 \cdot \sqrt{L1 \cdot L2}$	[H]

Voltage Source voltageSource1
Parameters

Comment	Name	Current Value	Unit
Voltage RMS	VrmsSrc	230	[V]
Phase	phi	0	[deg]

Resistor resistor1
Parameters

Comment	Name	Current Value	Unit
Resistance	R	50	[Ohm]

Inductor inductor1
Parameters

Comment	Name	Current Value	Unit
Inductance	L	5	[mH]

Resistor resistor2
Parameters

Comment	Name	Current Value	Unit
Resistance	R	10	[Ohm]

trafo1.n

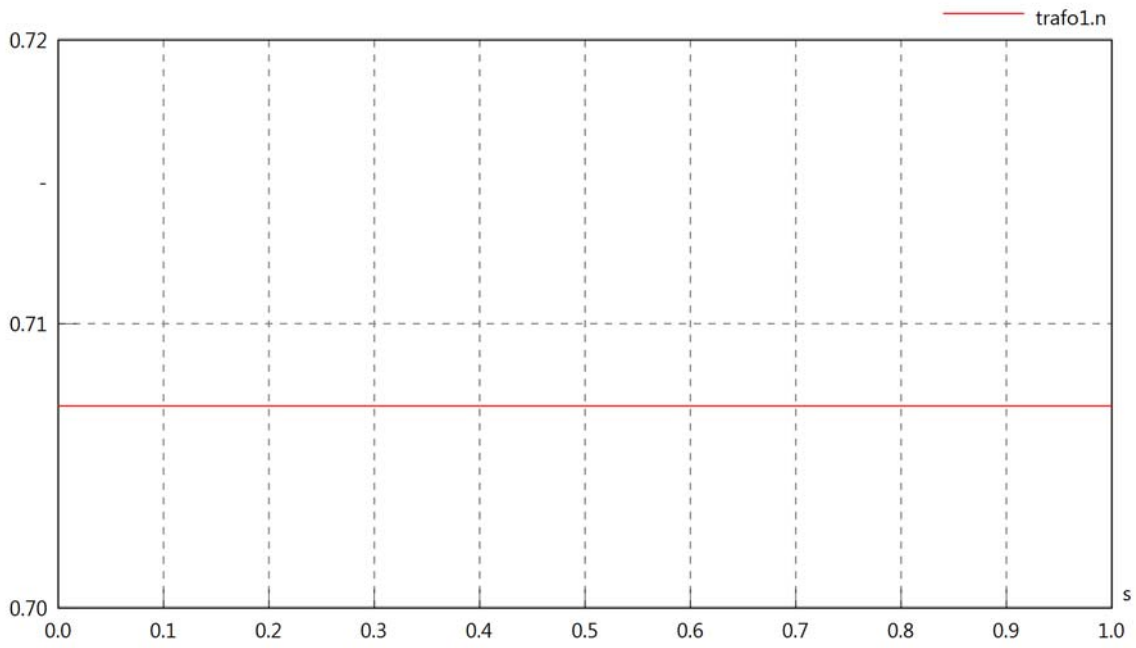

trafo1.k

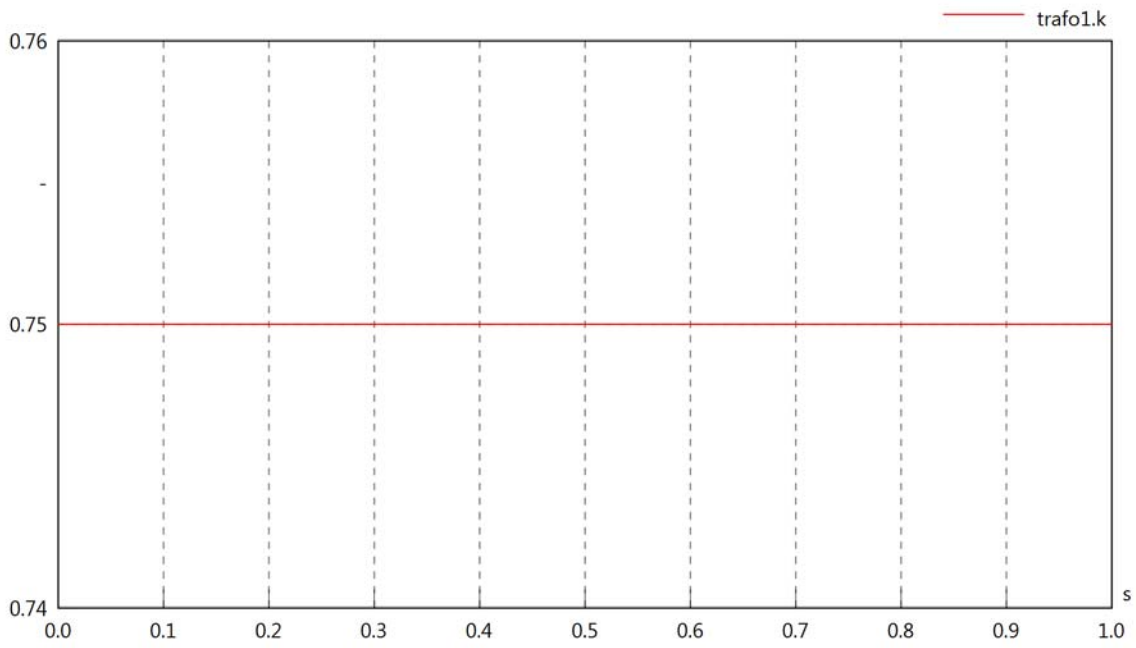

trafo1.VrmsIn

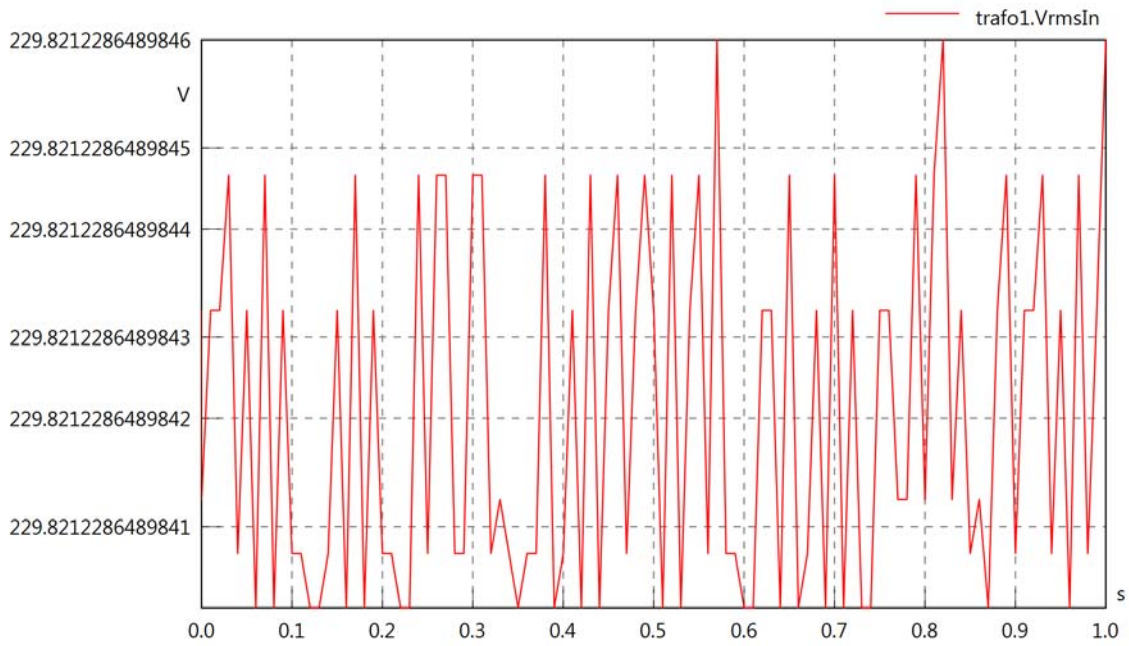

trafo1.vReIn

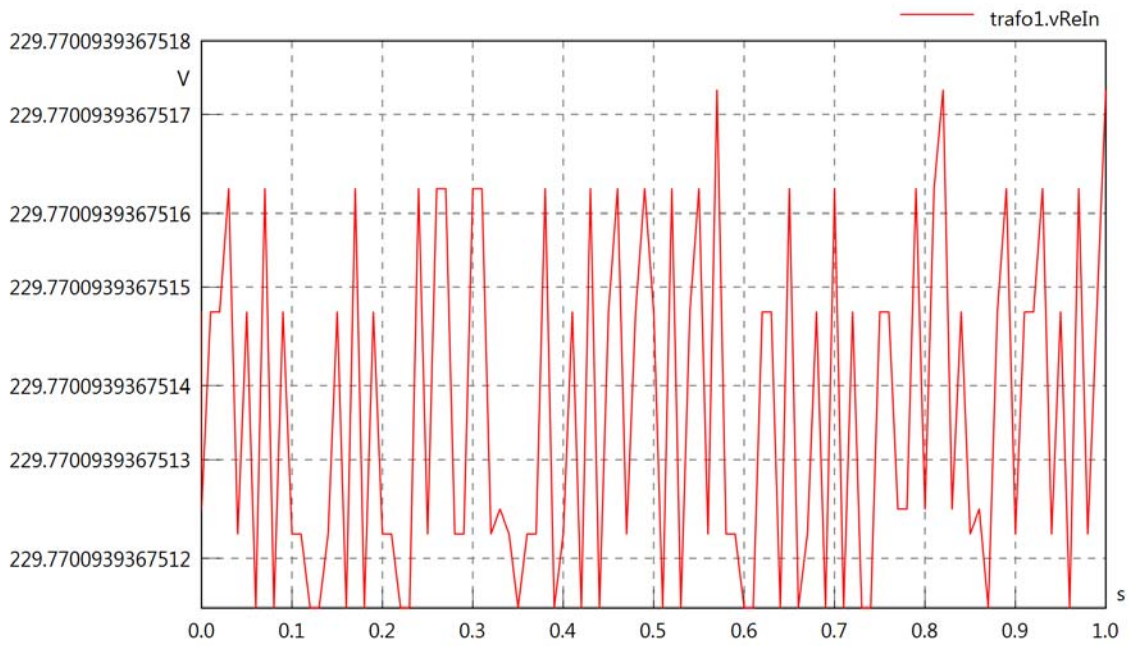

trafo1.vImIn

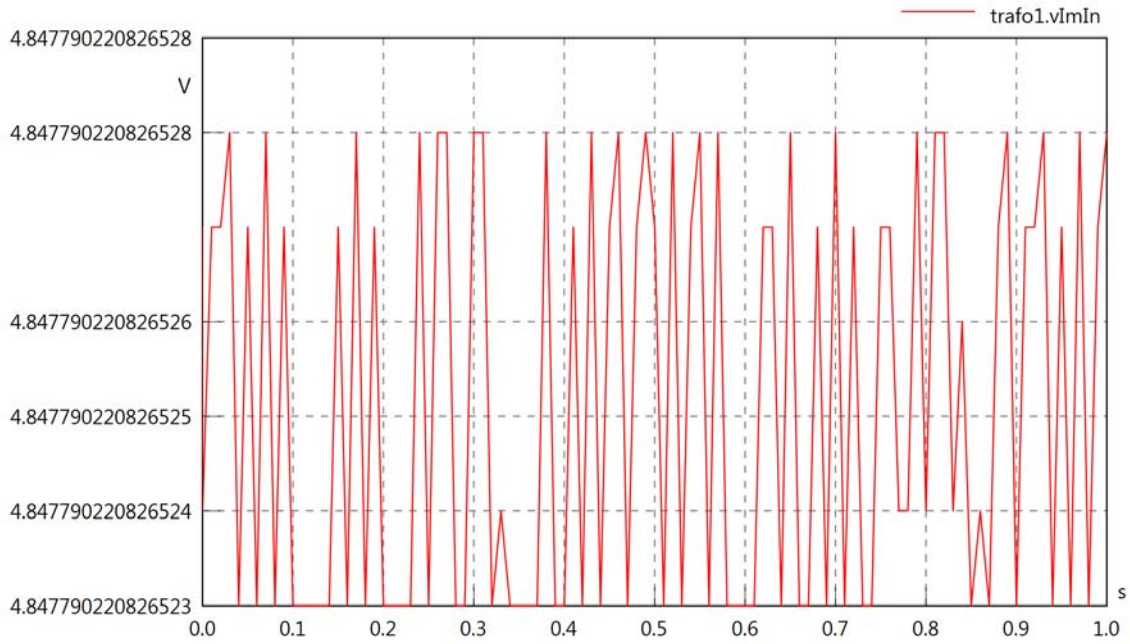

trafo1.IrmsIn

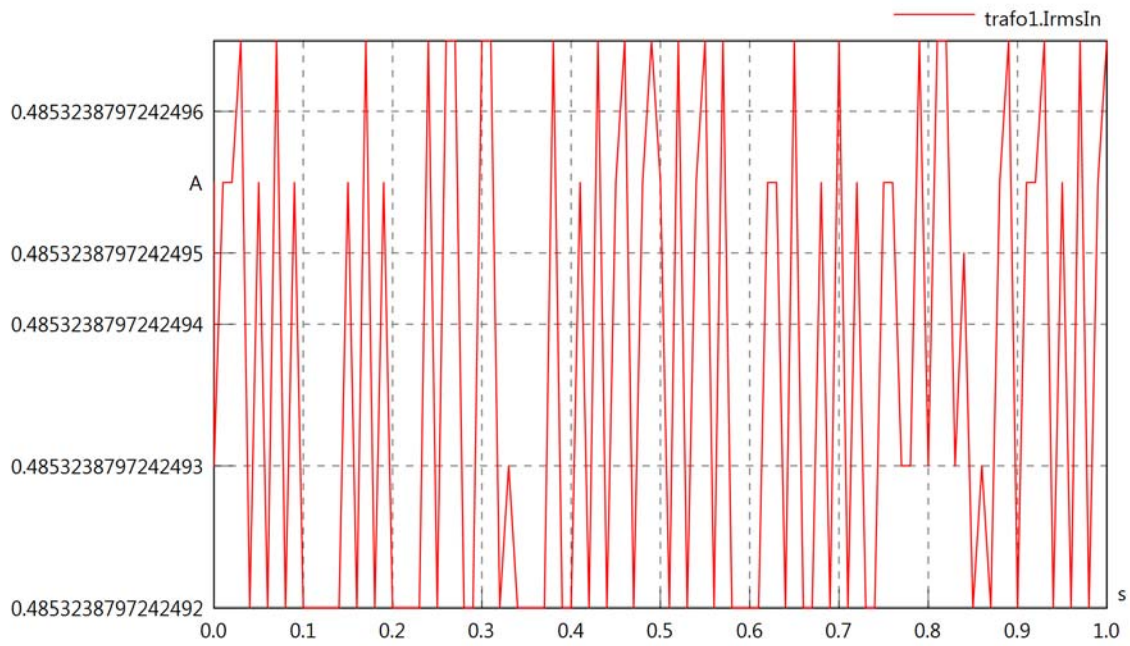

trafo1.iReIn

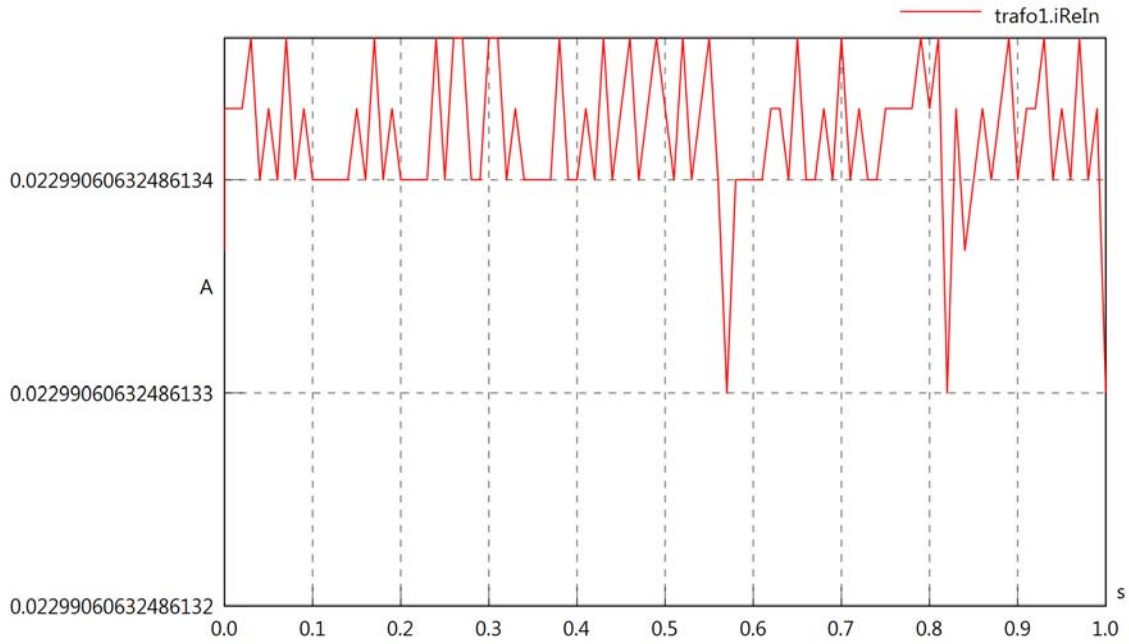

trafo1.iImIn

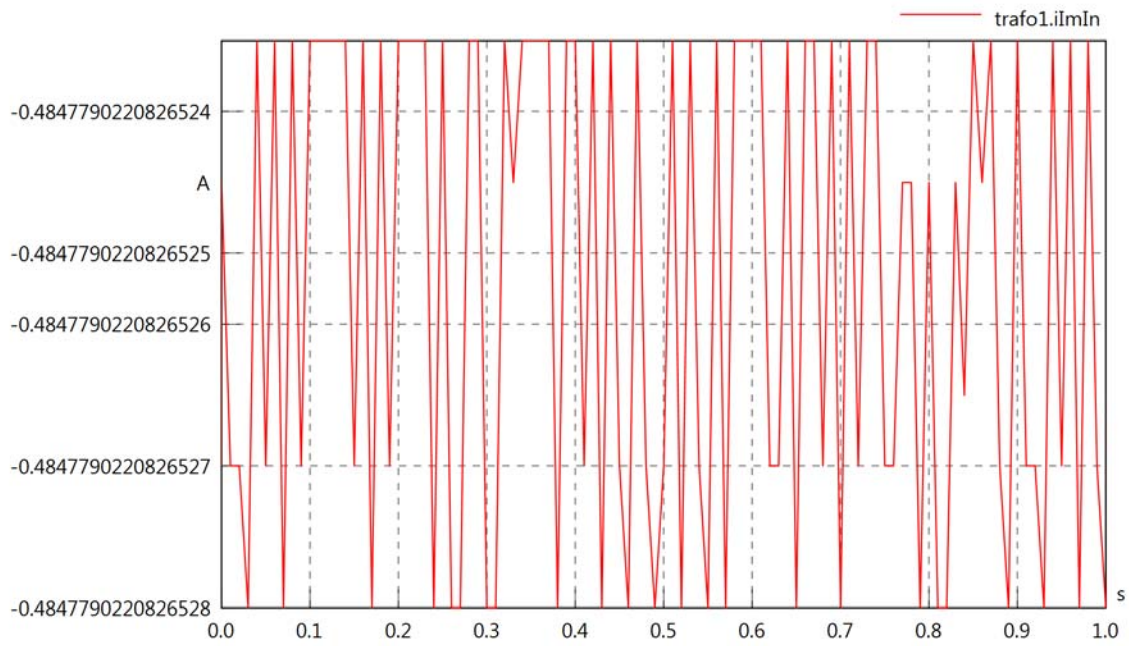

trafo1.phiVIn

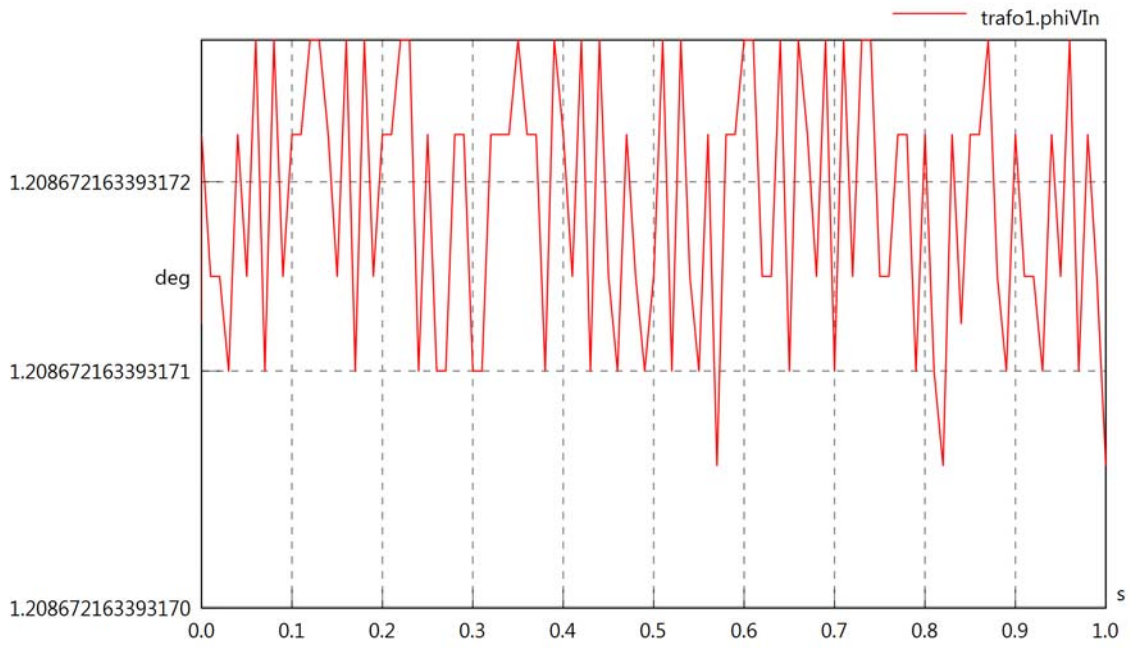

trafo1.phiIn

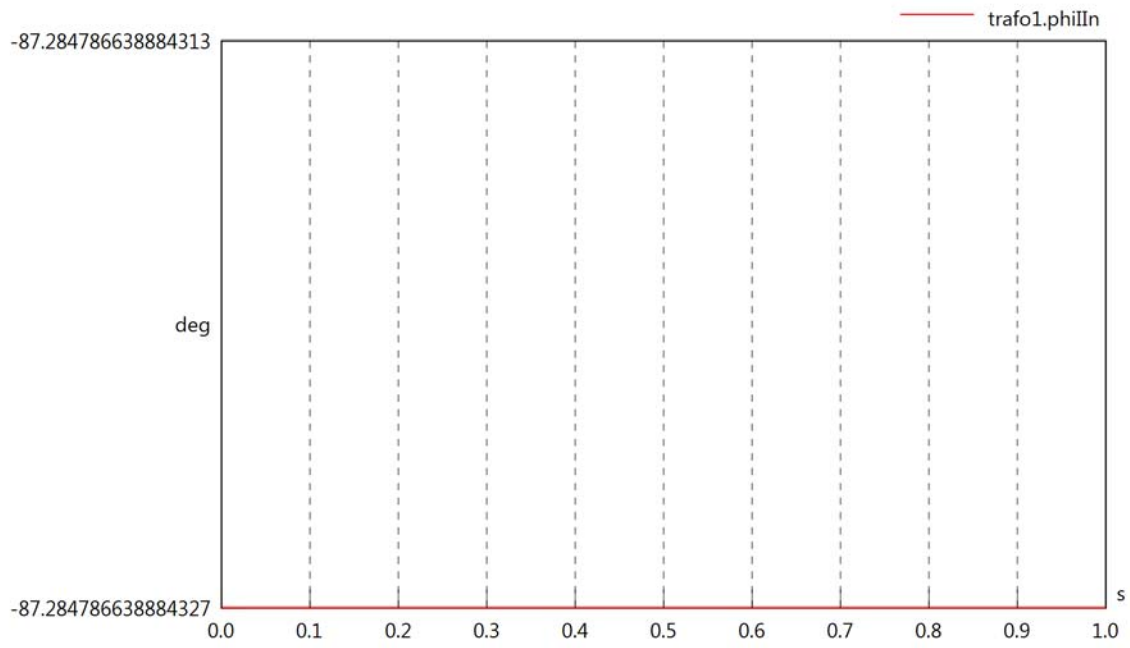

trafo1.phiIVIn

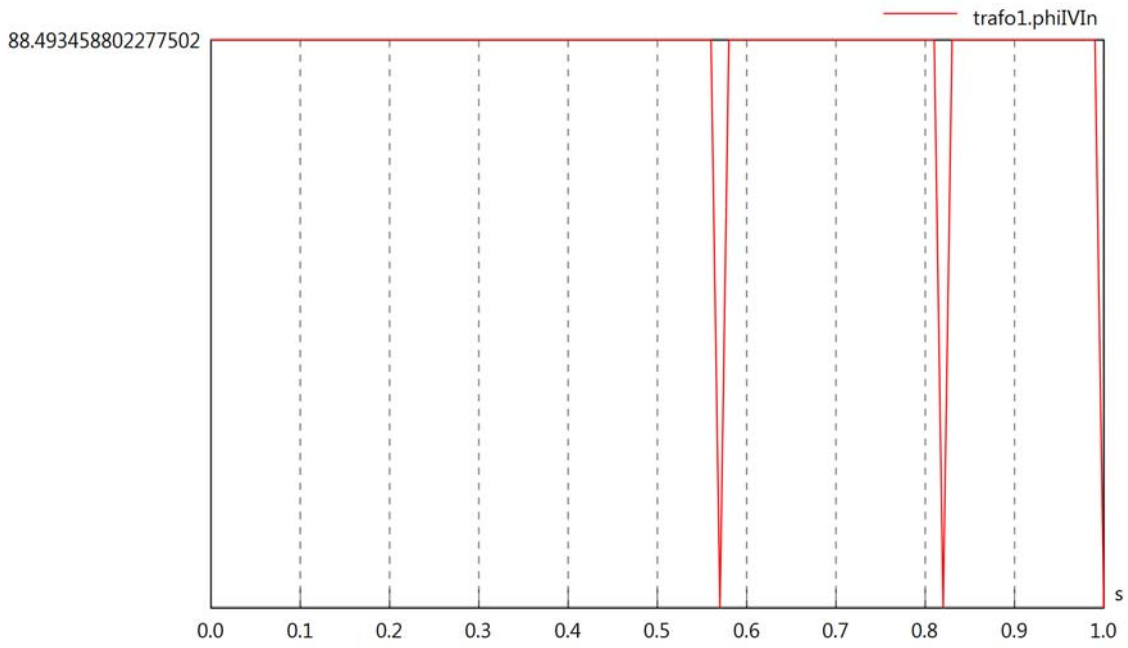

trafo1.PReIn



trafo1.PImIn

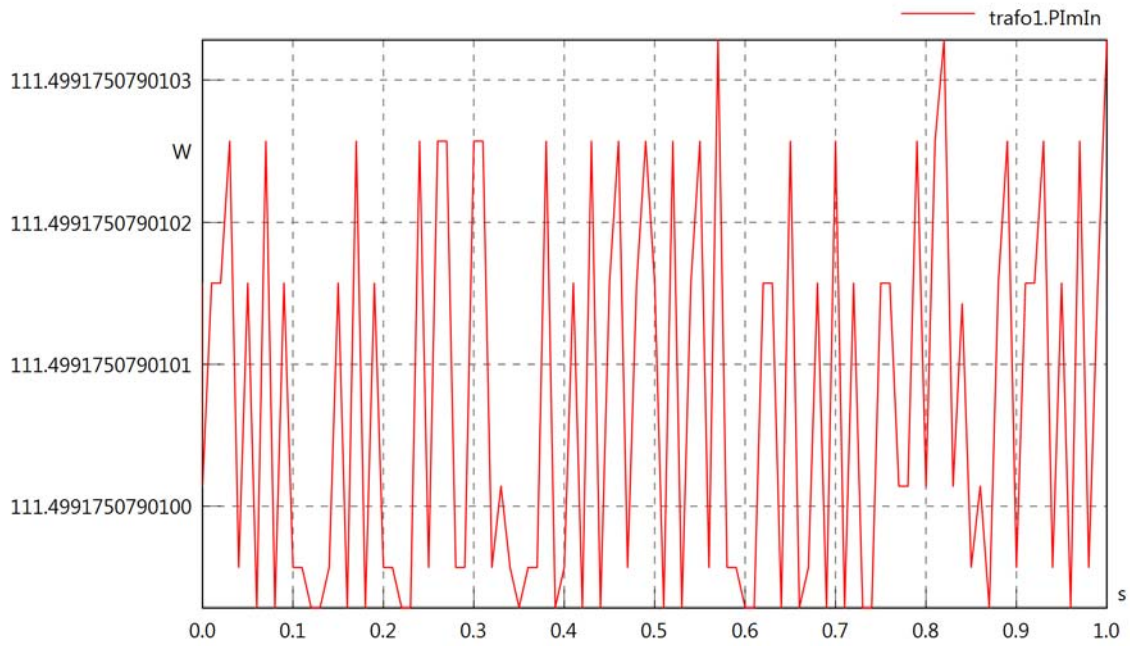

trafo1.SIn

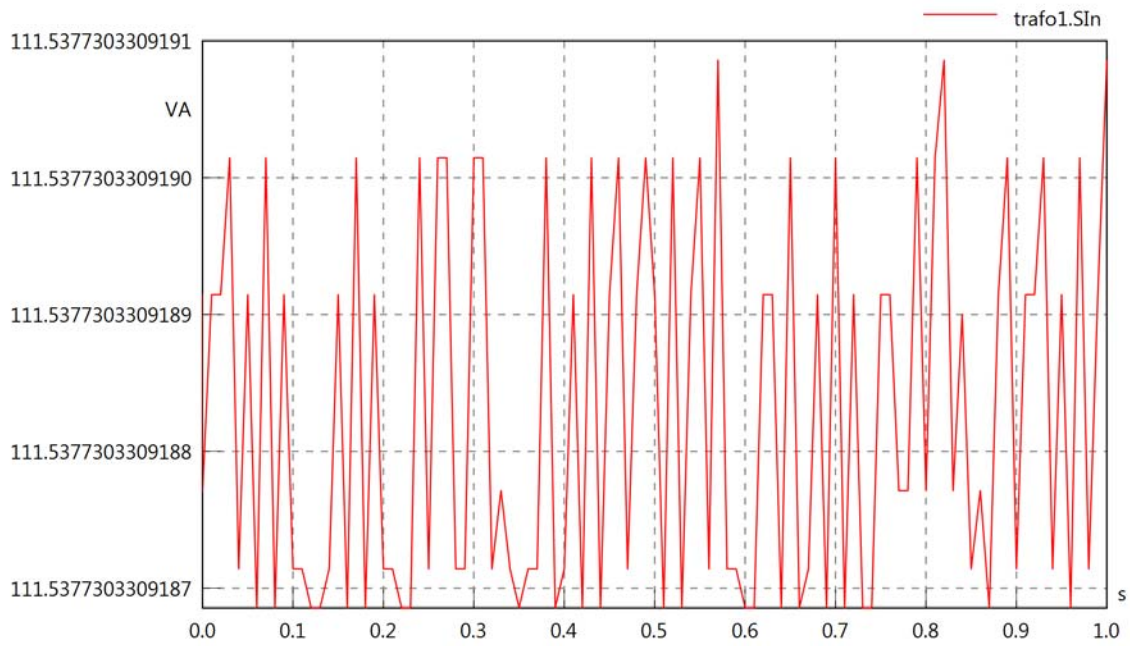

trafo1.pfIn

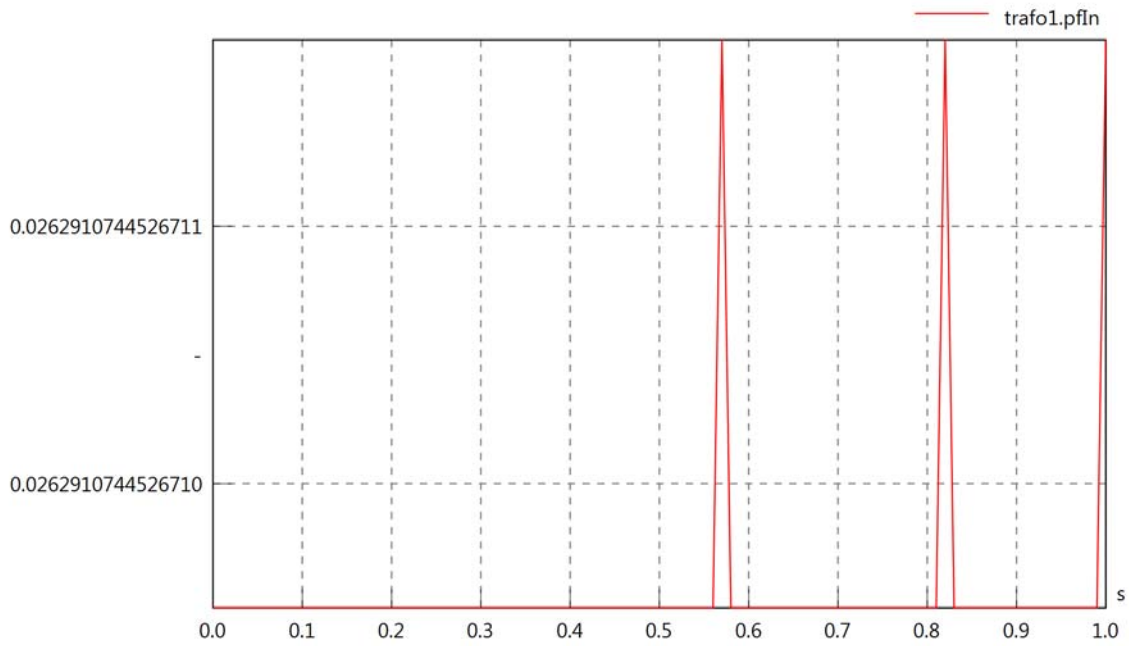

trafo1.VrmsOut

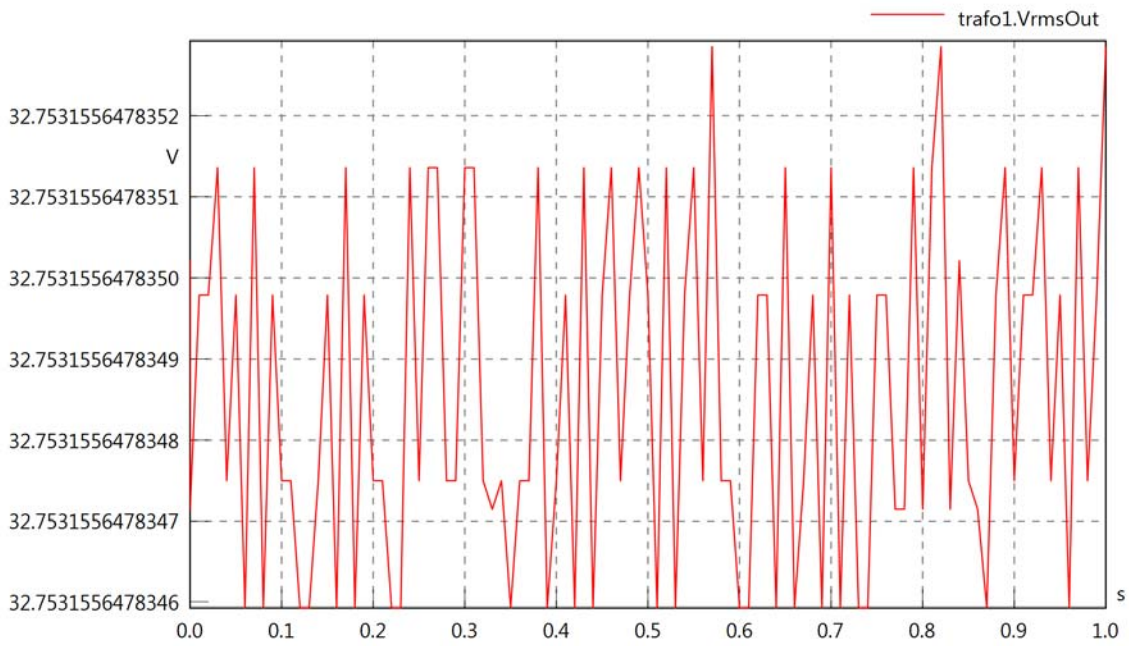

trafo1.vReOut

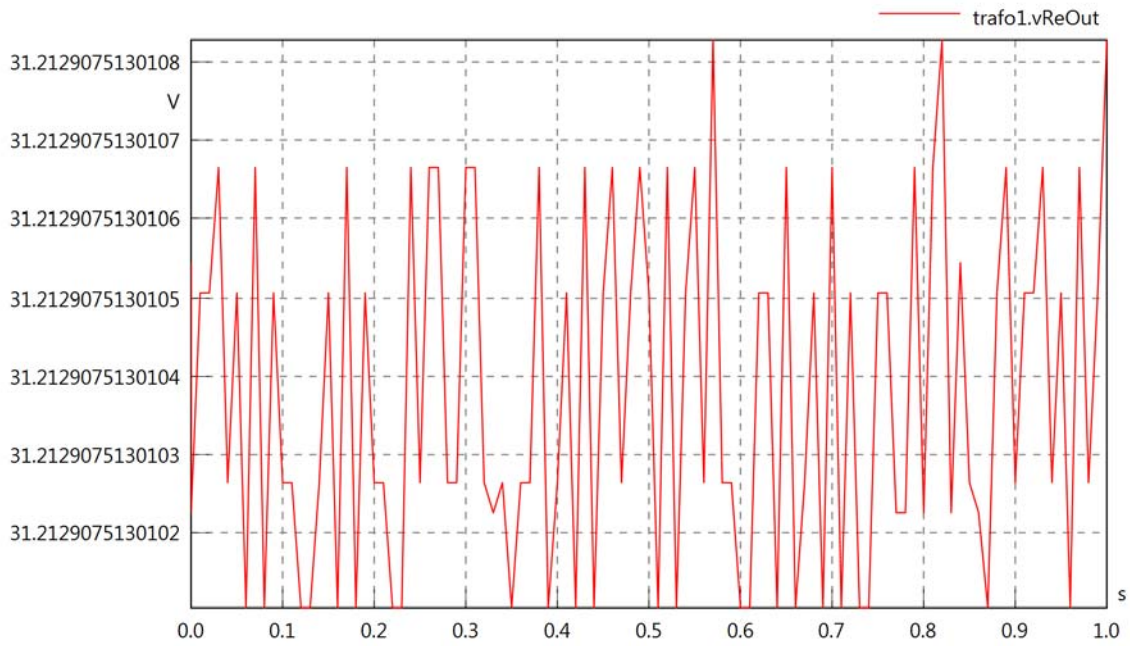

trafo1.vImOut

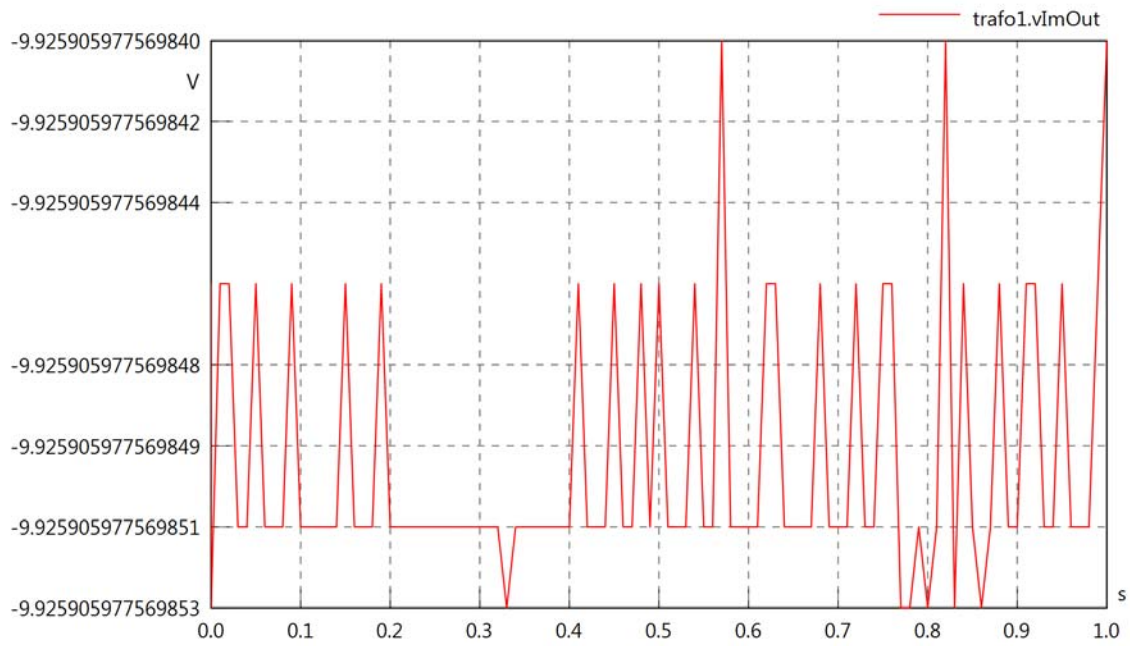

trafo1.IrmsOut

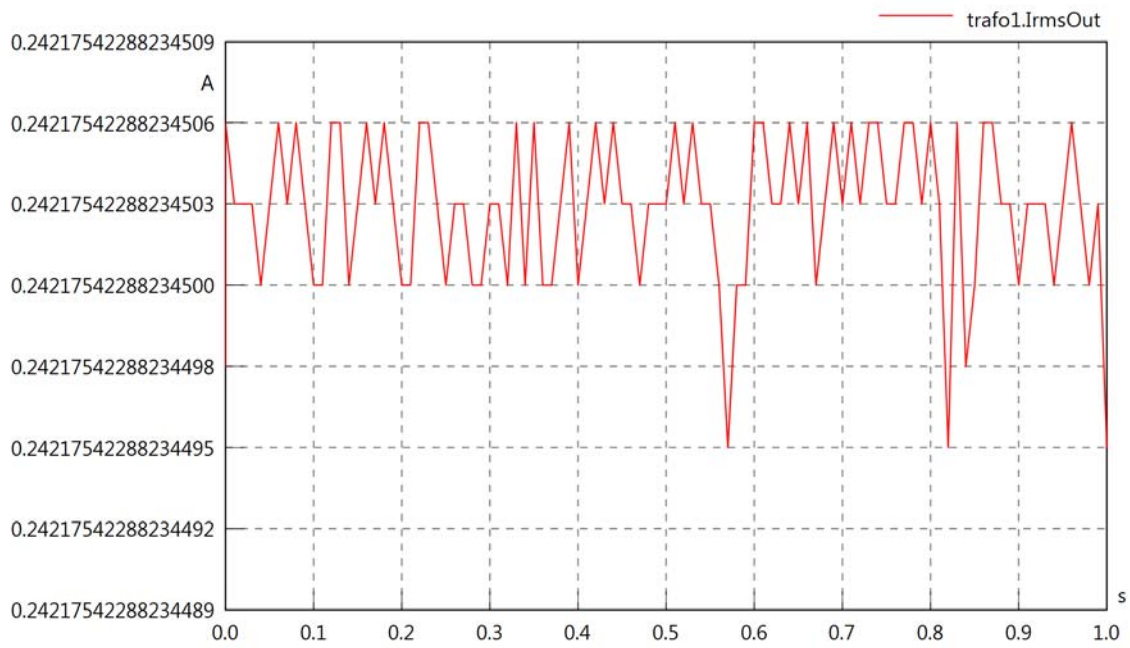

trafo1.iReOut

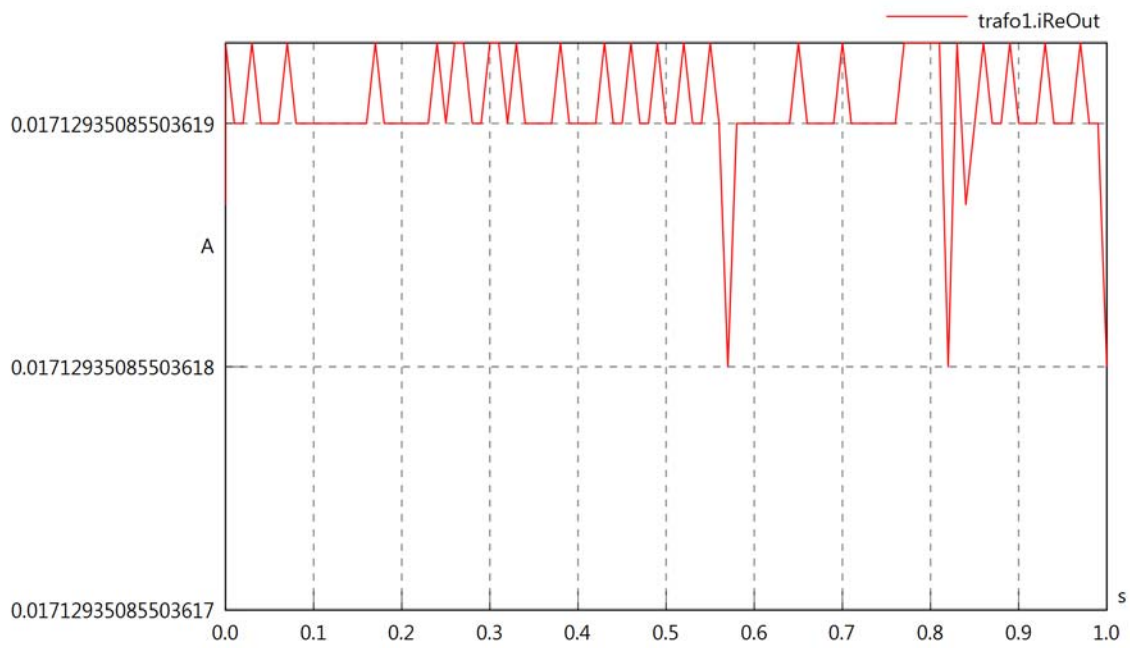

trafo1.iImOut

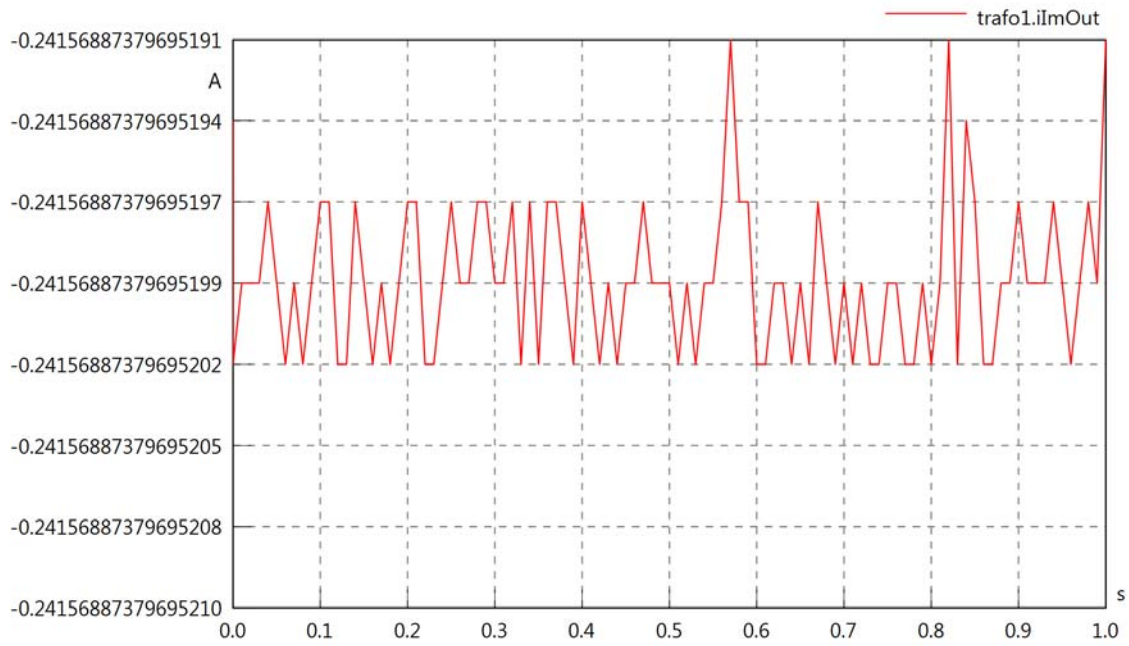

trafo1.phiVOut

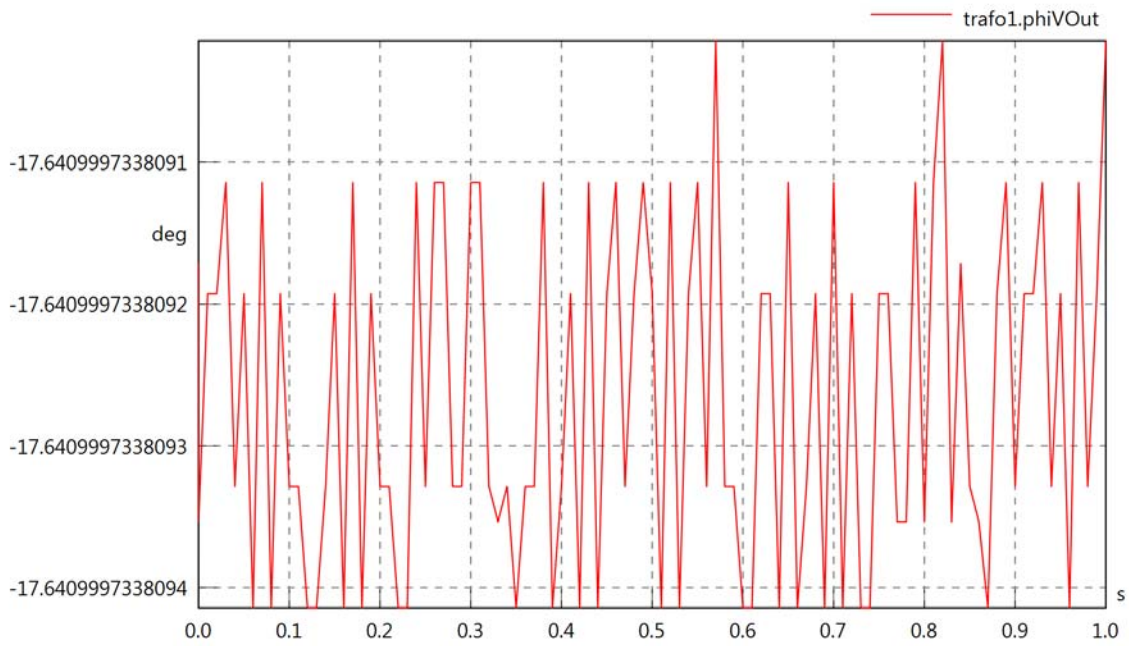

trafo1.phiIOut

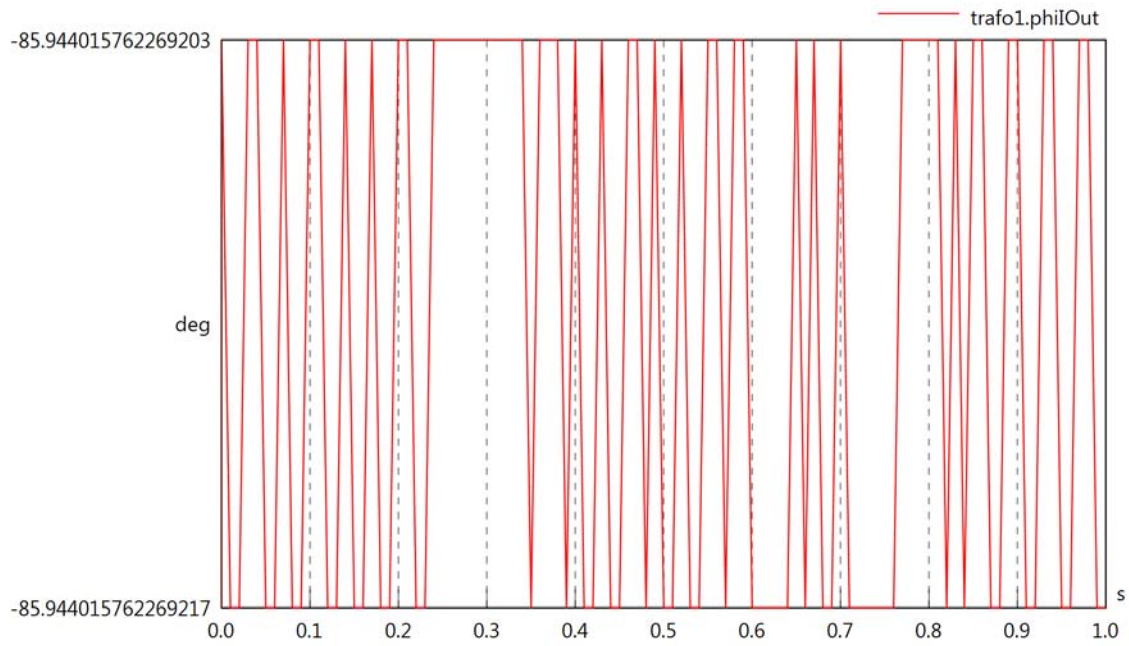

trafo1.phiIVOut

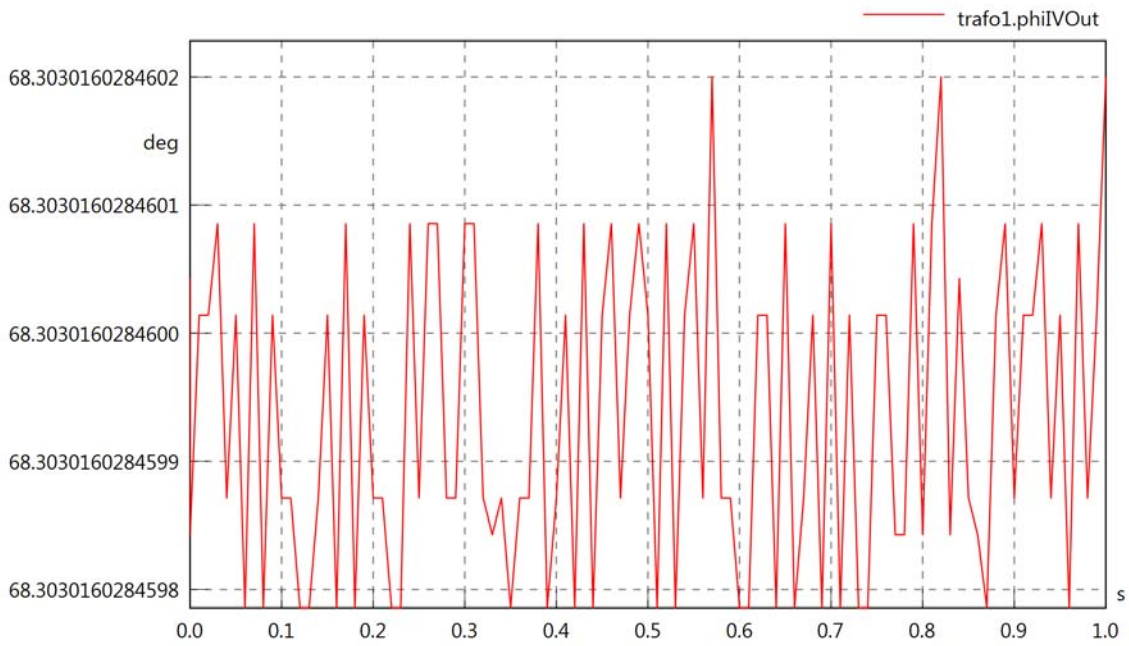

trafo1.PReOut

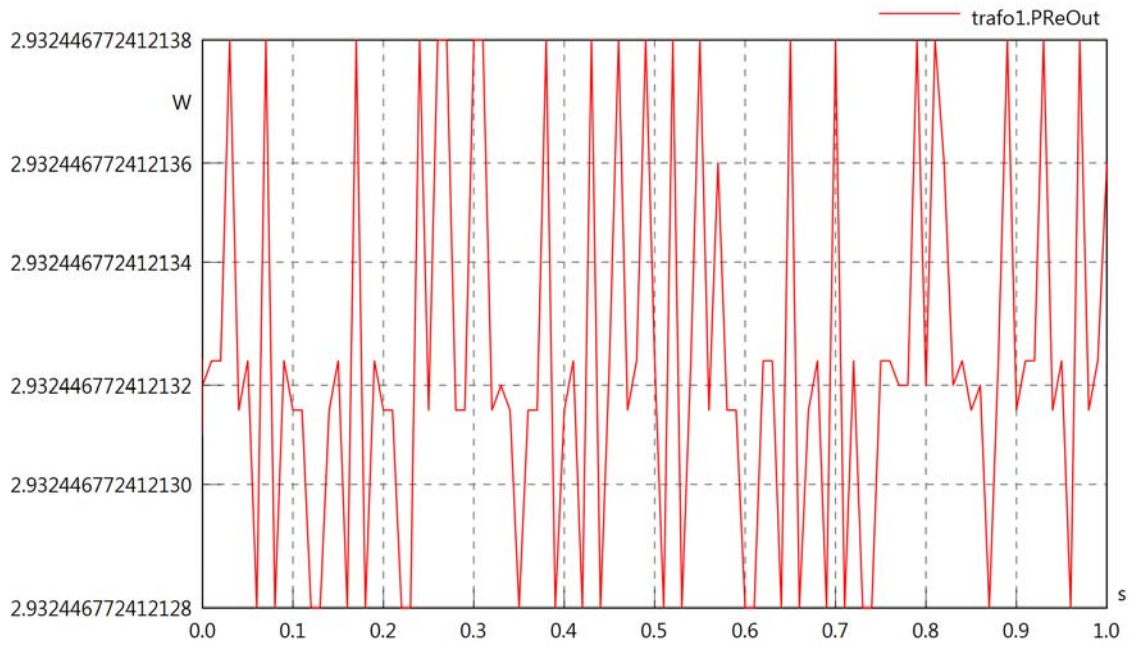

trafo1.PImOut

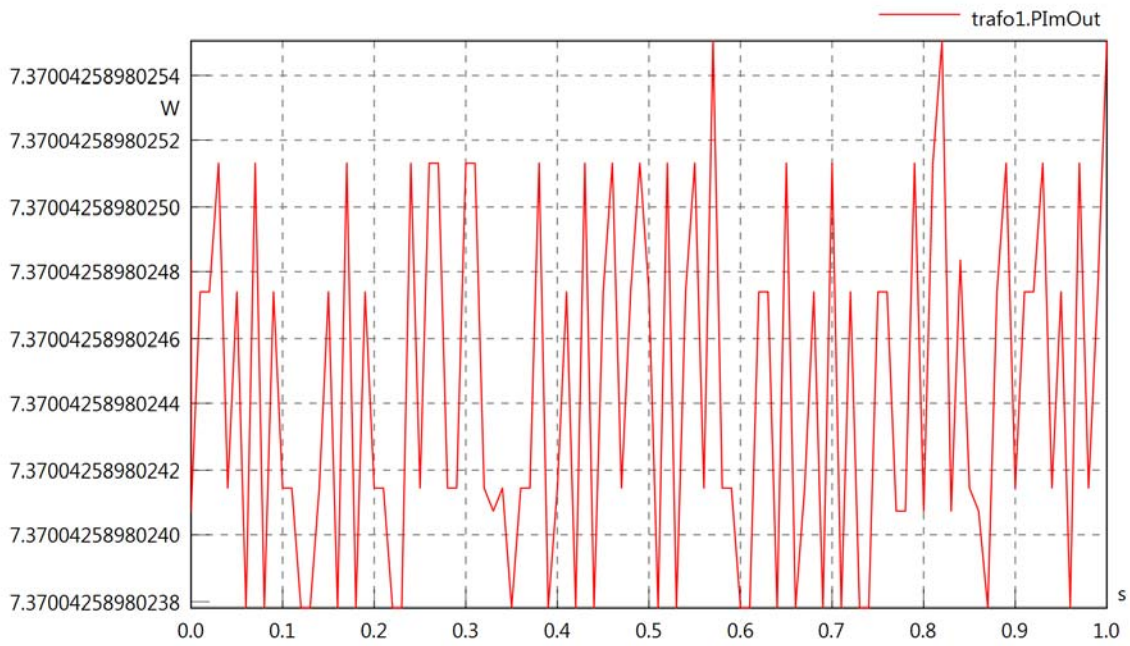

trafo1.SOut

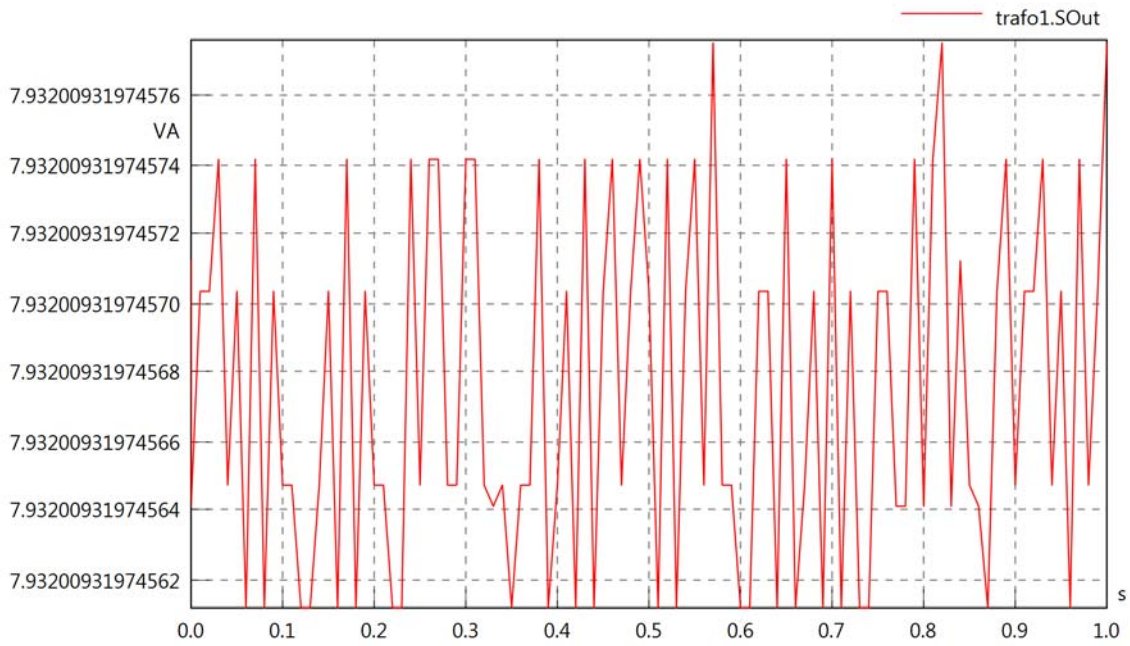

trafo1.pfOut

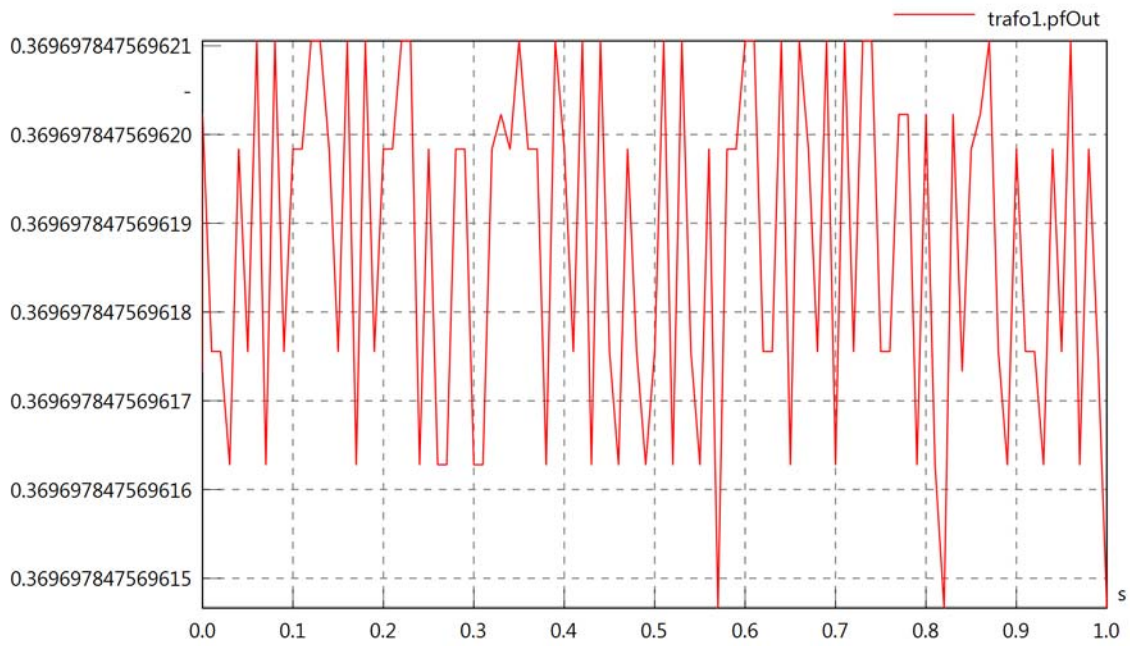
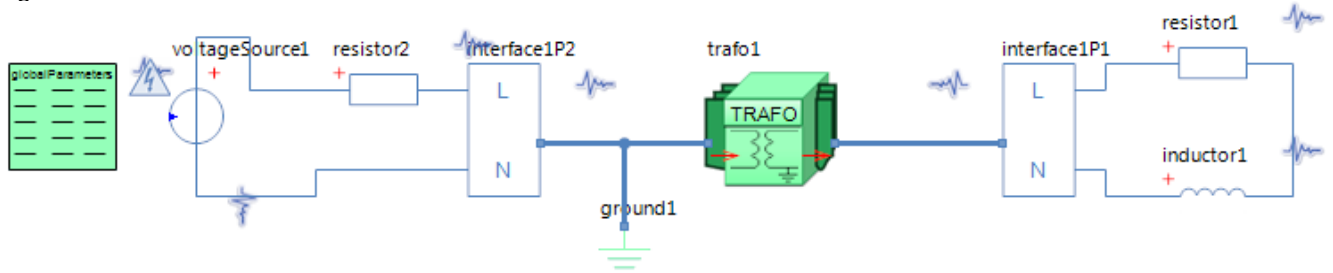

Diagram View



GlobalParameters globalParameters
Parameters

Comment	Name	Current Value	Unit
Type of Calculation	eCalculationKind	Signal Calculation	
Description of Frequency	eFrequencyKind	Linear	
Minimum Frequency	fMin	100	[kHz]
Maximum Frequency	fMax	100	[kHz]

Transformer trafo1
Parameters

Comment	Name	Current Value	Unit
Transformer Type	kind	Lossless Transformer	
Primary Inductance	L1	40	[mH]
Initial Value	i10	0 (Fixed)	[A]
Secondary Inductance	L2	80	[mH]
Initial Value	i20	0 (Fixed)	[A]
Mutual Coupling Inductance	M	$0.75 \cdot \sqrt{L1 \cdot L2}$	[H]

Voltage Source voltageSource1
Parameters

Comment	Name	Current Value	Unit
Voltage RMS	VrmsSrc	230	[V]
Phase	phi	0	[deg]

Resistor resistor1
Parameters

Comment	Name	Current Value	Unit
Resistance	R	50	[Ohm]

Inductor inductor1
Parameters

Comment	Name	Current Value	Unit
Inductance	L	5	[mH]

Resistor resistor2
Parameters

Comment	Name	Current Value	Unit
Resistance	R	10	[Ohm]

trafo1.n

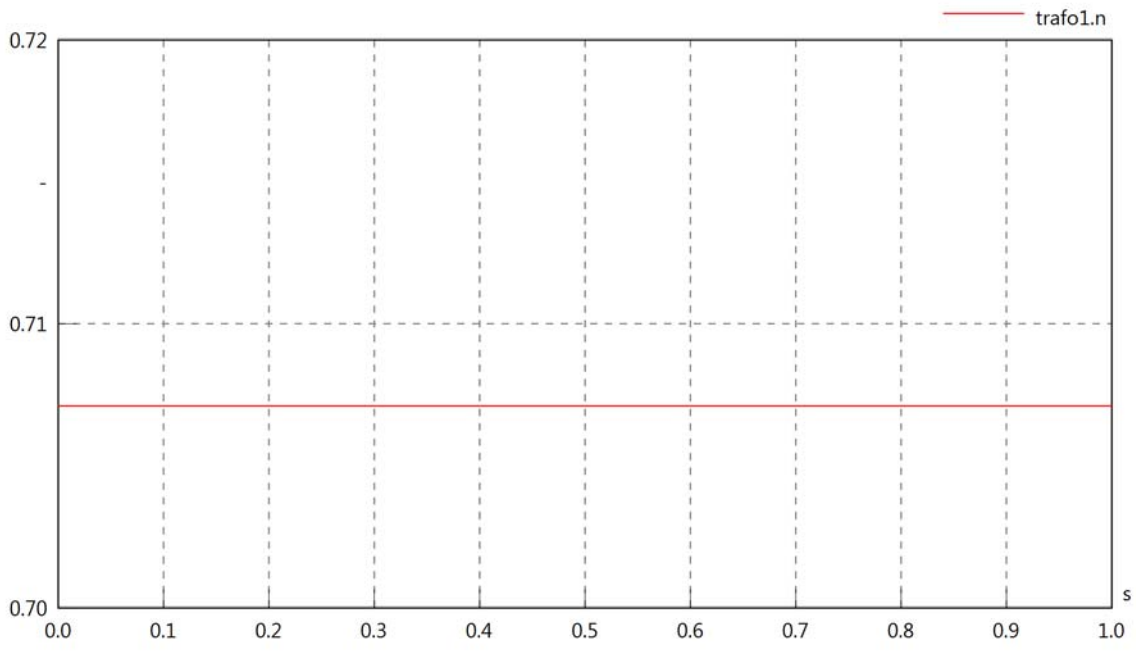

trafo1.k

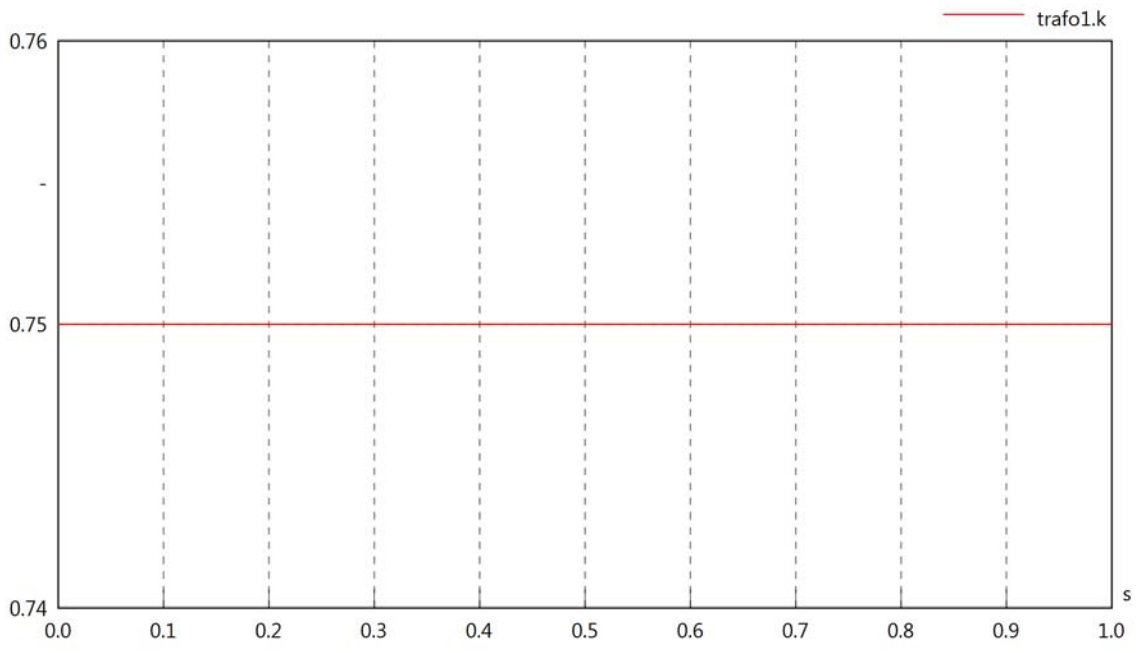

trafo1.VrmsIn

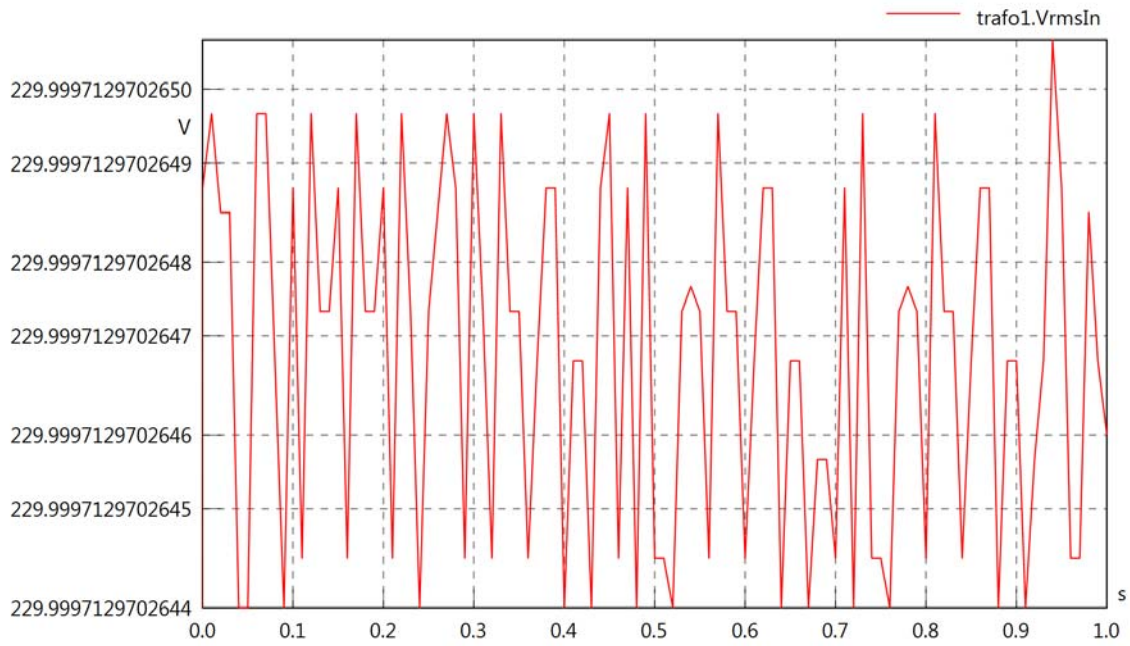

trafo1.vReIn

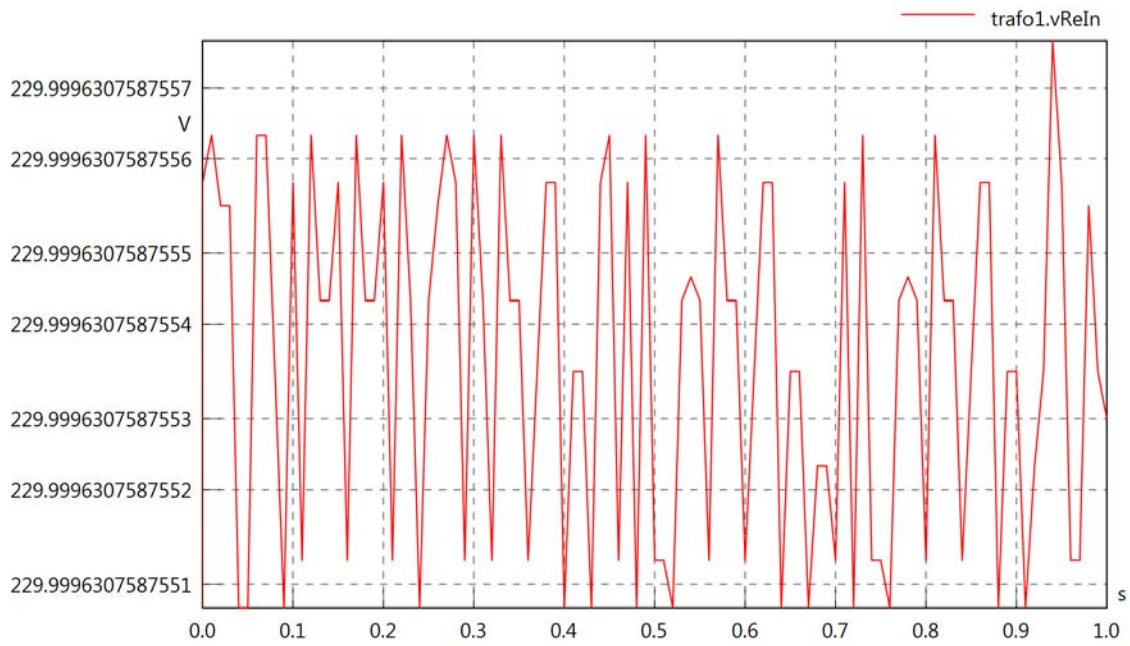

trafo1.vImIn

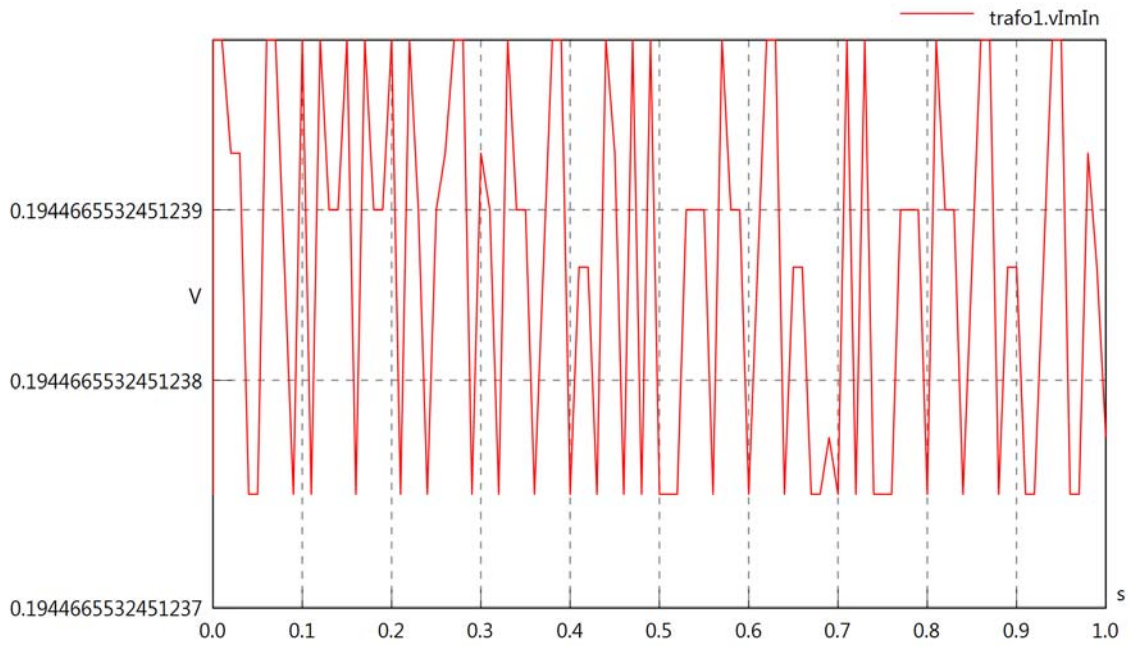

trafo1.IrmsIn

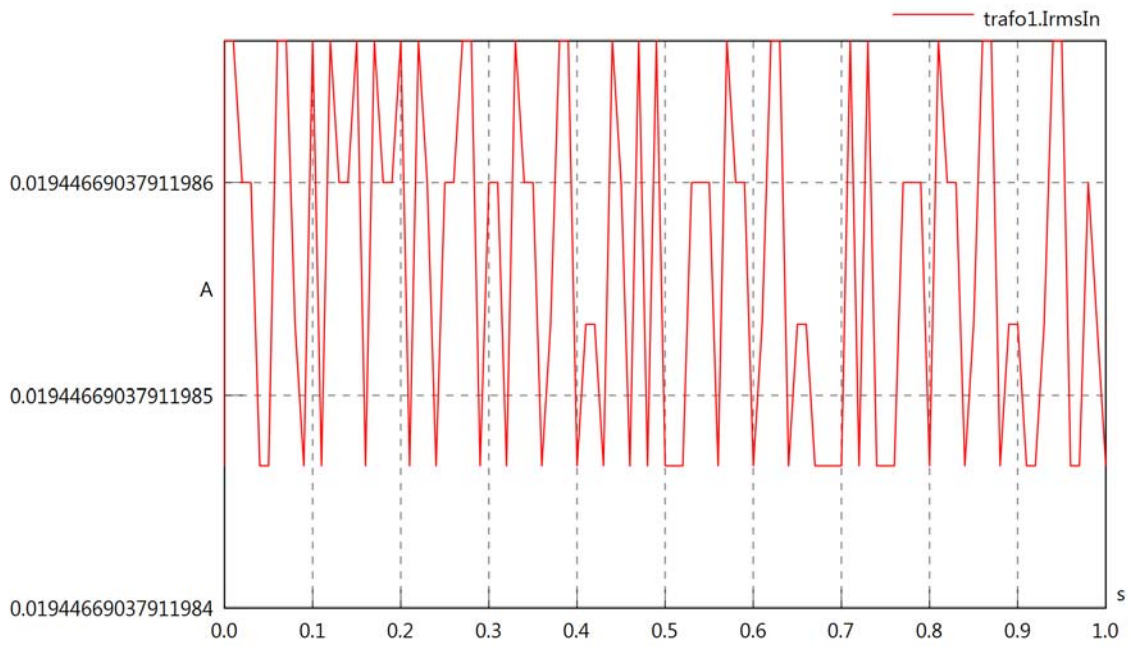

trafo1.iReIn

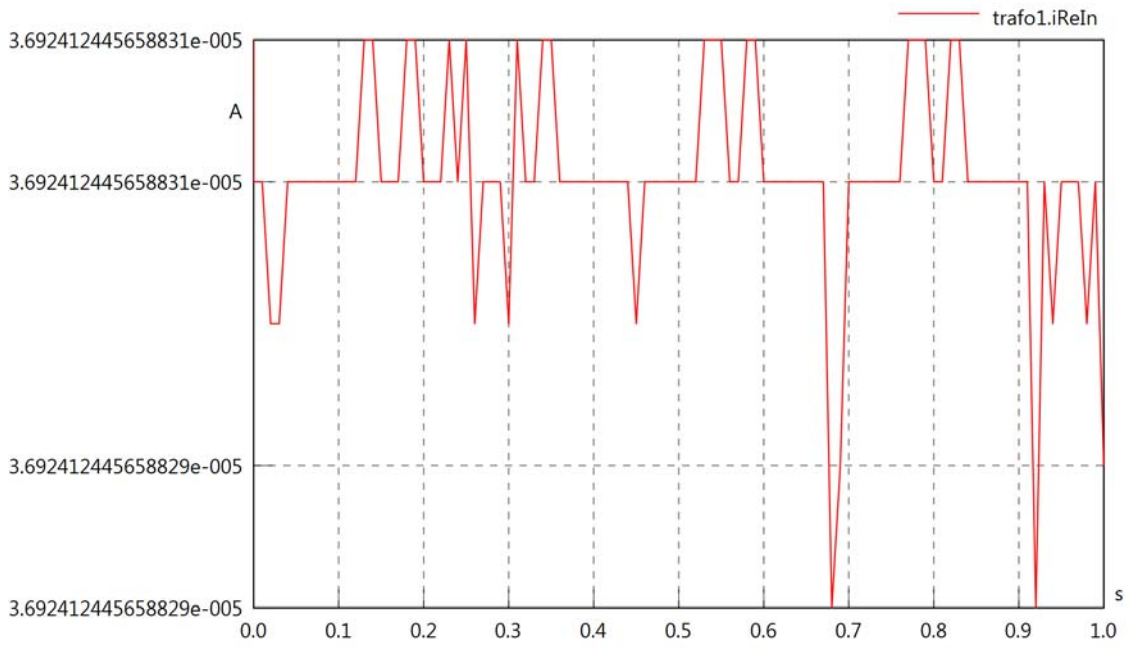

trafo1.iImIn

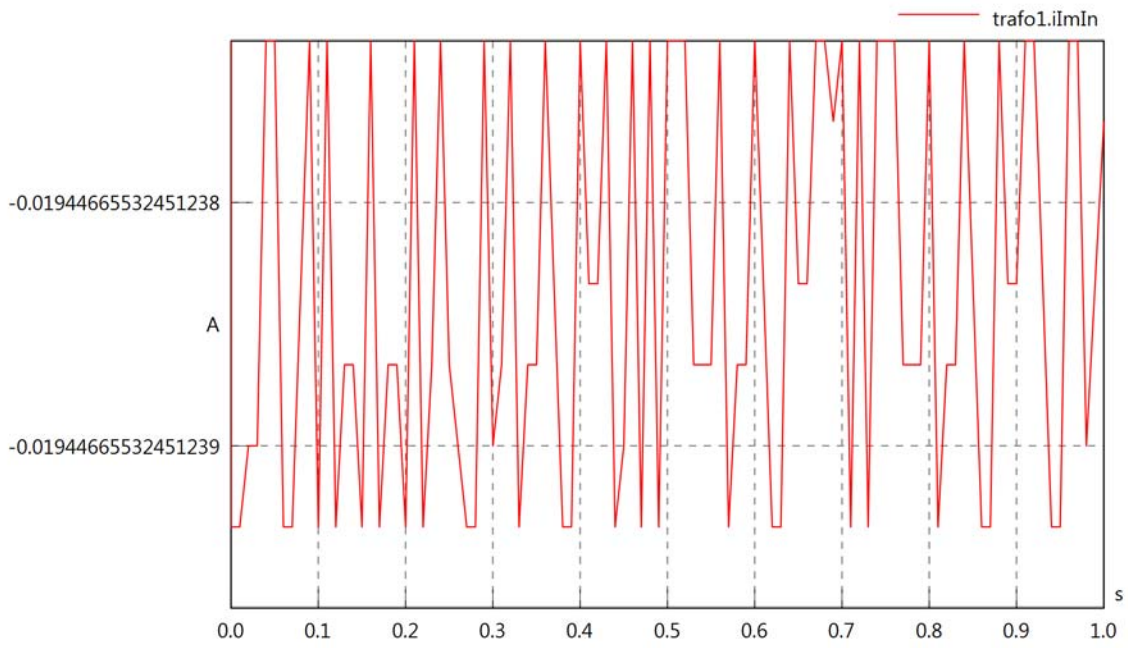

trafo1.phiVIn

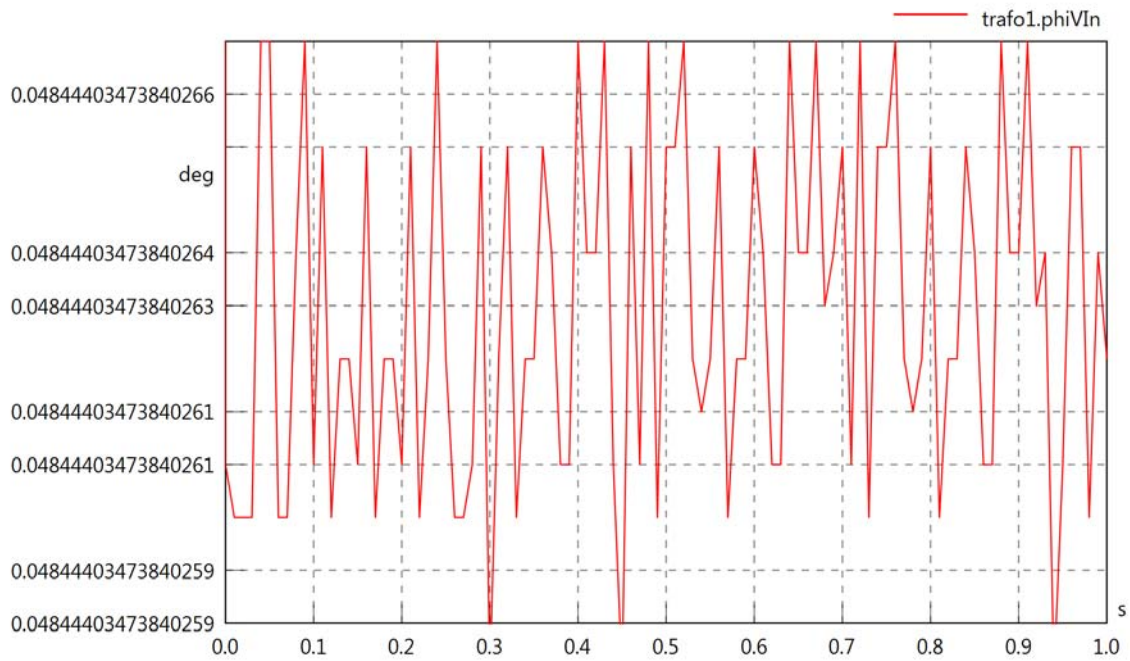

trafo1.phiIn

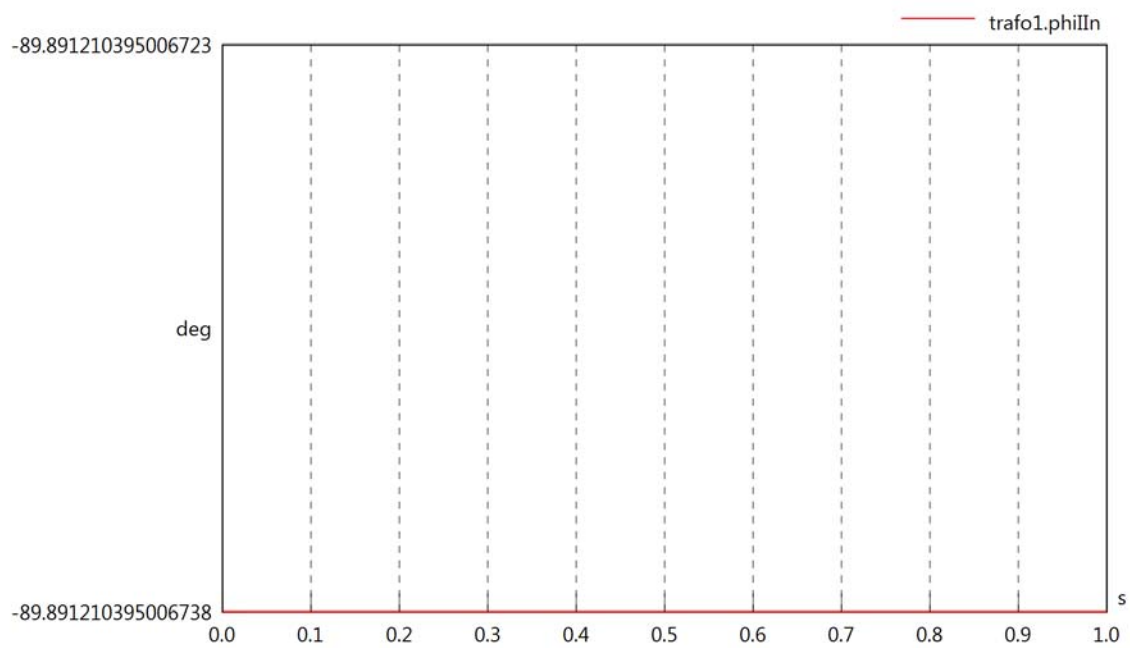

trafo1.phiIVIn

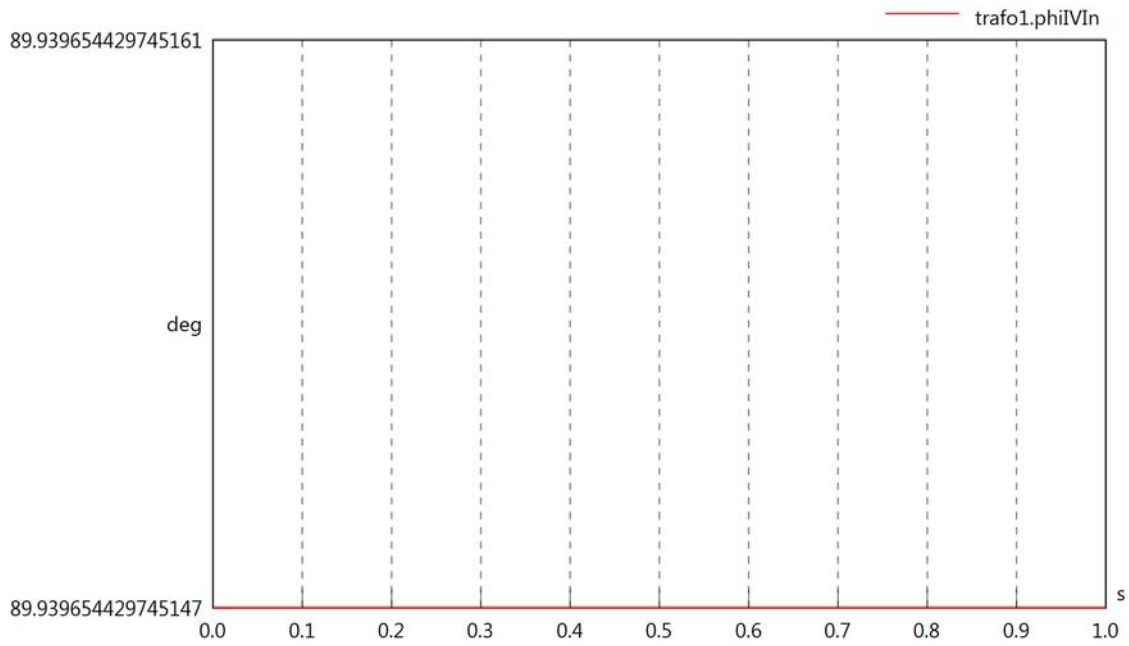

trafo1.PReIn

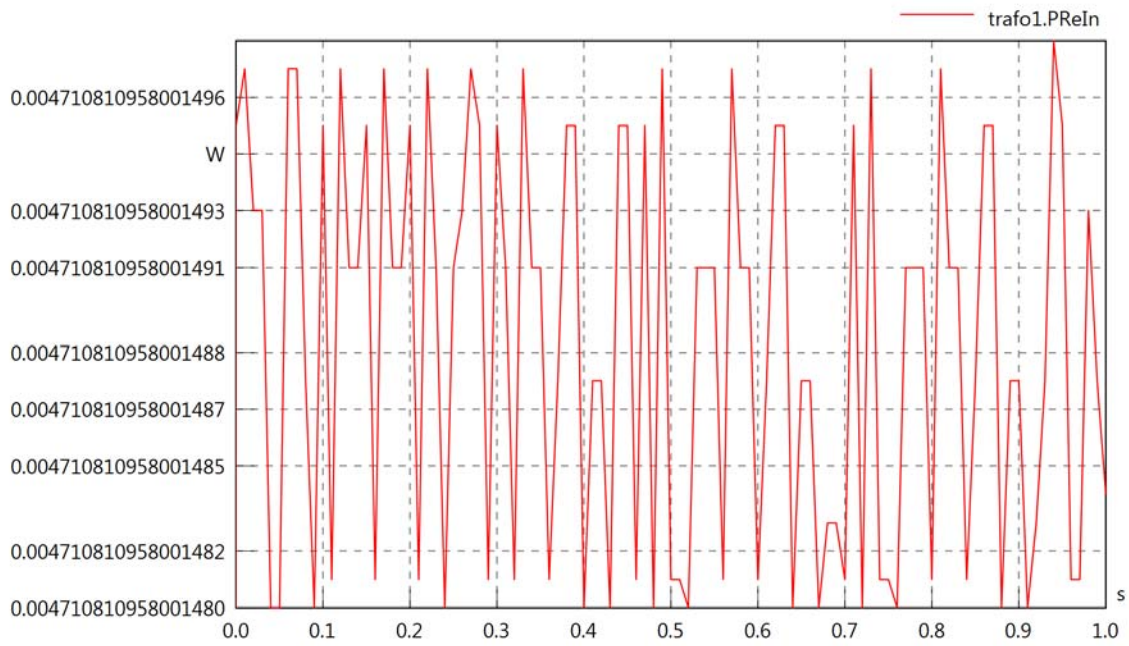

trafo1.PImIn

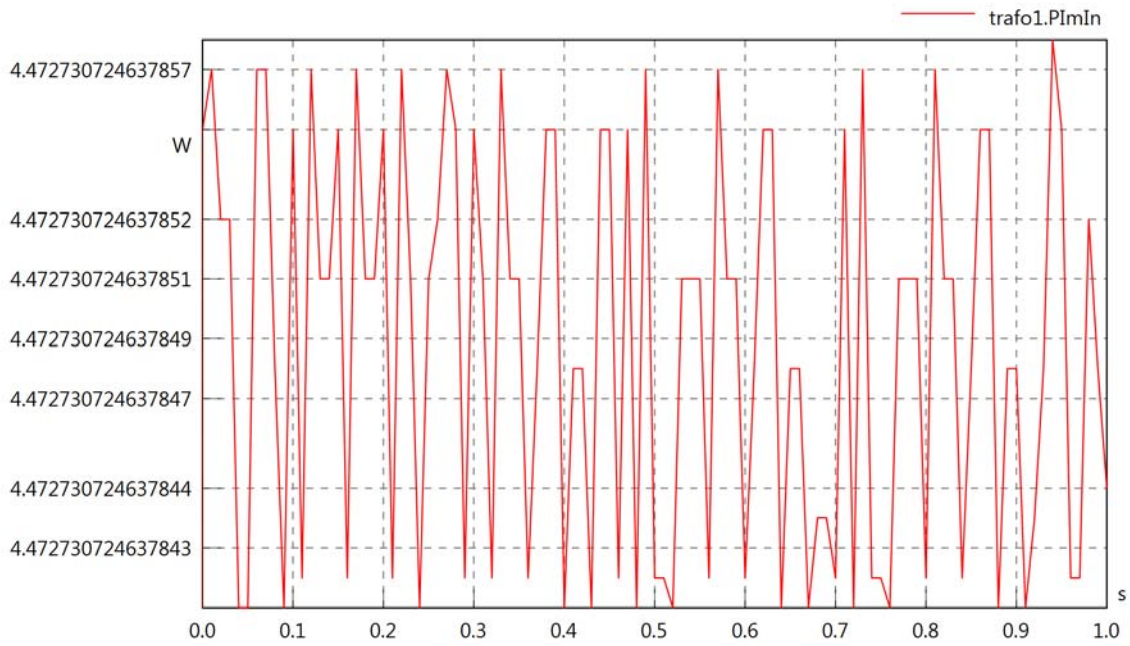

trafo1.SIn

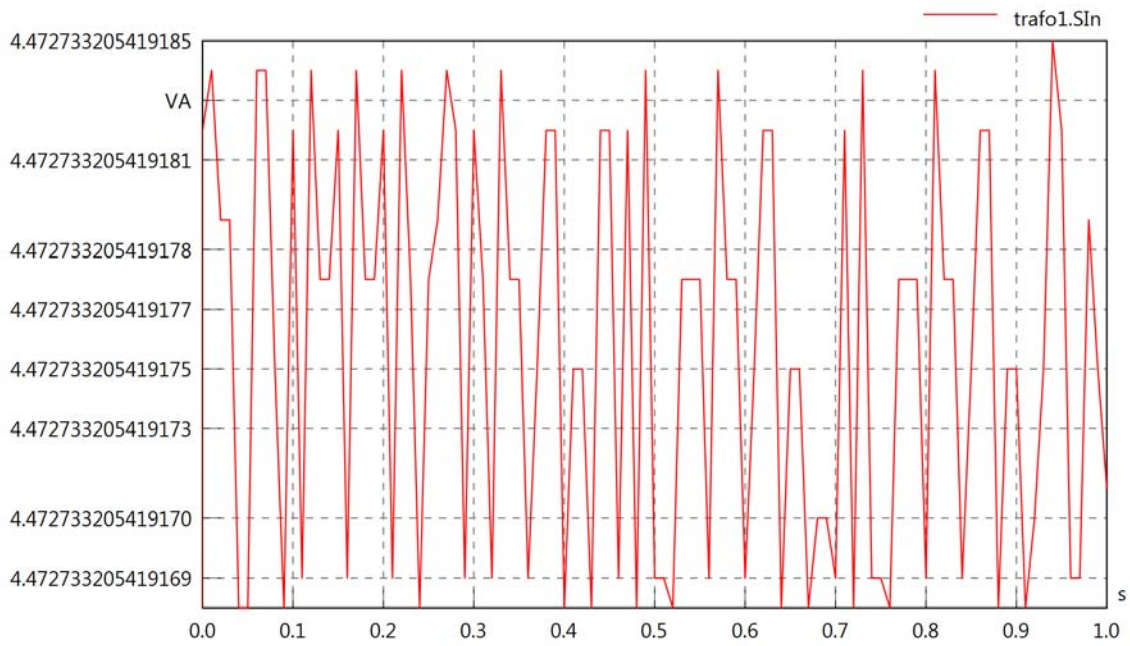

trafo1.pfIn

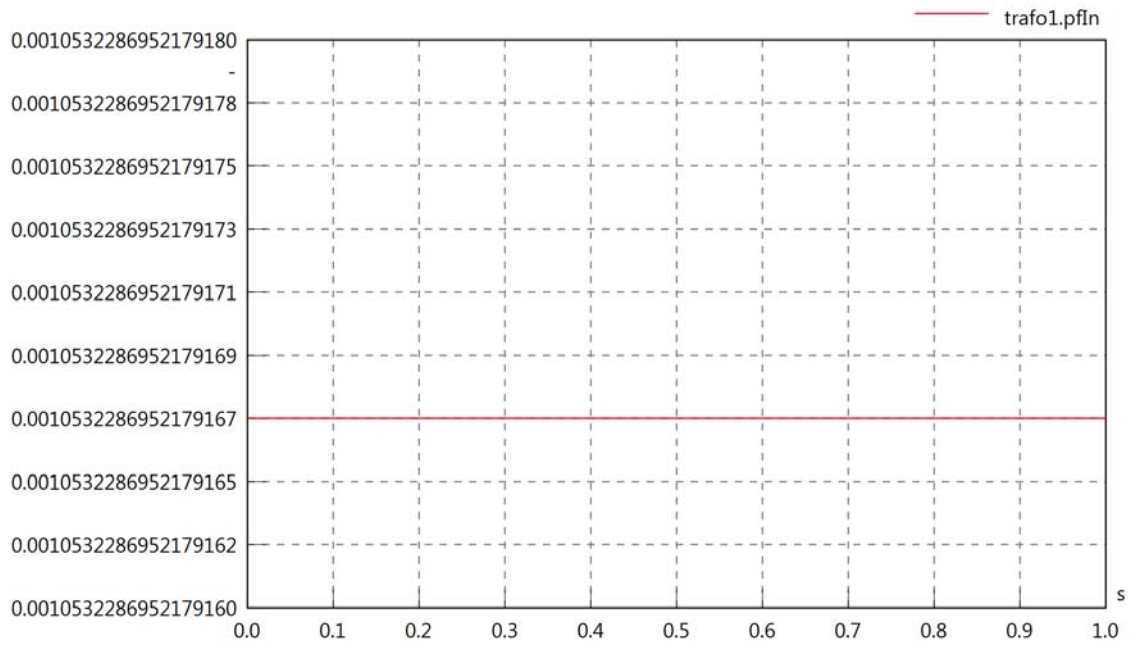

trafo1.VrmsOut

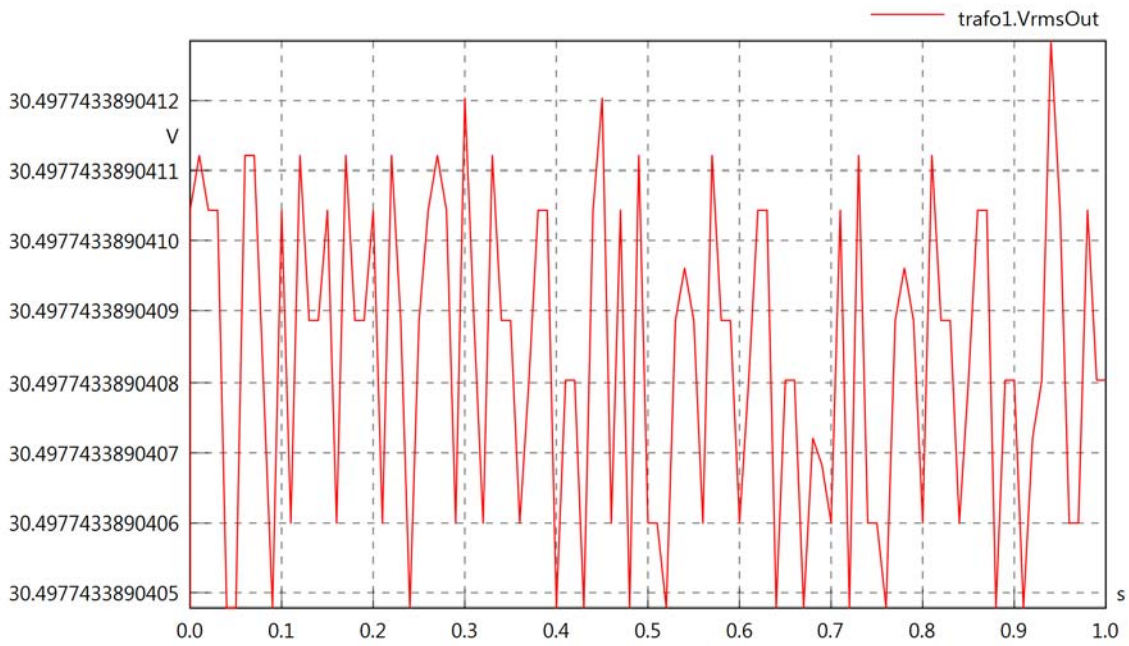

trafo1.vReOut

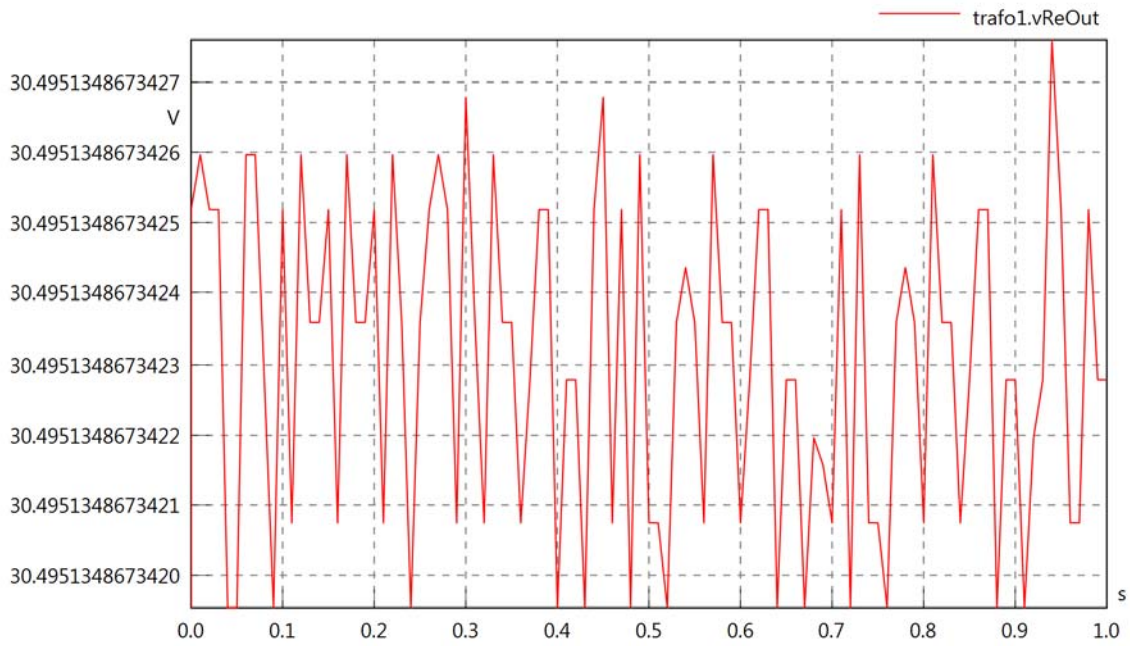

trafo1.vImOut

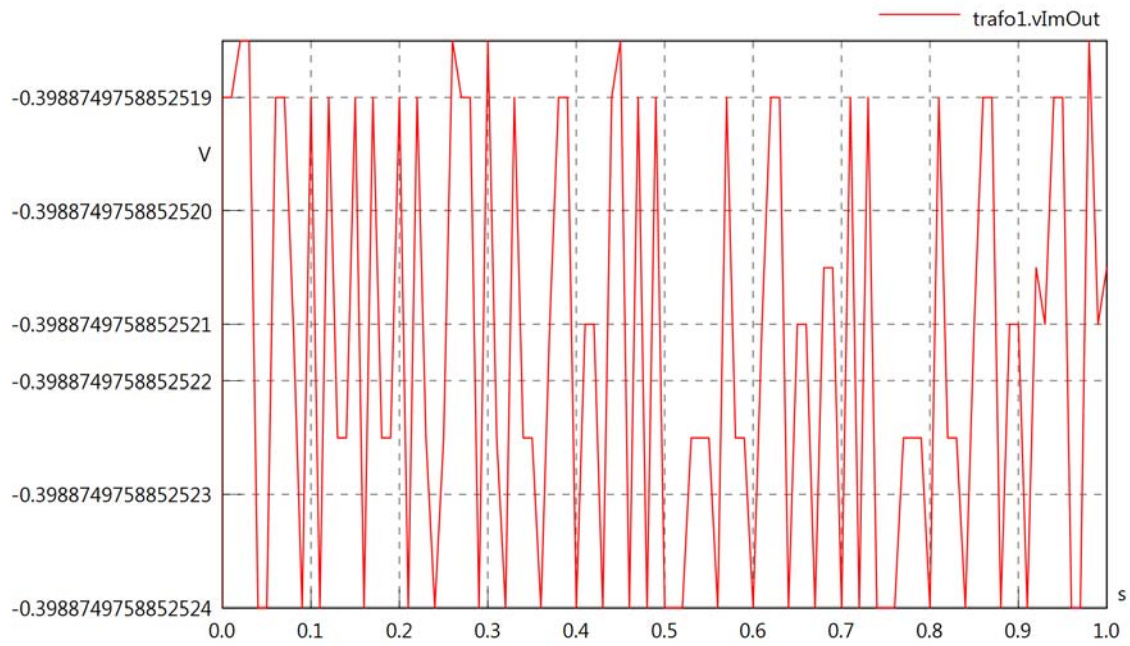

trafo1.IrmsOut

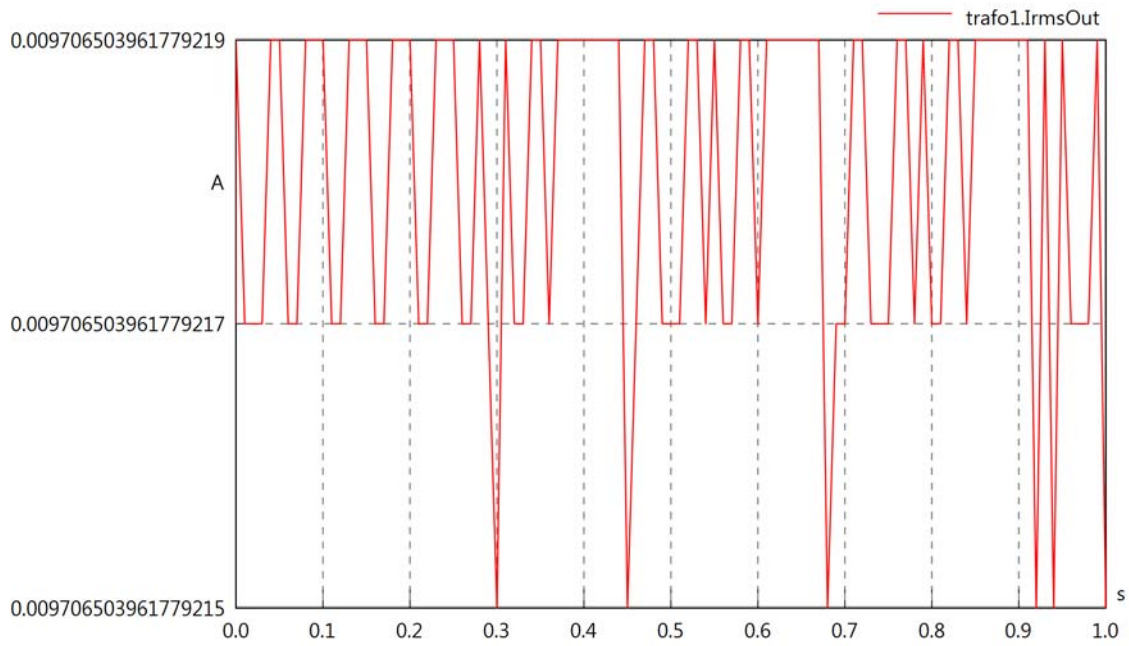

trafo1.iReOut

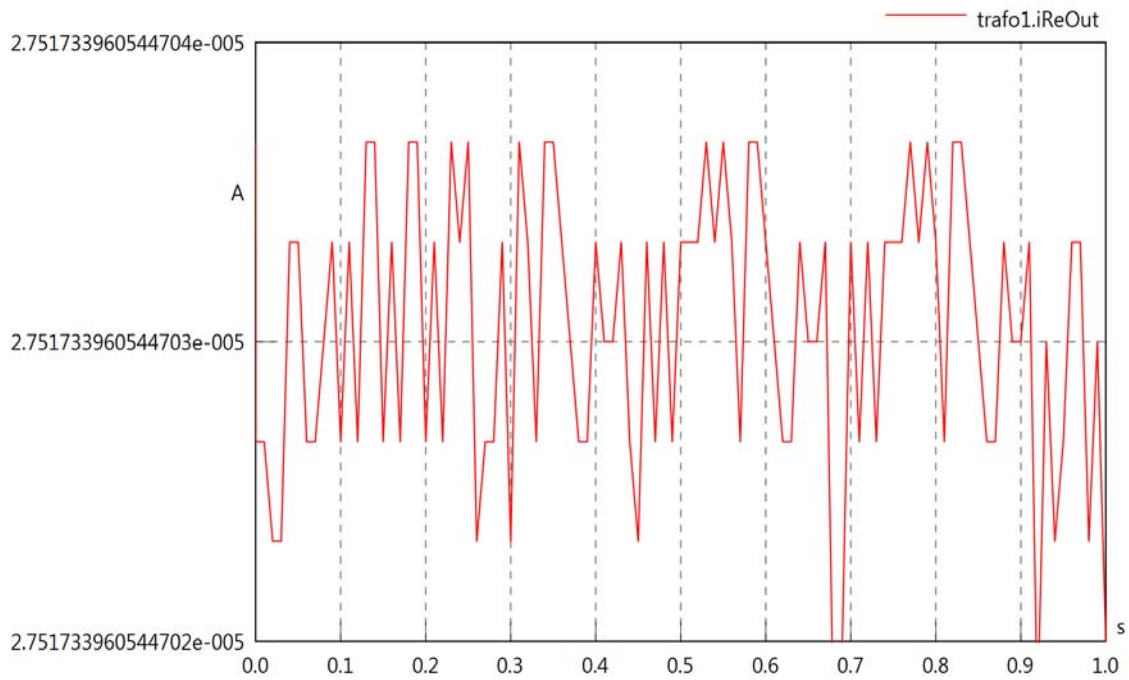

trafo1.iImOut

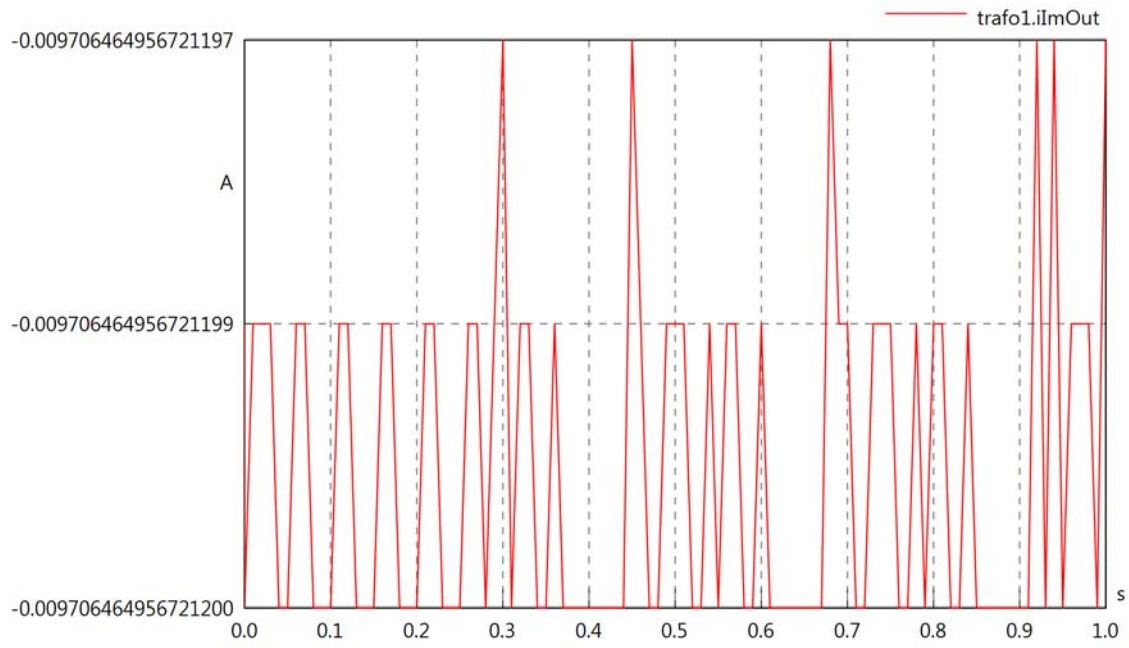

trafo1.phiVOut

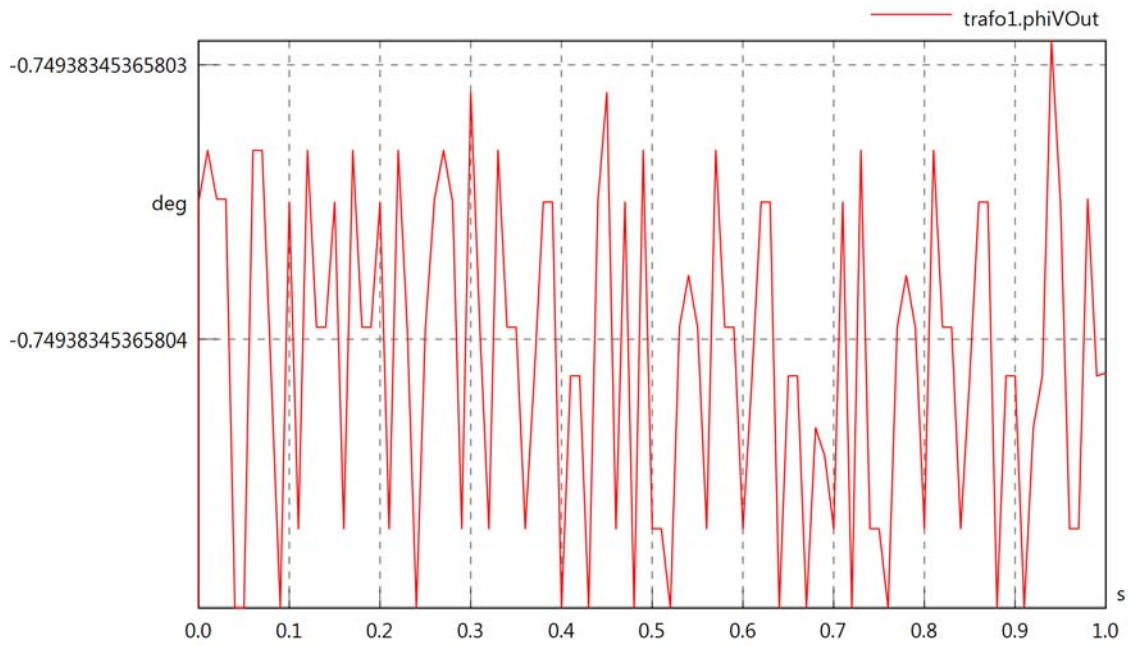

trafo1.phiIOut

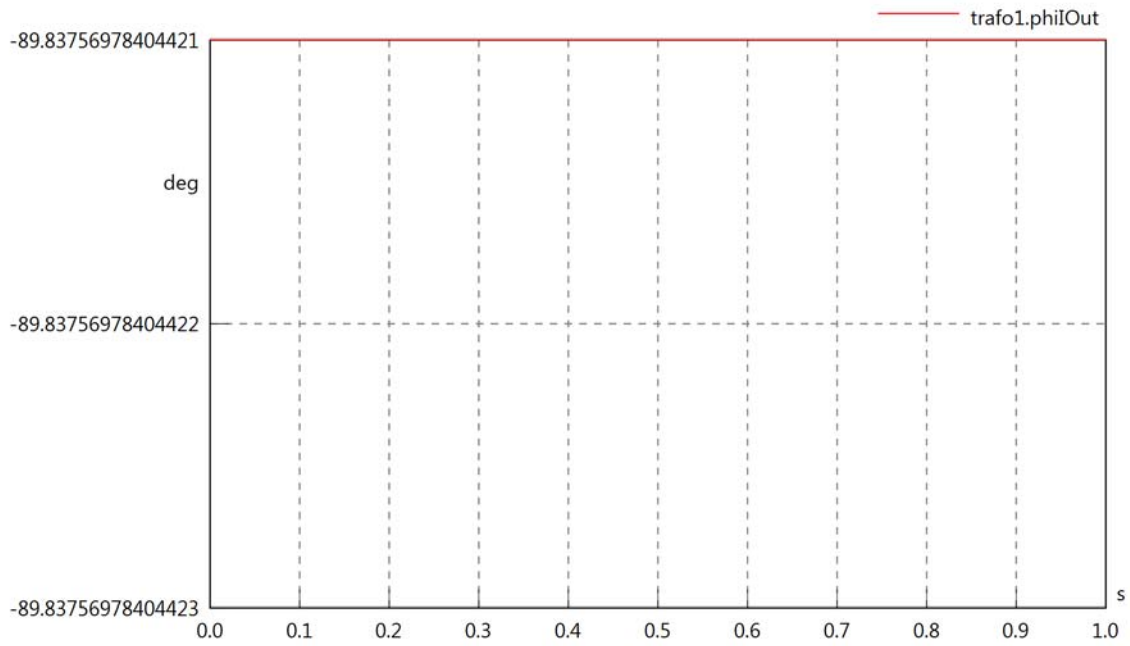

trafo1.phiIVOut

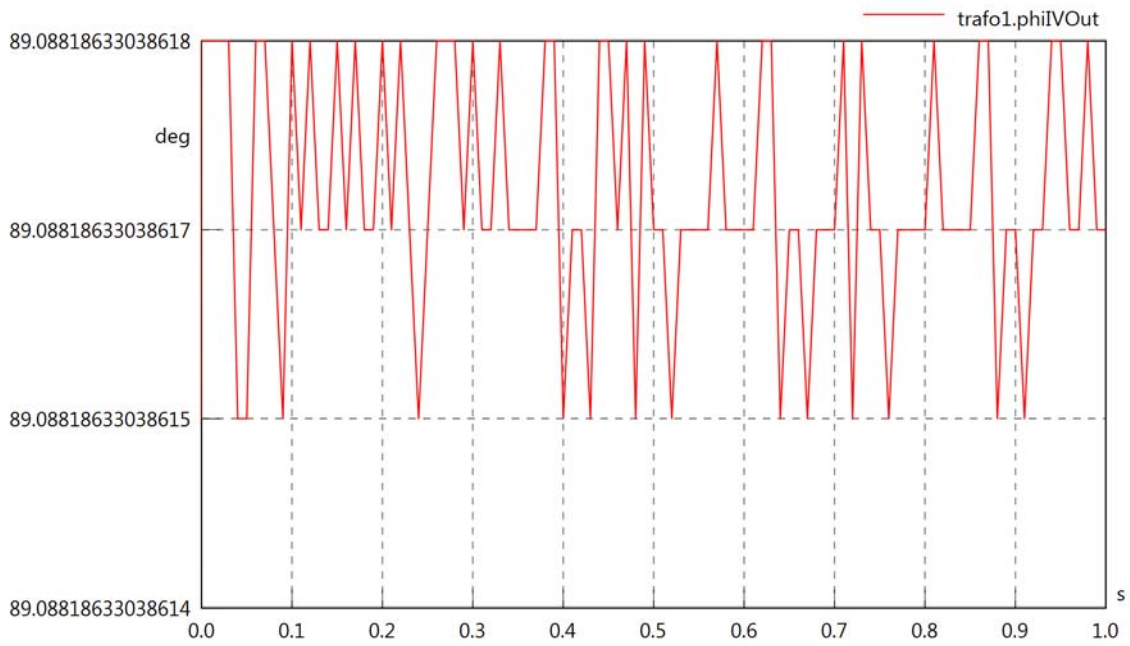

trafo1.PReOut

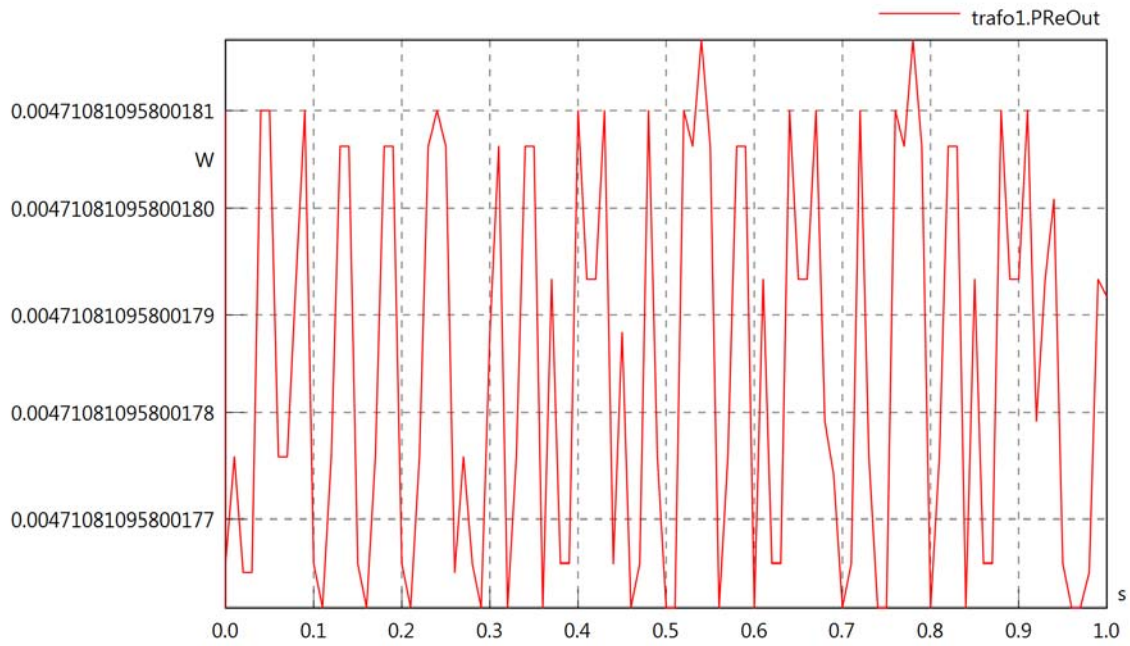

trafo1.PImOut

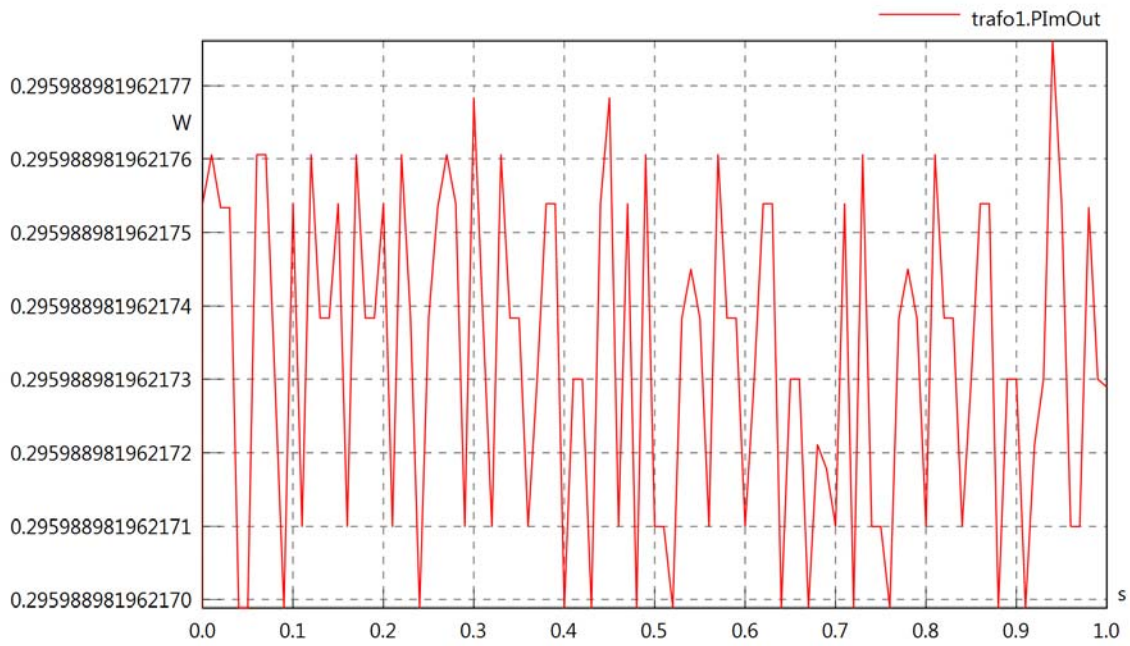

trafo1.SOut

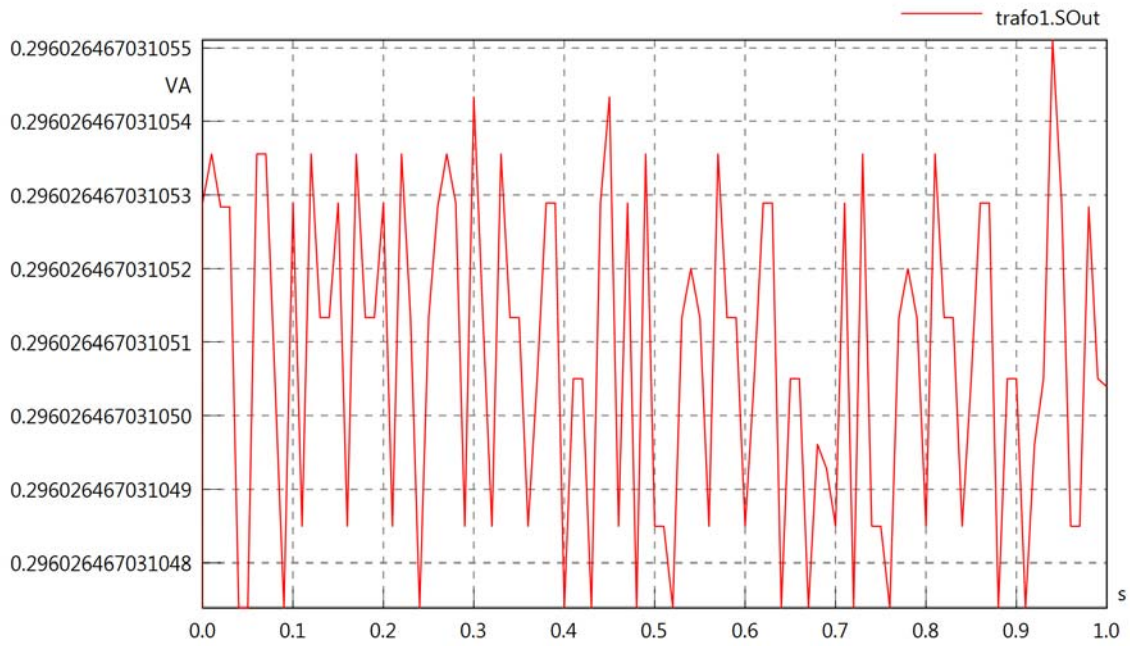

trafo1.pfOut

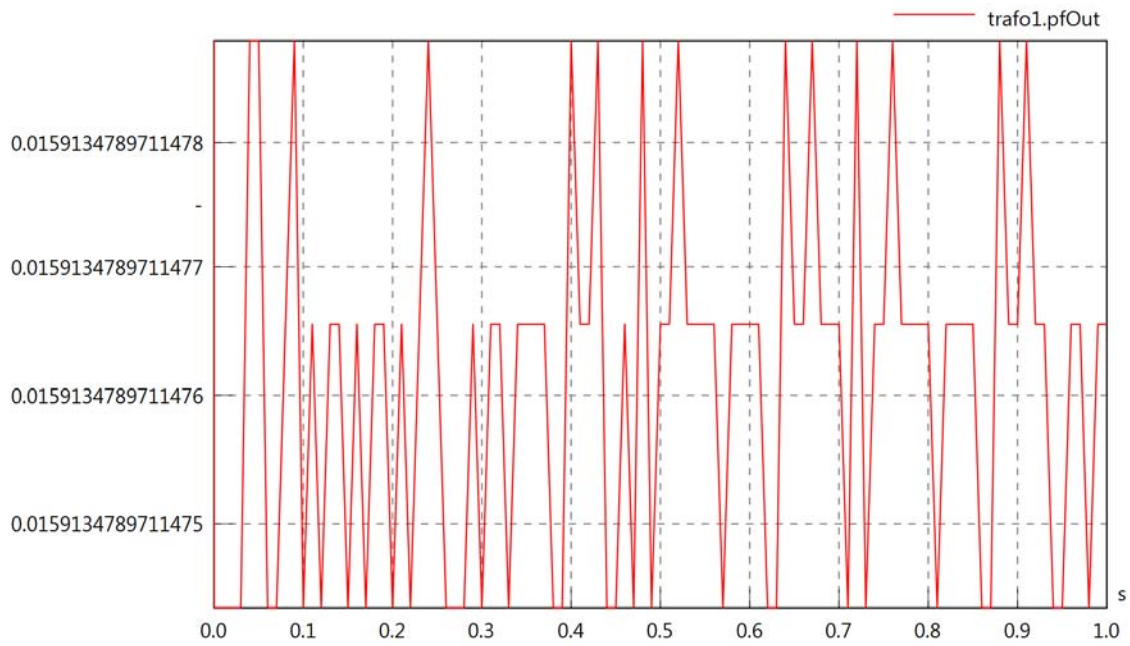
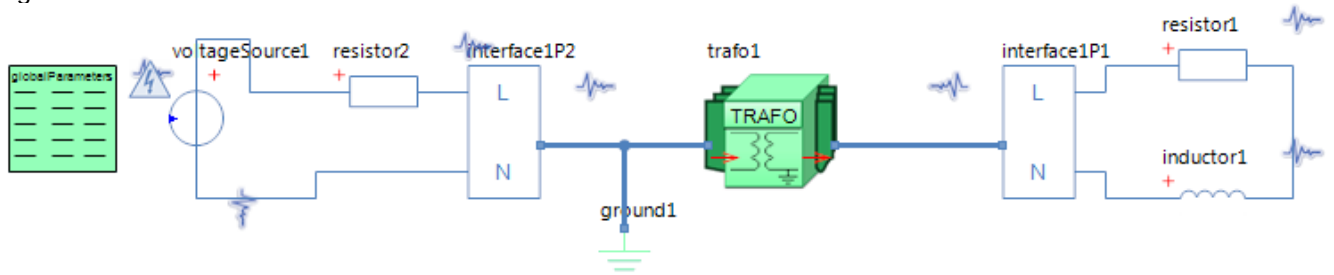

Diagram View



GlobalParameters globalParameters
Parameters

Comment	Name	Current Value	Unit
Type of Calculation	eCalculationKind	Signal Calculation	
Description of Frequency	eFrequencyKind	Linear	
Minimum Frequency	fMin	60	[Hz]
Maximum Frequency	fMax	60	[Hz]

Transformer trafo1
Parameters

Comment	Name	Current Value	Unit
Transformer Type	kind	Lossy Transformer	
Primary Winding Resistance	R1	5	[Ohm]
Primary Inductance	L1	40	[mH]
Initial Value	i10	0 (Fixed)	[A]
Secondary Winding Resistance	R2	5	[Ohm]
Secondary Inductance	L2	80	[mH]
Initial Value	i20	0 (Fixed)	[A]
Iron Loss Resistance	Rfe	50	[kOhm]
Mutual Coupling Inductance	M	$0.75 * \sqrt{L1 * L2}$	[H]

Voltage Source voltageSource1
Parameters

Comment	Name	Current Value	Unit
Voltage RMS	VrmsSrc	230	[V]
Phase	phi	0	[deg]

Resistor resistor1
Parameters

Comment	Name	Current Value	Unit
Resistance	R	50	[Ohm]

Inductor inductor1
Parameters

Comment	Name	Current Value	Unit
Inductance	L	5	[mH]

Resistor resistor2
Parameters

Comment	Name	Current Value	Unit
Resistance	R	10	[Ohm]

trafo1.n

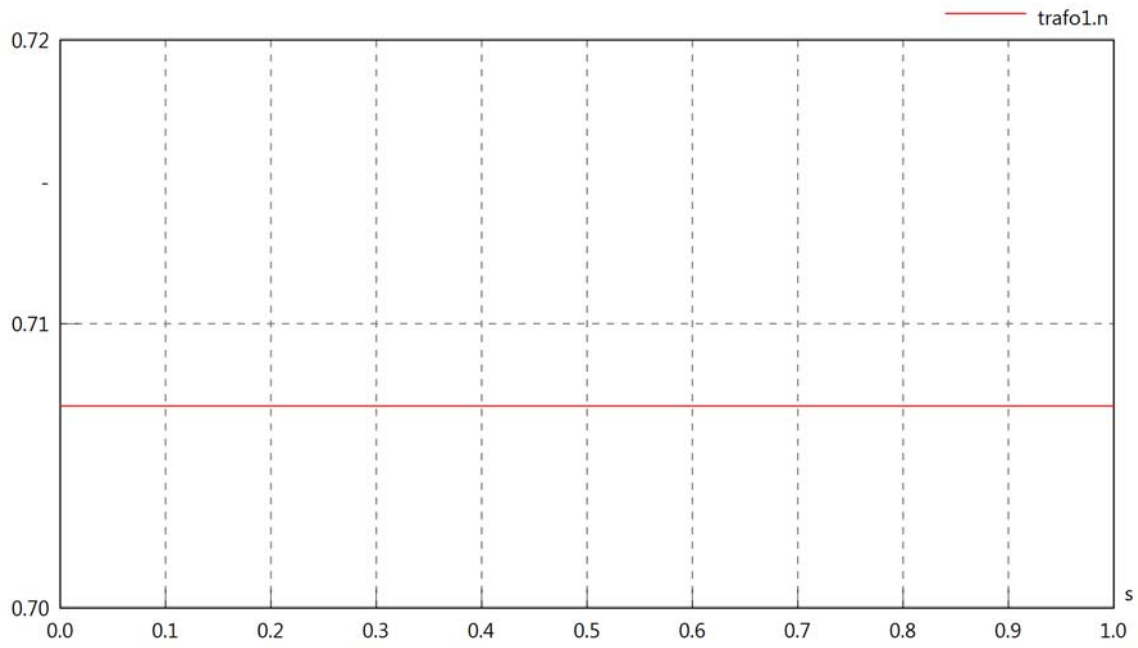

trafo1.k

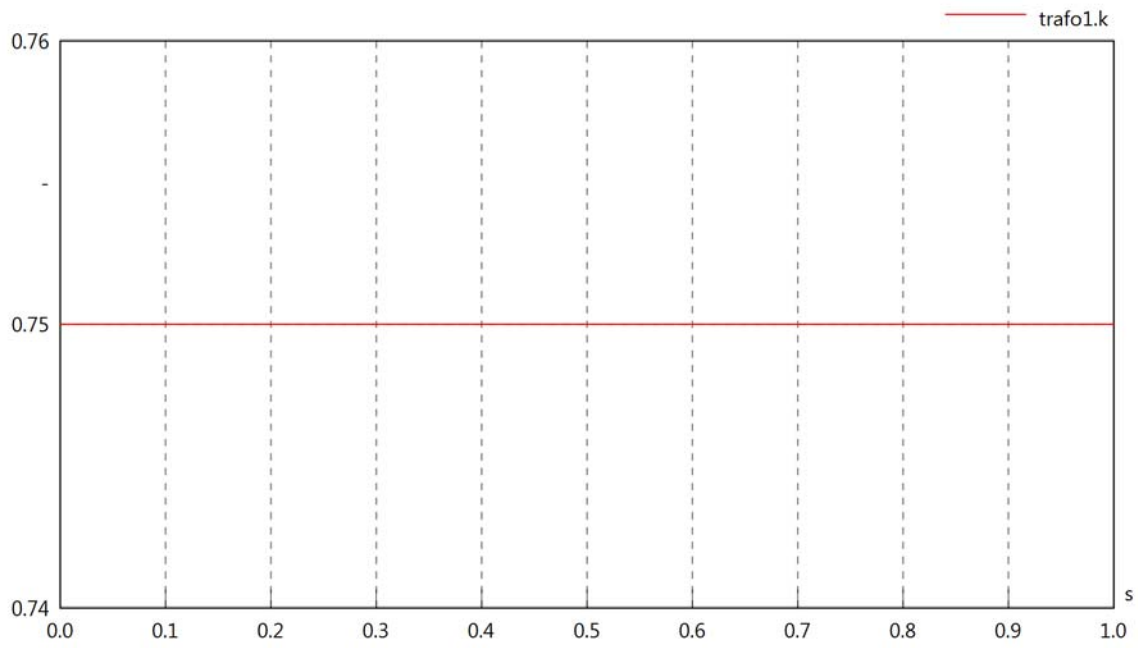

trafo1.VrmsIn

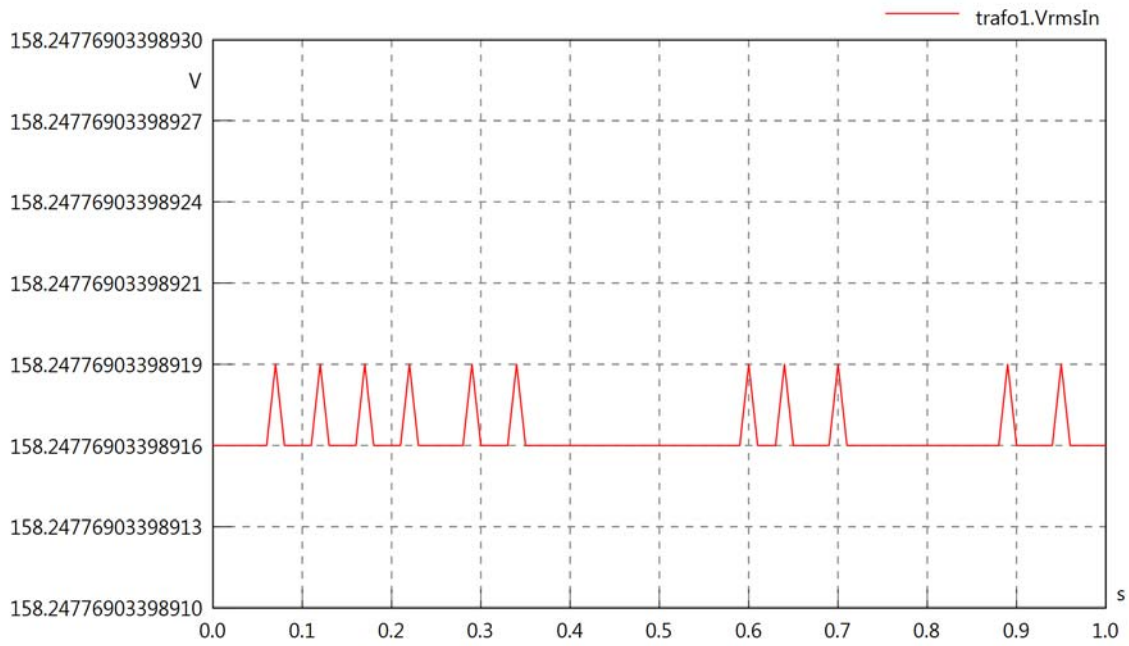

trafo1.vReIn

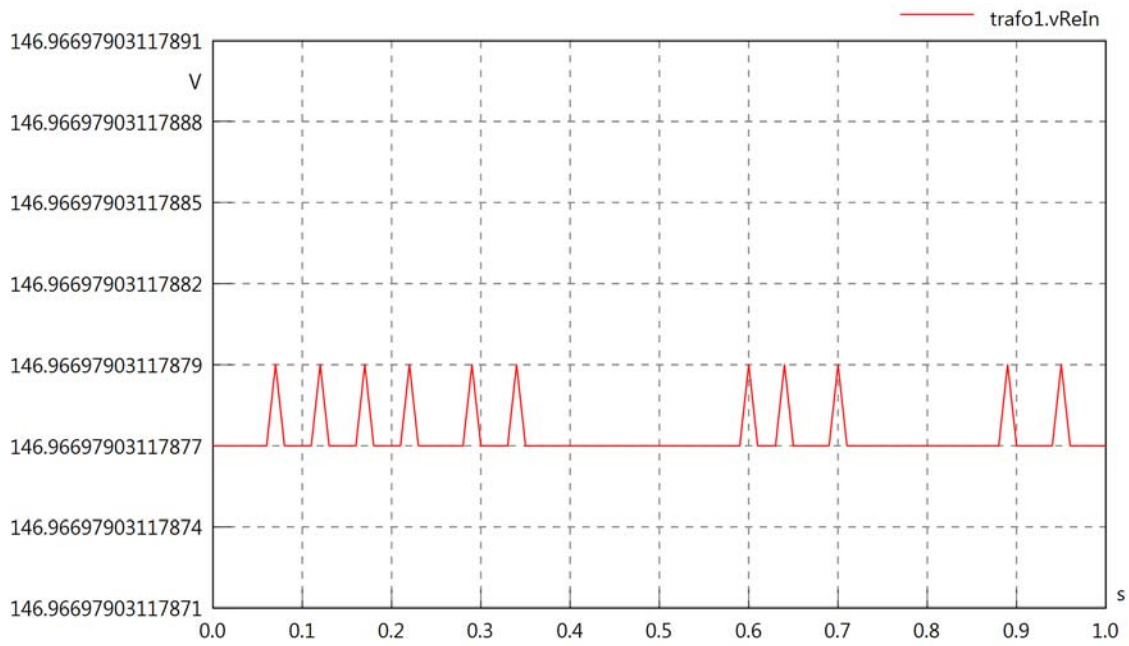

trafo1.vlmIn

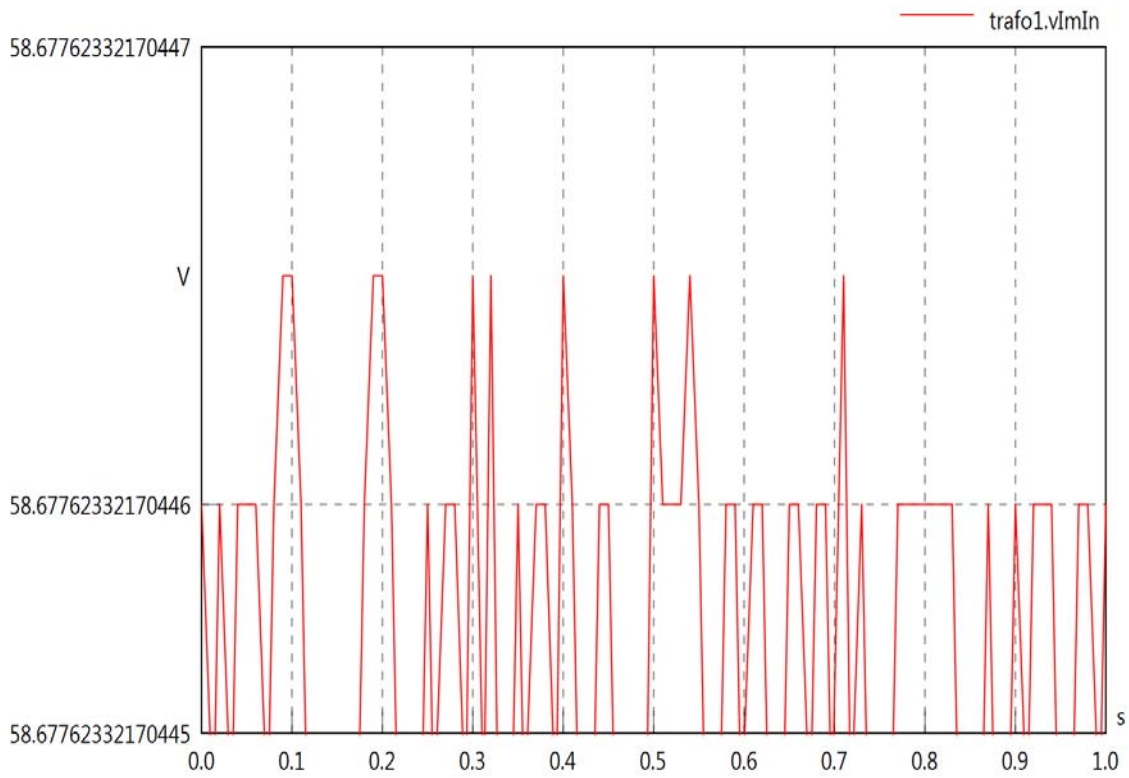

trafo1.IrmsIn

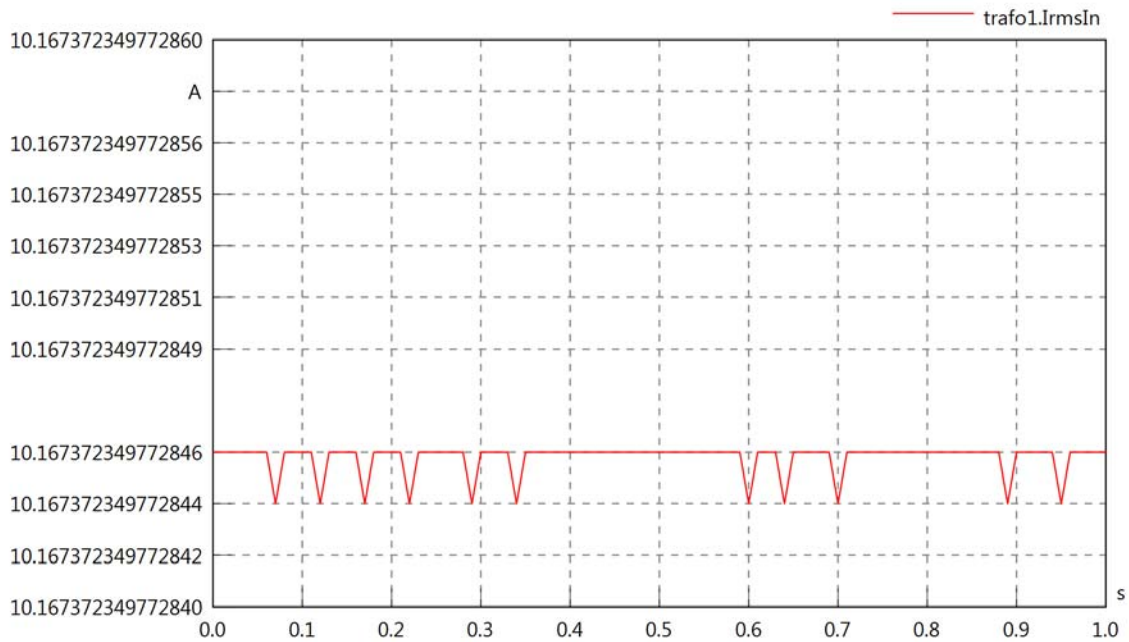

trafo1.iReIn

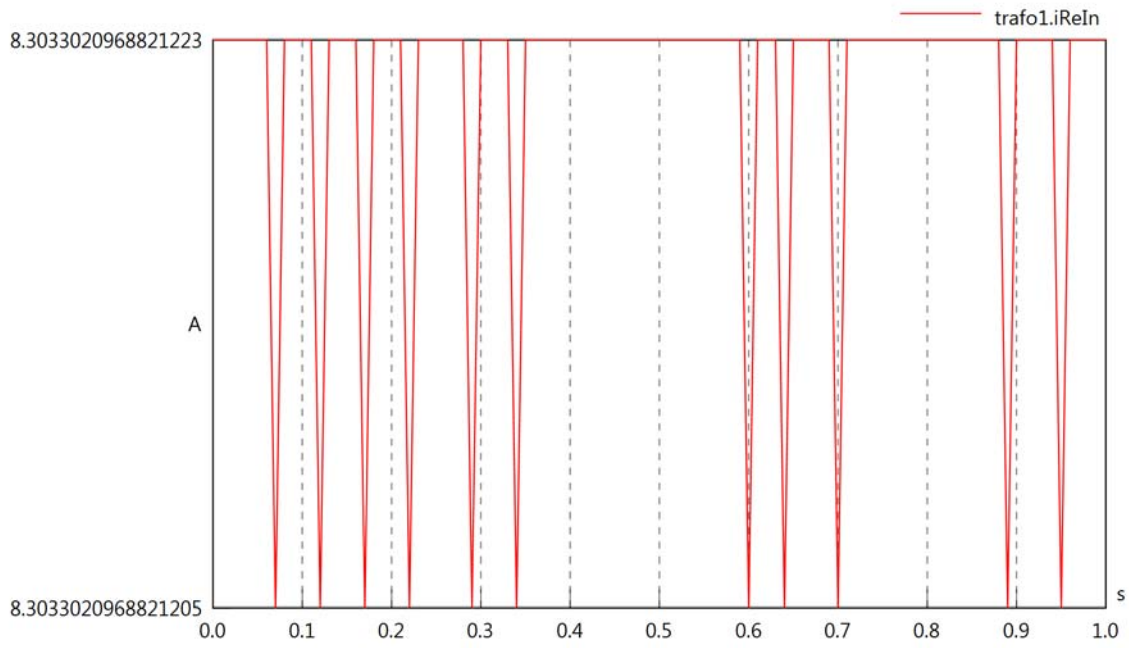

trafo1.iImIn

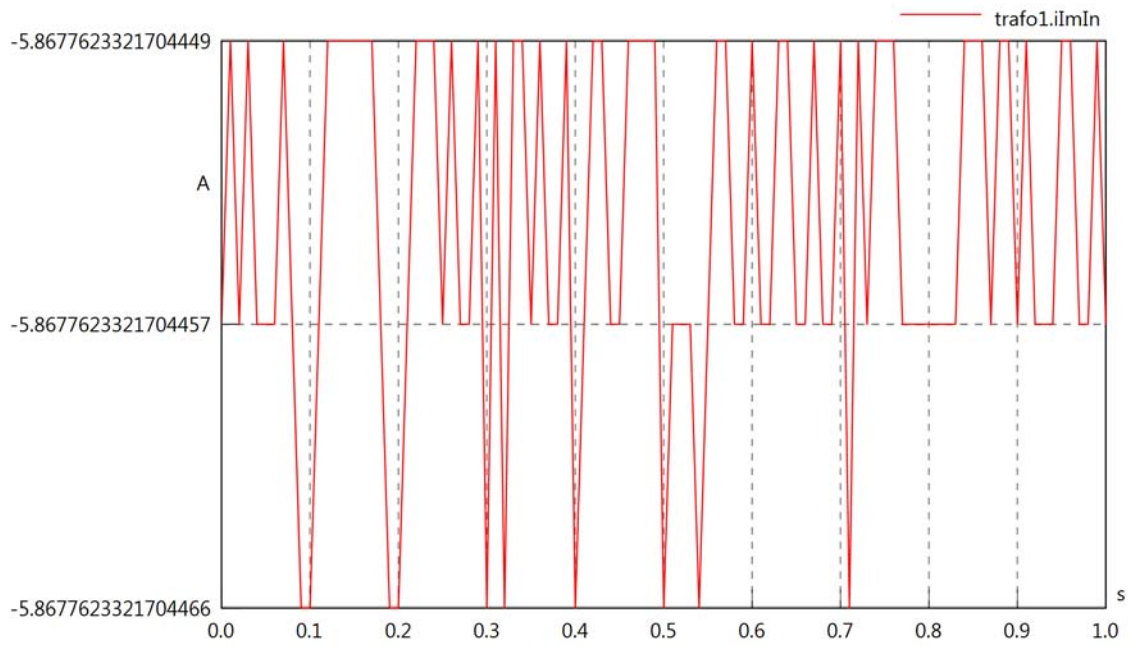

trafo1.phiVIn

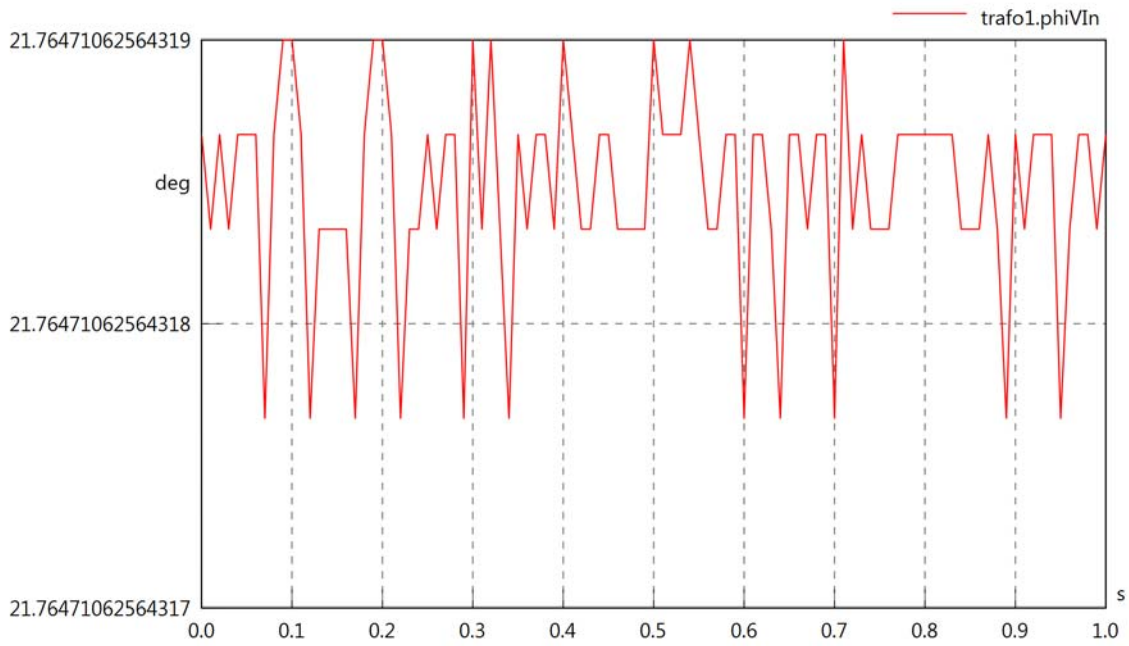

trafo1.phiIIIn

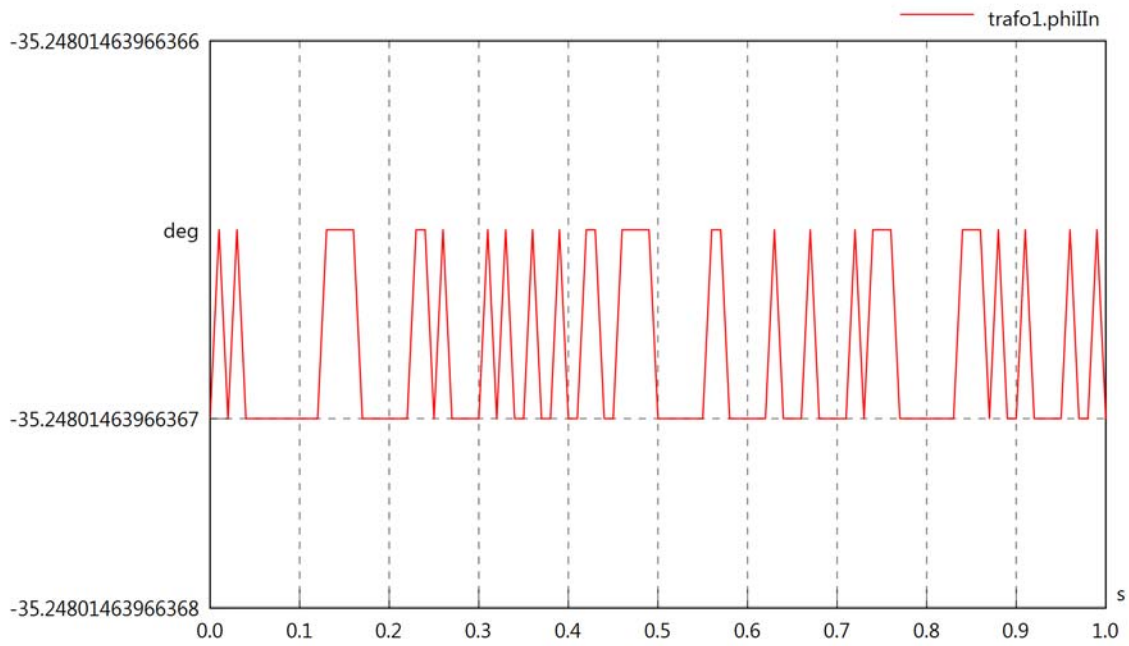

trafo1.phiIVIn

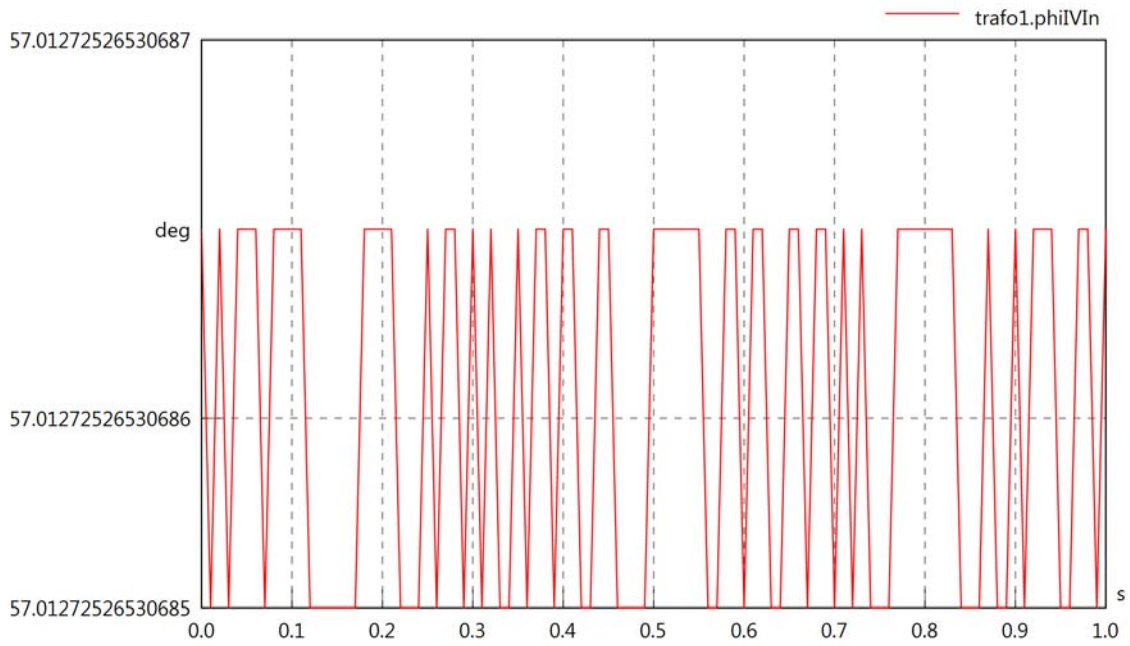

trafo1.PReIn

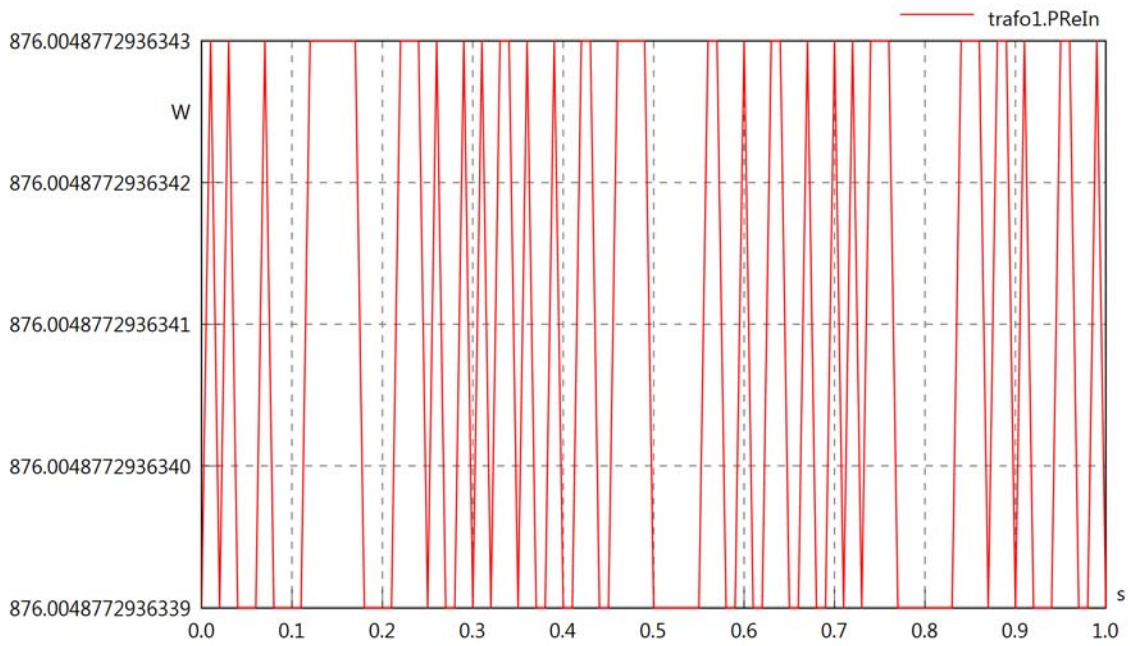

trafo1.PImIn

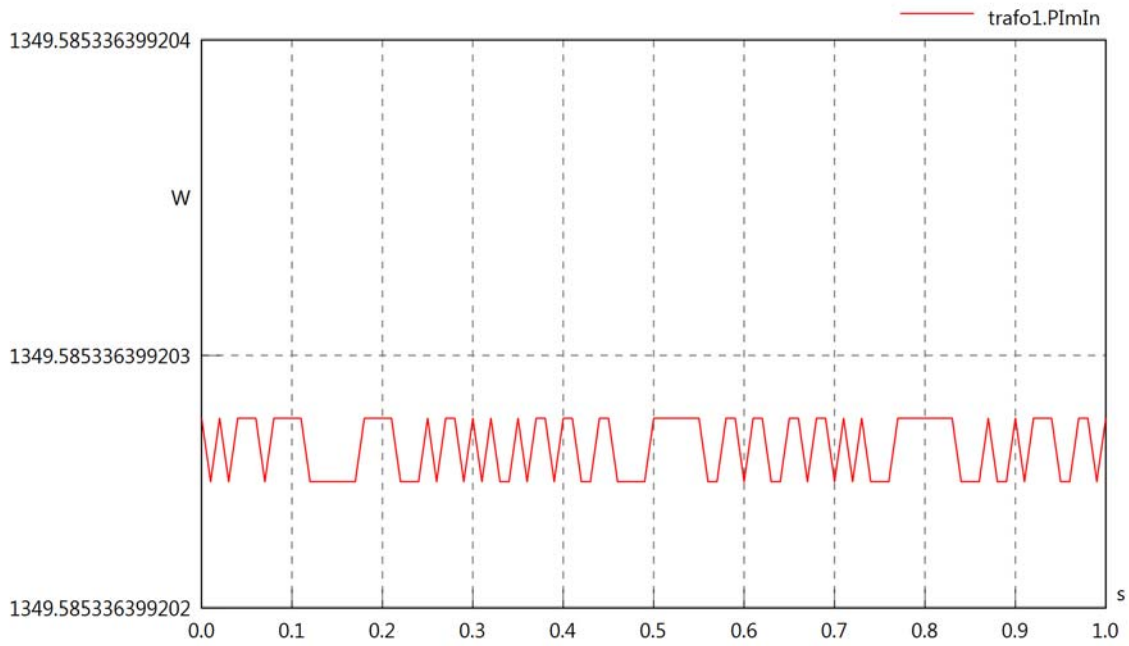

trafo1.SIn

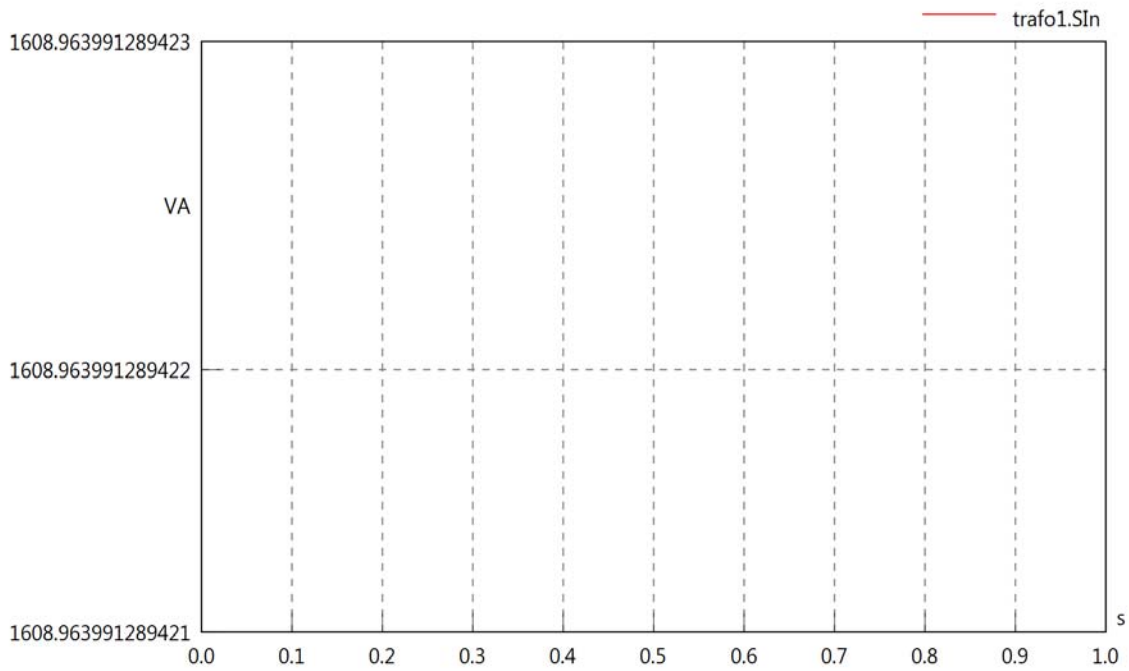

trafo1.pfIn

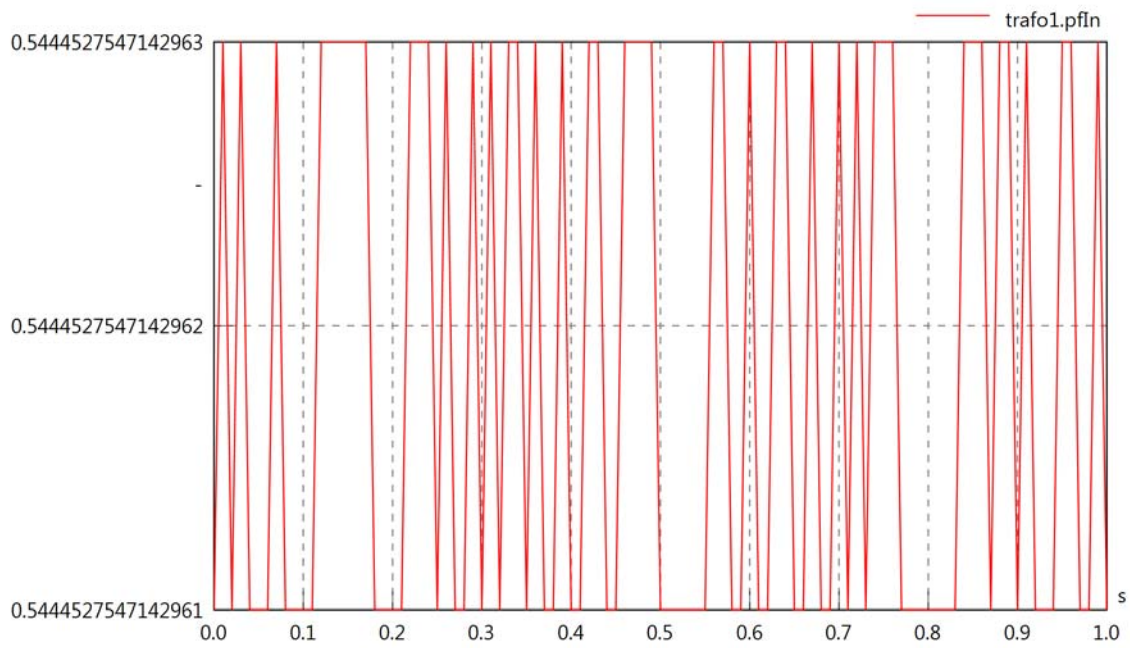

trafo1.VrmsOut

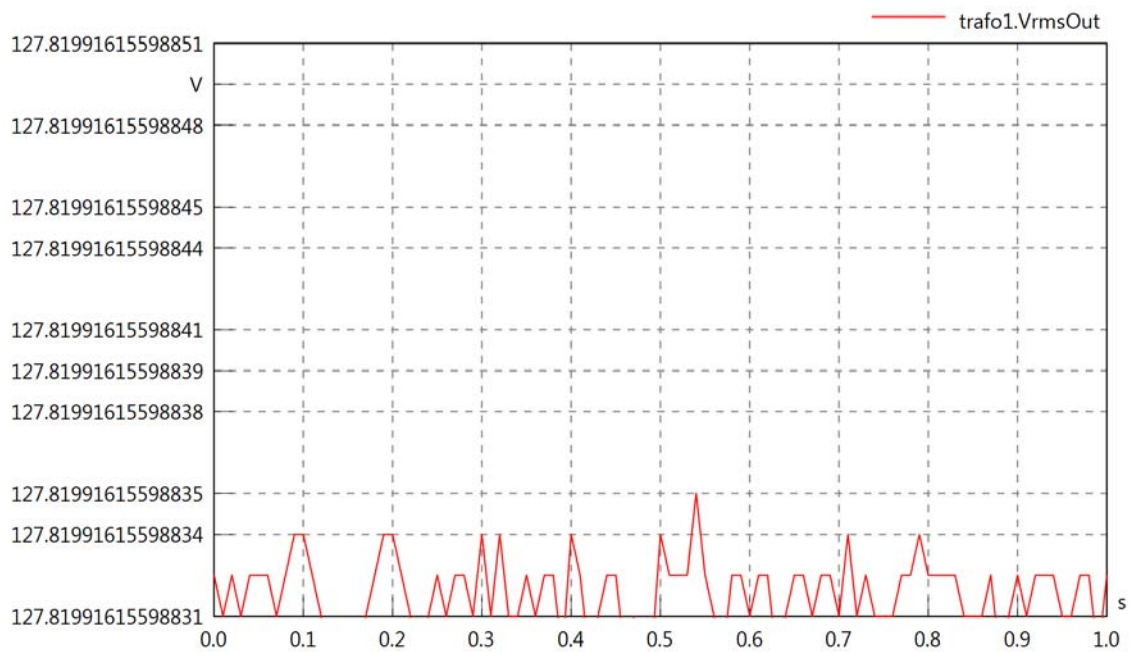

trafo1.vReOut

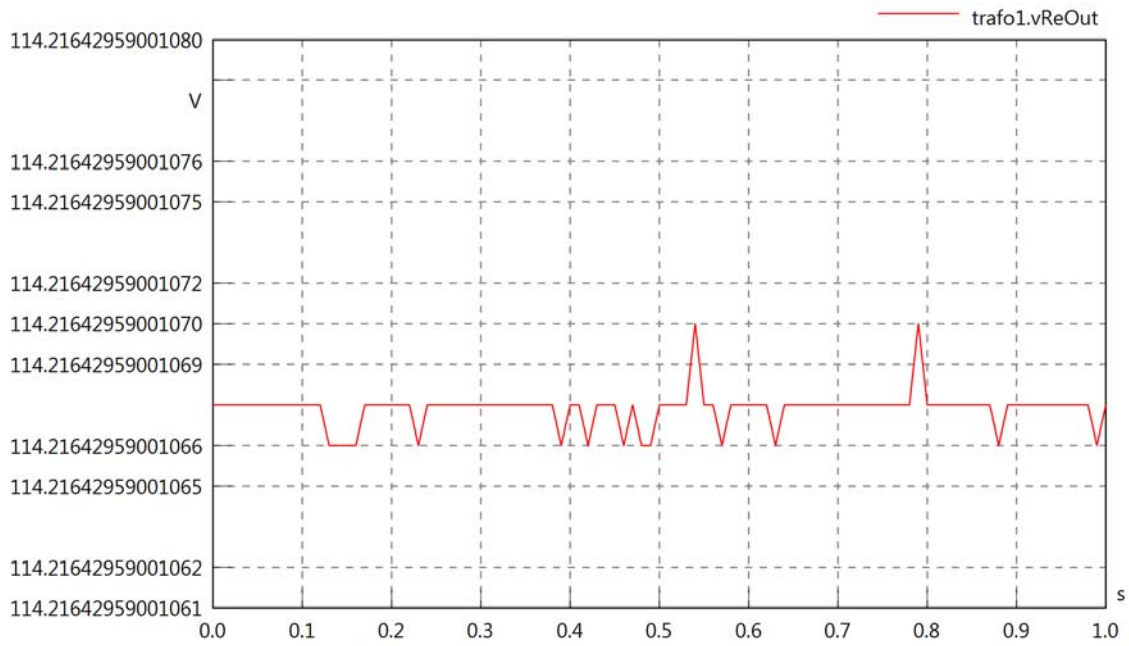

trafo1.vImOut

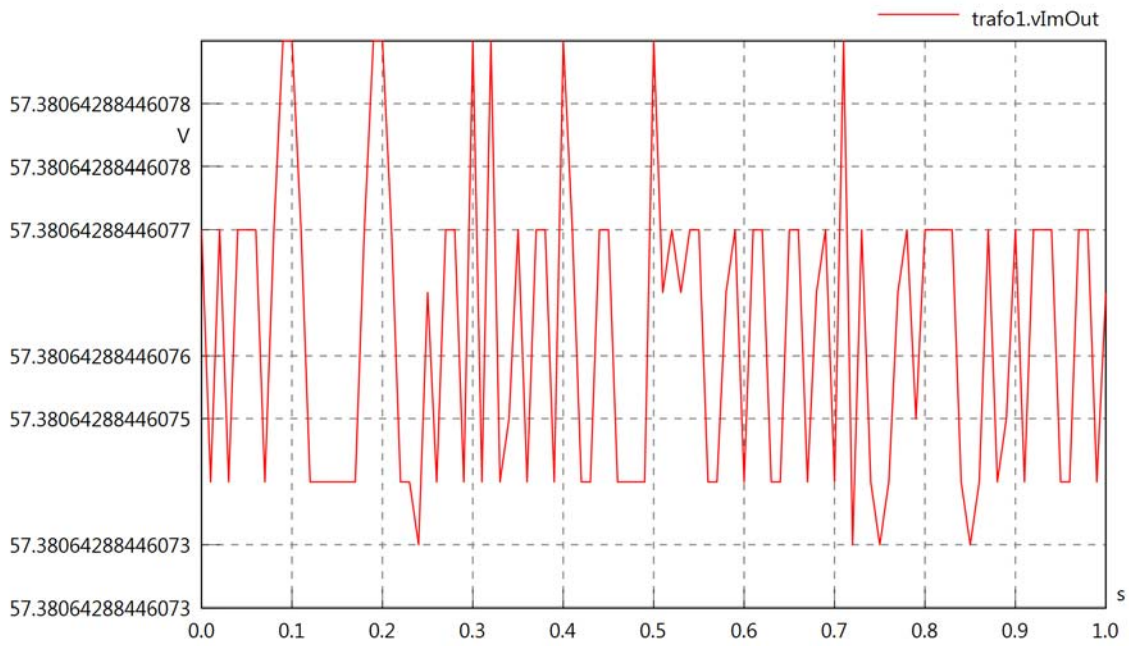

trafo1.IrmsOut

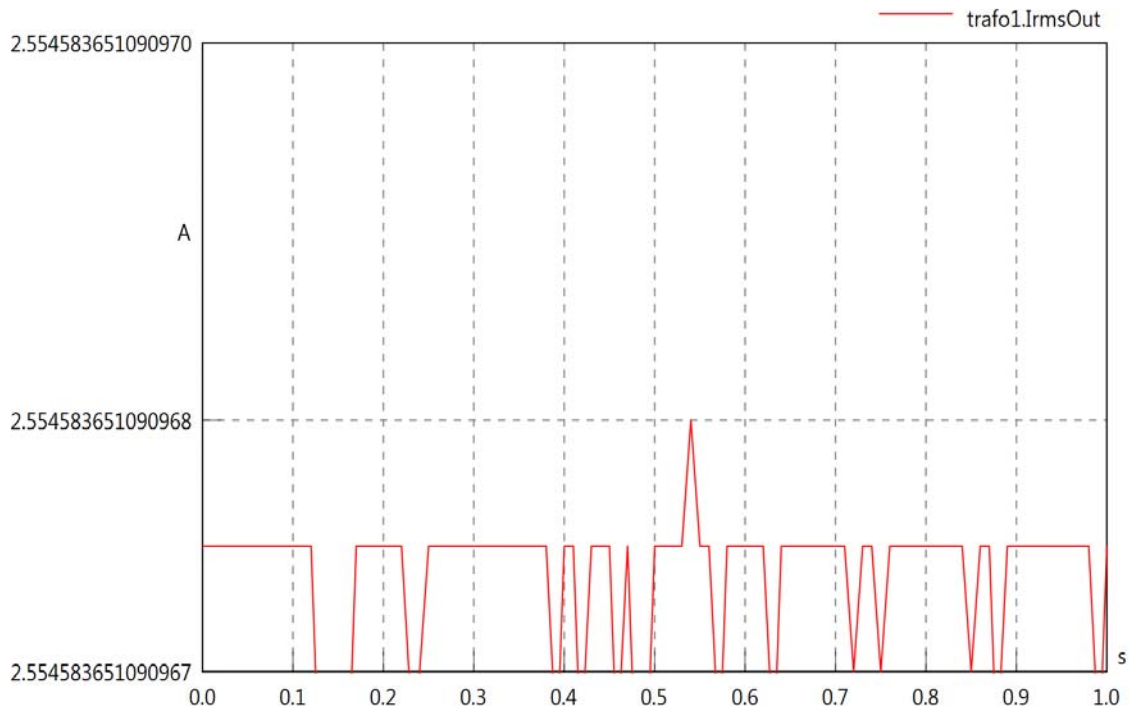

trafo1.iReOut

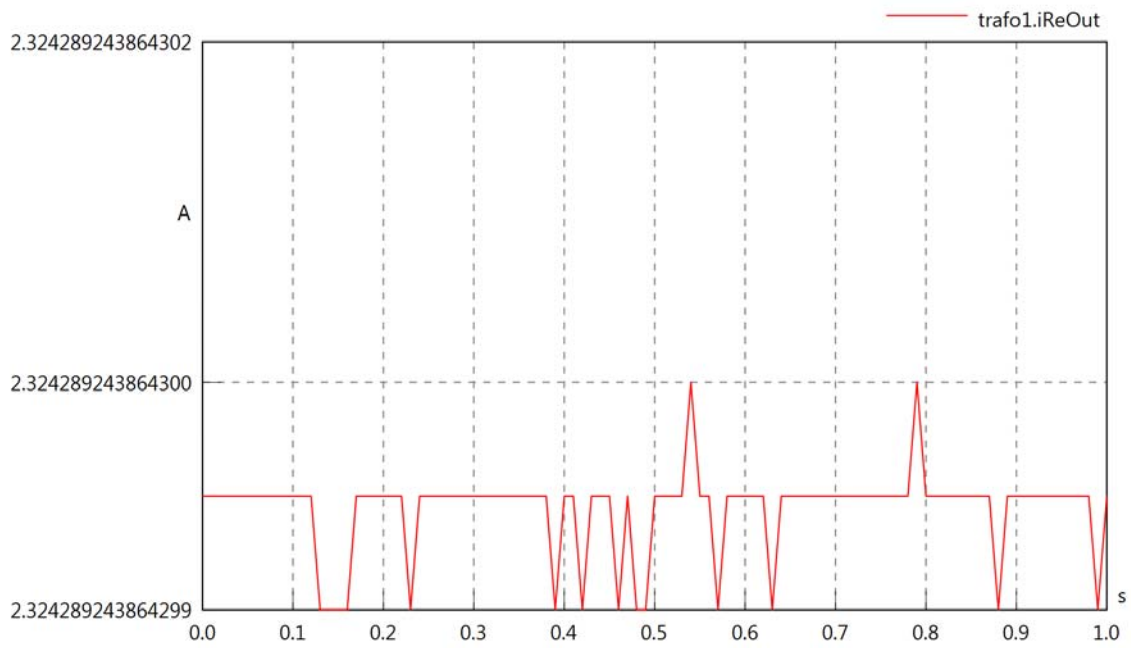

trafo1.iImOut

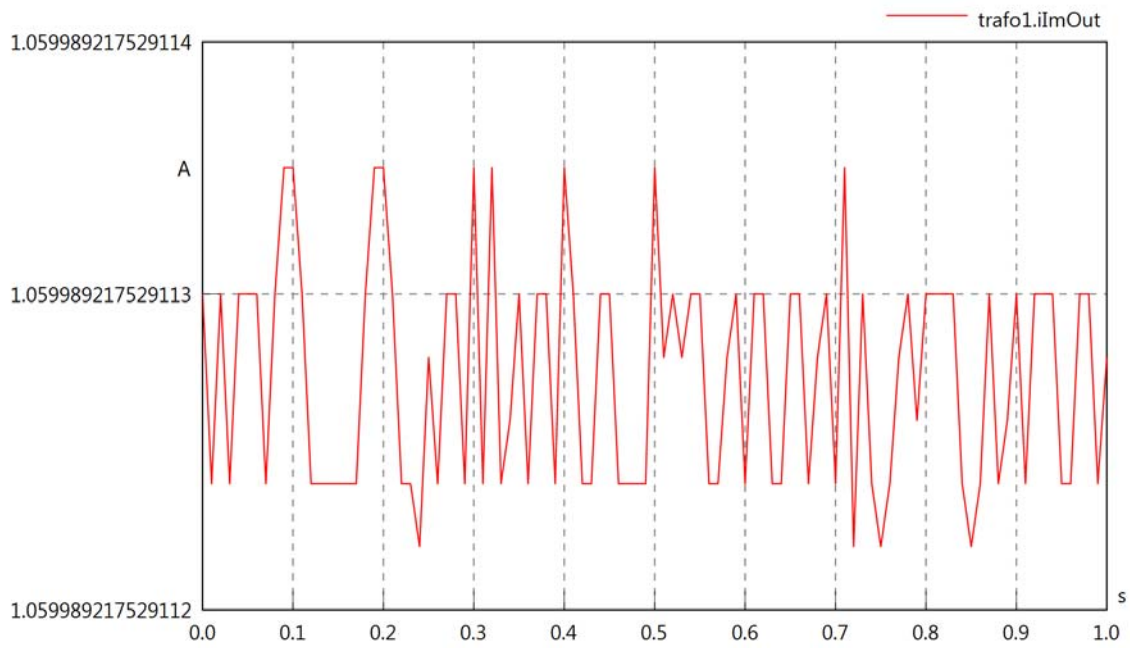

trafo1.phiVOut

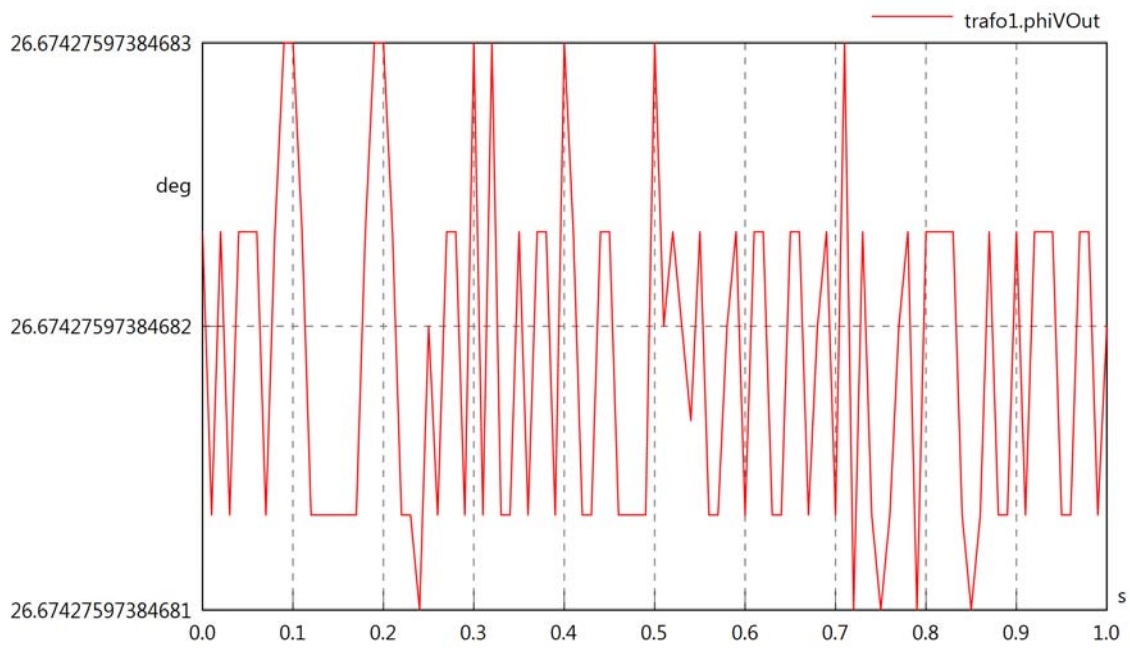

trafo1.phiIOut

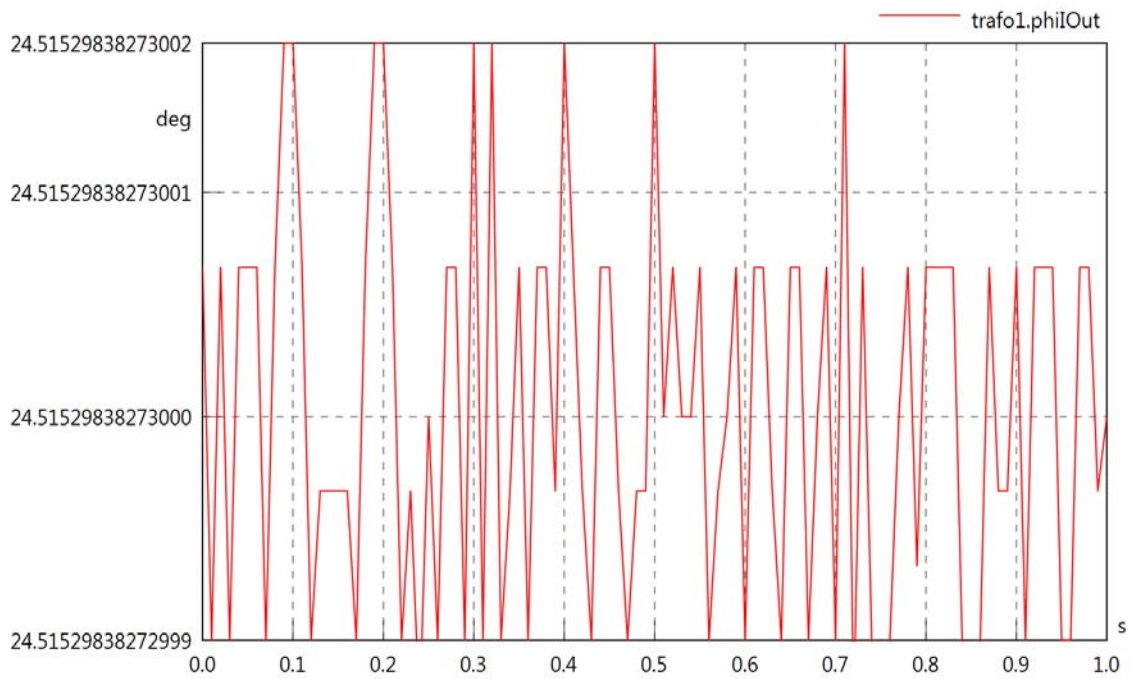

trafo1.phiIVOut

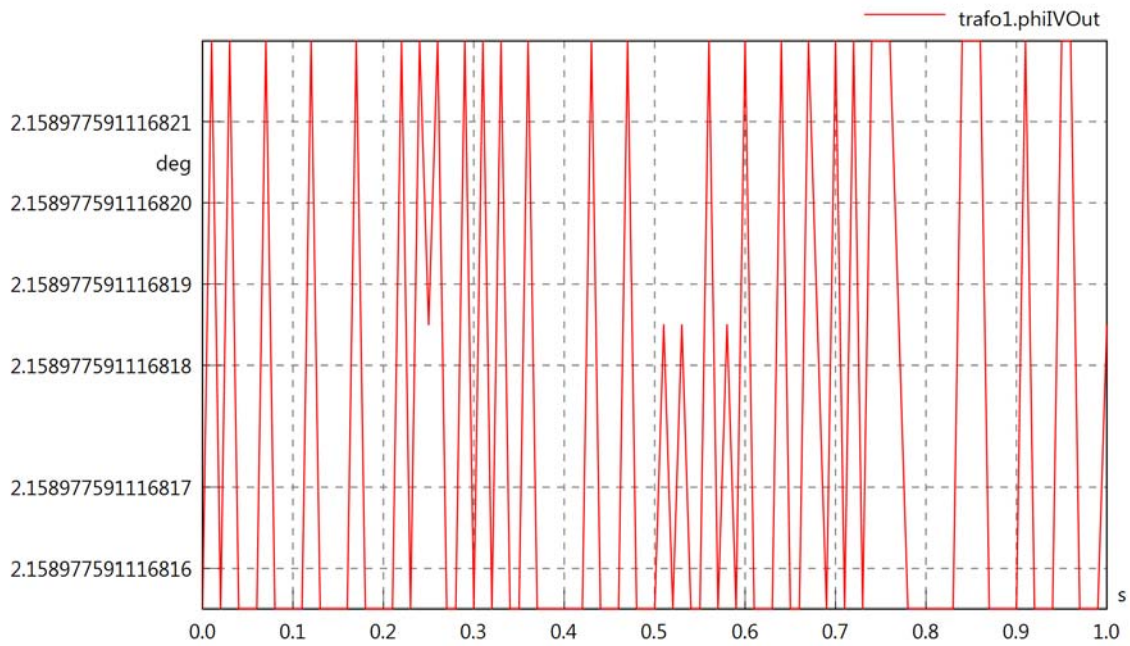

trafo1.PReOut

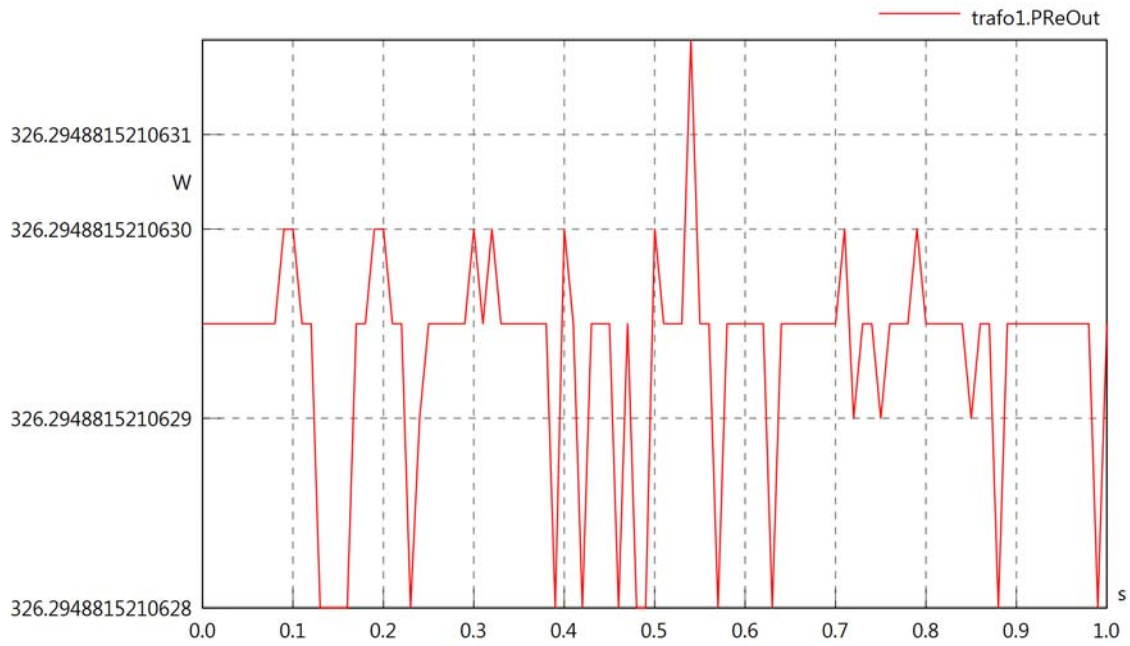

trafo1.PImOut

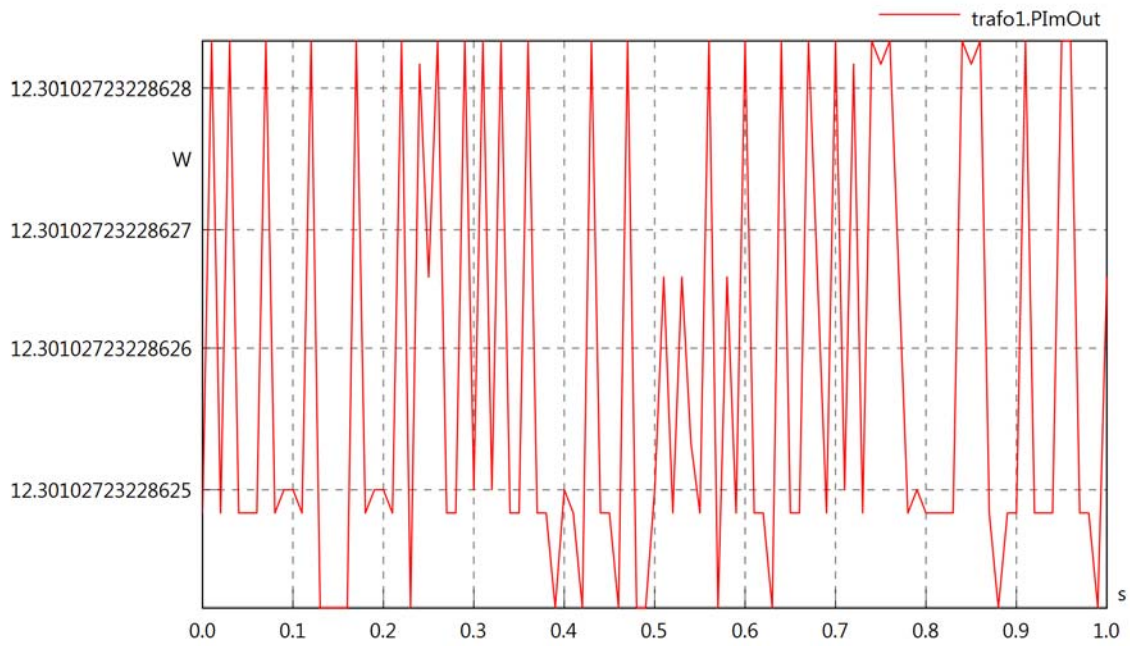

trafo1.SOut

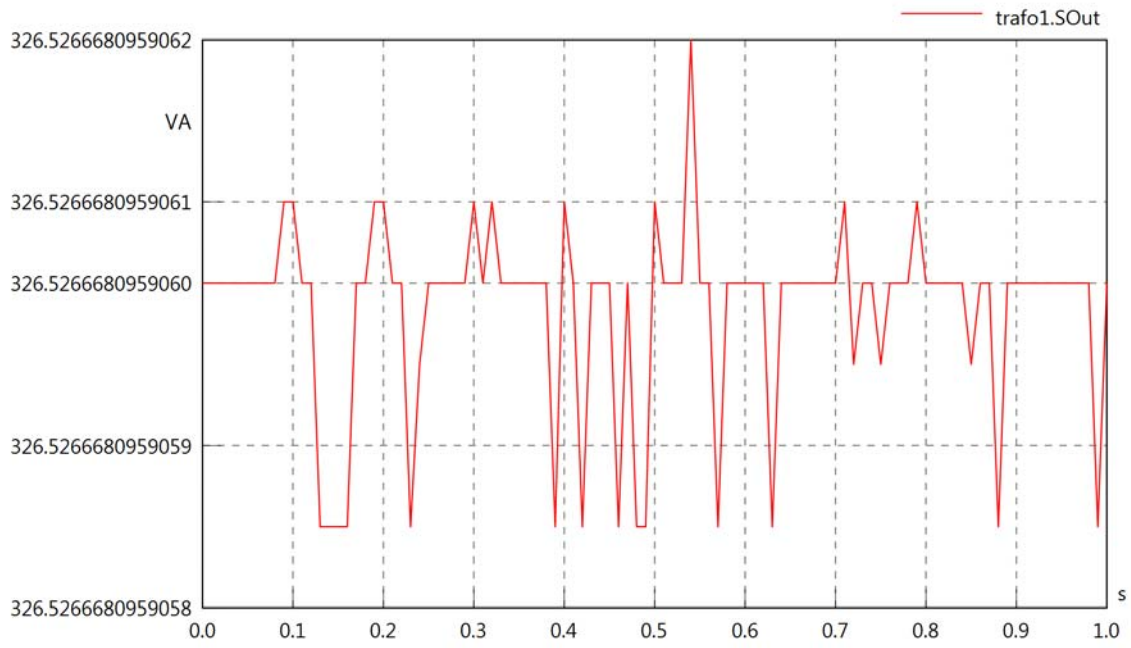

trafo1.pfOut

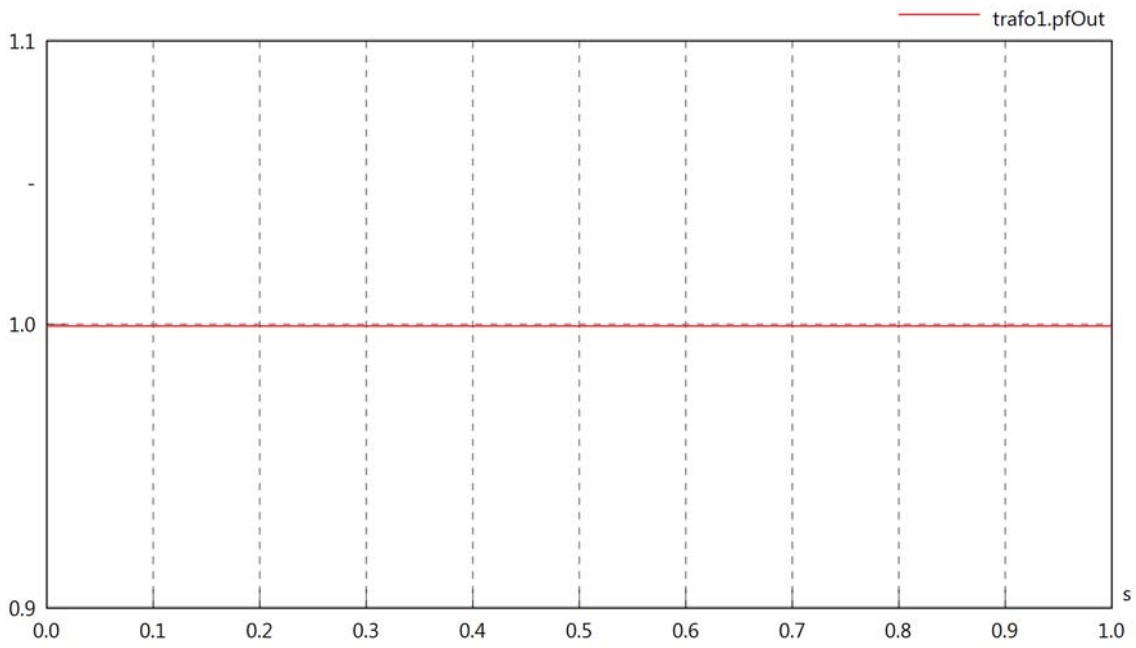
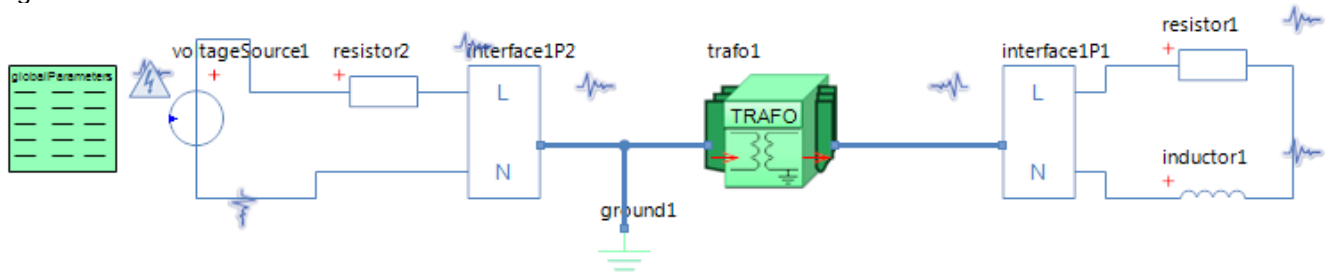

Diagram View



GlobalParameters globalParameters
Parameters

Comment	Name	Current Value	Unit
Type of Calculation	eCalculationKind	Signal Calculation	
Description of Frequency	eFrequencyKind	Linear	
Minimum Frequency	fMin	4000	[Hz]
Maximum Frequency	fMax	4000	[Hz]

Transformer trafo1
Parameters

Comment	Name	Current Value	Unit
Transformer Type	kind	Lossy Transformer	
Primary Winding Resistance	R1	5	[Ohm]
Primary Inductance	L1	40	[mH]
Initial Value	i10	0 (Fixed)	[A]
Secondary Winding Resistance	R2	5	[Ohm]
Secondary Inductance	L2	80	[mH]
Initial Value	i20	0 (Fixed)	[A]
Iron Loss Resistance	Rfe	50	[kOhm]
Mutual Coupling Inductance	M	$0.75 * \sqrt{L1 * L2}$	[H]

Voltage Source voltageSource1
Parameters

Comment	Name	Current Value	Unit
Voltage RMS	VrmsSrc	230	[V]
Phase	phi	0	[deg]

Resistor resistor1
Parameters

Comment	Name	Current Value	Unit
Resistance	R	50	[Ohm]

Inductor inductor1
Parameters

Comment	Name	Current Value	Unit
Inductance	L	5	[mH]

Resistor resistor2
Parameters

Comment	Name	Current Value	Unit
Resistance	R	10	[Ohm]

trafo1.n

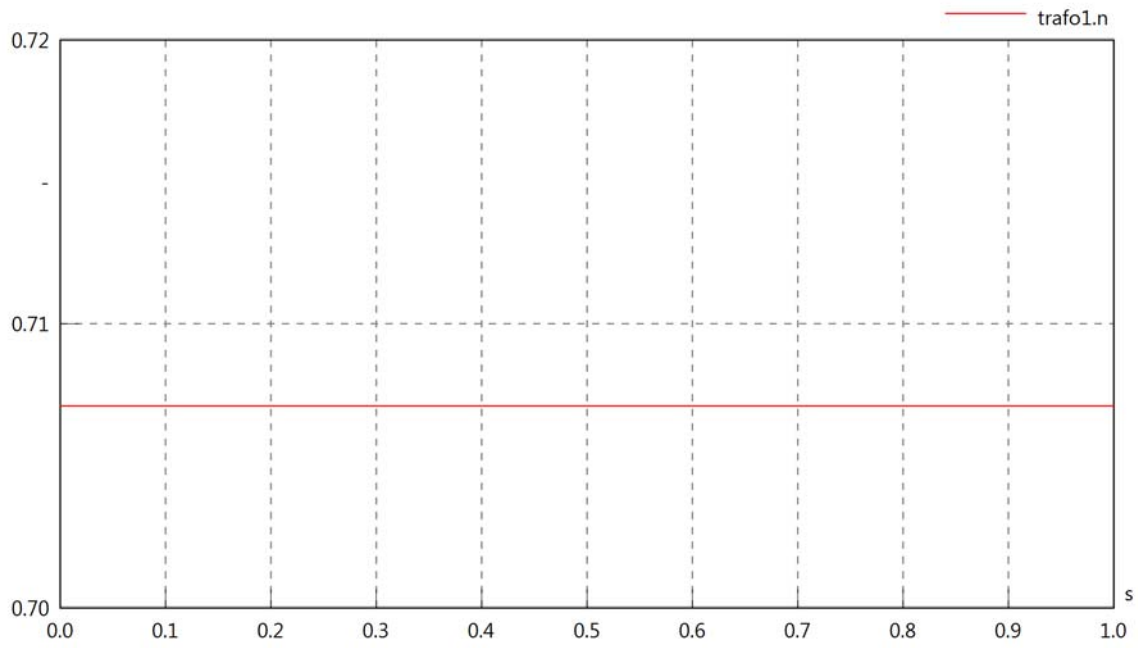

trafo1.k

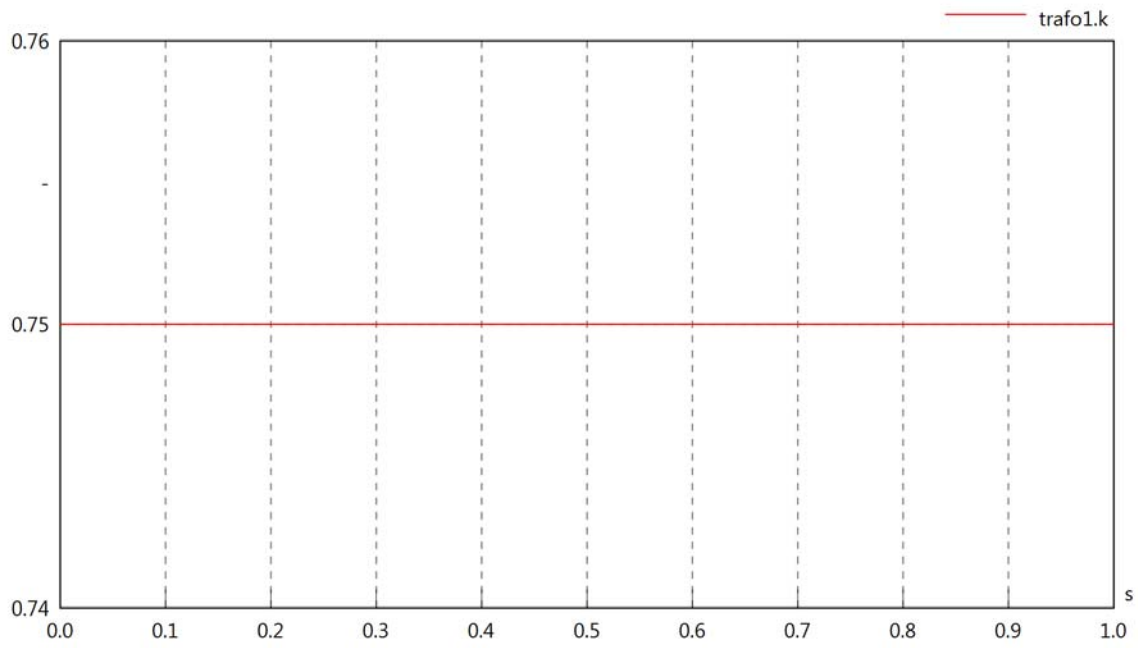

trafo1.VrmsIn

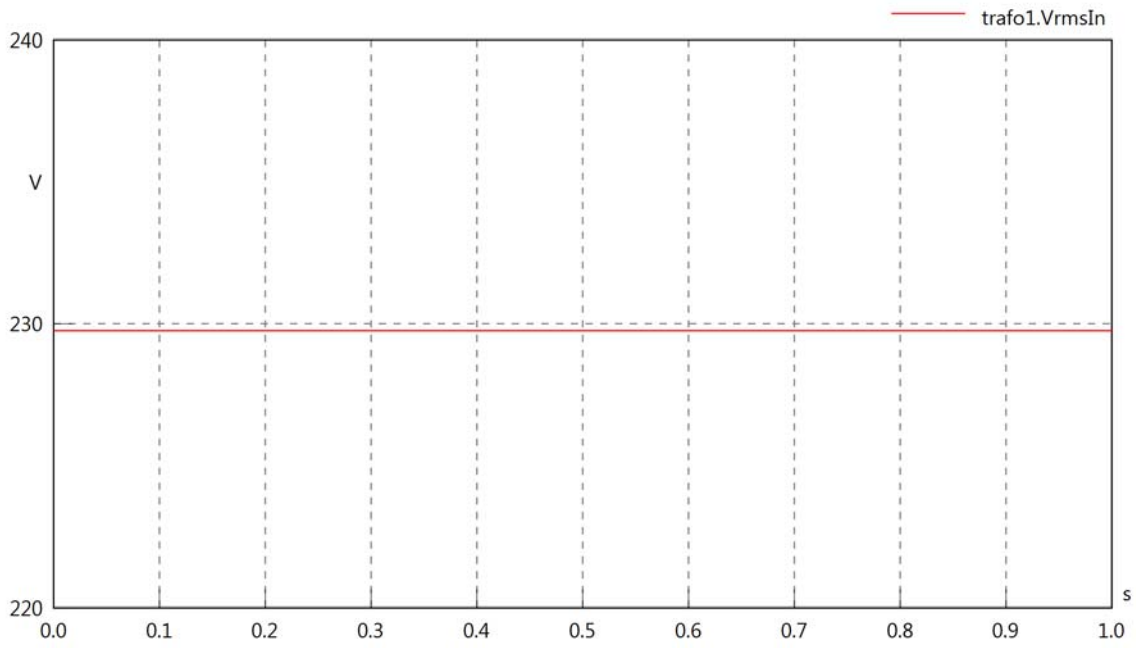

trafo1.vReIn

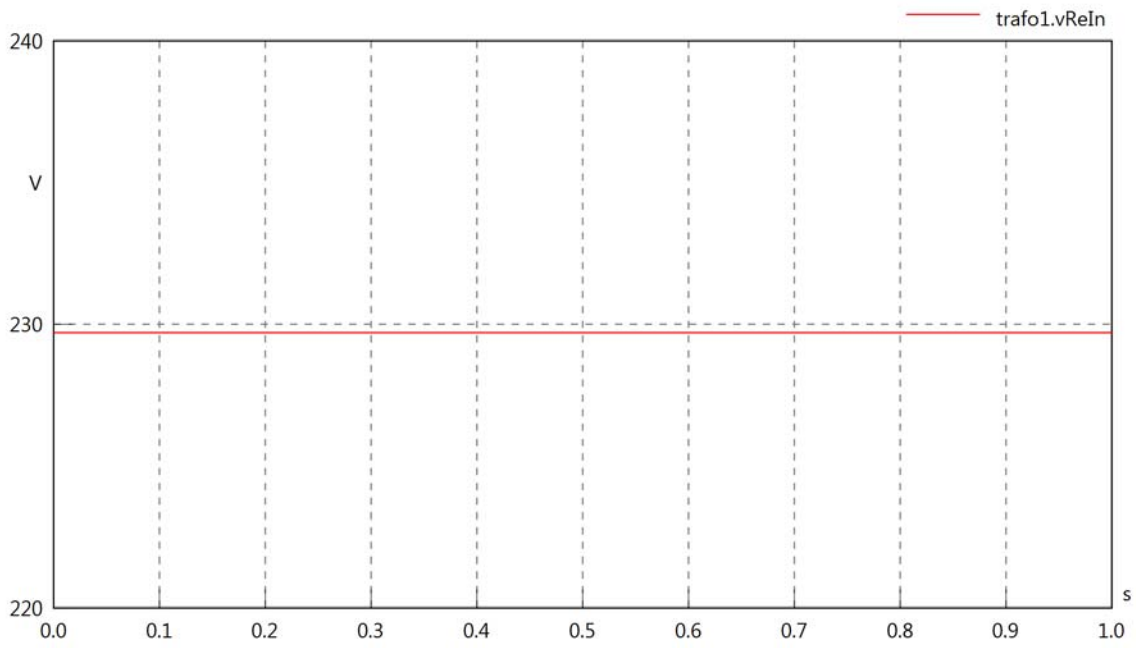

trafo1.vImIn

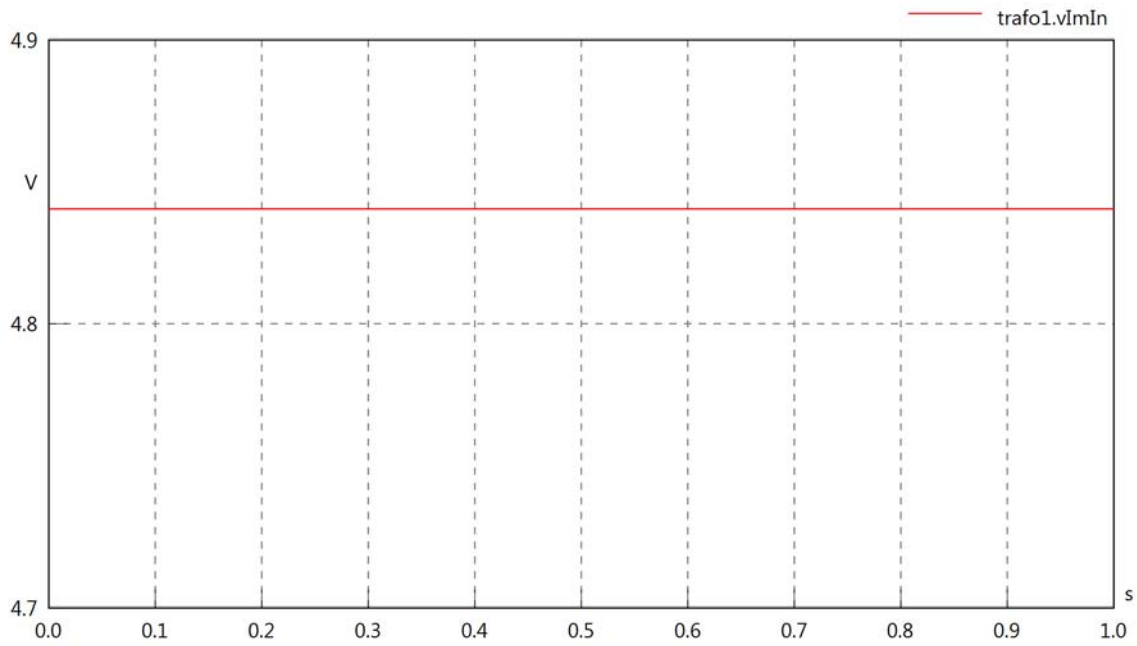

trafo1.IrmsIn

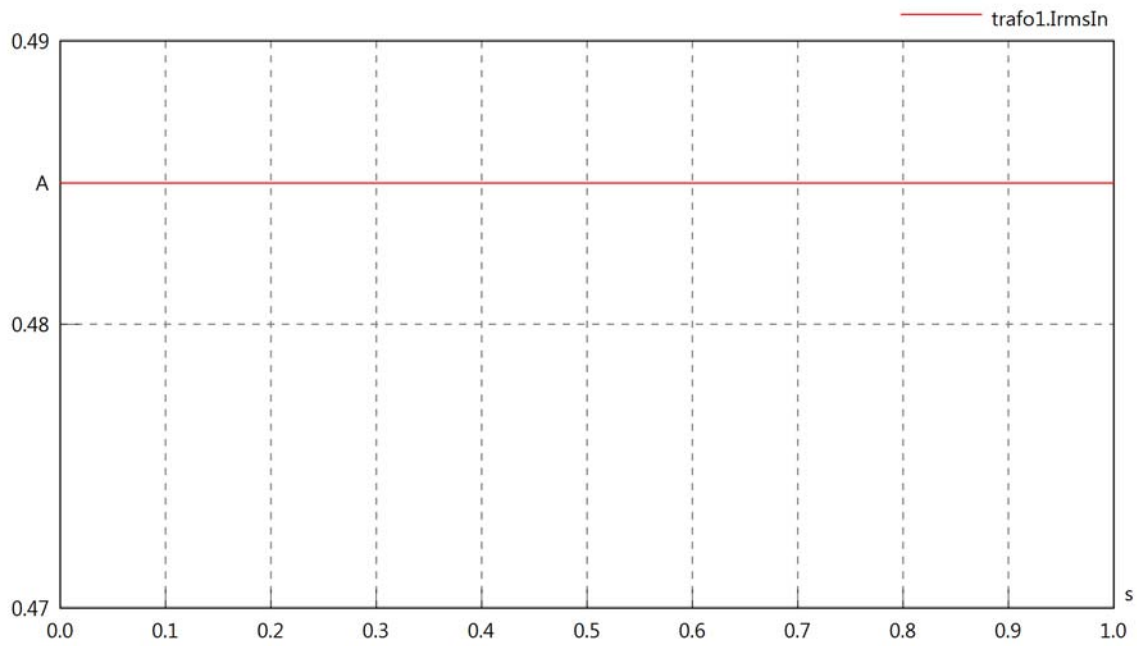

trafo1.iReIn

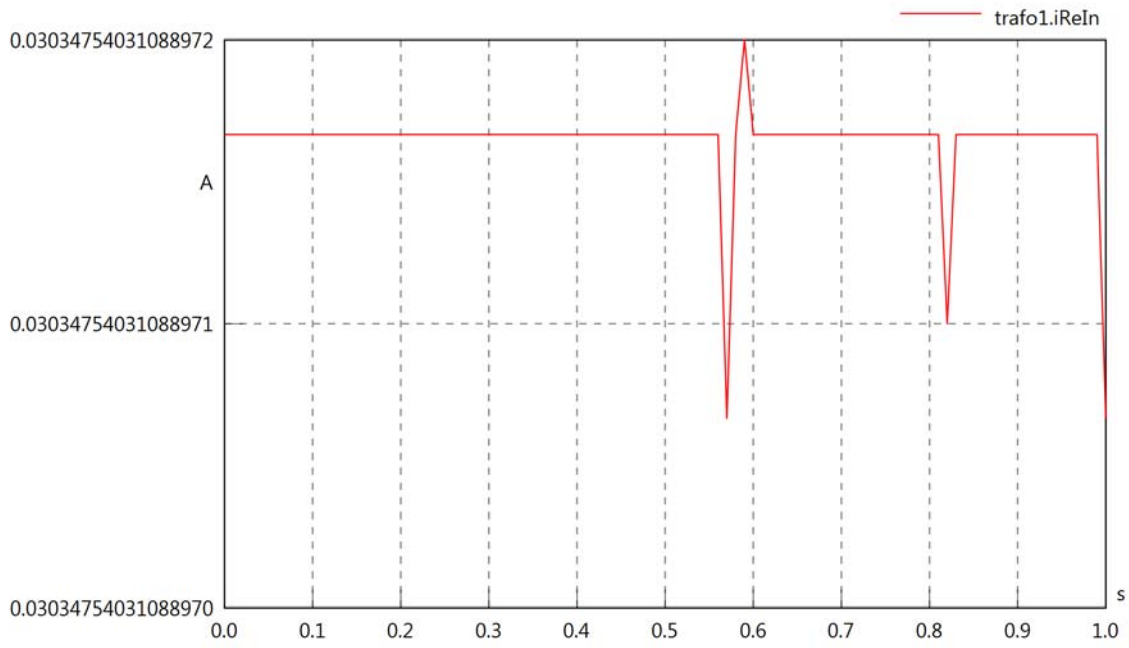

trafo1.iImIn

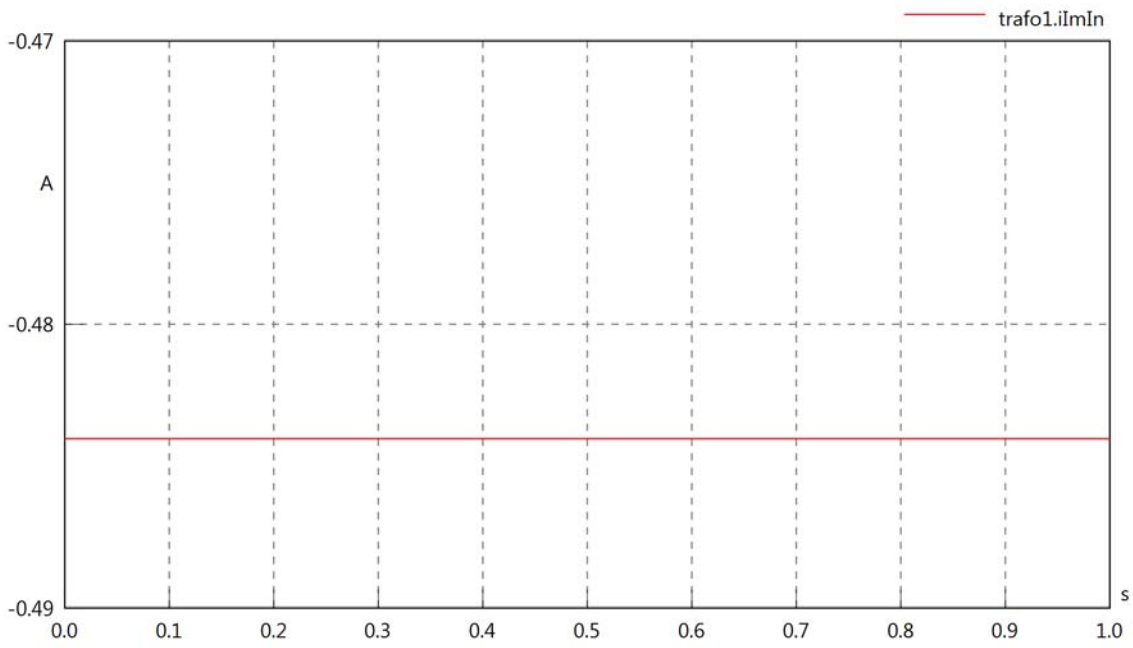

trafo1.phiVIn

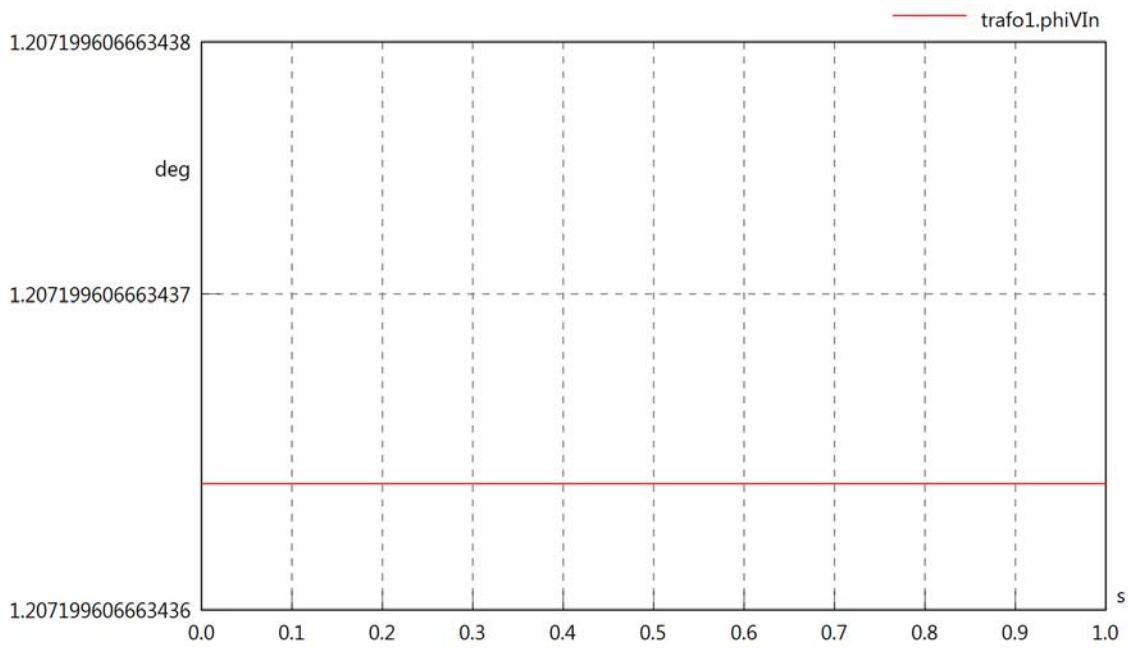

trafo1.phiIIIn

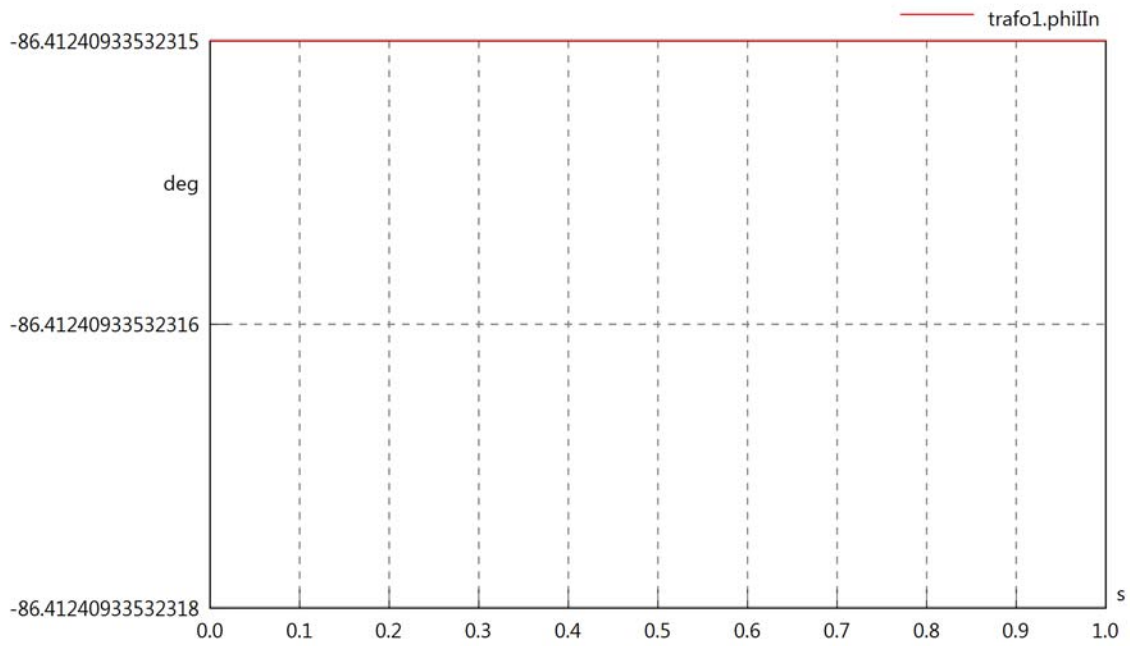

trafo1.phiIVIn

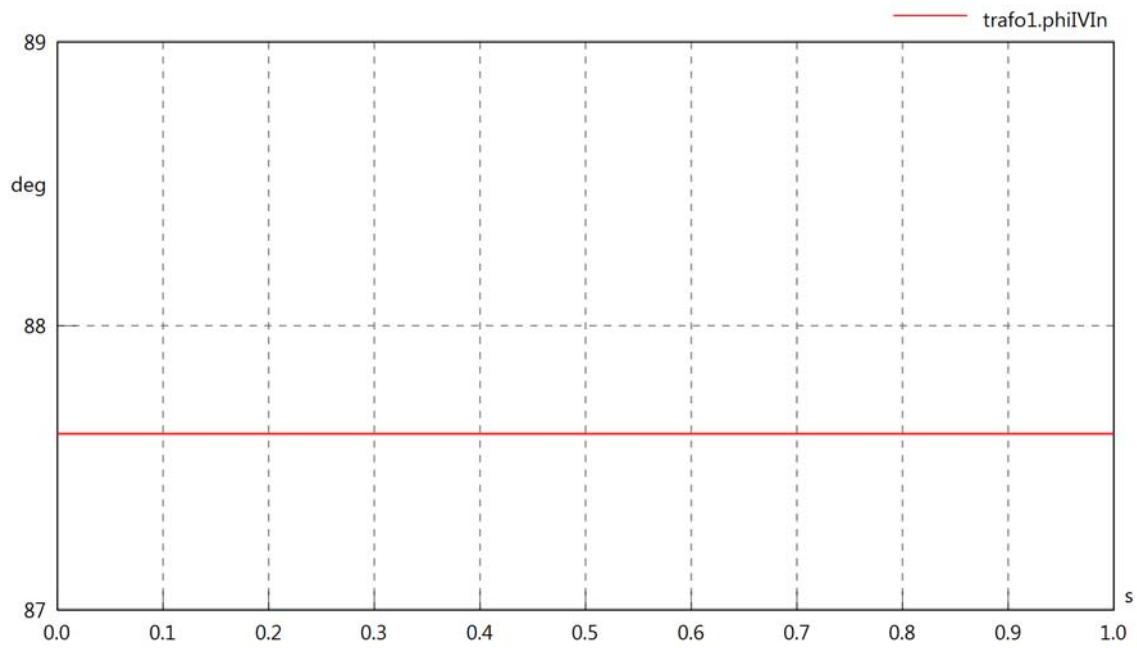

trafo1.PReIn

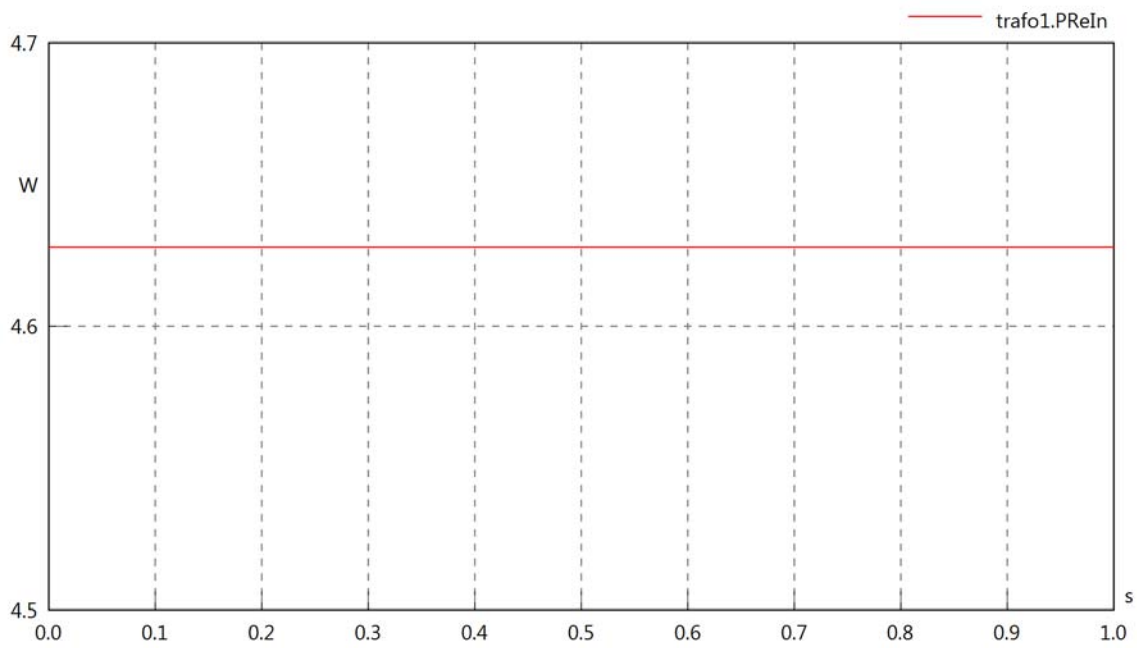

trafo1.PImIn

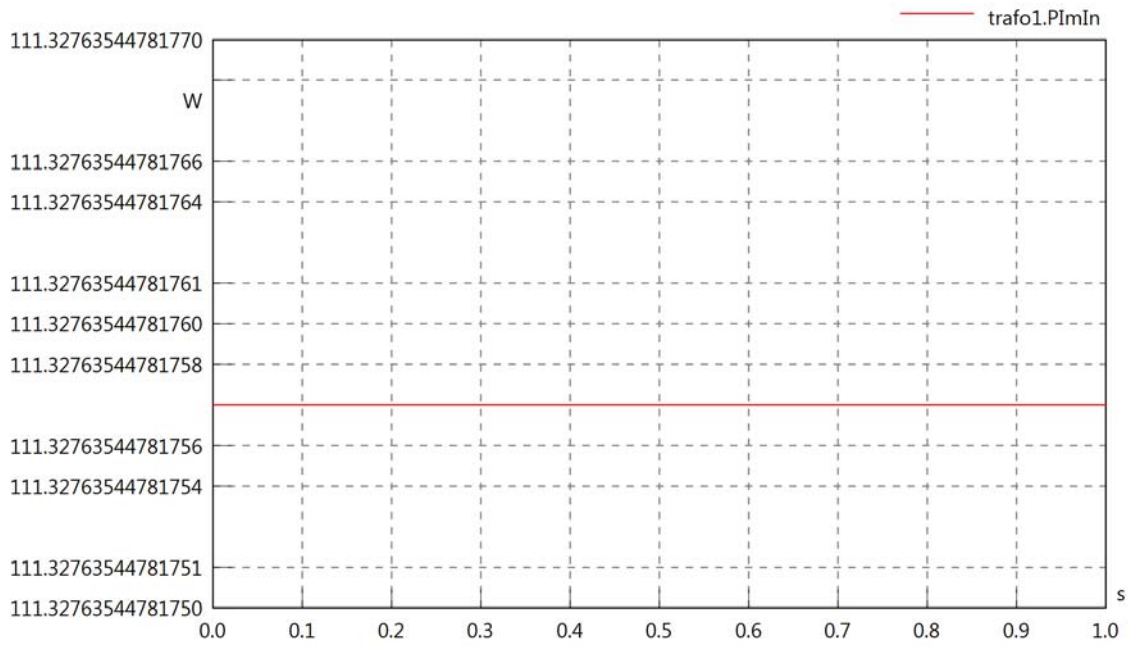

trafo1.SIn

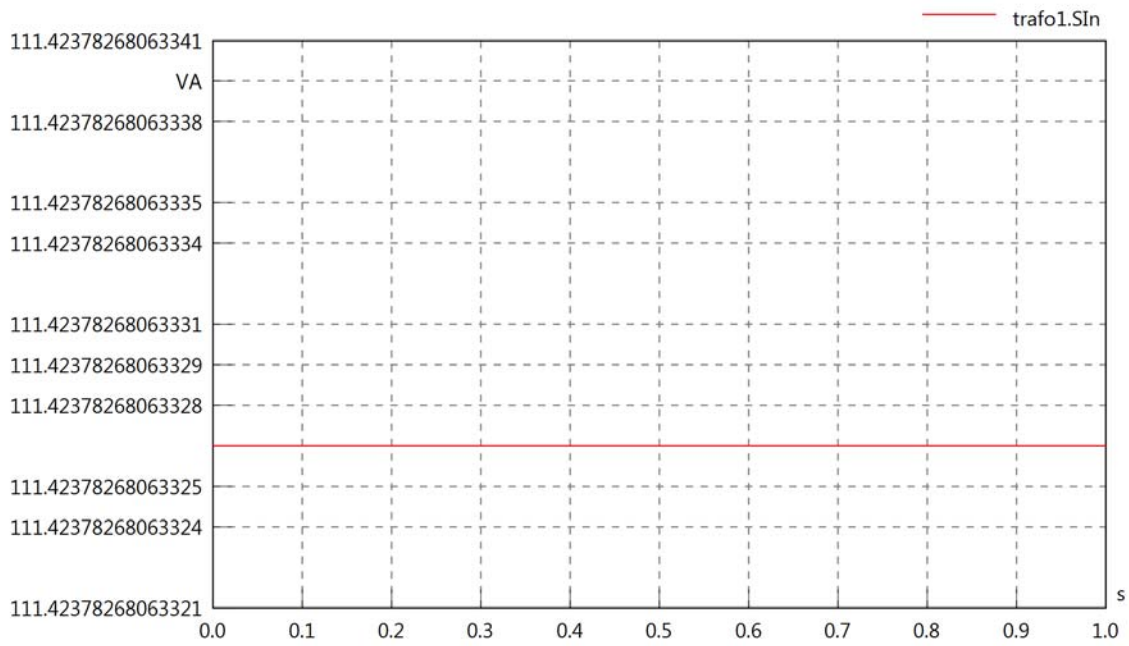

trafo1.pfIn

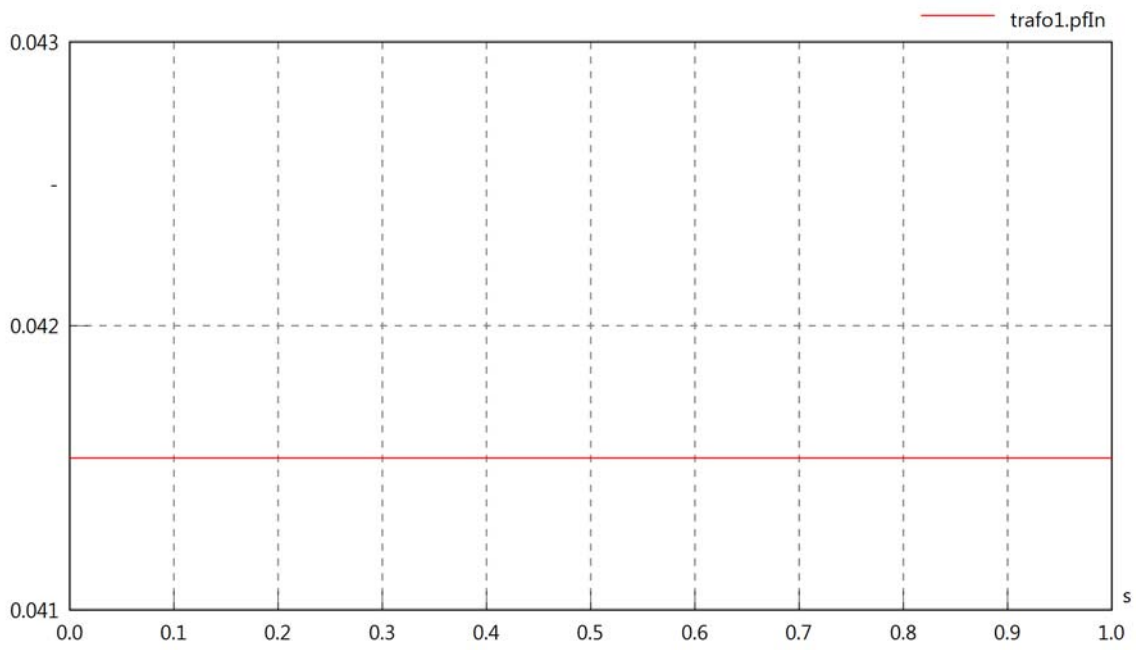

trafo1.VrmsOut

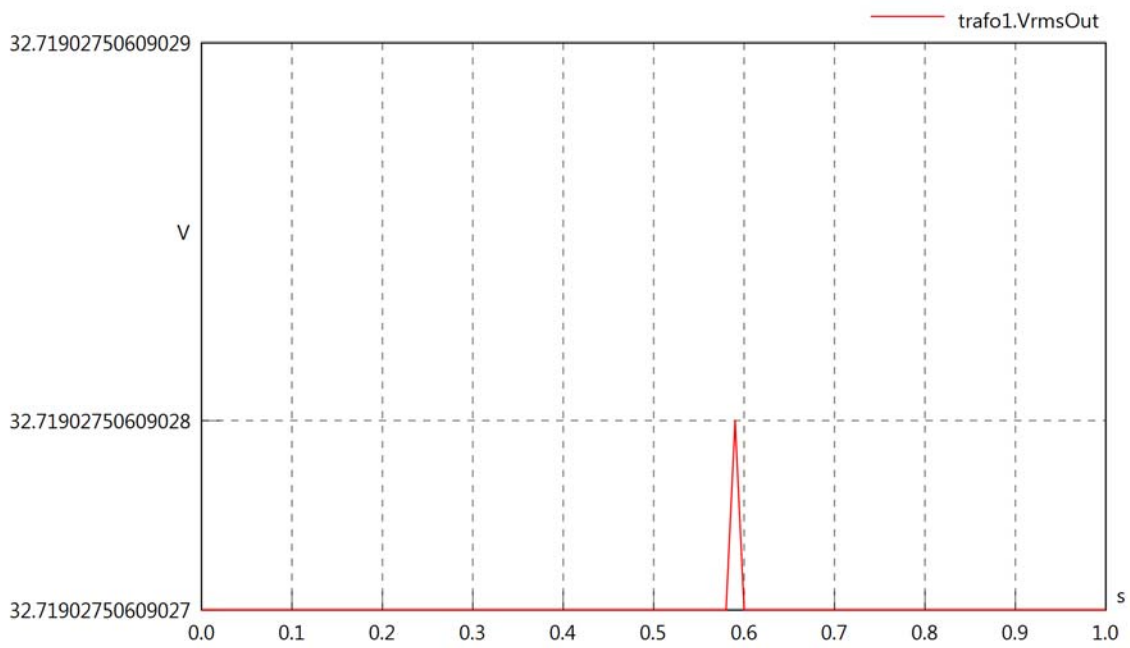

trafo1.vReOut

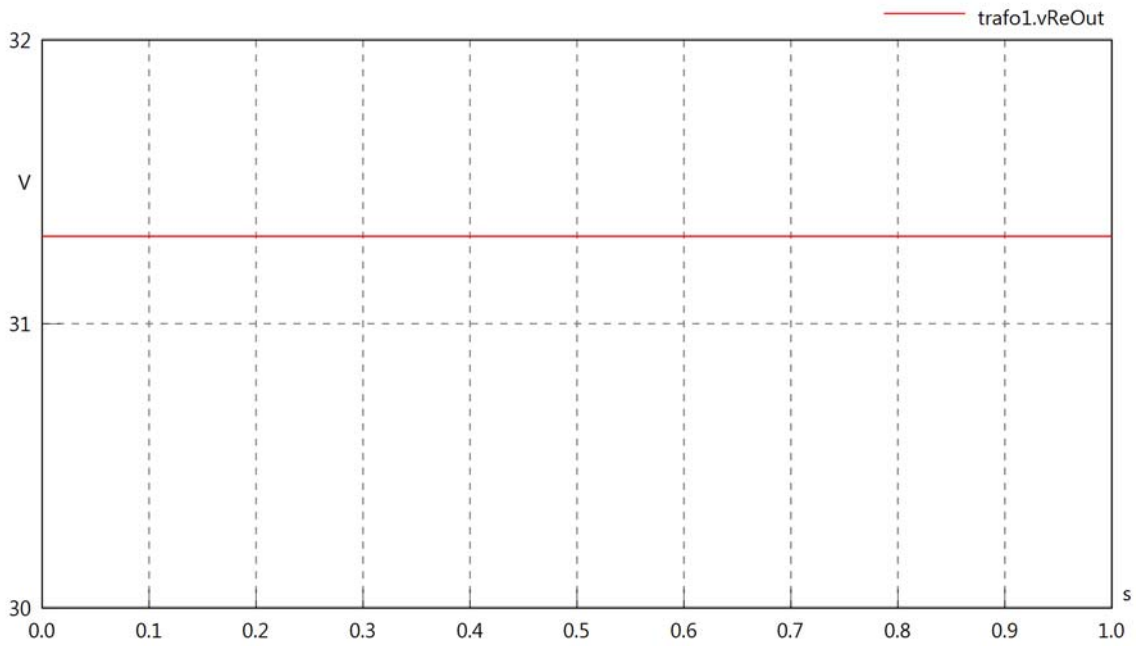

trafo1.vImOut

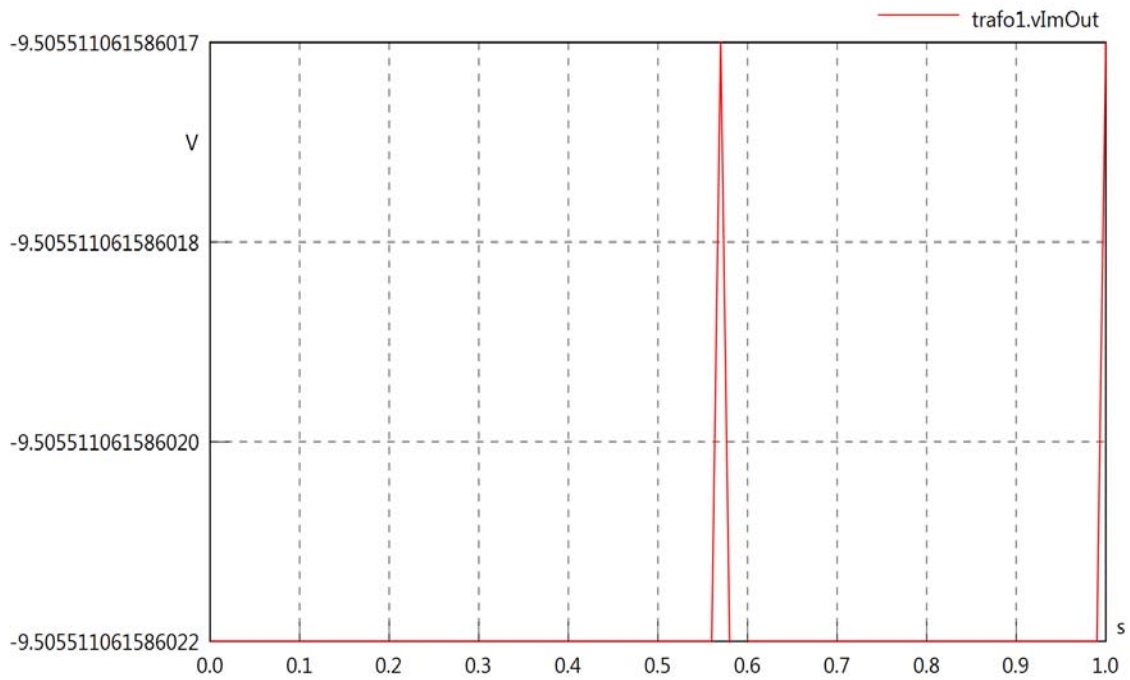

trafo1.IrmsOut

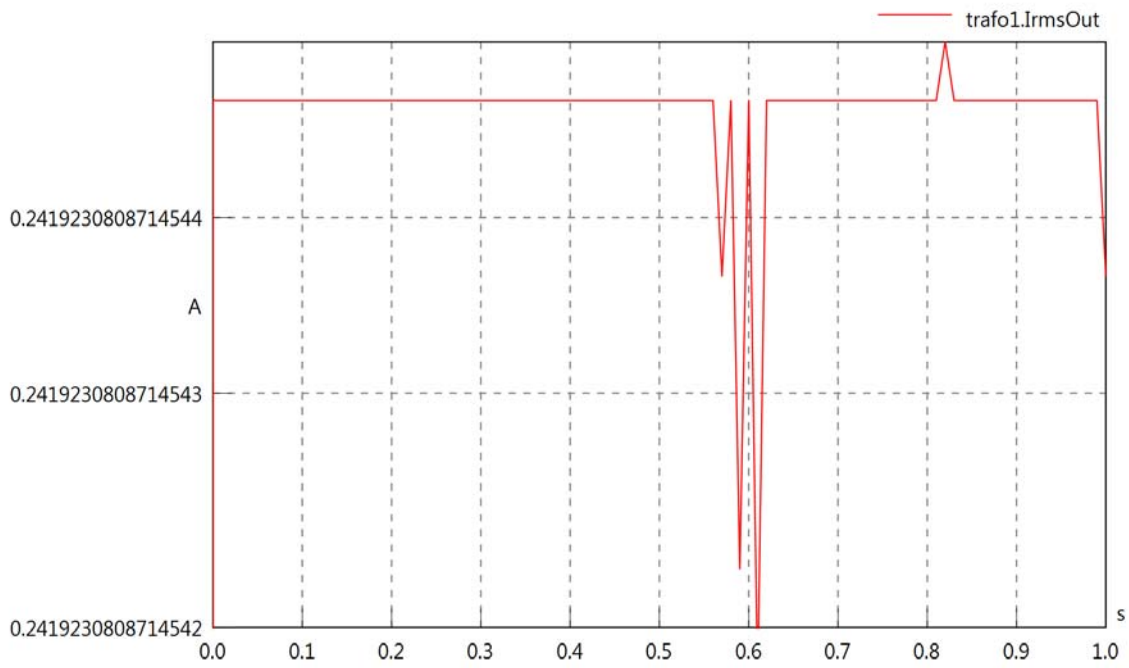

trafo1.iReOut

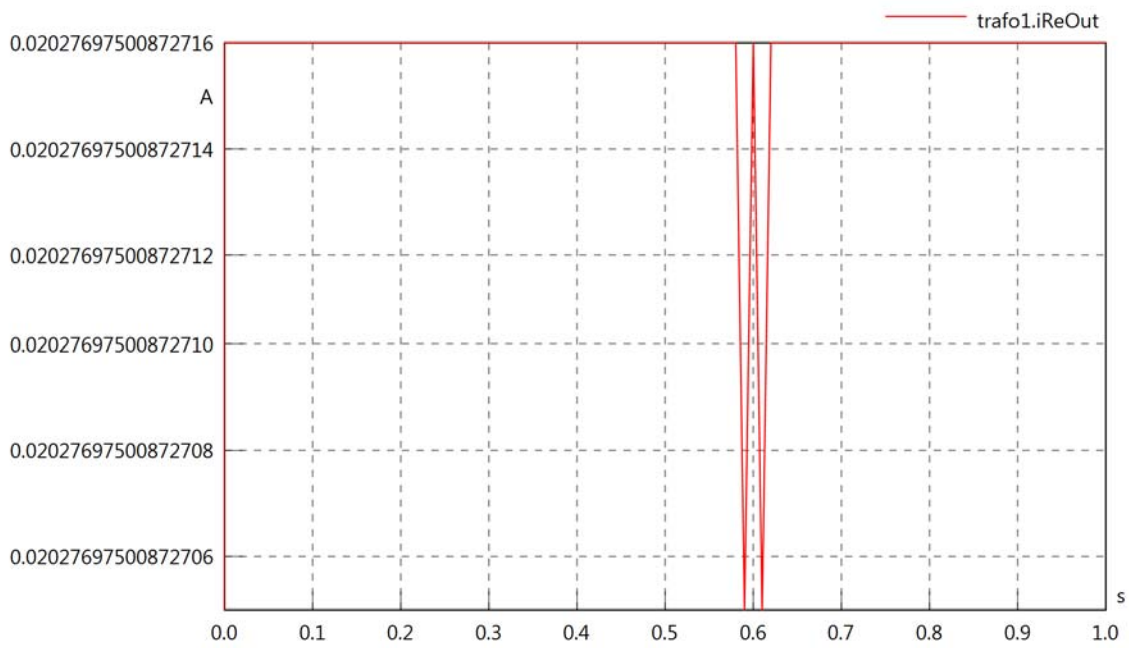

trafo1.iImOut

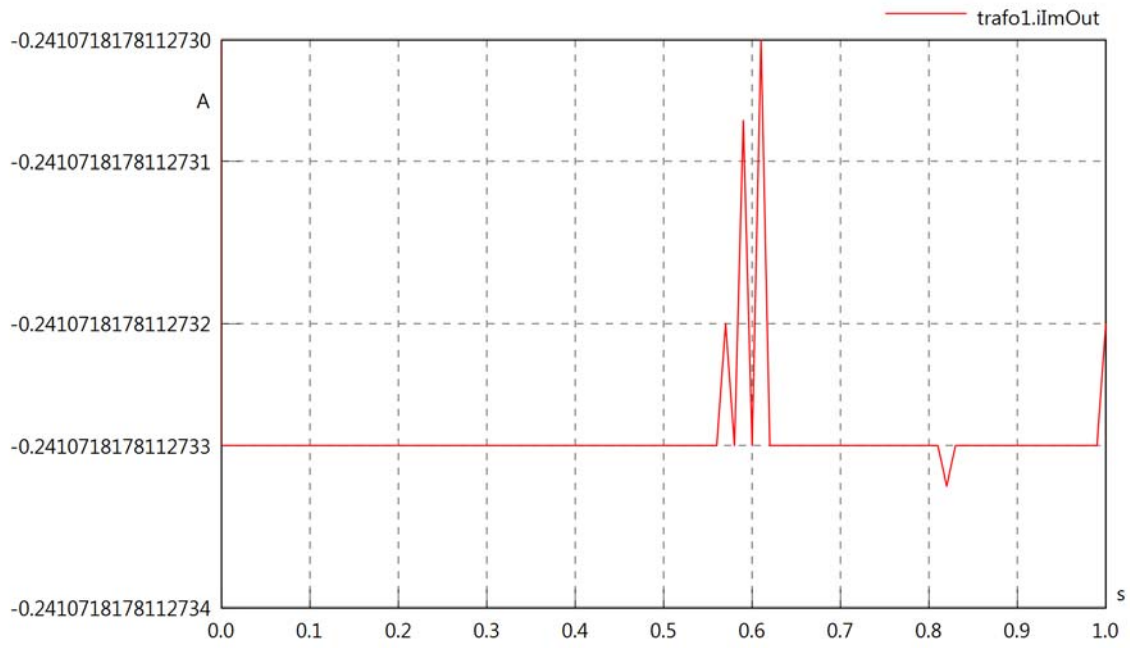

trafo1.phiVOut

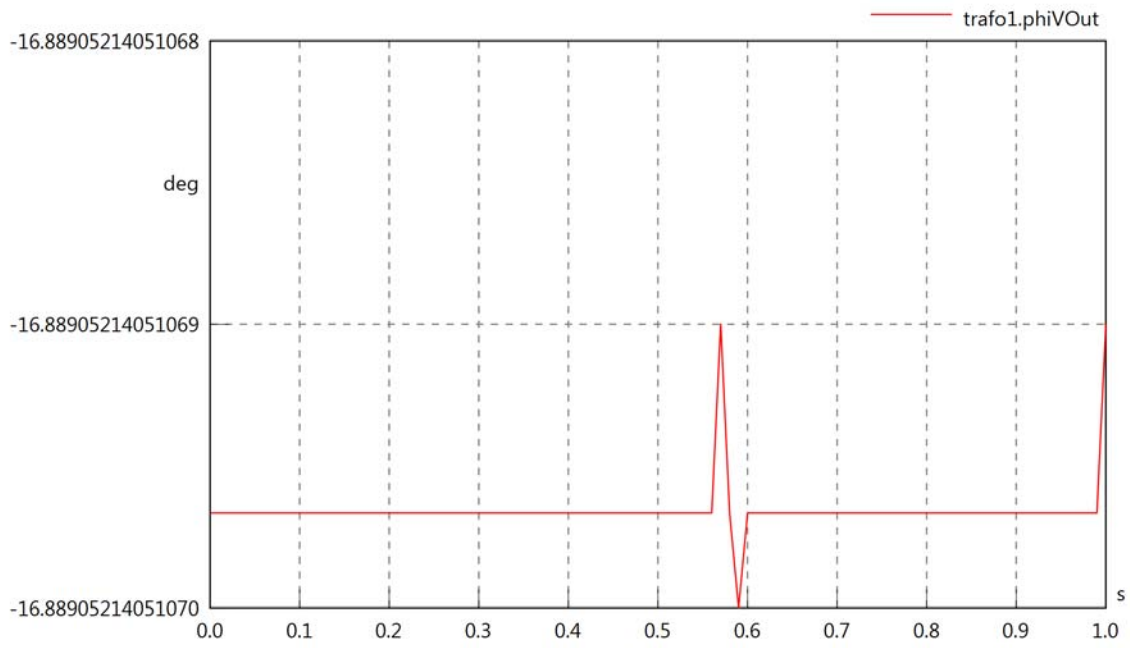

trafo1.phiIOut

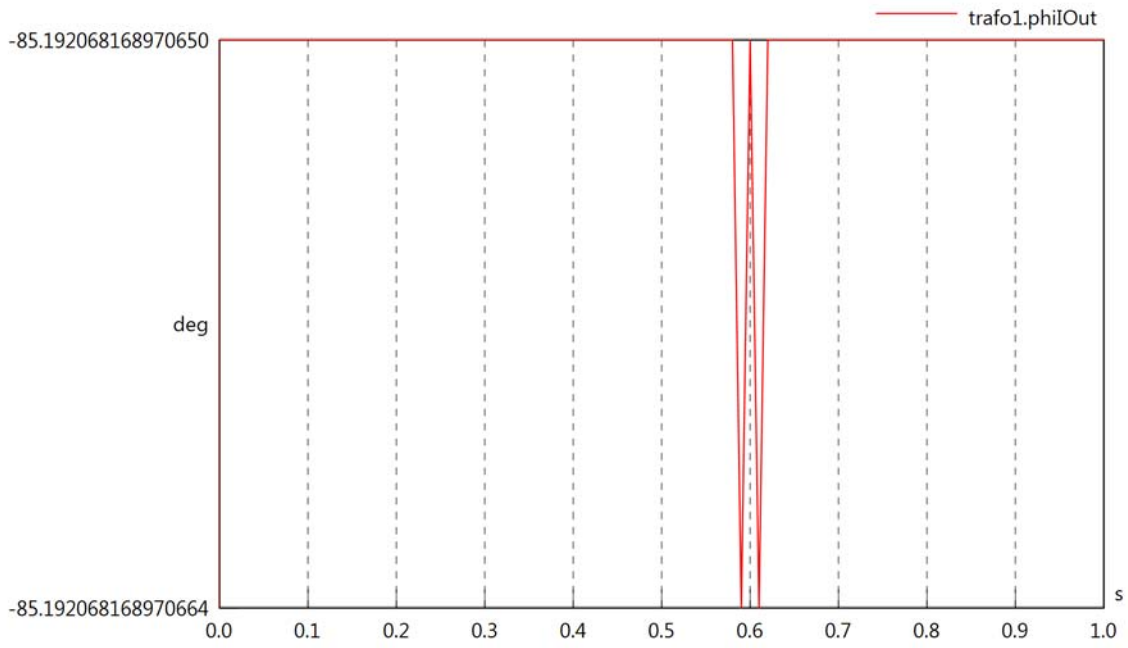

trafo1.phiIVOut

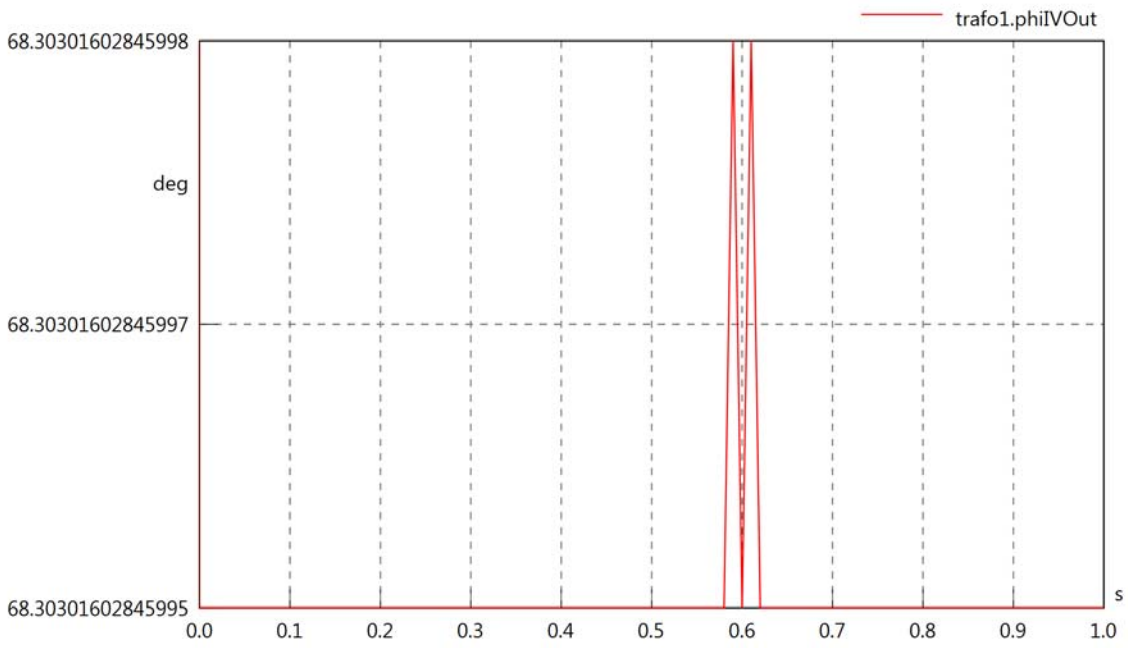

trafo1.PReOut

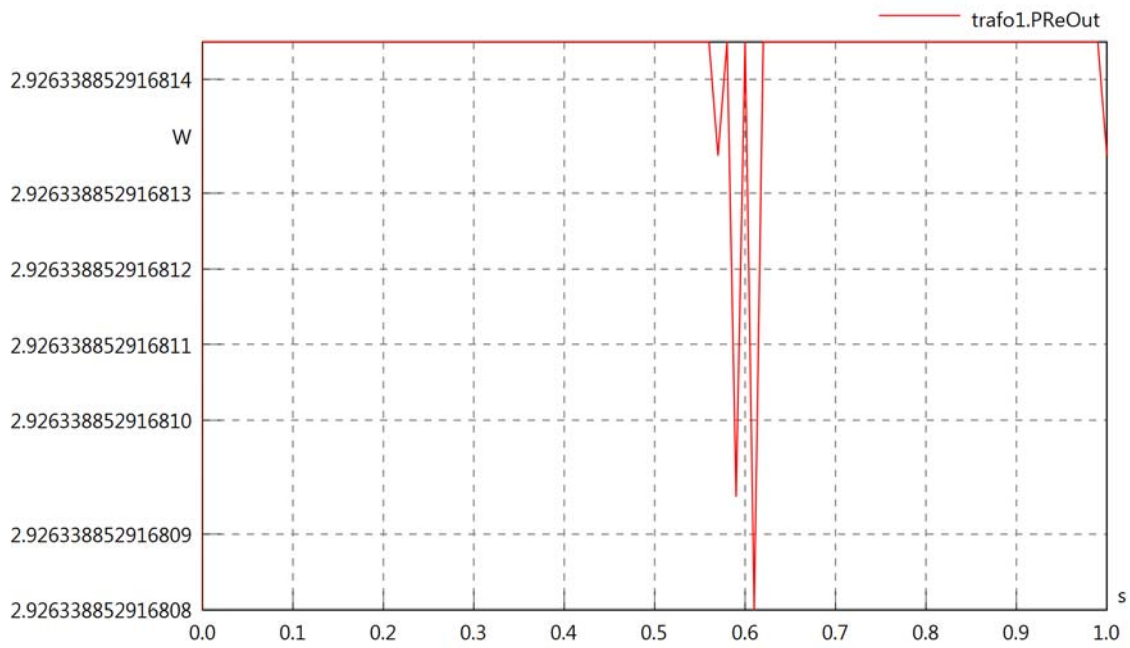

trafo1.PImOut

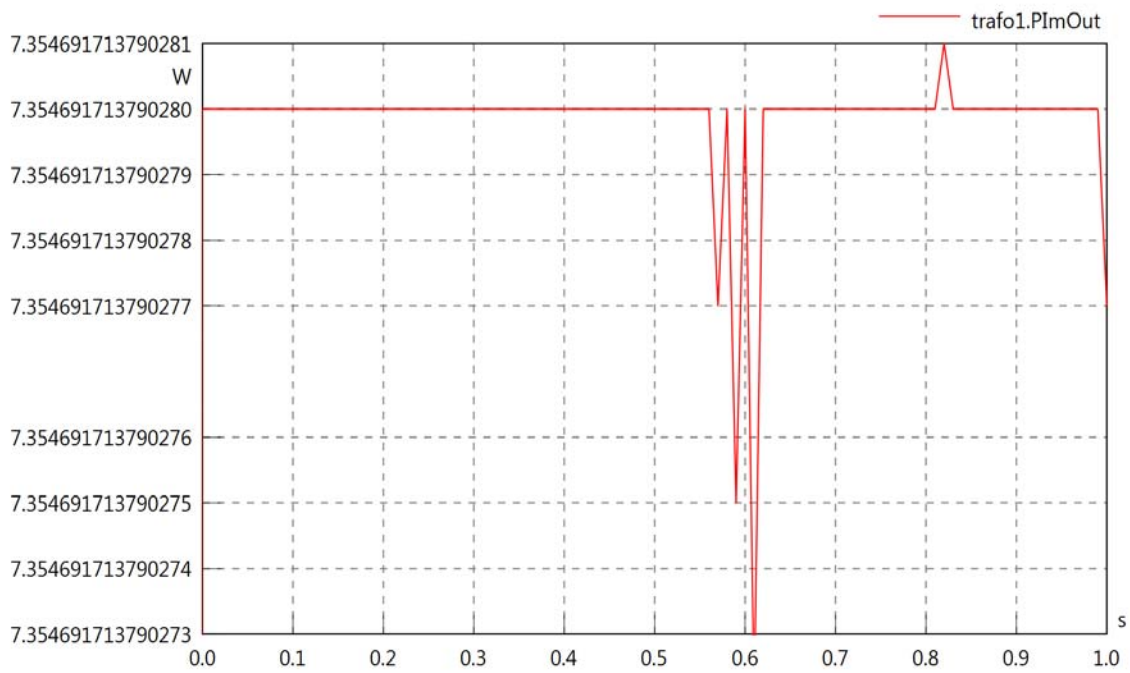

trafo1.SOut

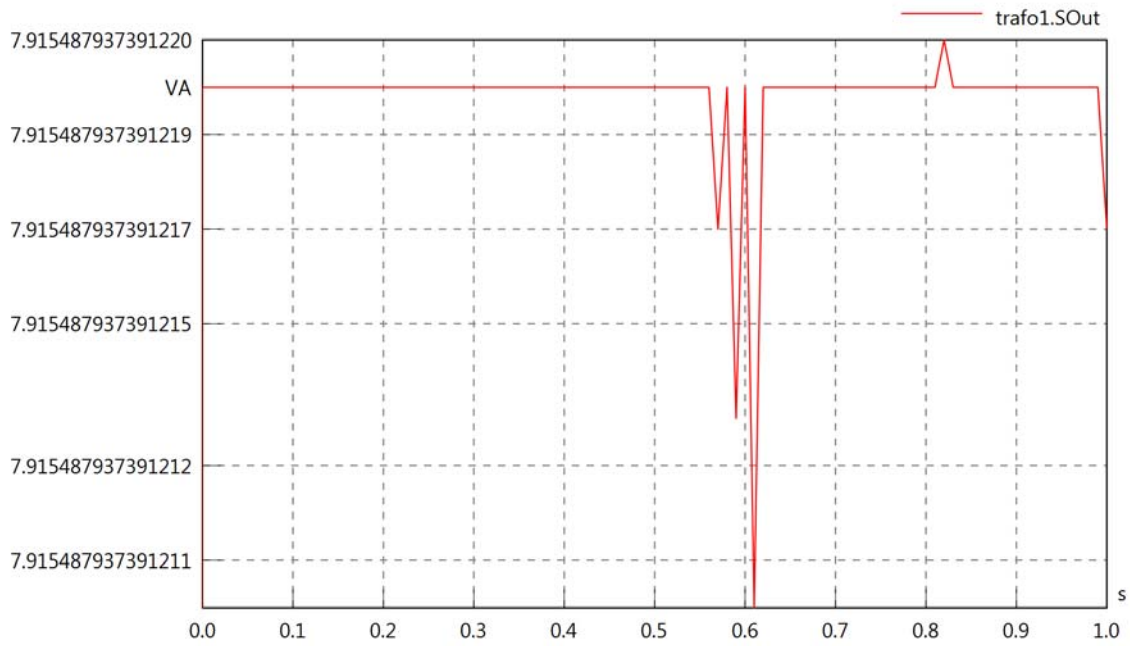

trafo1.pfOut

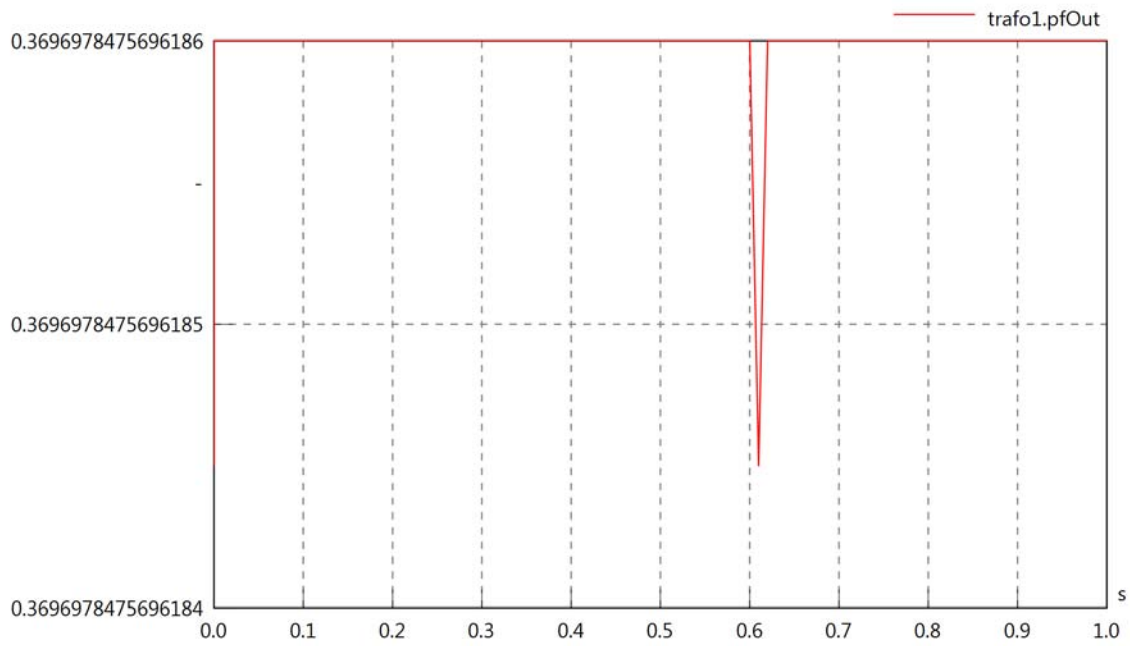
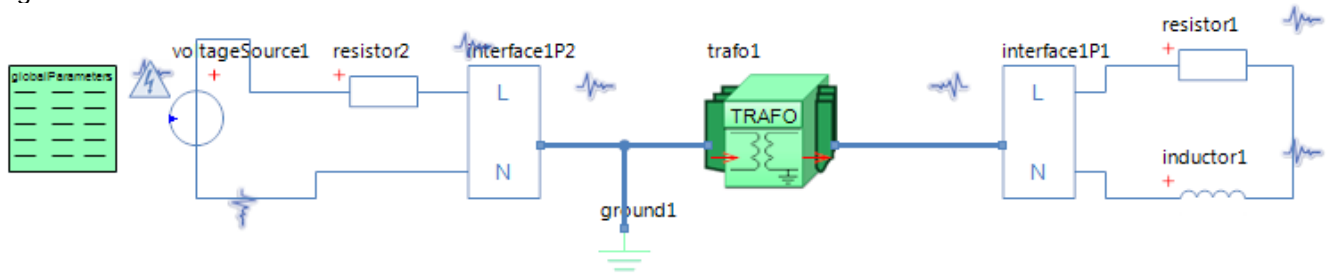

Diagram View



GlobalParameters globalParameters
Parameters

Comment	Name	Current Value	Unit
Type of Calculation	eCalculationKind	Signal Calculation	
Description of Frequency	eFrequencyKind	Linear	
Minimum Frequency	fMin	100	[kHz]
Maximum Frequency	fMax	100	[kHz]

Transformer trafo1
Parameters

Comment	Name	Current Value	Unit
Transformer Type	kind	Lossy Transformer	
Primary Winding Resistance	R1	5	[Ohm]
Primary Inductance	L1	40	[mH]
Initial Value	i10	0 (Fixed)	[A]
Secondary Winding Resistance	R2	5	[Ohm]
Secondary Inductance	L2	80	[mH]
Initial Value	i20	0 (Fixed)	[A]
Iron Loss Resistance	Rfe	50	[kOhm]
Mutual Coupling Inductance	M	$0.75 * \sqrt{L1 * L2}$	[H]

Voltage Source voltageSource1
Parameters

Comment	Name	Current Value	Unit
Voltage RMS	VrmsSrc	230	[V]
Phase	phi	0	[deg]

Resistor resistor1
Parameters

Comment	Name	Current Value	Unit
Resistance	R	50	[Ohm]

Inductor inductor1
Parameters

Comment	Name	Current Value	Unit
Inductance	L	5	[mH]

Resistor resistor2
Parameters

Comment	Name	Current Value	Unit
Resistance	R	10	[Ohm]

trafo1.n

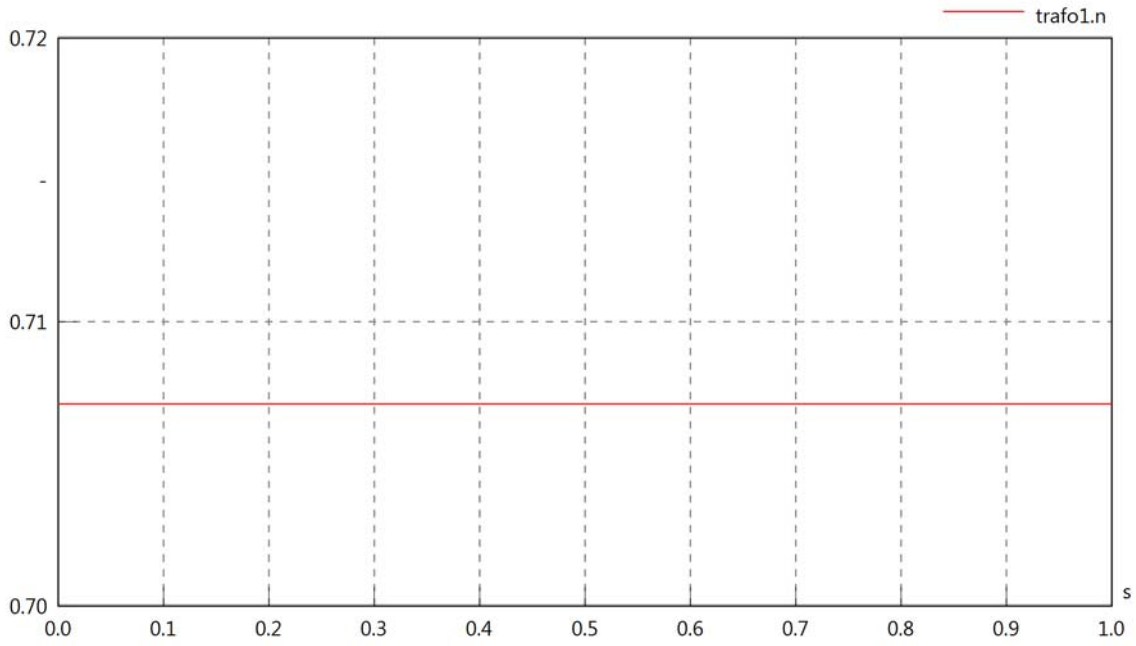

trafo1.k

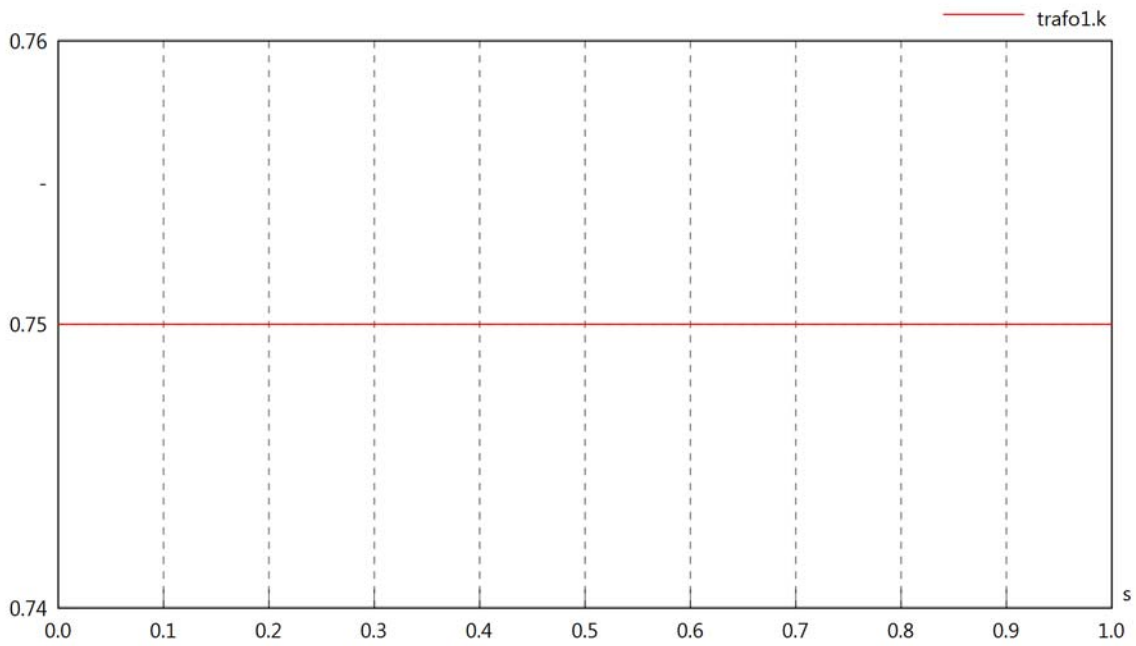

trafo1.VrmsIn

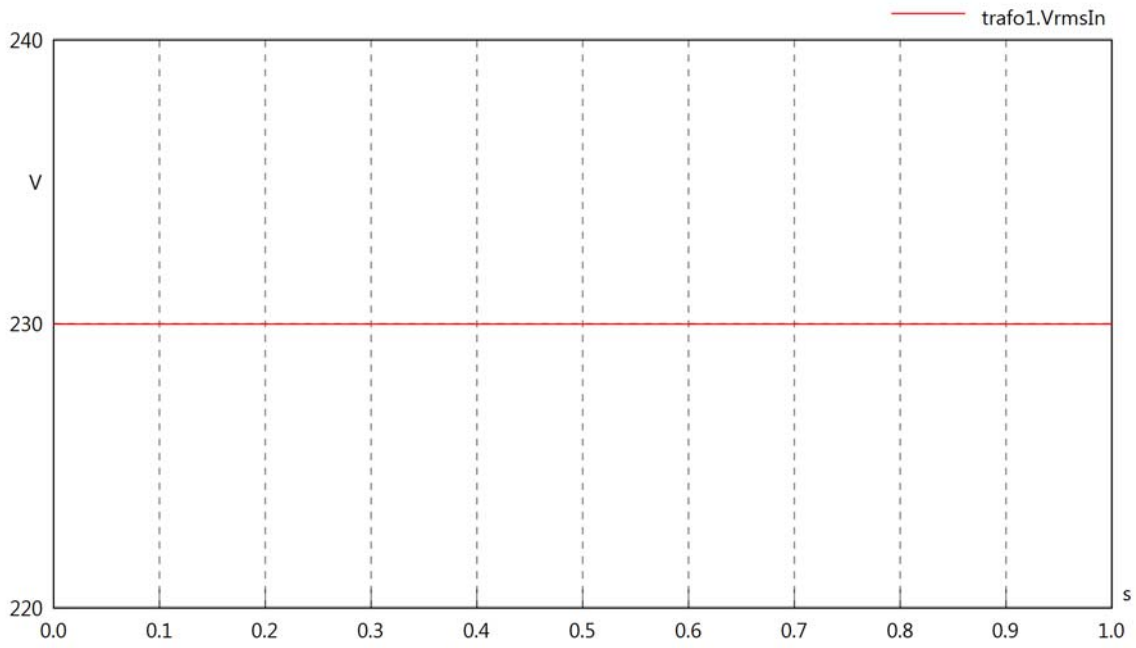

trafo1.vReIn

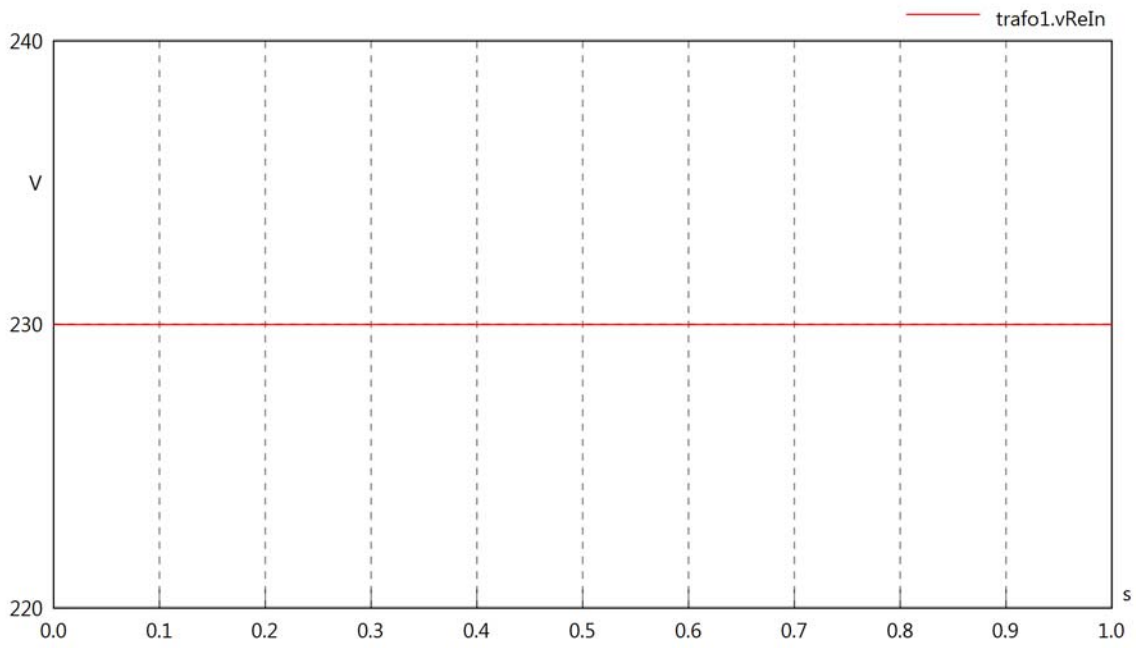

trafo1.vImIn

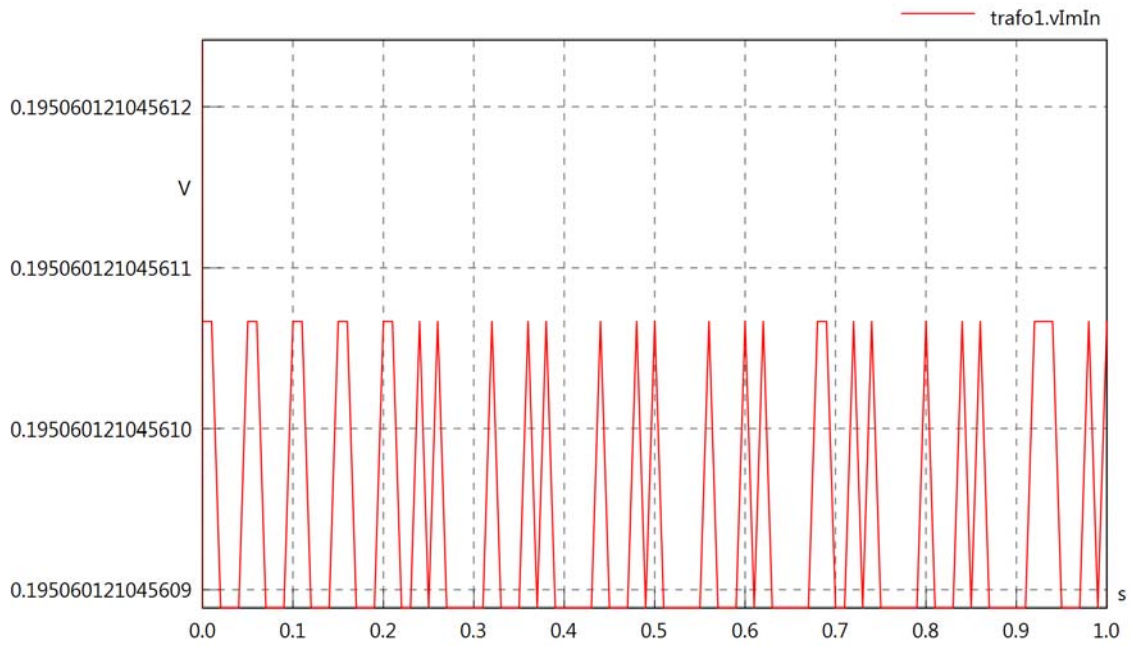

trafo1.IrmsIn

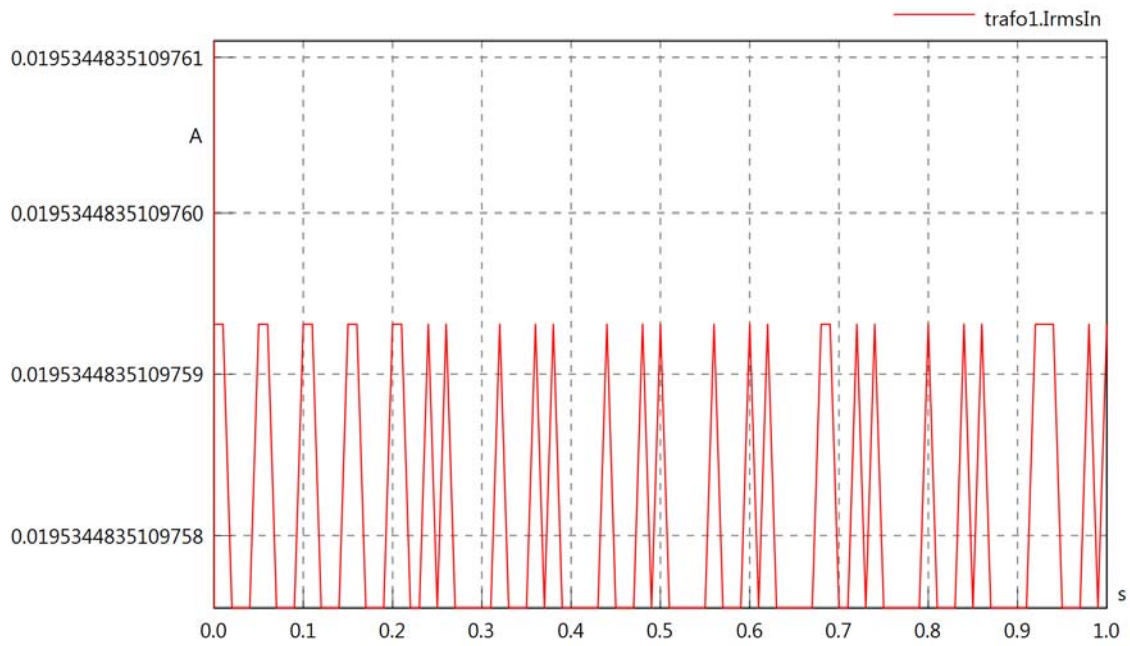

trafo1.iReIn

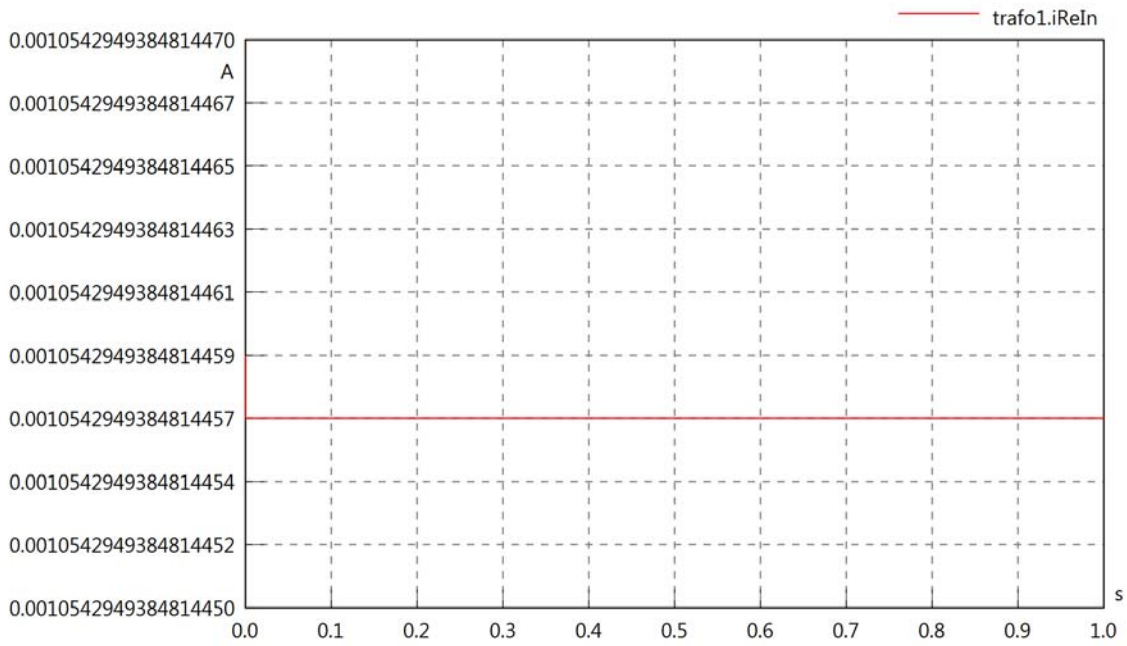

trafo1.iImIn

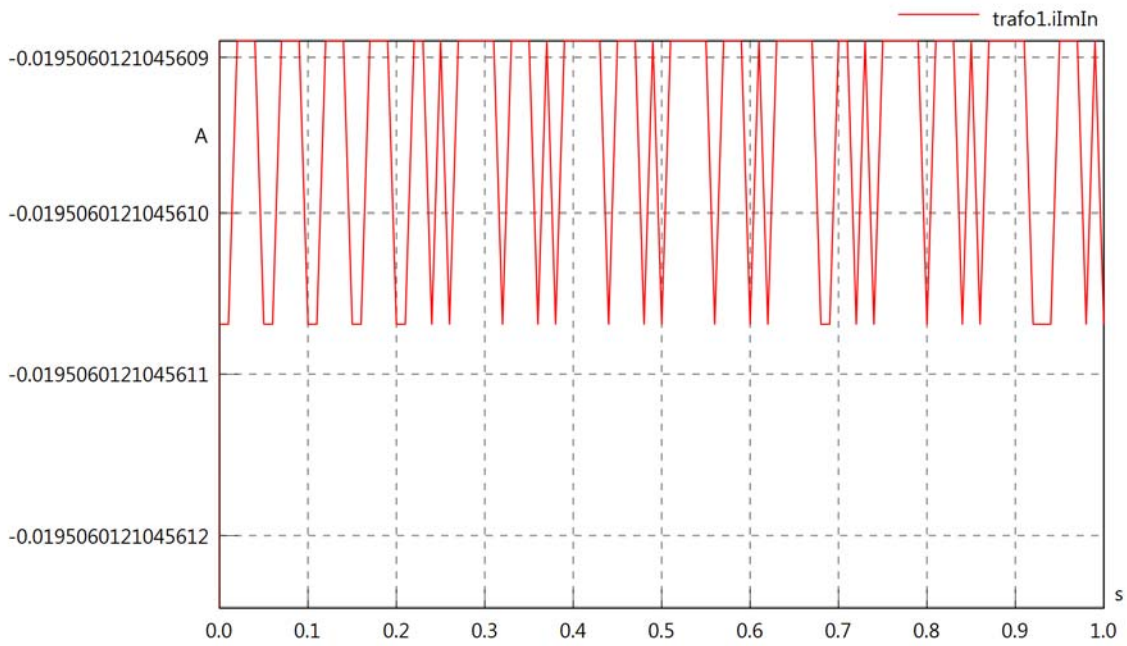

trafo1.phiVIn

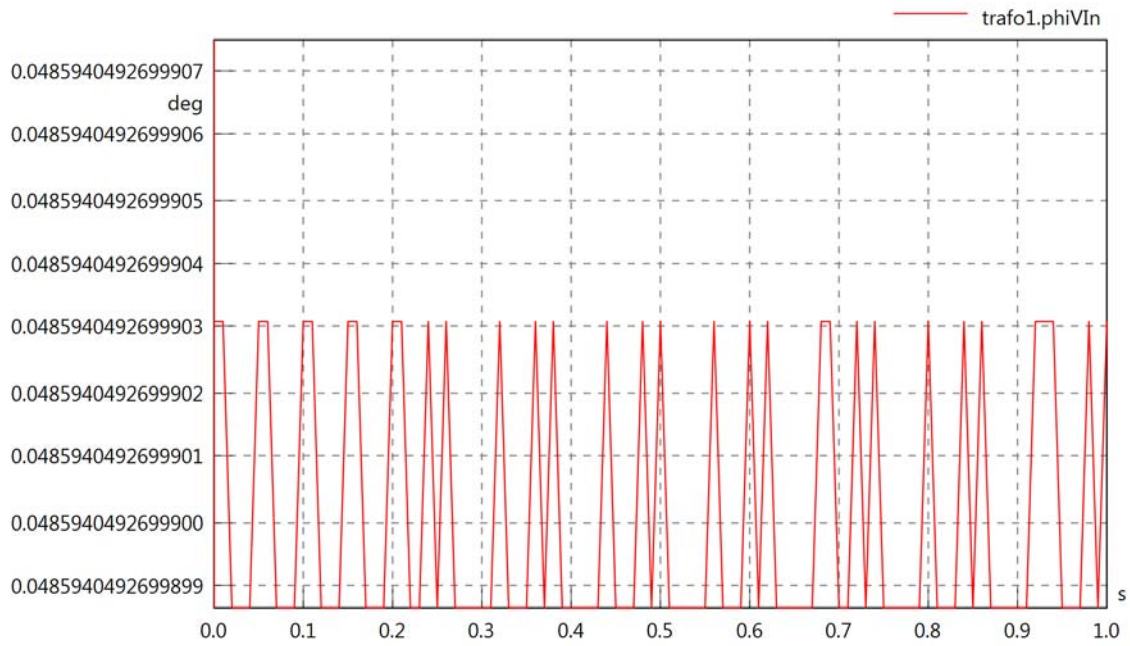

trafo1.phiIIIn

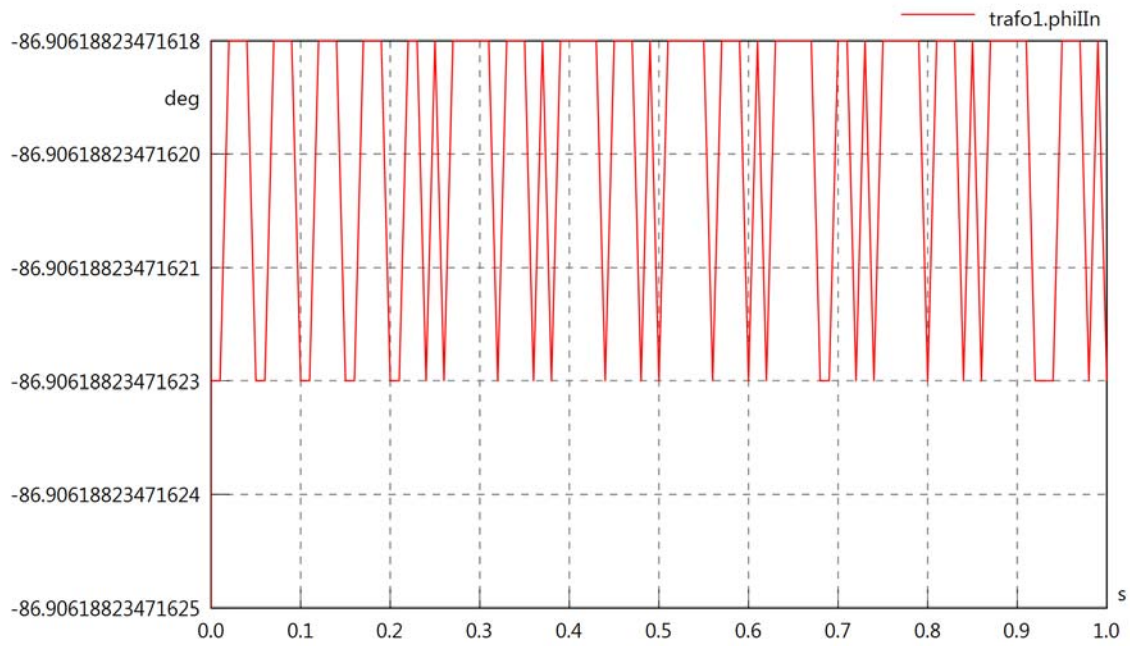

trafo1.phiIVIn

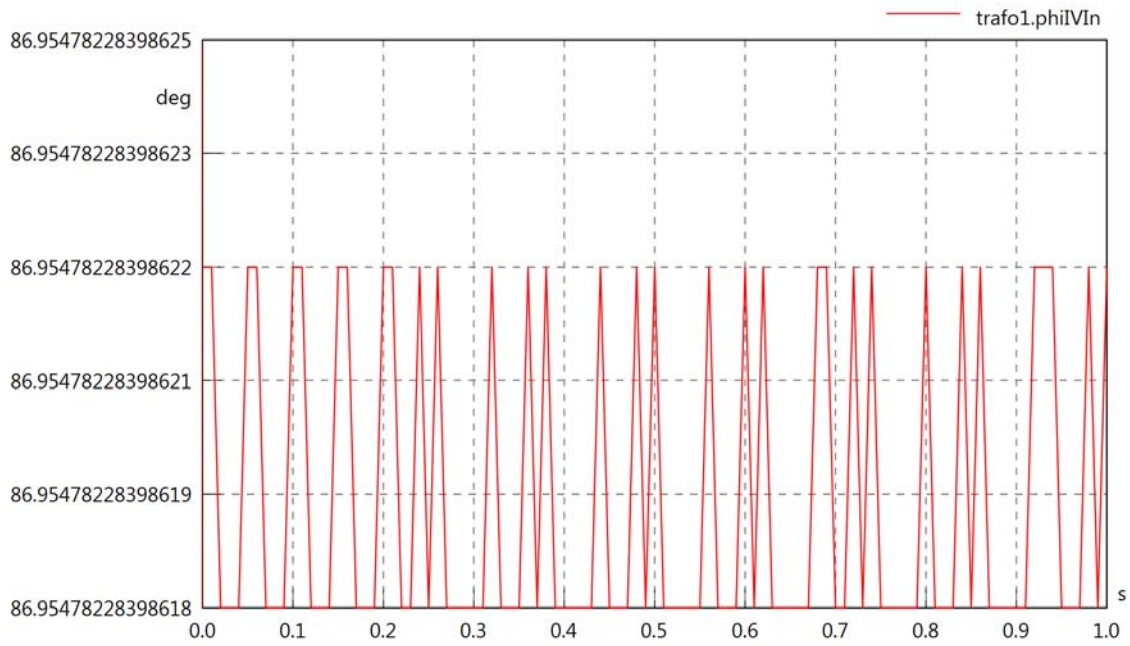

trafo1.PReIn

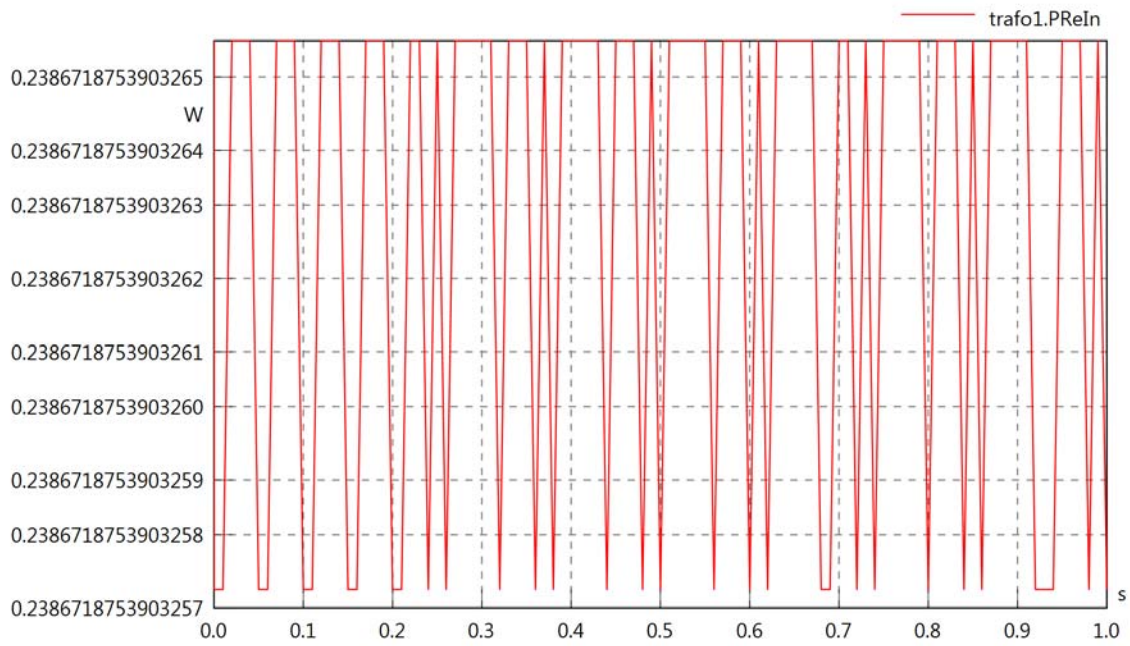

trafo1.PImIn

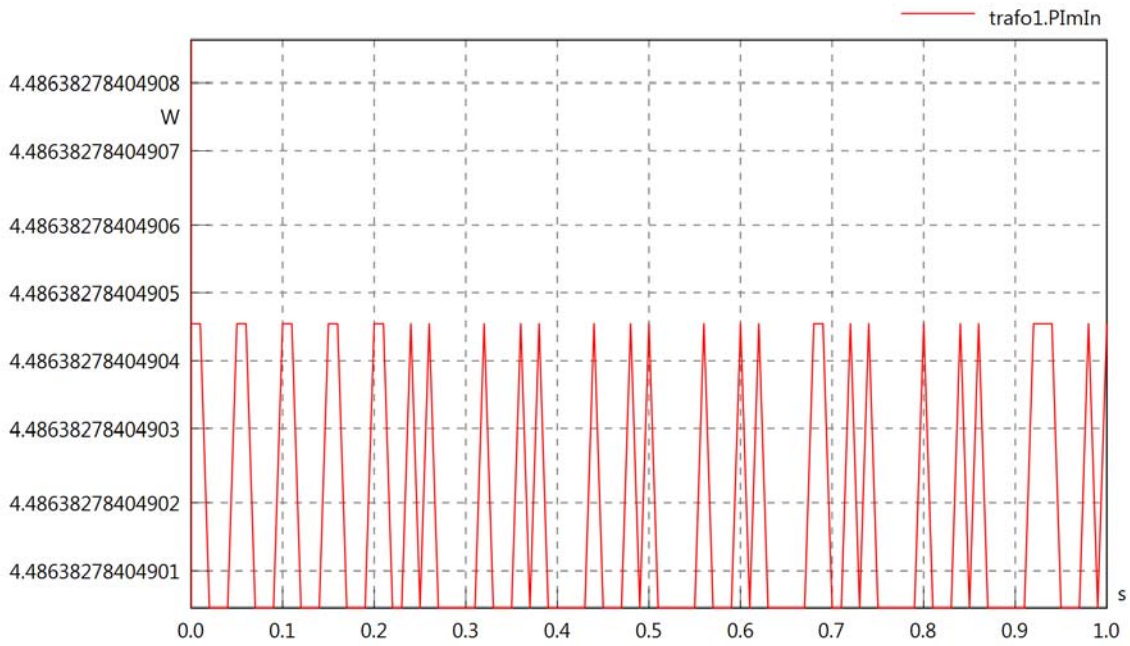

trafo1.SIn

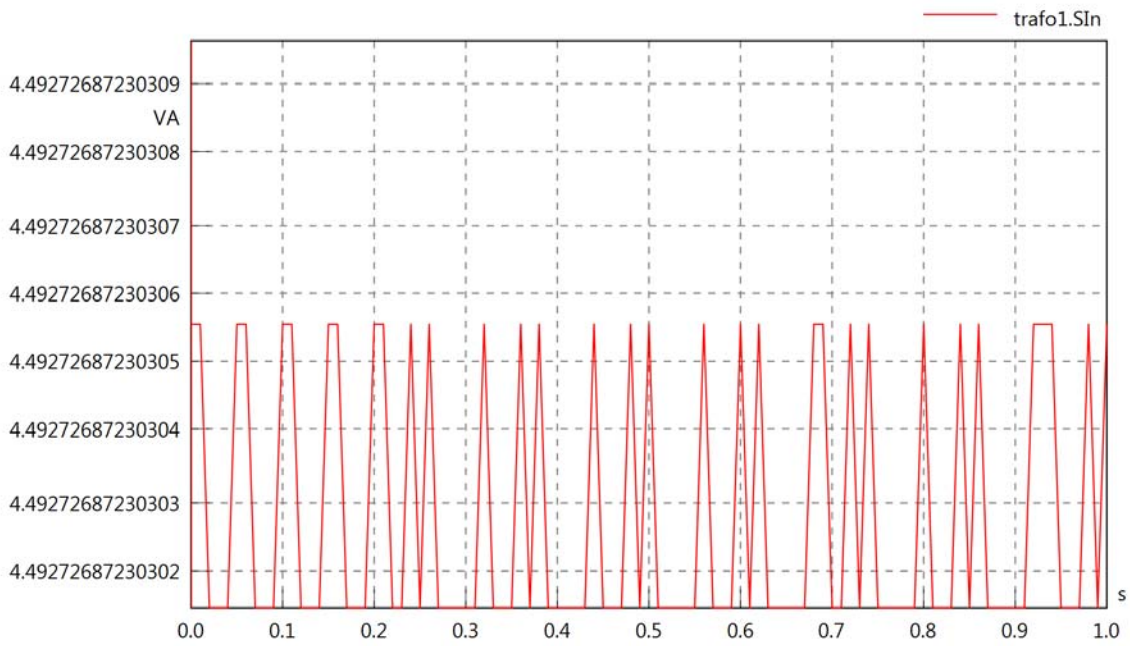

trafo1.pfIn

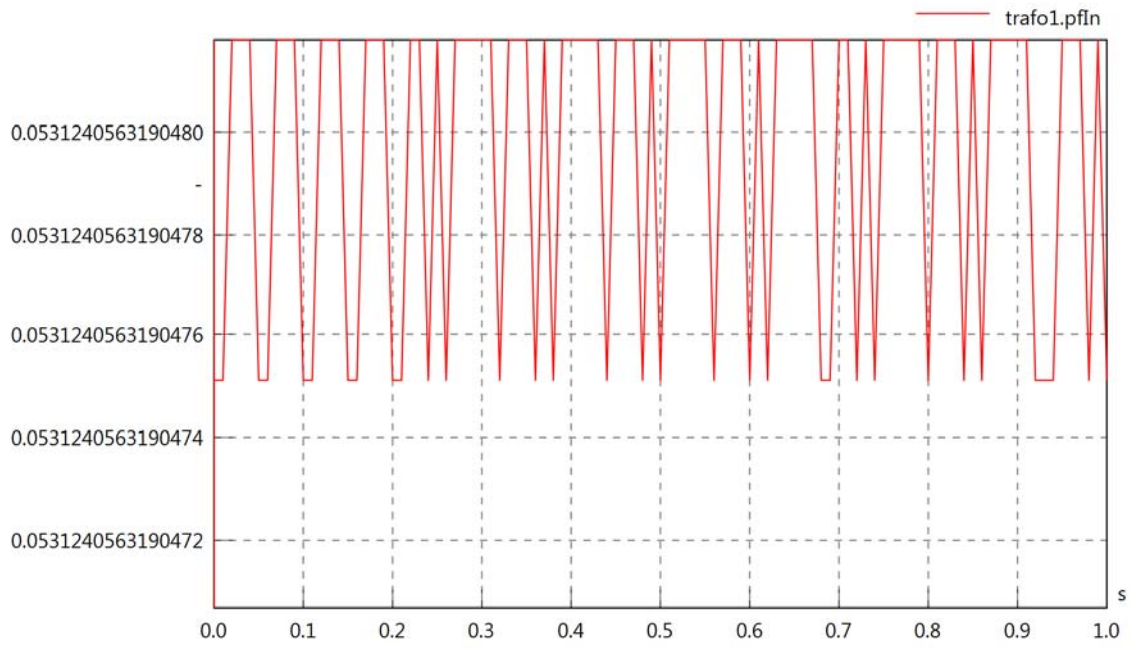

trafo1.VrmsOut

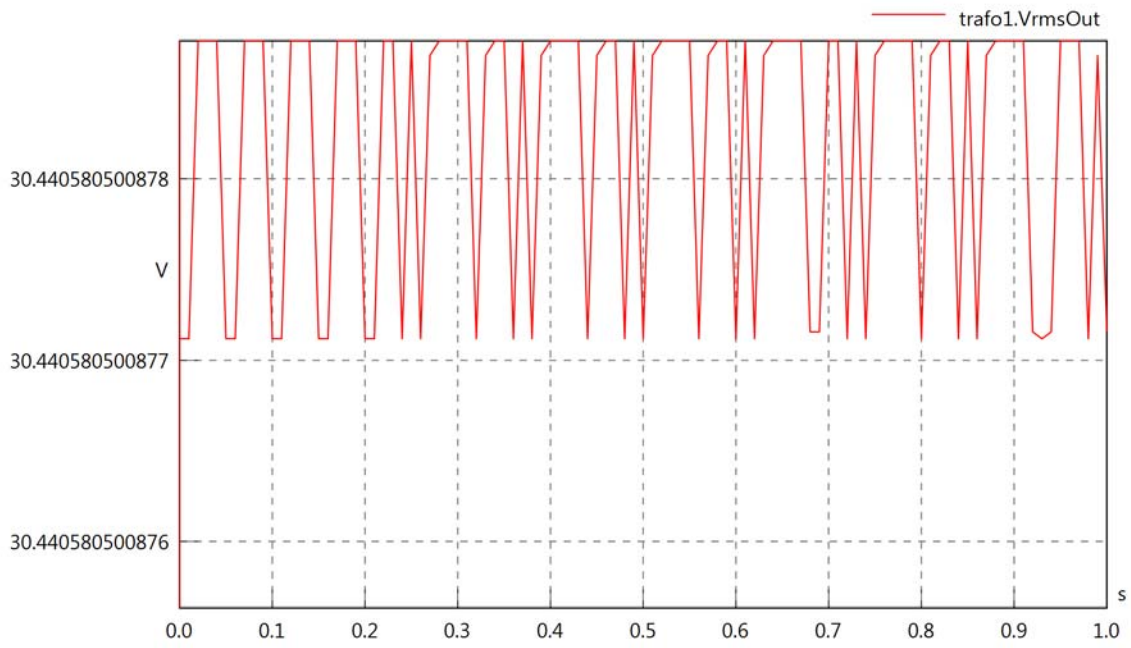

trafo1.vReOut

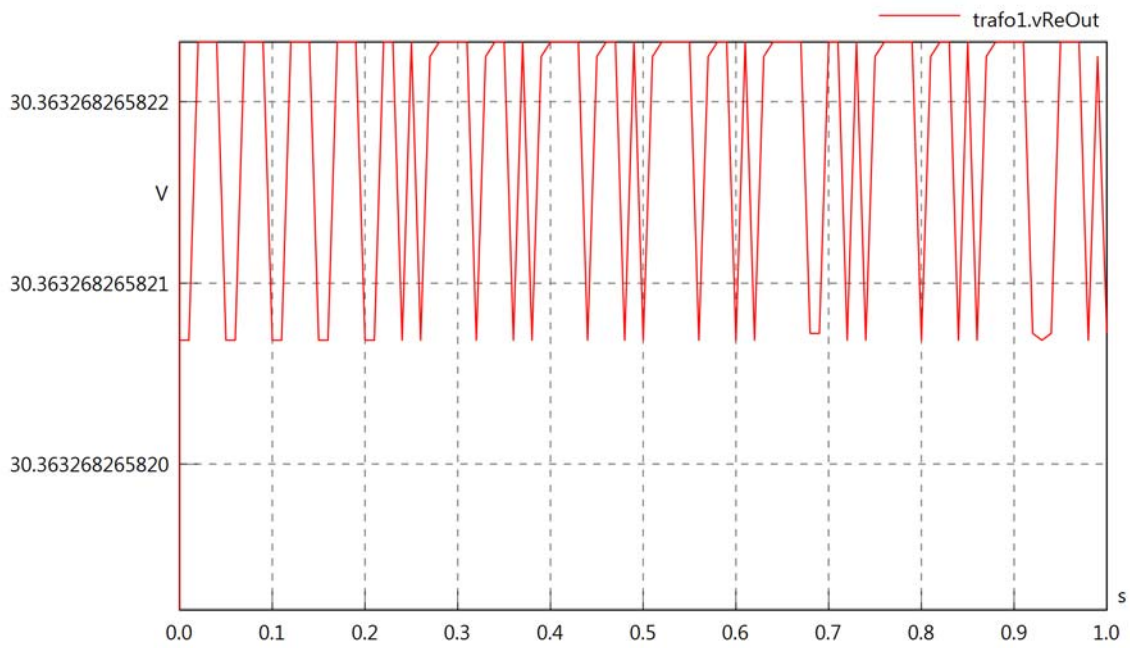

trafo1.vImOut

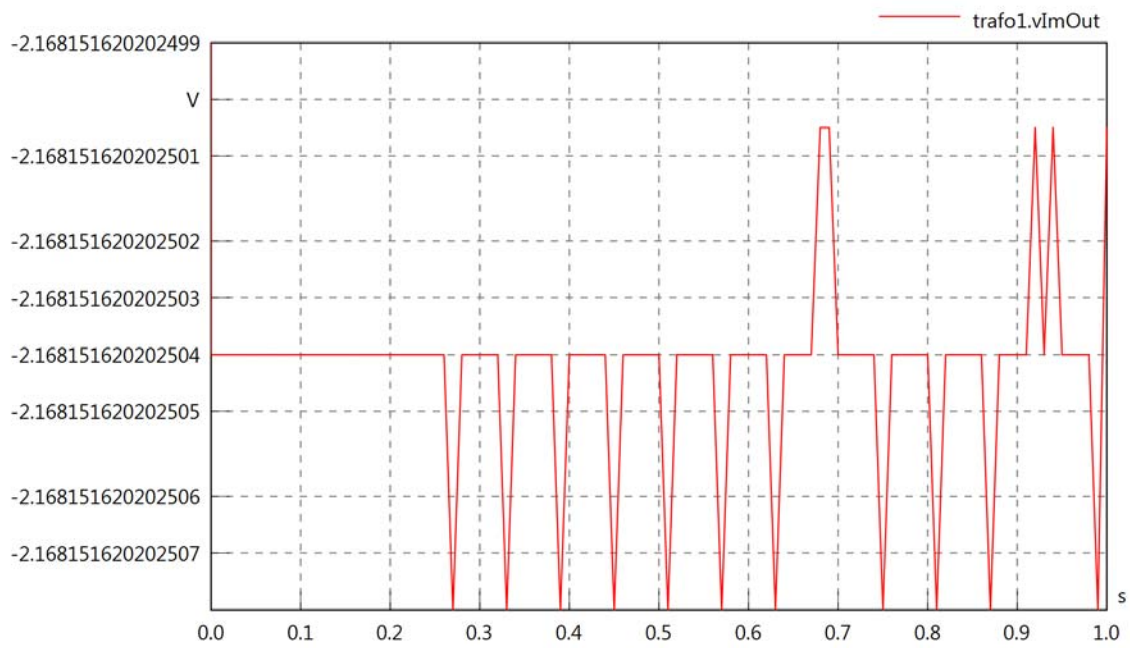

trafo1.IrmsOut

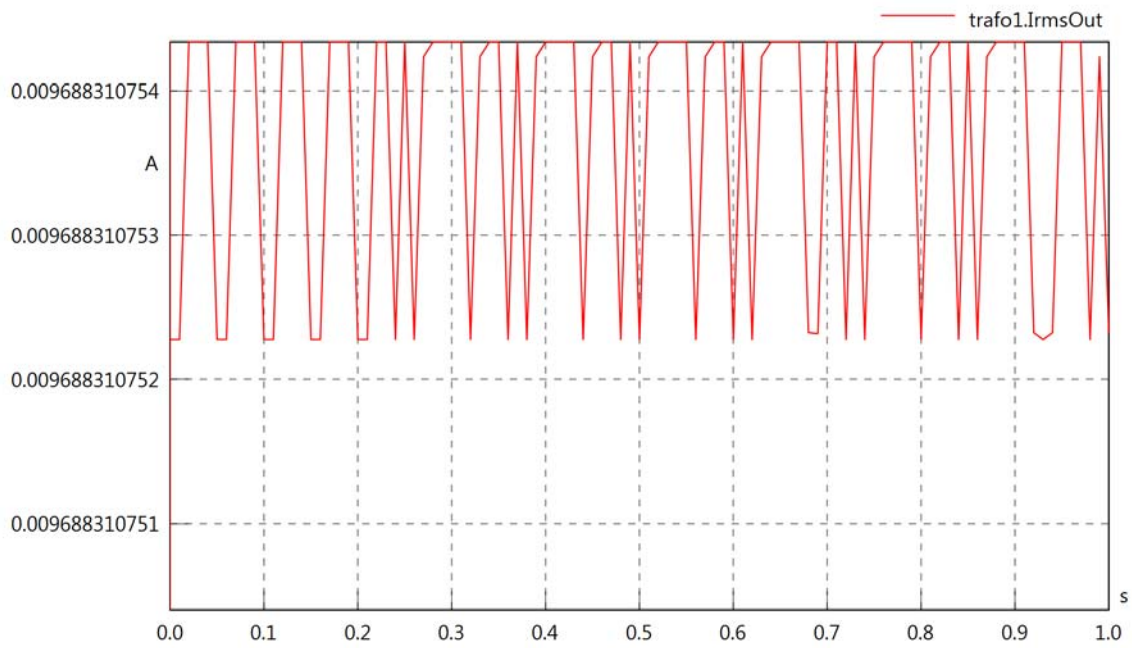

trafo1.iReOut

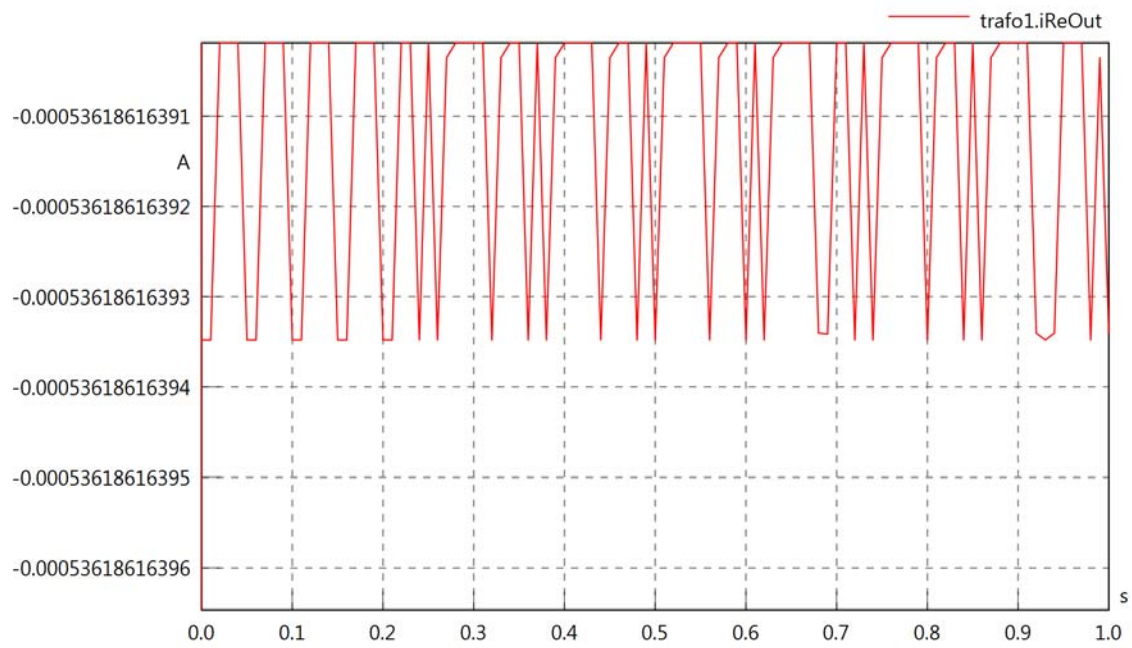

trafo1.iImOut



trafo1.phiVOut

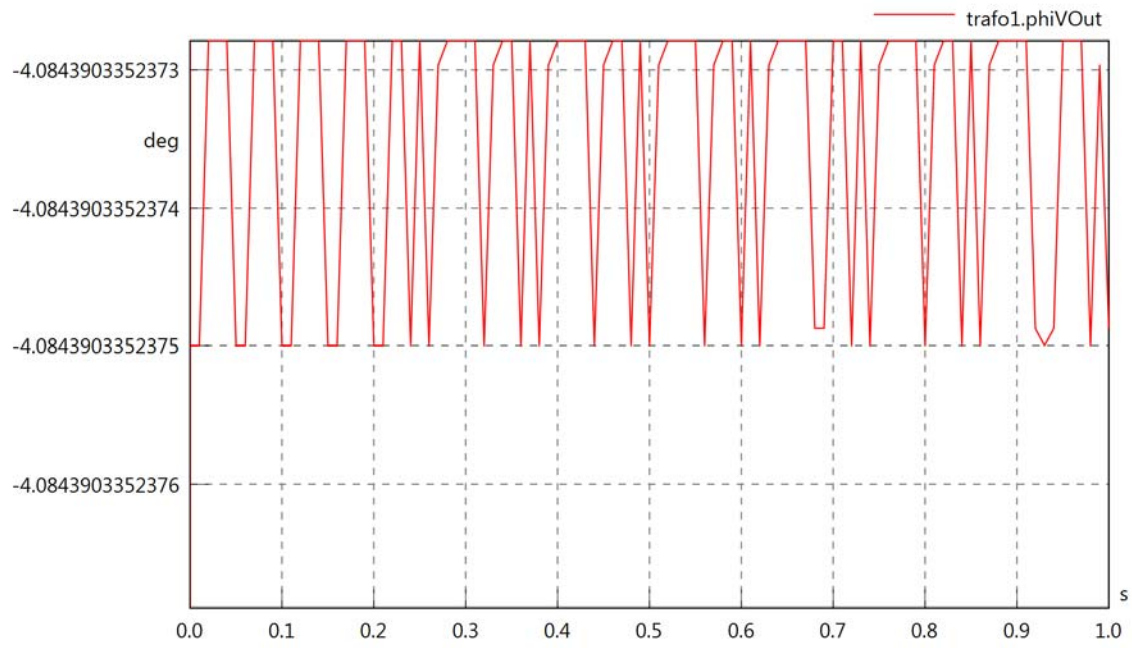

trafo1.phiIOut

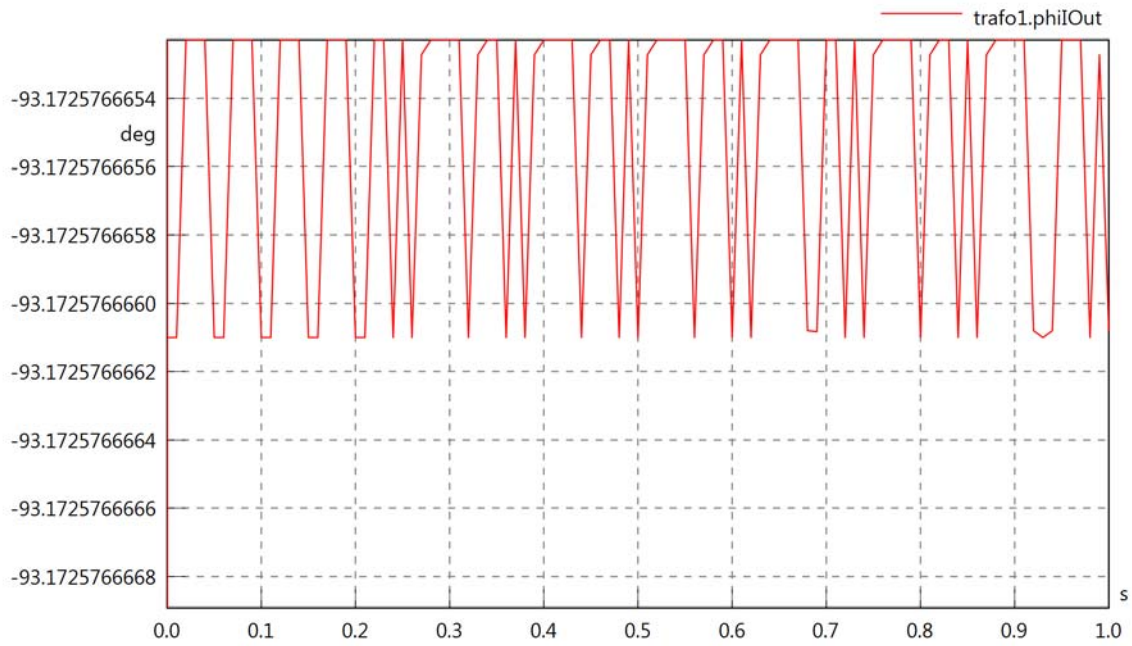

trafo1.phiIVOut

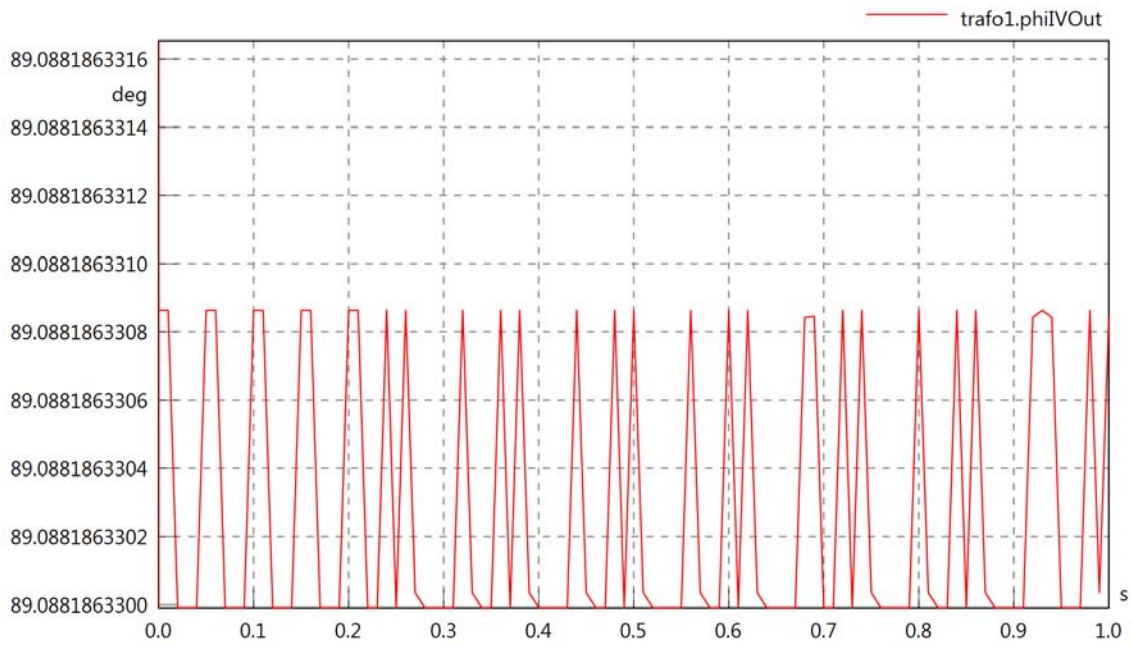

trafo1.PReOut

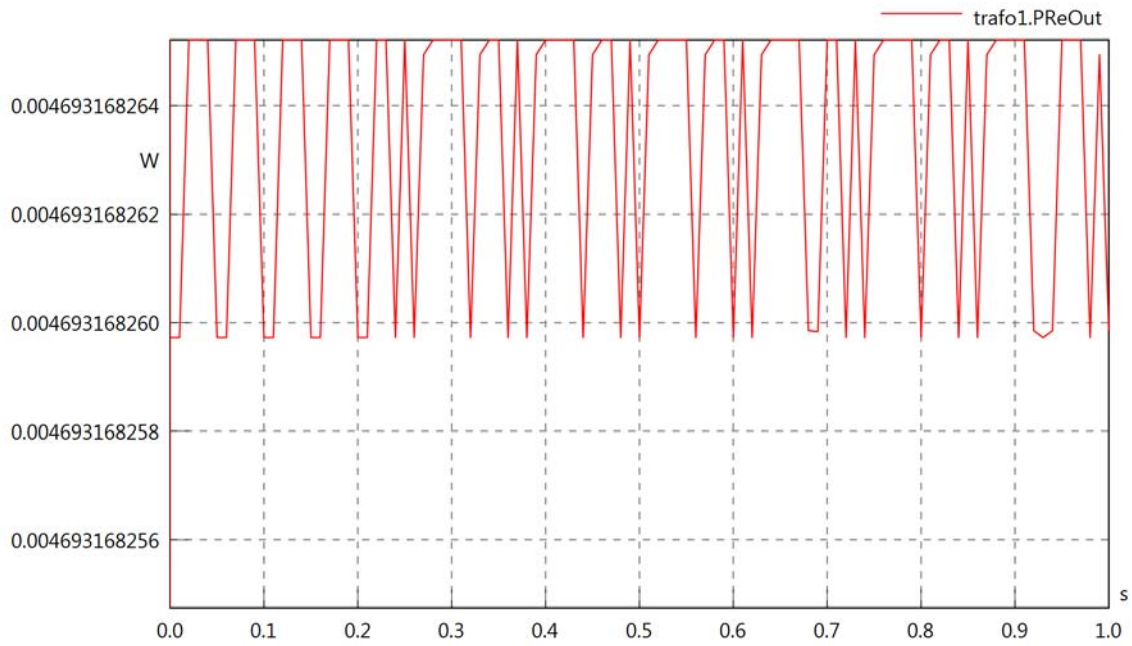

trafo1.PImOut

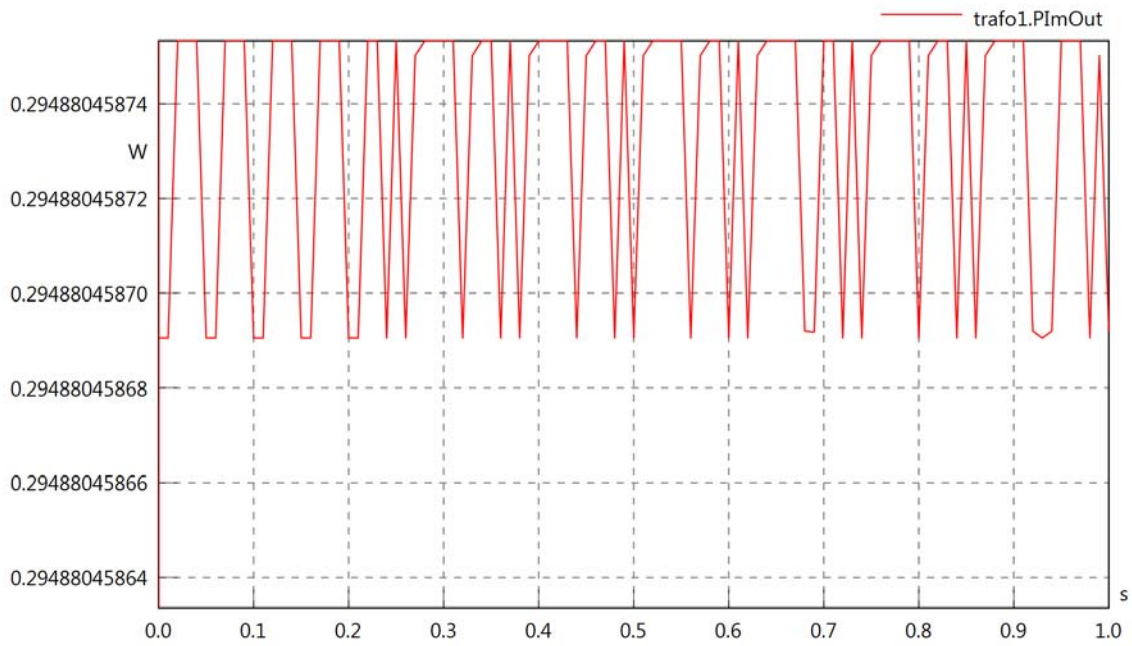

trafo1.SOut

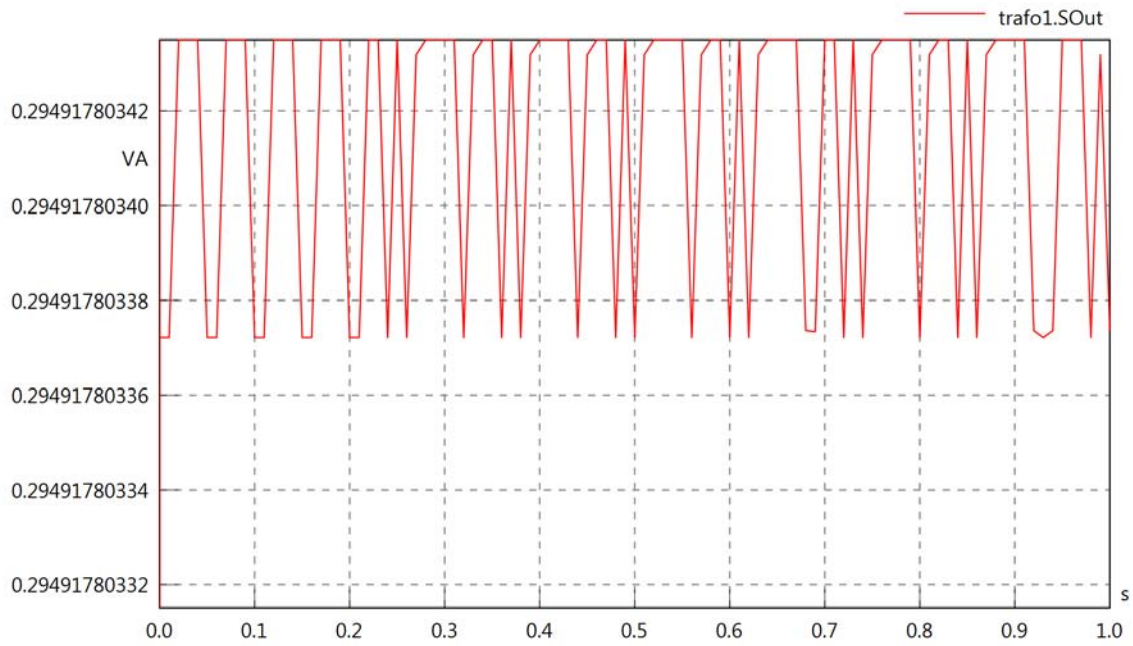

trafo1.pfOut

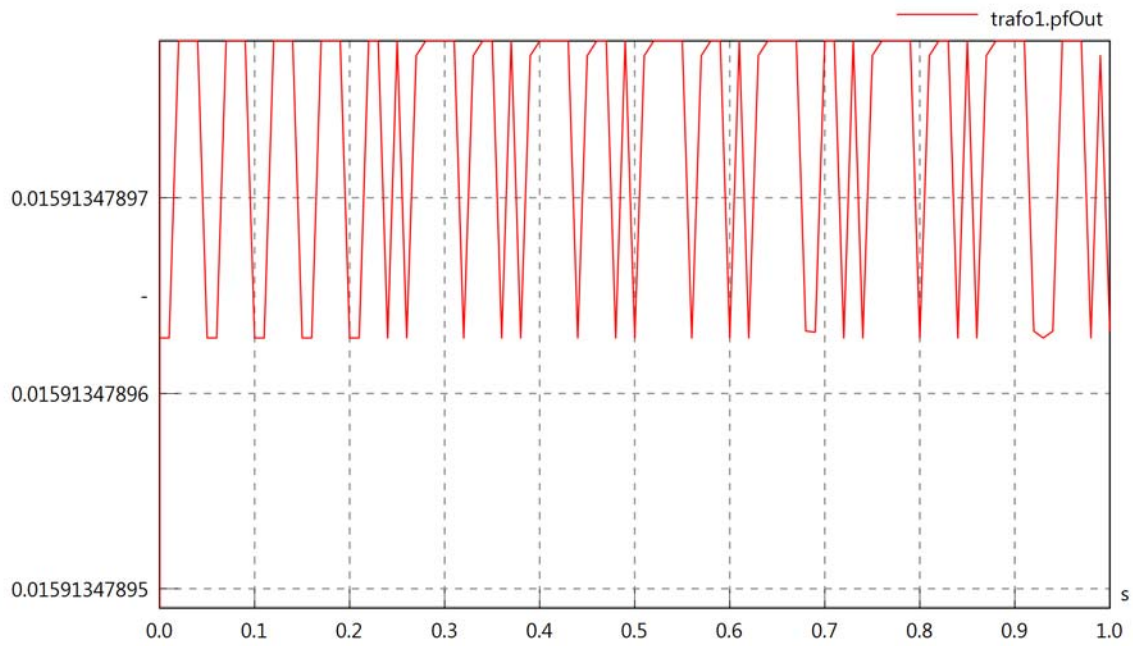
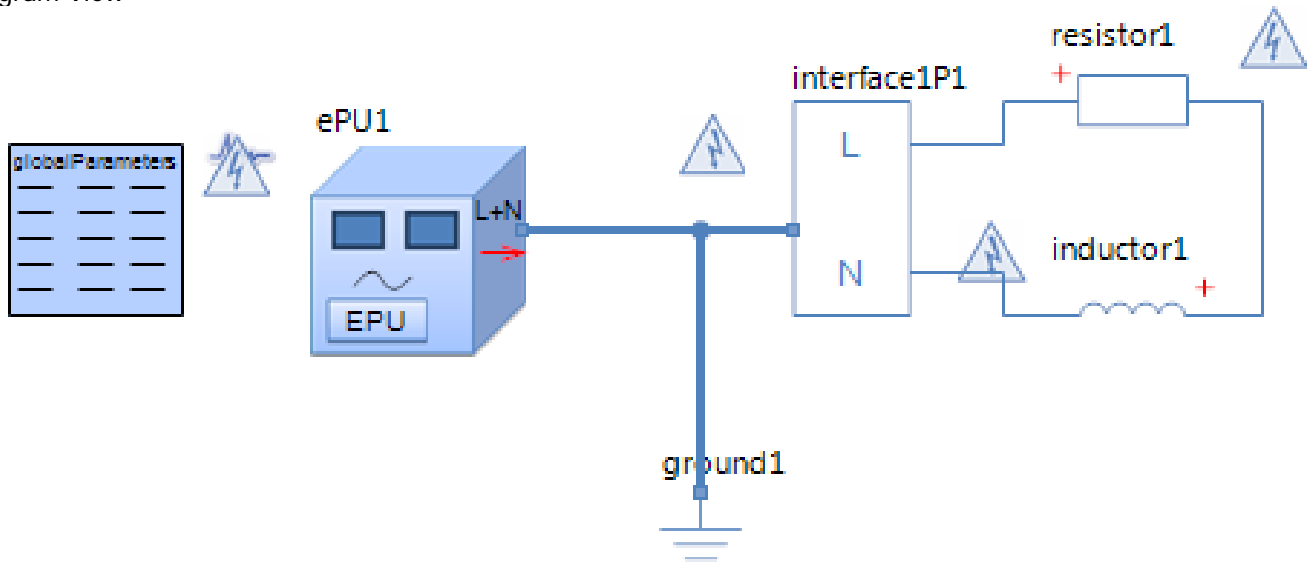

Diagram View



Resistor resistor1
Parameters

Comment	Name	Current Value	Unit
Resistance	R	100	[Ohm]

Inductor inductor1
Parameters

Comment	Name	Current Value	Unit
Inductance	L	100	[mH]
Initial Value	i0	0 (Fixed)	[A]
Kind	kind	absolute	

Electrical Power Unit ePU1
Parameters

Comment	Name	Current Value	Unit
Internal Resistance L1	RL	5	[Ohm]
Internal Resistance N	RN	5	[Ohm]
Sine Wave RMS Voltage	VrmsSrc	230	[V]
Frequency	f	30	[Hz]
Voltage Offset	offset	0	[V]
Voltage Start-phase	phase	0	[deg]
Power Unit Type	kind	Without UPS Noise	

ePU1.vOut

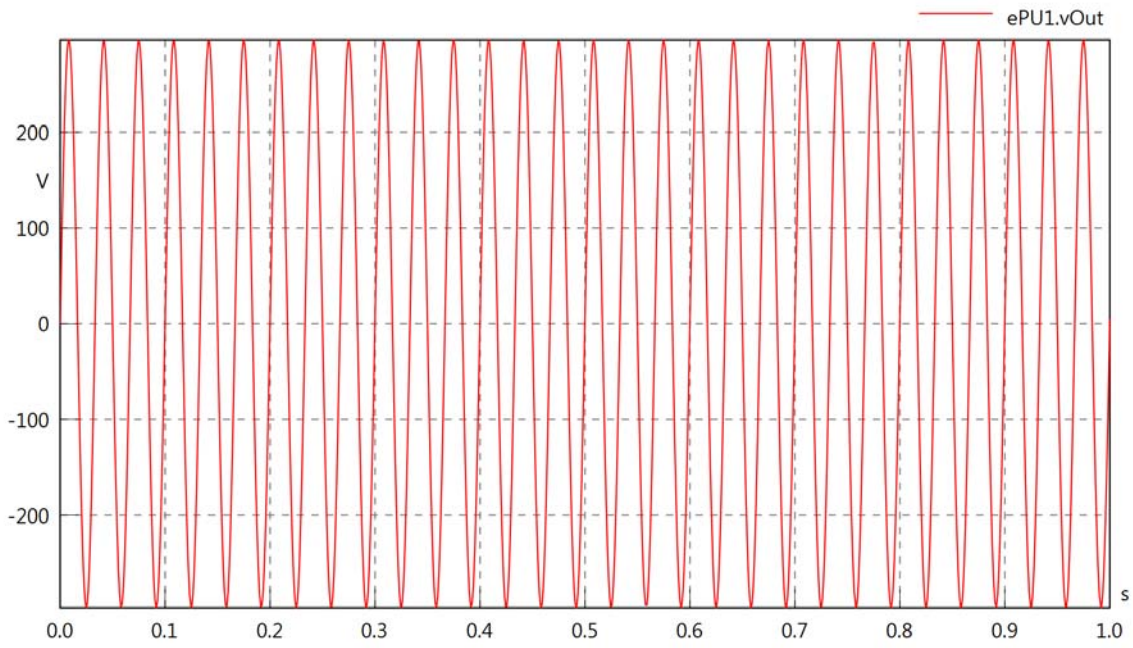

ePU1.vDrop

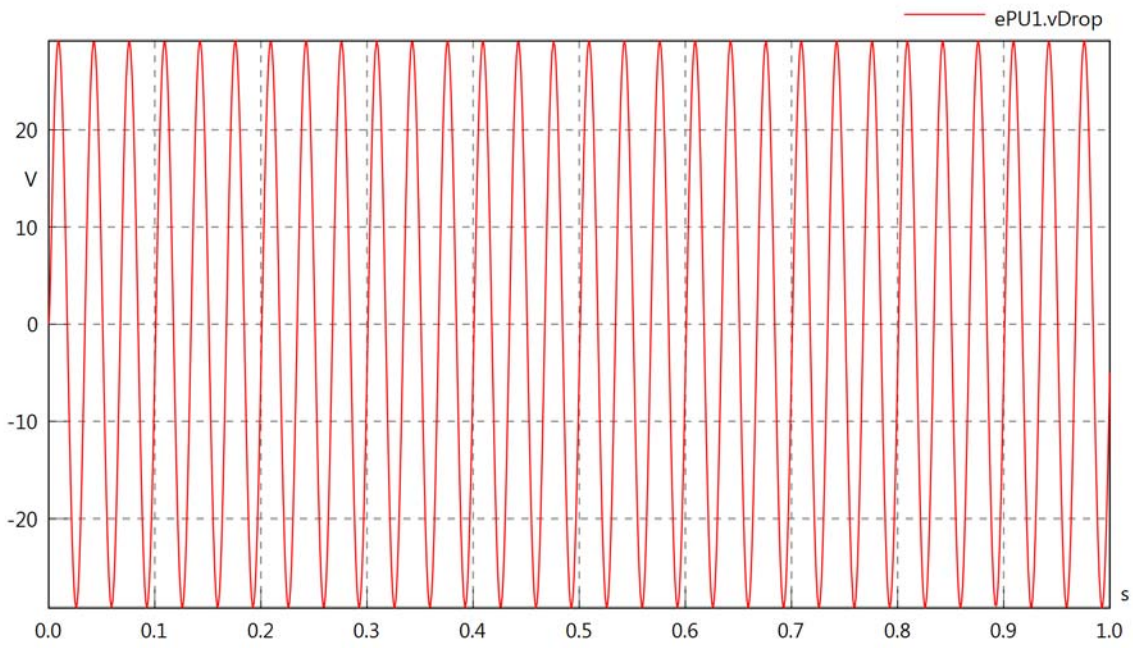

ePU1.iOut

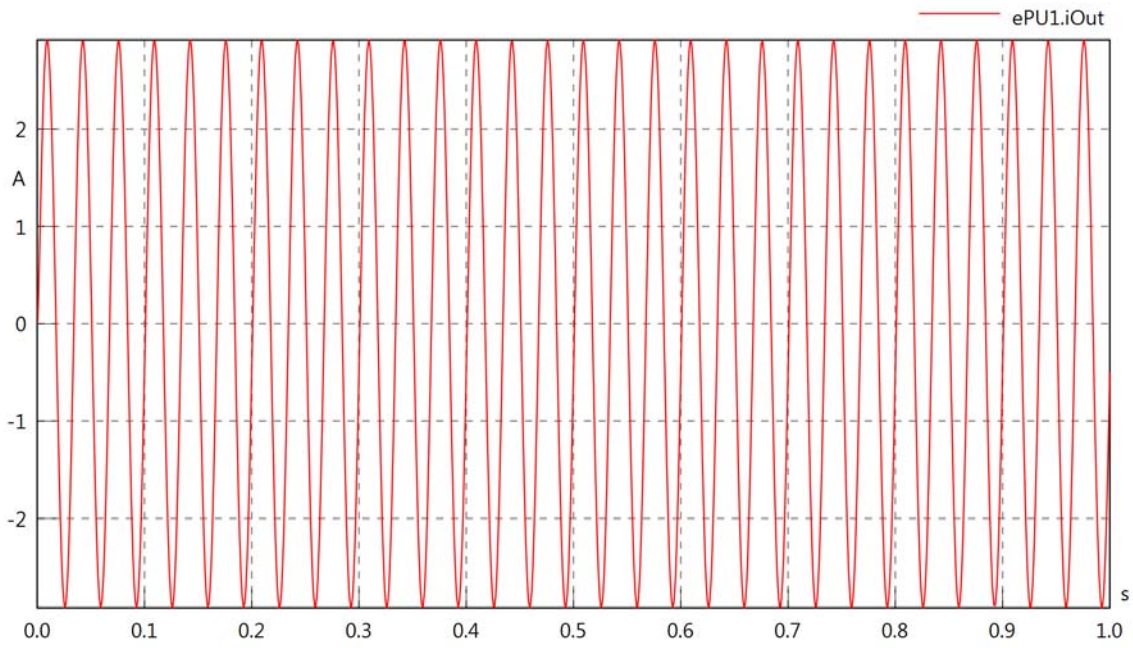

ePU1.POut

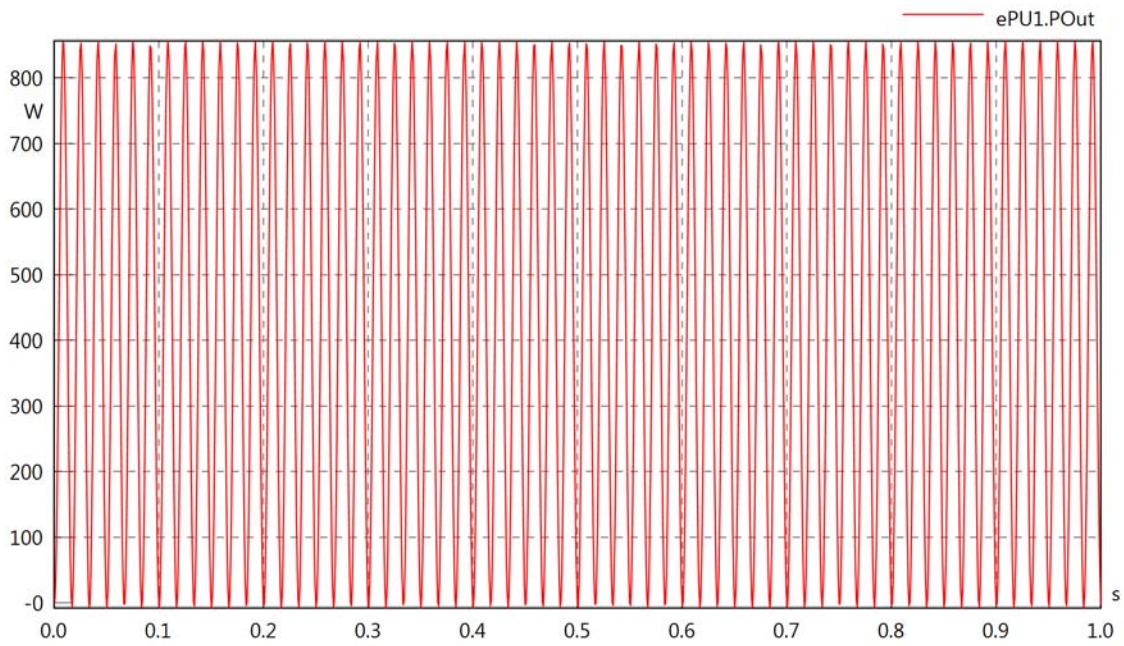

ePU1.PI

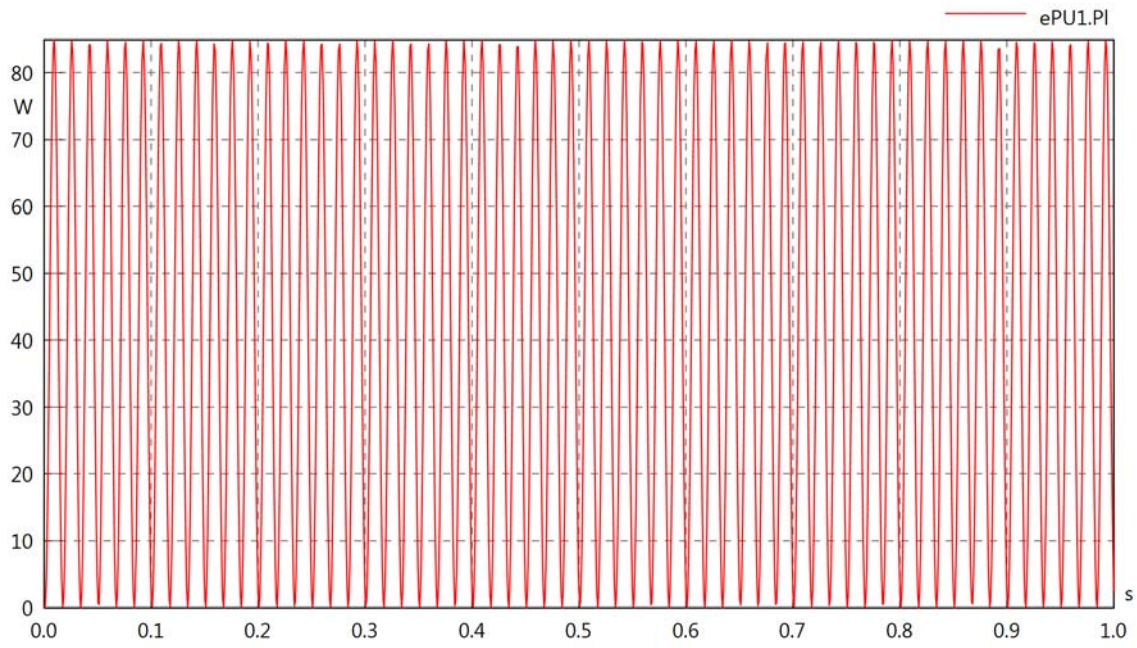
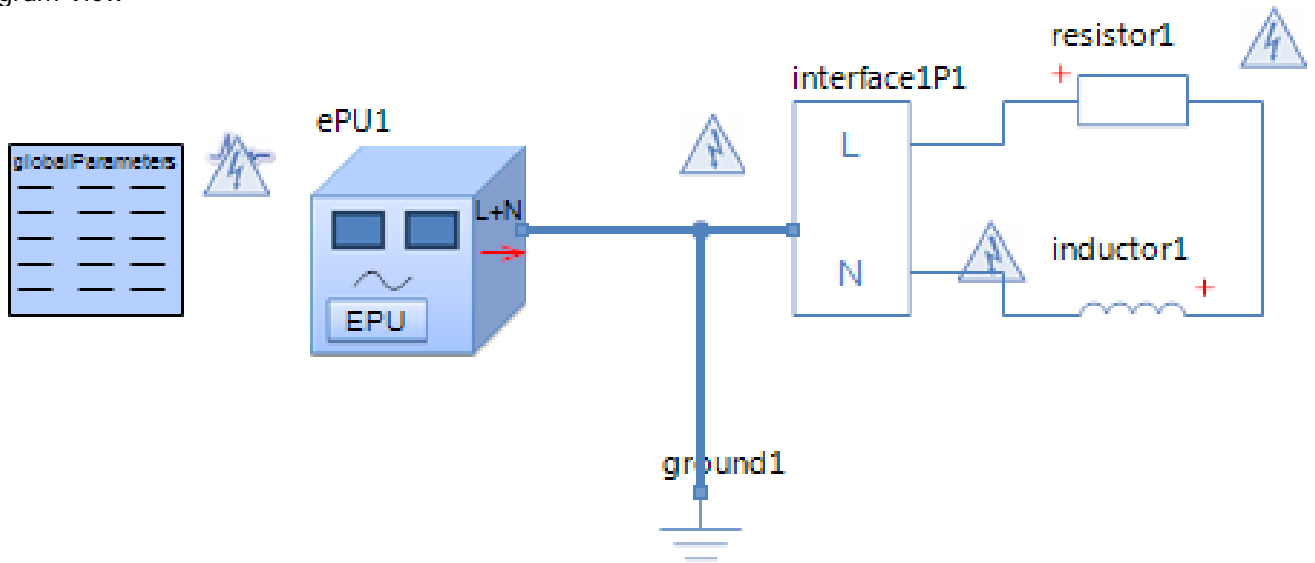

Diagram View



Resistor resistor1
Parameters

Comment	Name	Current Value	Unit
Resistance	R	100	[Ohm]

Inductor inductor1
Parameters

Comment	Name	Current Value	Unit
Inductance	L	100	[mH]
Initial Value	i0	0 (Fixed)	[A]
Kind	kind	absolute	

Electrical Power Unit ePU1
Parameters

Comment	Name	Current Value	Unit
Internal Resistance L1	RL	5	[Ohm]
Internal Resistance N	RN	5	[Ohm]
Sine Wave RMS Voltage	VrmsSrc	230	[V]
Frequency	f	60	[Hz]
Voltage Offset	offset	0	[V]
Voltage Start-phase	phase	0	[deg]
Power Unit Type	kind	Without UPS Noise	

ePU1.vOut

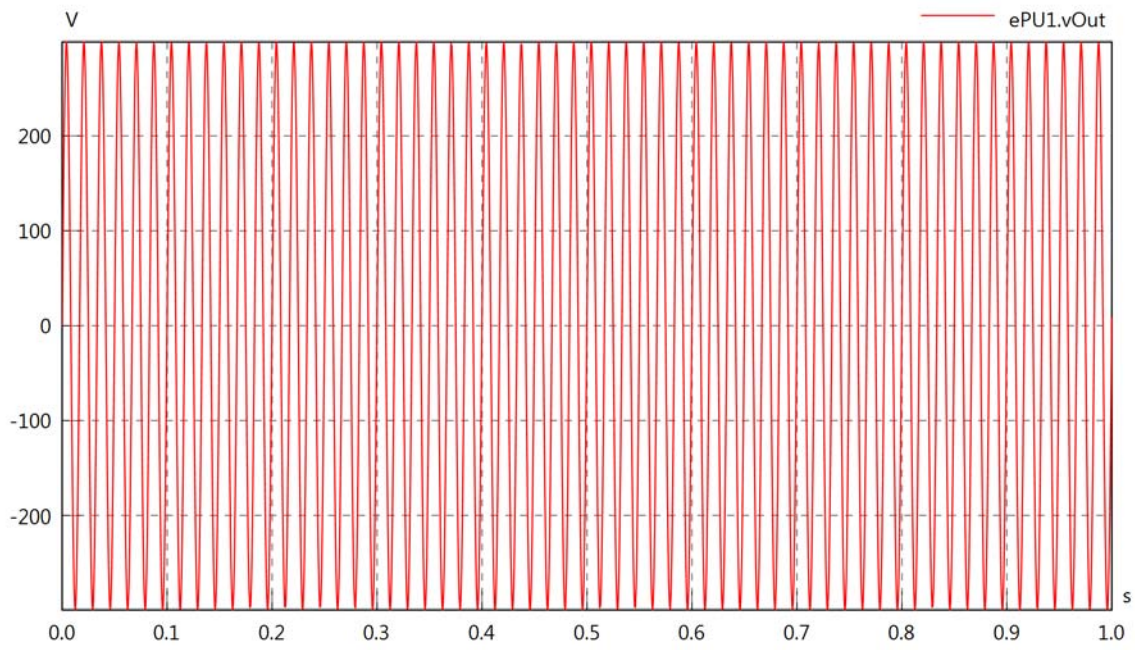

ePU1.vDrop

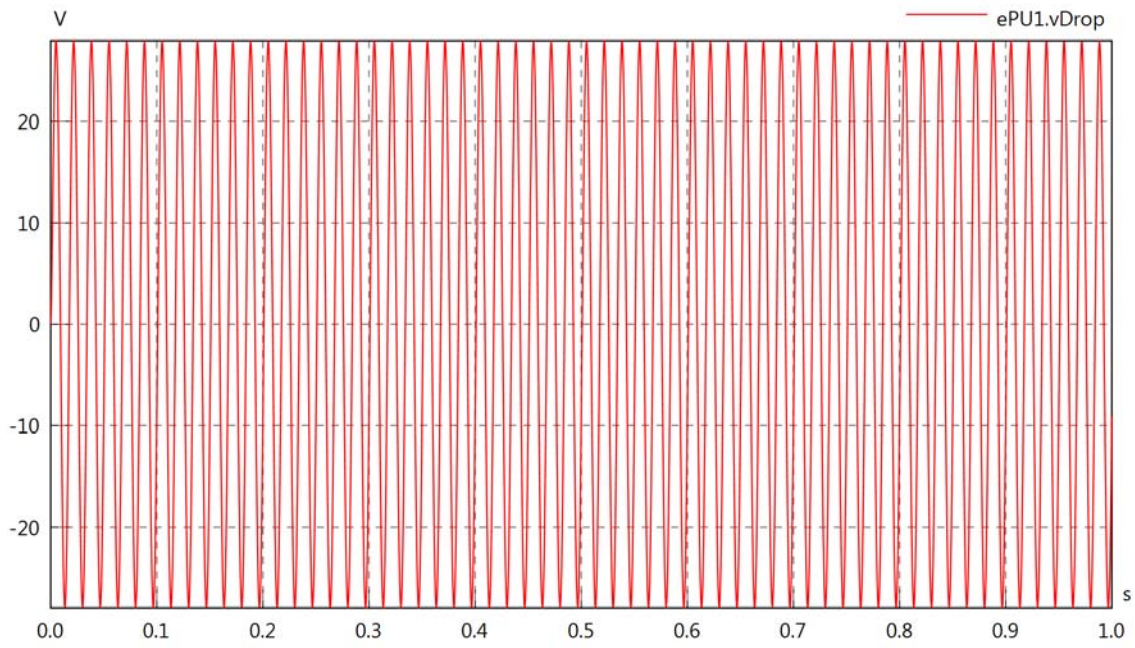

ePU1.iOut

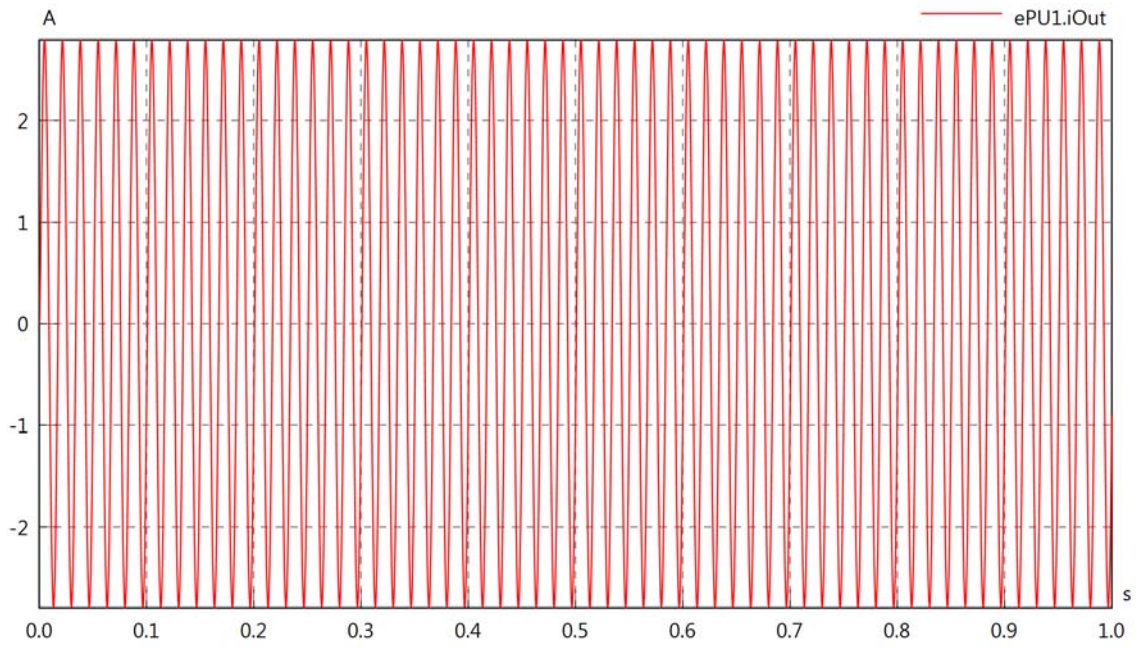

ePU1.POut

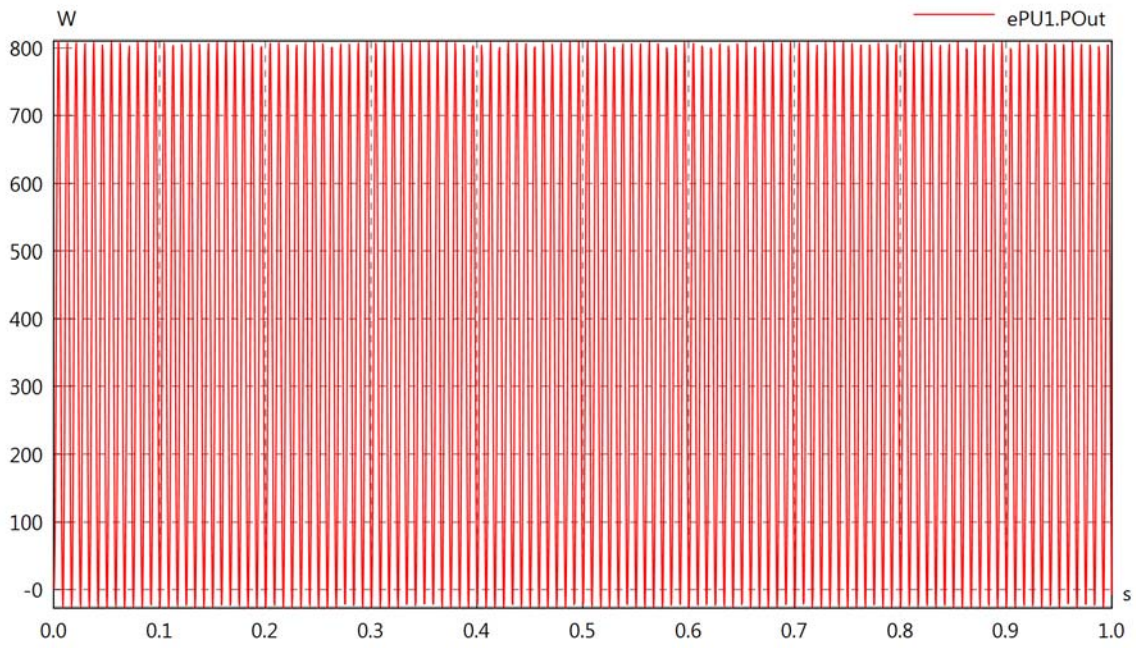

ePU1.PI

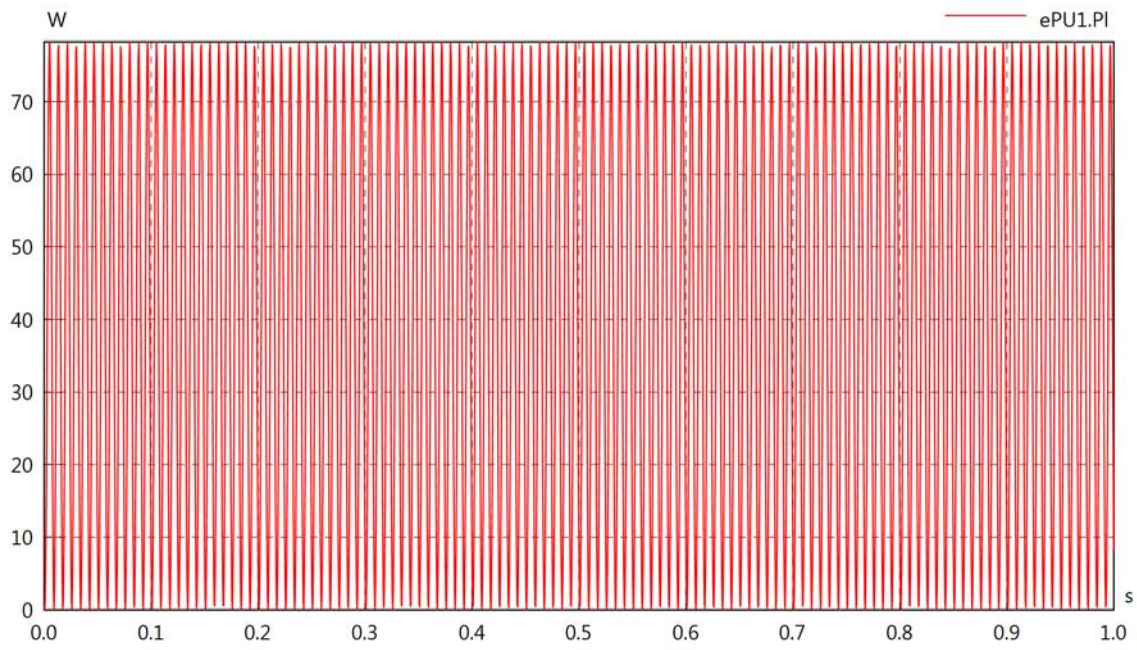
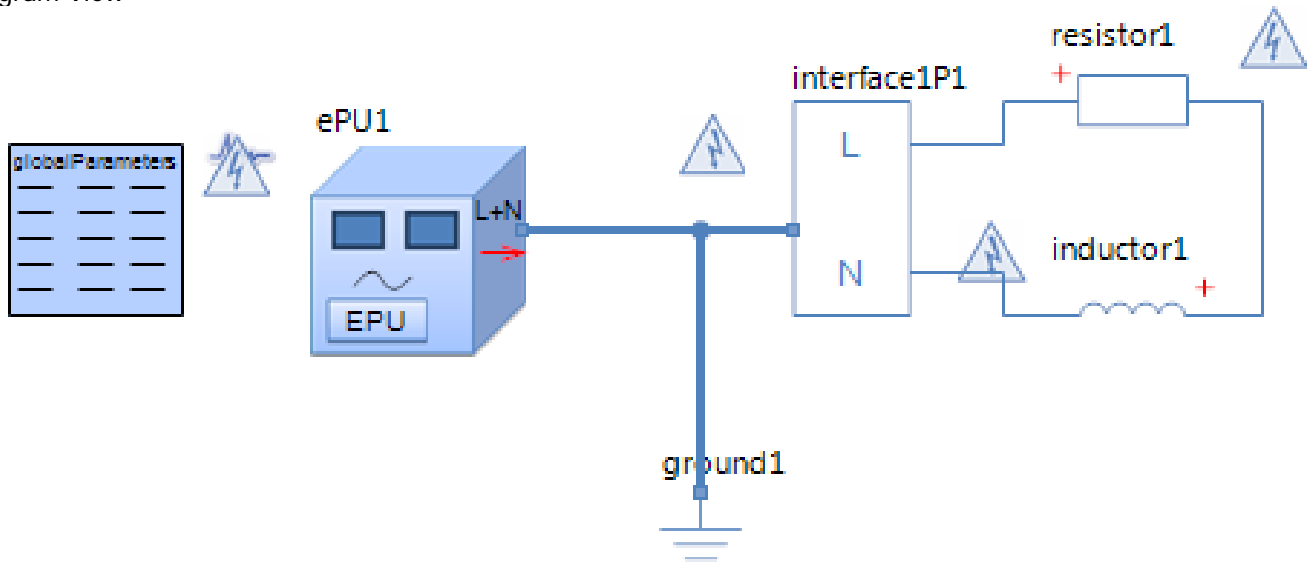

Diagram View



Resistor resistor1
Parameters

Comment	Name	Current Value	Unit
Resistance	R	100	[Ohm]

Inductor inductor1
Parameters

Comment	Name	Current Value	Unit
Inductance	L	100	[mH]
Initial Value	i0	0 (Fixed)	[A]
Kind	kind	absolute	

Electrical Power Unit ePU1
Parameters

Comment	Name	Current Value	Unit
Internal Resistance L1	RL	5	[Ohm]
Internal Resistance N	RN	5	[Ohm]
Sine Wave RMS Voltage	VrmsSrc	230	[V]
Frequency	f	120	[Hz]
Voltage Offset	offset	0	[V]
Voltage Start-phase	phase	0	[deg]
Power Unit Type	kind	Without UPS Noise	

ePU1.vOut

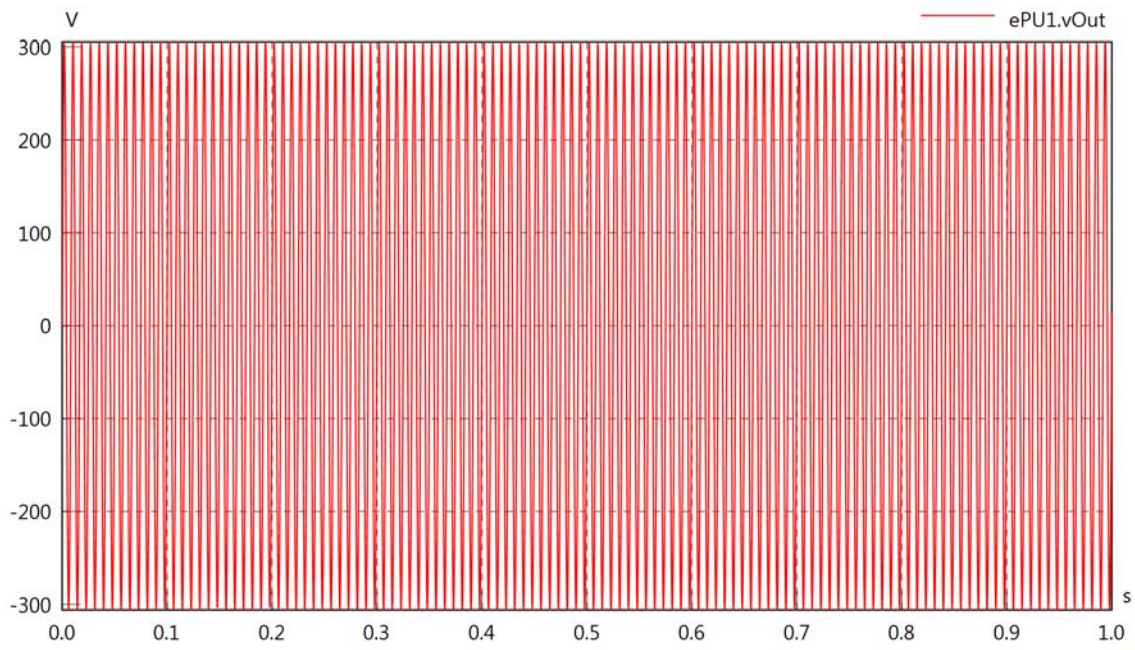

ePU1.vDrop

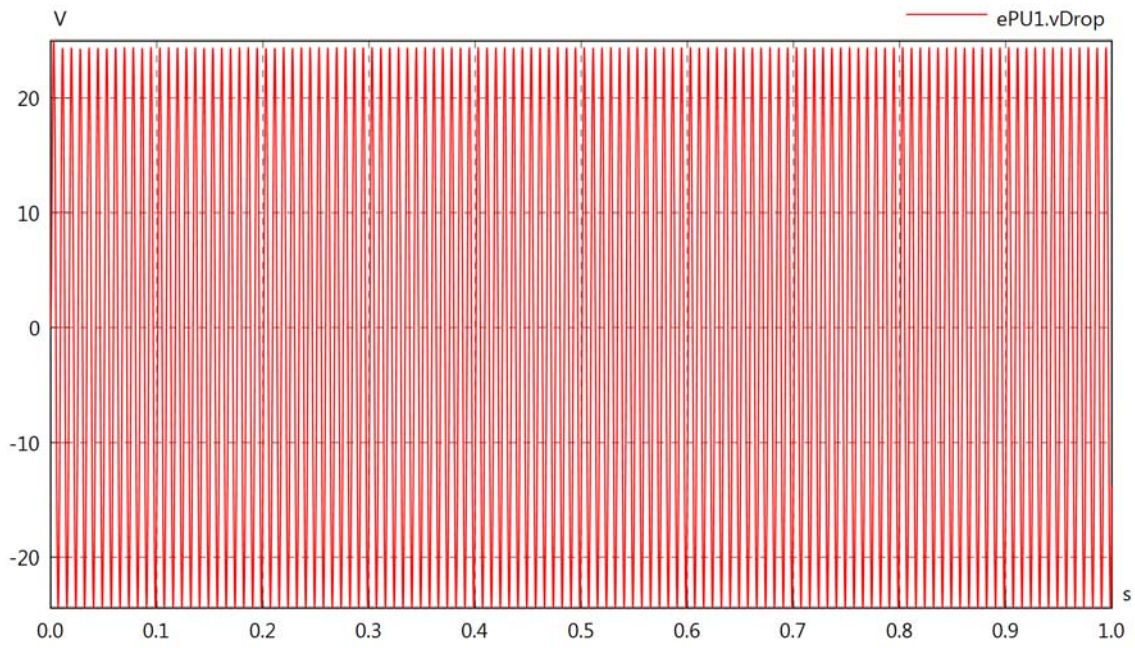

ePU1.iOut

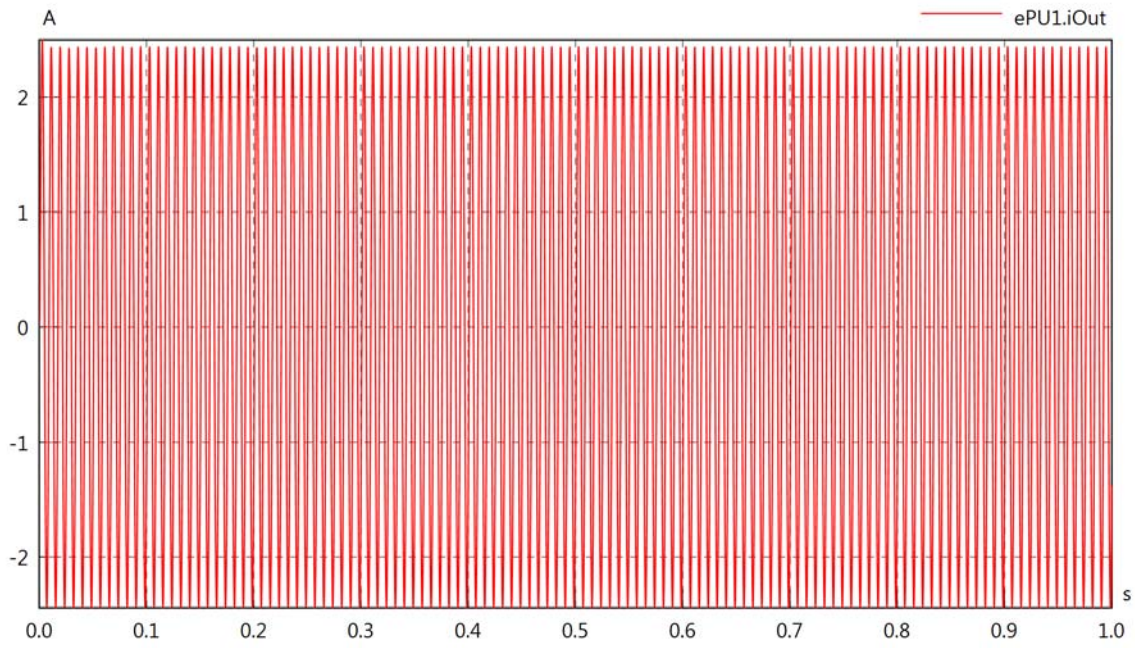

ePU1.POut

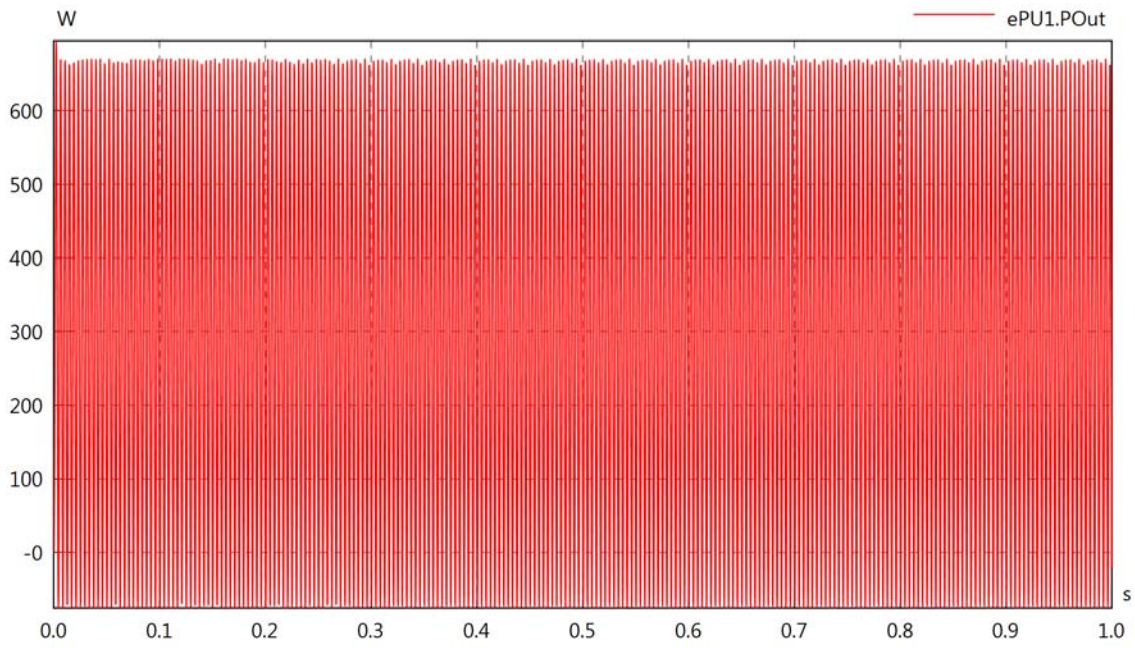

ePU1.PI

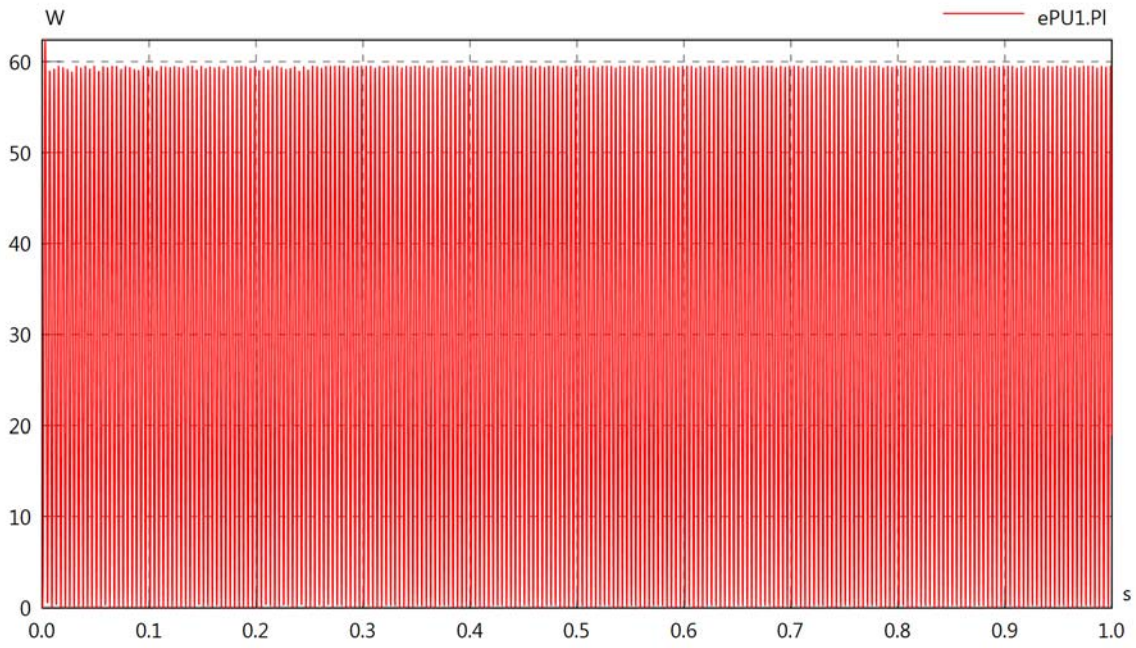
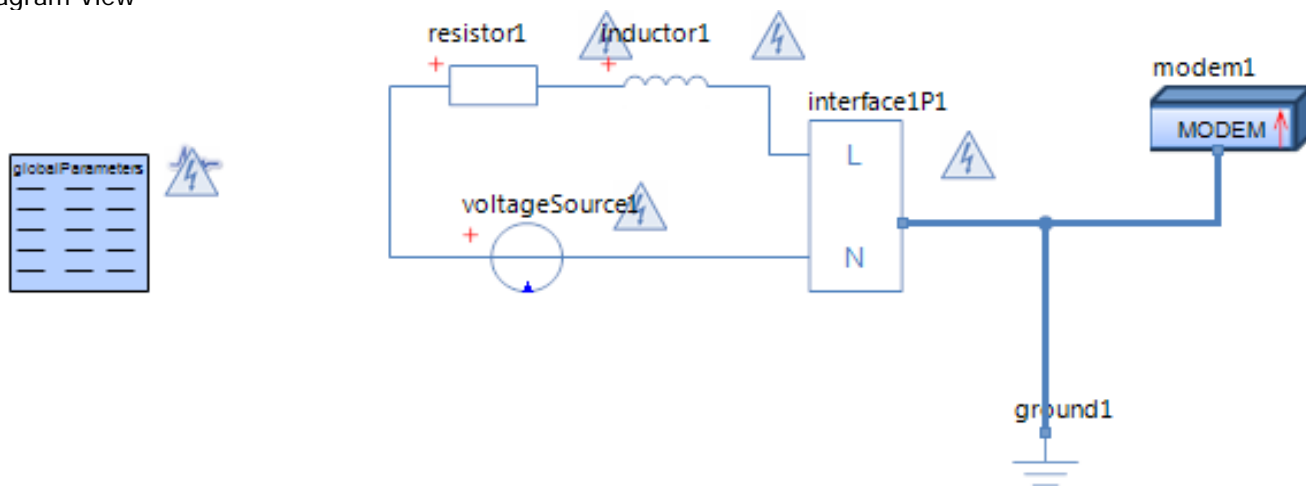

Diagram View



Resistor resistor1
Parameters

Comment	Name	Current Value	Unit
Resistance	R	1500	[Ohm]

Inductor inductor1
Parameters

Comment	Name	Current Value	Unit
Inductance	L	5	[mH]
Initial Value	i0	0 (Fixed)	[A]
Kind	kind	absolute	

Voltage Source voltageSource1
Parameters

Comment	Name	Current Value	Unit
Voltage	v_src	$\sqrt{2} * 230 * \sin(t * 2 * \pi * 30)$	[V]

modem1.vIn

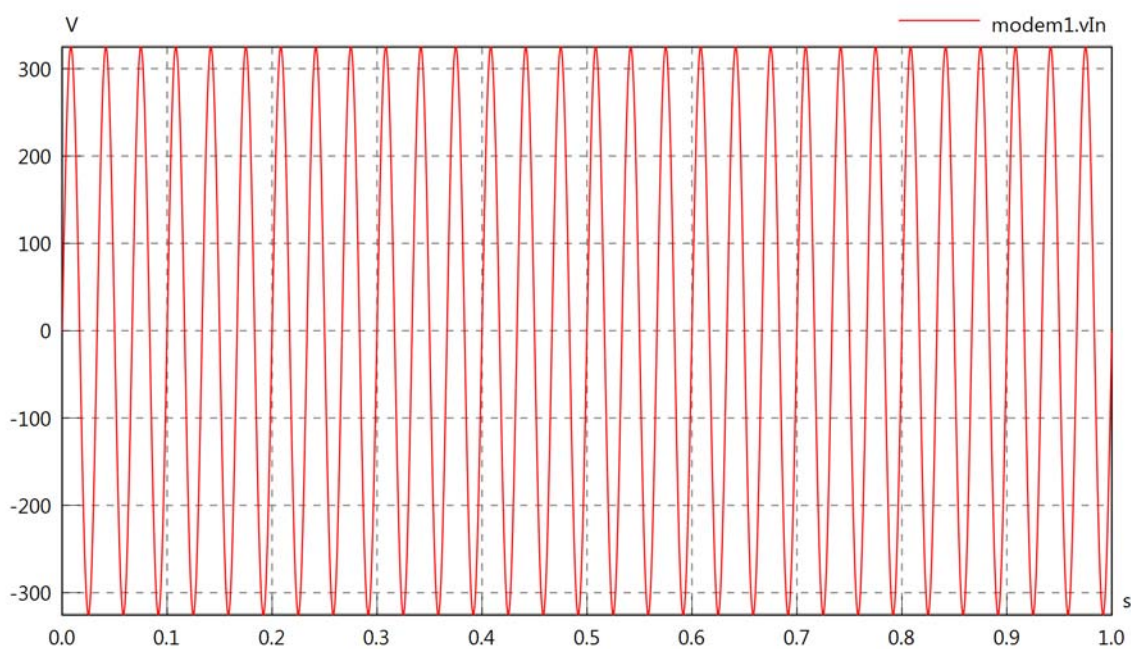

modem1.iIn

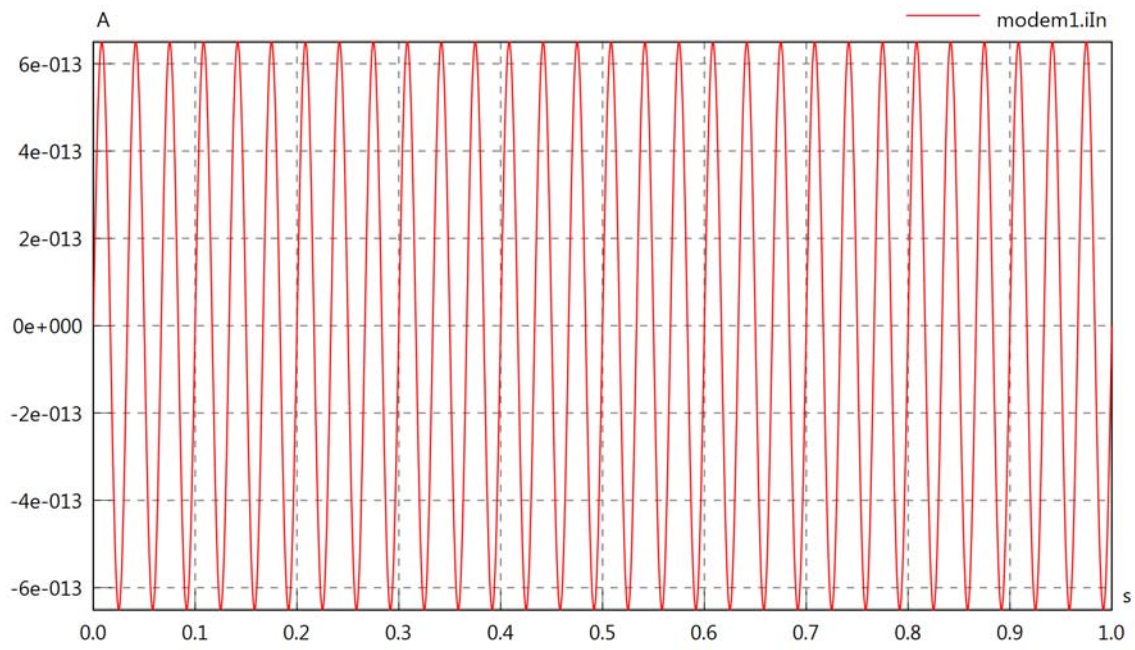

modem1.PIn

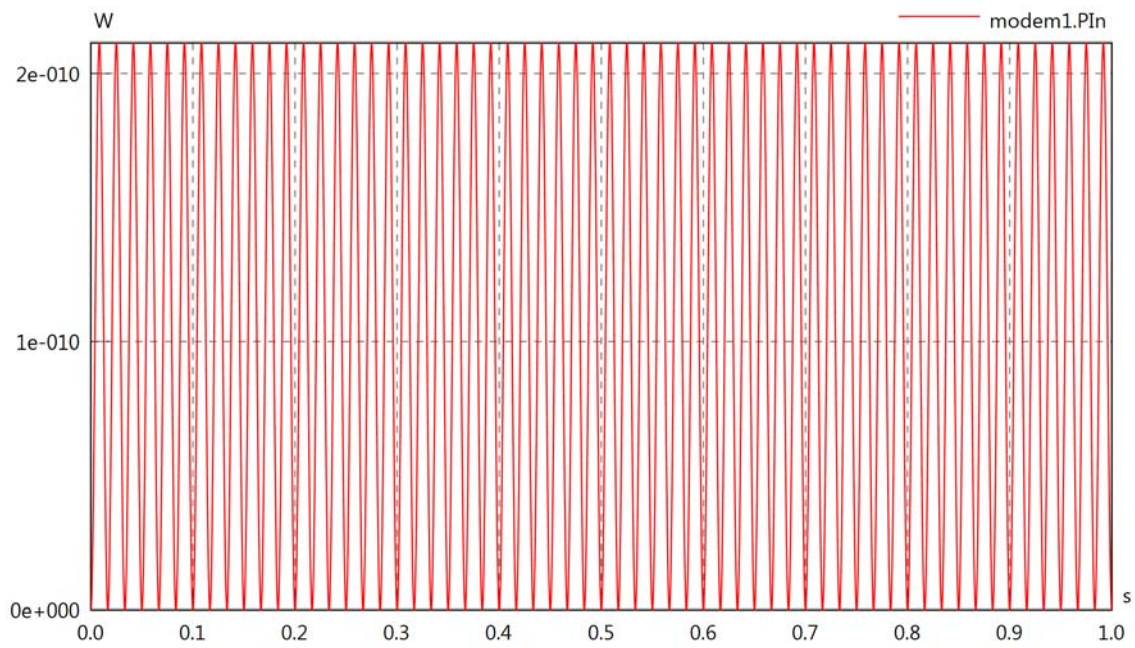
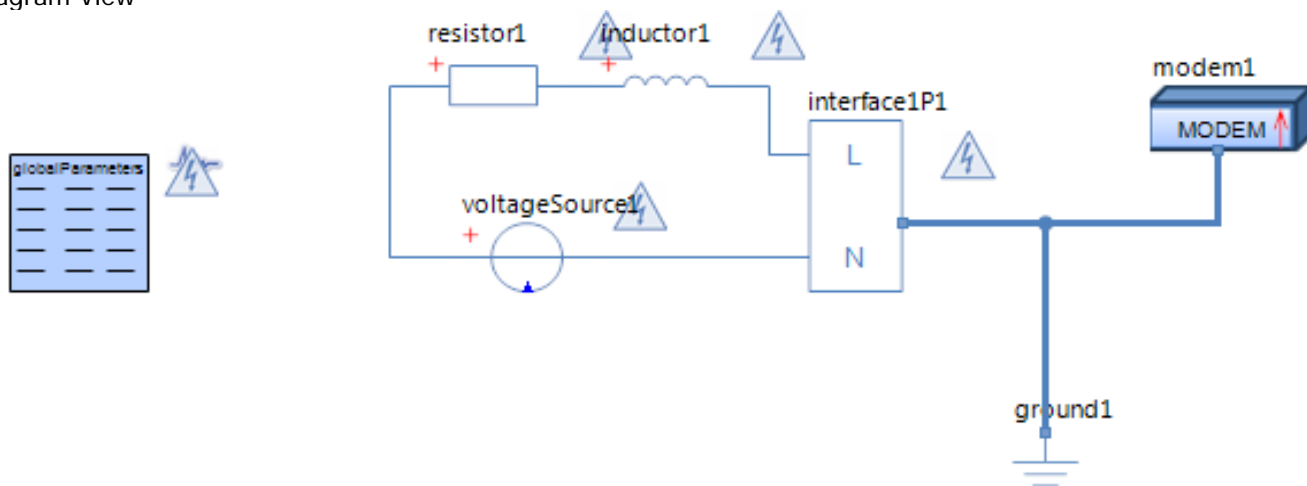

Diagram View



Resistor resistor1
Parameters

Comment	Name	Current Value	Unit
Resistance	R	1500	[Ohm]

Inductor inductor1
Parameters

Comment	Name	Current Value	Unit
Inductance	L	5	[mH]
Initial Value	i0	0 (Fixed)	[A]
Kind	kind	absolute	

Voltage Source voltageSource1
Parameters

Comment	Name	Current Value	Unit
Voltage	v_src	$\sqrt{2} * 230 * \sin(t * 2 * \pi * 60)$	[V]

modem1.vIn

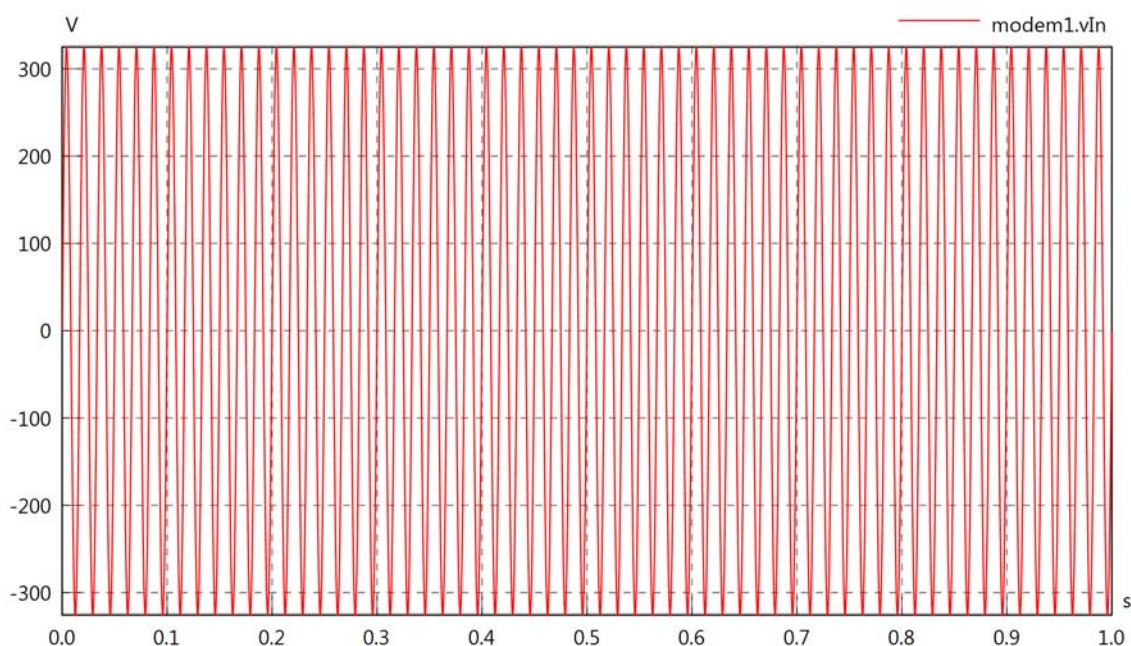

modem1.iIn

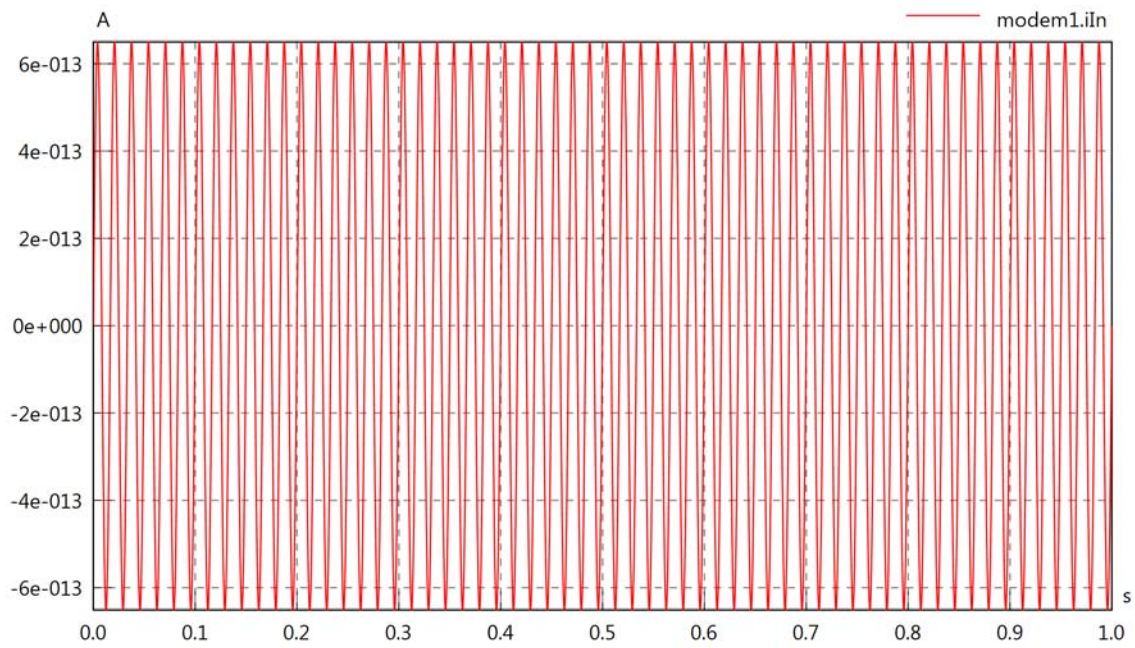

modem1.PIn

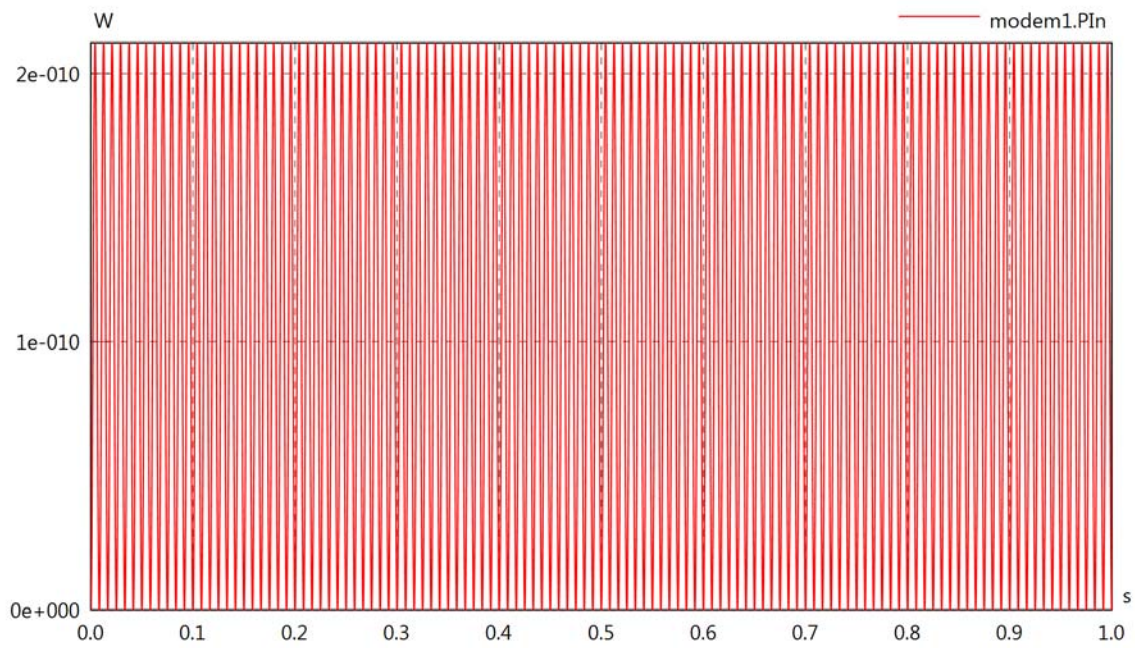
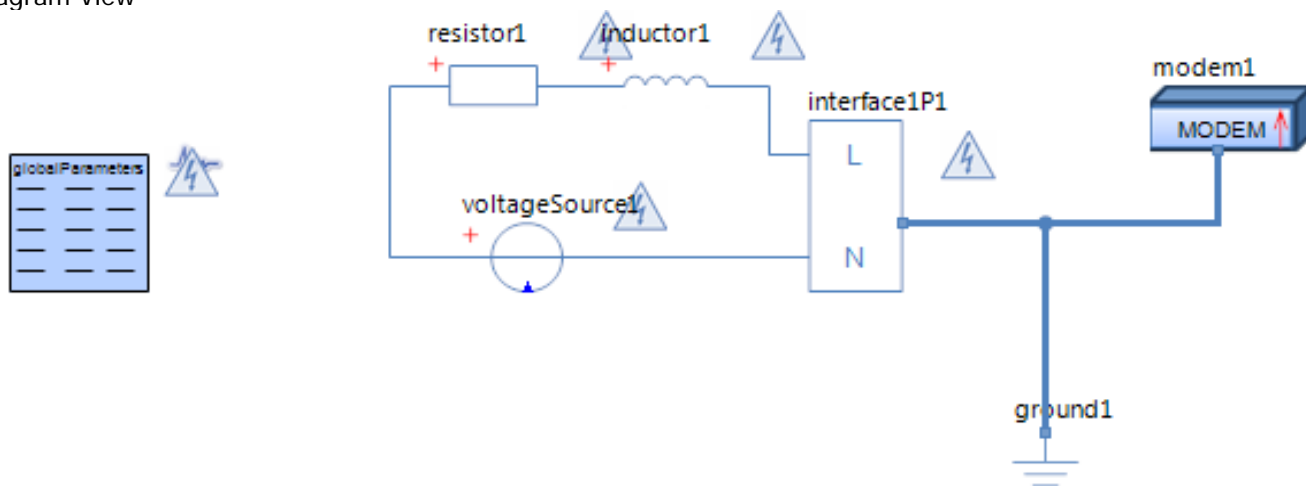

Diagram View



Resistor resistor1
Parameters

Comment	Name	Current Value	Unit
Resistance	R	1500	[Ohm]

Inductor inductor1
Parameters

Comment	Name	Current Value	Unit
Inductance	L	5	[mH]
Initial Value	i0	0 (Fixed)	[A]
Kind	kind	absolute	

Voltage Source voltageSource1
Parameters

Comment	Name	Current Value	Unit
Voltage	v_src	$\sqrt{2} * 230 * \sin(t * 2 * \pi * 120)$	[V]

modem1.vIn

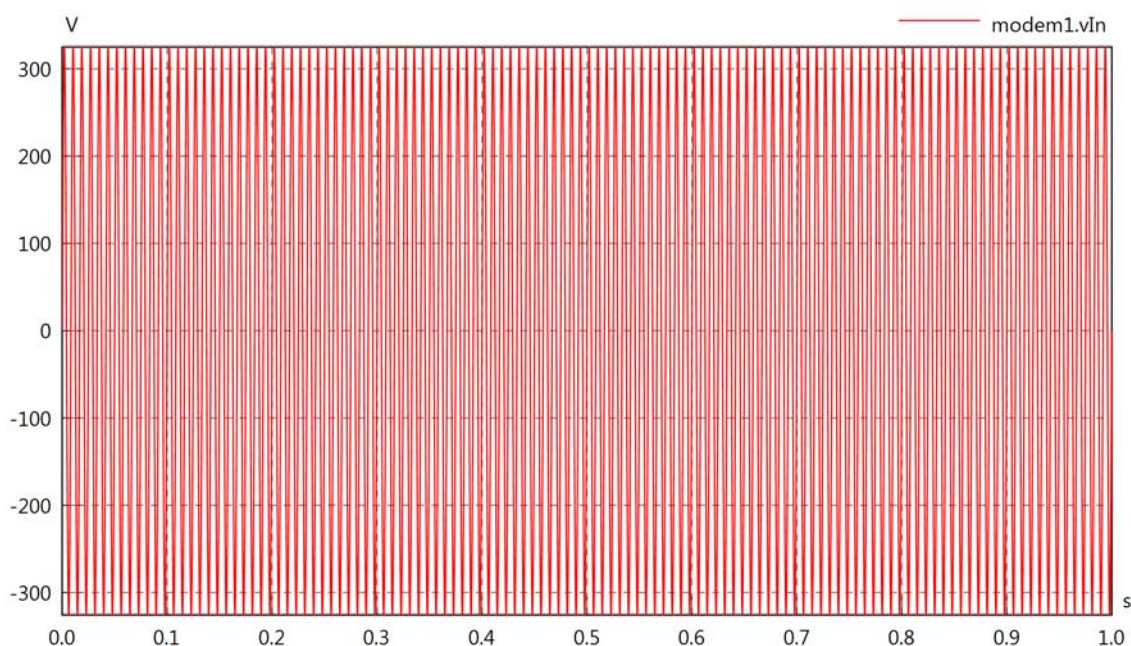

modem1.iIn

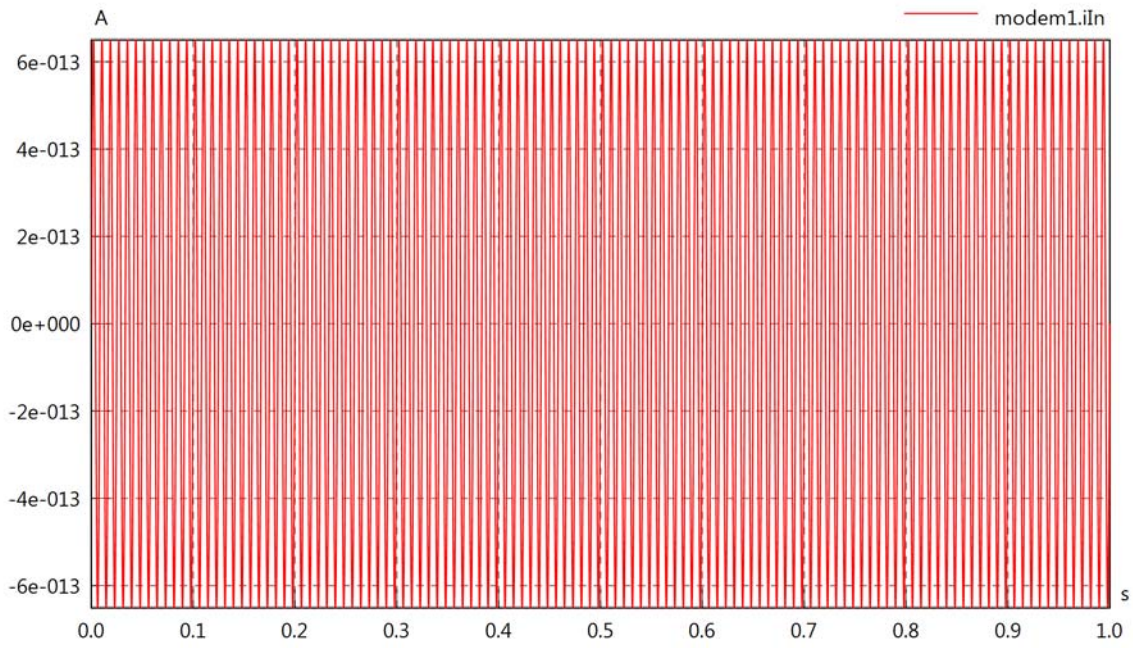

modem1.PIn

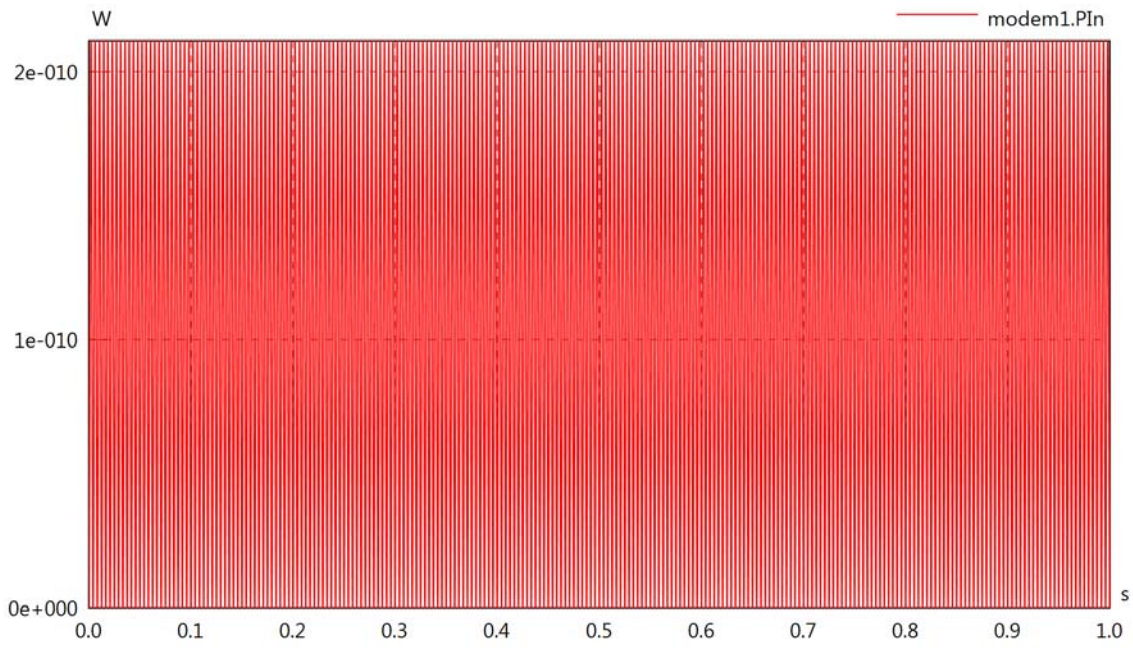
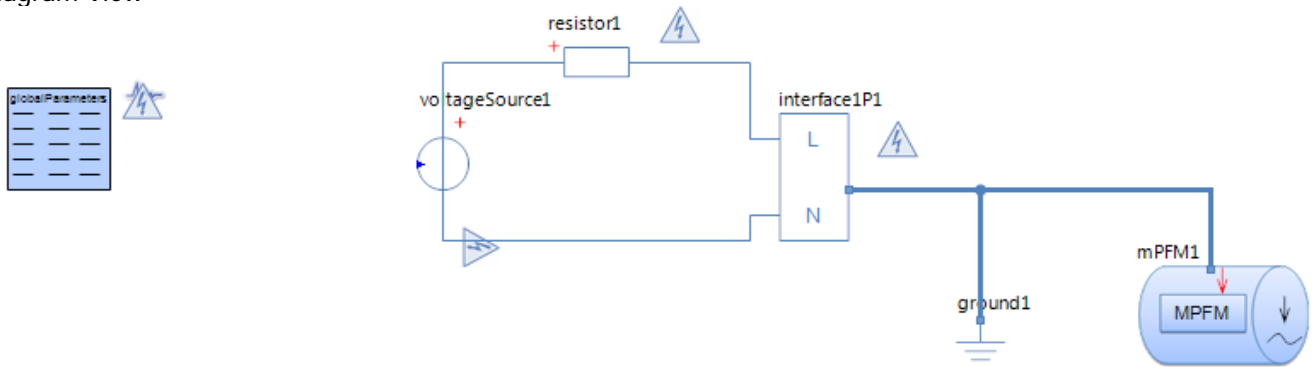

Diagram View



Multiphase Flow Meter mPFM1
Parameters

Comment	Name	Current Value	Unit
Simulate with internal Transformer	trafoOn	false	
MPFM Input Frequency	fIn	30	[Hz]
Constant or Variable Power	pType	Constant Power	
Output Power from PSU in MPFM	P	100	[VA]
PSU Power Factor	pf	0.7	[-]
PSU turn-off RMS Voltage	vMin	130	[V]
PSU turn-on RMS Voltage	vMax	180	[V]

Resistor resistor1
Parameters

Comment	Name	Current Value	Unit
Resistance	R	50	[Ohm]

Voltage Source voltageSource1
Parameters

Comment	Name	Current Value	Unit
Voltage	v_src	$230 \cdot \sqrt{2} \cdot \sin(2 \cdot \pi \cdot t \cdot 30)$	[V]

mPFM1.Rload

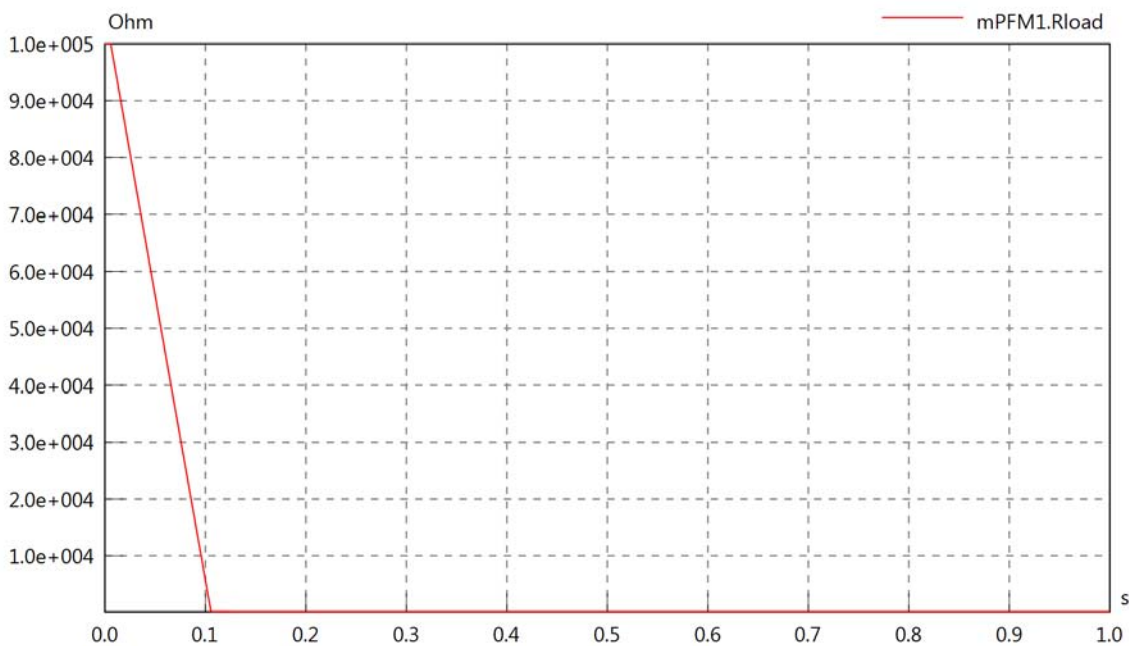

mPFM1.Load

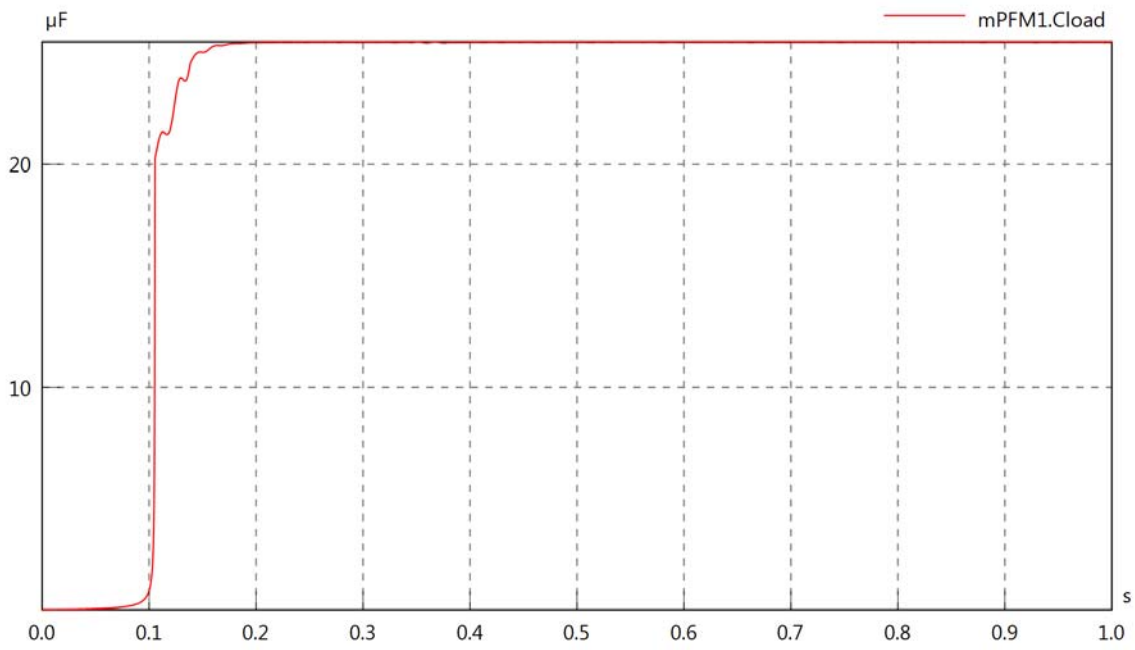

mPFM1.PsetX2

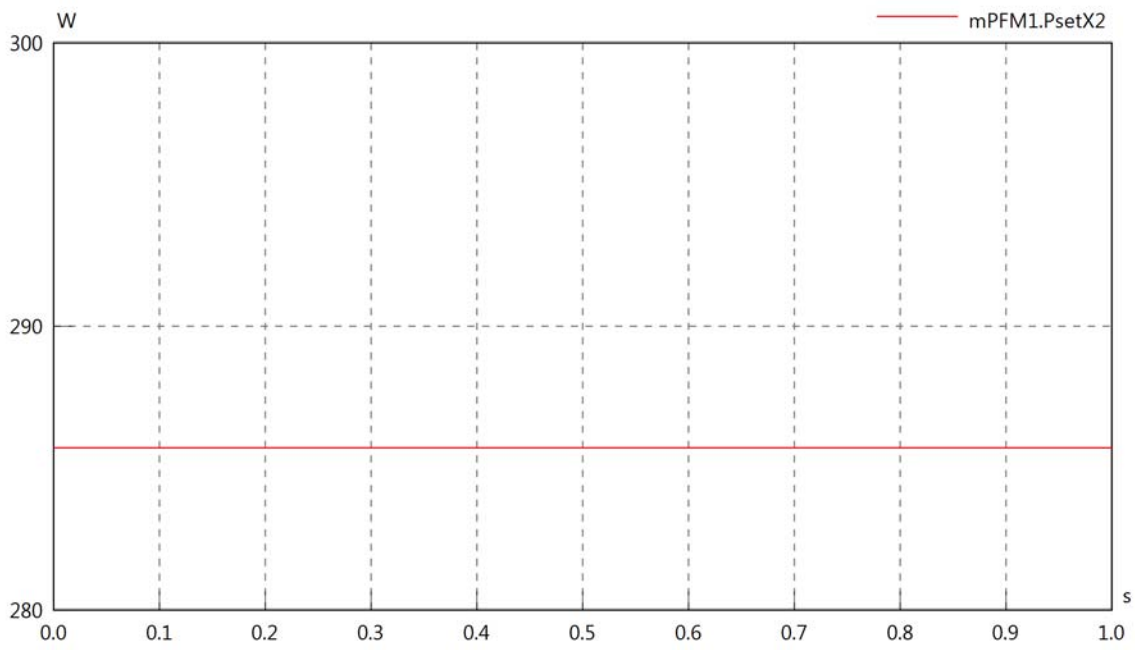

mPFM1.Pset

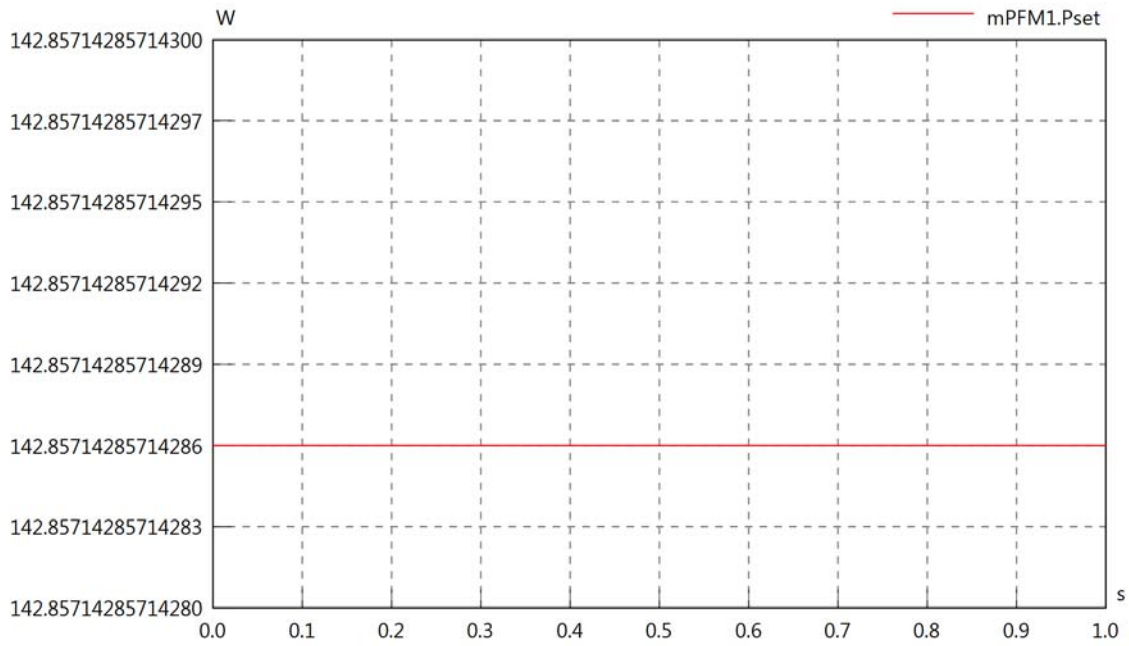

mPFM1.PCalc

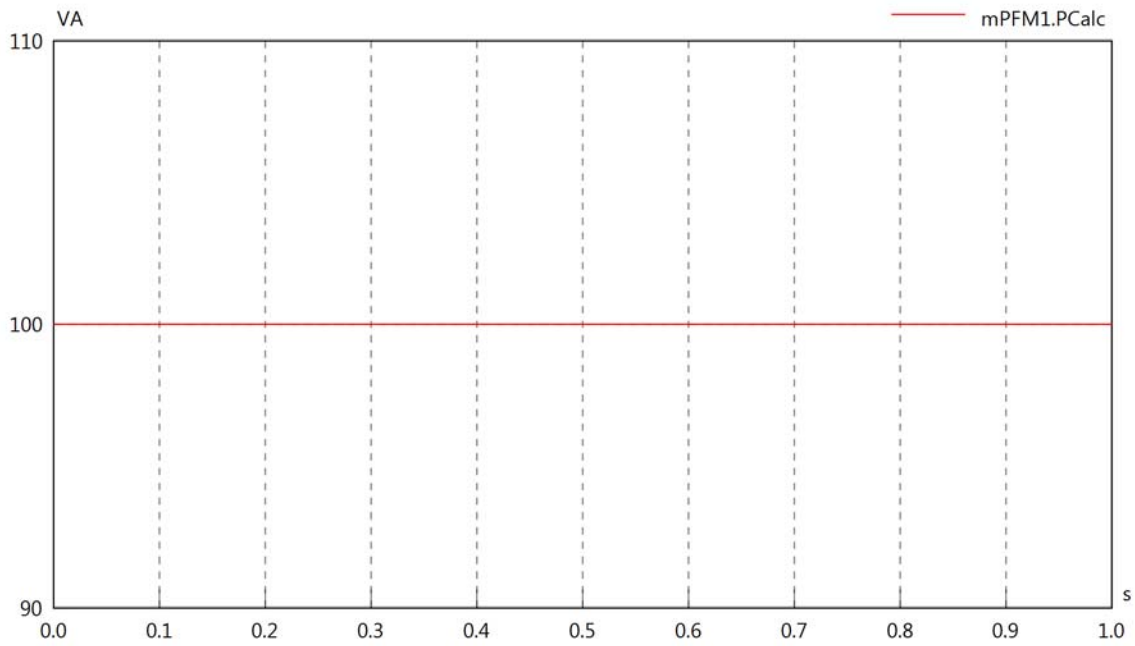

mPFM1.vIn

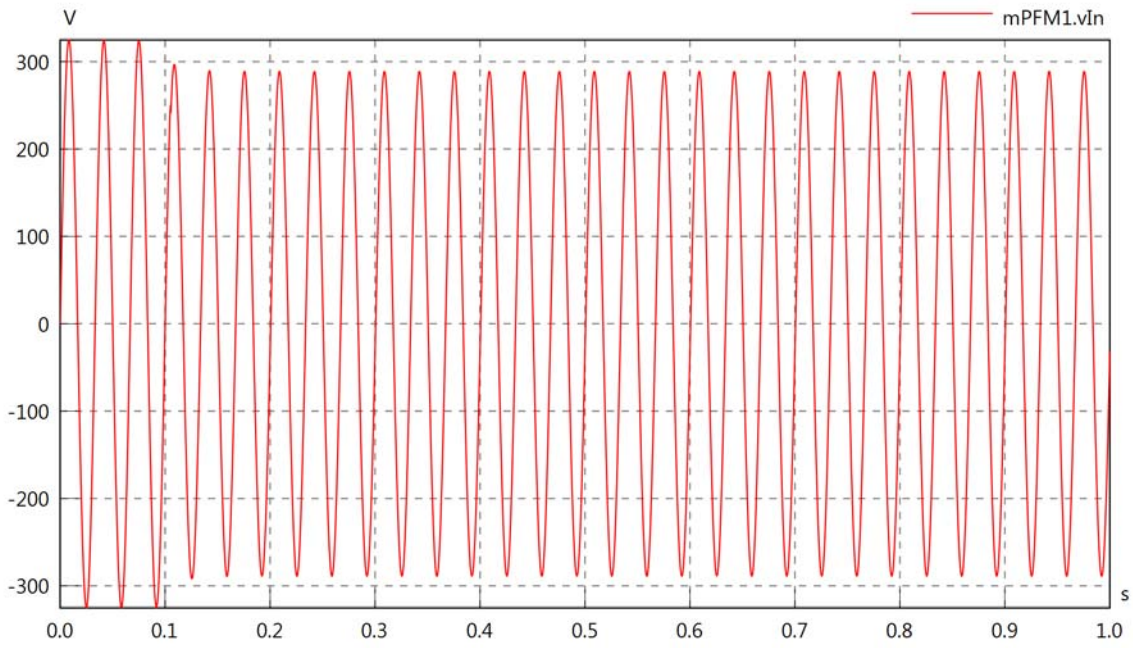

mPFM1.iIn

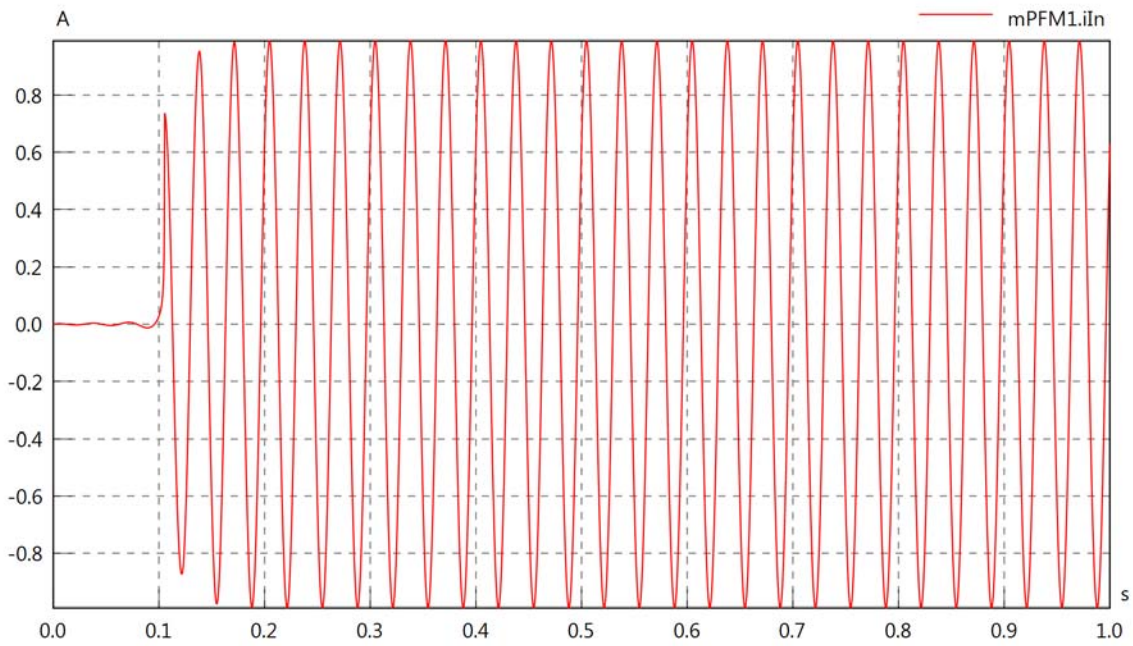

mPFM1.PI

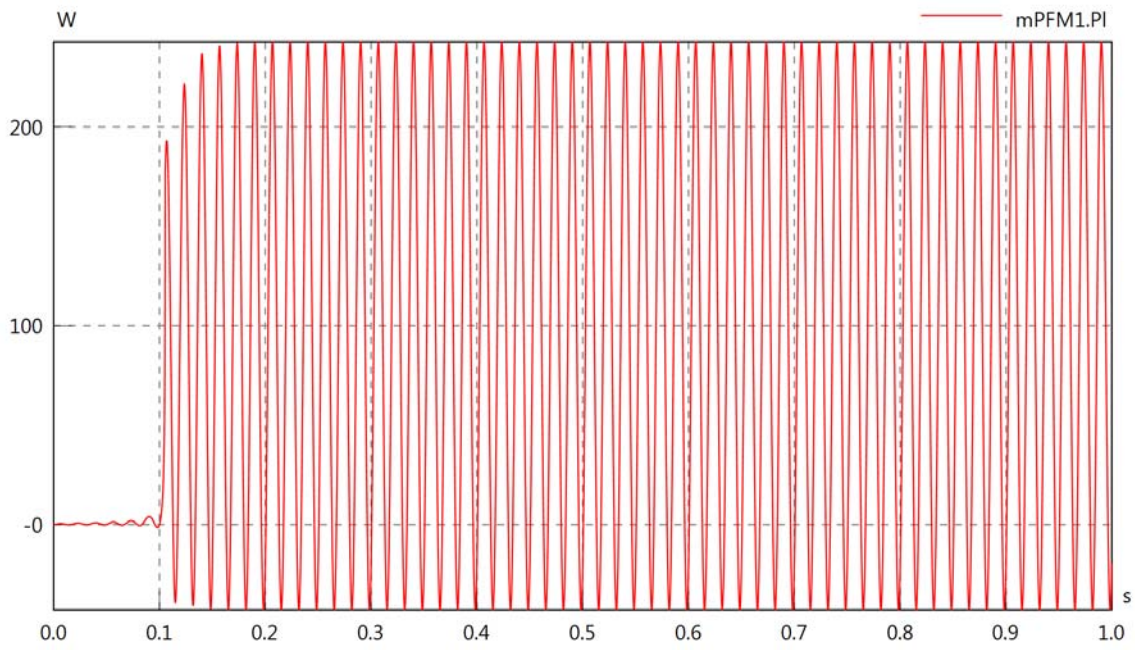

mPFM1.vLoad

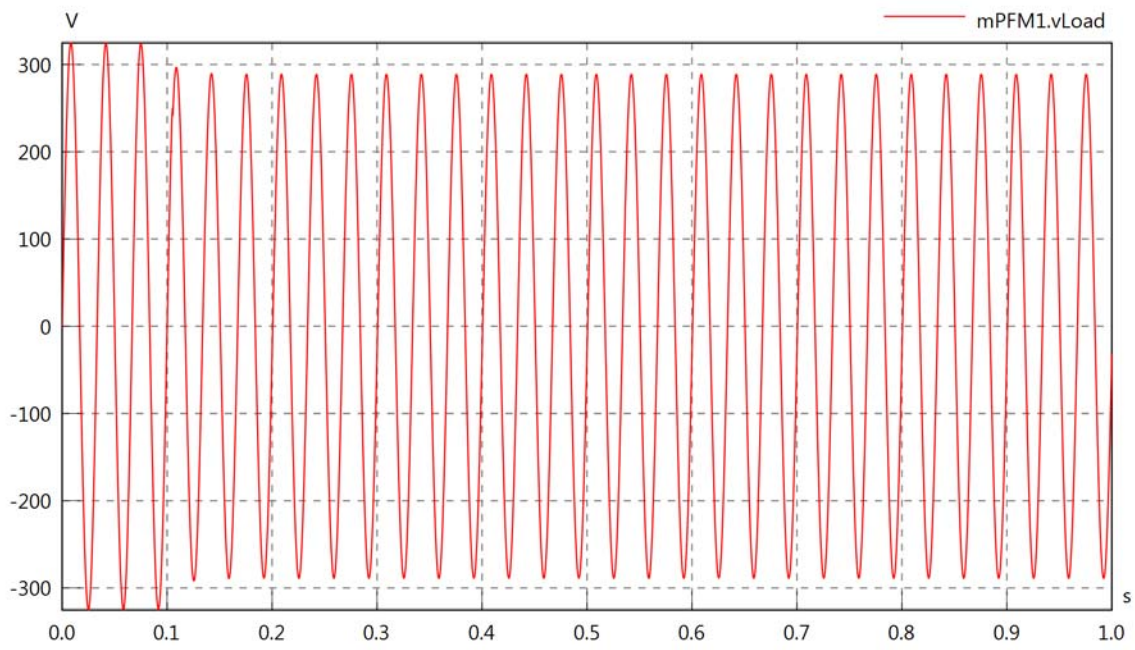

mPFM1.iLoad

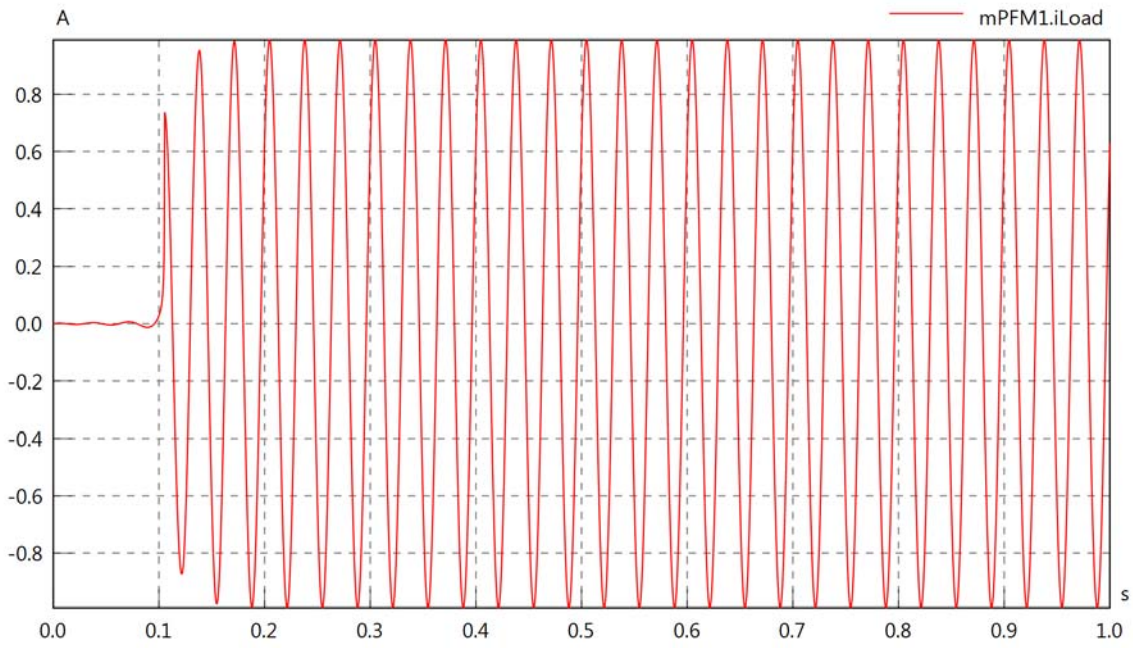

mPFM1.PIload

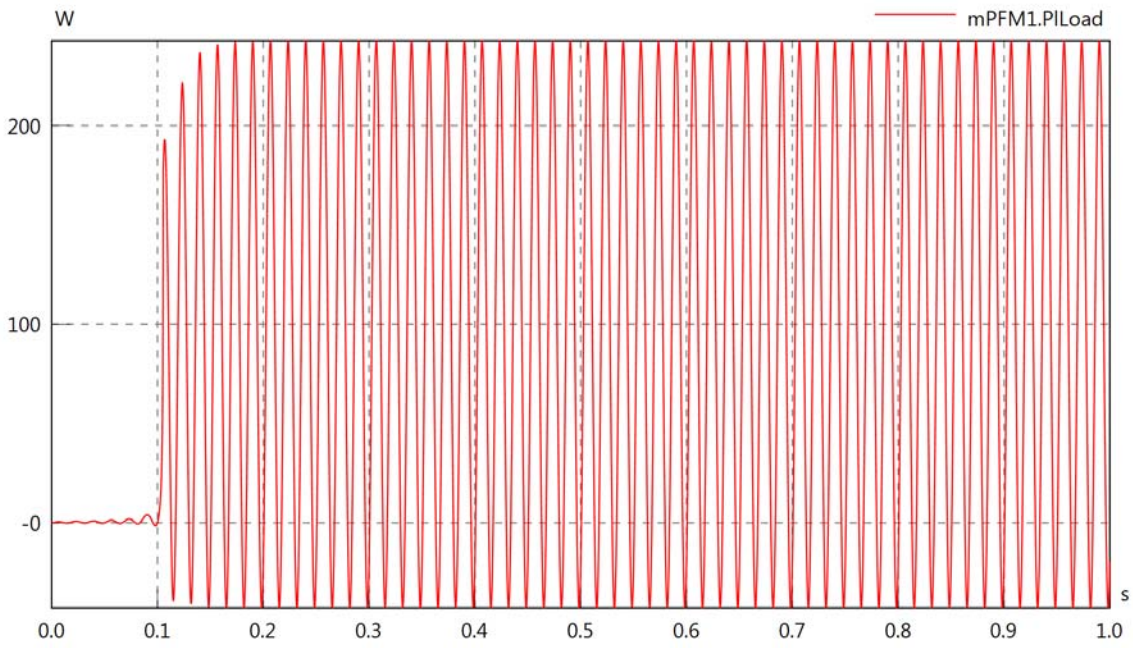
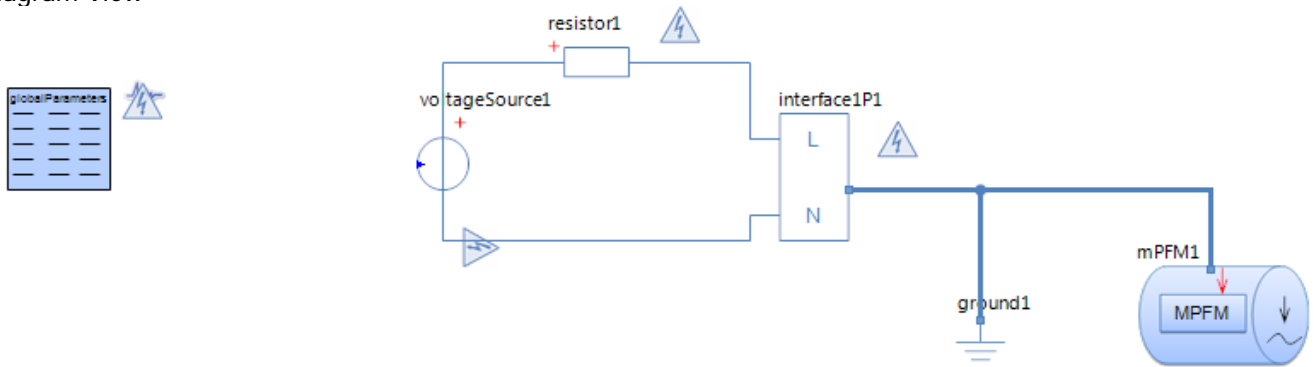

Diagram View



Multiphase Flow Meter mPFM1
Parameters

Comment	Name	Current Value	Unit
Simulate with internal Transformer	trafoOn	false	
MPFM Input Frequency	fIn	60	[Hz]
Constant or Variable Power	pType	Constant Power	
Output Power from PSU in MPFM	P	100	[VA]
PSU Power Factor	pf	0.7	[-]
PSU turn-off RMS Voltage	vMin	130	[V]
PSU turn-on RMS Voltage	vMax	180	[V]

Resistor resistor1
Parameters

Comment	Name	Current Value	Unit
Resistance	R	50	[Ohm]

Voltage Source voltageSource1
Parameters

Comment	Name	Current Value	Unit
Voltage	v_src	$230 \cdot \sqrt{2} \cdot \sin(2 \cdot \pi \cdot t \cdot 60)$	[V]

mPFM1.Rload

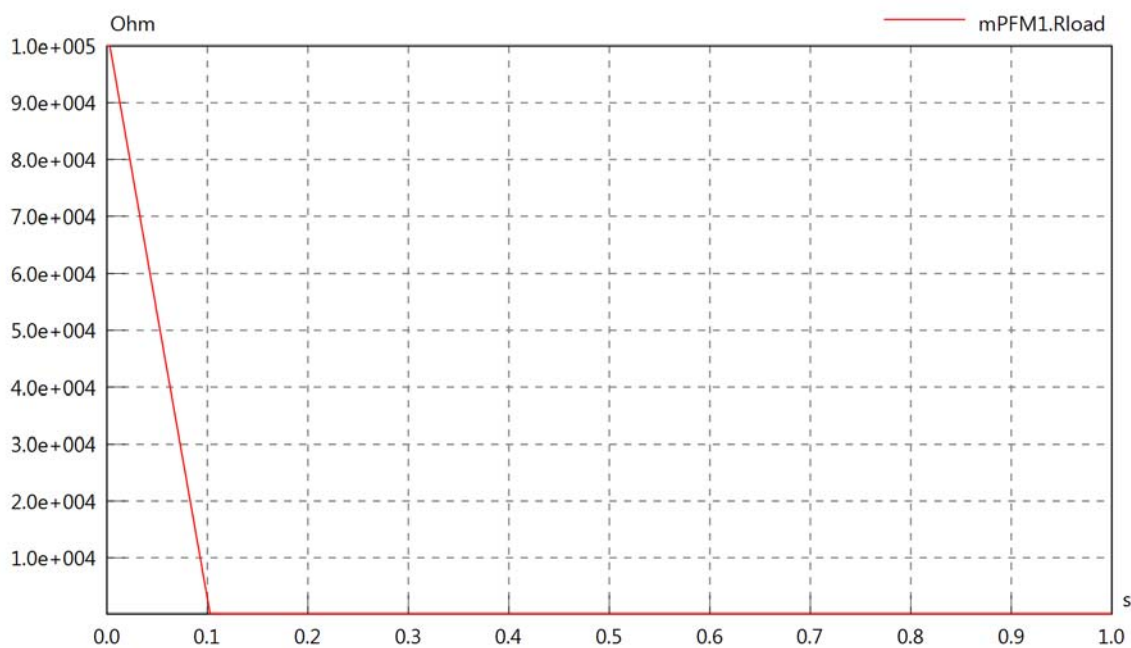

mPFM1.Cload

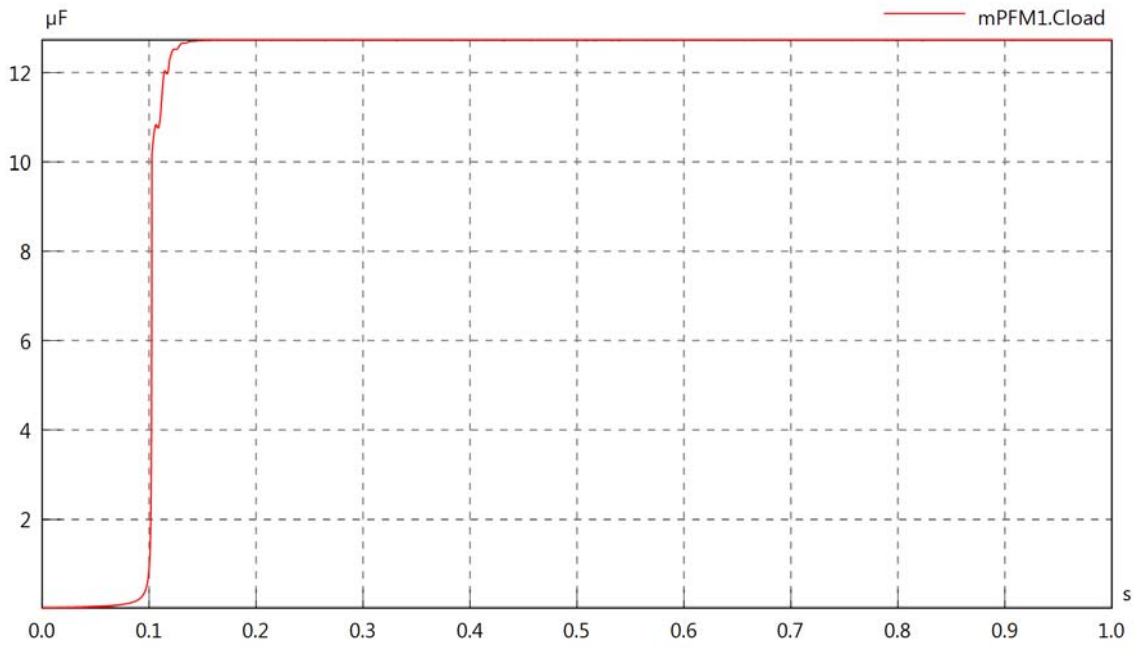

mPFM1.PsetX2

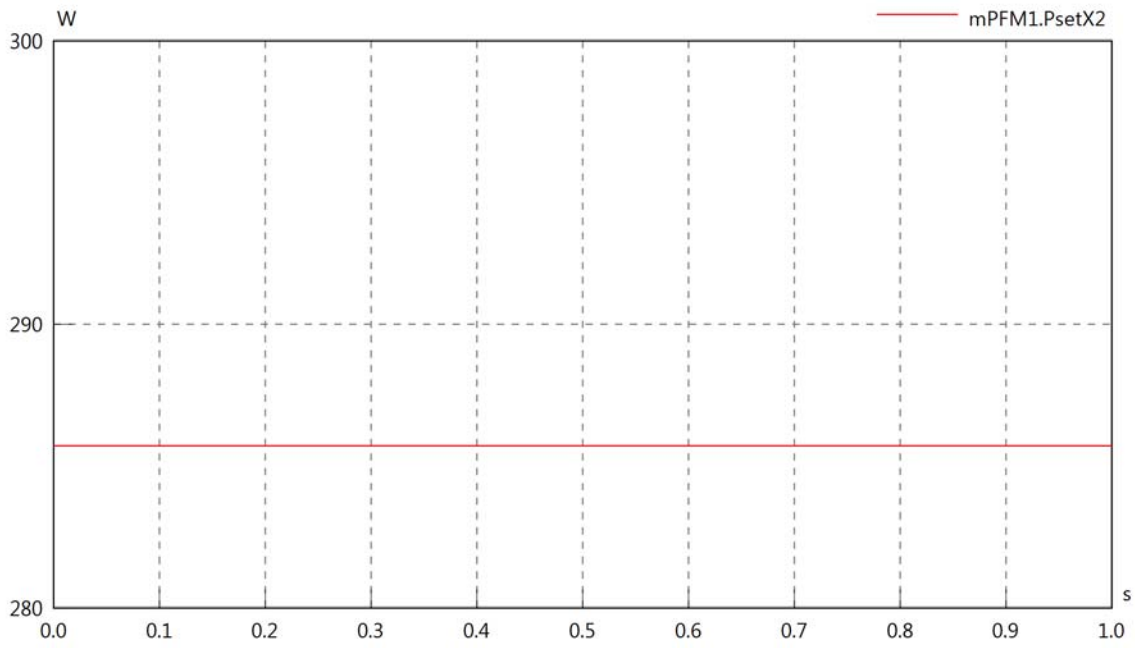

mPFM1.Pset

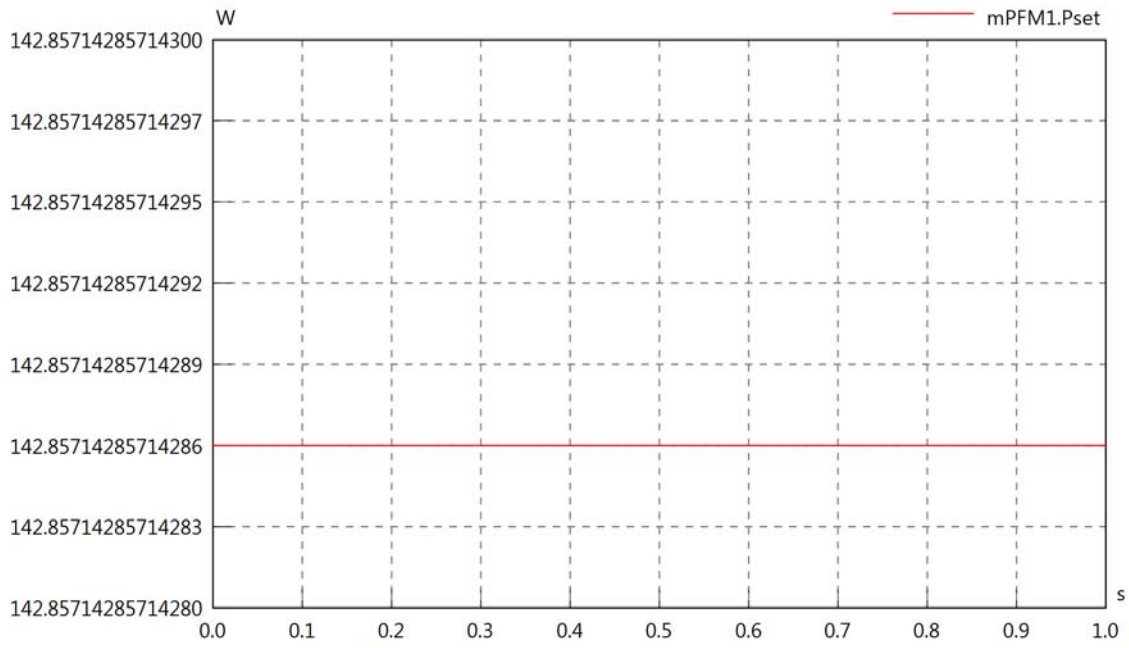

mPFM1.PCalc

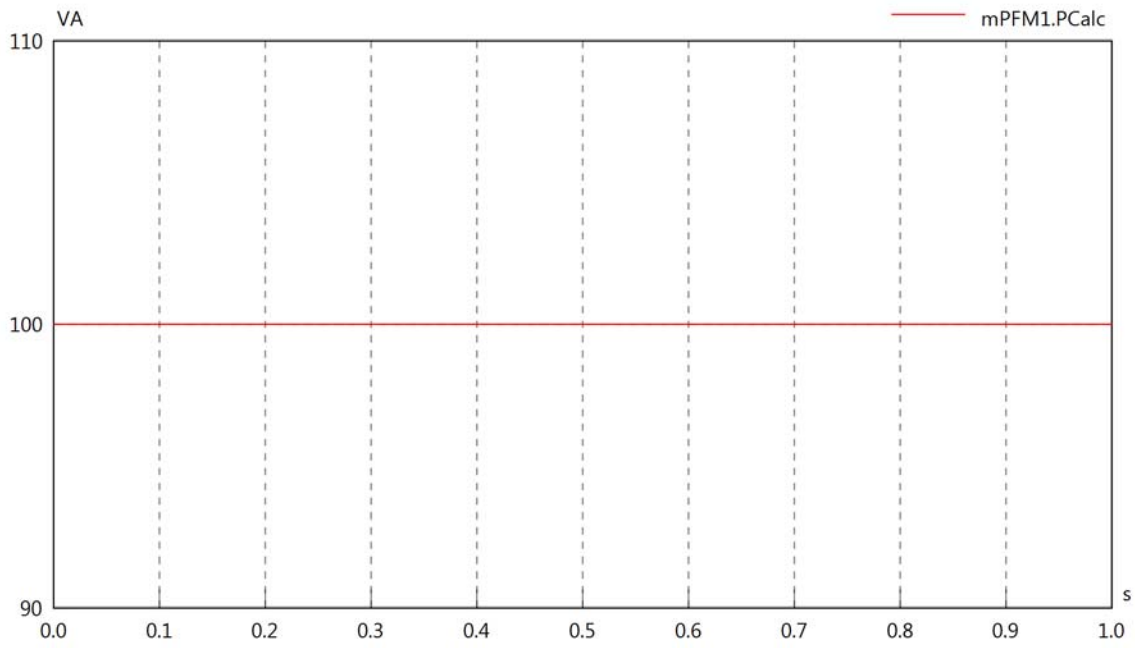

mPFM1.vIn

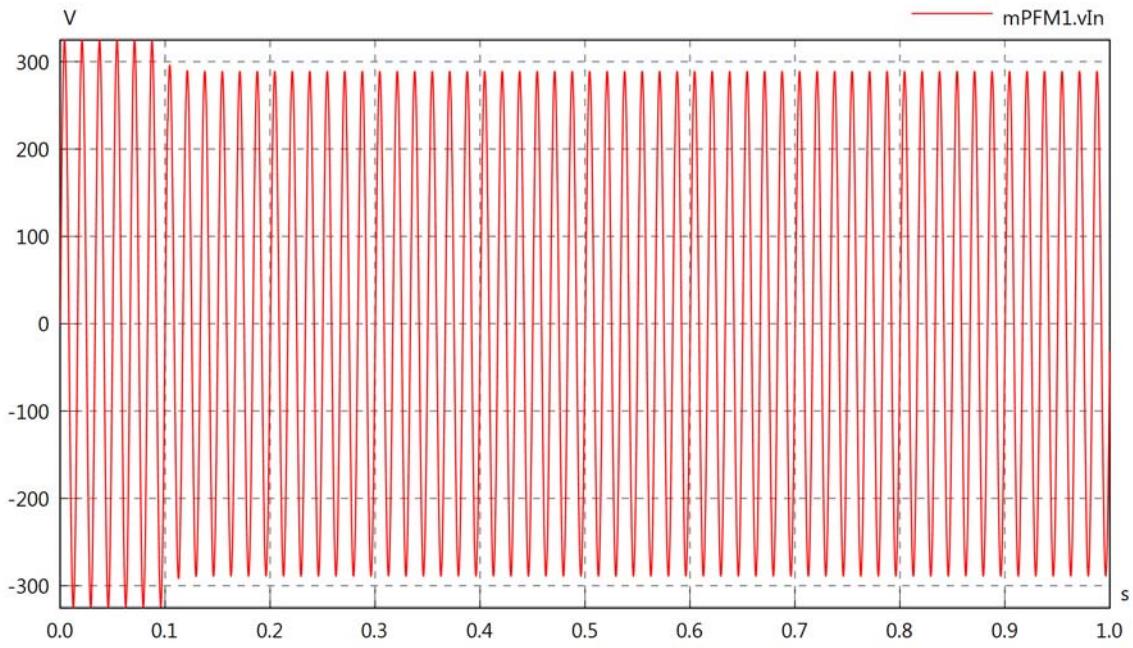

mPFM1.iIn

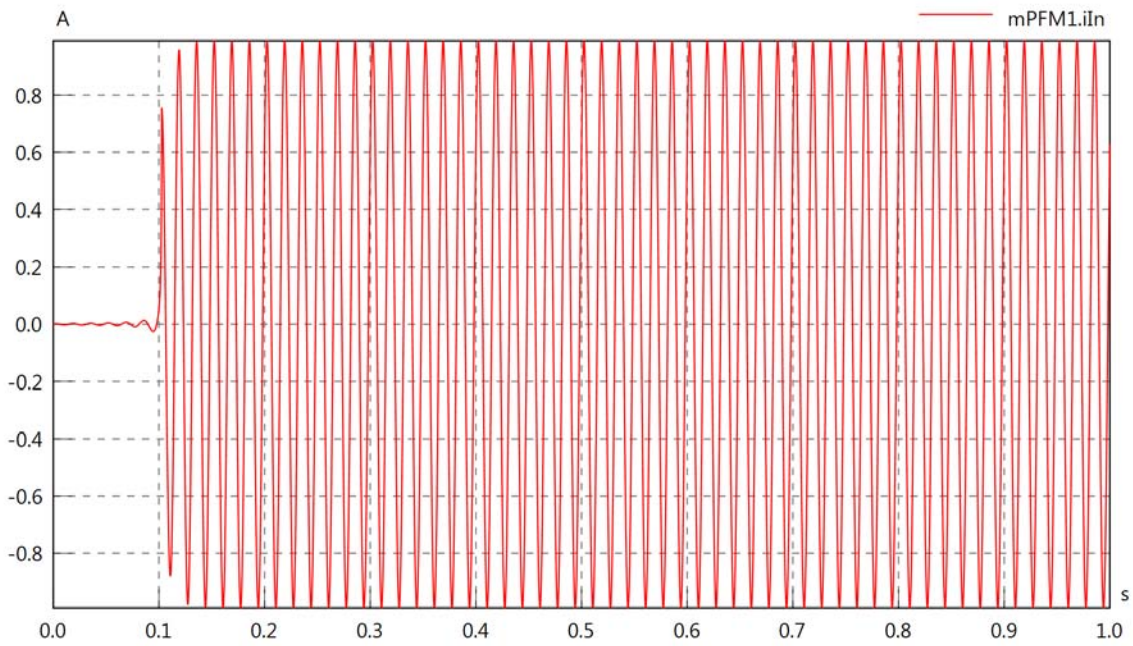

mPFM1.PI

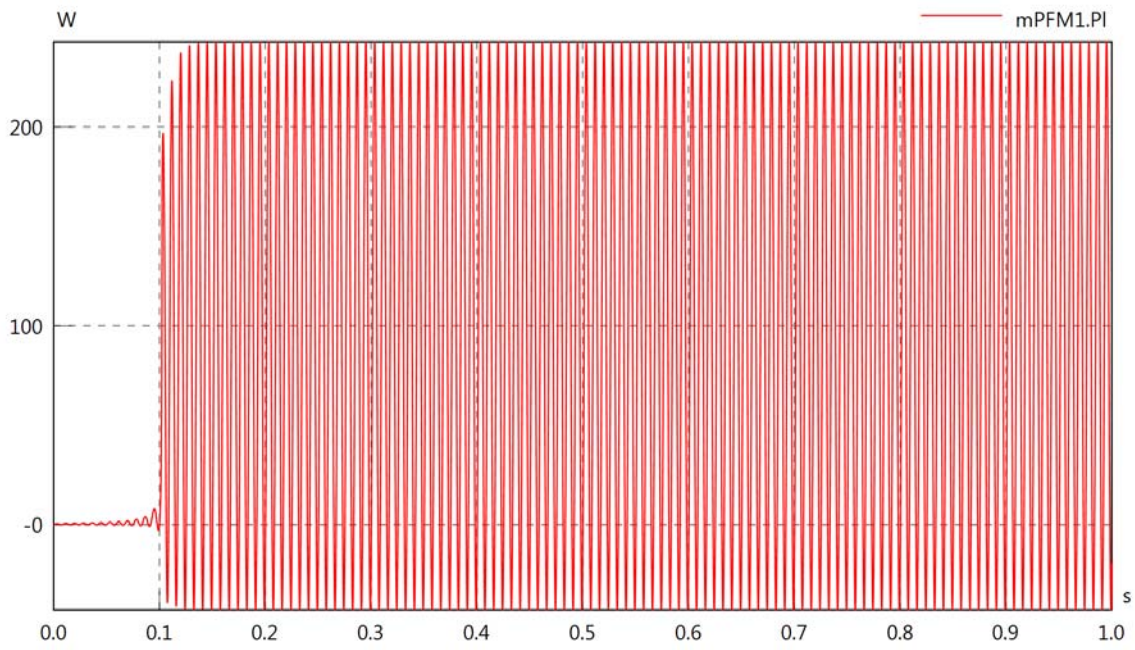

mPFM1.vLoad

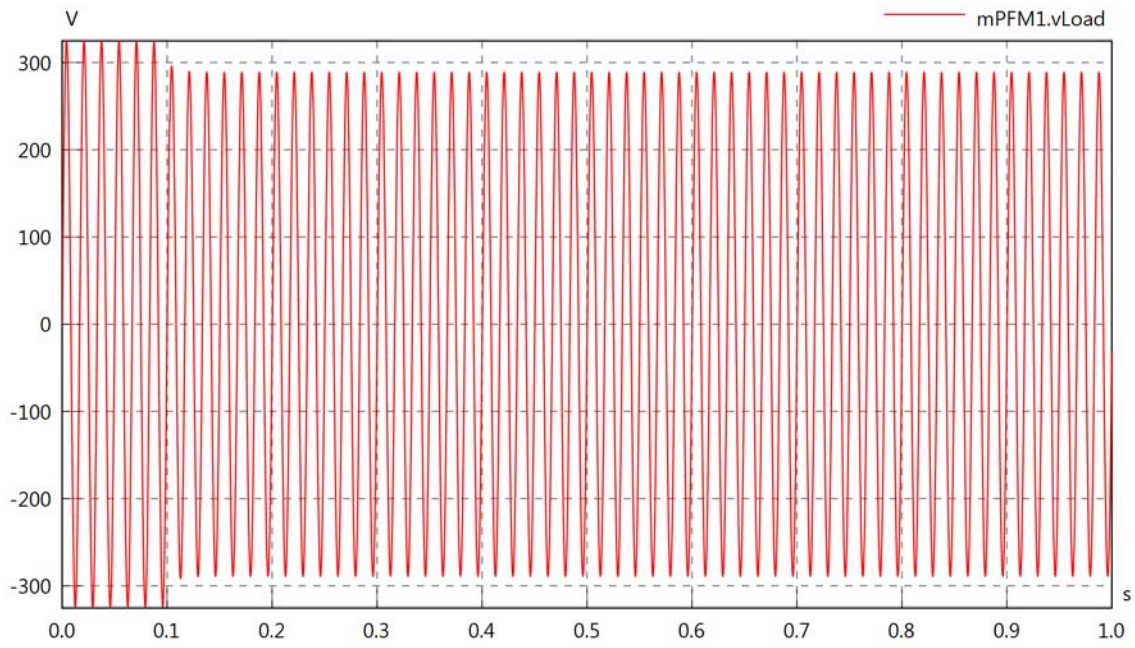

mPFM1.iLoad

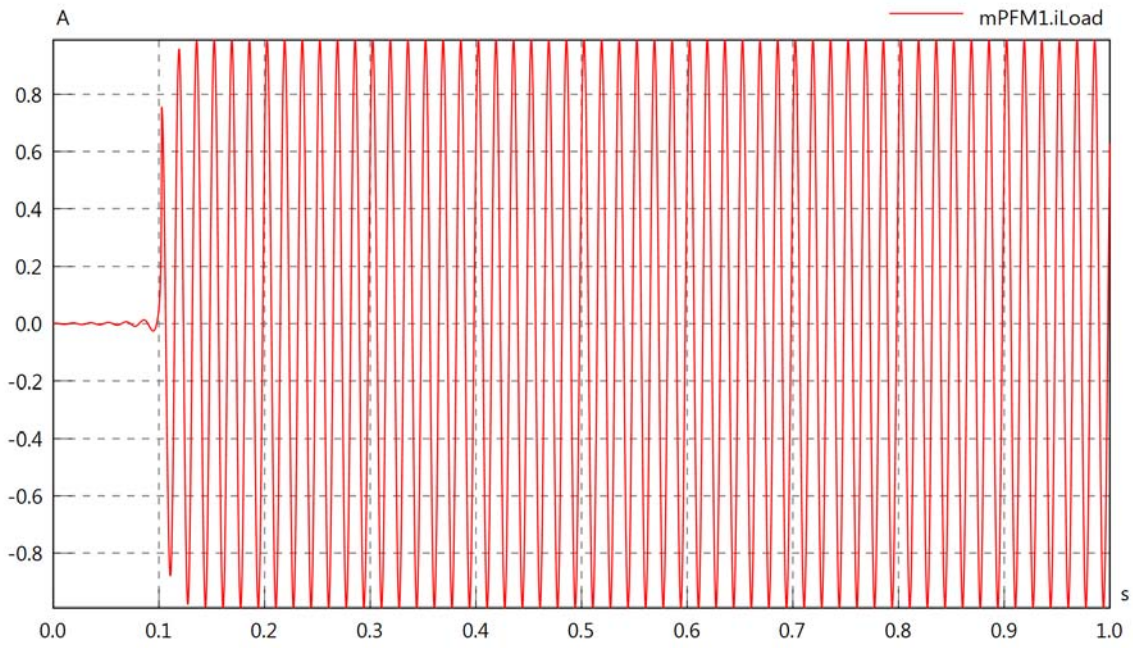

mPFM1.PIload

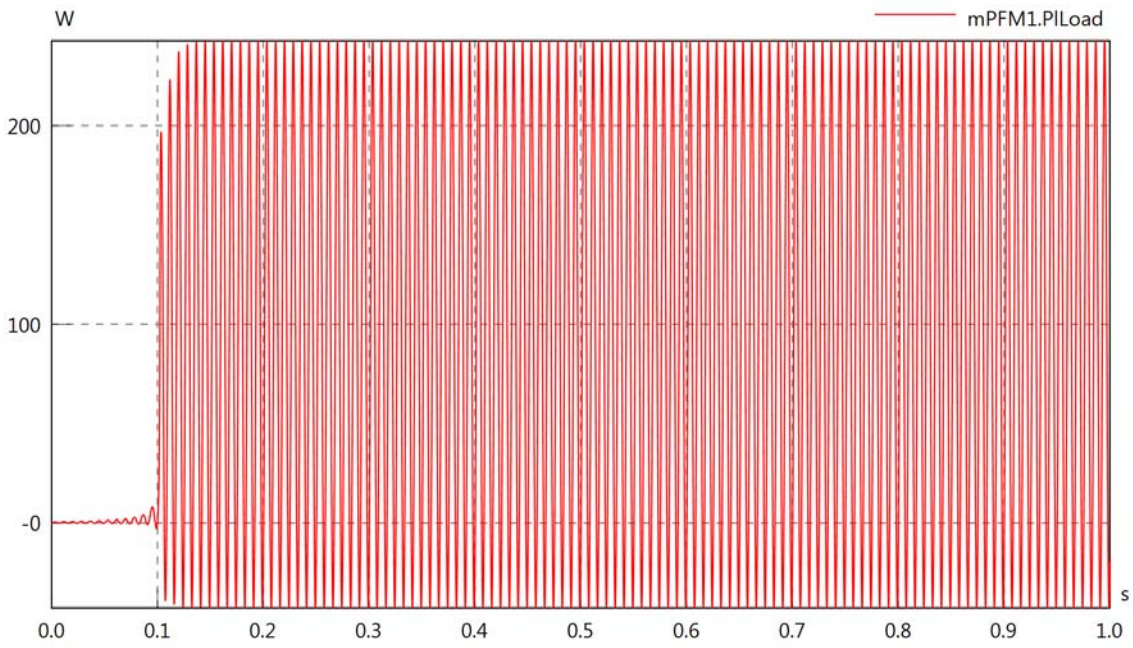
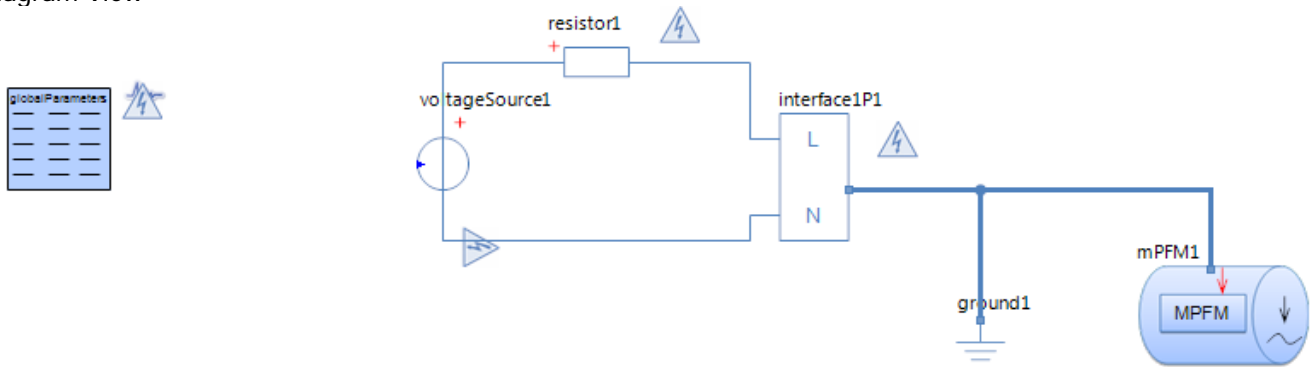

Diagram View



Multiphase Flow Meter mPFM1
Parameters

Comment	Name	Current Value	Unit
Simulate with internal Transformer	trafoOn	false	
MPFM Input Frequency	fIn	120	[Hz]
Constant or Variable Power	pType	Constant Power	
Output Power from PSU in MPFM	P	100	[VA]
PSU Power Factor	pf	0.7	[-]
PSU turn-off RMS Voltage	vMin	130	[V]
PSU turn-on RMS Voltage	vMax	180	[V]

Resistor resistor1
Parameters

Comment	Name	Current Value	Unit
Resistance	R	50	[Ohm]

Voltage Source voltageSource1
Parameters

Comment	Name	Current Value	Unit
Voltage	v_src	$230 \cdot \sqrt{2} \cdot \sin(2 \cdot \pi \cdot t \cdot 120)$	[V]

mPFM1.Rload

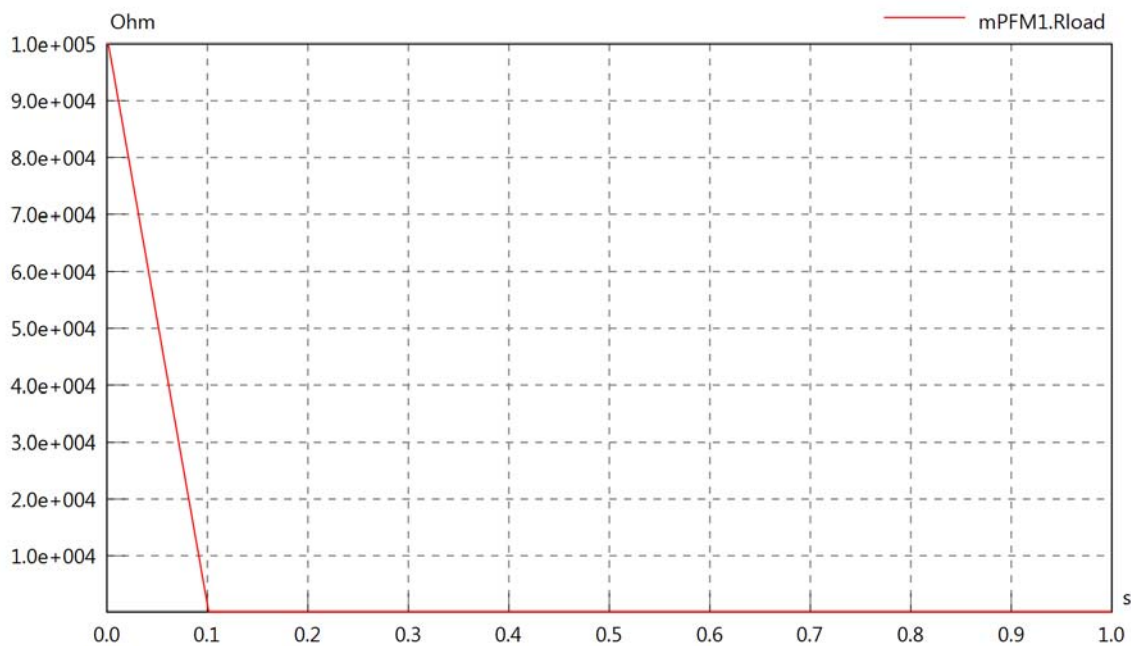

mPFM1.Cload

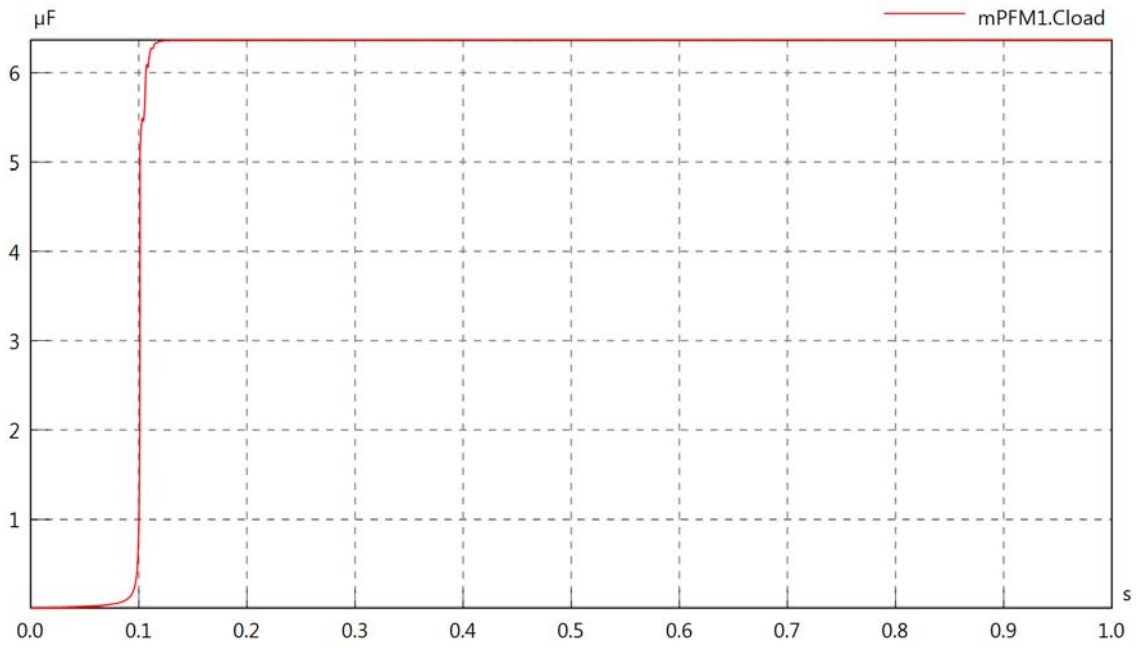

mPFM1.PsetX2

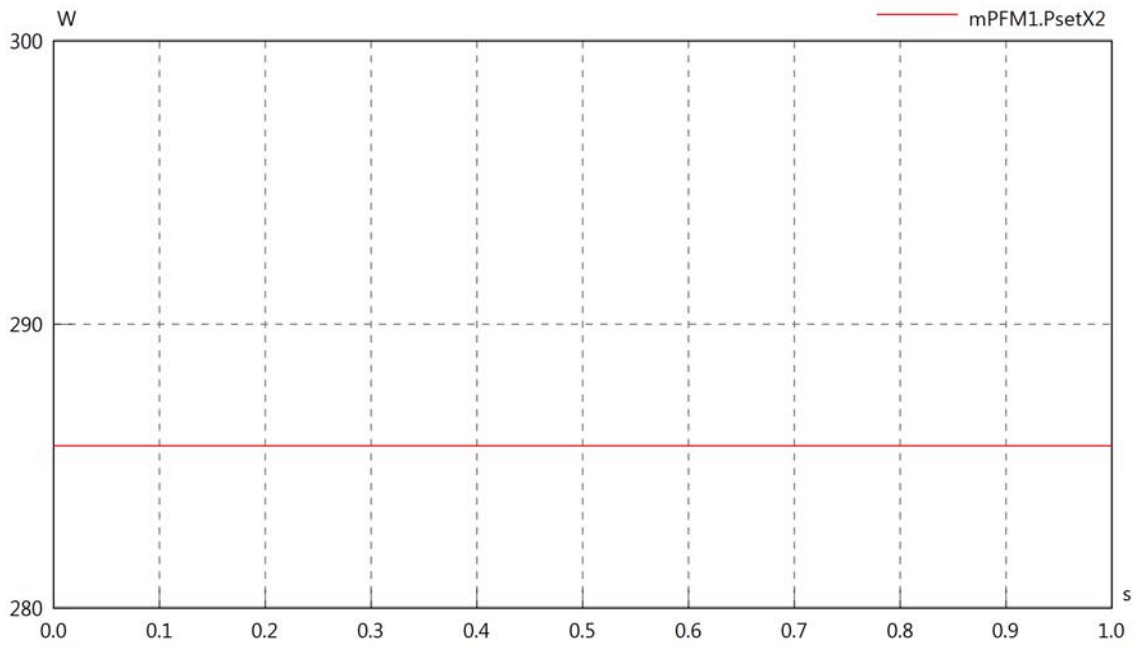

mPFM1.Pset

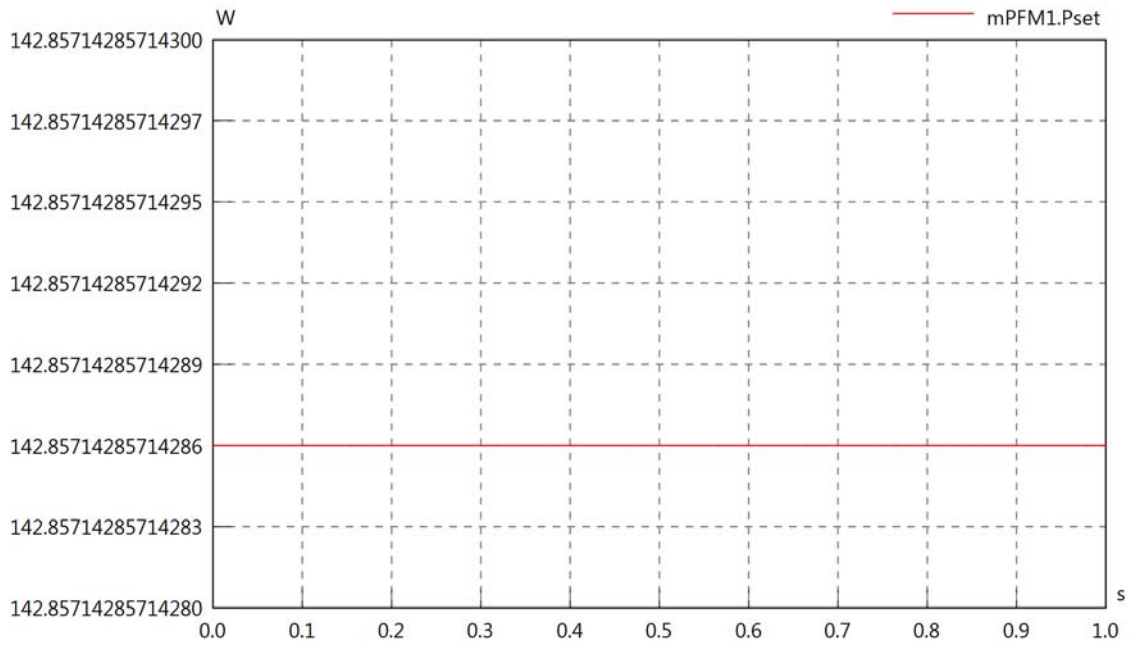

mPFM1.PCalc

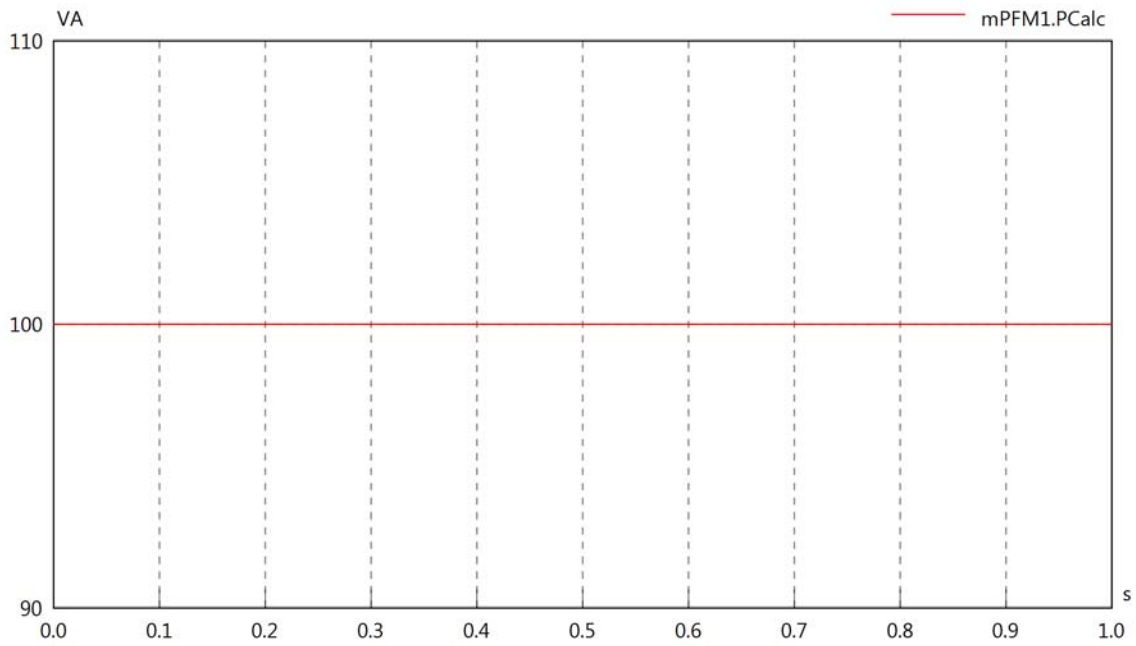

mPFM1.vIn

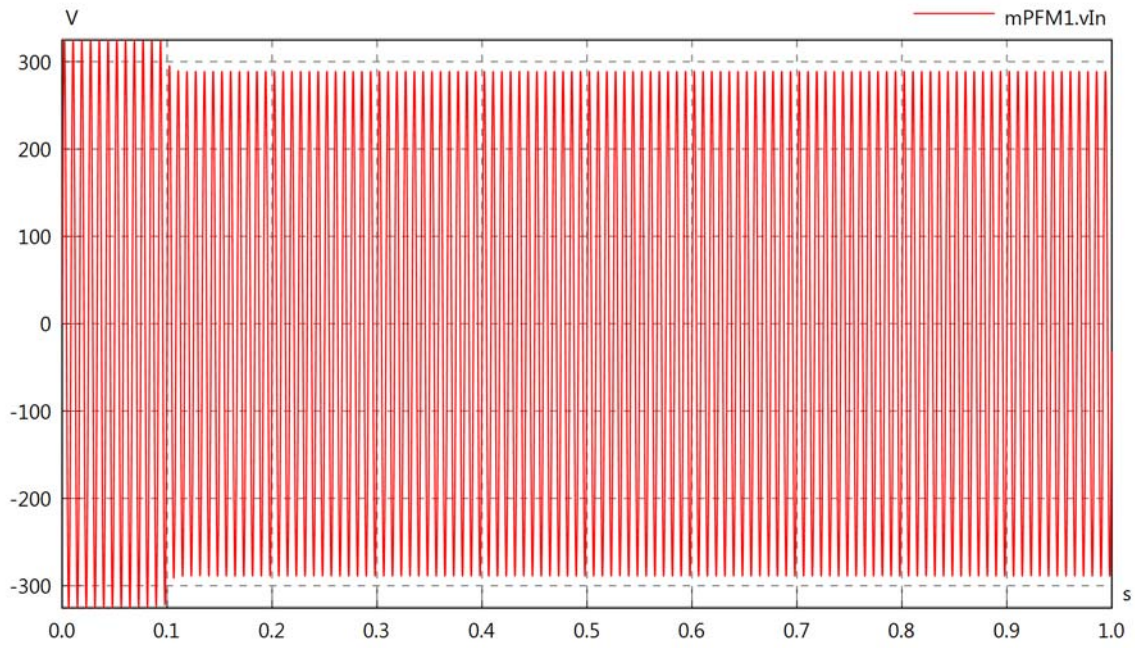

mPFM1.iIn

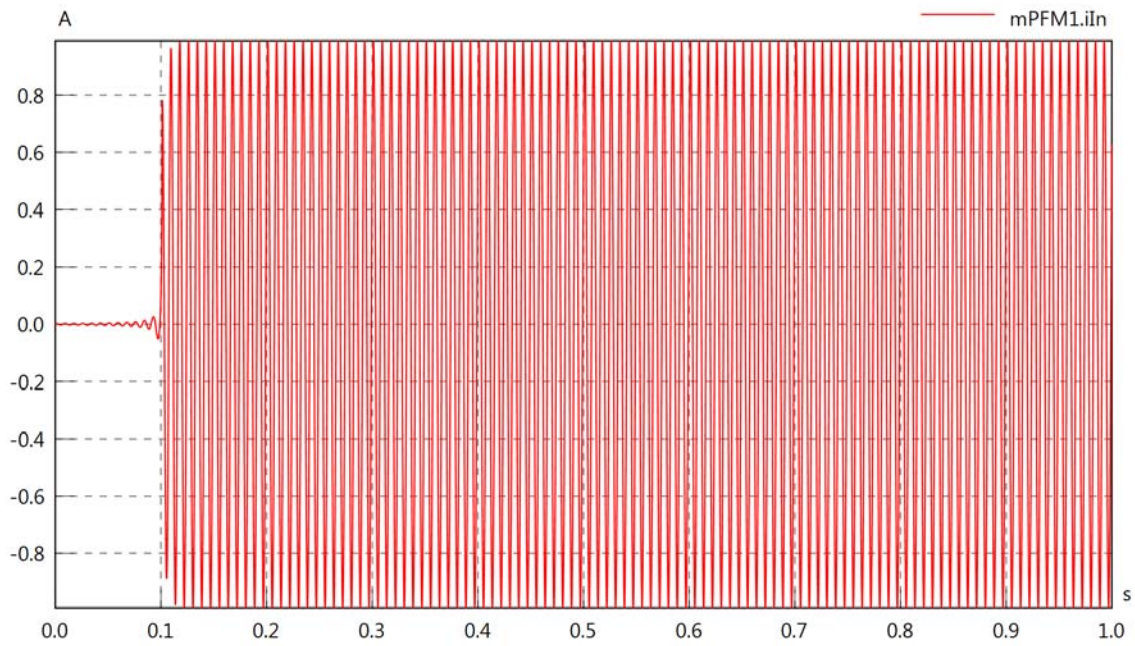

mPFM1.PI

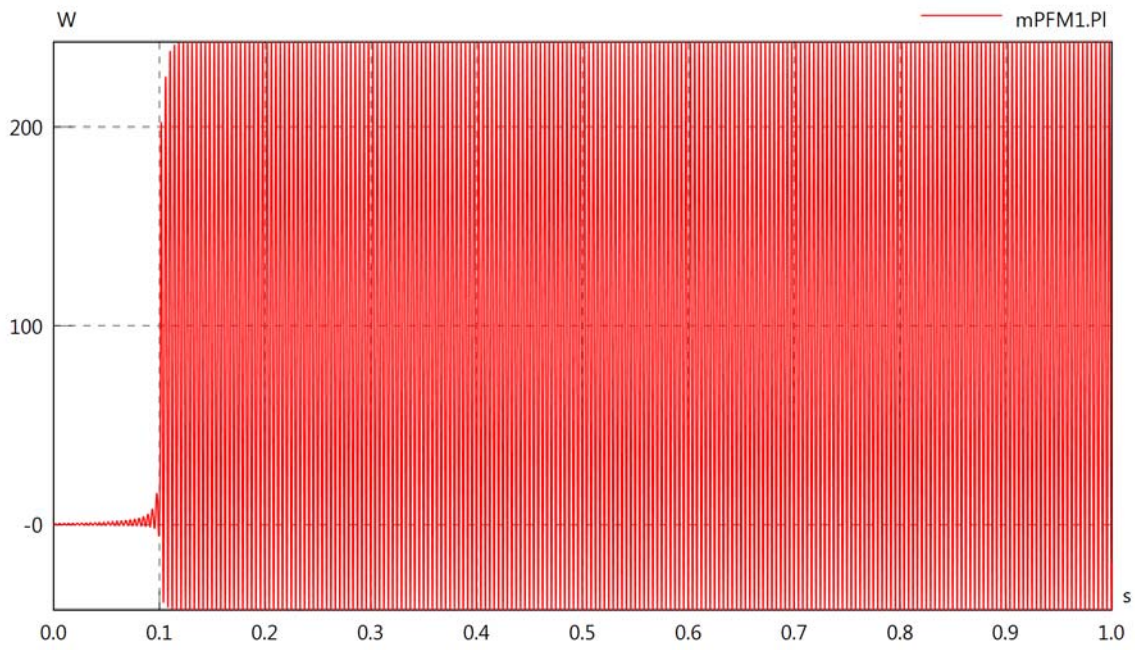

mPFM1.vLoad

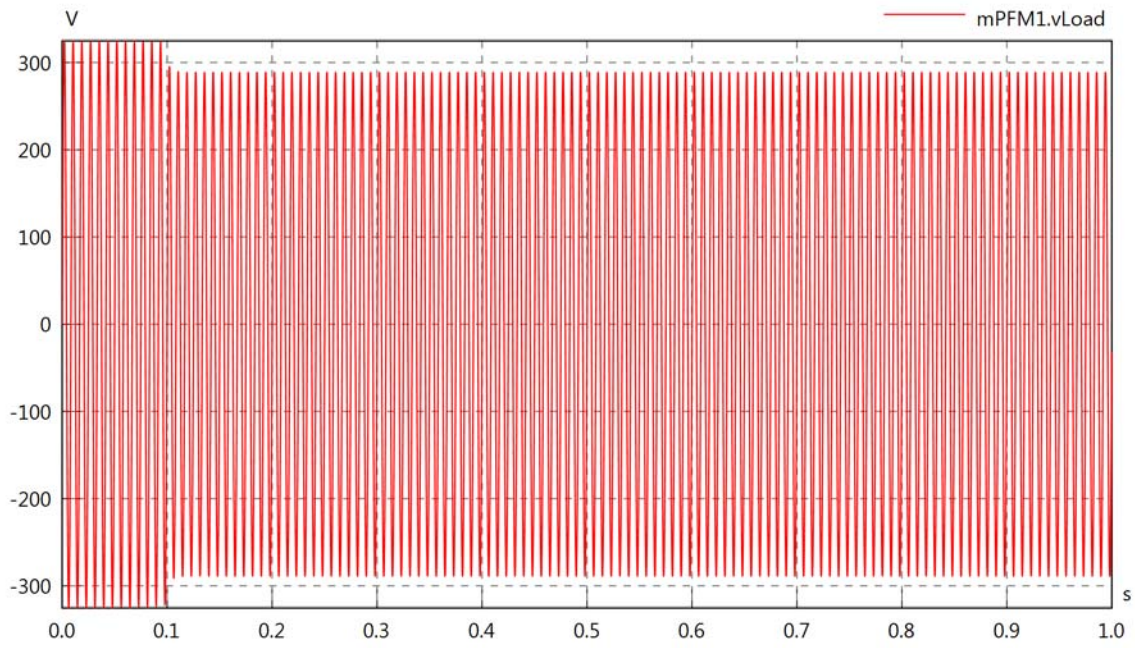

mPFM1.iLoad

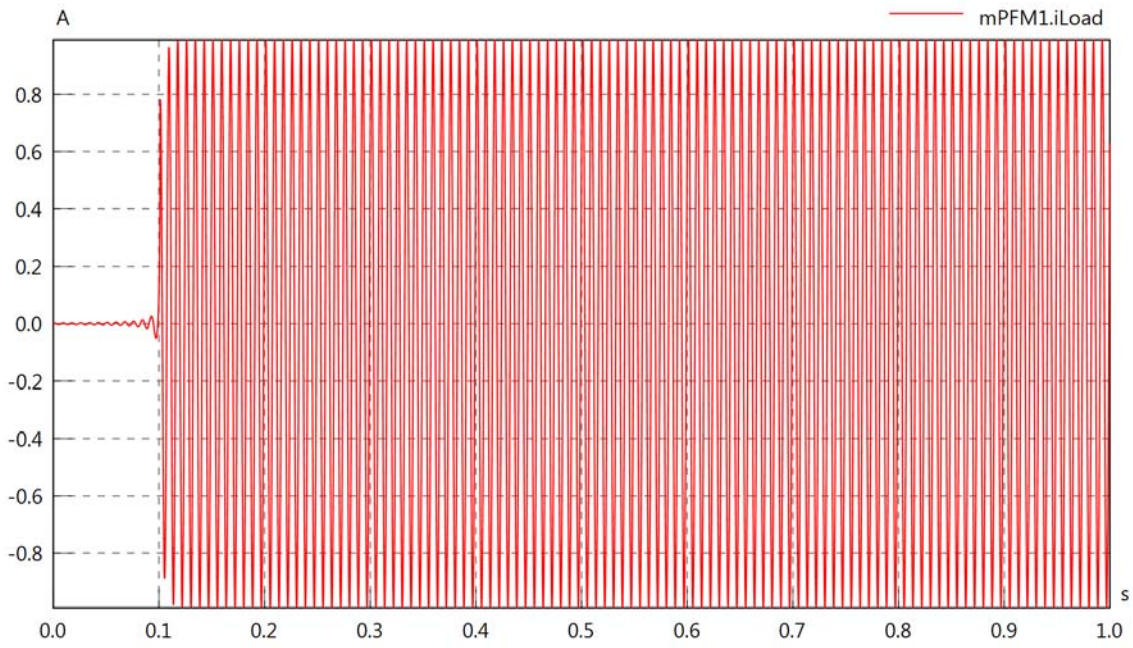

mPFM1.PILoad

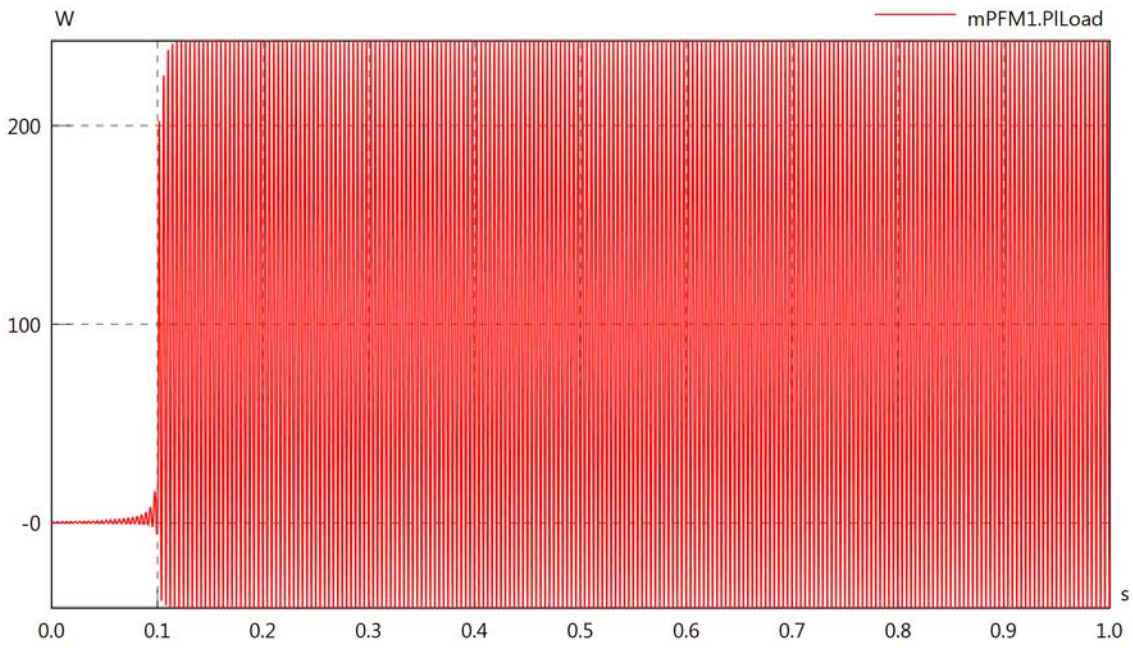
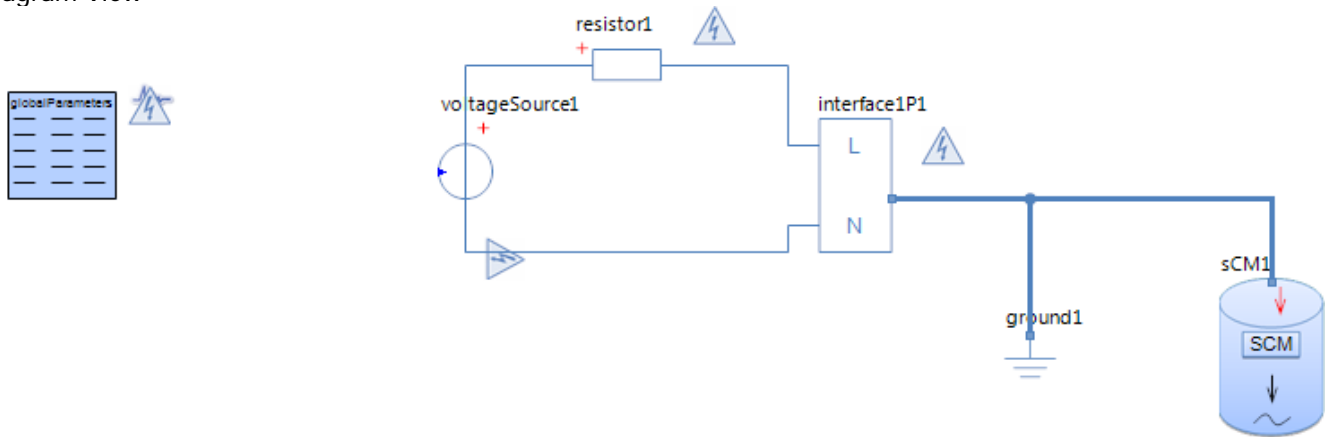

Diagram View



Resistor resistor1
Parameters

Comment	Name	Current Value	Unit
Resistance	R	50	[Ohm]

Voltage Source voltageSource1
Parameters

Comment	Name	Current Value	Unit
Voltage	v_src	$230 \cdot \sqrt{2} \cdot \sin(2 \cdot \pi \cdot t \cdot 30)$	[V]

Subsea Control Module sCM1
Parameters

Comment	Name	Current Value	Unit
Simulate with internal Transformer	trafoOn	false	
SCM Input Frequency	fIn	30	[Hz]
Constant or Variable Power	pType	Constant Power	
Output Power from PSU in SCM	P	100	[VA]
PSU Power Factor	pf	0.7	[-]
PSU turn-off RMS Voltage	vMin	130	[V]
PSU turn-on RMS Voltage	vMax	180	[V]

sCM1.Rload

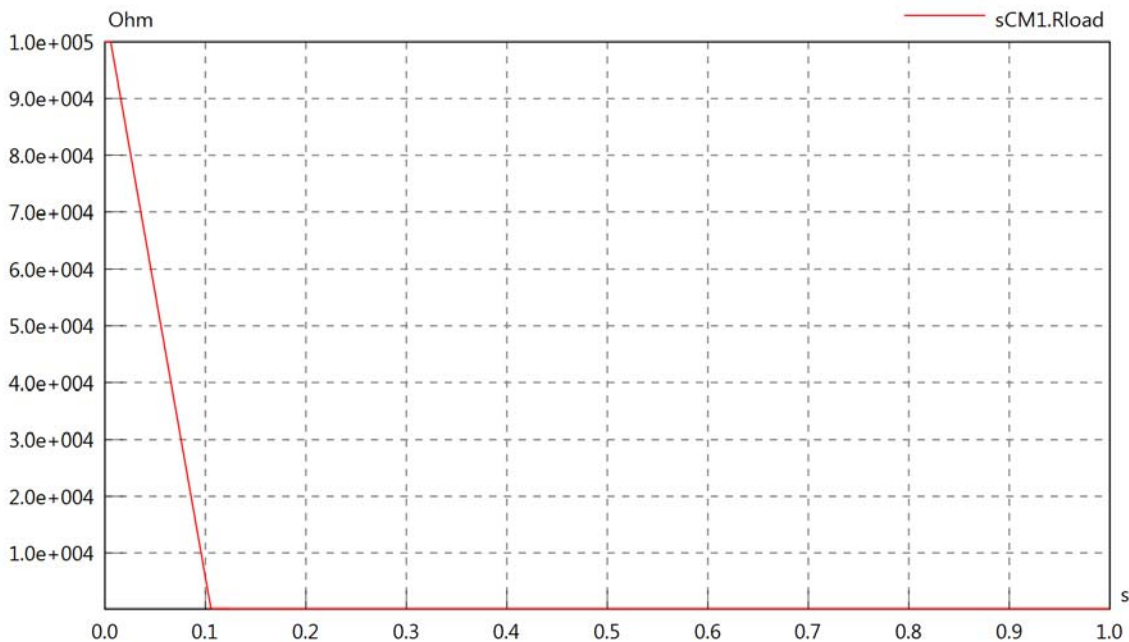

sCM1.Cload

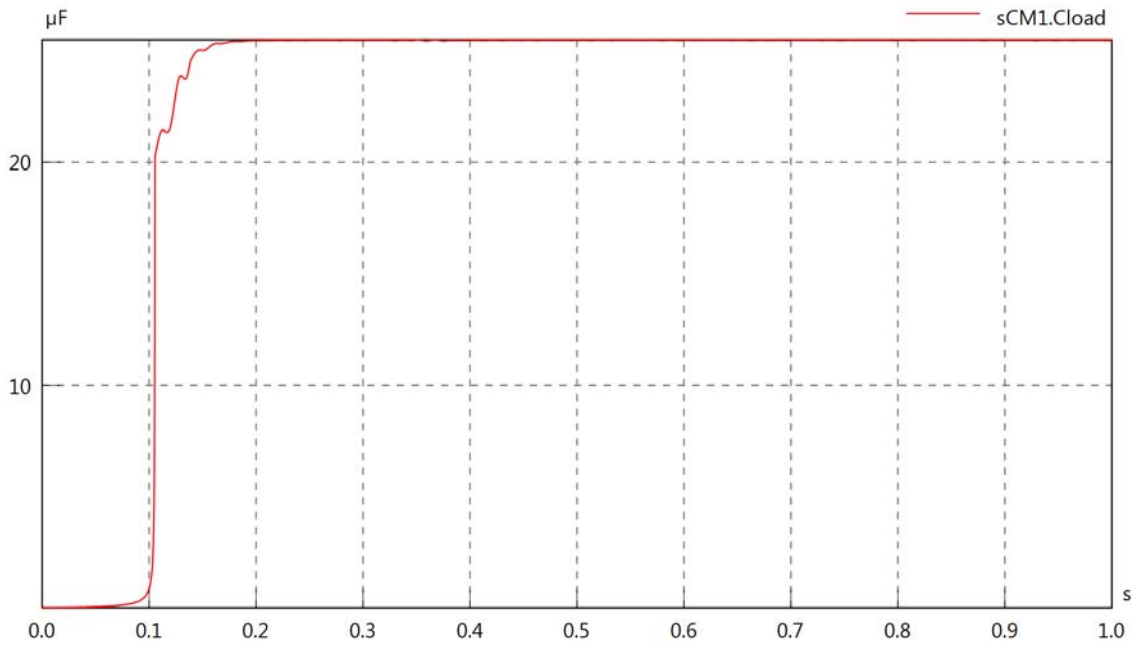

sCM1.PsetX2

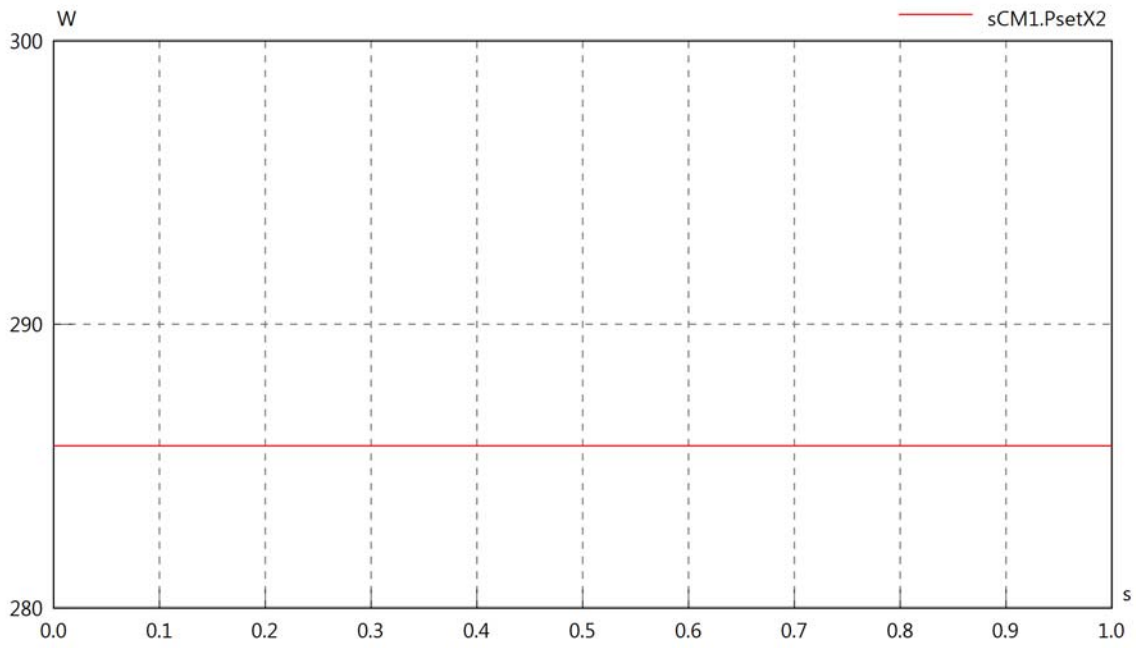

sCM1.Pset

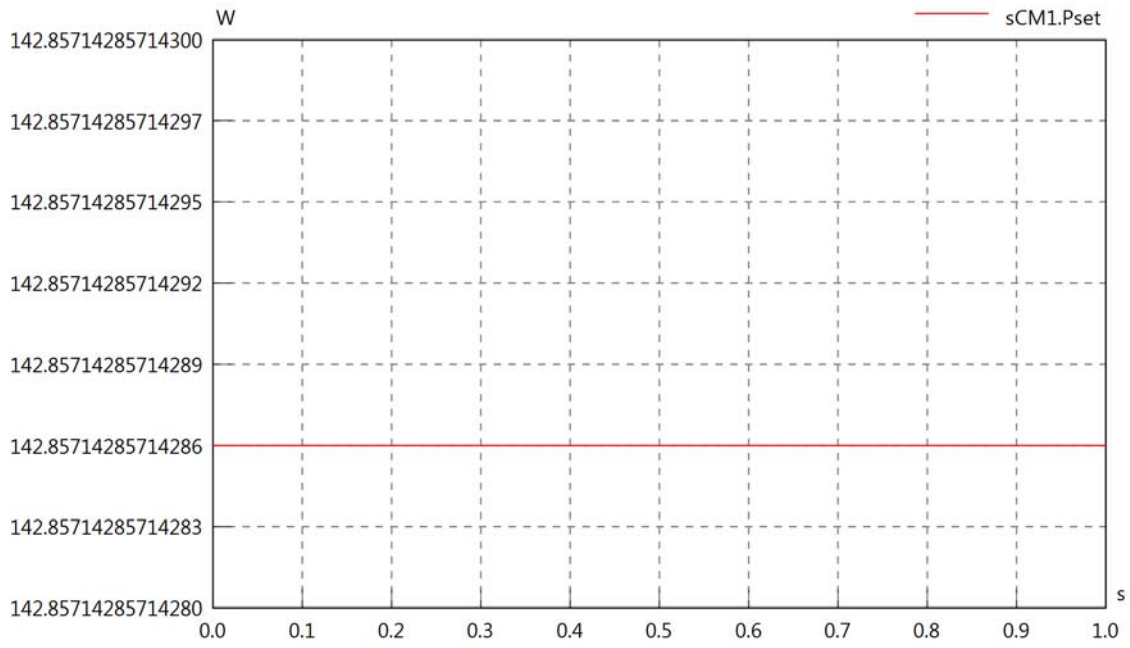

sCM1.PCalc

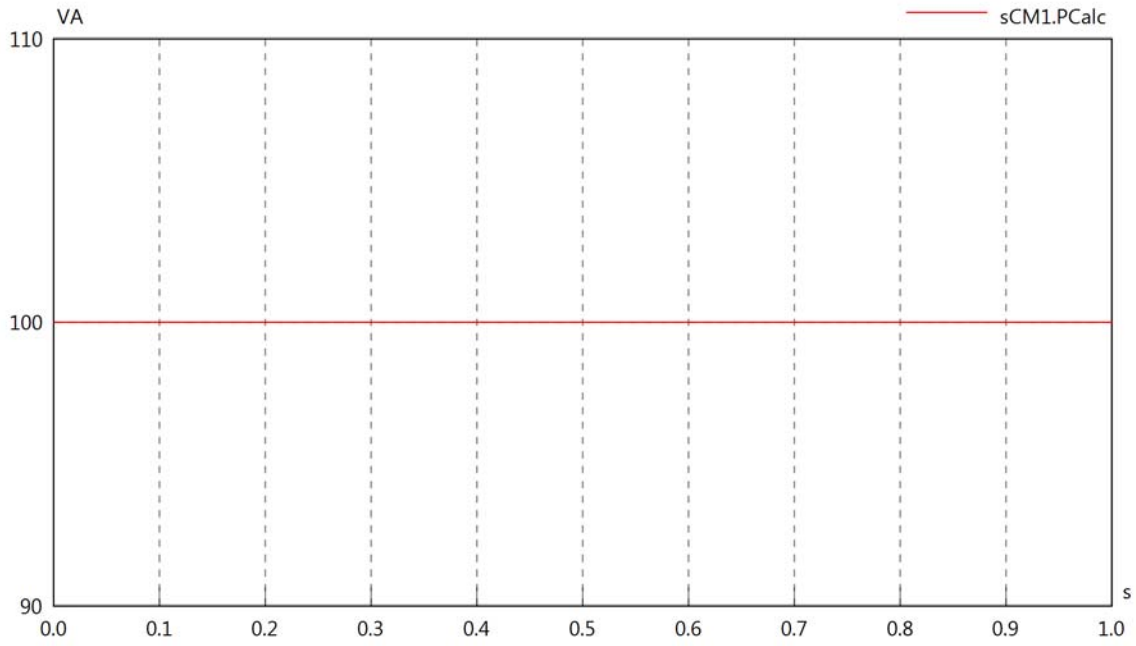

sCM1.vIn

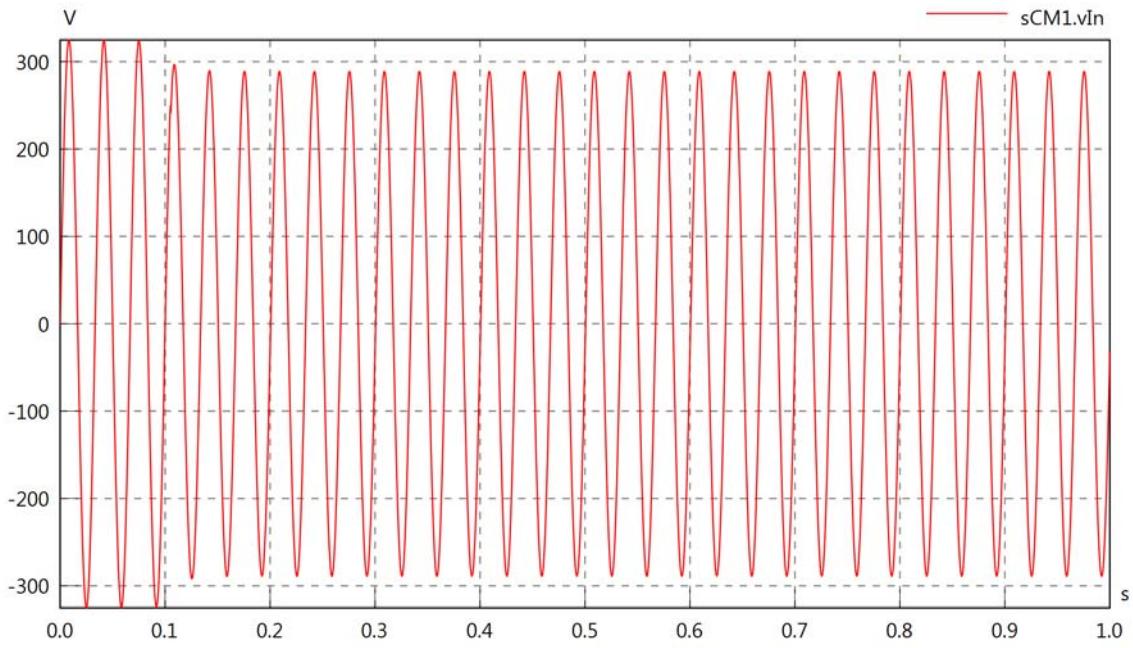

sCM1.iIn

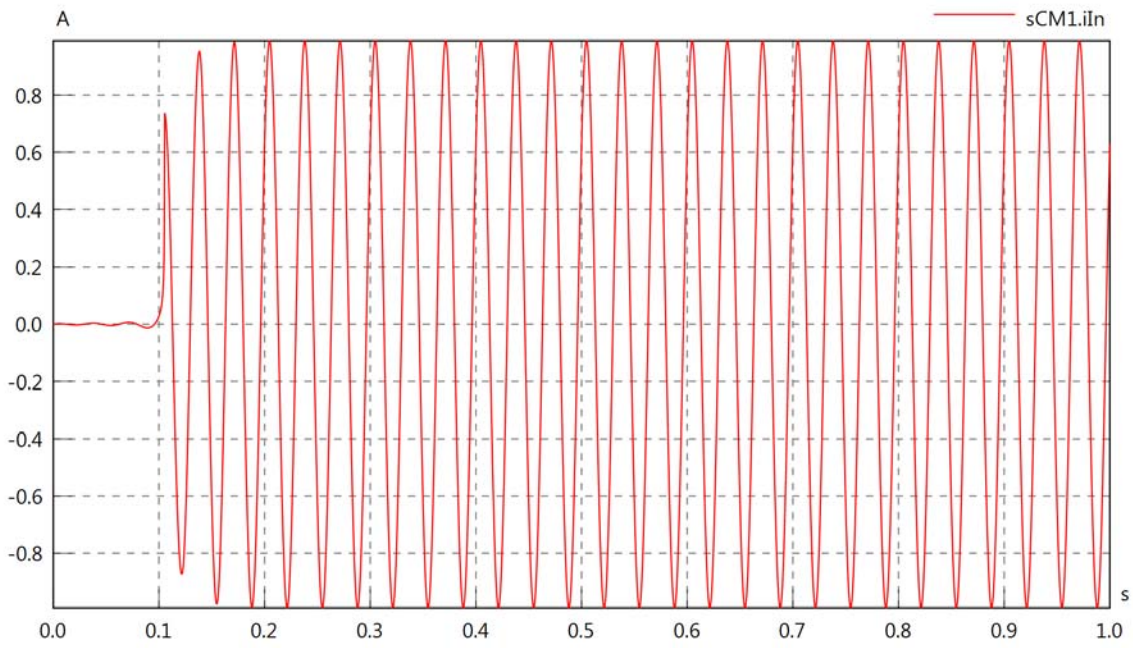

sCM1.PI

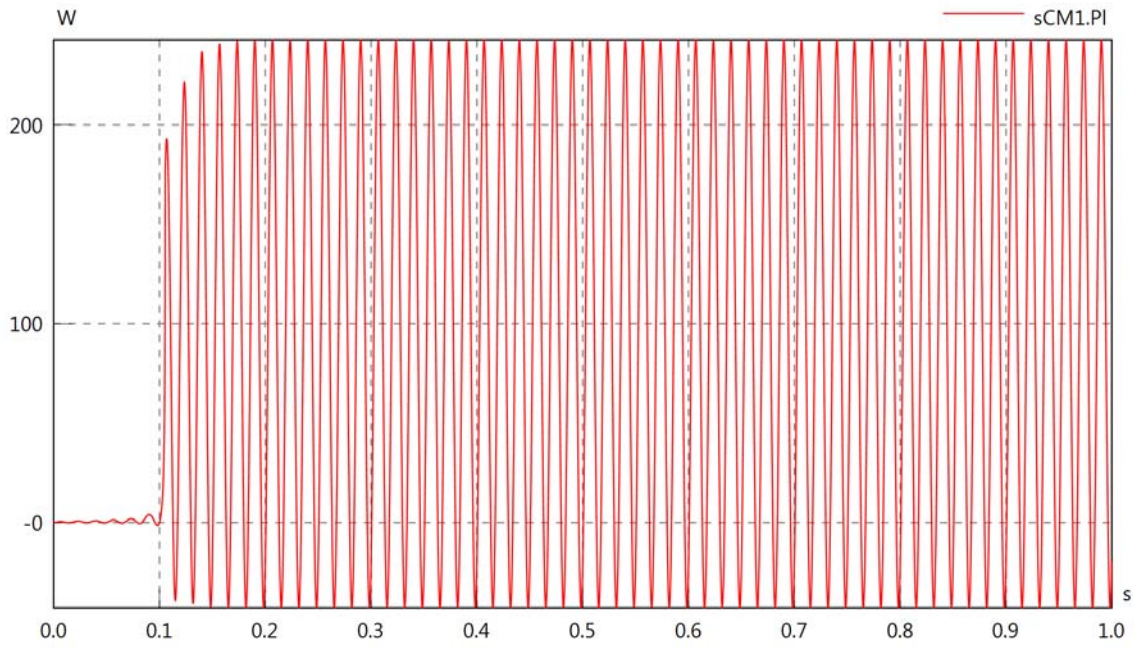

sCM1.vLoad

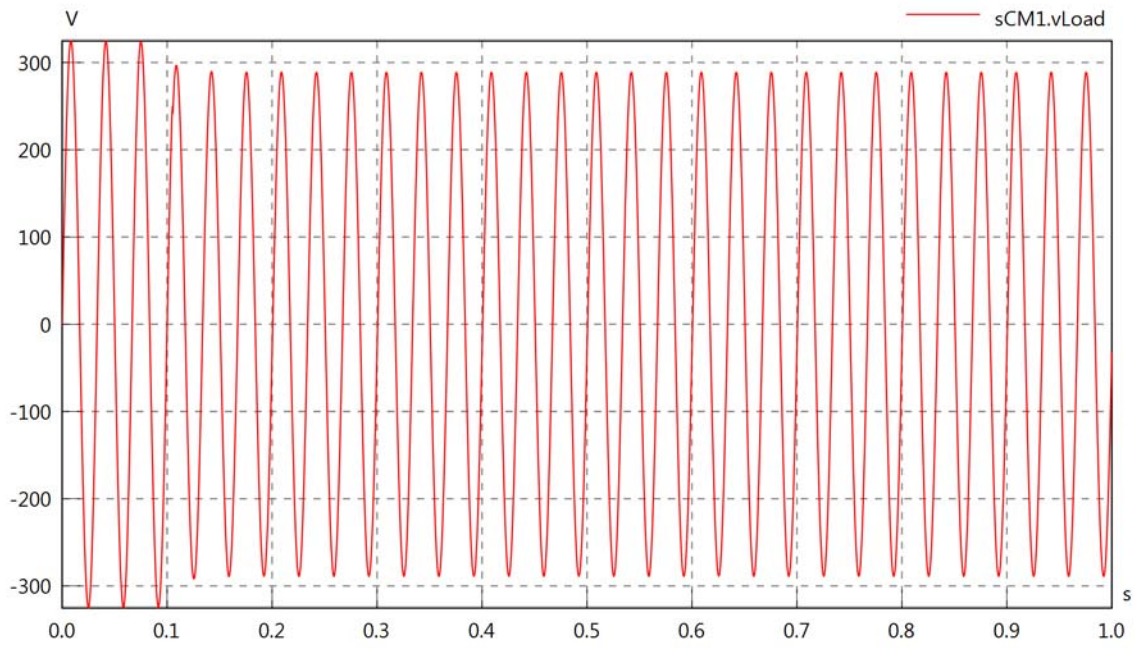

sCM1.iLoad

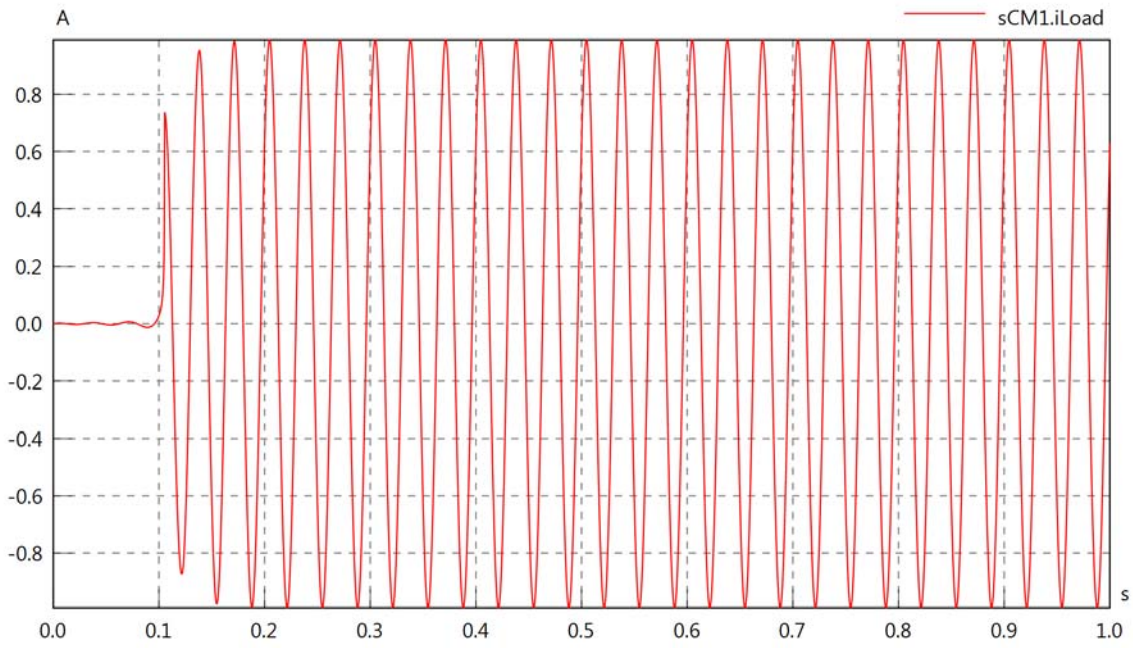

sCM1.PILoad

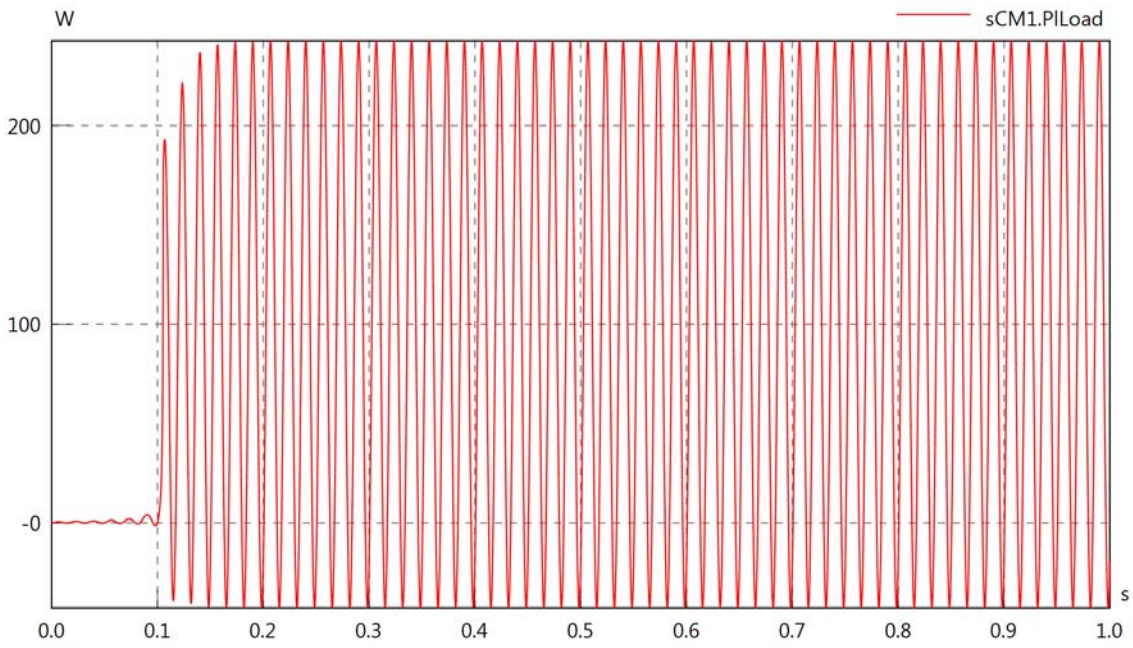
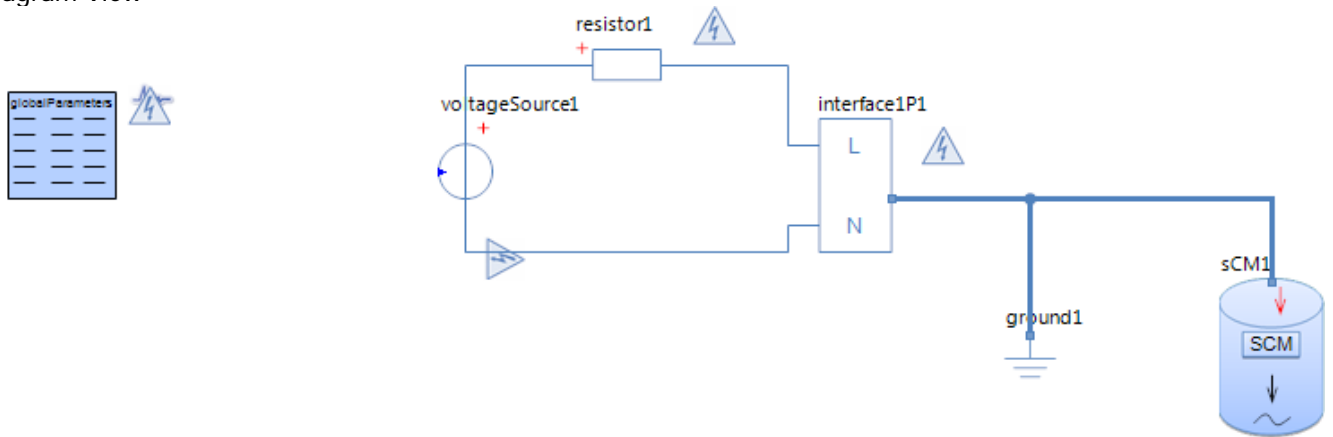

Diagram View



Resistor resistor1
Parameters

Comment	Name	Current Value	Unit
Resistance	R	50	[Ohm]

Voltage Source voltageSource1
Parameters

Comment	Name	Current Value	Unit
Voltage	v_src	$230 \cdot \sqrt{2} \cdot \sin(2 \cdot \pi \cdot t \cdot 60)$	[V]

Subsea Control Module sCM1
Parameters

Comment	Name	Current Value	Unit
Simulate with internal Transformer	trafoOn	false	
SCM Input Frequency	fIn	60	[Hz]
Constant or Variable Power	pType	Constant Power	
Output Power from PSU in SCM	P	100	[VA]
PSU Power Factor	pf	0.7	[-]
PSU turn-off RMS Voltage	vMin	130	[V]
PSU turn-on RMS Voltage	vMax	180	[V]

sCM1.Rload

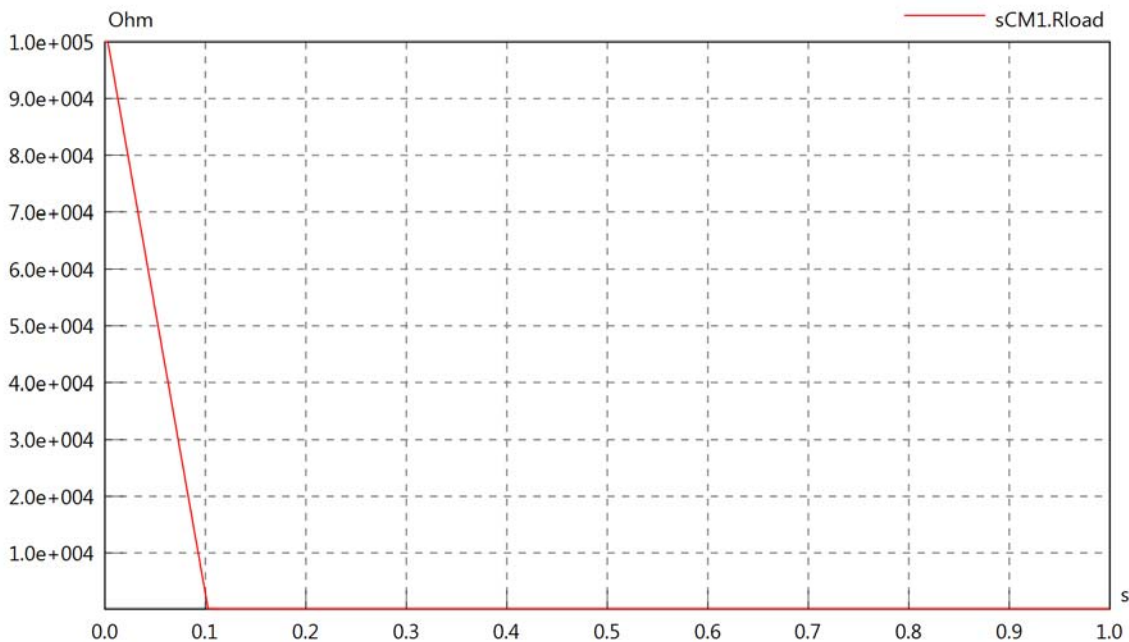

sCM1.Cload

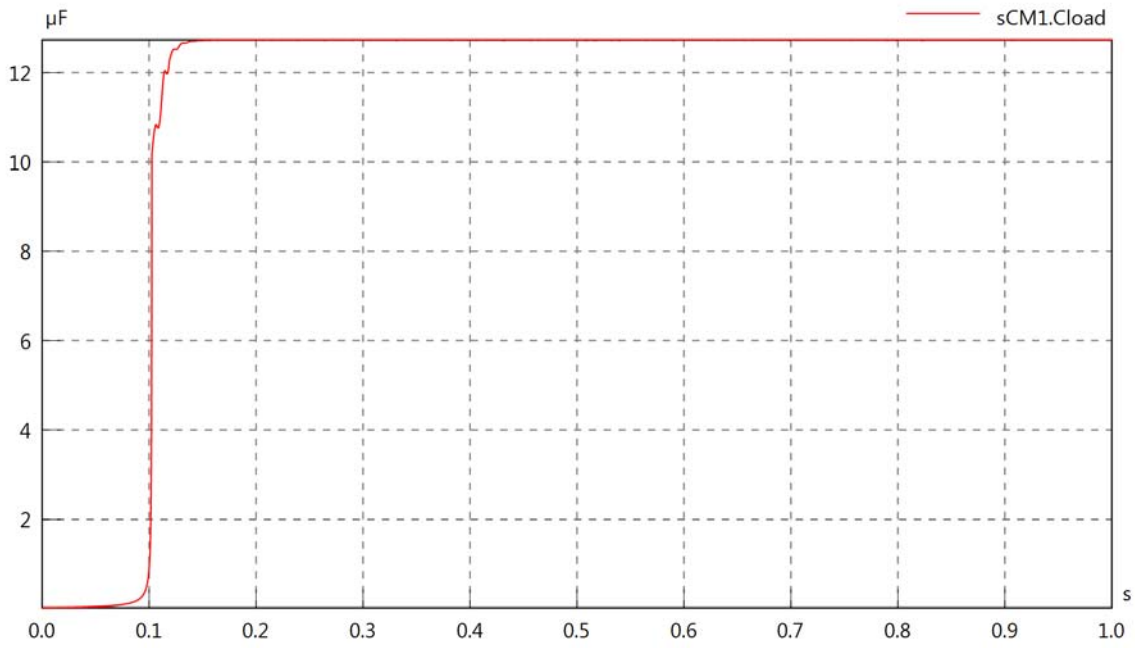

sCM1.PsetX2

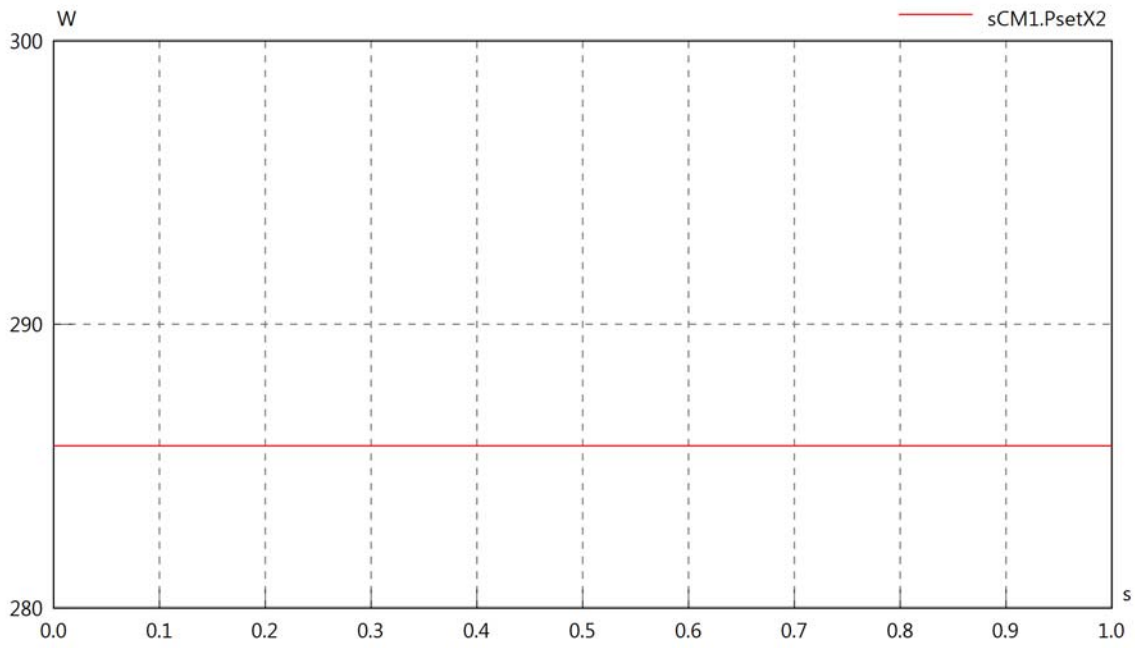

sCM1.Pset

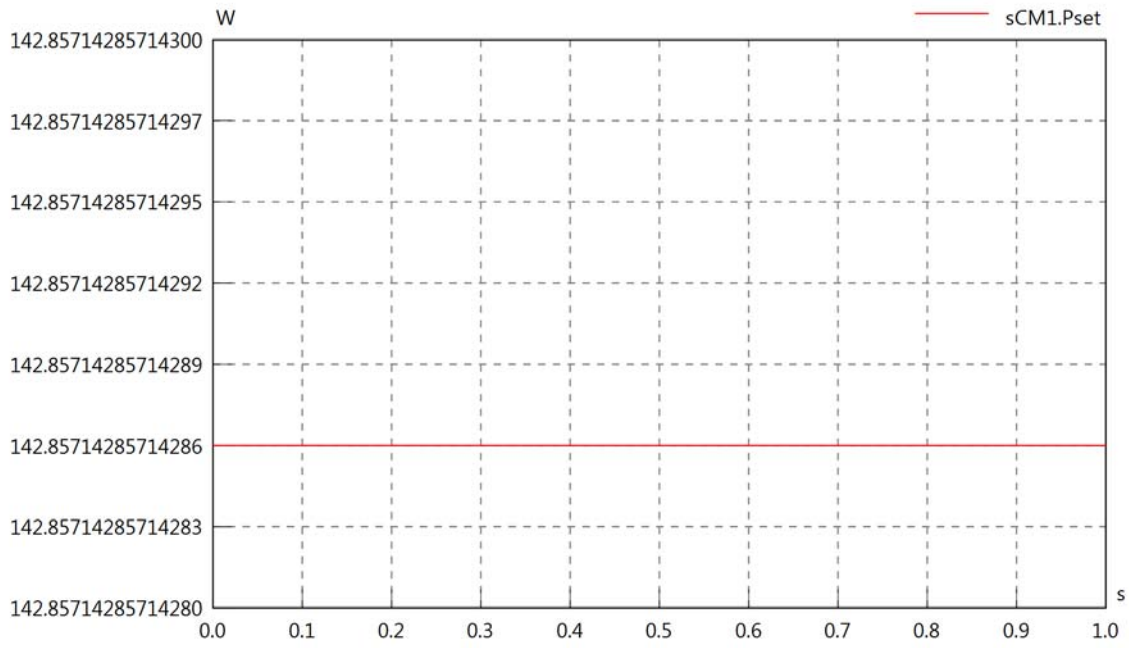

sCM1.PCalc

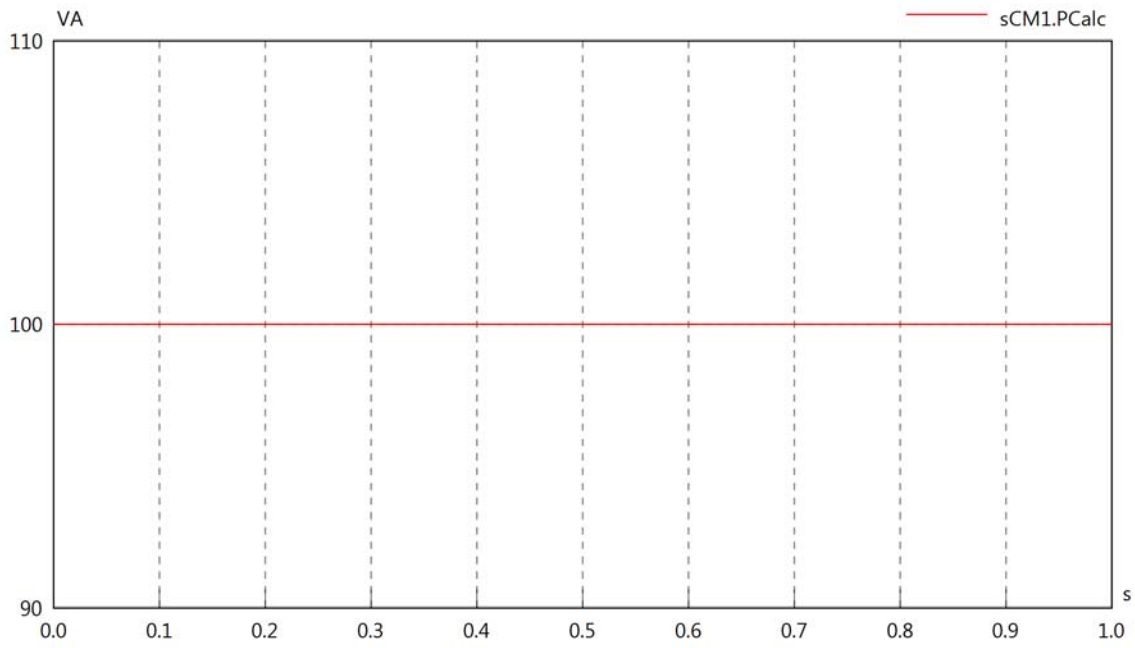

sCM1.vIn

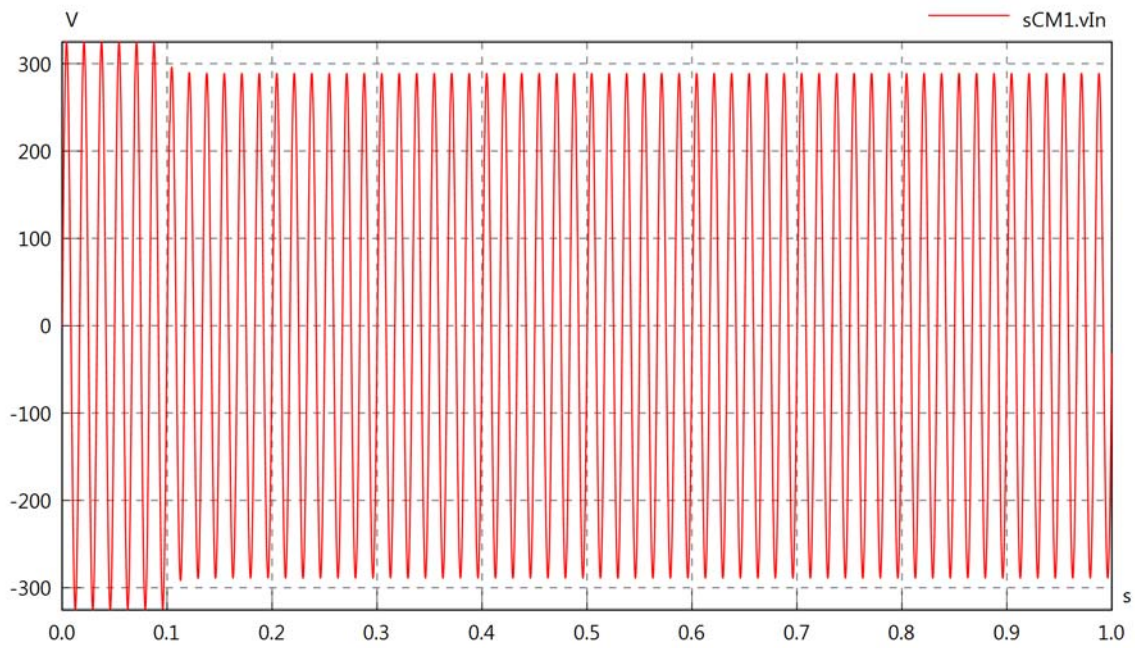

sCM1.iIn

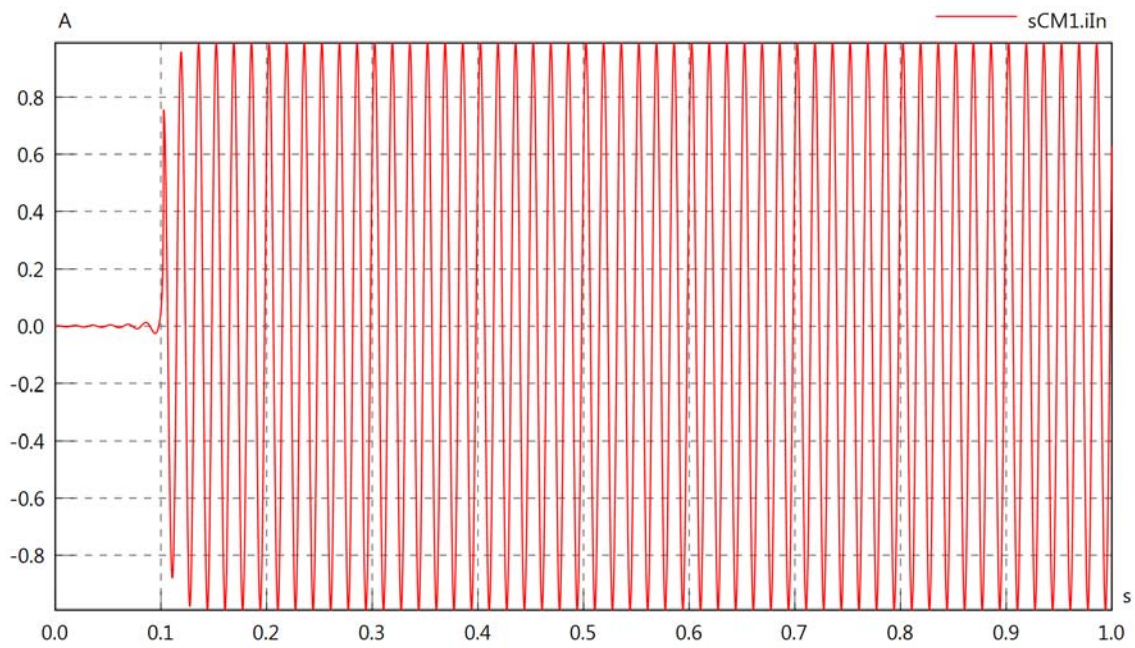

sCM1.PI

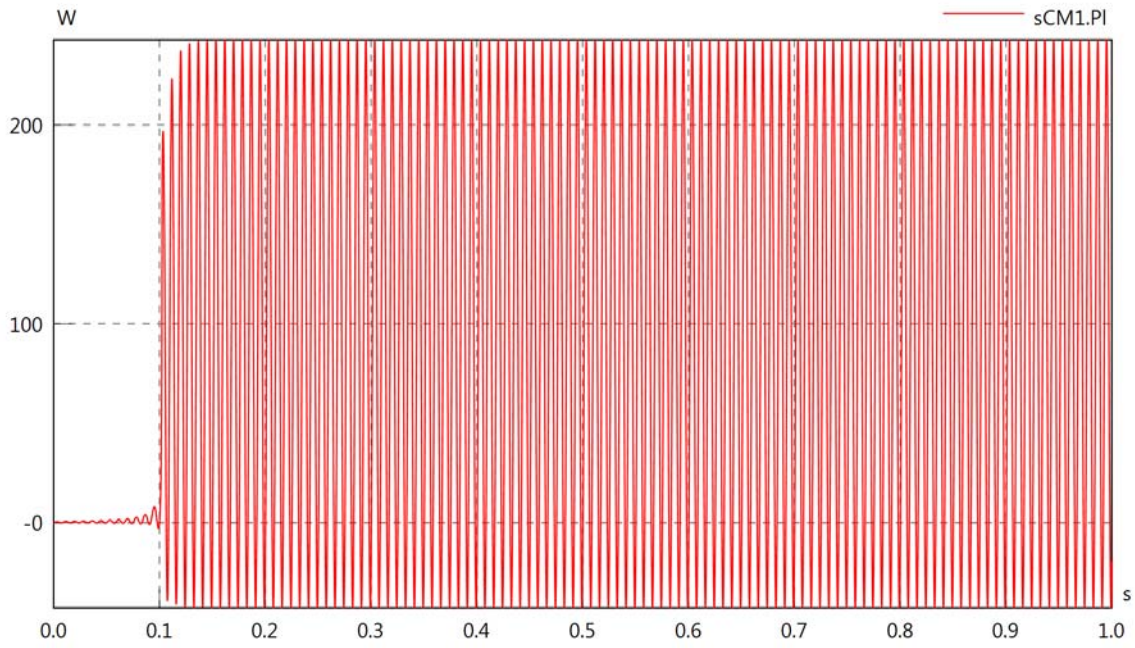

sCM1.vLoad

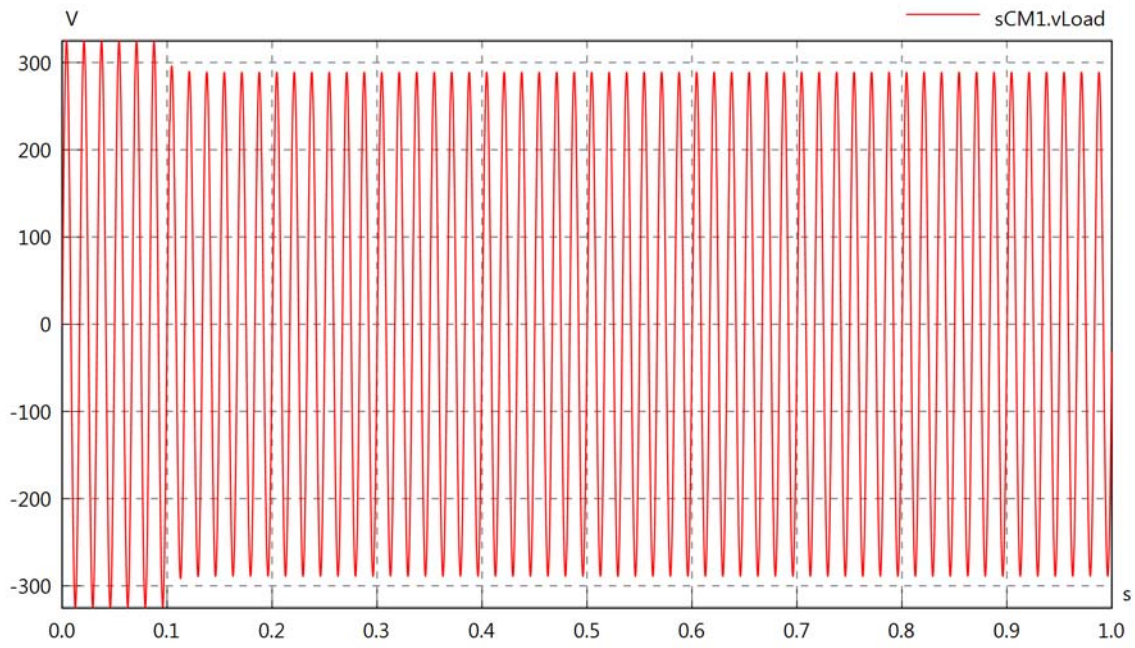

sCM1.iLoad

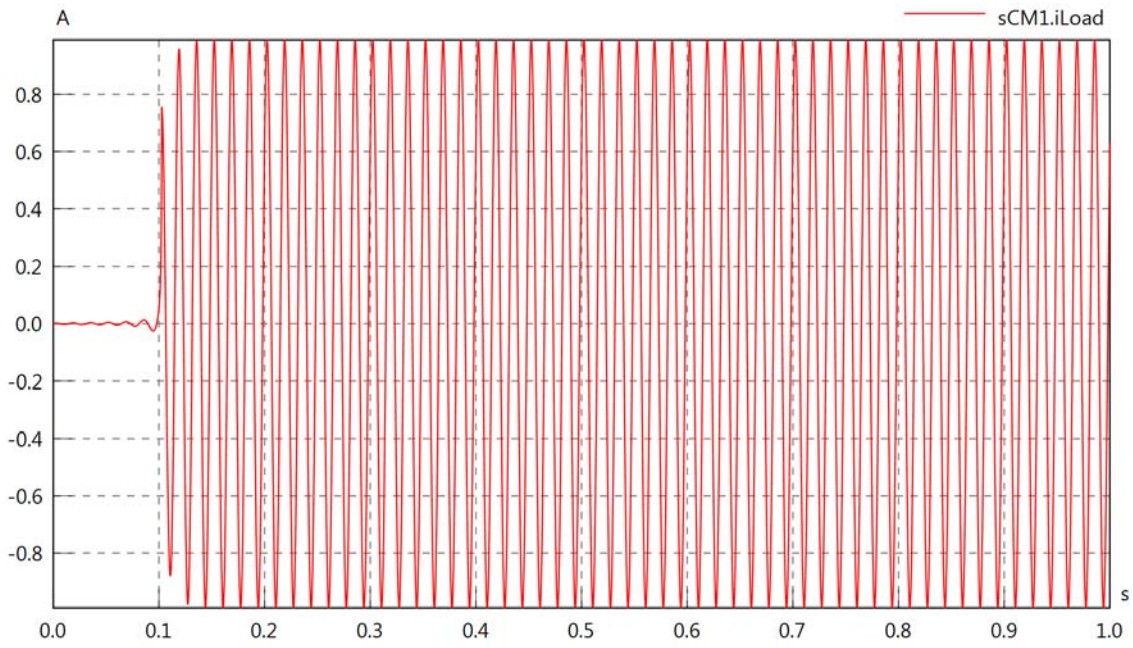

sCM1.PILoad

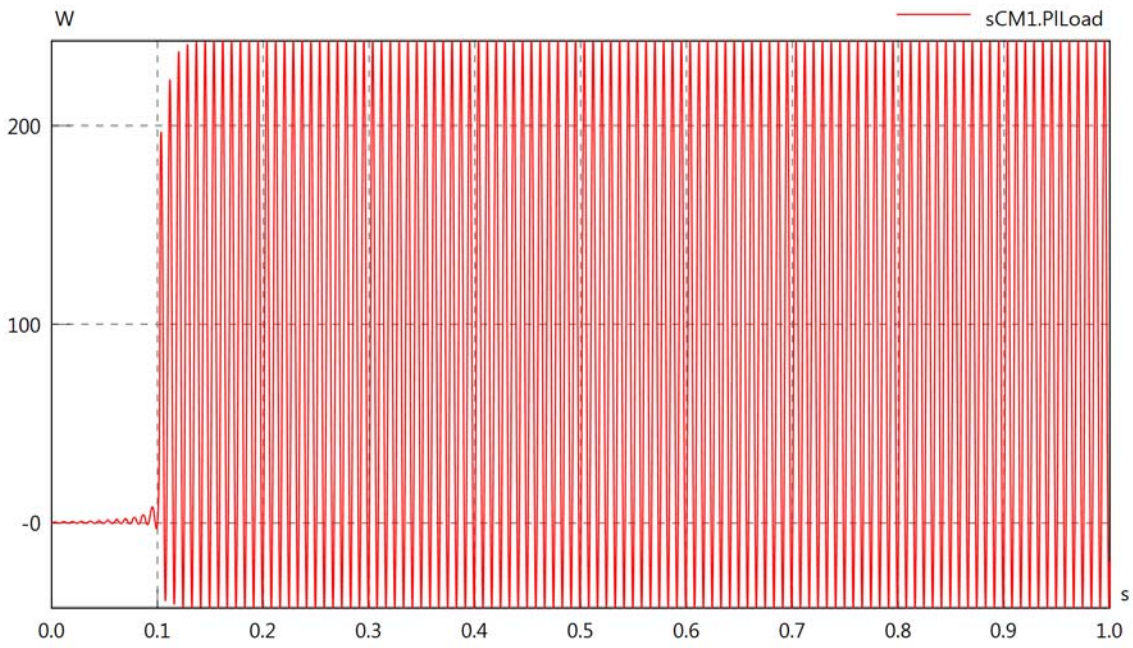
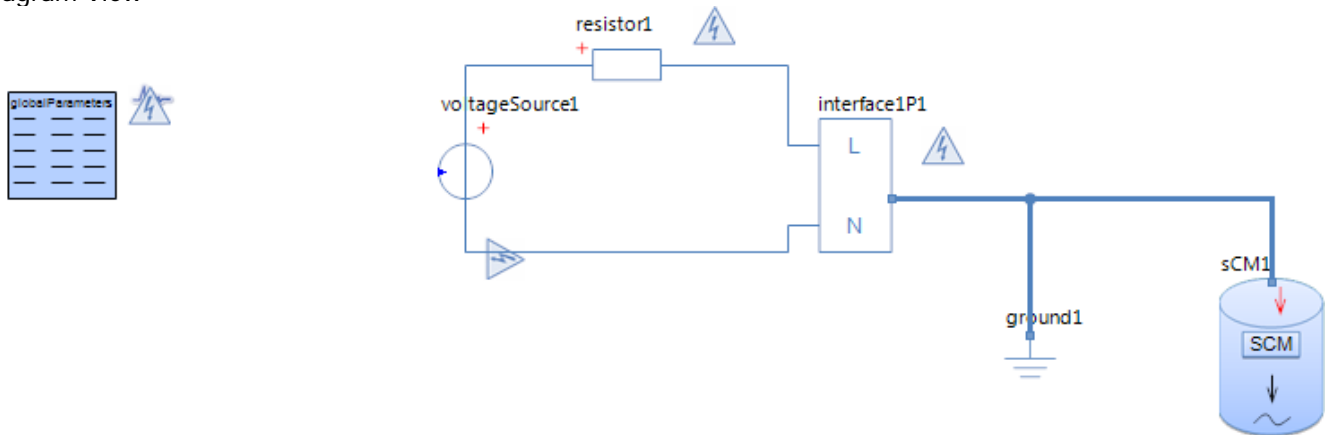

Diagram View



Resistor resistor1
Parameters

Comment	Name	Current Value	Unit
Resistance	R	50	[Ohm]

Voltage Source voltageSource1
Parameters

Comment	Name	Current Value	Unit
Voltage	v_src	$230 \cdot \sqrt{2} \cdot \sin(2 \cdot \pi \cdot t \cdot 120)$	[V]

Subsea Control Module sCM1
Parameters

Comment	Name	Current Value	Unit
Simulate with internal Transformer	trafoOn	false	
SCM Input Frequency	fIn	120	[Hz]
Constant or Variable Power	pType	Constant Power	
Output Power from PSU in SCM	P	100	[VA]
PSU Power Factor	pf	0.7	[-]
PSU turn-off RMS Voltage	vMin	130	[V]
PSU turn-on RMS Voltage	vMax	180	[V]

sCM1.Rload

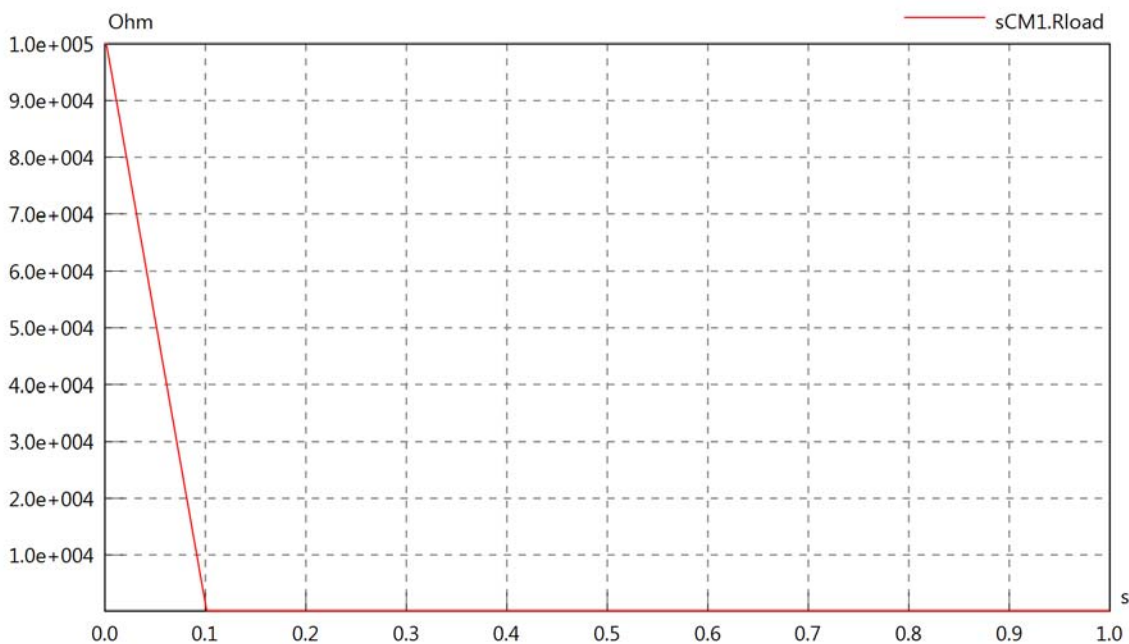

sCM1.Cload

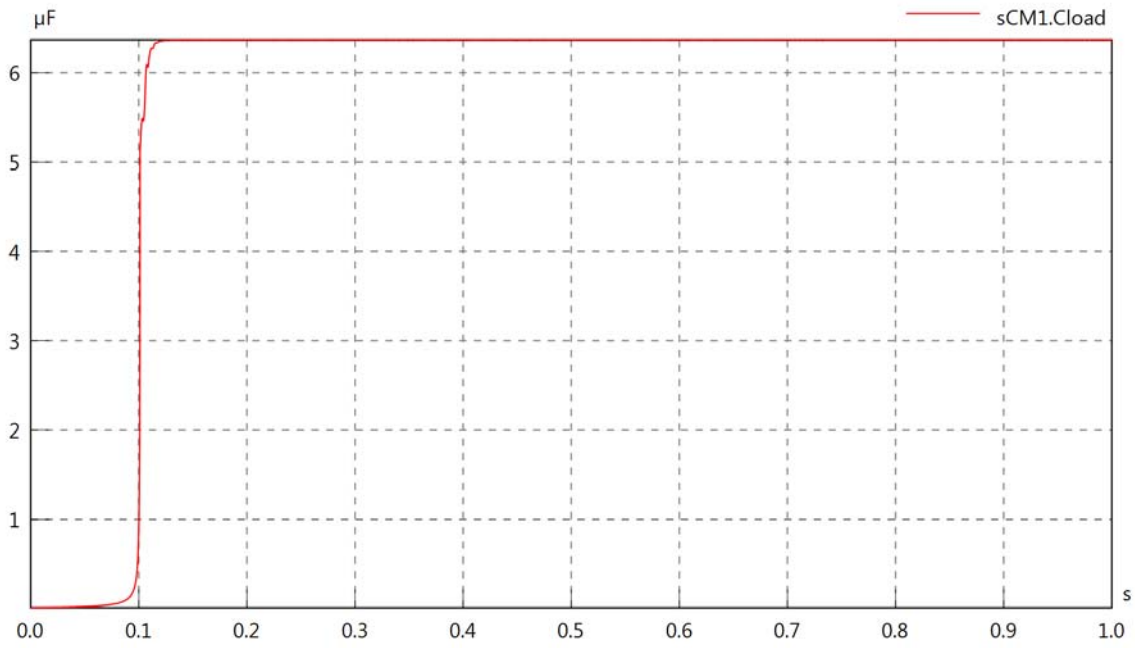

sCM1.PsetX2

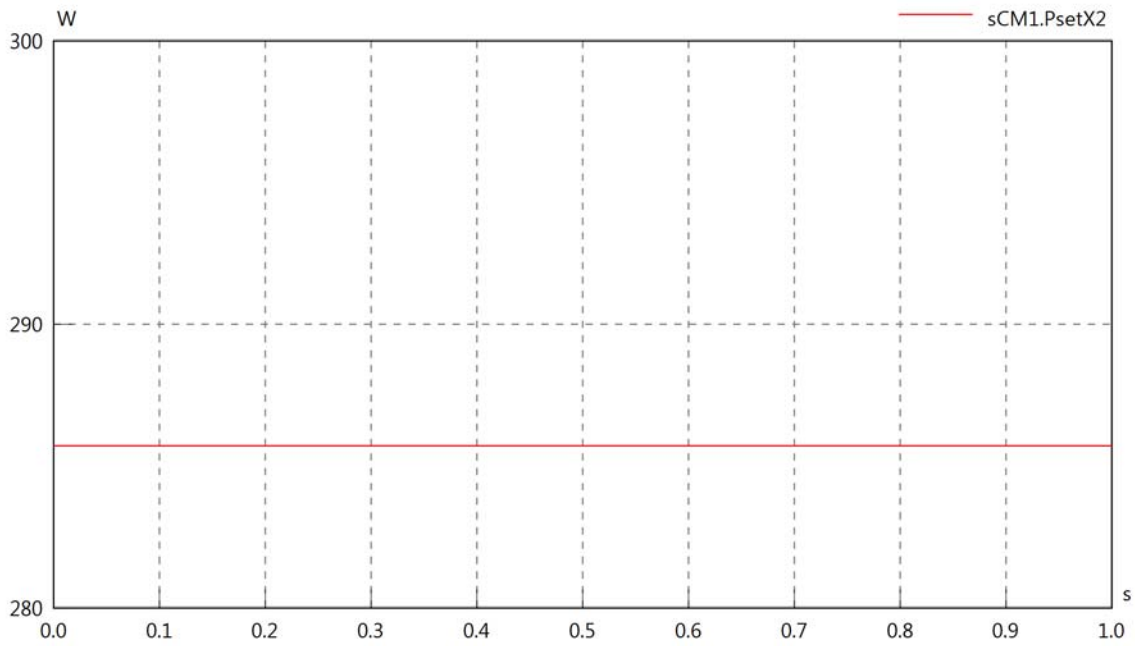

sCM1.Pset

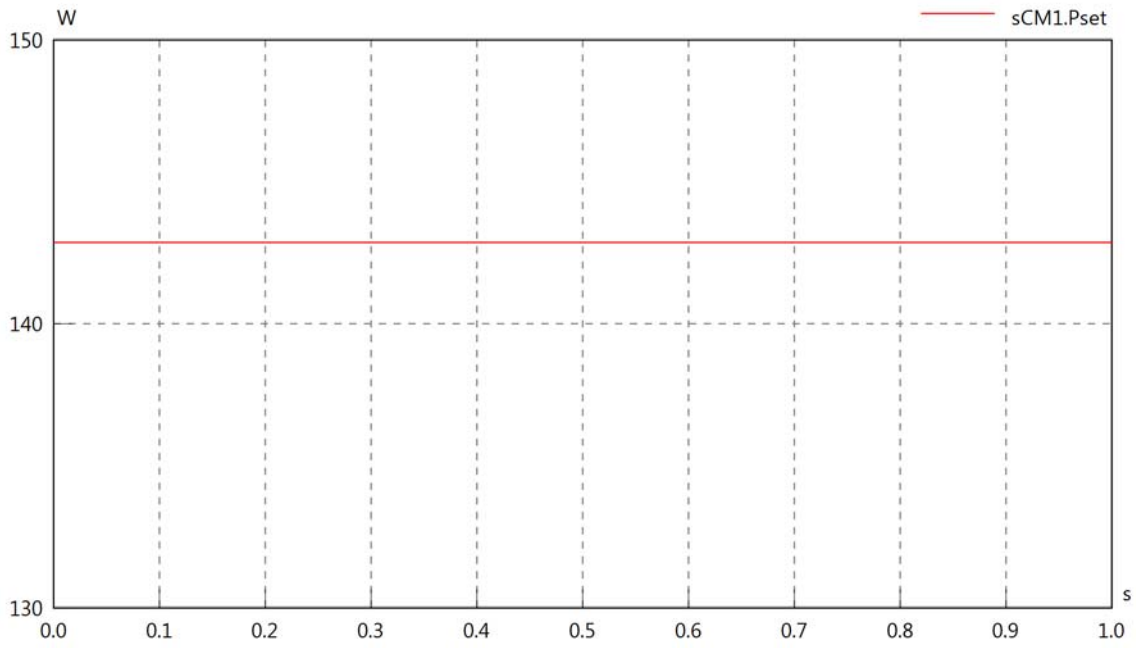

sCM1.PCalc

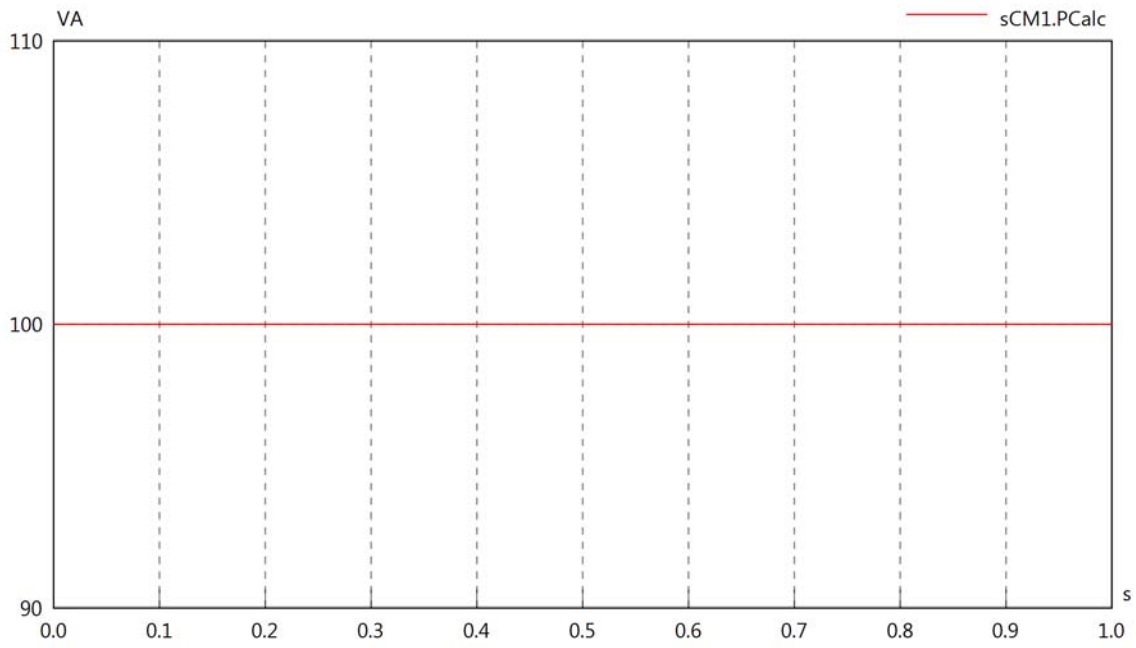

sCM1.vIn

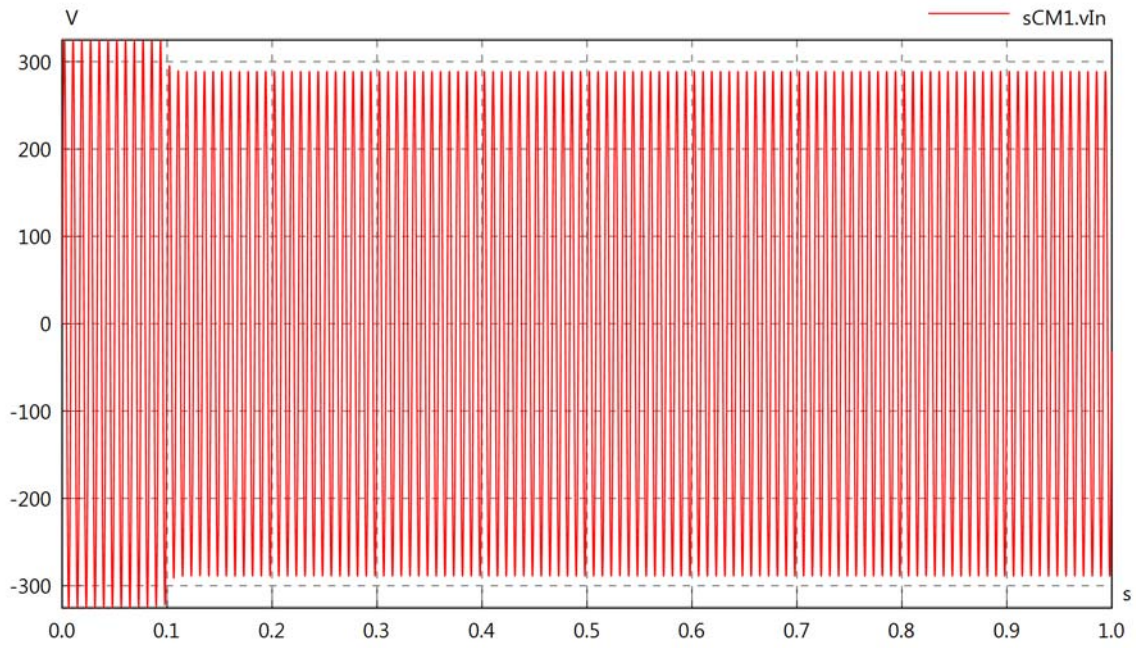

sCM1.iIn

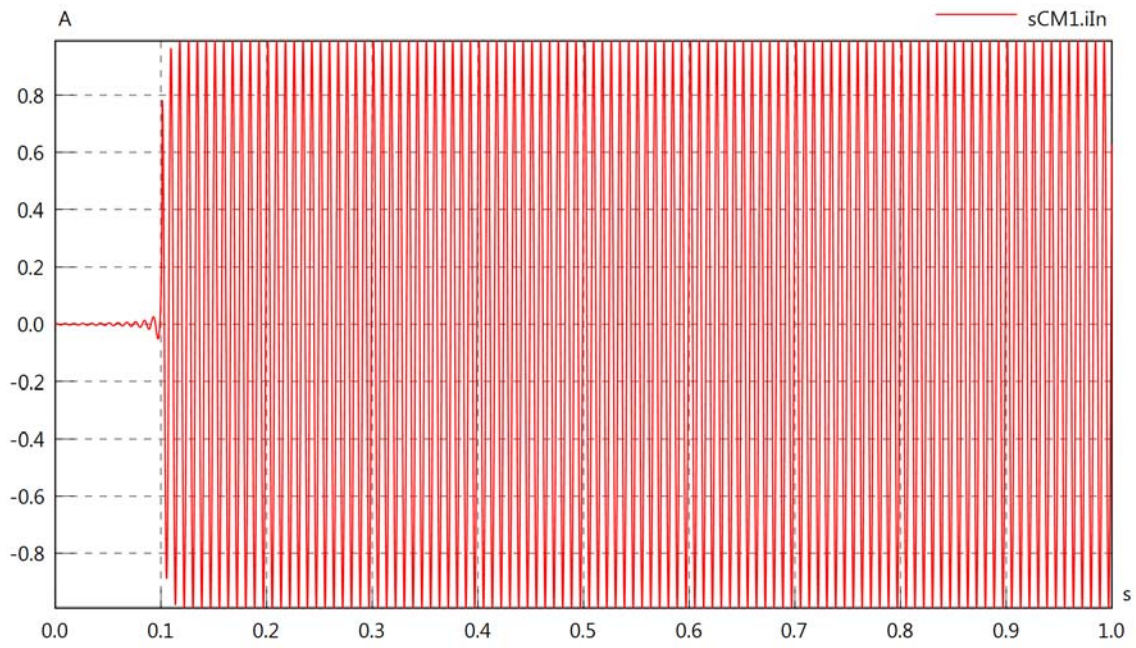

sCM1.PI

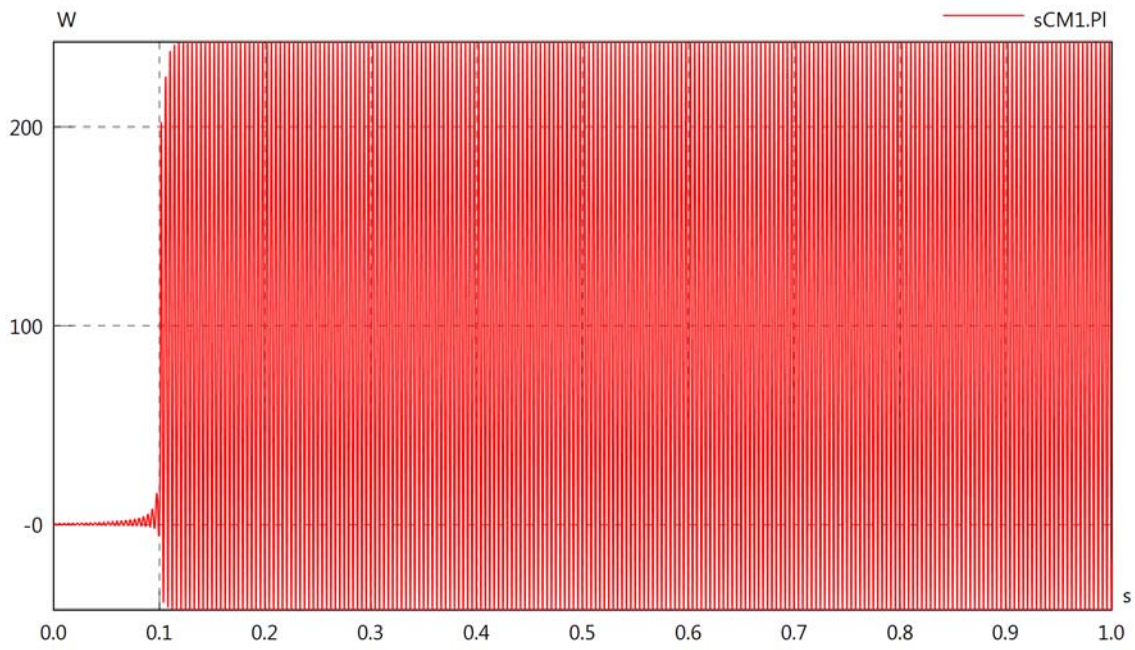

sCM1.vLoad

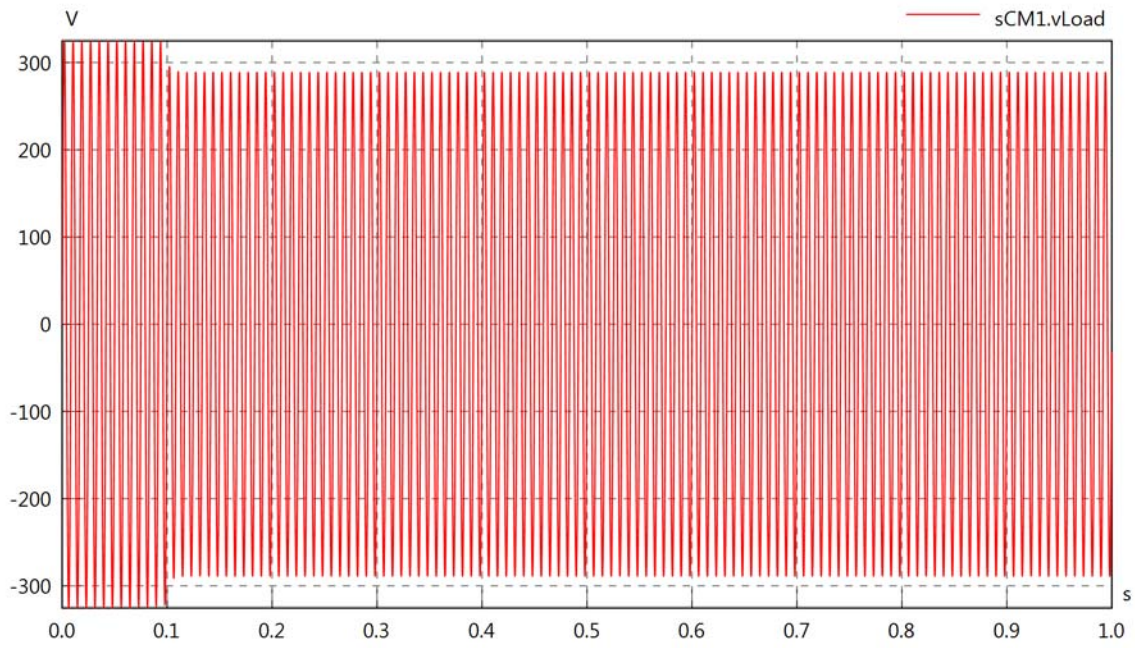

sCM1.iLoad

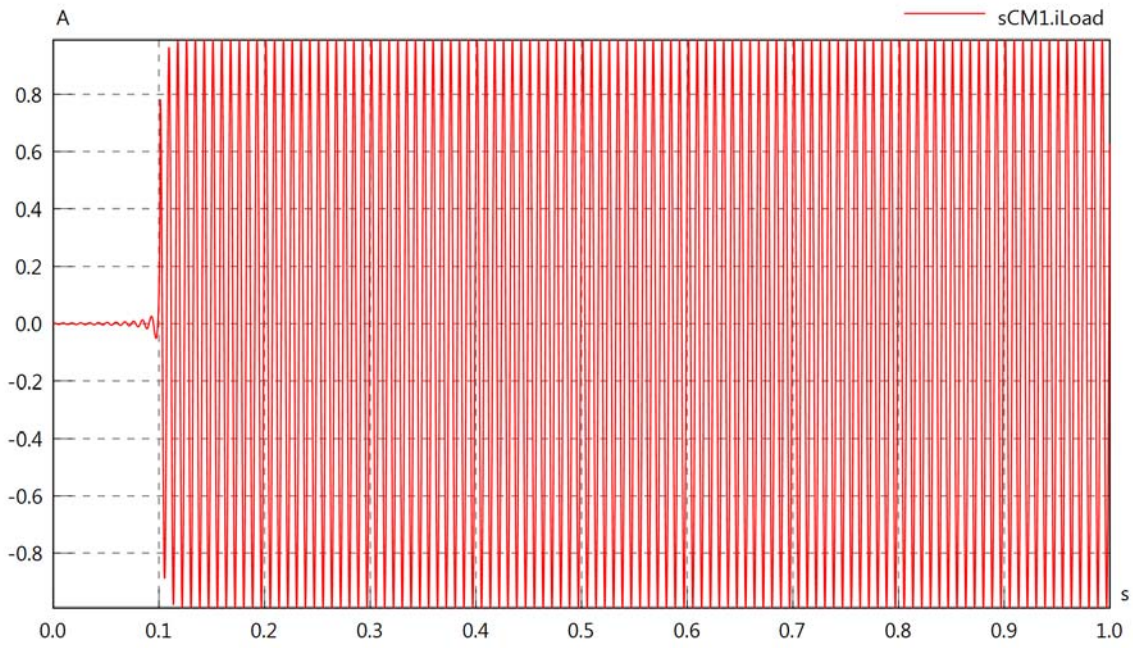

sCM1.PILoad

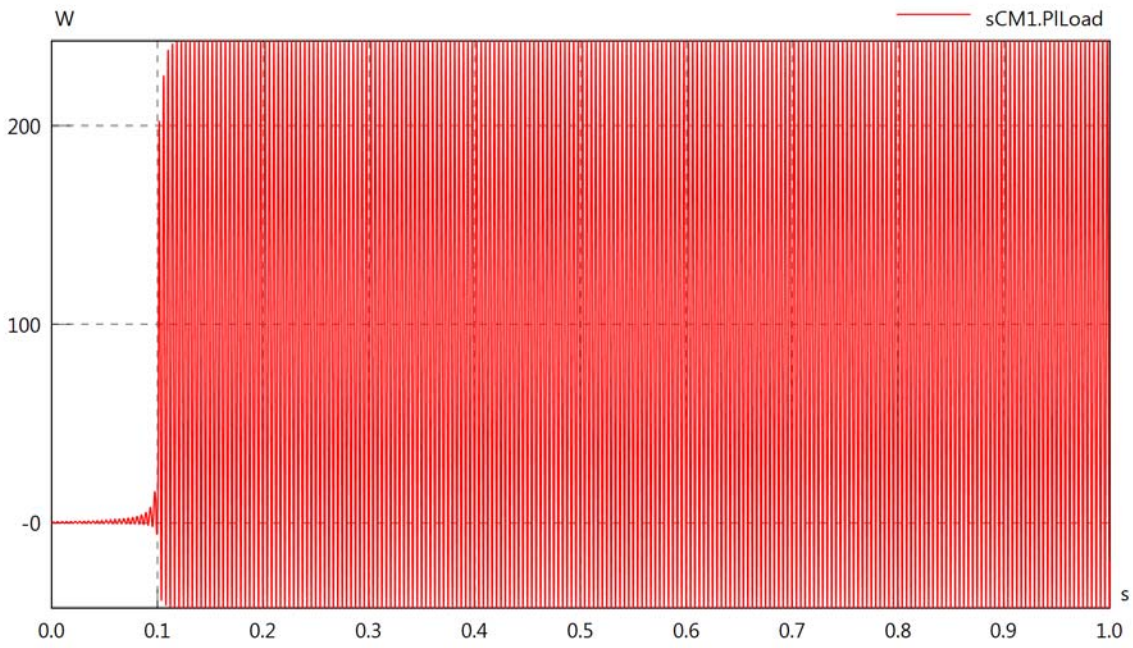
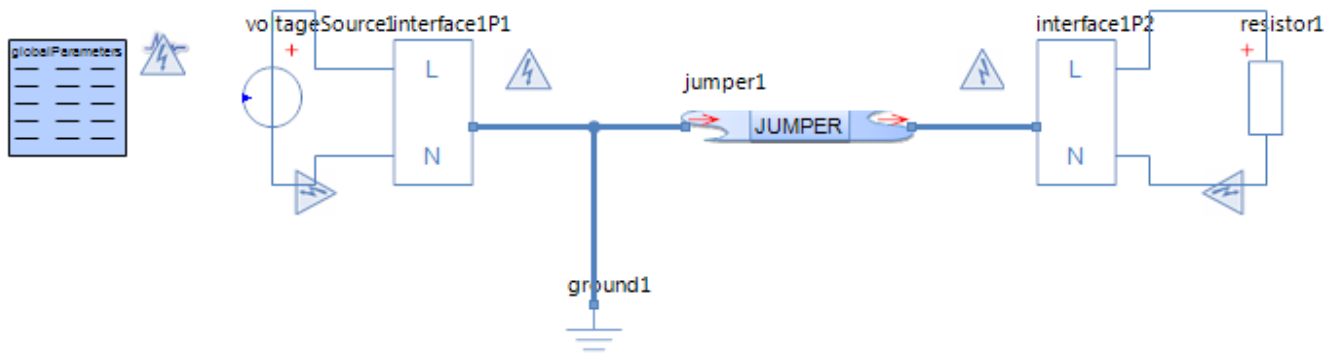

Diagram View



Jumper jumper1
Parameters

Comment	Name	Current Value	Unit
Resistance per length for each Line at 20 °C (68 °F)	r	1	[Ohm/km]
Inductance per length for each Line	l	2.5	[mH/km]
Conductance per length between Lines	g	1e-10	[1/(Ohm·m)]
Capacitance per length between Lines	c	0.3	[µF/km]
Length of Jumper for each Line	length	100	[km]
Number of Lumped Segments	N	3	[Stck]
Temperature of the conductor	temp	5	[°C]

Voltage Source voltageSource1
Parameters

Comment	Name	Current Value	Unit
Voltage	v_src	$\min(230, 630000 \cdot t) \cdot \sqrt{2} \cdot \sin(2 \cdot \pi \cdot 30 \cdot t)$	[V]

Resistor resistor1
Parameters

Comment	Name	Current Value	Unit
Resistance	R	50	[Ohm]

jumper1.rTemp

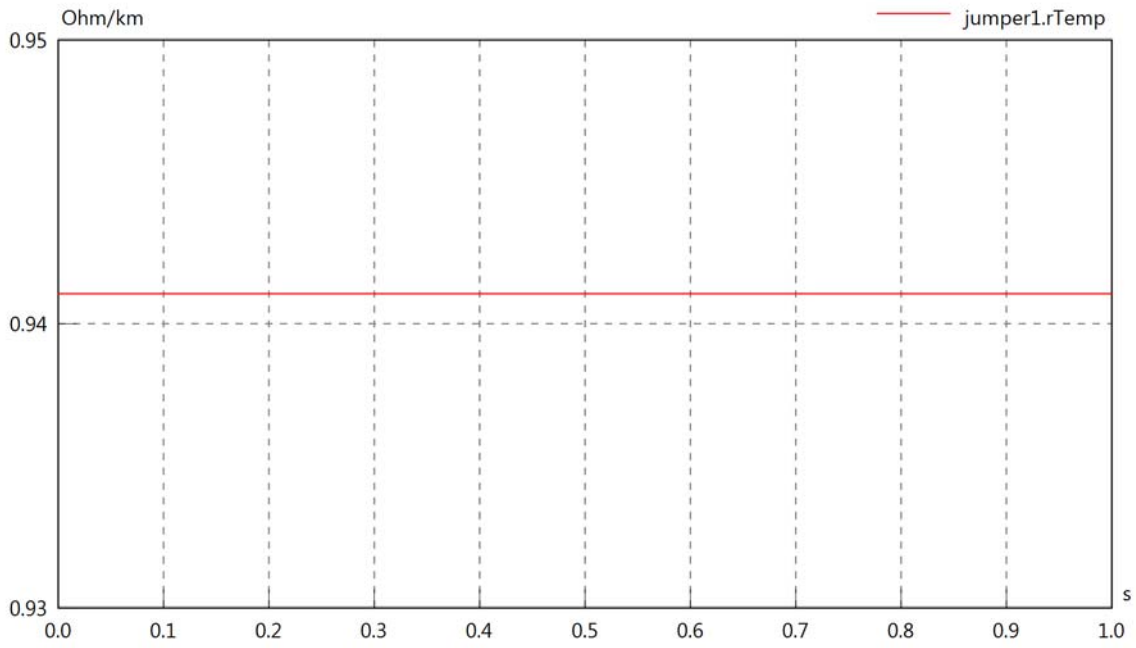

jumper1.rInternal

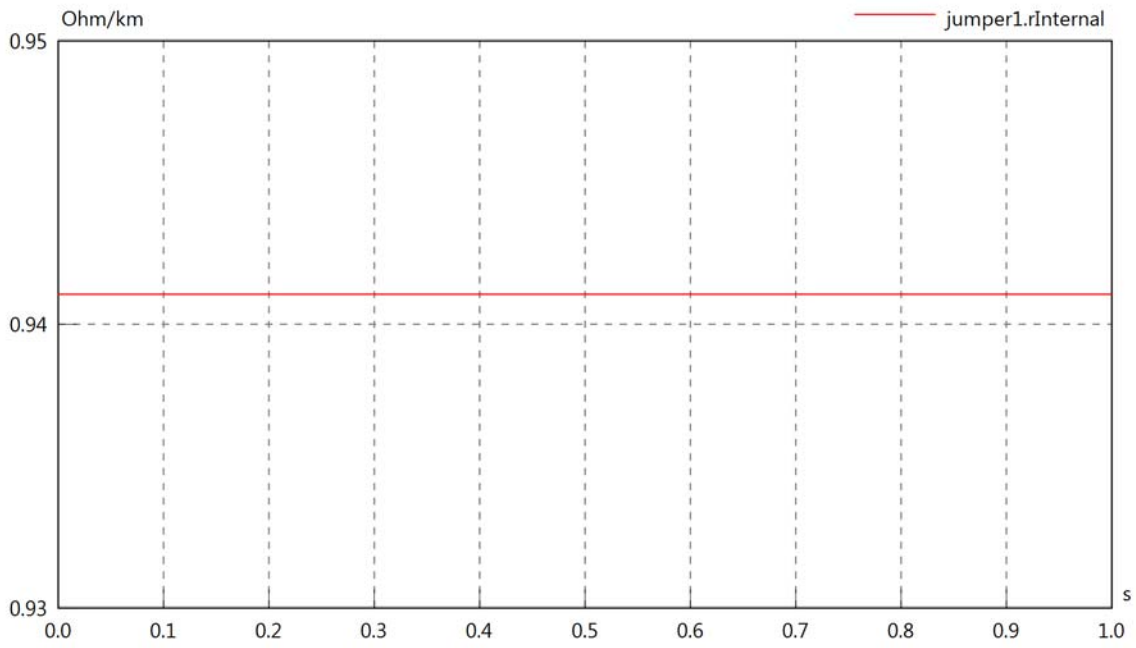

jumper1.vIn

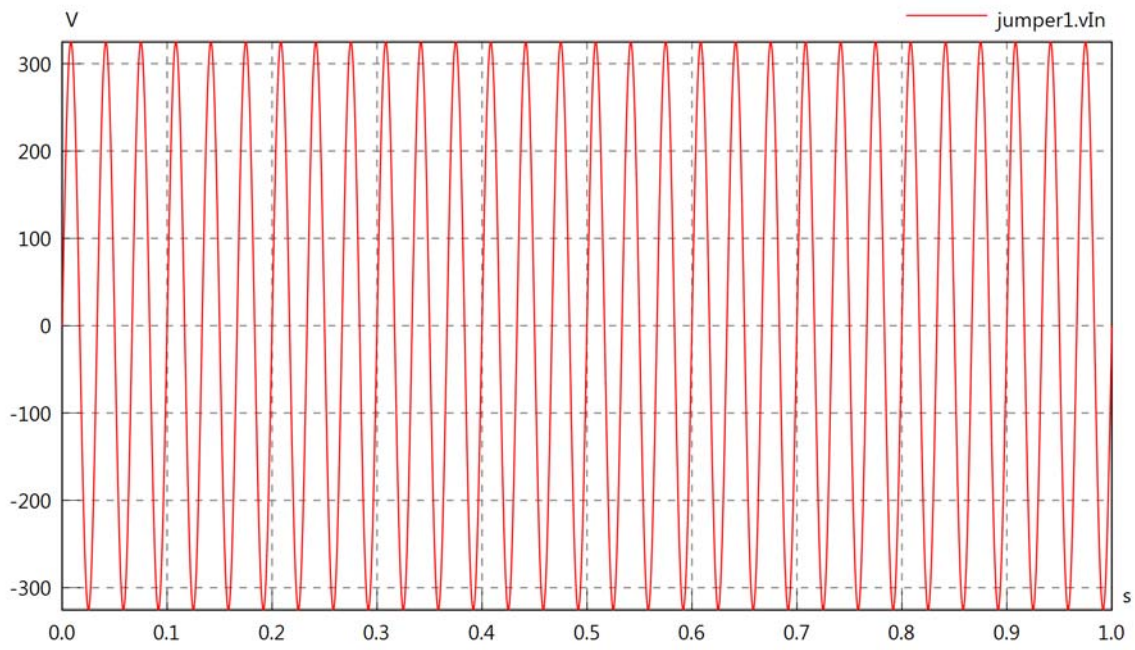

jumper1.vOut

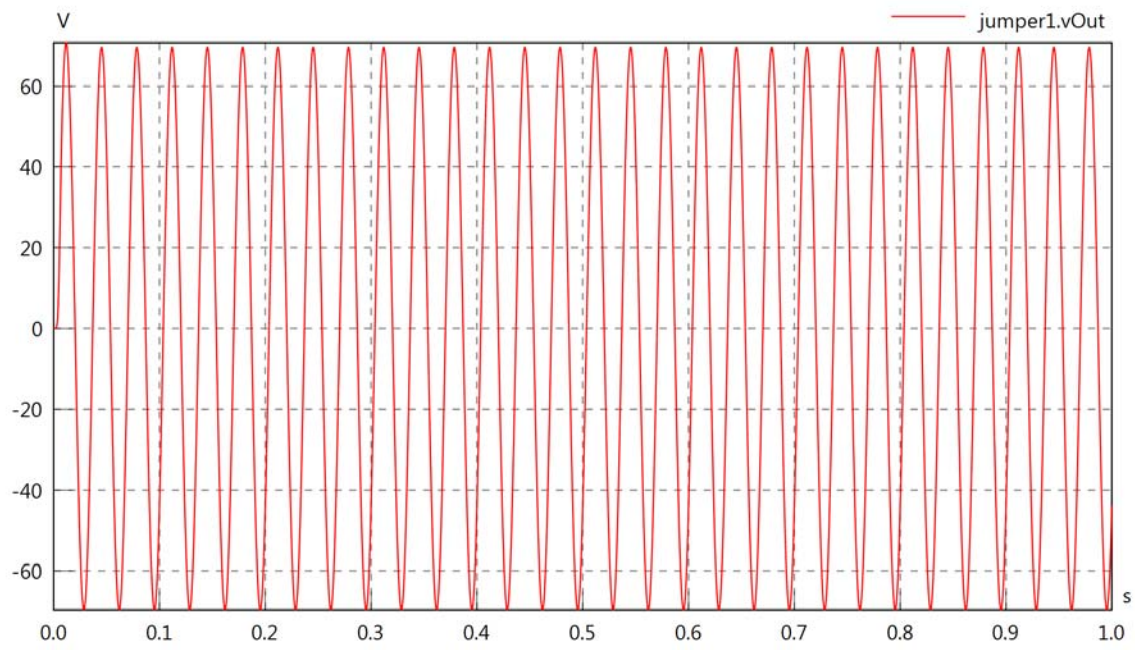

jumper1.v

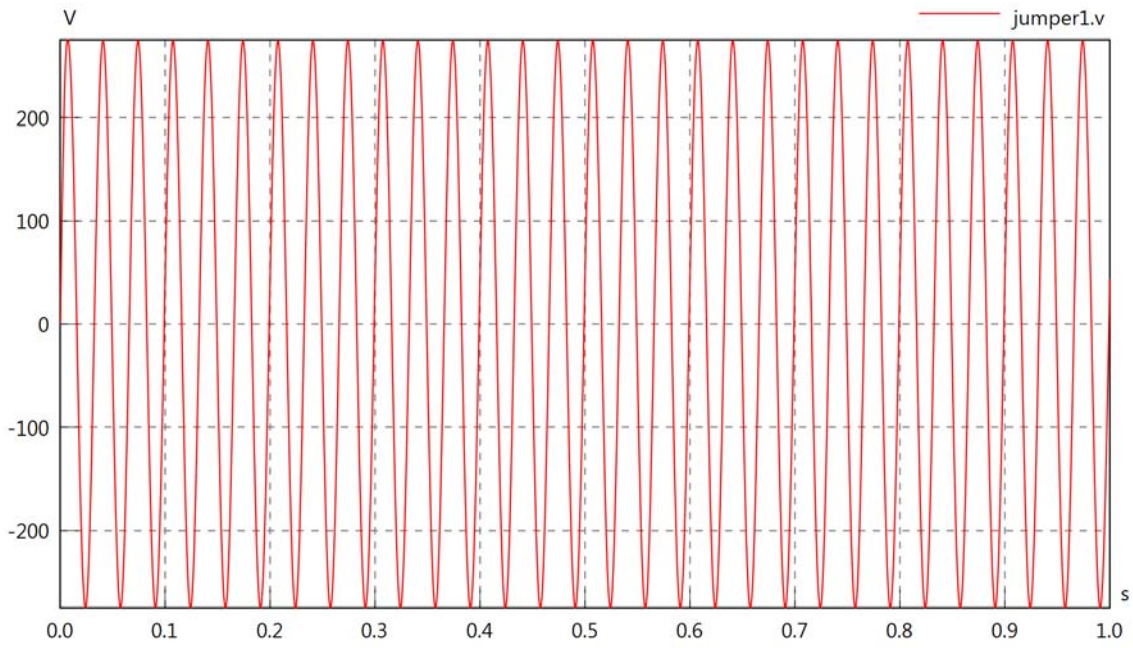

jumper1.iIn

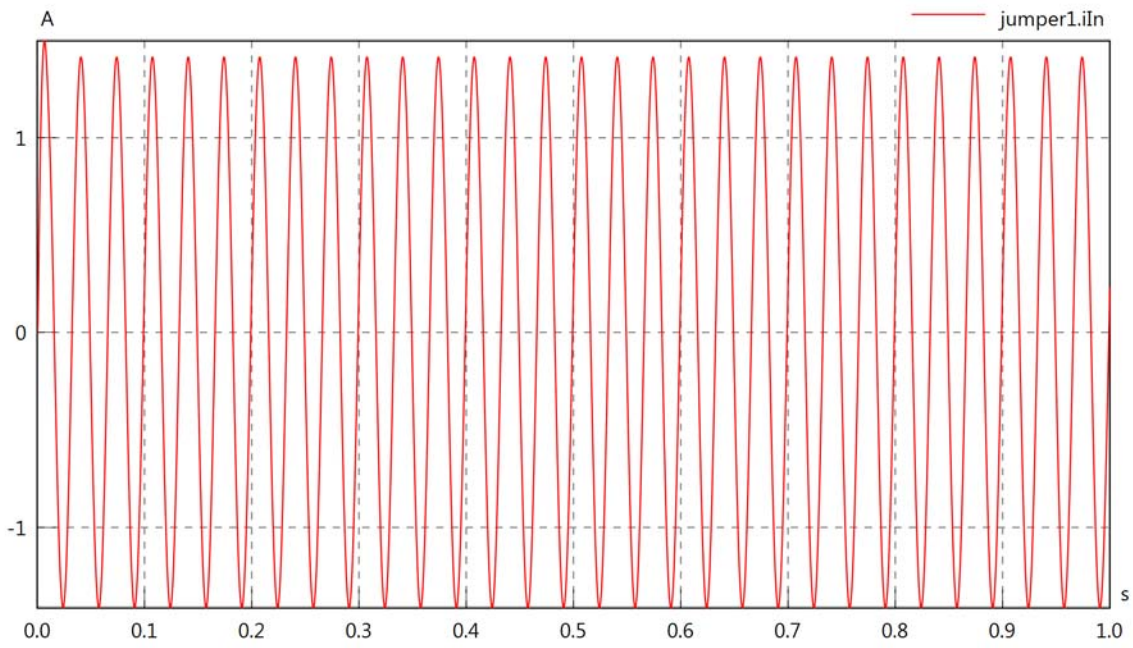

jumper1.iOut

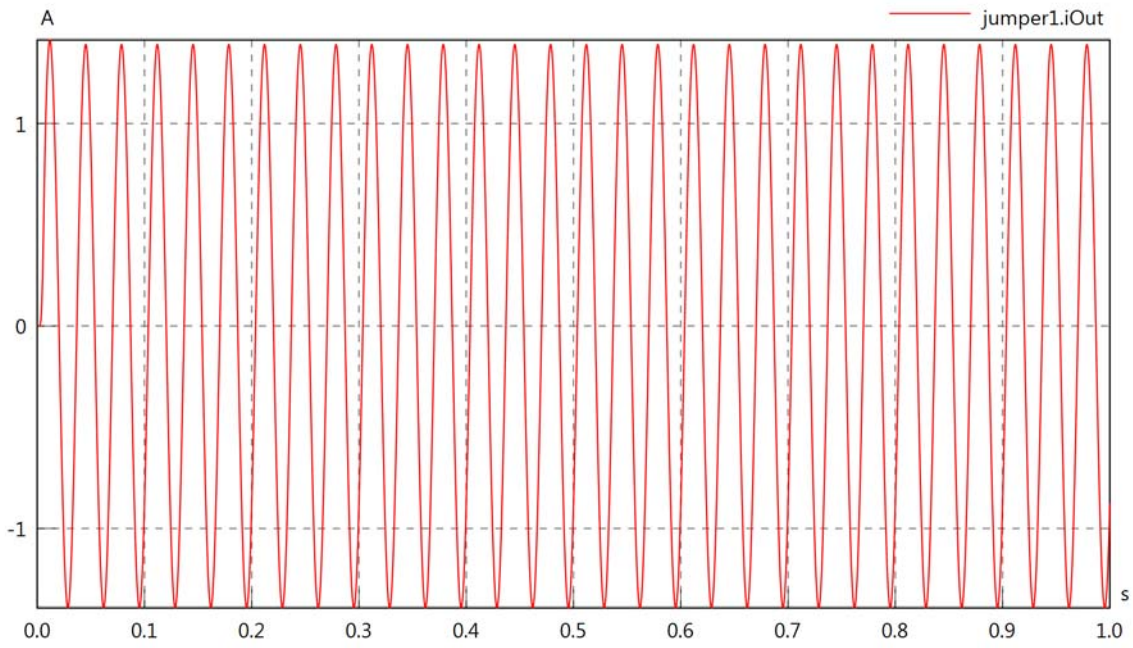

jumper1.PIn

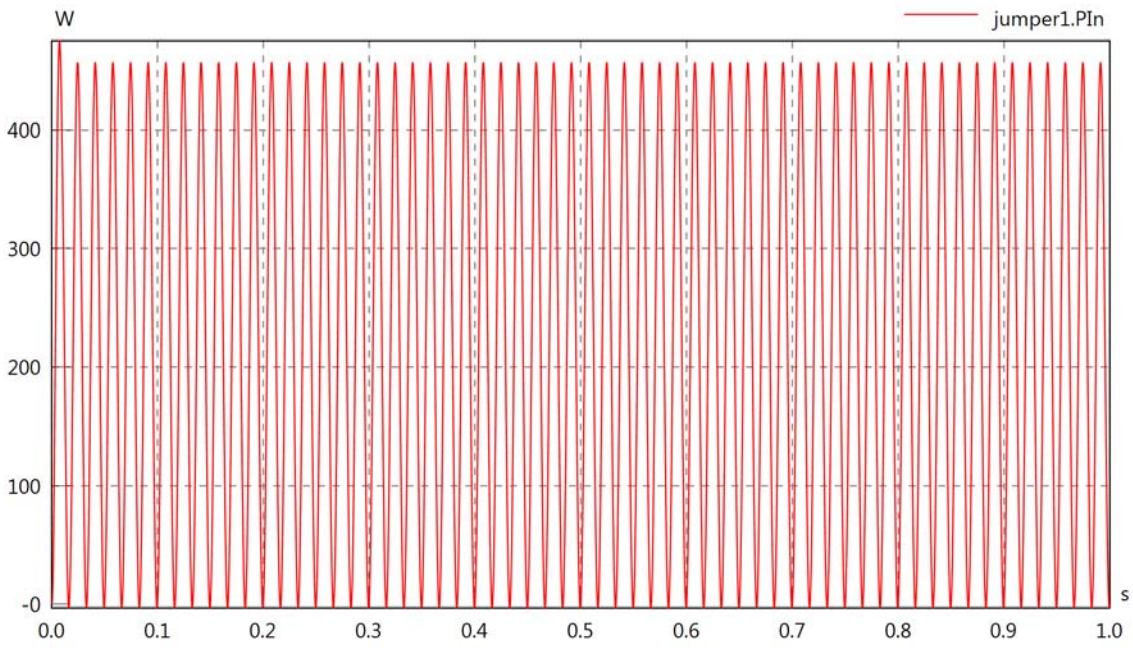

jumper1.POut

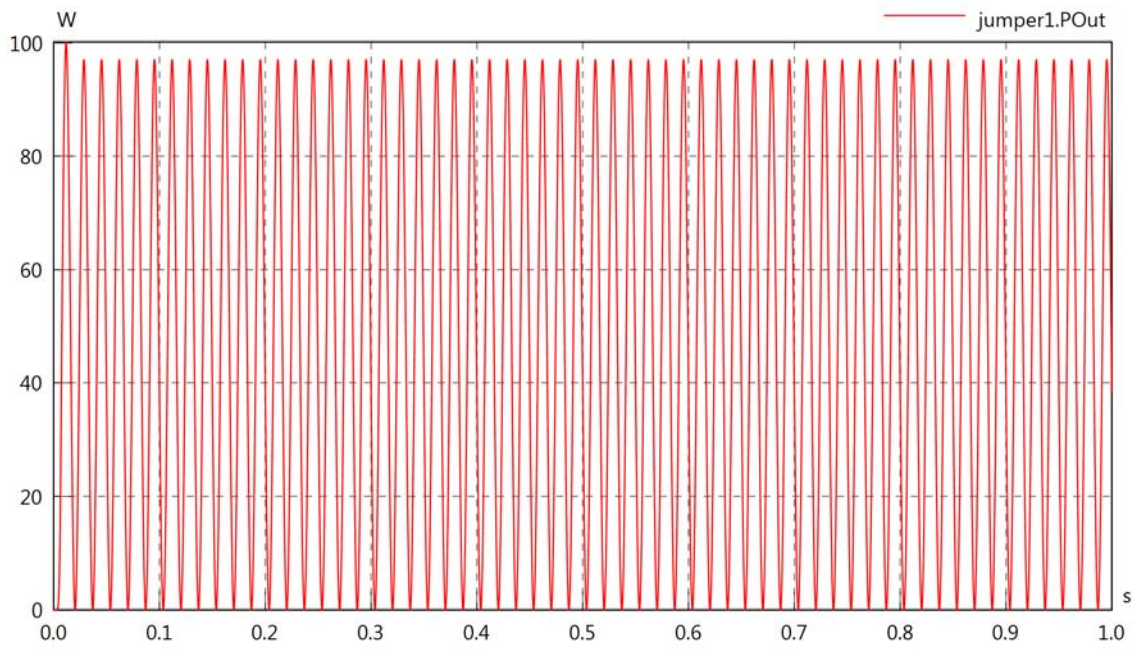

jumper1.PI

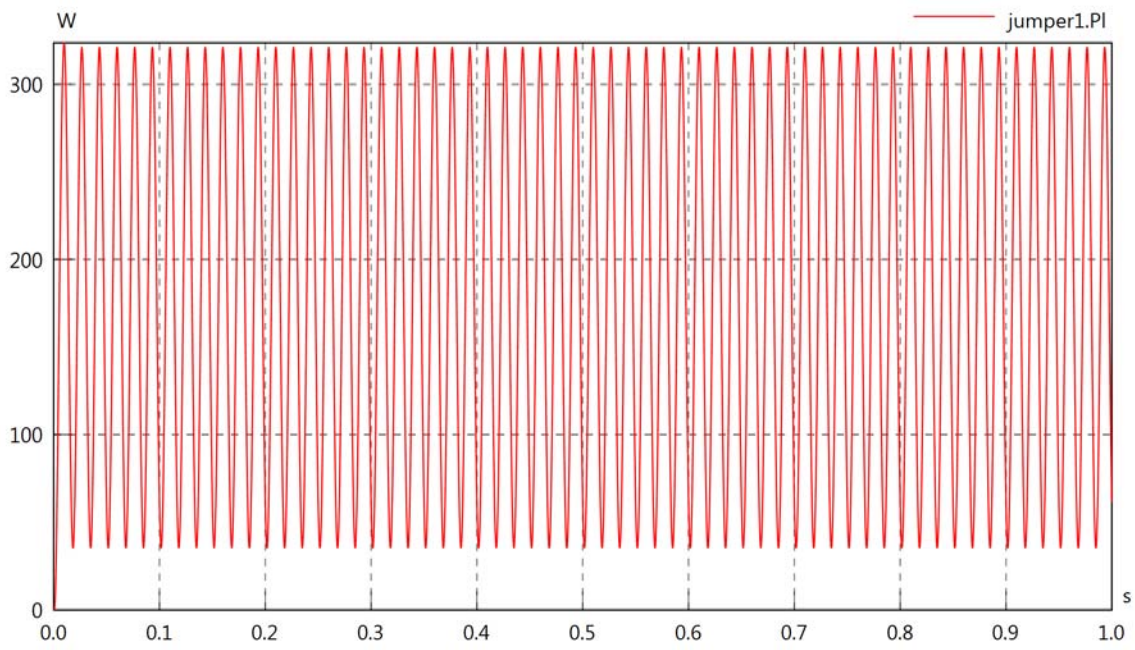
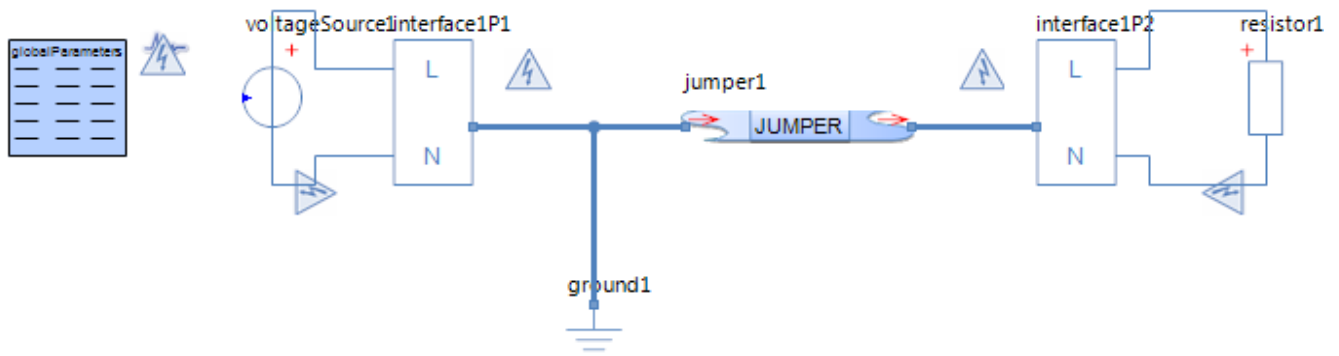

Diagram View



Jumper jumper1
Parameters

Comment	Name	Current Value	Unit
Resistance per length for each Line at 20 °C (68 °F)	r	1	[Ohm/km]
Inductance per length for each Line	l	2.5	[mH/km]
Conductance per length between Lines	g	1e-10	[1/(Ohm·m)]
Capacitance per length between Lines	c	0.3	[µF/km]
Length of Jumper for each Line	length	100	[km]
Number of Lumped Segments	N	3	[Stck]
Temperature of the conductor	temp	5	[°C]

Voltage Source voltageSource1
Parameters

Comment	Name	Current Value	Unit
Voltage	v_src	$\min(230, 630000 \cdot t) \cdot \sqrt{2} \cdot \sin(2 \cdot \pi \cdot 60 \cdot t)$	[V]

Resistor resistor1
Parameters

Comment	Name	Current Value	Unit
Resistance	R	50	[Ohm]

jumper1.rTemp

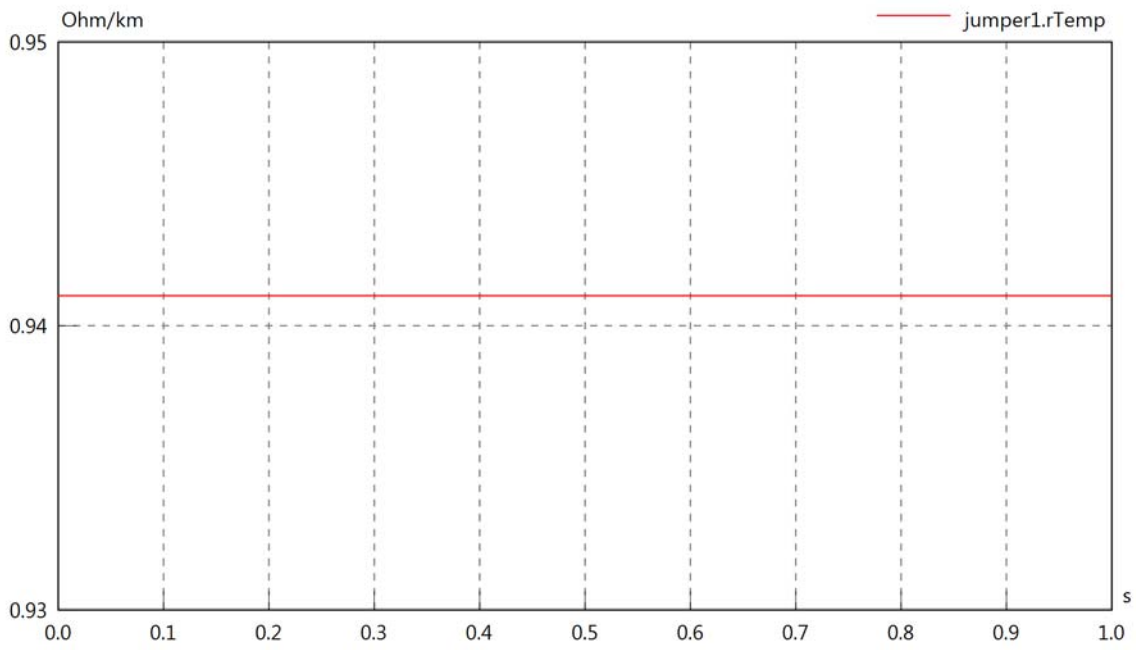

jumper1.rInternal

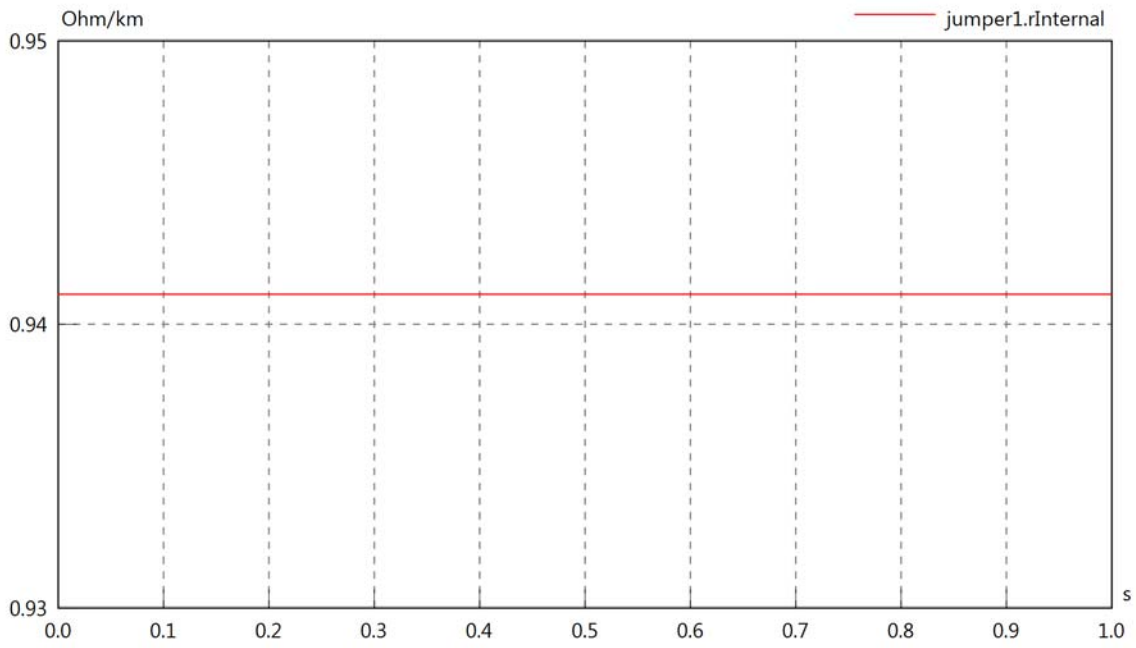

jumper1.vIn

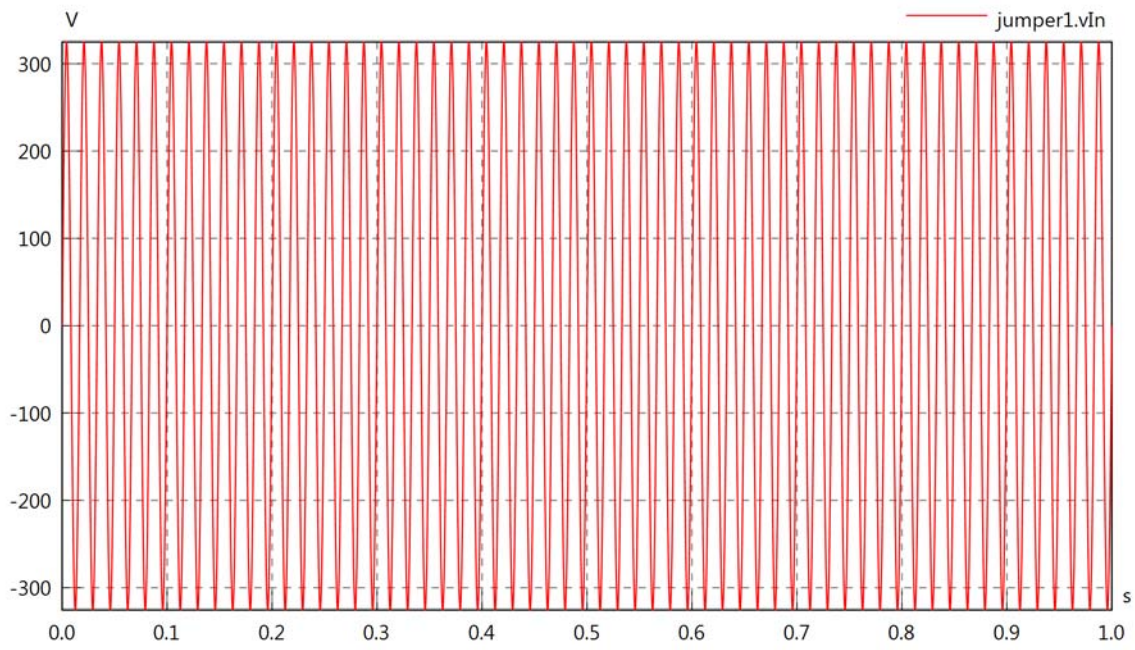

jumper1.vOut

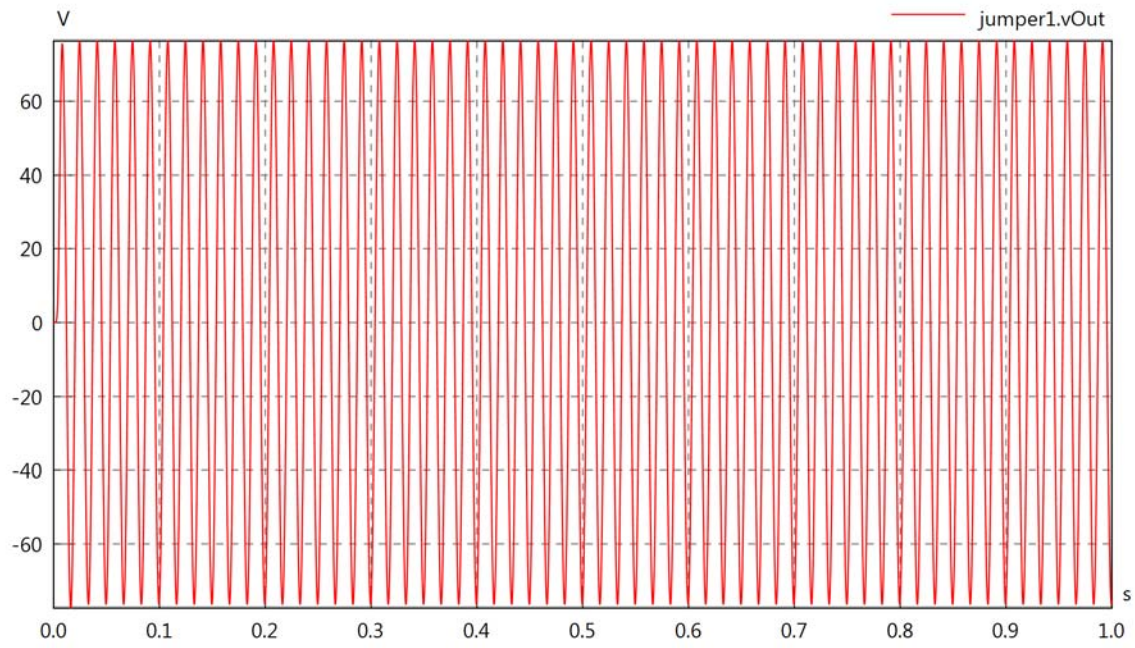

jumper1.v

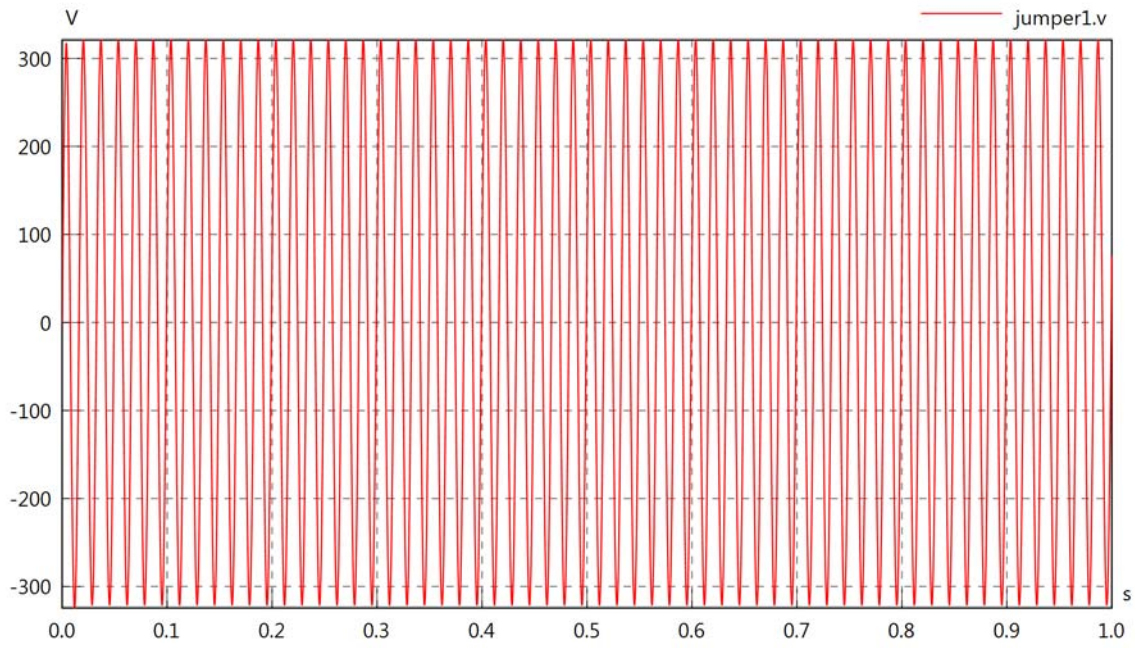

jumper1.iIn

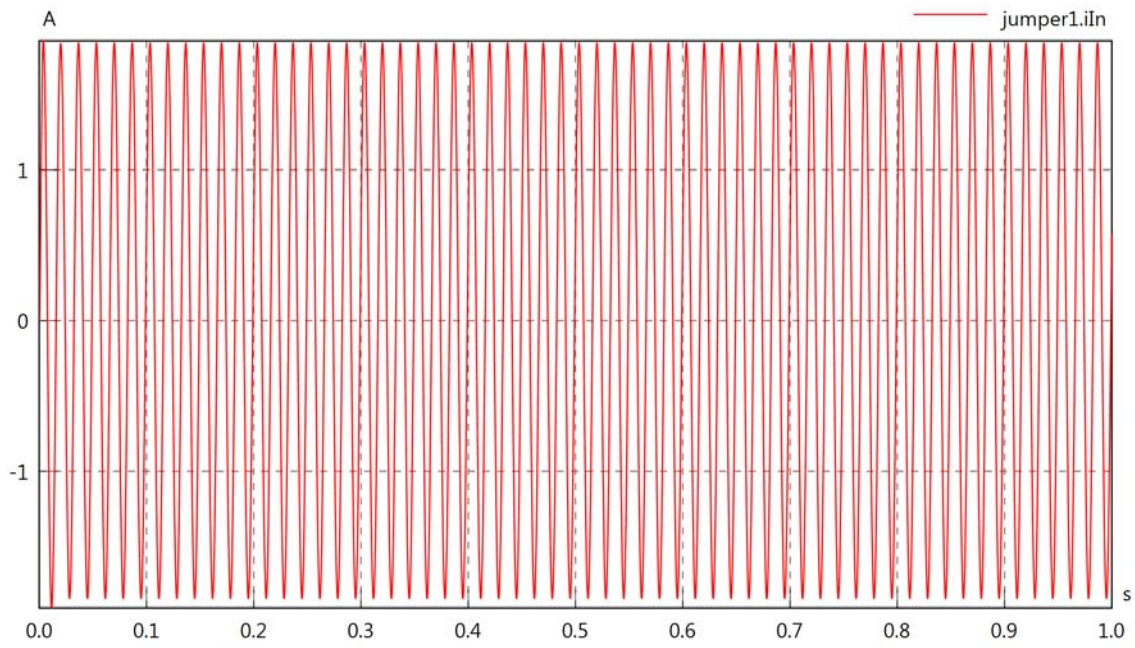

jumper1.iOut

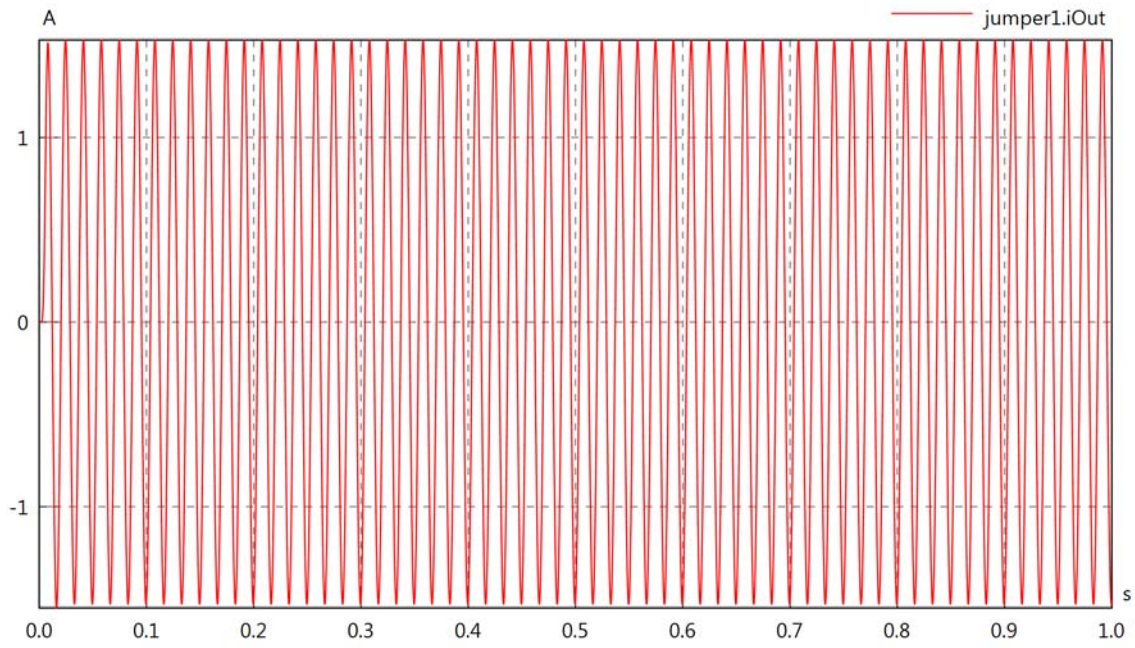

jumper1.PIn

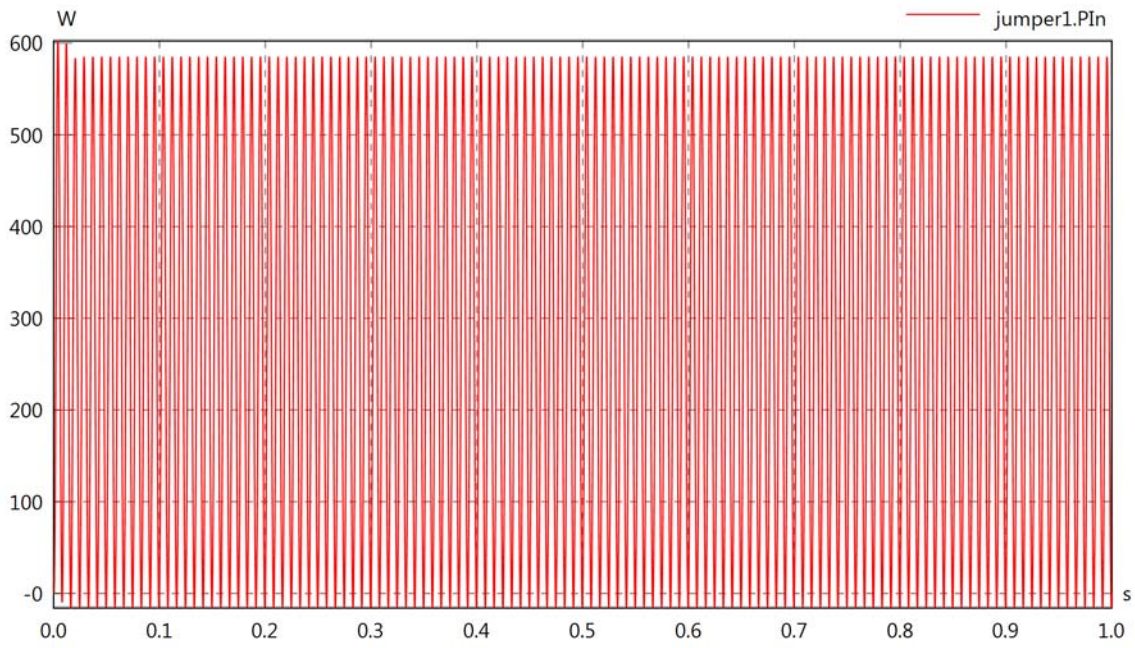

jumper1.POut

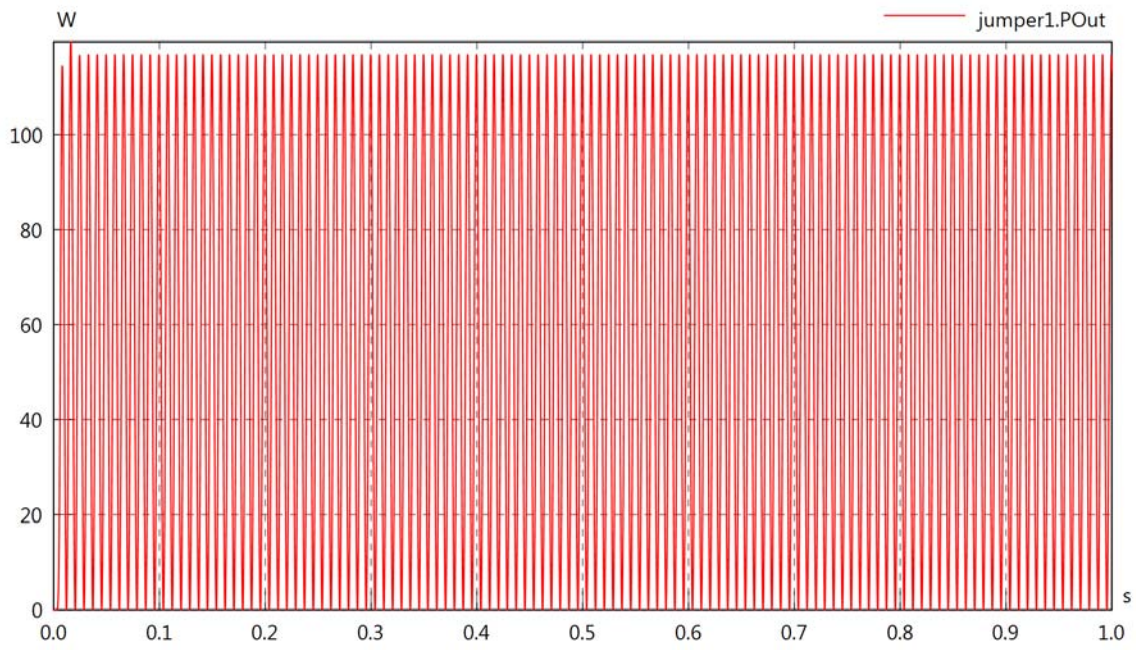

jumper1.PI

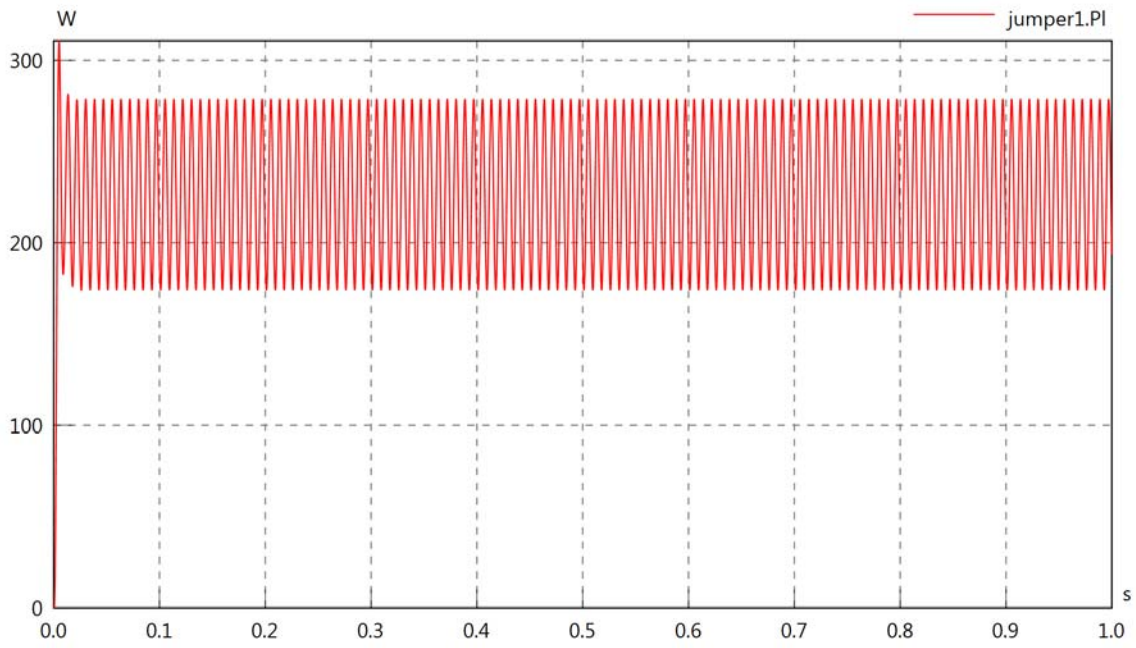
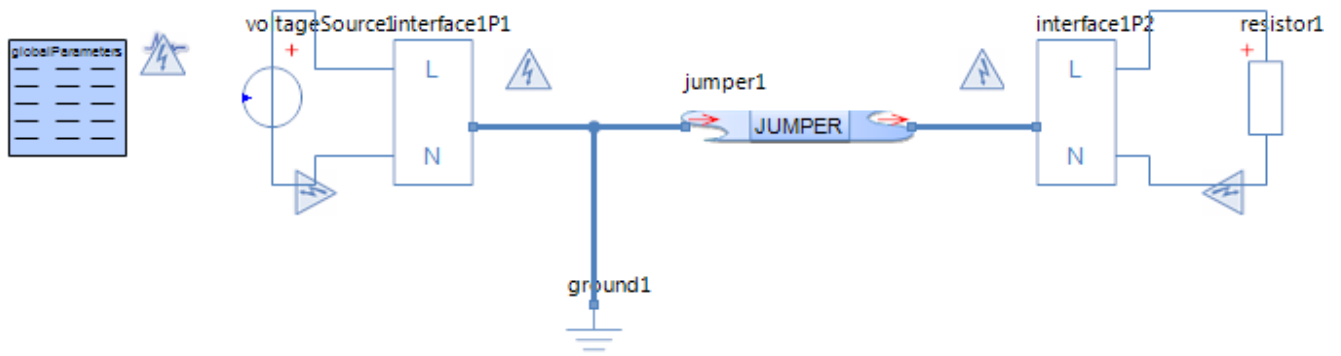

Diagram View



Jumper jumper1
Parameters

Comment	Name	Current Value	Unit
Resistance per length for each Line at 20 °C (68 °F)	r	1	[Ohm/km]
Inductance per length for each Line	l	2.5	[mH/km]
Conductance per length between Lines	g	1e-10	[1/(Ohm·m)]
Capacitance per length between Lines	c	0.3	[µF/km]
Length of Jumper for each Line	length	100	[km]
Number of Lumped Segments	N	3	[Stck]
Temperature of the conductor	temp	5	[°C]

Voltage Source voltageSource1
Parameters

Comment	Name	Current Value	Unit
Voltage	v_src	$\min(230, 630000 \cdot t) \cdot \sqrt{2} \cdot \sin(2 \cdot \pi \cdot 120 \cdot t)$	[V]

Resistor resistor1
Parameters

Comment	Name	Current Value	Unit
Resistance	R	50	[Ohm]

jumper1.rTemp

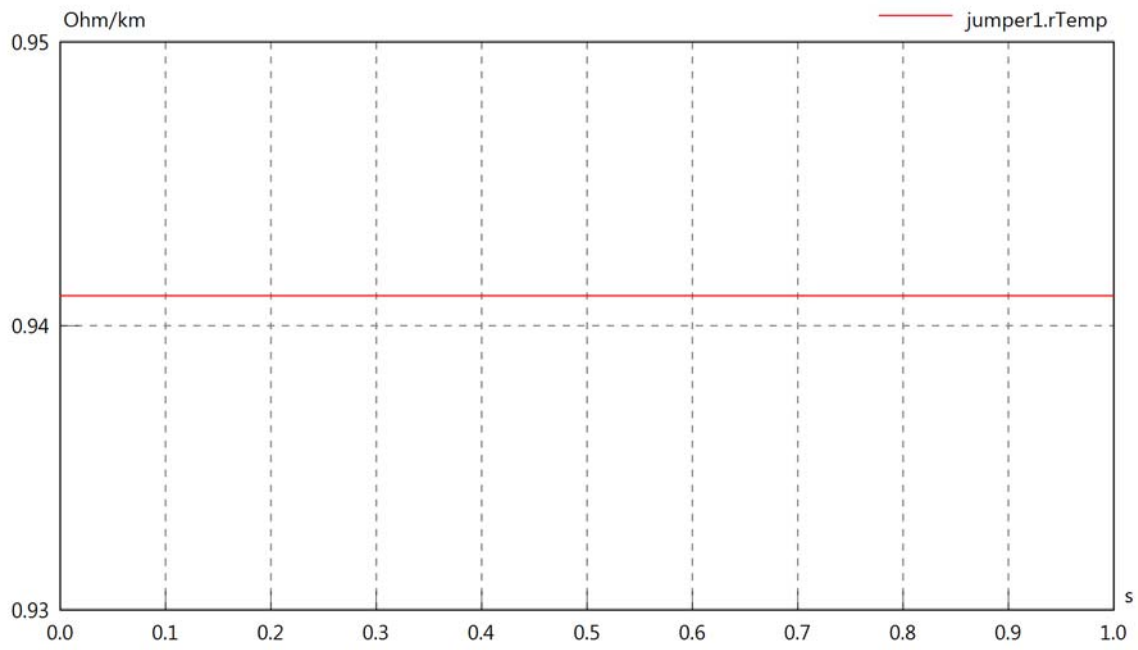

jumper1.rInternal

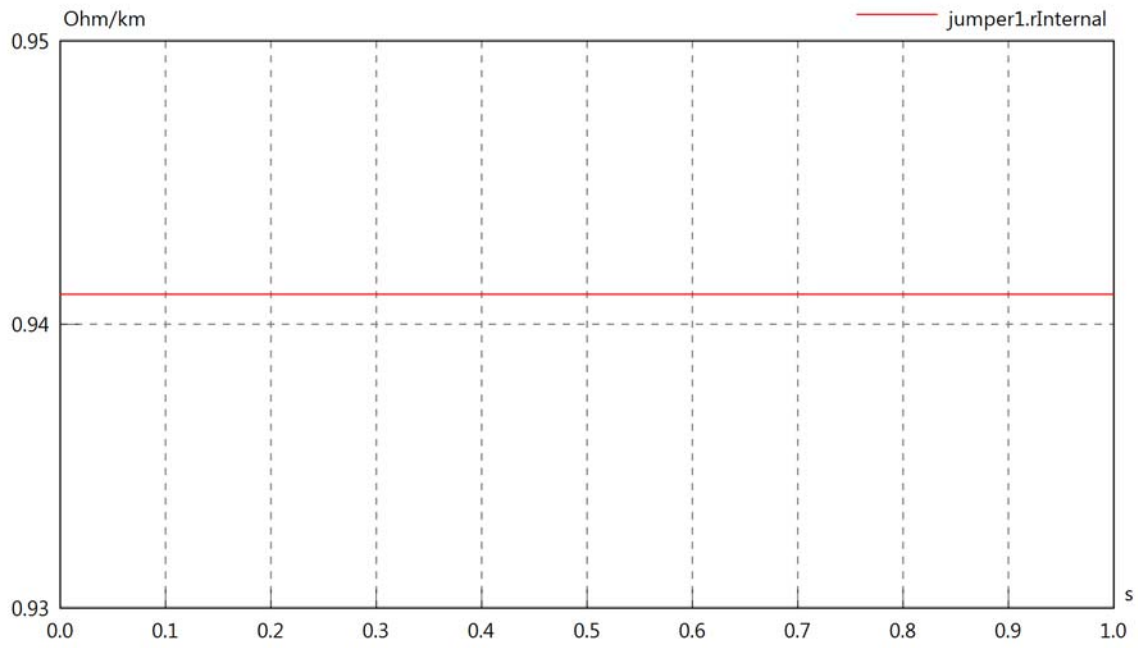

jumper1.vIn

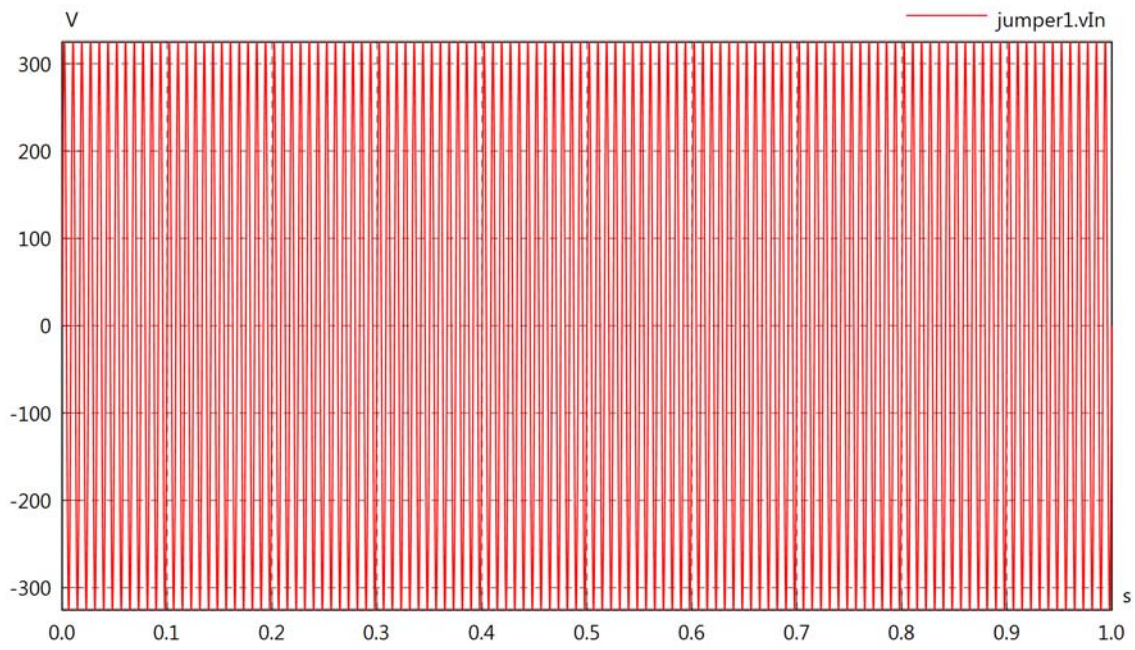

jumper1.vOut

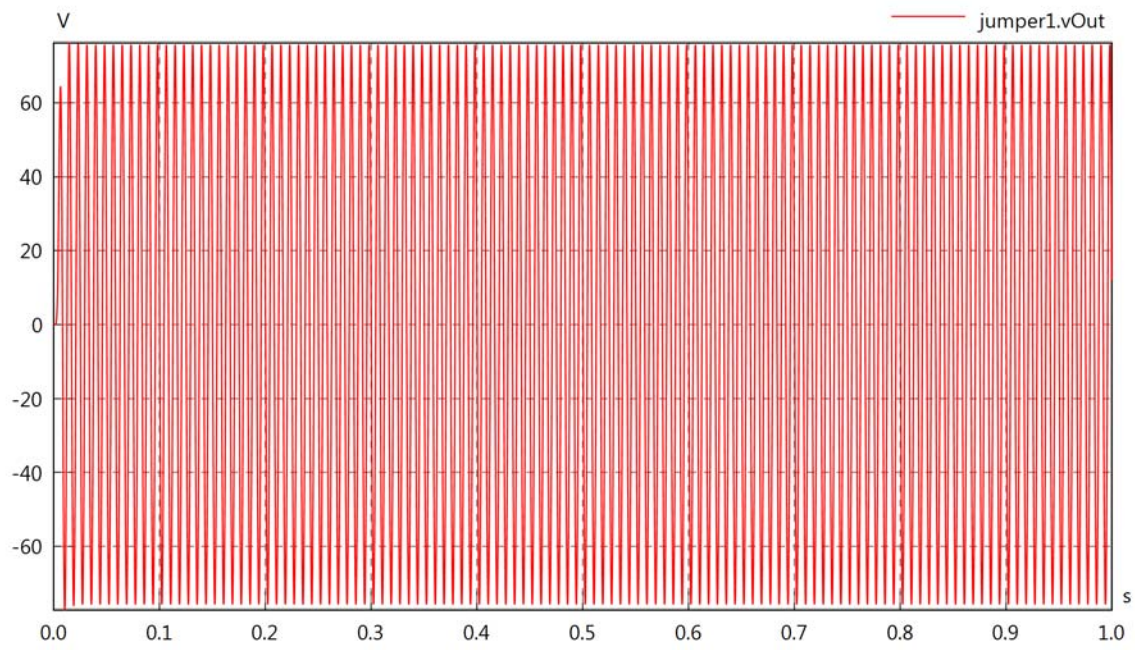

jumper1.v

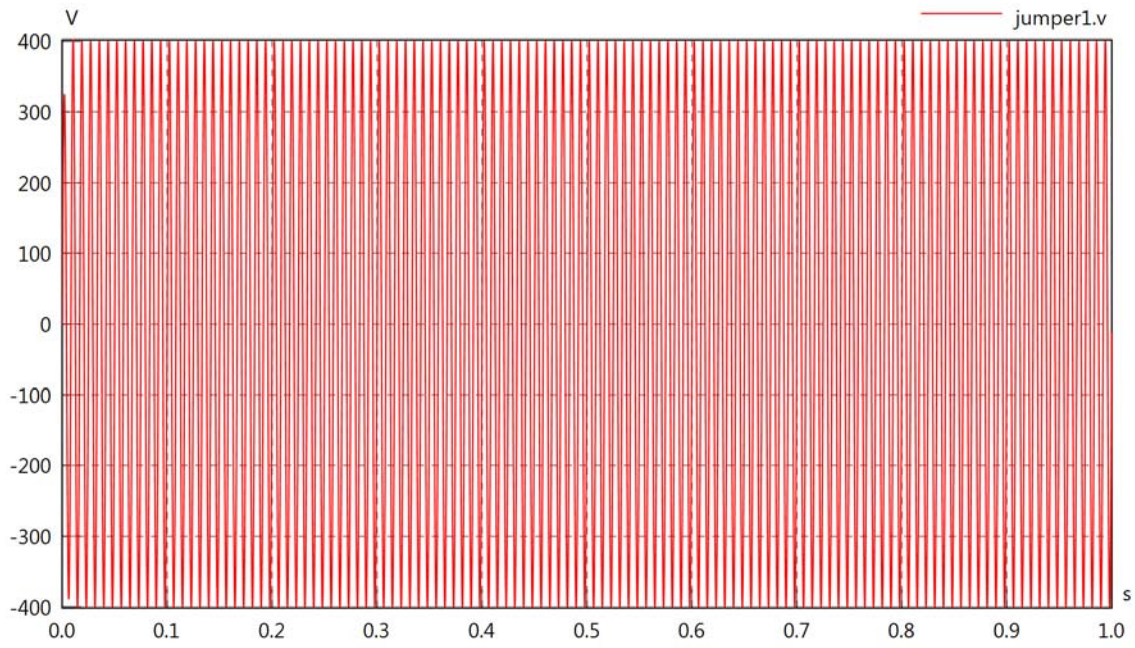

jumper1.iIn

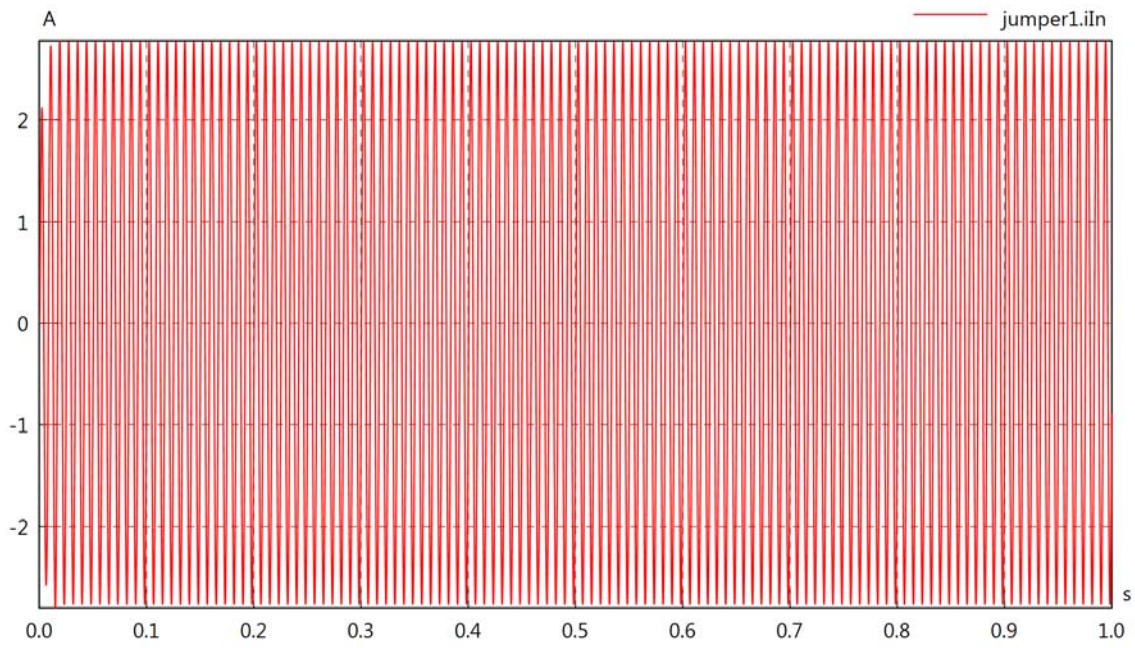

jumper1.iOut

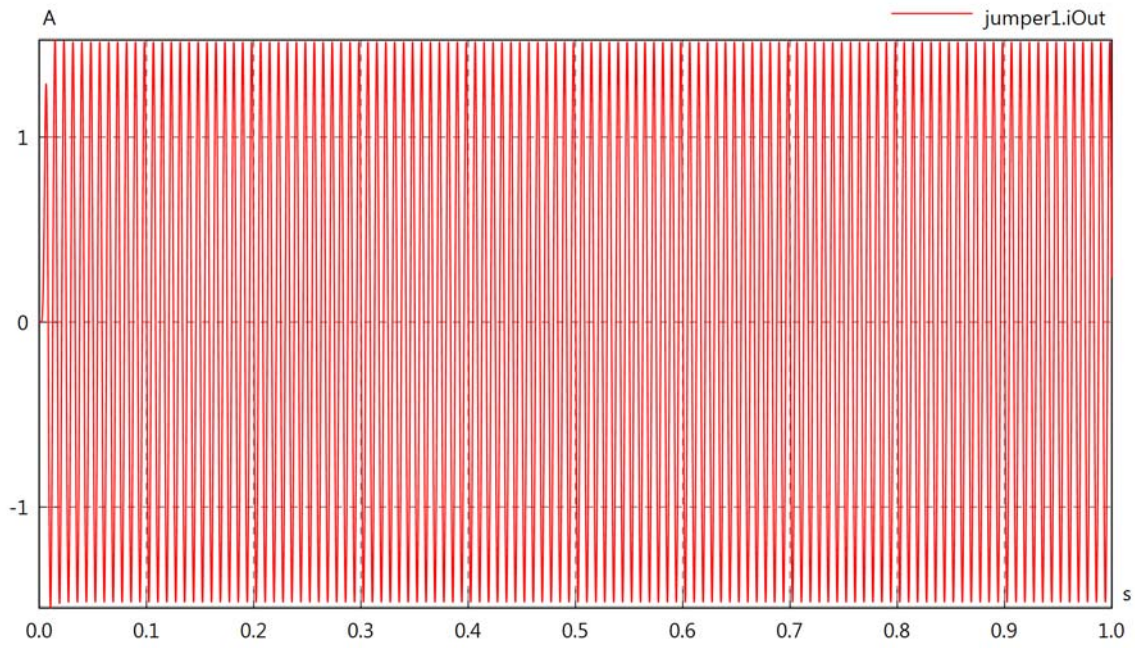

jumper1.PIn

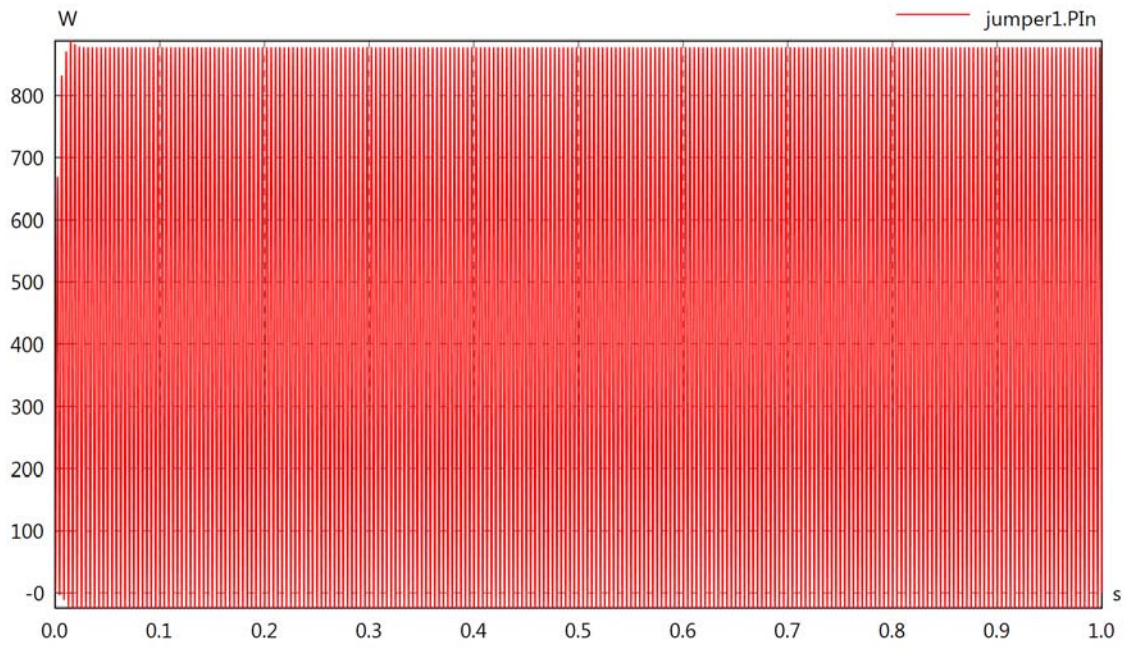

jumper1.POut

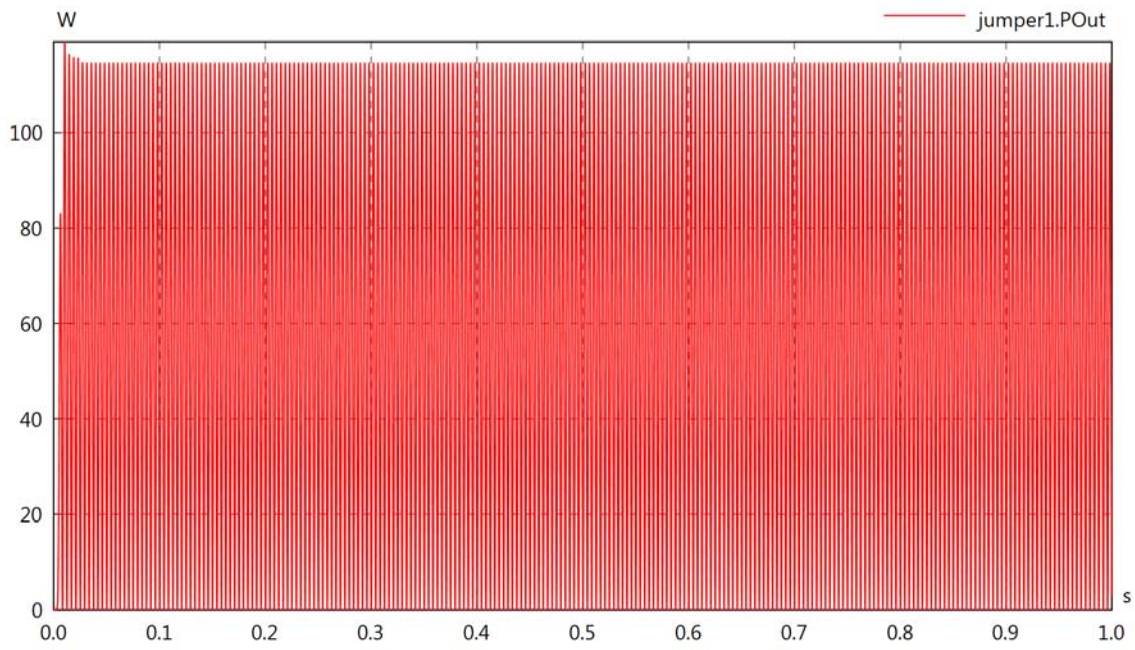

jumper1.PI

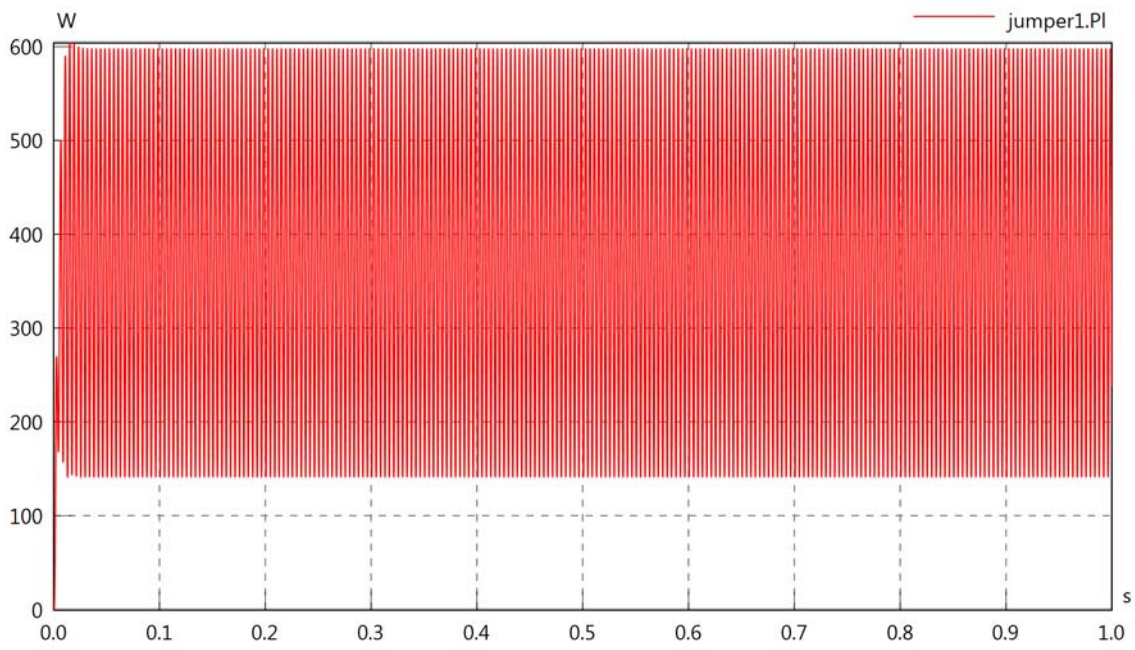
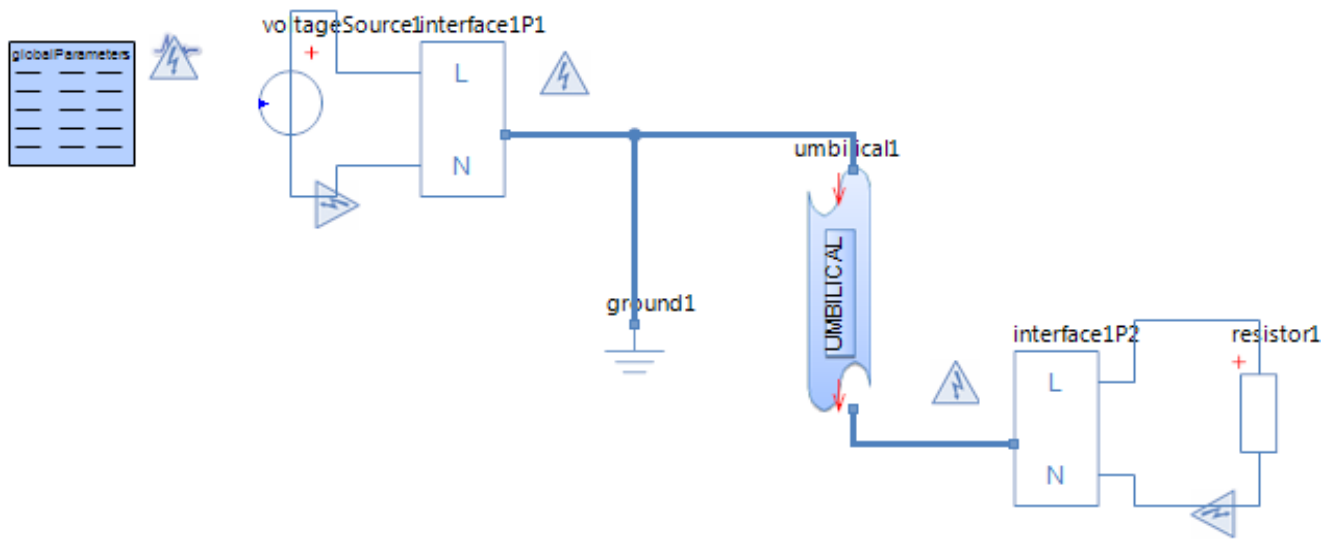

Diagram View



Voltage Source voltageSource1
Parameters

Comment	Name	Current Value	Unit
Voltage	v_src	$\min(230, 630000 \cdot t) \cdot \sqrt{2} \cdot \sin(2 \cdot \pi \cdot 30 \cdot t)$	[V]

Resistor resistor1
Parameters

Comment	Name	Current Value	Unit
Resistance	R	50	[Ohm]

Umbilical umbilical1
Parameters

Comment	Name	Current Value	Unit
Resistance per length for each Line at 20 °C (68 °F)	r	1	[Ohm/km]
Inductance per length for each Line	l	2.5	[mH/km]
Conductance per length between Lines	g	1e-10	[1/(Ohm·m)]
Capacitance per length between Lines	c	0.3	[µF/km]
Length of Umbilical for each Line	length	100	[km]
Number of Lumped Segments	N	3	[Stck]
Temperature of the conductor	temp	5	[°C]

umbilical1.rTemp

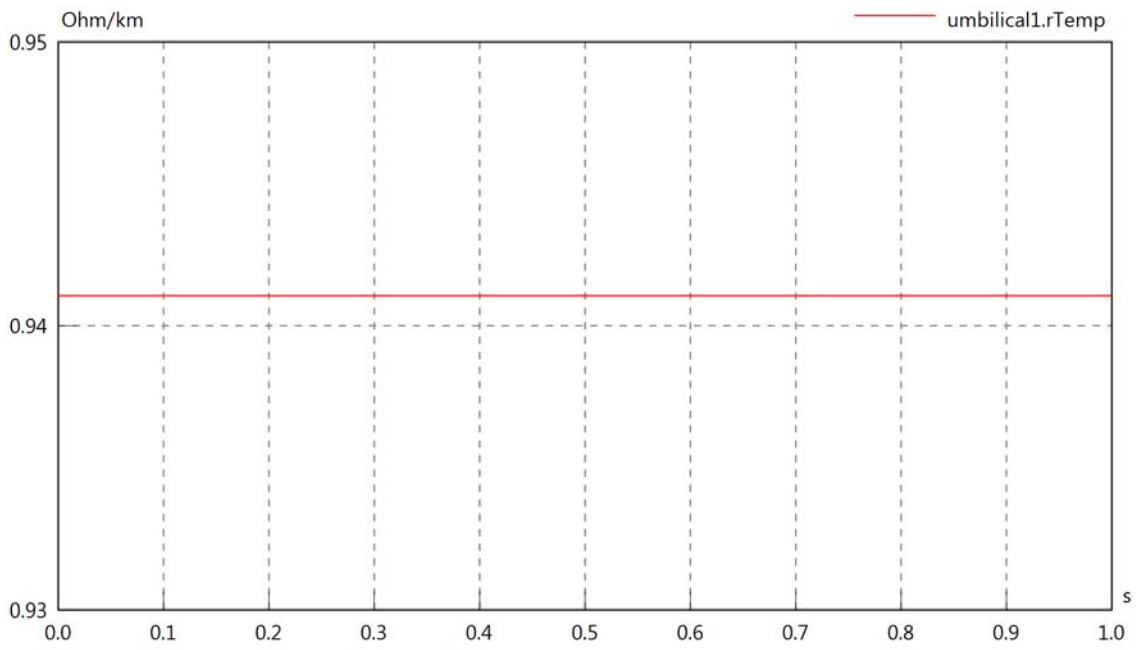

umbilical1.rInternal

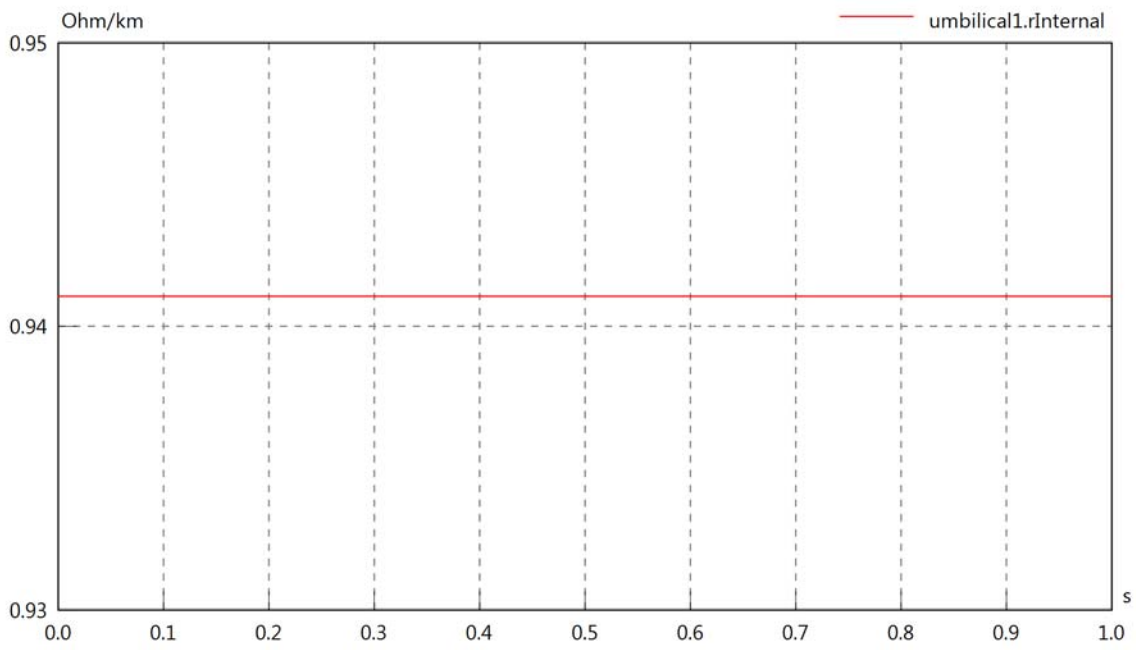

umbilical1.vIn

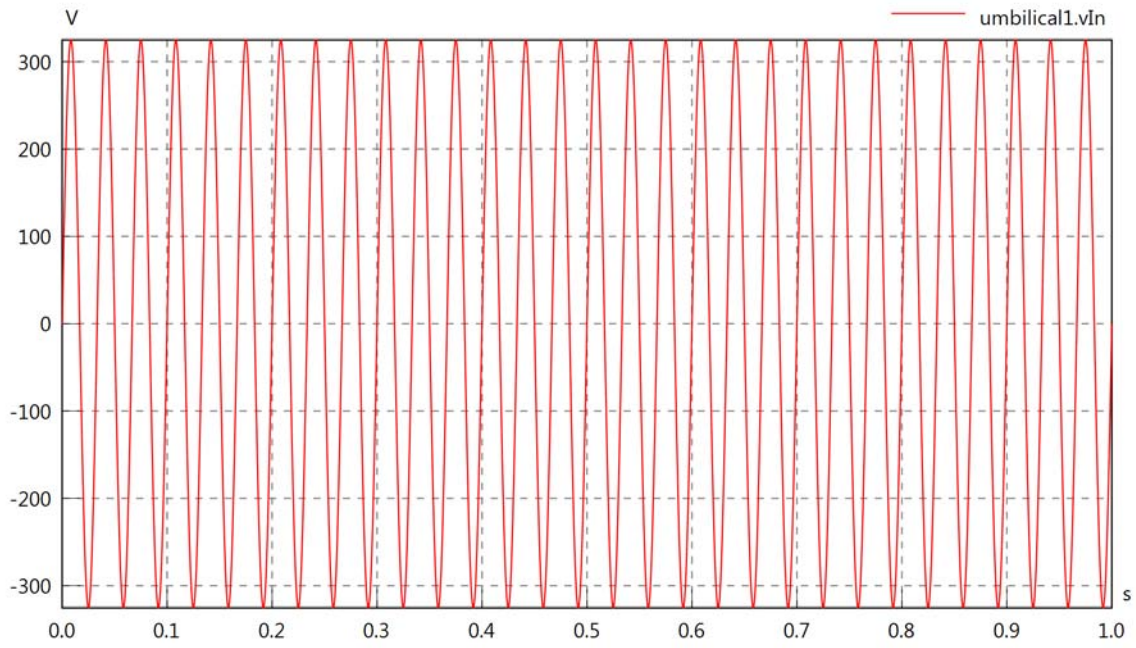

umbilical1.vOut

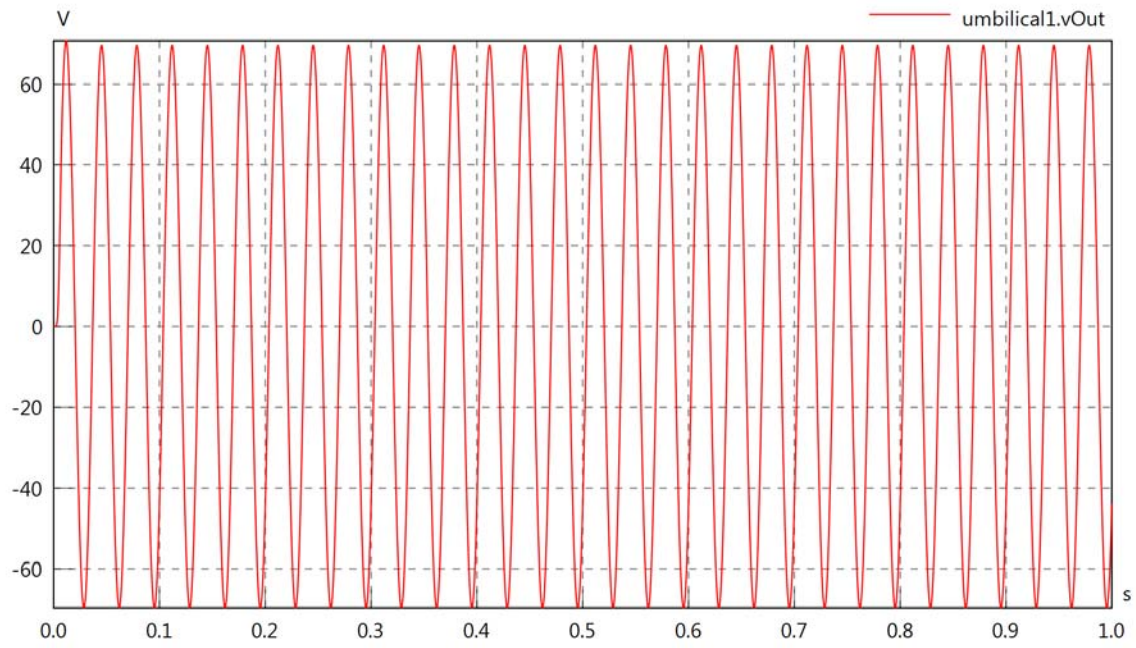

umbilical1.v

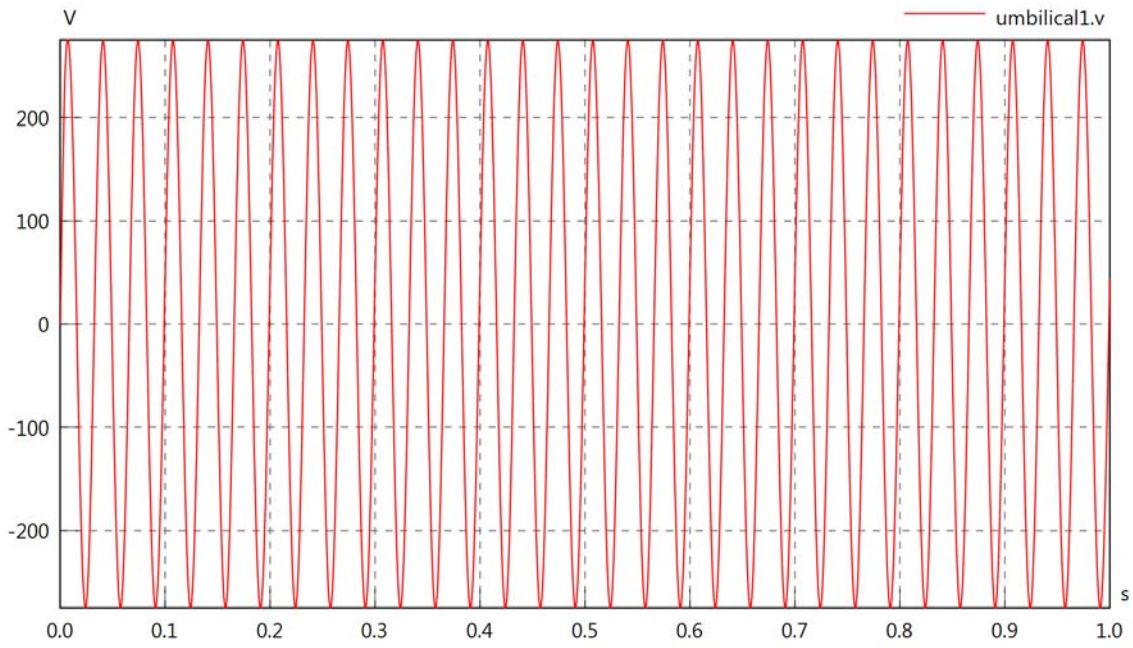

umbilical1.iIn

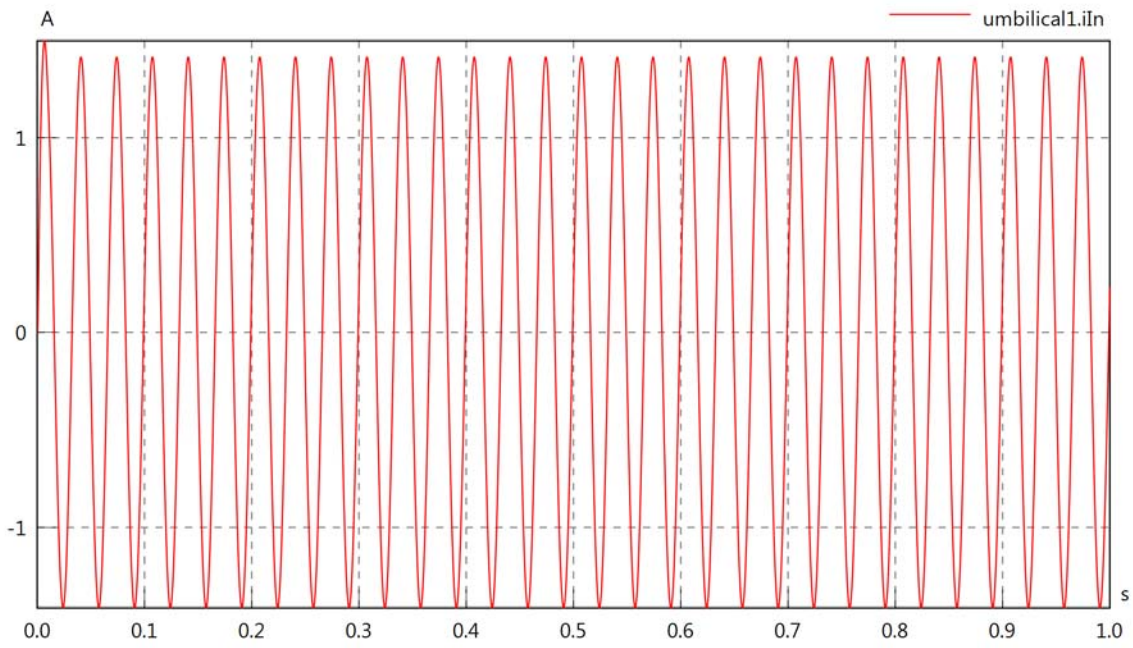

umbilical1.iOut

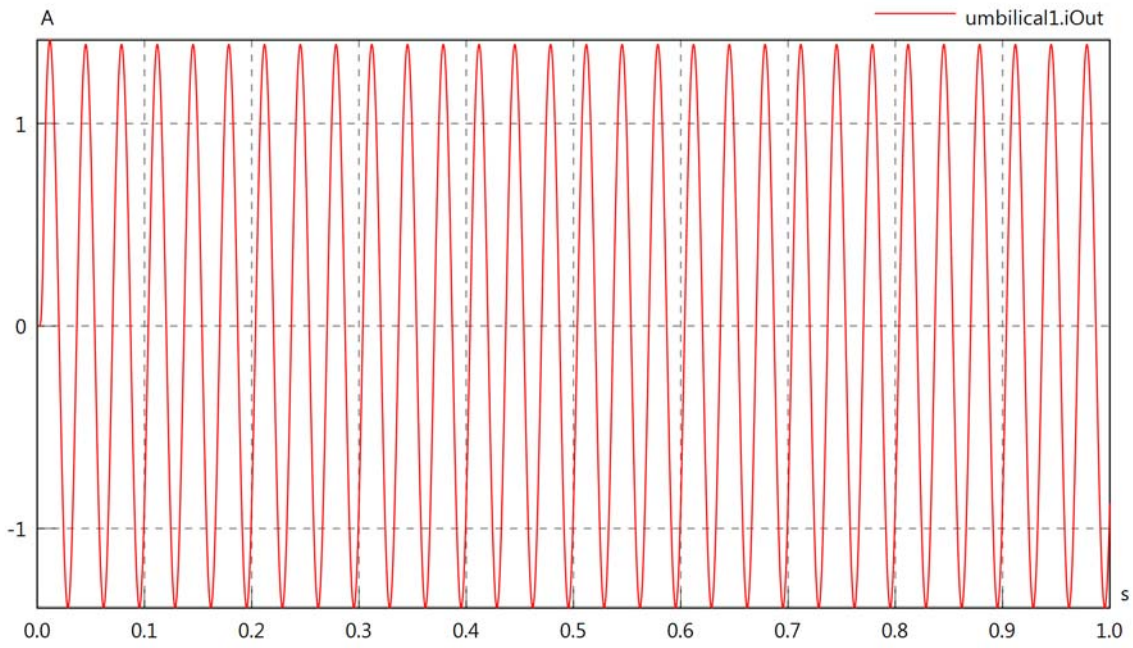

umbilical1.PIn

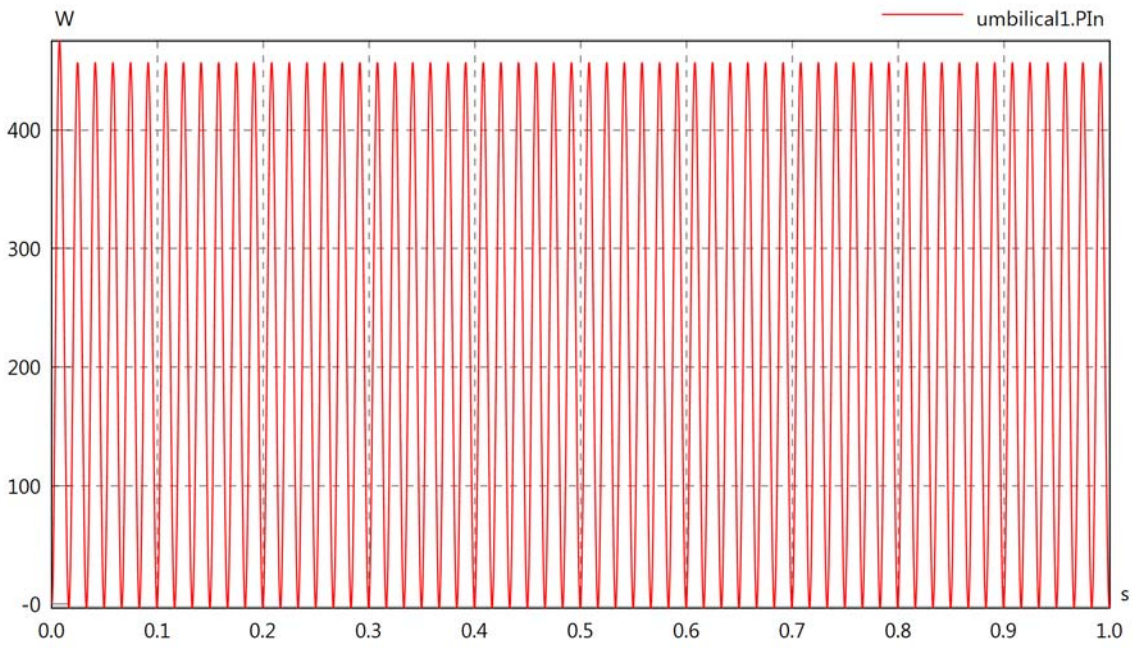

umbilical1.POut

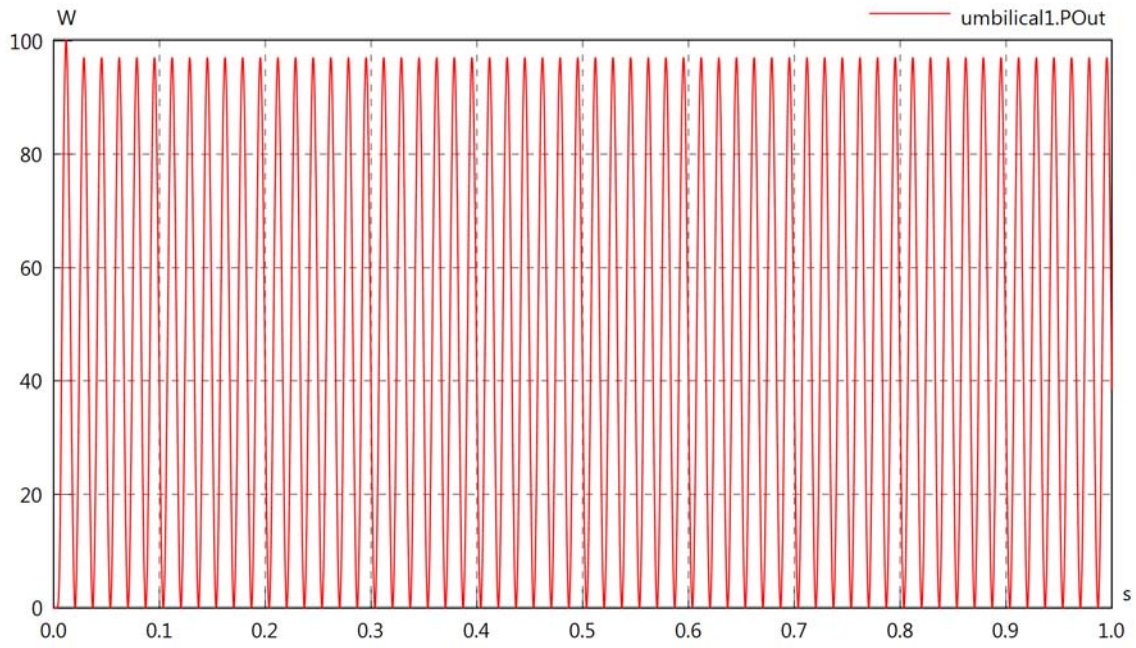

umbilical1.PI

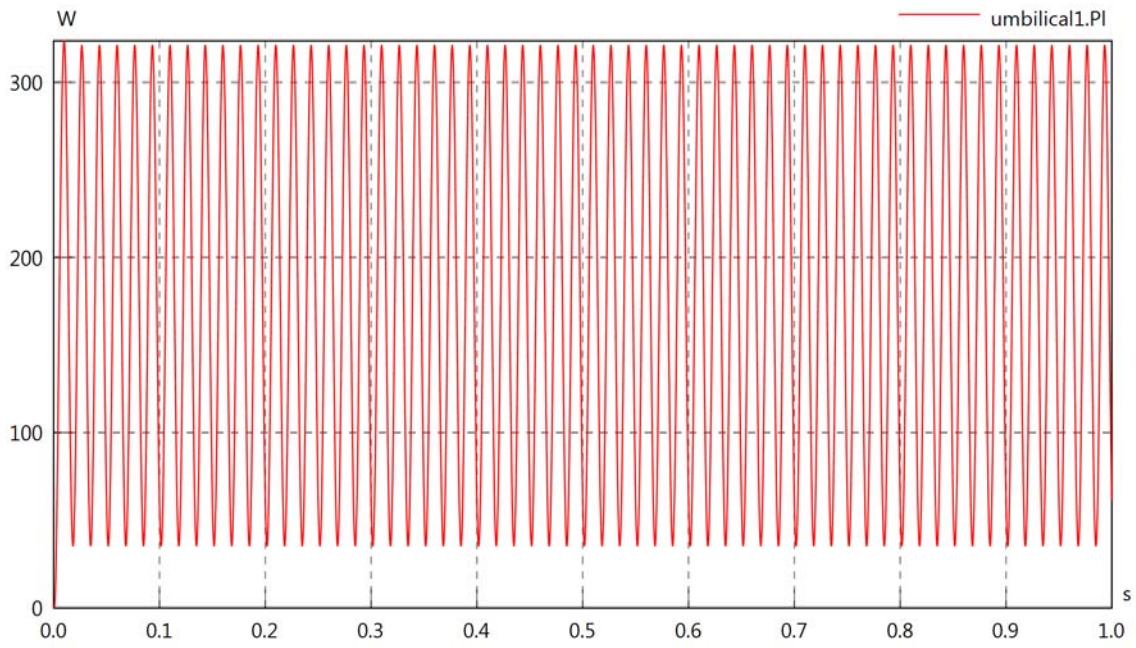
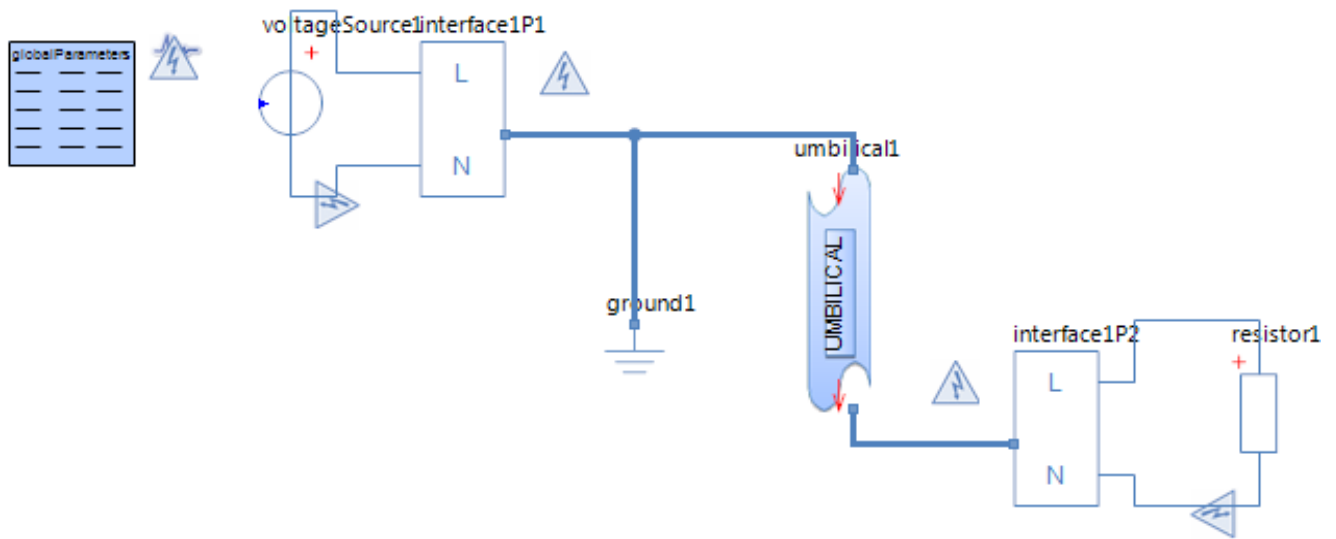

Diagram View



Voltage Source voltageSource1
Parameters

Comment	Name	Current Value	Unit
Voltage	v_src	$\min(230, 630000 \cdot t) \cdot \sqrt{2} \cdot \sin(2 \cdot \pi \cdot 60 \cdot t)$	[V]

Resistor resistor1
Parameters

Comment	Name	Current Value	Unit
Resistance	R	50	[Ohm]

Umbilical umbilical1
Parameters

Comment	Name	Current Value	Unit
Resistance per length for each Line at 20 °C (68 °F)	r	1	[Ohm/km]
Inductance per length for each Line	l	2.5	[mH/km]
Conductance per length between Lines	g	1e-10	[1/(Ohm·m)]
Capacitance per length between Lines	c	0.3	[µF/km]
Length of Umbilical for each Line	length	100	[km]
Number of Lumped Segments	N	3	[Stck]
Temperature of the conductor	temp	5	[°C]

umbilical1.rTemp

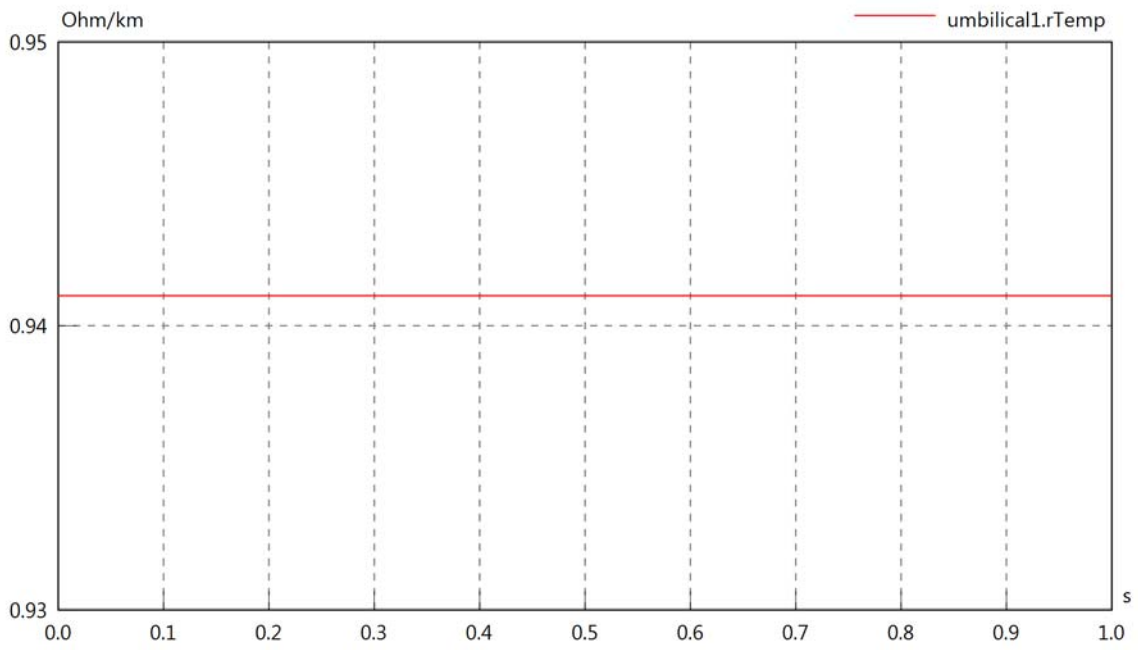

umbilical1.rInternal

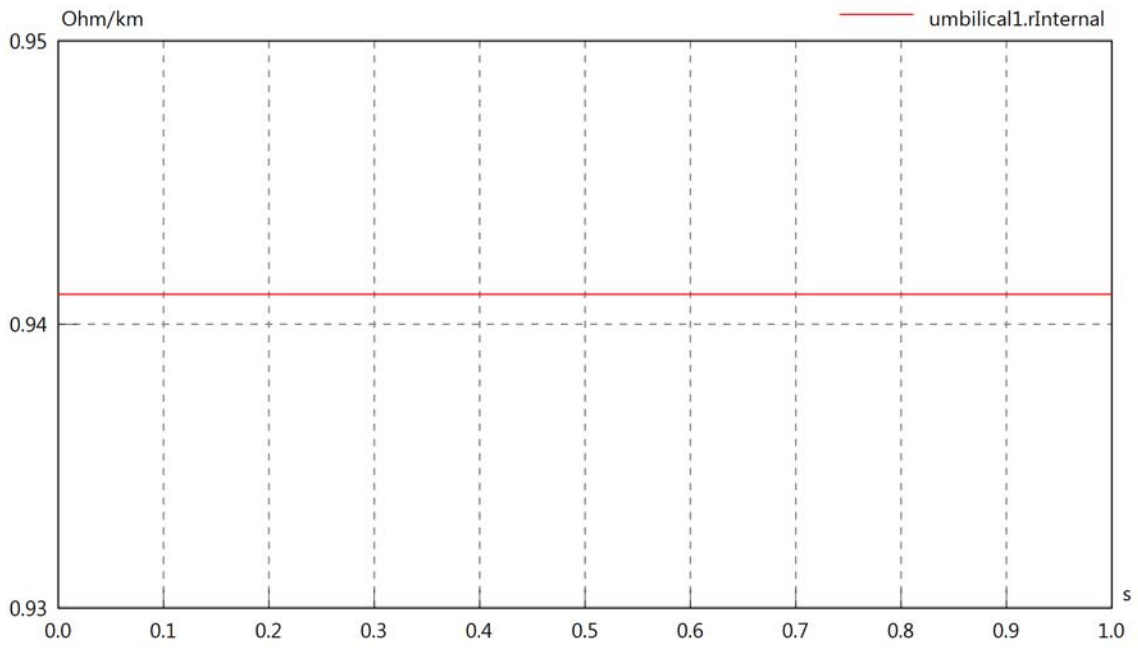

umbilical1.vIn

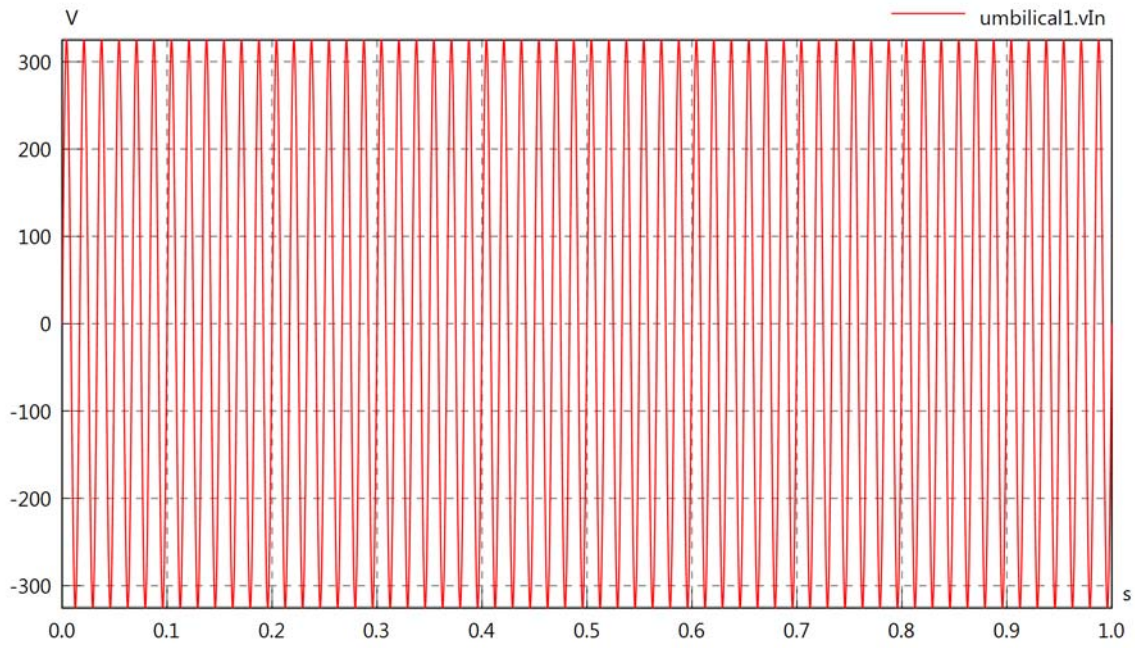

umbilical1.vOut

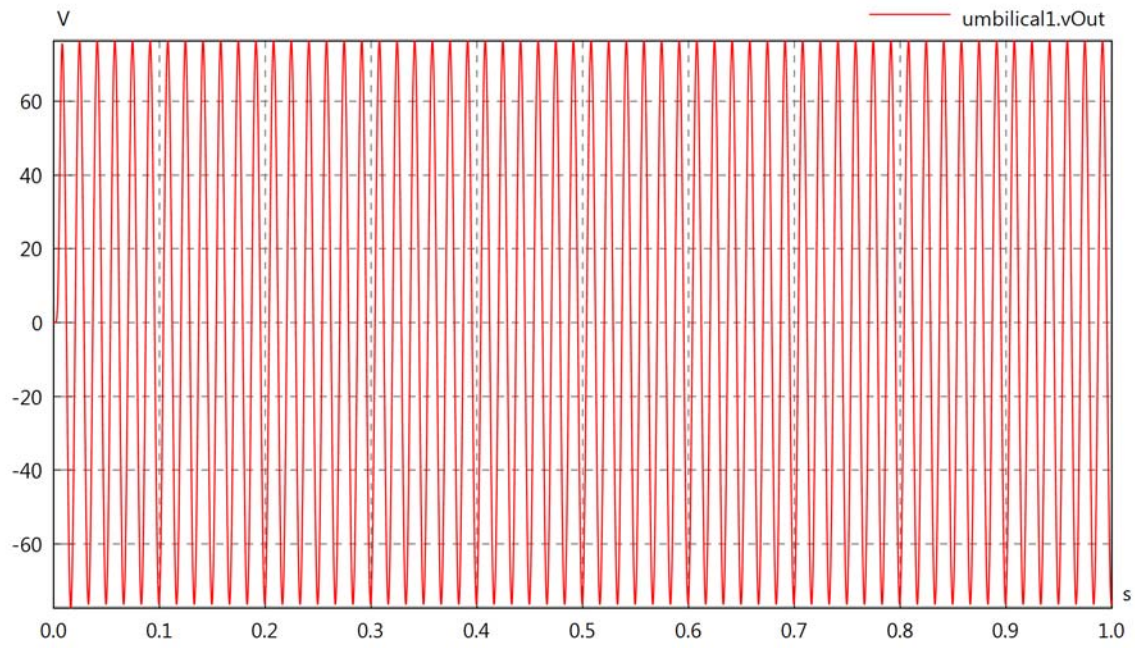

umbilical1.v

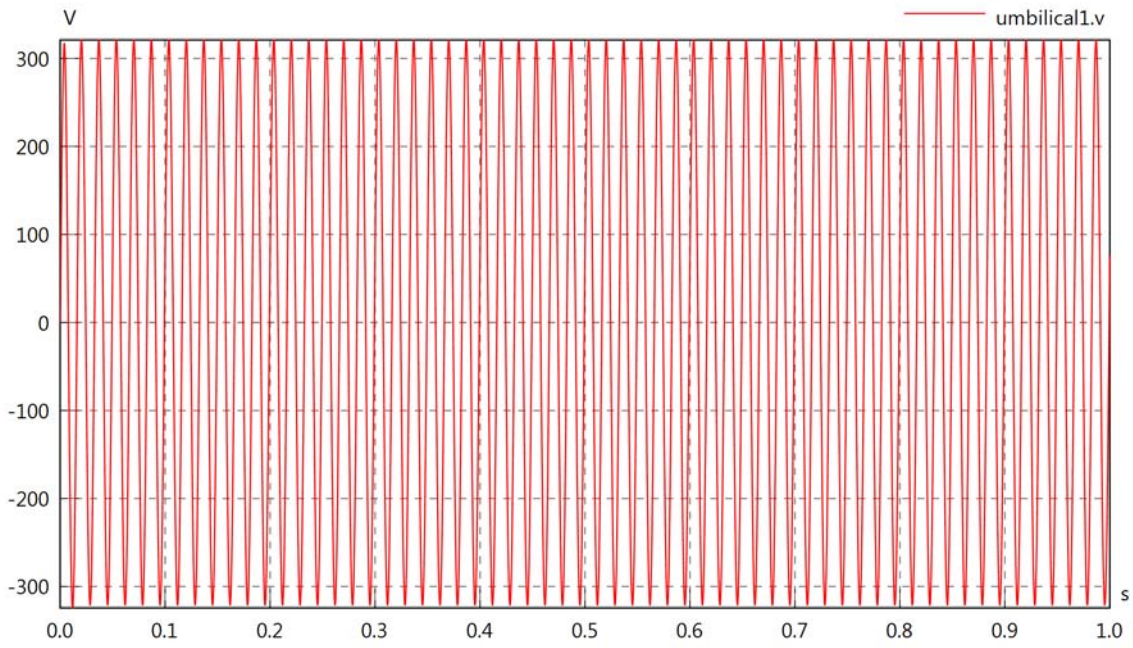

umbilical1.iIn

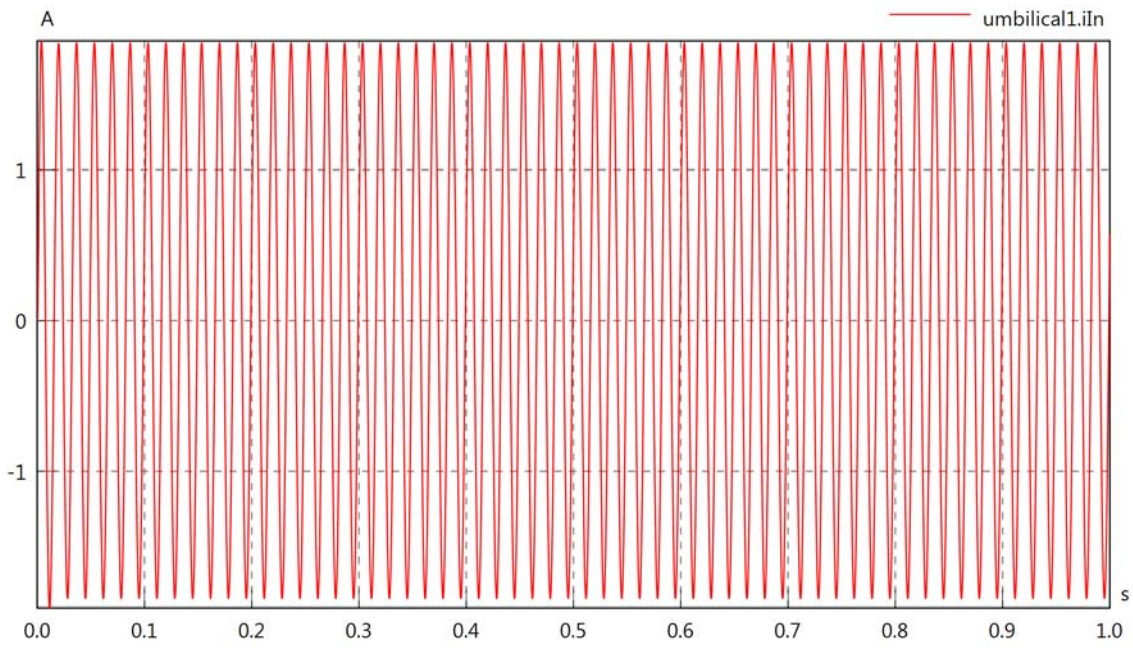

umbilical1.iOut

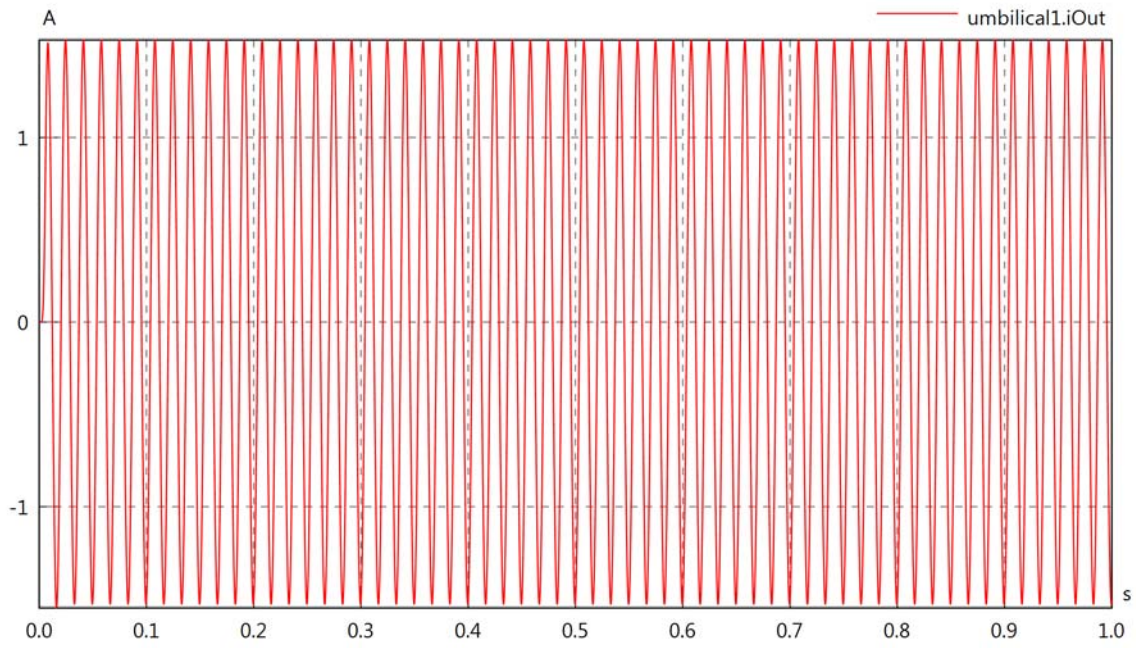

umbilical1.PIn

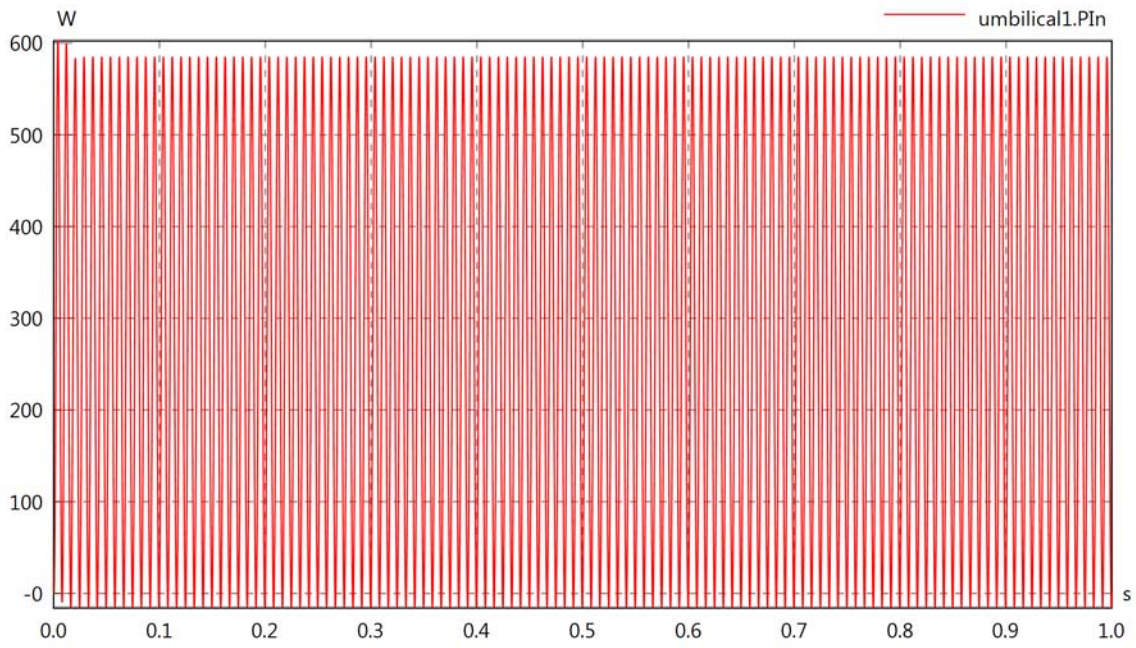

umbilical1.POut

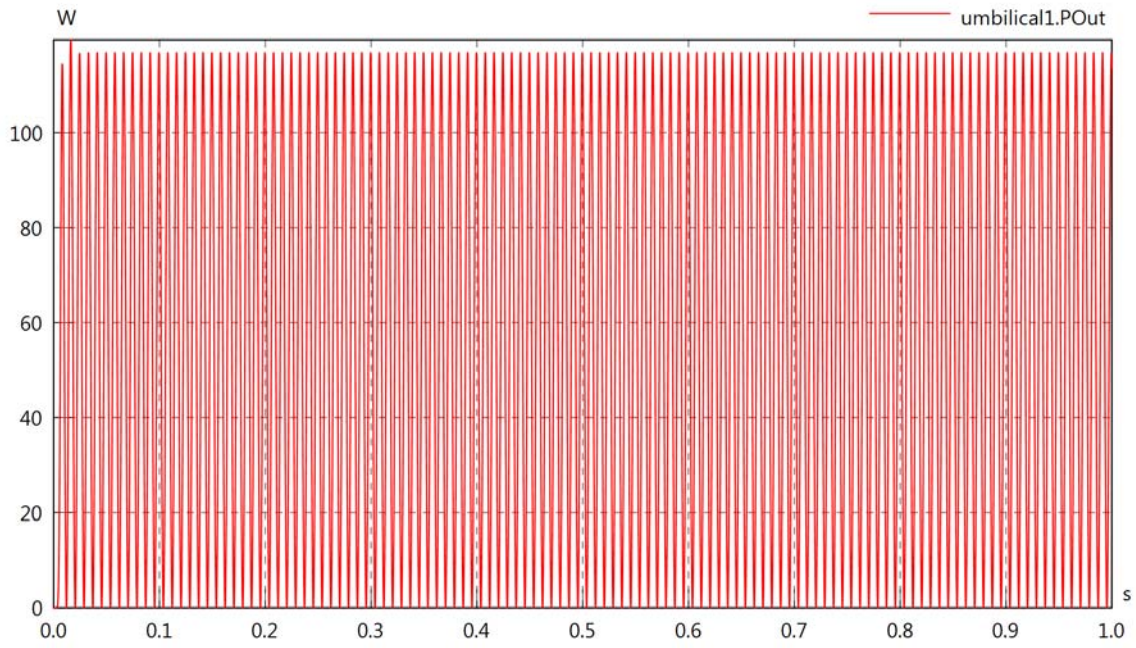

umbilical1.PI

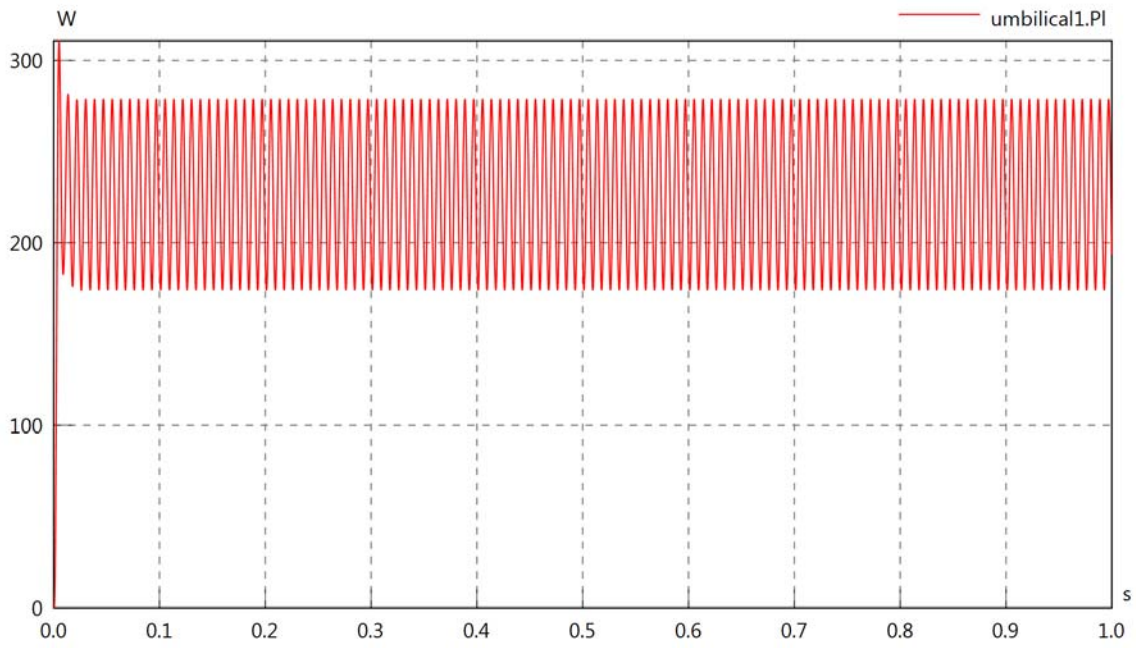
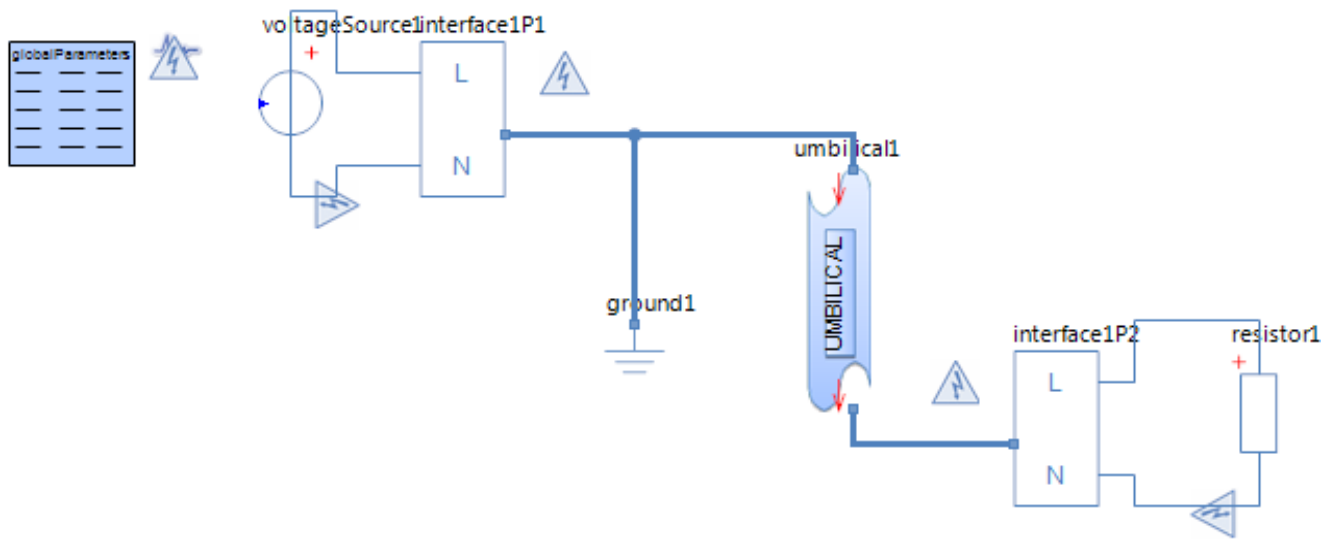

Diagram View



Voltage Source voltageSource1
Parameters

Comment	Name	Current Value	Unit
Voltage	v_src	$\min(230, 630000 \cdot t) \cdot \sqrt{2} \cdot \sin(2 \cdot \pi \cdot 120 \cdot t)$	[V]

Resistor resistor1
Parameters

Comment	Name	Current Value	Unit
Resistance	R	50	[Ohm]

Umbilical umbilical1
Parameters

Comment	Name	Current Value	Unit
Resistance per length for each Line at 20 °C (68 °F)	r	1	[Ohm/km]
Inductance per length for each Line	l	2.5	[mH/km]
Conductance per length between Lines	g	1e-10	[1/(Ohm·m)]
Capacitance per length between Lines	c	0.3	[µF/km]
Length of Umbilical for each Line	length	100	[km]
Number of Lumped Segments	N	3	[Stck]
Temperature of the conductor	temp	5	[°C]

umbilical1.rTemp

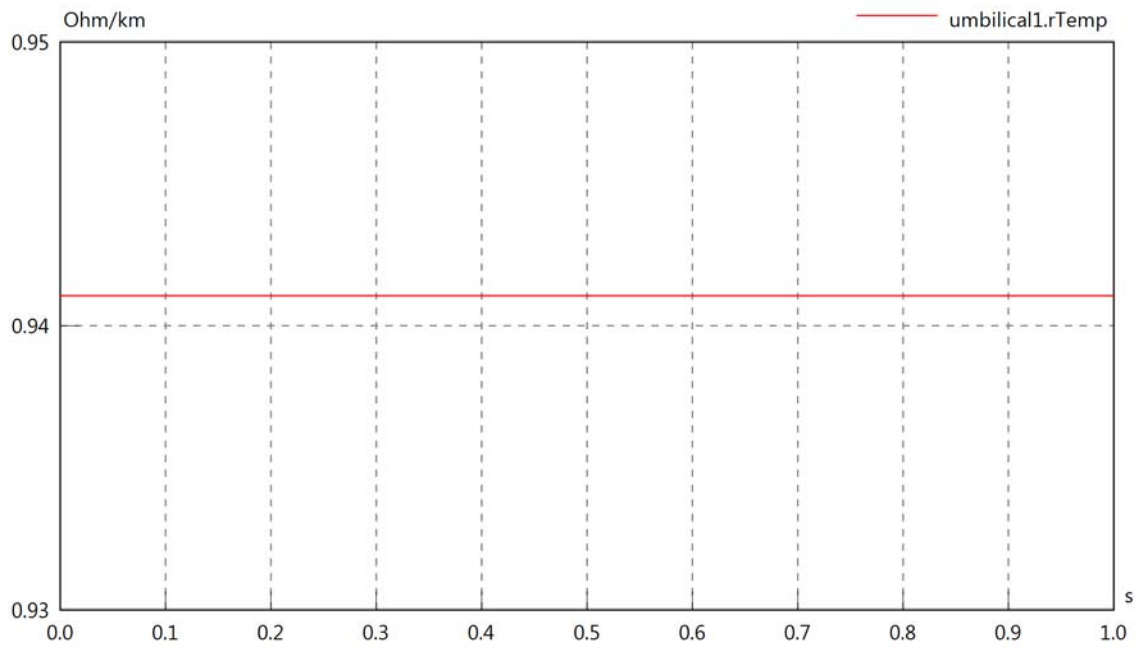

umbilical1.rInternal

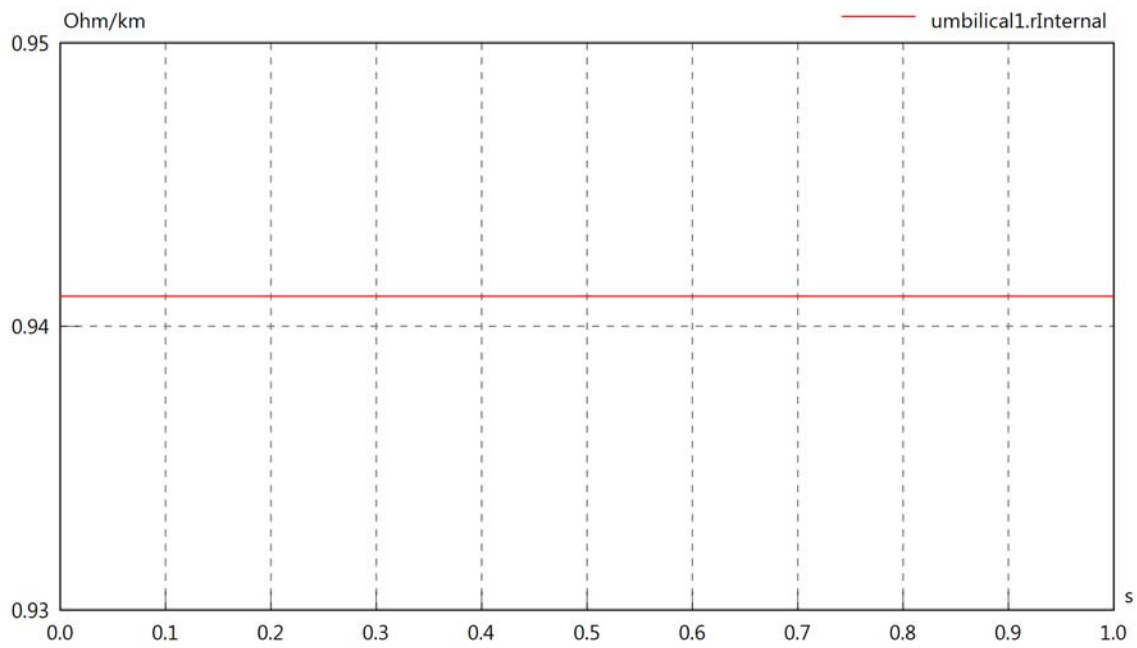

umbilical1.vIn

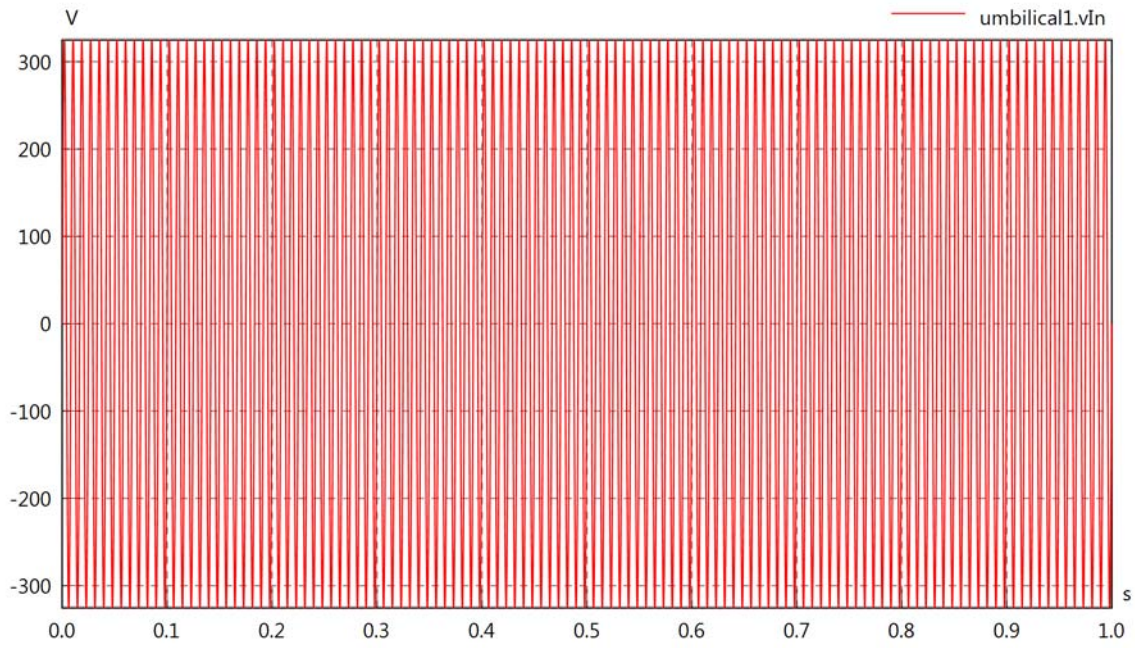

umbilical1.vOut

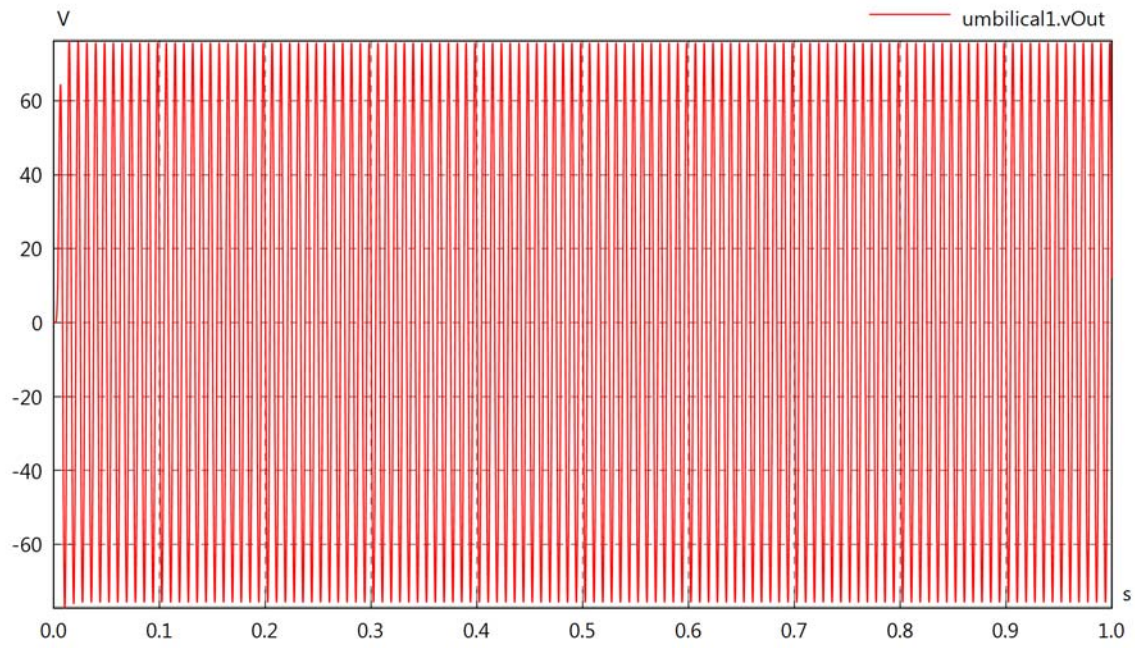

umbilical1.v

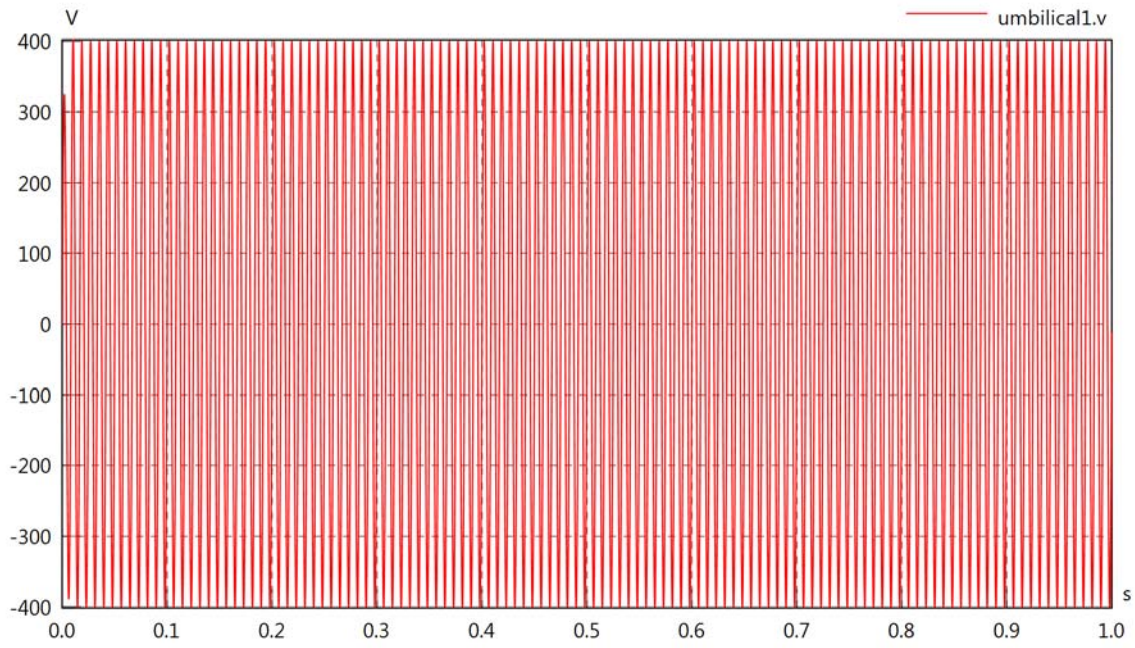

umbilical1.iIn

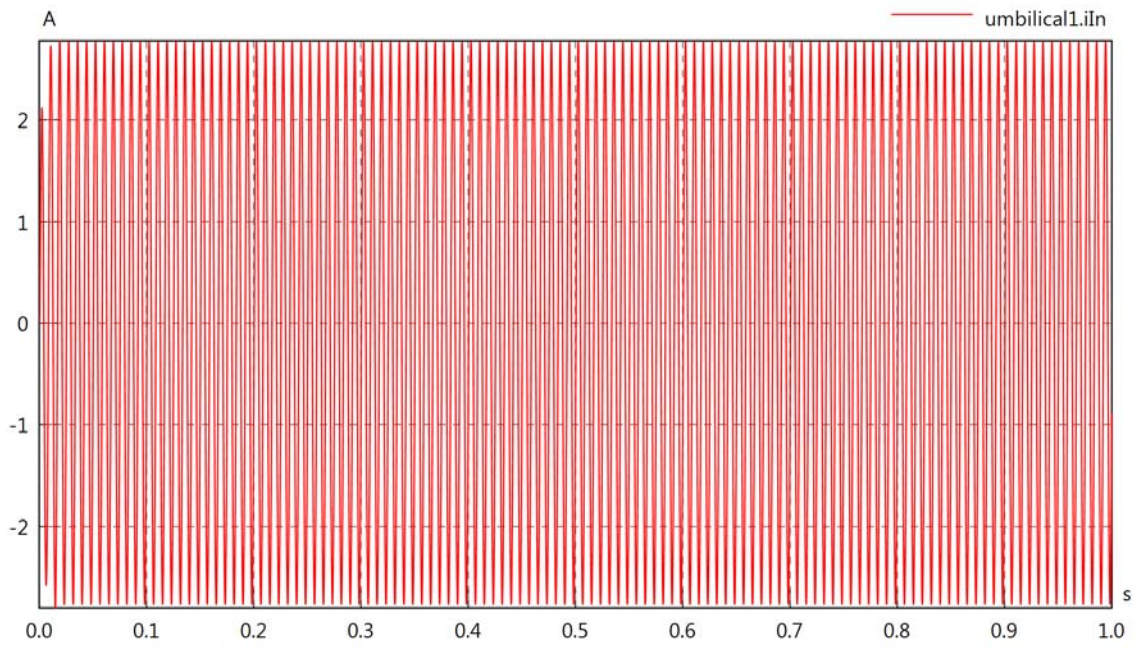

umbilical1.iOut

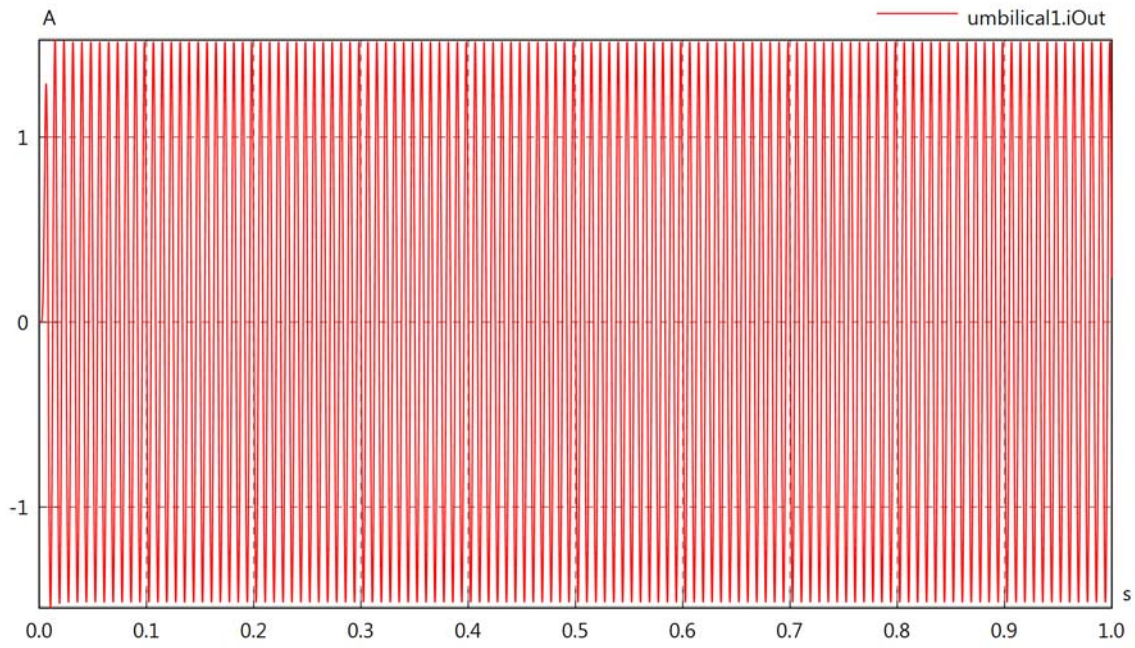

umbilical1.PIn

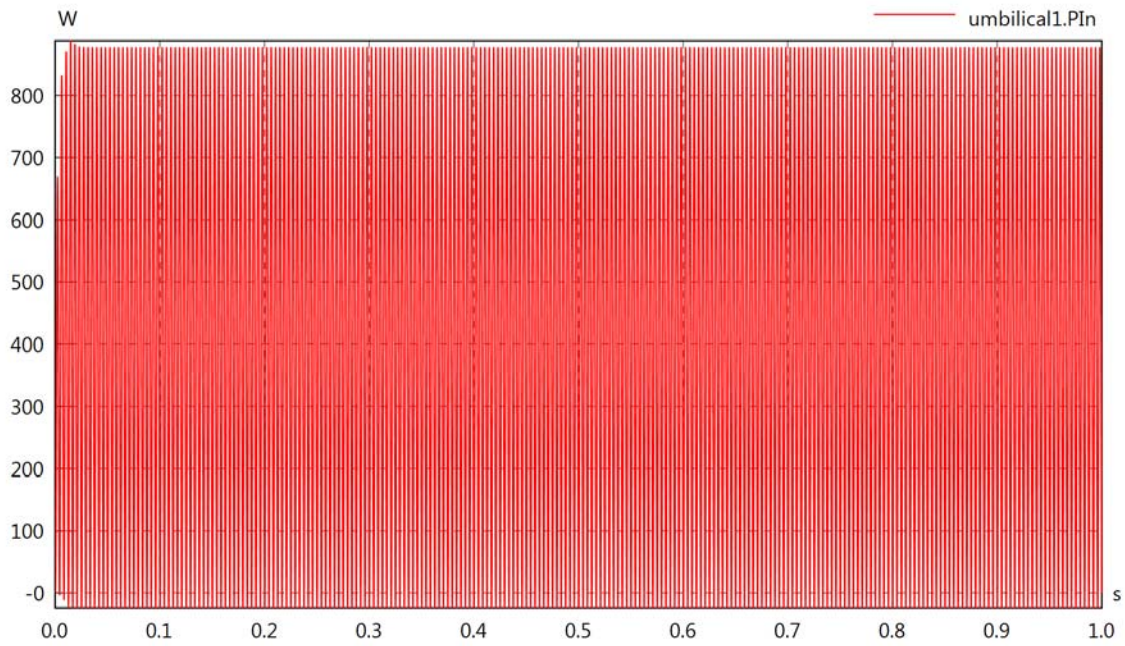

umbilical1.POut

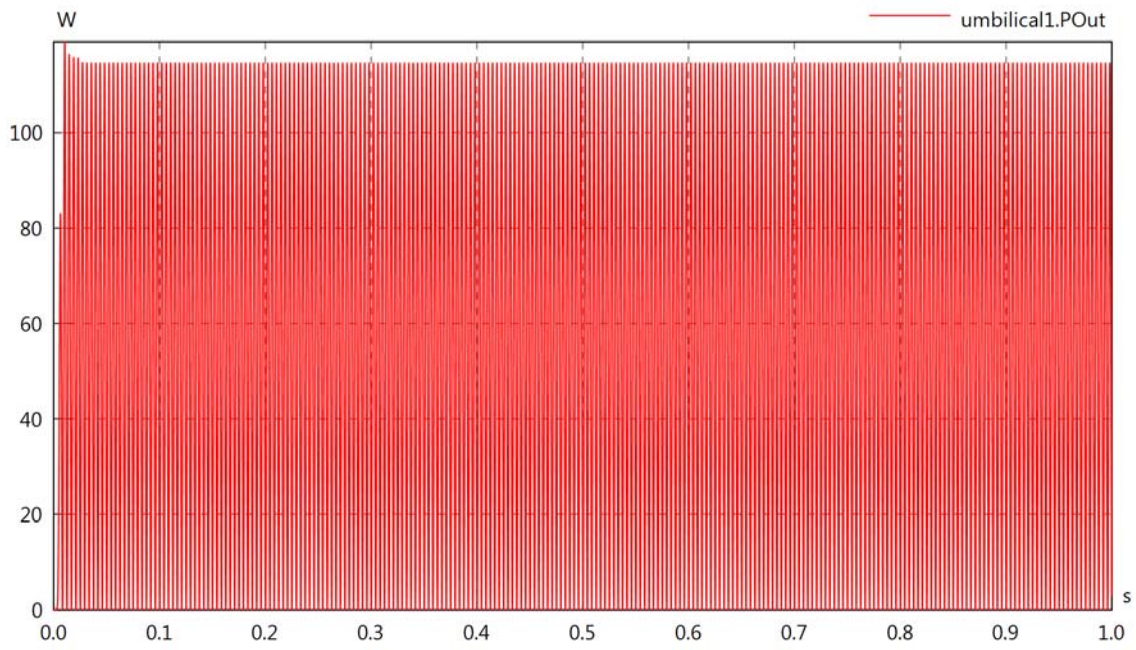

umbilical1.PI

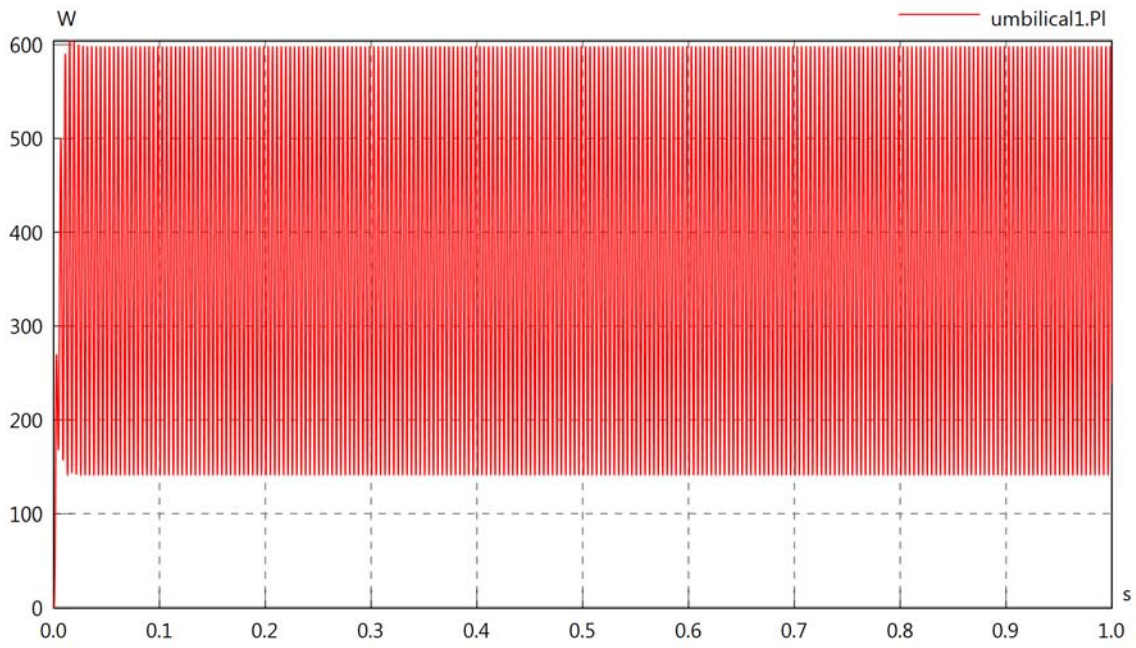
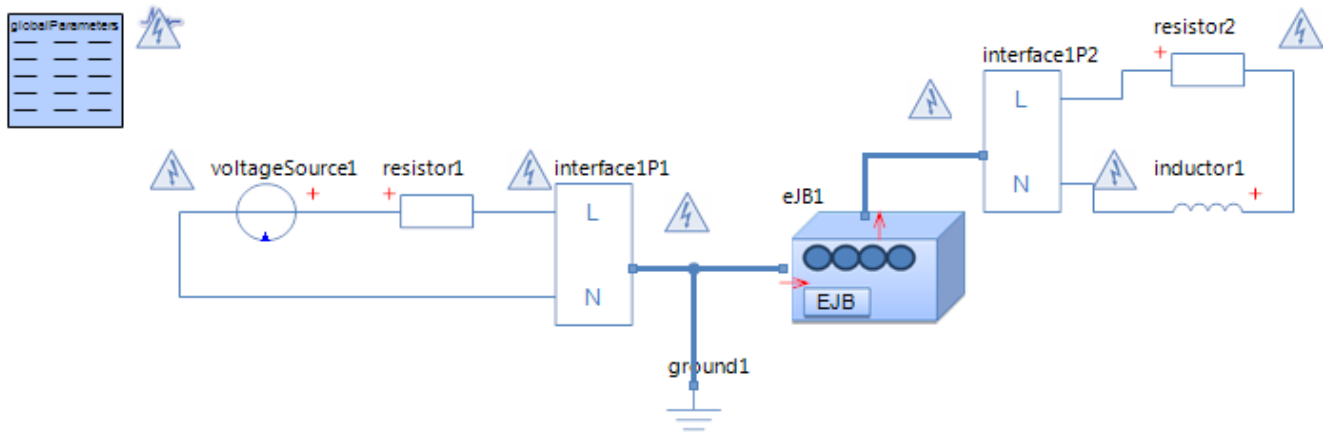

Diagram View



Voltage Source voltageSource1

Parameters

Comment	Name	Current Value	Unit
Voltage	v_src	$230 \cdot \sqrt{2} \cdot \sin(2 \cdot \pi \cdot 30 \cdot t)$	[V]

Resistor resistor1

Parameters

Comment	Name	Current Value	Unit
Resistance	R	10	[Ohm]

Resistor resistor2

Parameters

Comment	Name	Current Value	Unit
Resistance	R	100	[Ohm]

Electrical Junction Box eJB1

Parameters

Comment	Name	Current Value	Unit
Poor or failing L1 connection	bL1	true	
Resistance in L1 connection	rL1	1	[kOhm]
Conductance between L1 and N	G	50	[1/Ohm]

Inductor inductor1

Parameters

Comment	Name	Current Value	Unit
Inductance	L	100	[mH]
Initial Value	i0	0 (Fixed)	[A]
Kind	kind	absolute	

eJB1.vIn

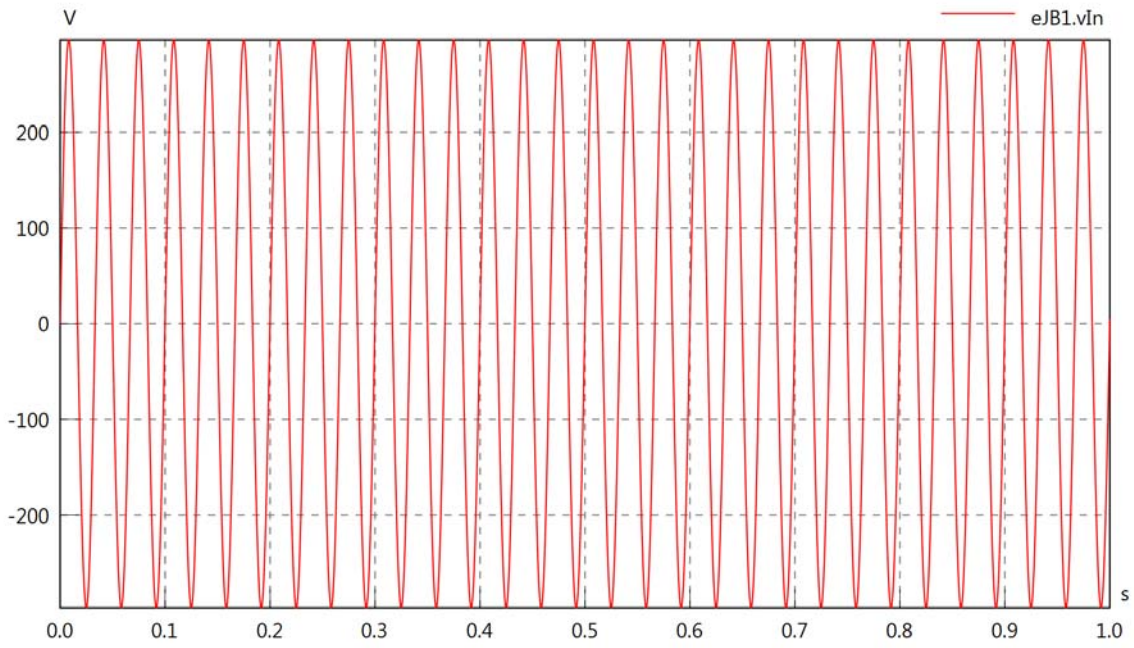

eJB1.vOut

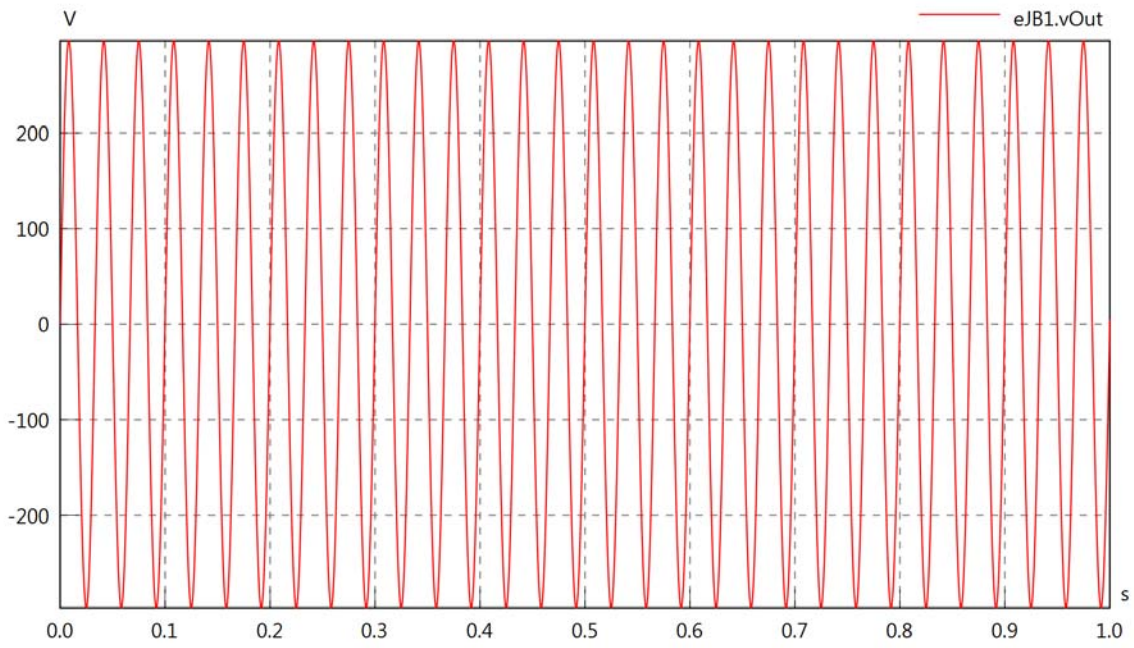

eJB1.v

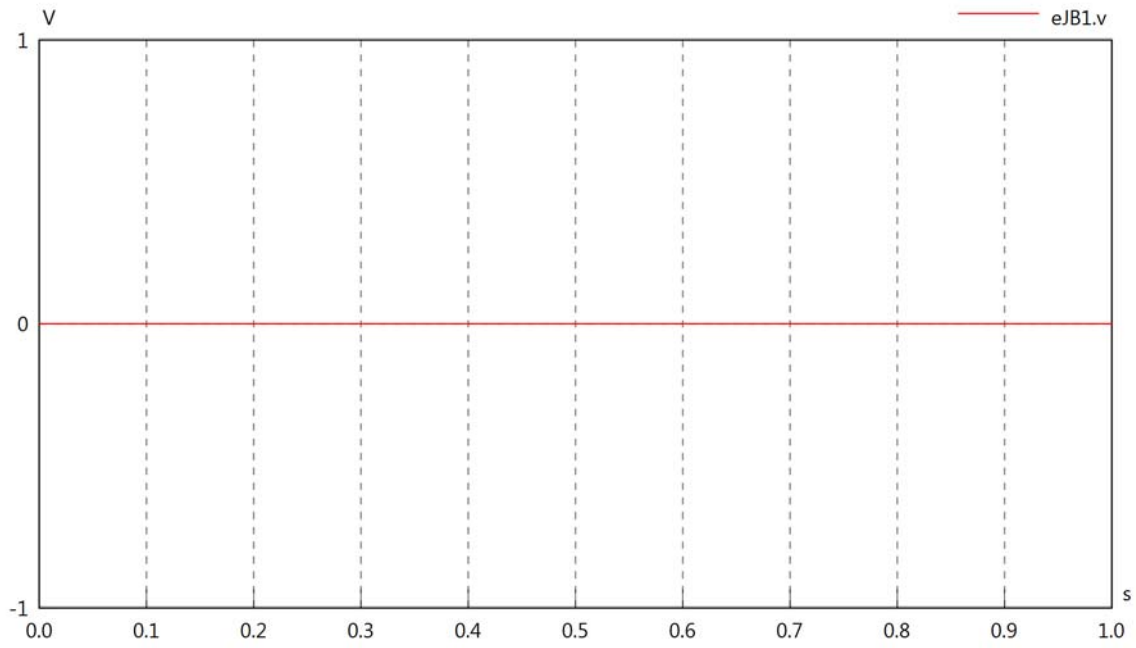

eJB1.iIn

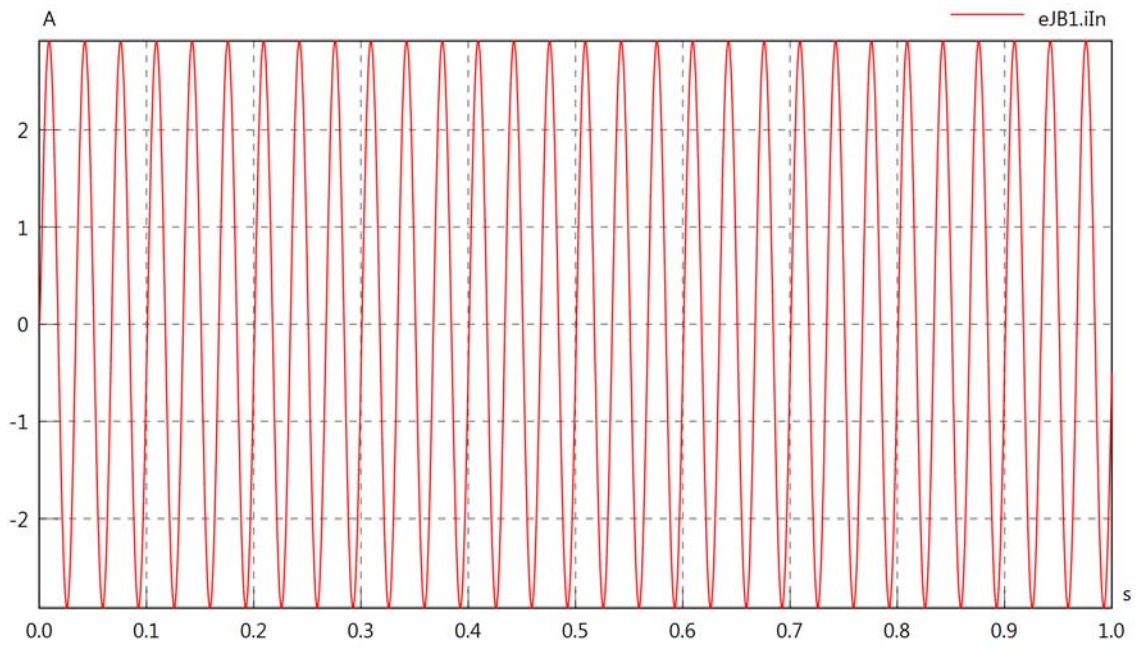

eJB1.iOut

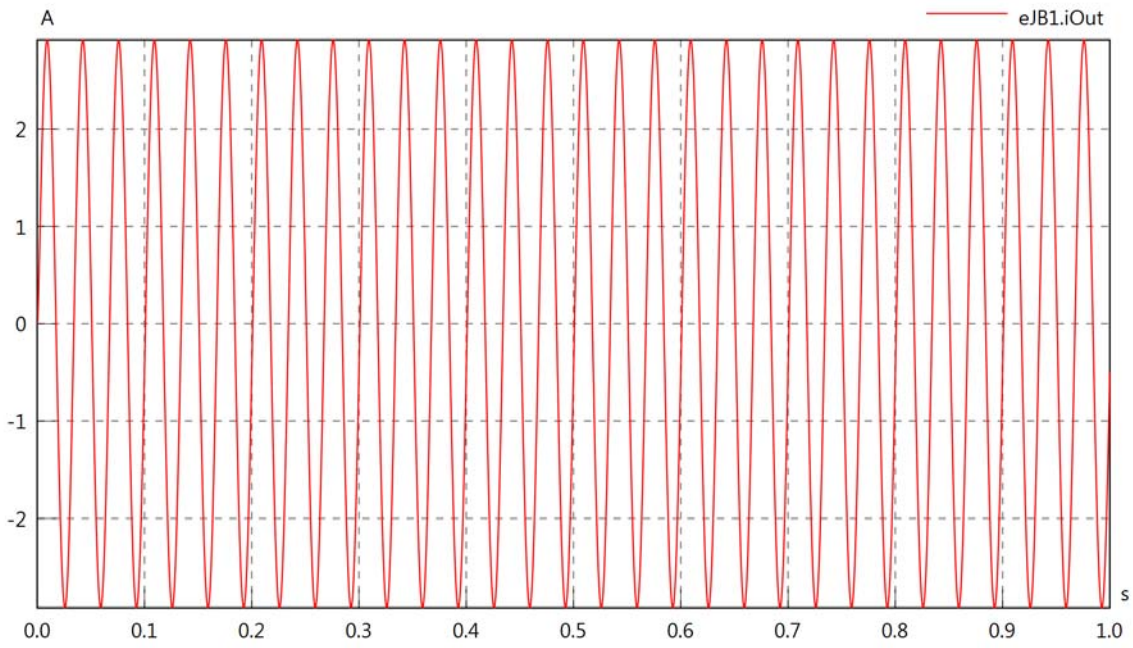

eJB1.PI

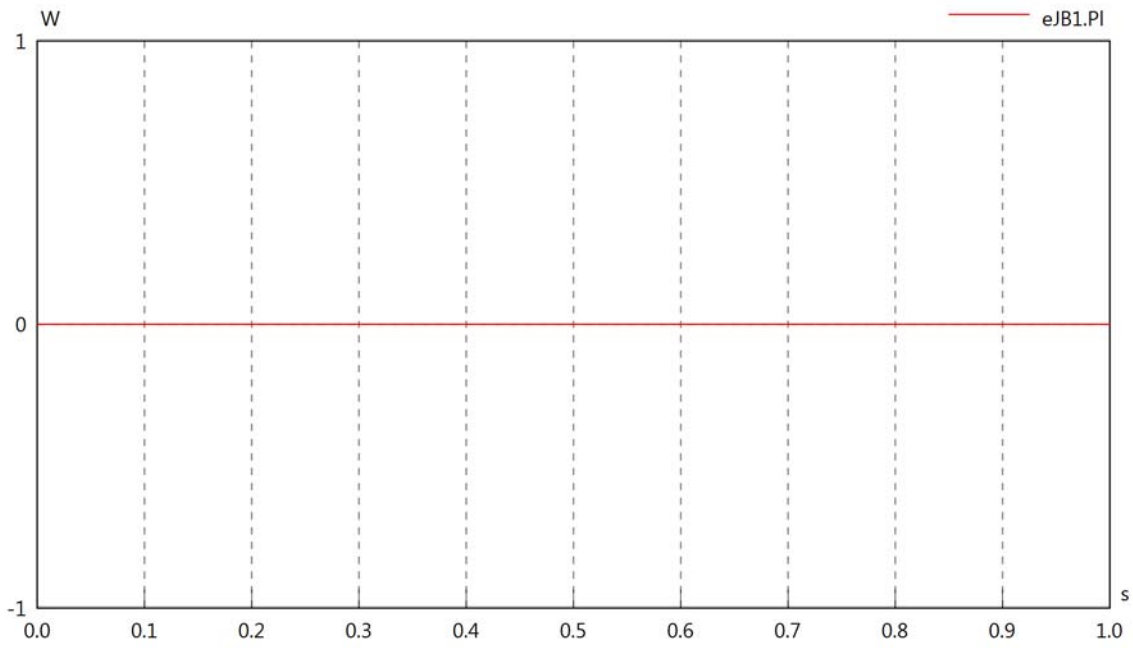
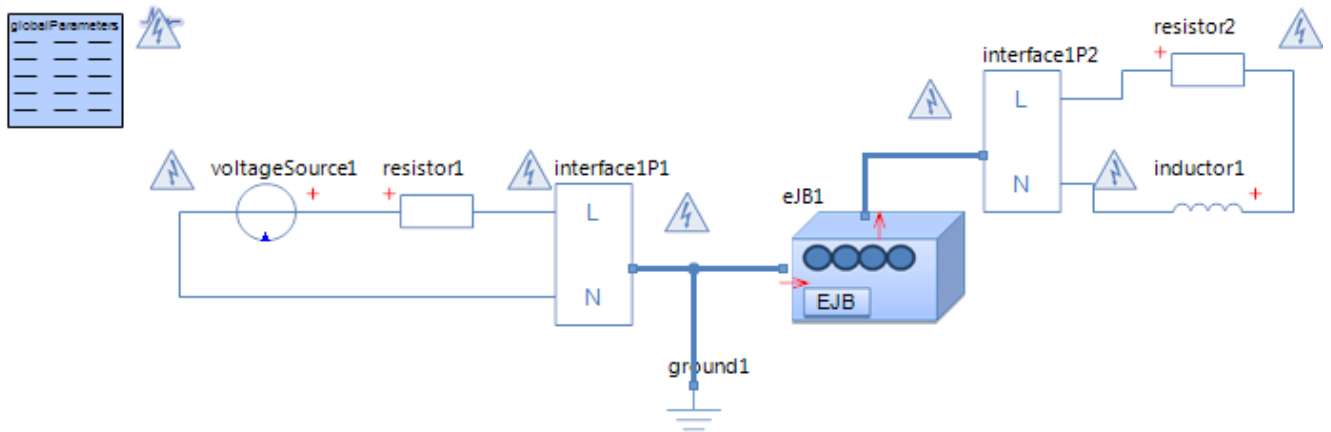

Diagram View



Voltage Source voltageSource1

Parameters

Comment	Name	Current Value	Unit
Voltage	v_src	$230 \cdot \sqrt{2} \cdot \sin(2 \cdot \pi \cdot 60 \cdot t)$	[V]

Resistor resistor1

Parameters

Comment	Name	Current Value	Unit
Resistance	R	10	[Ohm]

Resistor resistor2

Parameters

Comment	Name	Current Value	Unit
Resistance	R	100	[Ohm]

Electrical Junction Box eJB1

Parameters

Comment	Name	Current Value	Unit
Poor or failing L1 connection	bL1	false	

Inductor inductor1

Parameters

Comment	Name	Current Value	Unit
Inductance	L	100	[mH]
Initial Value	i0	0 (Fixed)	[A]
Kind	kind	absolute	

eJB1.vIn

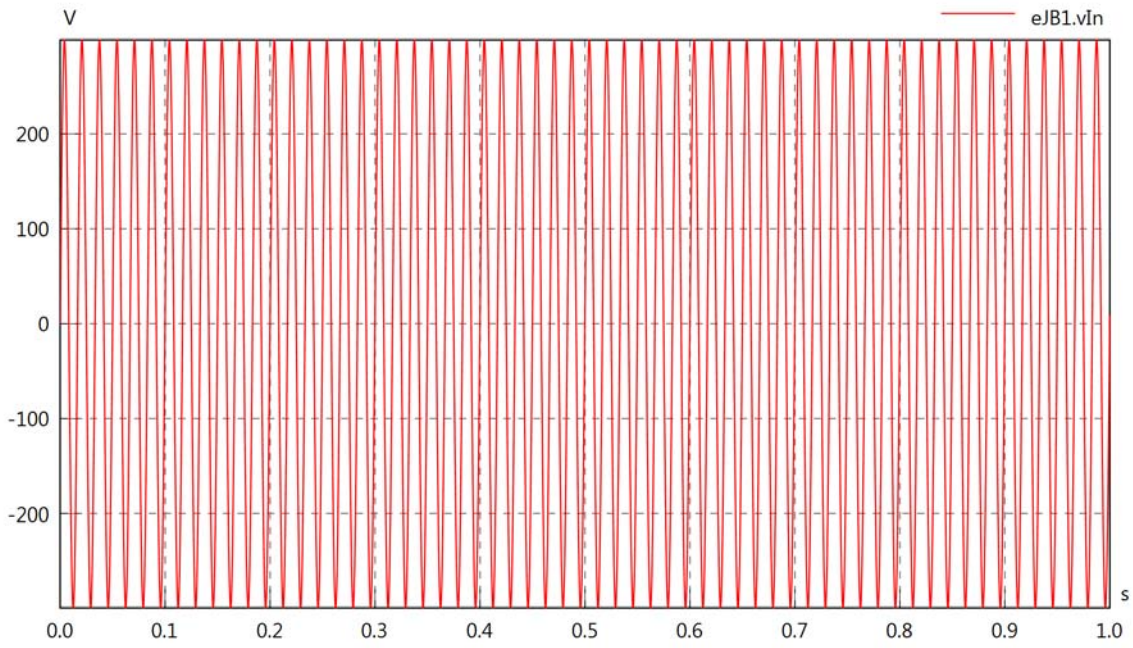

eJB1.vOut

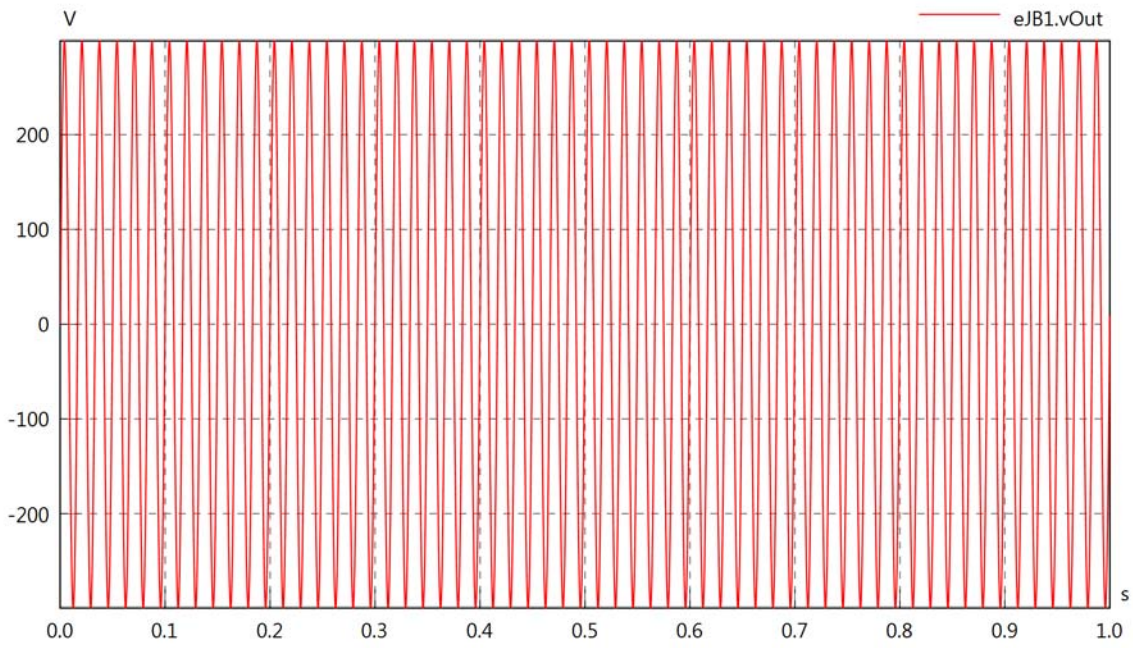

eJB1.v

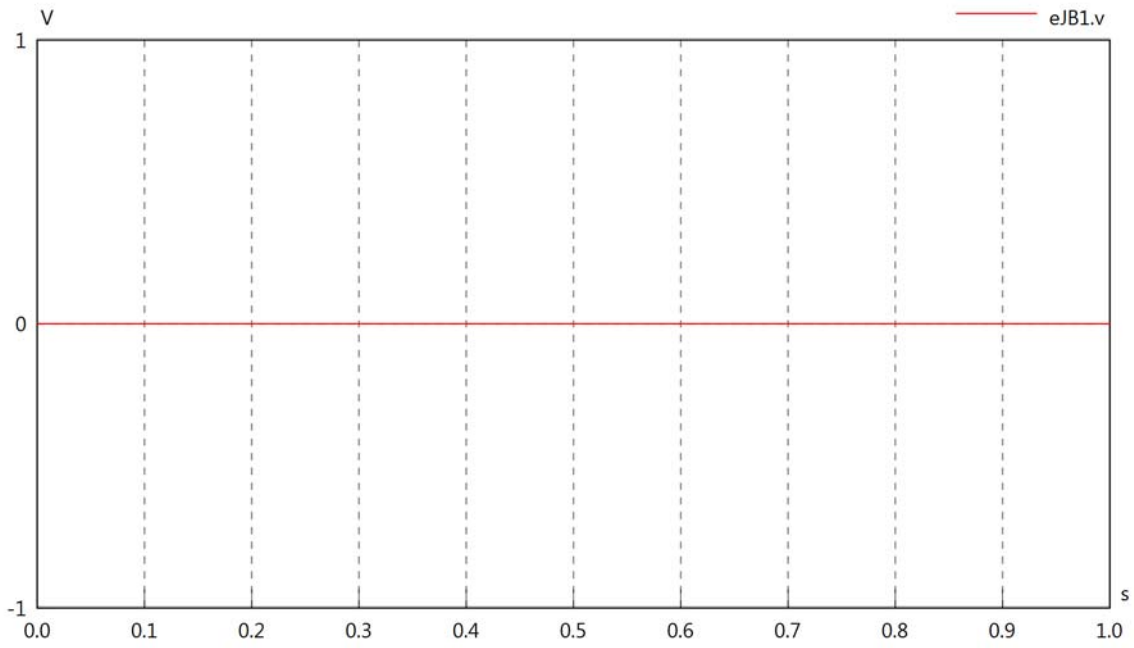

eJB1.iIn

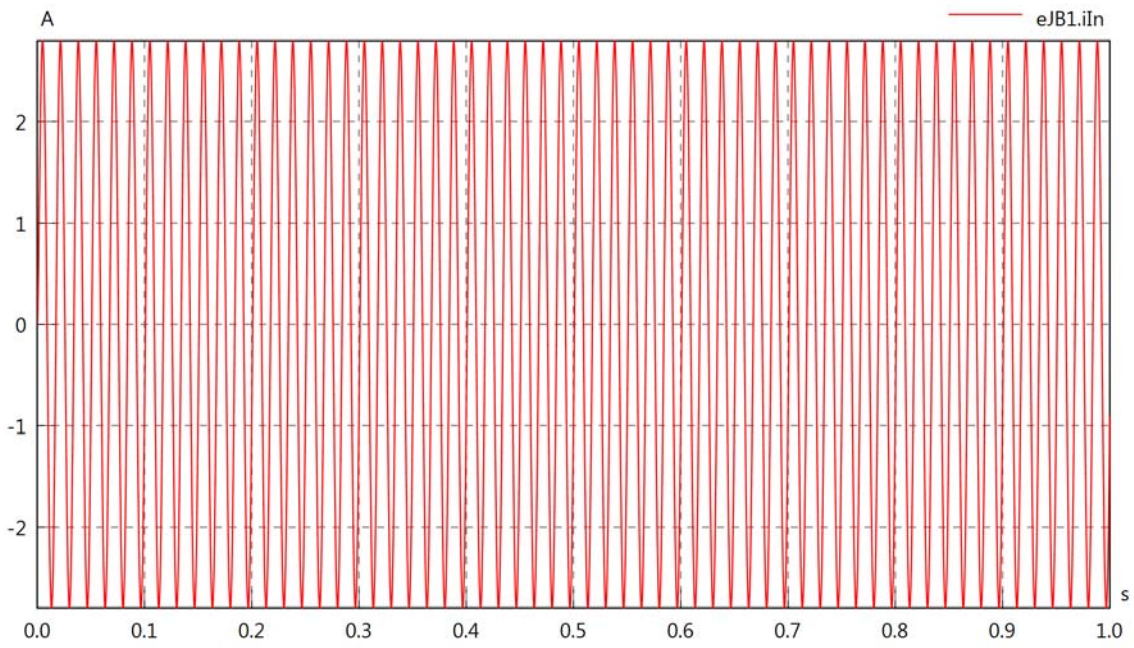

eJB1.iOut

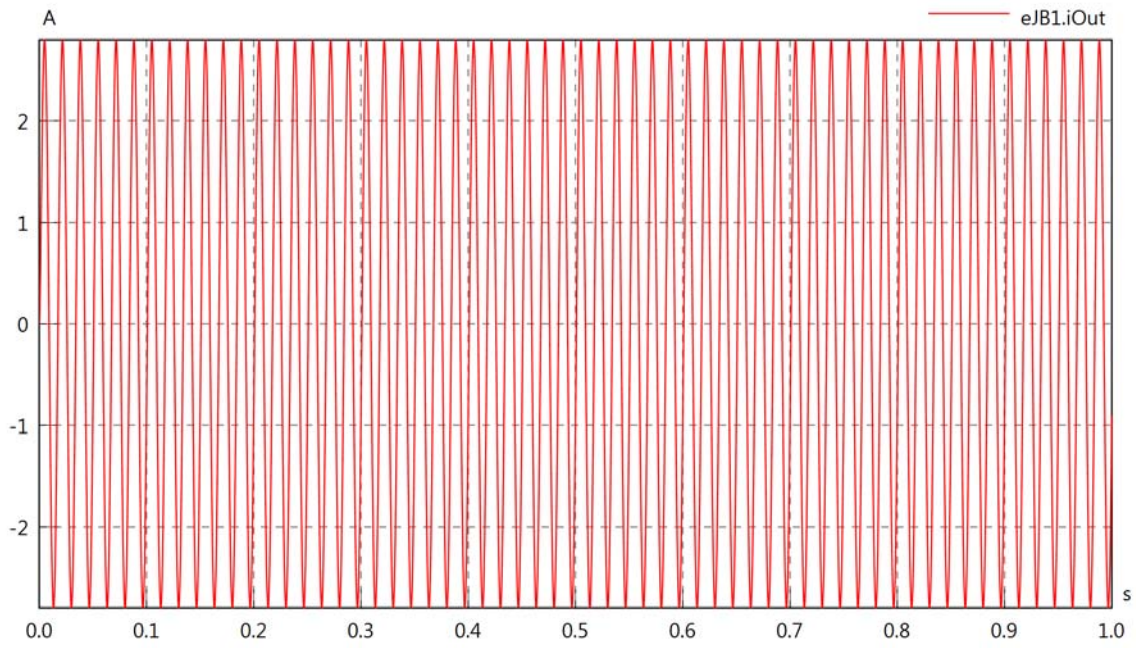

eJB1.PI

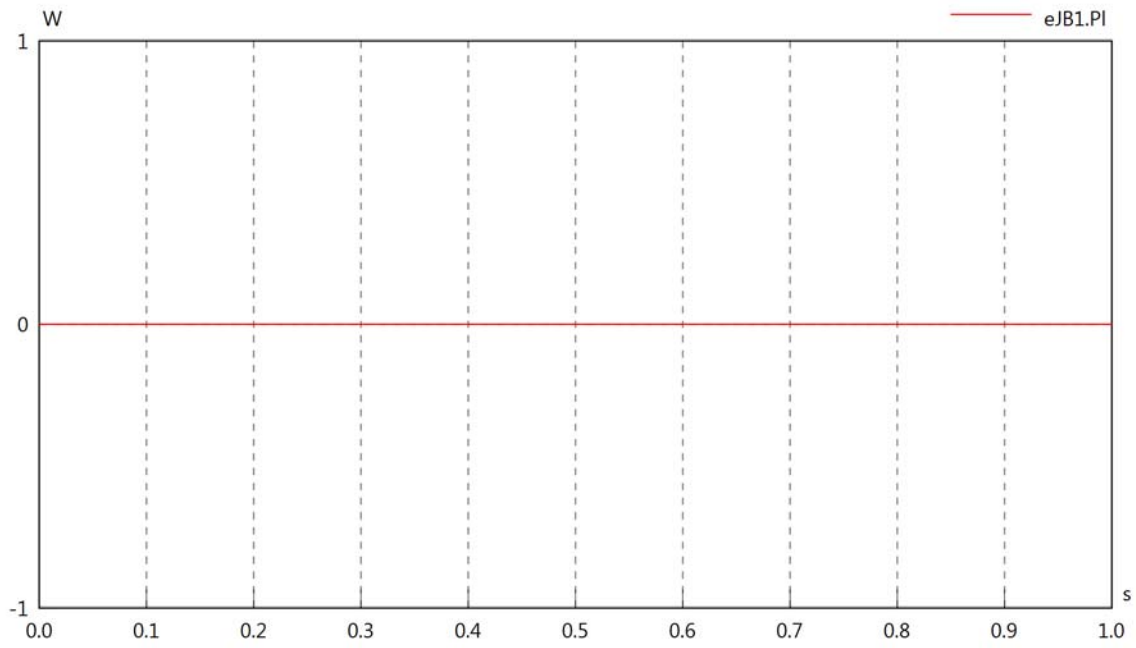
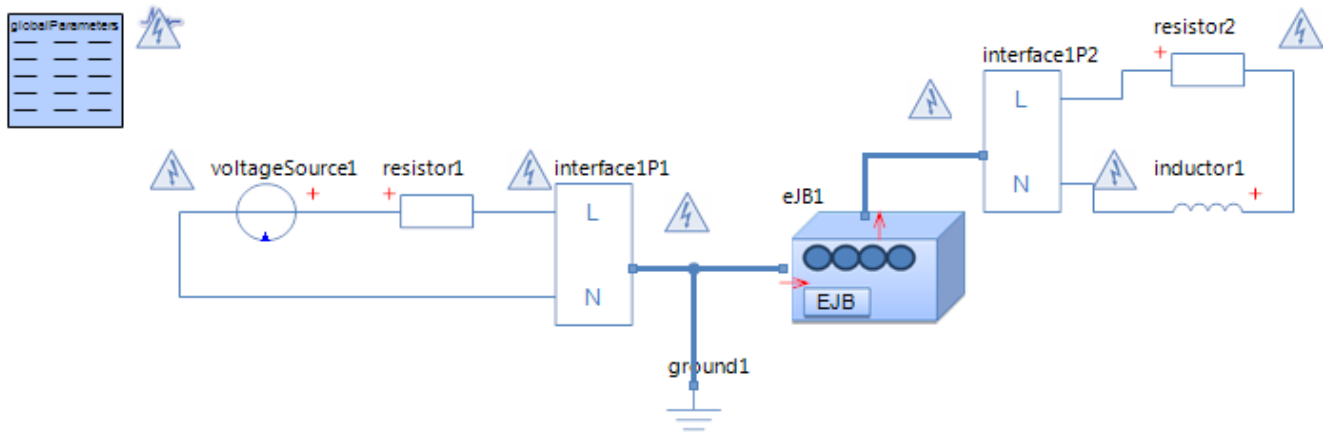

Diagram View



Voltage Source voltageSource1

Parameters

Comment	Name	Current Value	Unit
Voltage	v_src	$230 \cdot \sqrt{2} \cdot \sin(2 \cdot \pi \cdot 120 \cdot t)$	[V]

Resistor resistor1

Parameters

Comment	Name	Current Value	Unit
Resistance	R	10	[Ohm]

Resistor resistor2

Parameters

Comment	Name	Current Value	Unit
Resistance	R	100	[Ohm]

Electrical Junction Box eJB1

Parameters

Comment	Name	Current Value	Unit
Poor or failing L1 connection	bL1	false	

Inductor inductor1

Parameters

Comment	Name	Current Value	Unit
Inductance	L	100	[mH]
Initial Value	i0	0 (Fixed)	[A]
Kind	kind	absolute	

eJB1.vIn

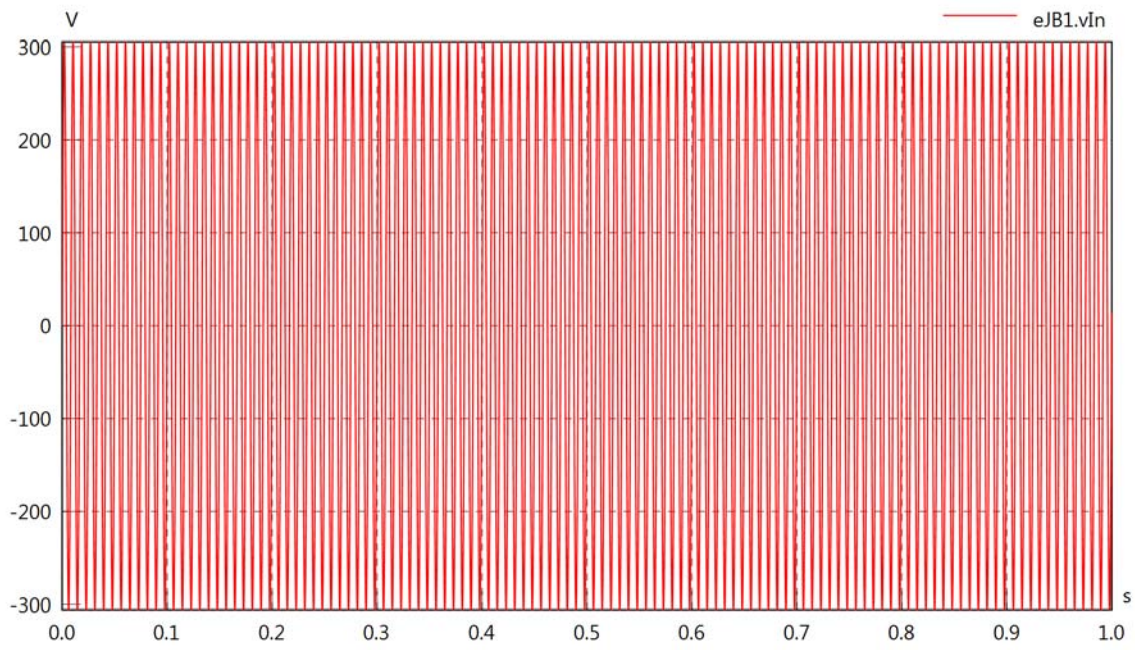

eJB1.vOut

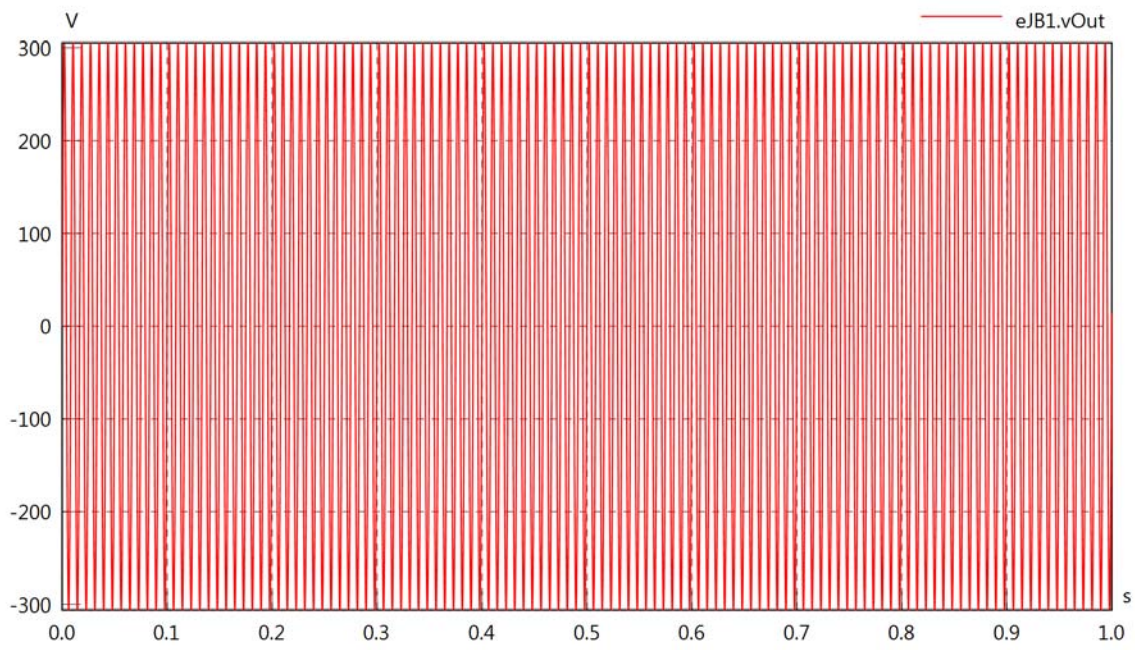

eJB1.v

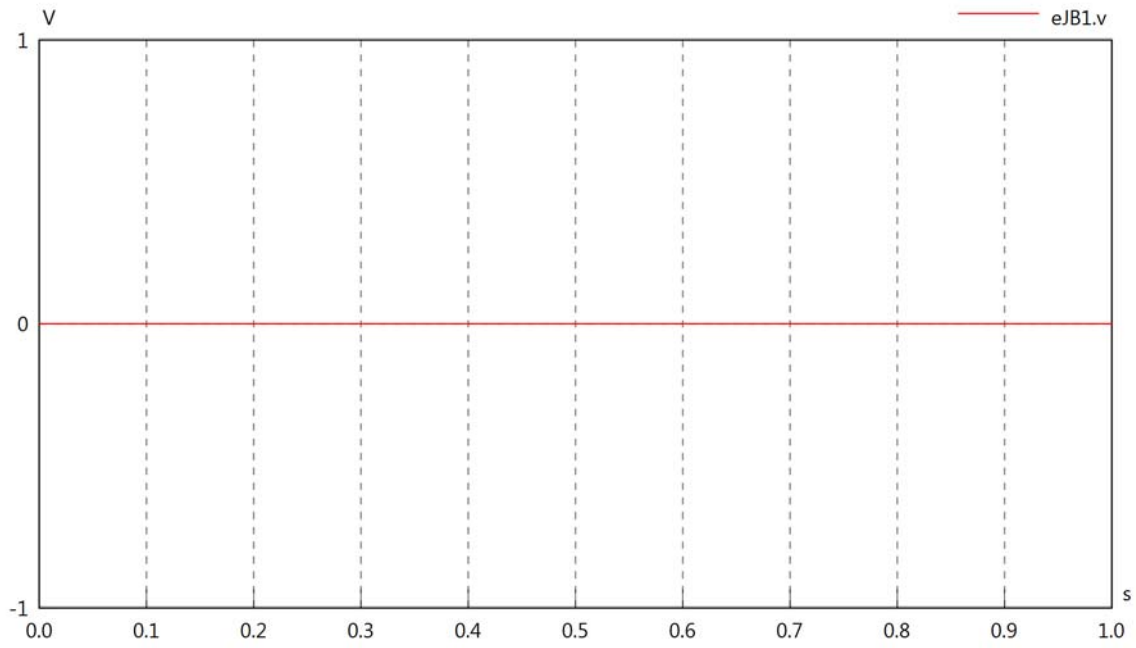

eJB1.iIn

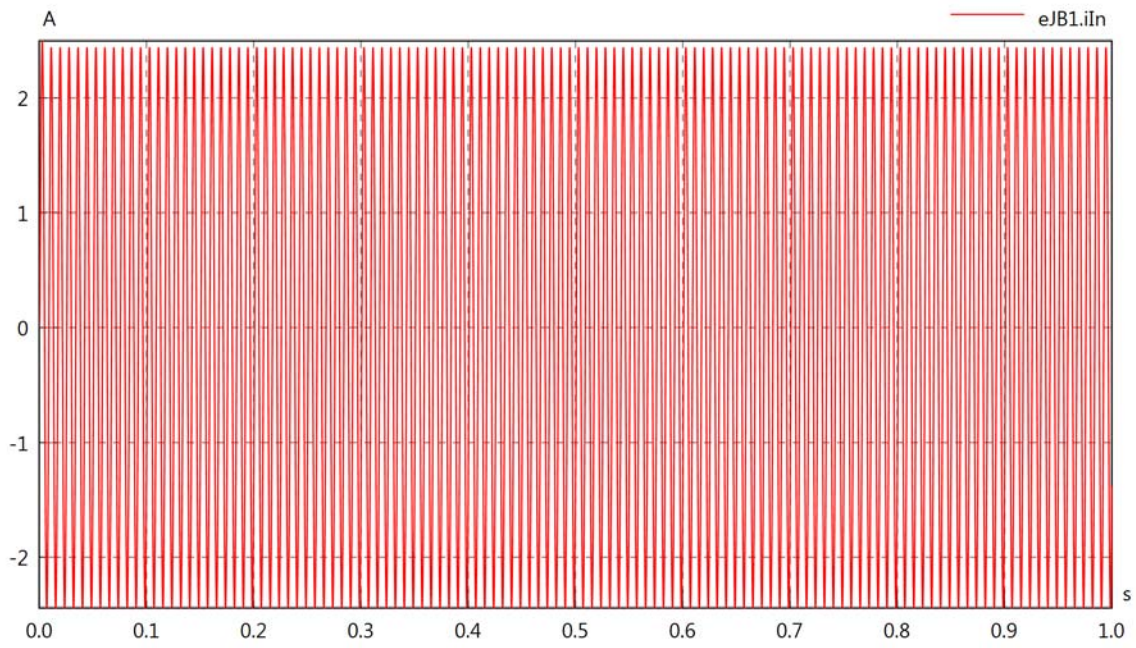

eJB1.iOut

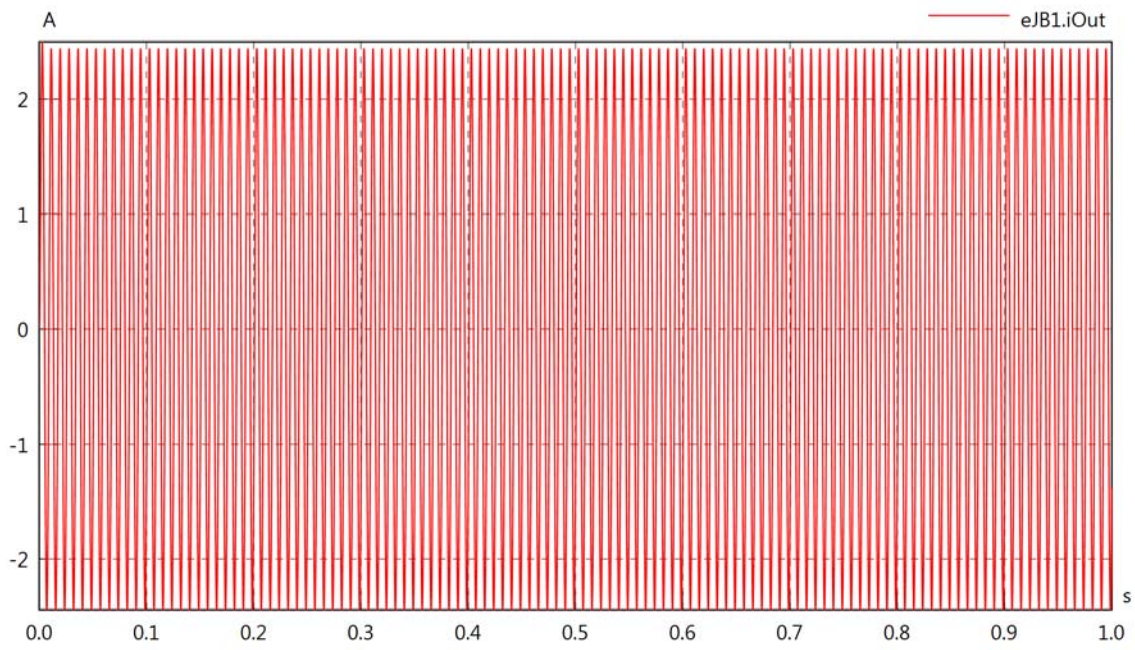

eJB1.PI

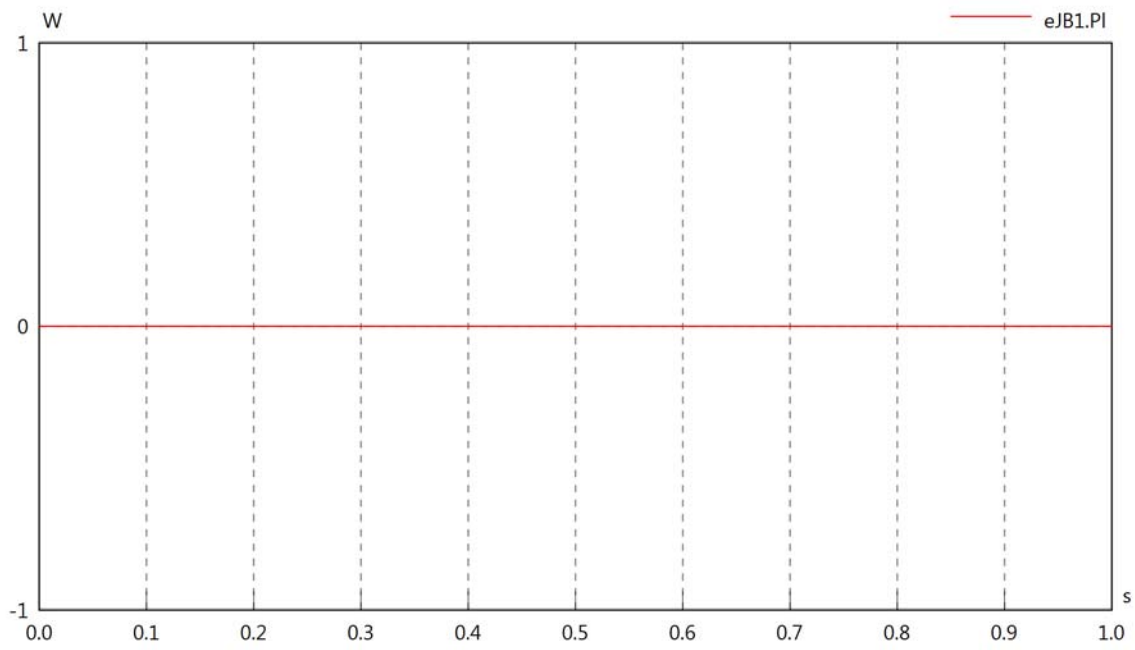
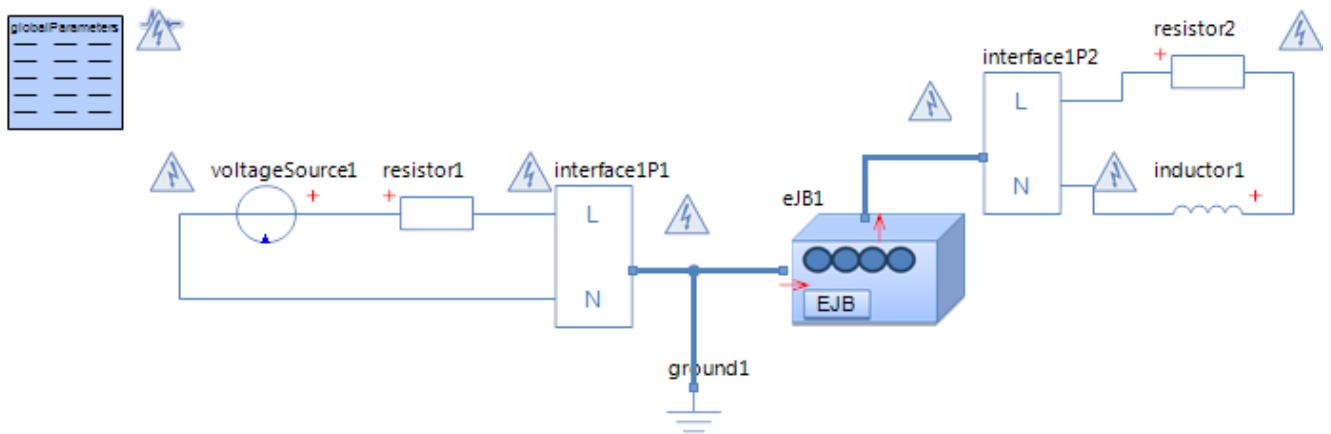

Diagram View



Voltage Source voltageSource1

Parameters

Comment	Name	Current Value	Unit
Voltage	v_src	$230 \cdot \sqrt{2} \cdot \sin(2 \cdot \pi \cdot 30 \cdot t)$	[V]

Resistor resistor1

Parameters

Comment	Name	Current Value	Unit
Resistance	R	10	[Ohm]

Resistor resistor2

Parameters

Comment	Name	Current Value	Unit
Resistance	R	100	[Ohm]

Electrical Junction Box eJB1

Parameters

Comment	Name	Current Value	Unit
Poor or failing L1 connection	bL1	true	
Resistance in L1 connection	rL1	1	[kOhm]
Conductance between L1 and N	G	50	[1/Ohm]

Inductor inductor1

Parameters

Comment	Name	Current Value	Unit
Inductance	L	100	[mH]
Initial Value	i0	0 (Fixed)	[A]
Kind	kind	absolute	

eJB1.vIn

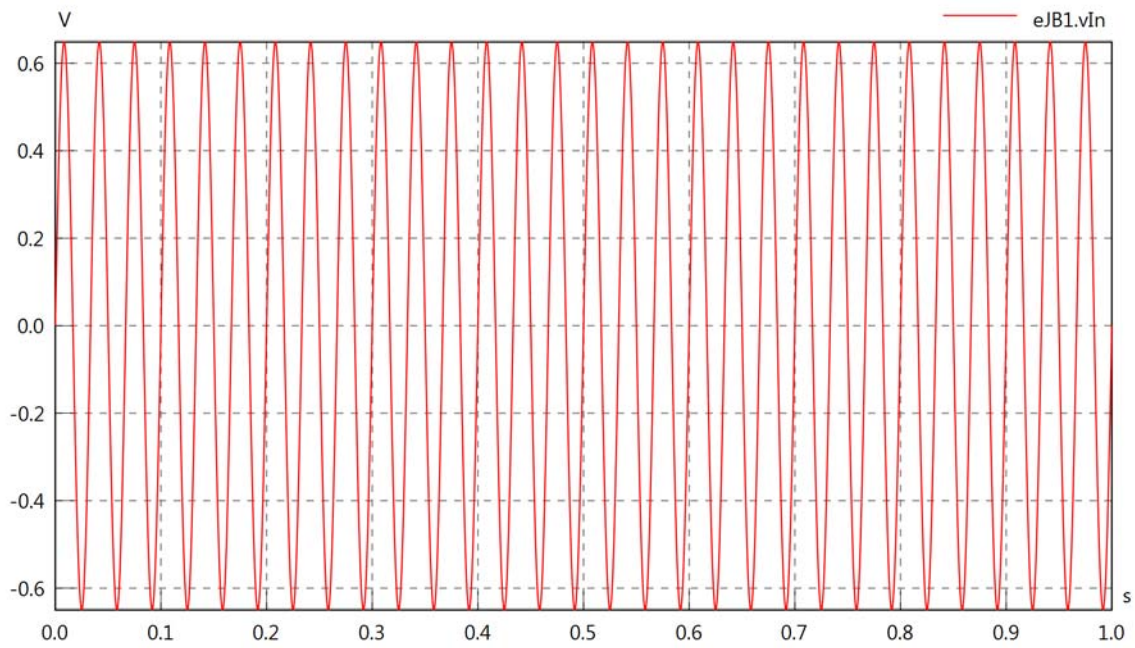

eJB1.vOut

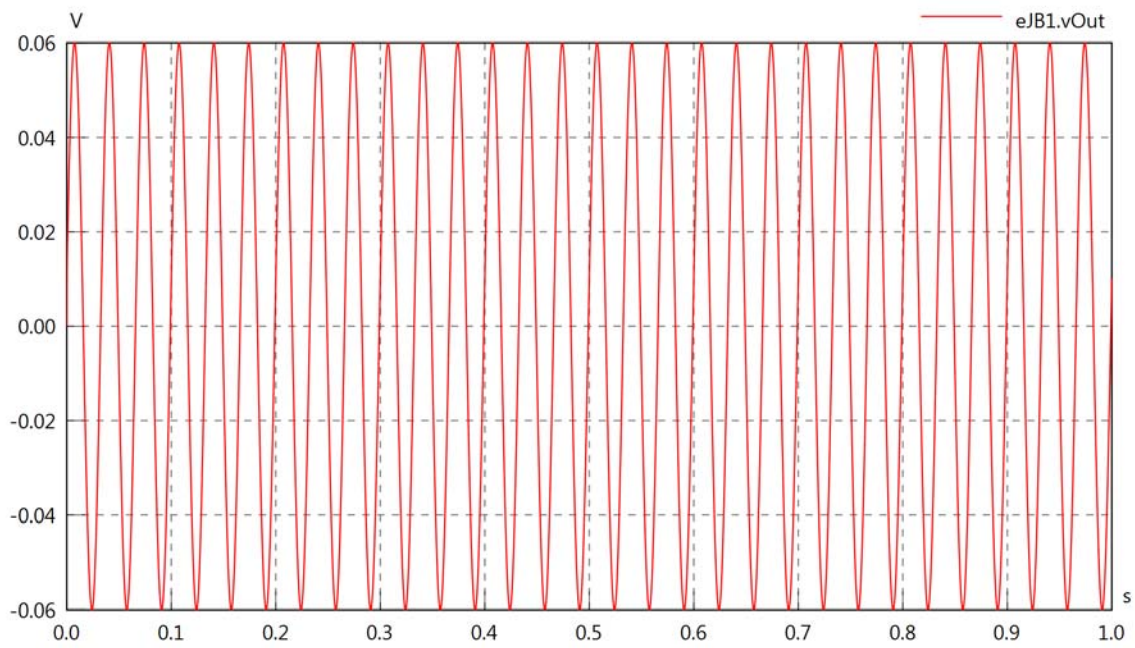

eJB1.v

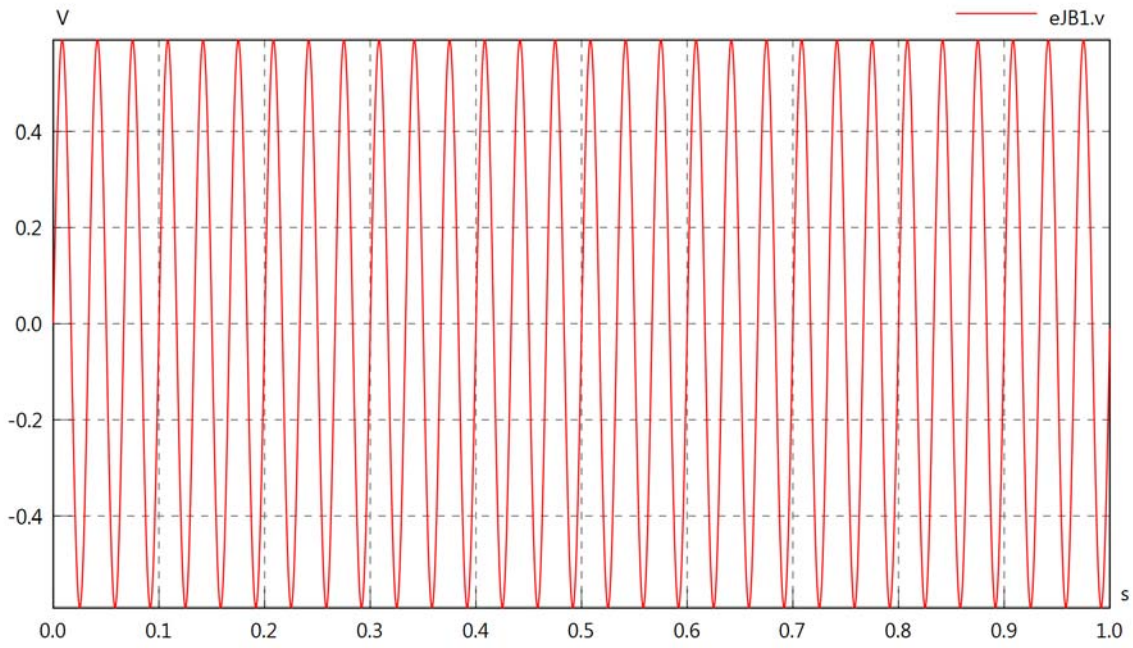

eJB1.iIn

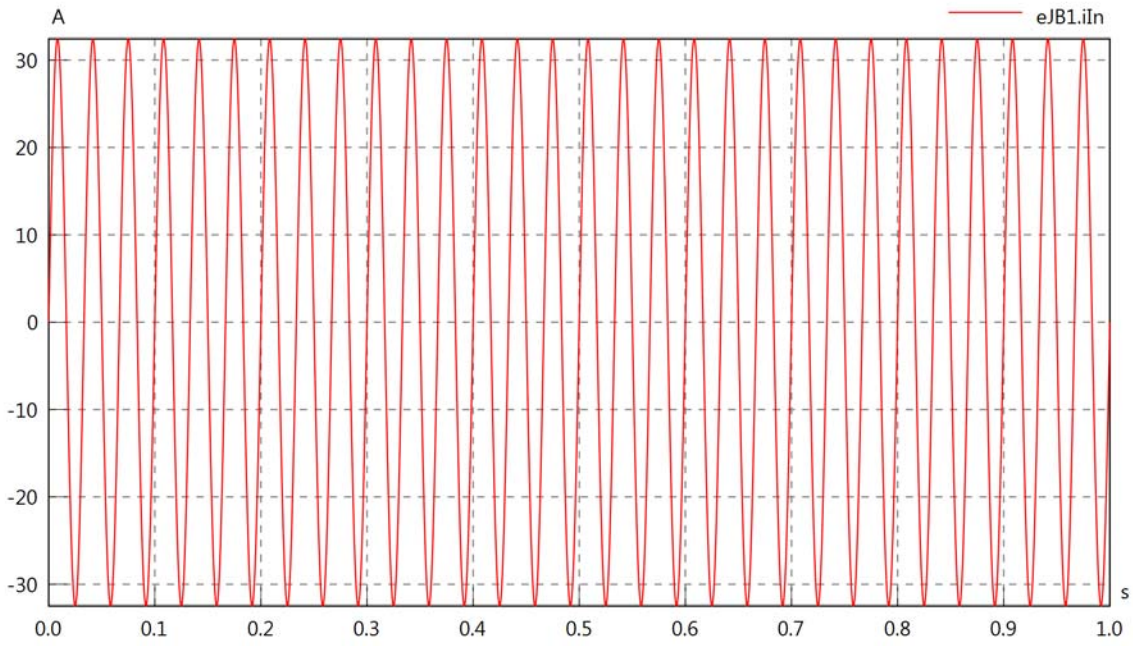

eJB1.iOut

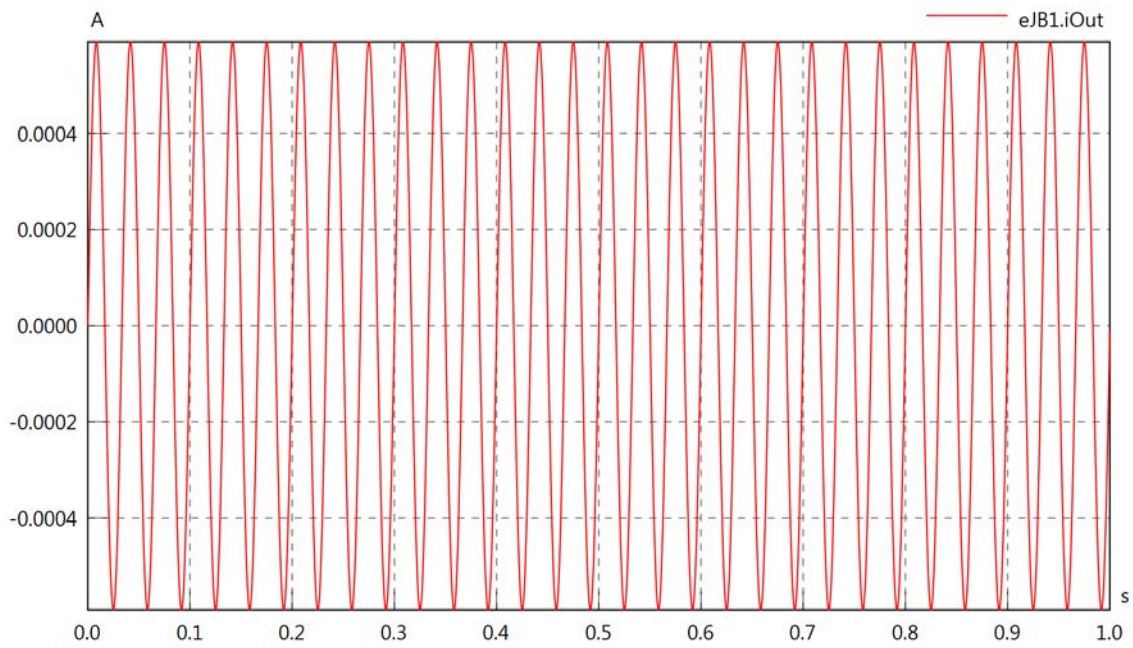

eJB1.PI

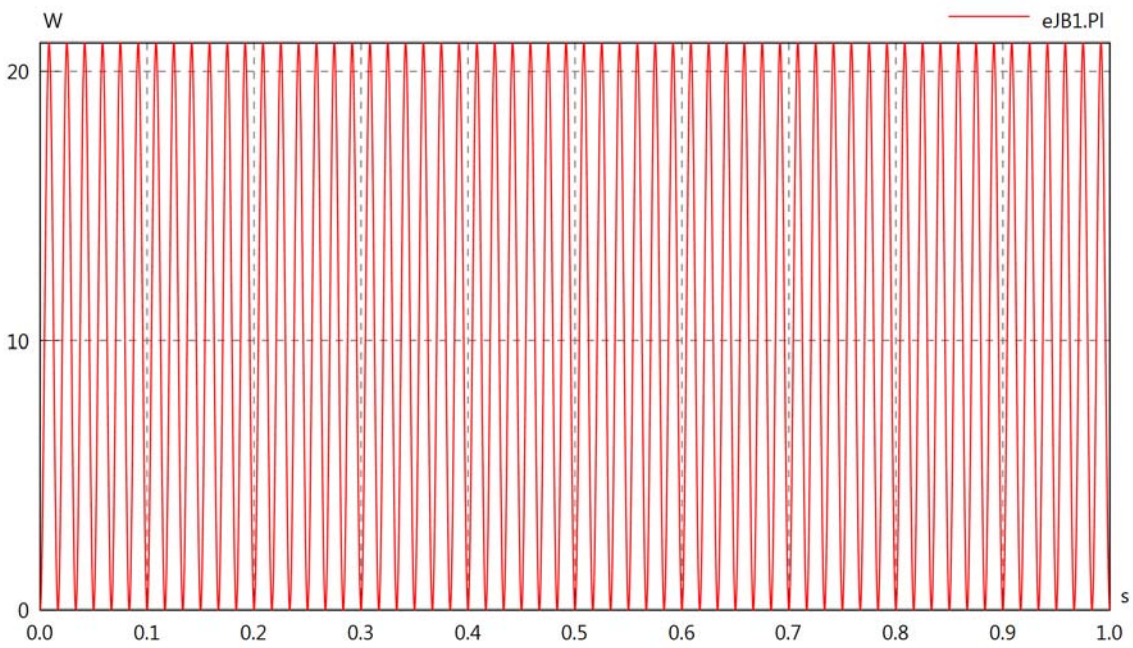
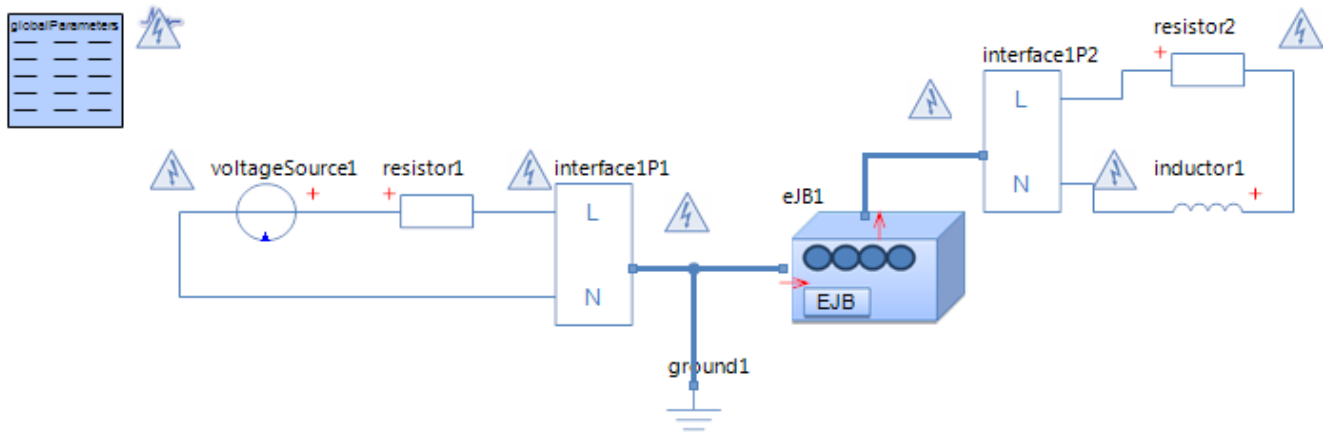

Diagram View



Voltage Source voltageSource1

Parameters

Comment	Name	Current Value	Unit
Voltage	v_src	$230 \cdot \sqrt{2} \cdot \sin(2 \cdot \pi \cdot 60 \cdot t)$	[V]

Resistor resistor1

Parameters

Comment	Name	Current Value	Unit
Resistance	R	10	[Ohm]

Resistor resistor2

Parameters

Comment	Name	Current Value	Unit
Resistance	R	100	[Ohm]

Electrical Junction Box eJB1

Parameters

Comment	Name	Current Value	Unit
Poor or failing L1 connection	bL1	true	
Resistance in L1 connection	rL1	1	[kOhm]
Conductance between L1 and N	G	50	[1/Ohm]

Inductor inductor1

Parameters

Comment	Name	Current Value	Unit
Inductance	L	100	[mH]
Initial Value	i0	0 (Fixed)	[A]
Kind	kind	absolute	

eJB1.vIn

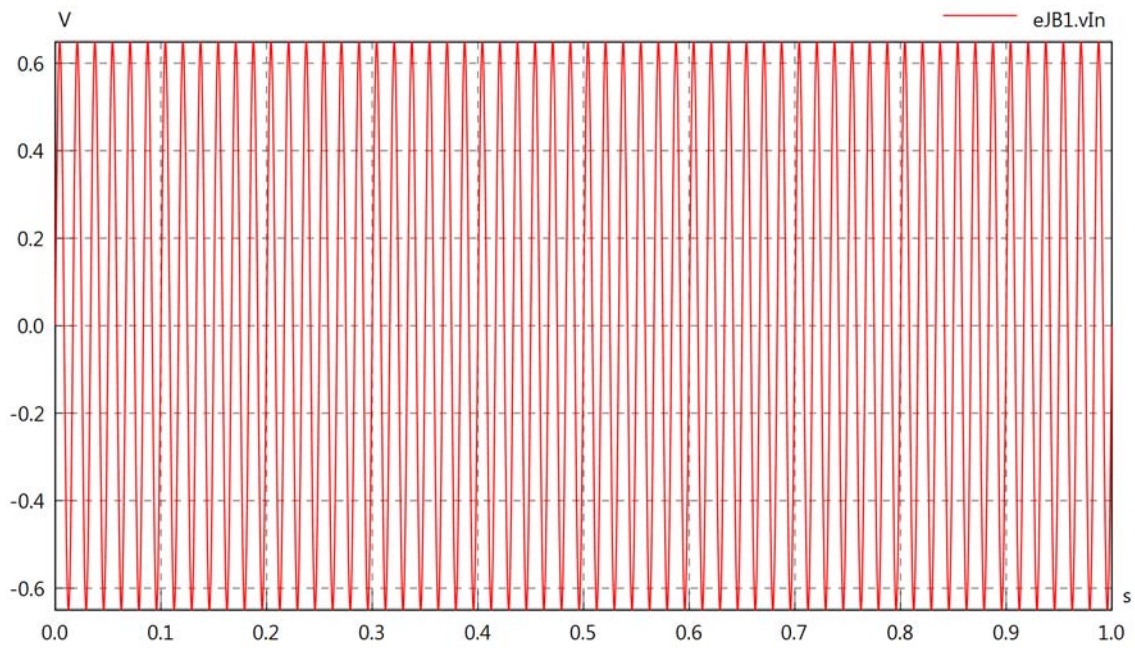

eJB1.vOut

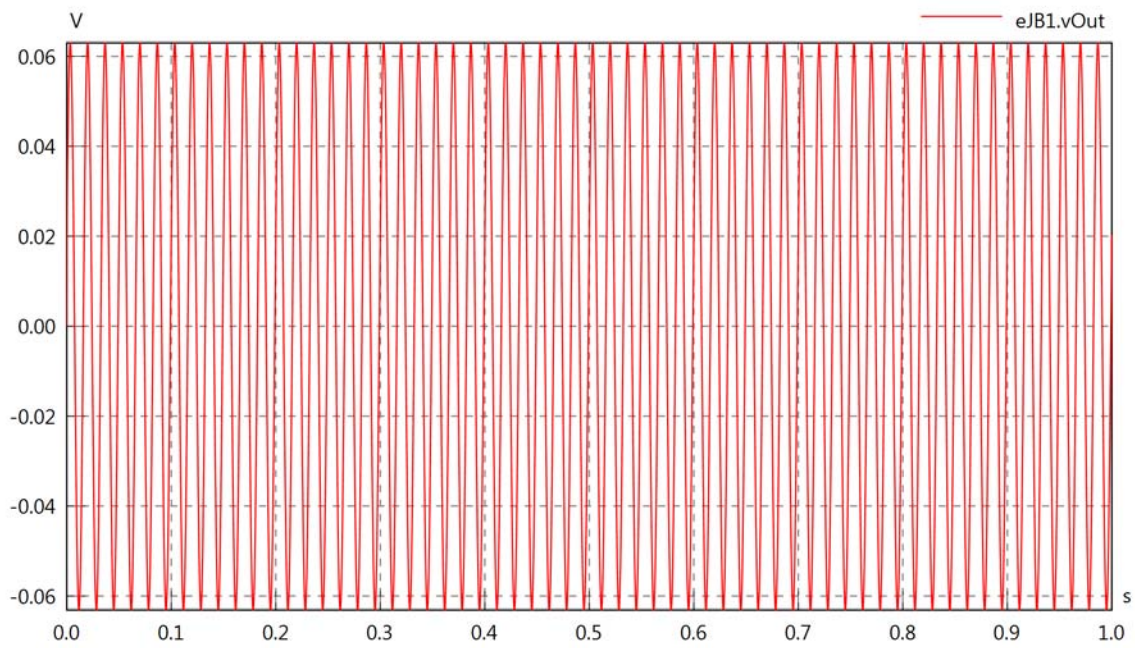

eJB1.v

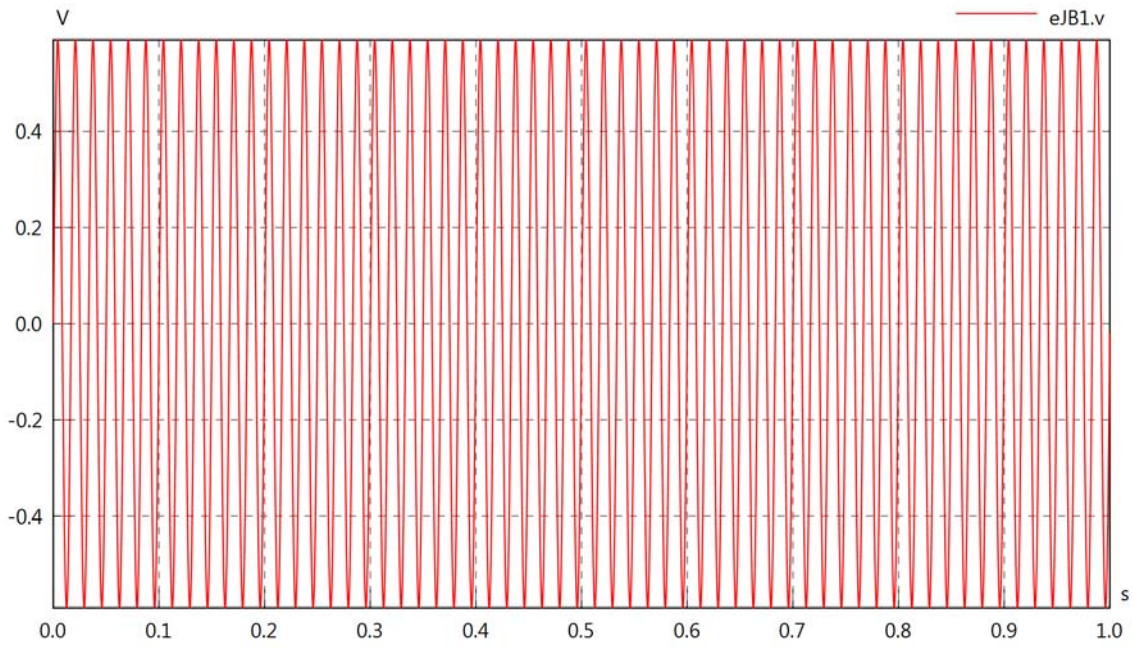

eJB1.iIn

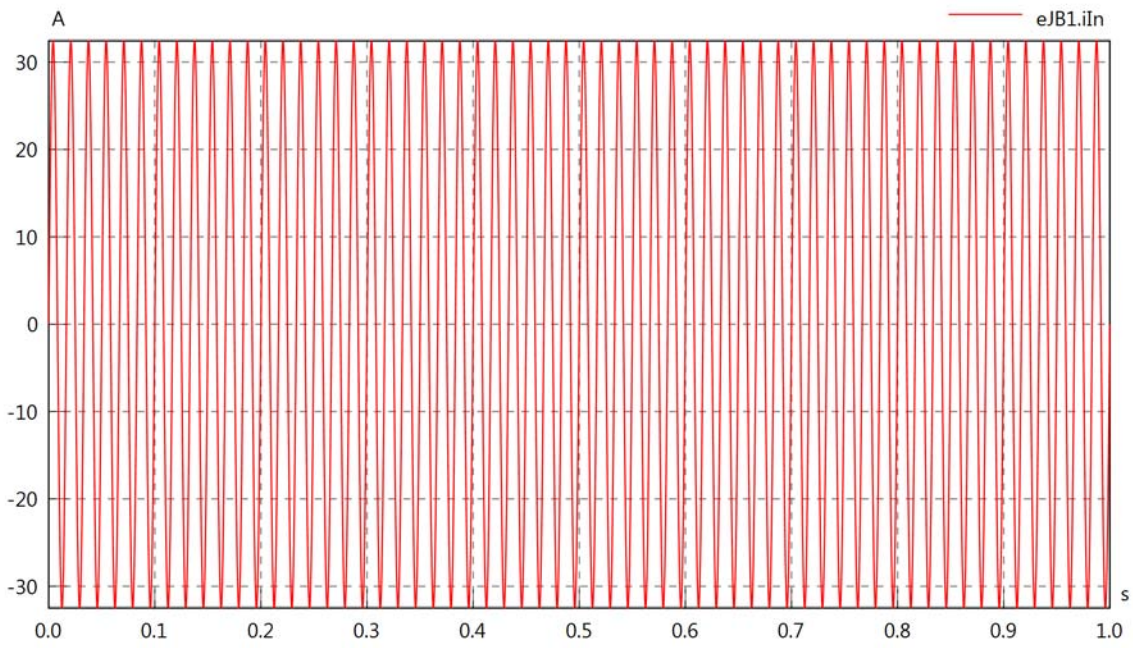

eJB1.iOut

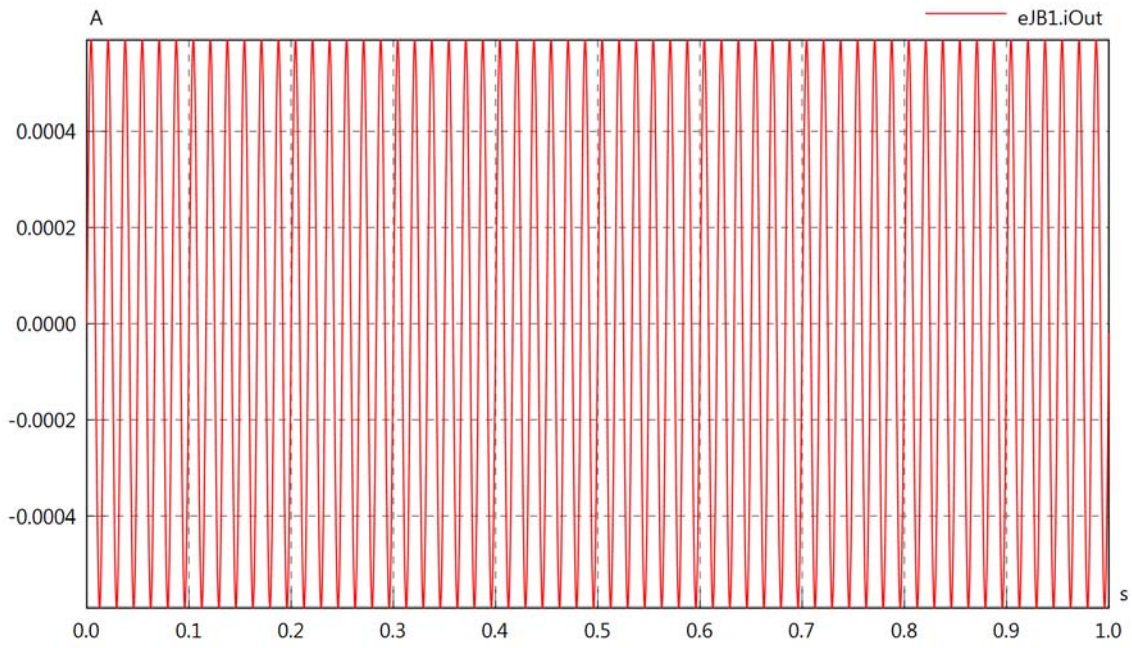

eJB1.PI

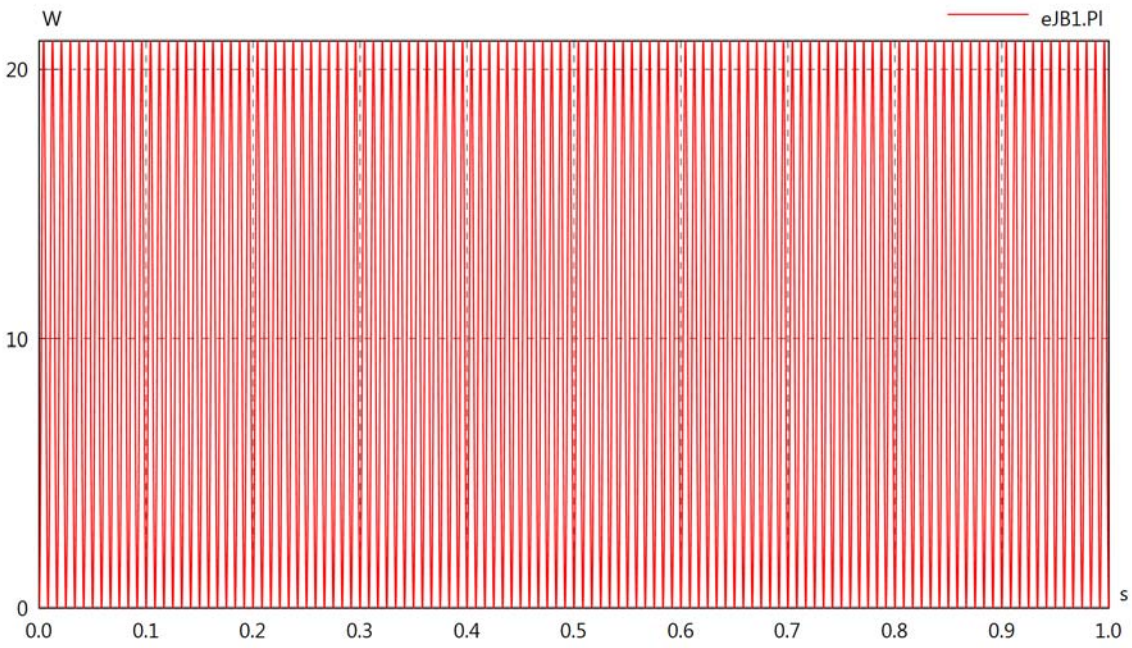
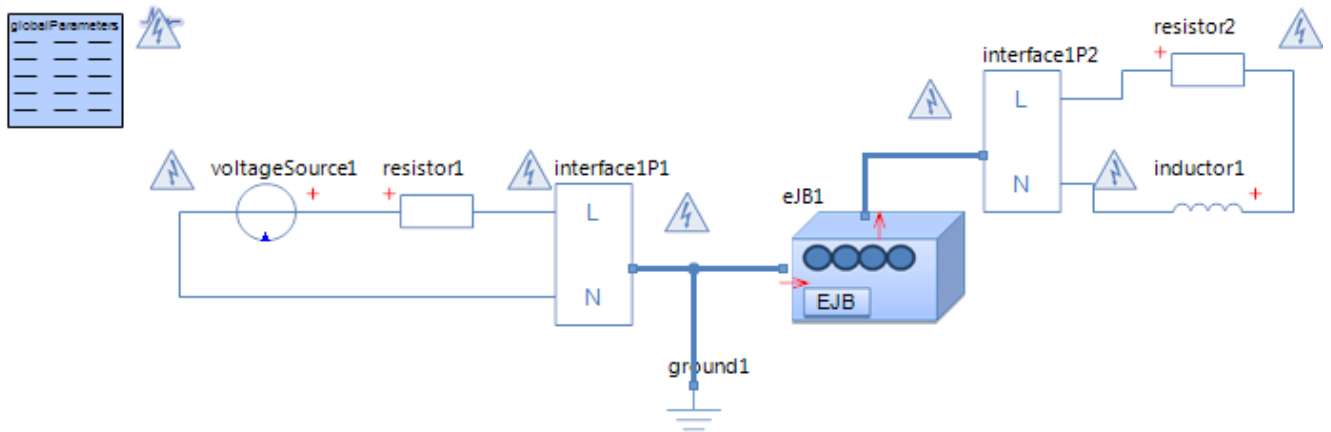

Diagram View



Voltage Source voltageSource1

Parameters

Comment	Name	Current Value	Unit
Voltage	v_src	$230 \cdot \sqrt{2} \cdot \sin(2 \cdot \pi \cdot 120 \cdot t)$	[V]

Resistor resistor1

Parameters

Comment	Name	Current Value	Unit
Resistance	R	10	[Ohm]

Resistor resistor2

Parameters

Comment	Name	Current Value	Unit
Resistance	R	100	[Ohm]

Electrical Junction Box eJB1

Parameters

Comment	Name	Current Value	Unit
Poor or failing L1 connection	bL1	true	
Resistance in L1 connection	rL1	1	[kOhm]
Conductance between L1 and N	G	50	[1/Ohm]

Inductor inductor1

Parameters

Comment	Name	Current Value	Unit
Inductance	L	100	[mH]
Initial Value	i0	0 (Fixed)	[A]
Kind	kind	absolute	

eJB1.vIn

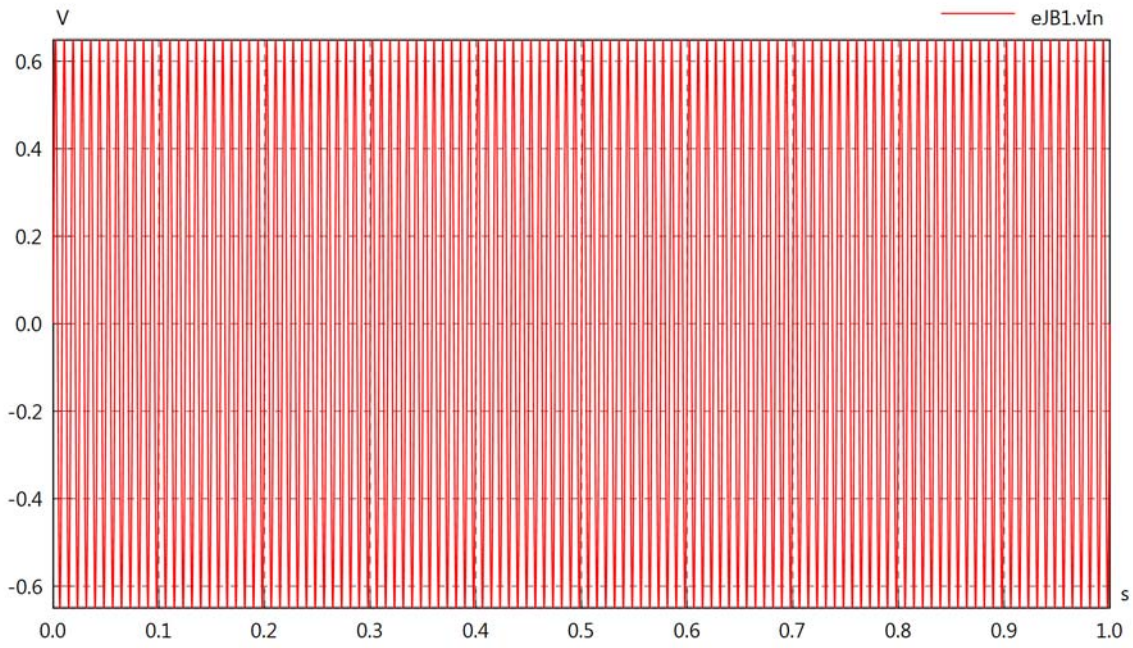

eJB1.vOut

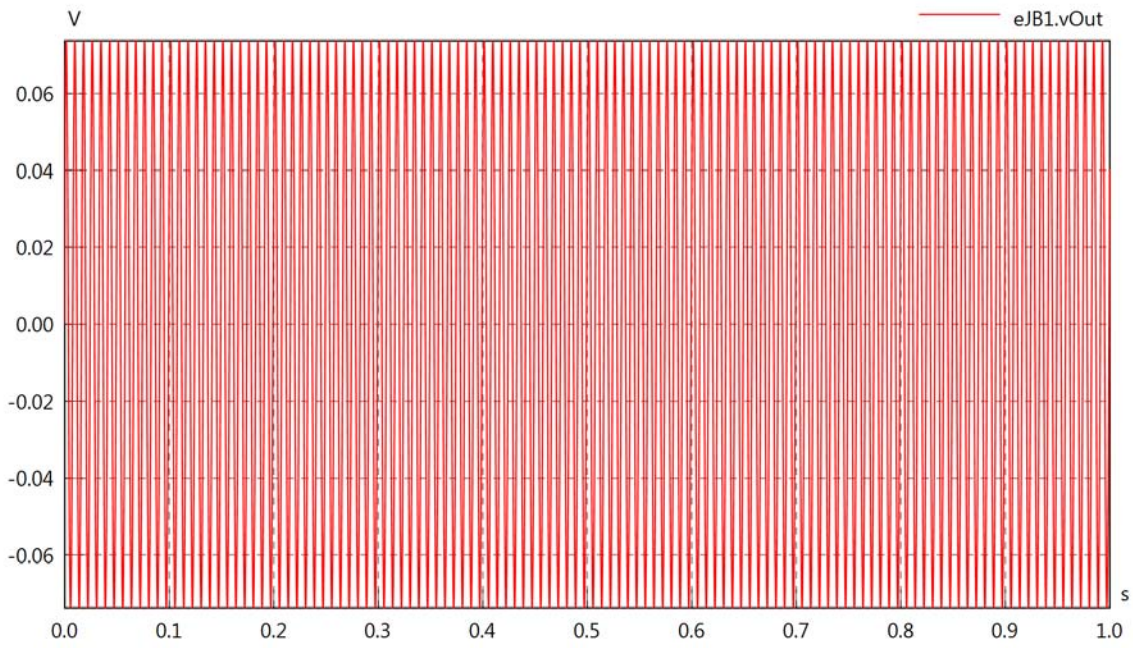

eJB1.v

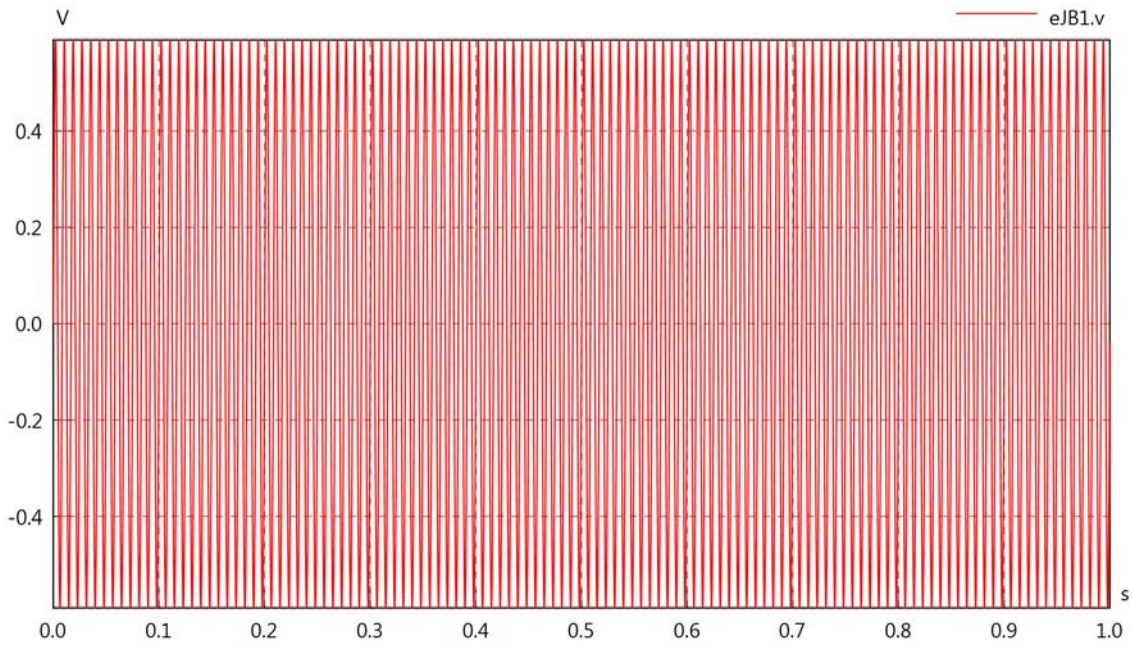

eJB1.iIn

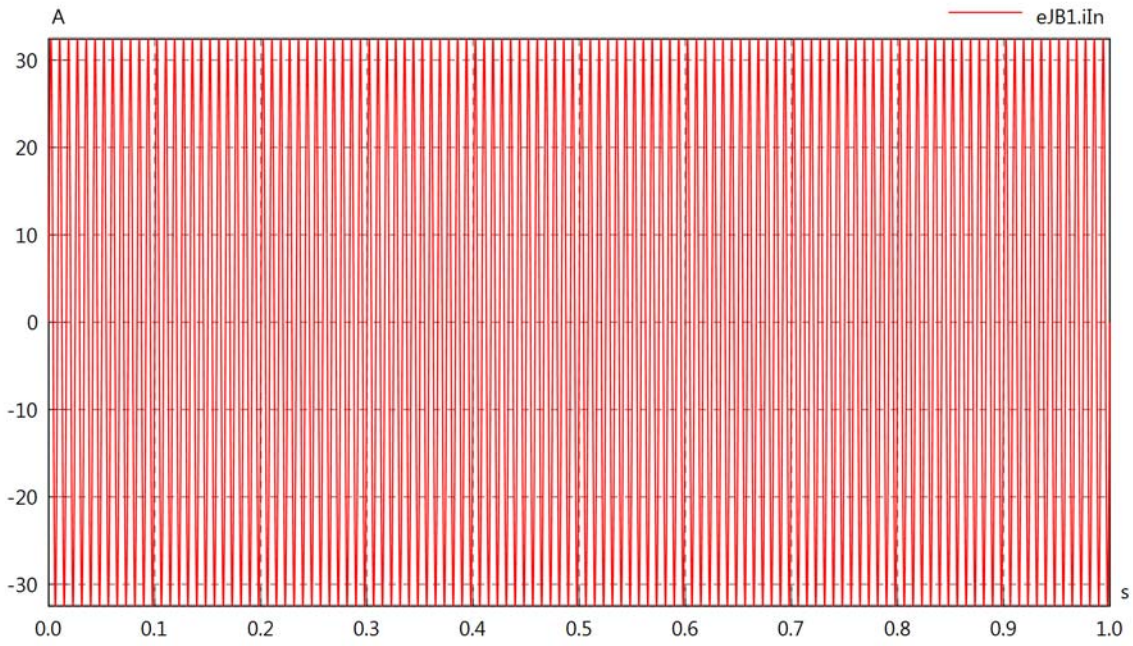

eJB1.iOut

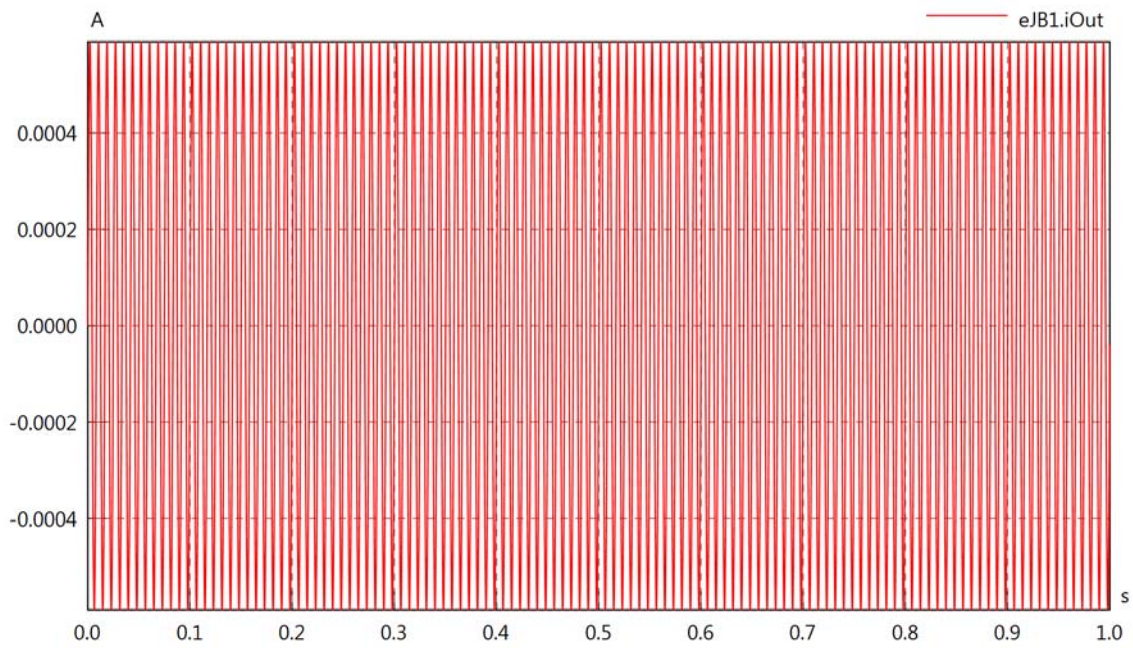

eJB1.PI

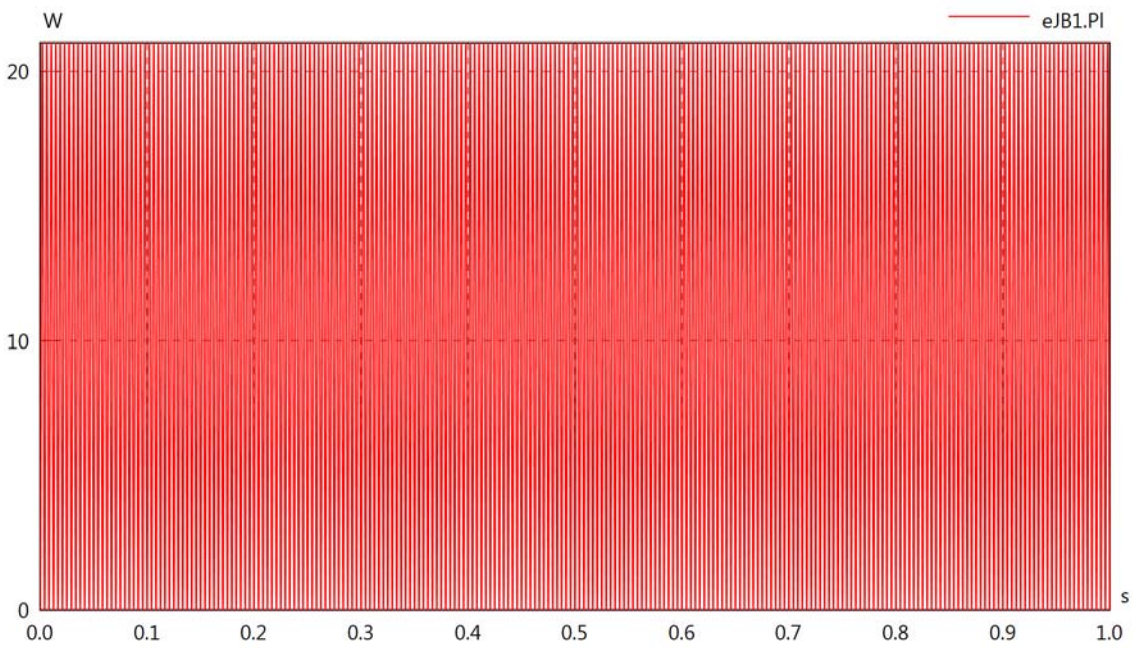
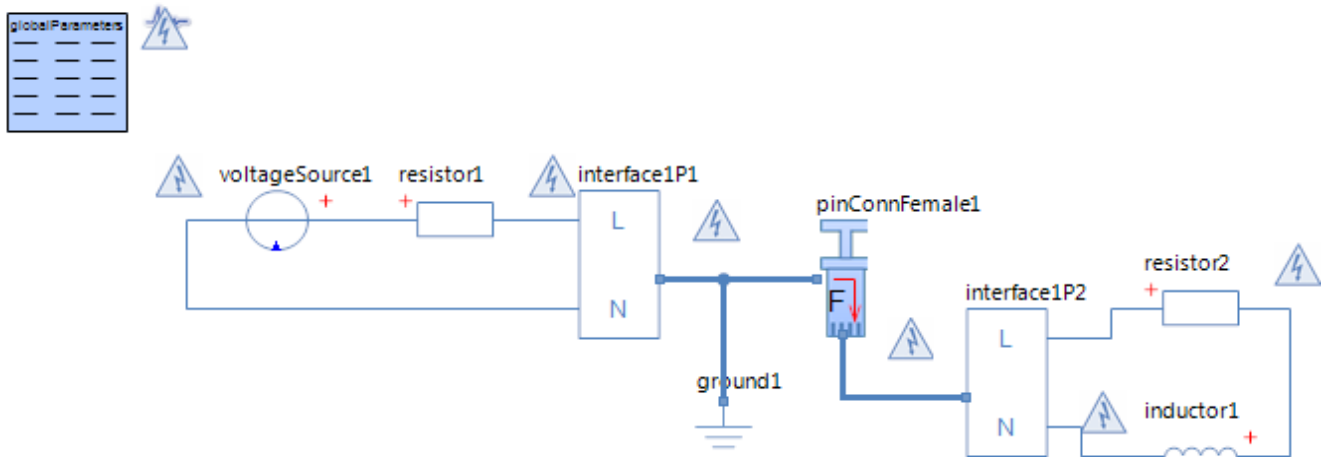

Diagram View



Voltage Source voltageSource1
Parameters

Comment	Name	Current Value	Unit
Voltage	v_src	$230 \cdot \sqrt{2} \cdot \sin(2 \cdot \pi \cdot 30 \cdot t)$	[V]

Resistor resistor1
Parameters

Comment	Name	Current Value	Unit
Resistance	R	10	[Ohm]

Resistor resistor2
Parameters

Comment	Name	Current Value	Unit
Resistance	R	100	[Ohm]

Inductor inductor1
Parameters

Comment	Name	Current Value	Unit
Inductance	L	100	[mH]
Initial Value	i0	0 (Fixed)	[A]
Kind	kind	absolute	

Pin Connector Female pinConnFemale1
Parameters

Comment	Name	Current Value	Unit
Poor or failing L1 connection	bL1	false	

pinConnFemale1.vIn

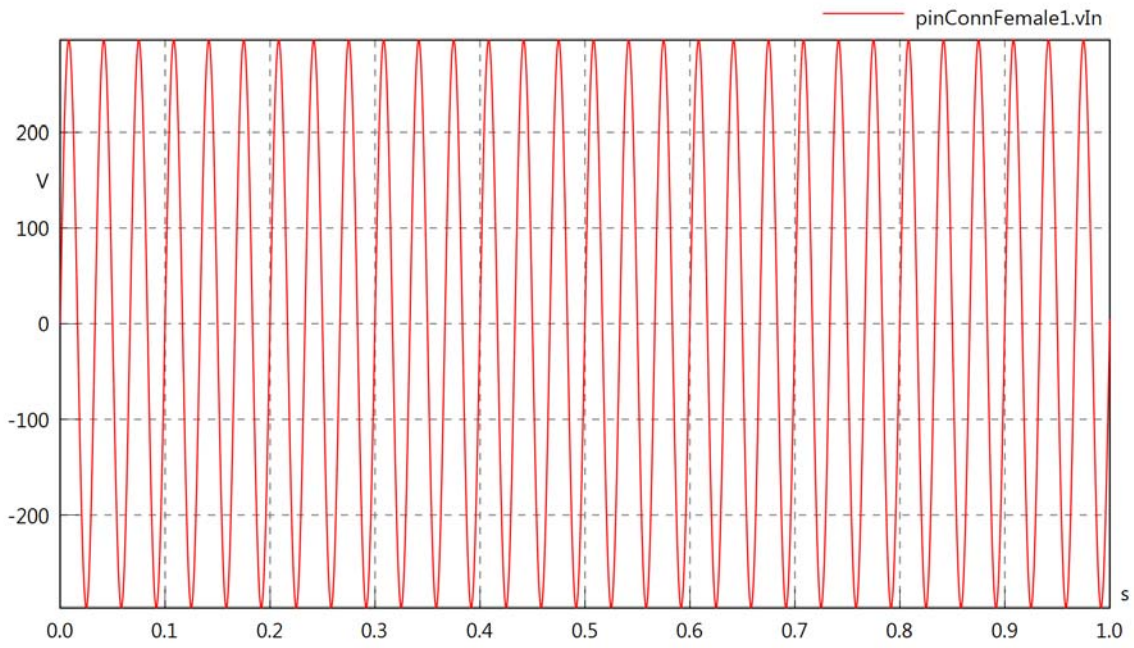

pinConnFemale1.vOut

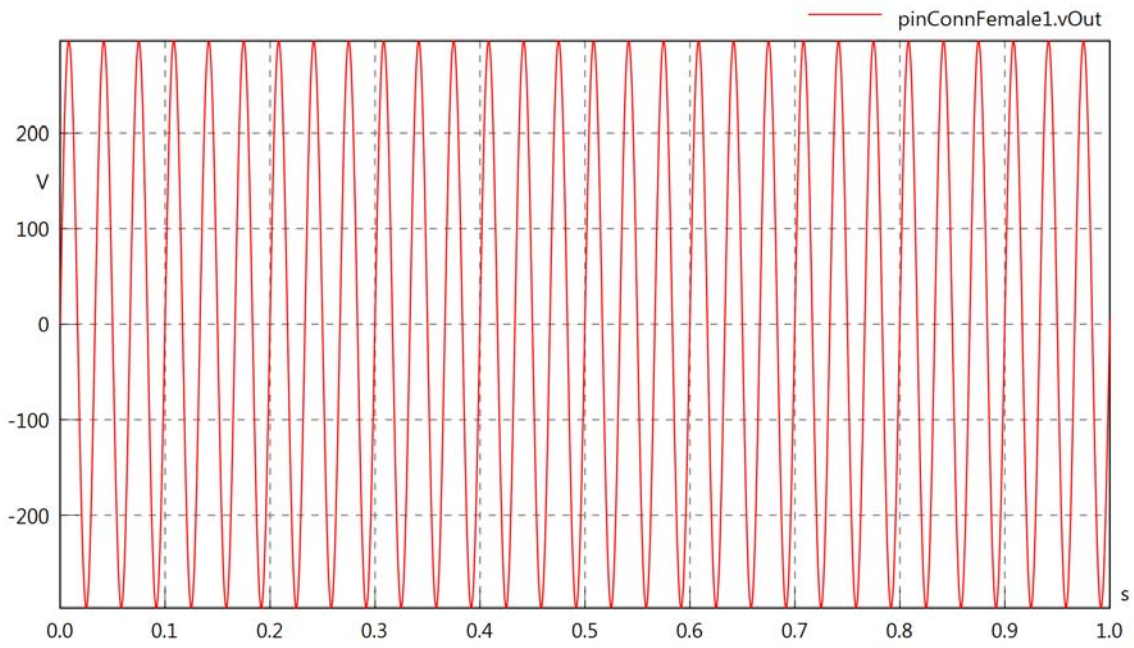

pinConnFemale1.v

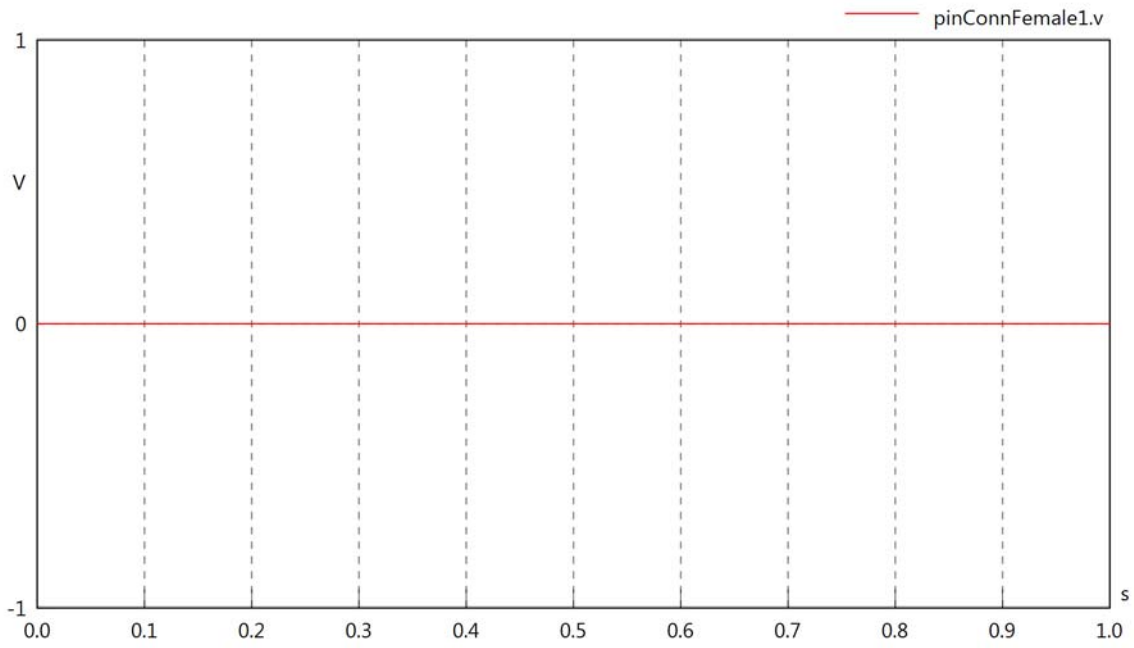

pinConnFemale1.iIn

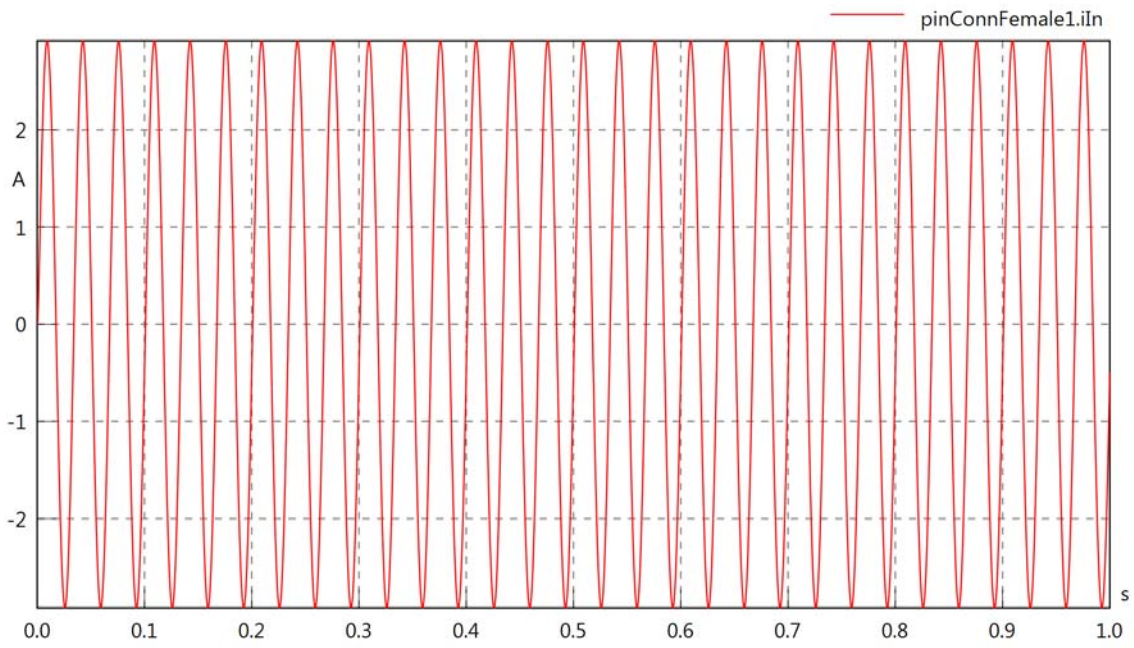

pinConnFemale1.iOut

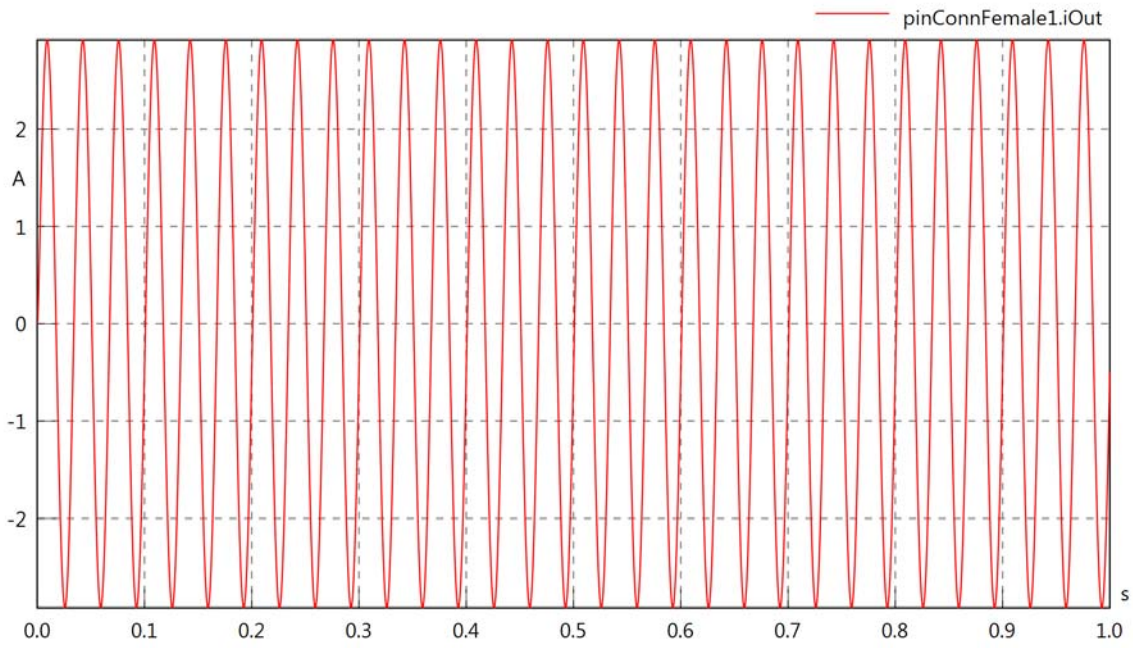

pinConnFemale1.PI

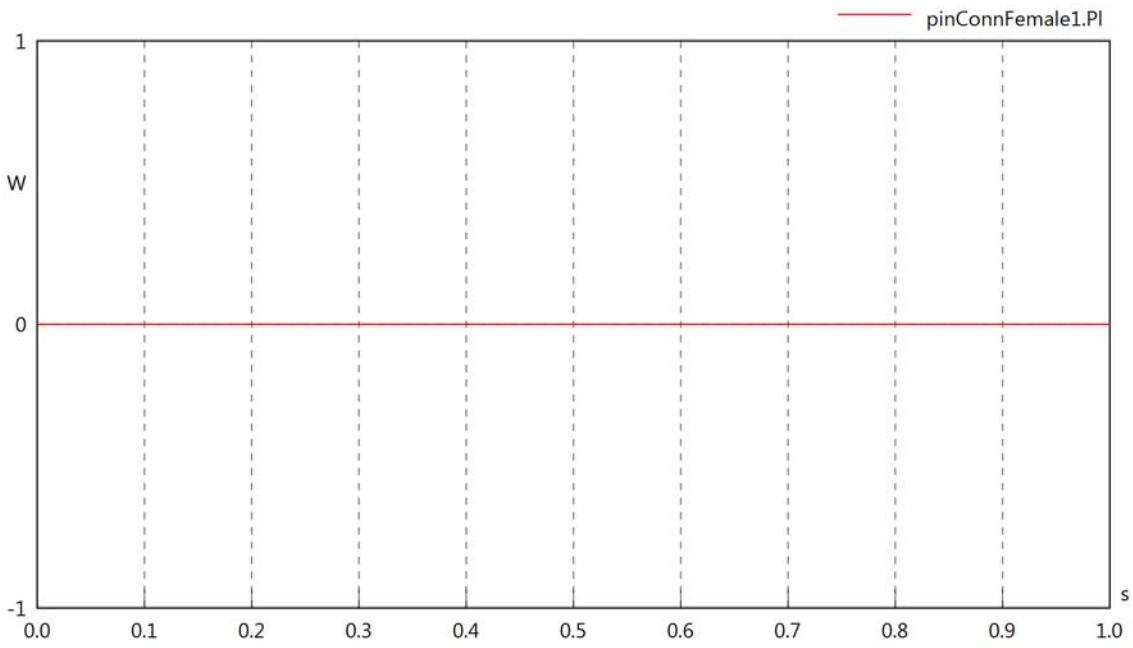
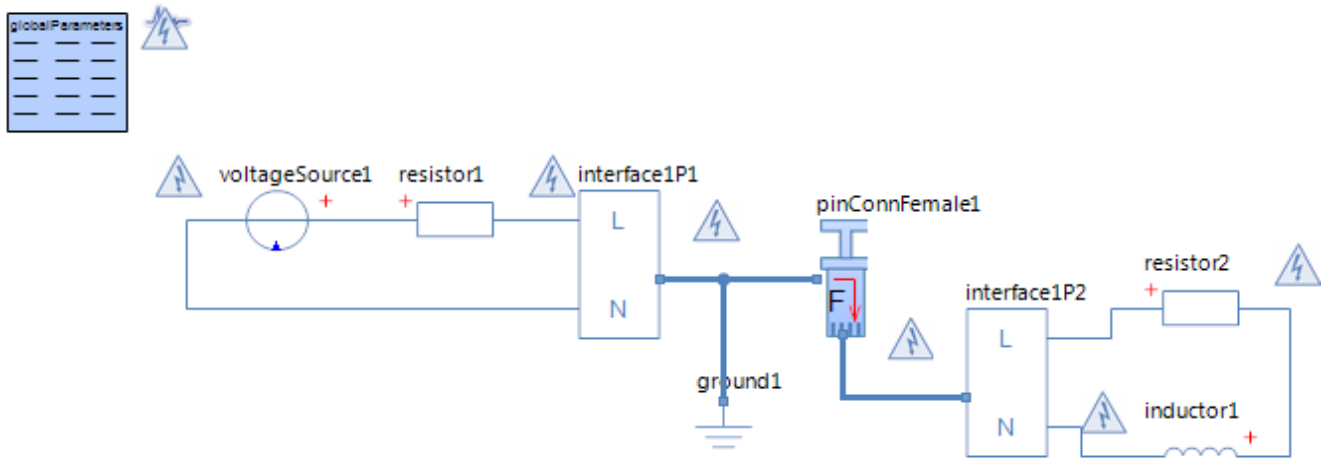

Diagram View



Voltage Source voltageSource1
Parameters

Comment	Name	Current Value	Unit
Voltage	v_src	$230 \cdot \sqrt{2} \cdot \sin(2 \cdot \pi \cdot 60 \cdot t)$	[V]

Resistor resistor1
Parameters

Comment	Name	Current Value	Unit
Resistance	R	10	[Ohm]

Resistor resistor2
Parameters

Comment	Name	Current Value	Unit
Resistance	R	100	[Ohm]

Inductor inductor1
Parameters

Comment	Name	Current Value	Unit
Inductance	L	100	[mH]
Initial Value	i0	0 (Fixed)	[A]
Kind	kind	absolute	

Pin Connector Female pinConnFemale1
Parameters

Comment	Name	Current Value	Unit
Poor or failing L1 connection	bL1	false	

pinConnFemale1.vIn

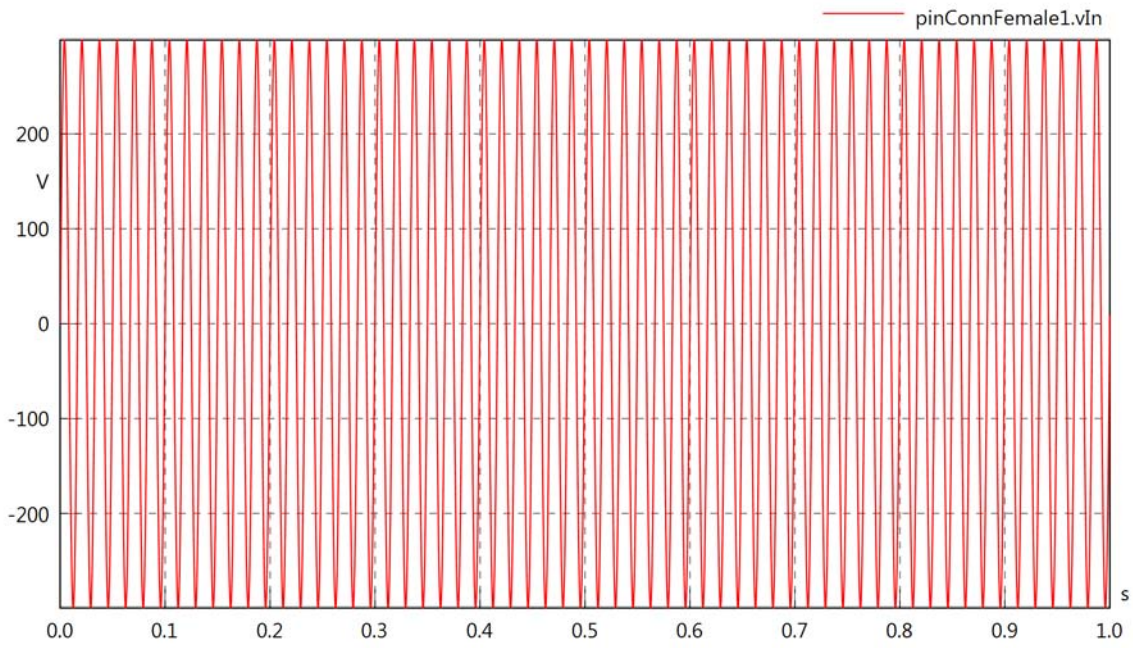

pinConnFemale1.vOut

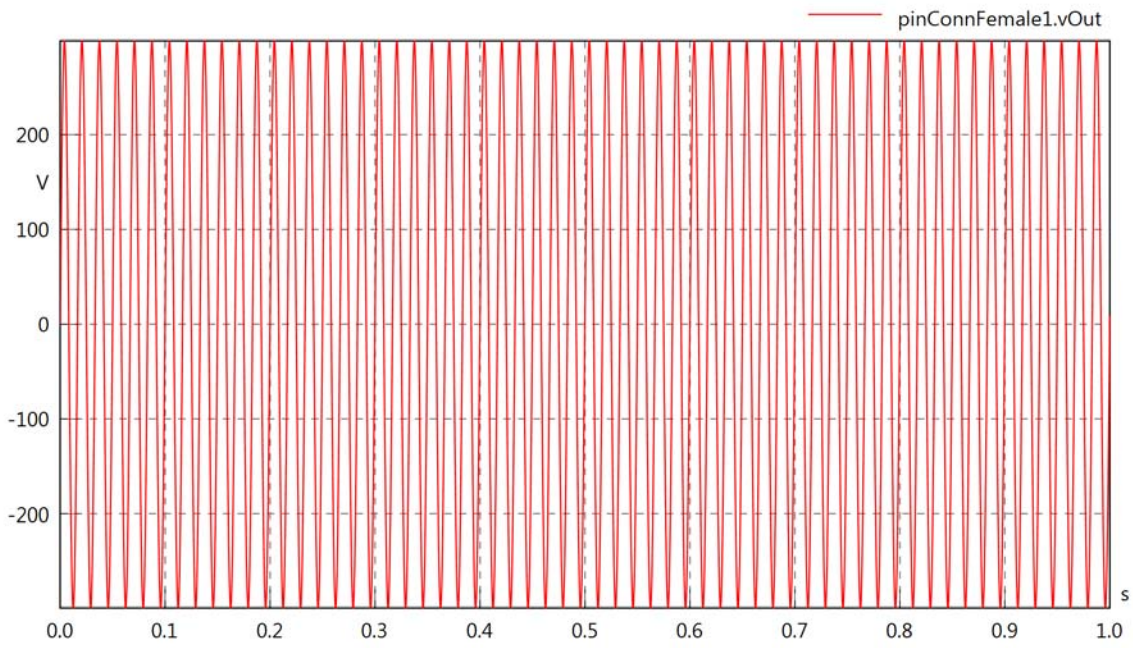

pinConnFemale1.v

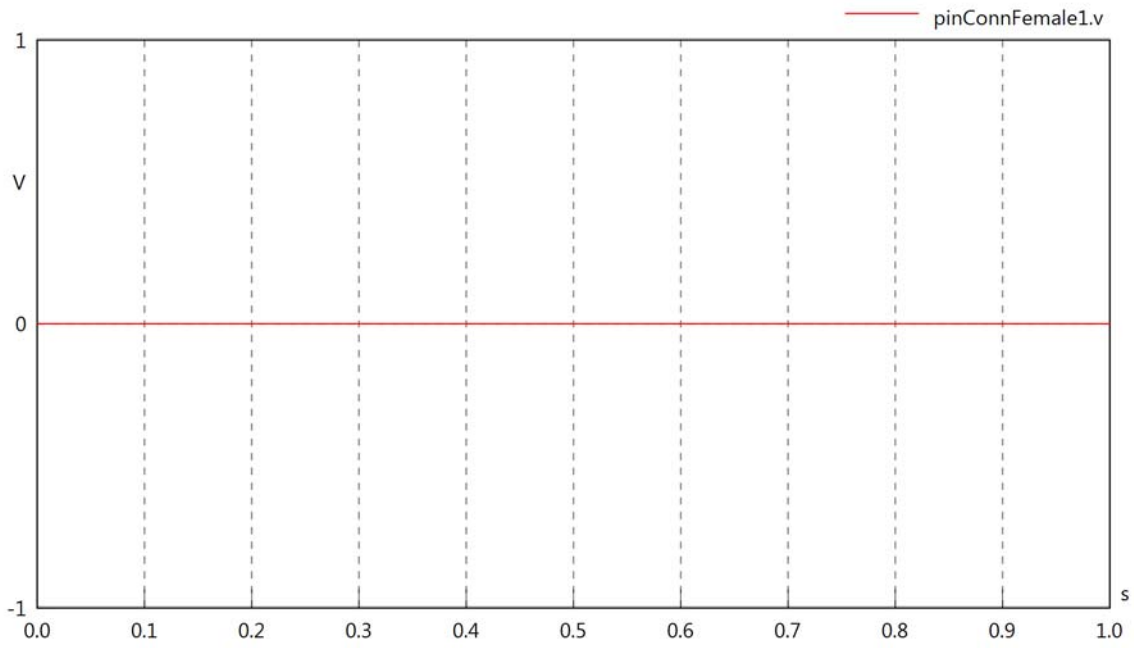

pinConnFemale1.iIn

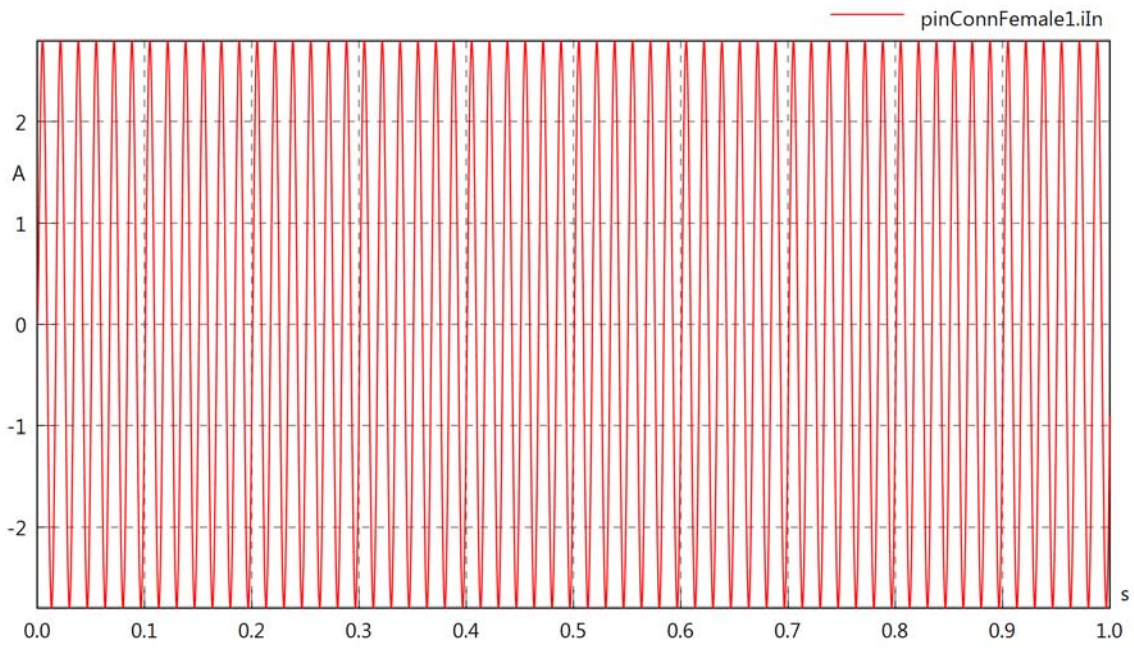

pinConnFemale1.iOut

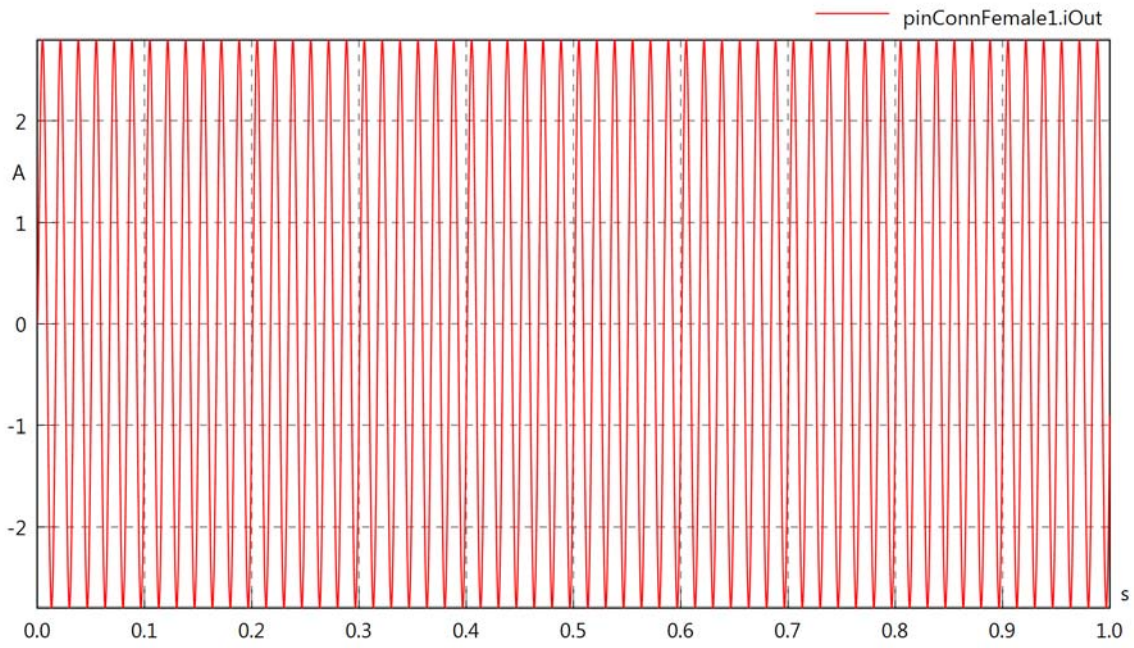

pinConnFemale1.PI

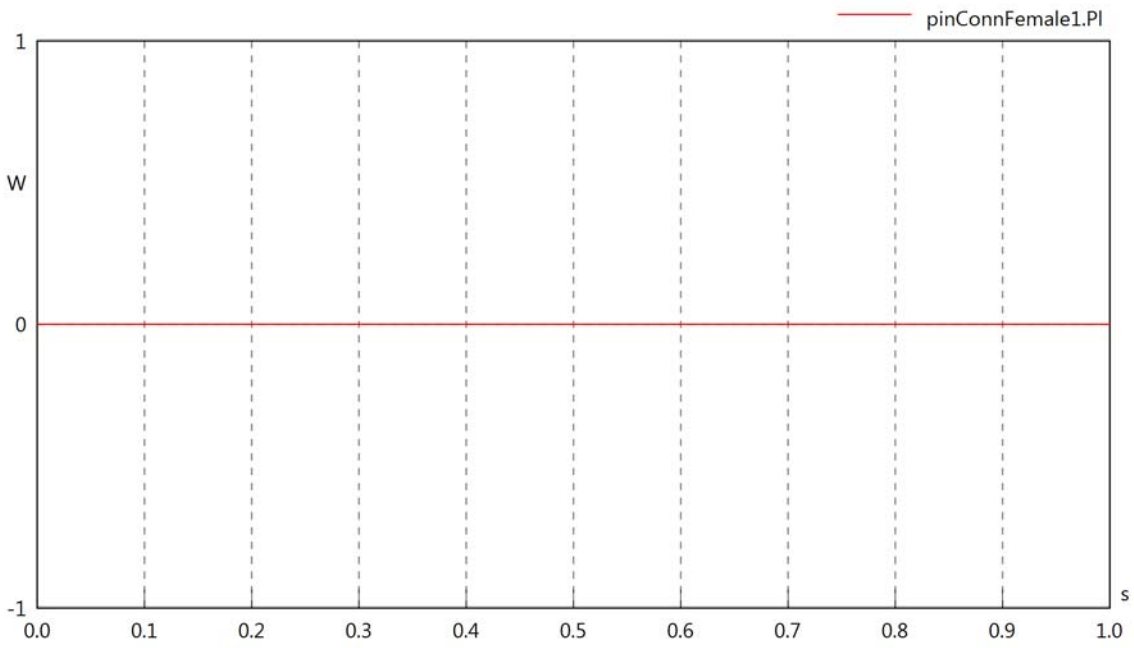
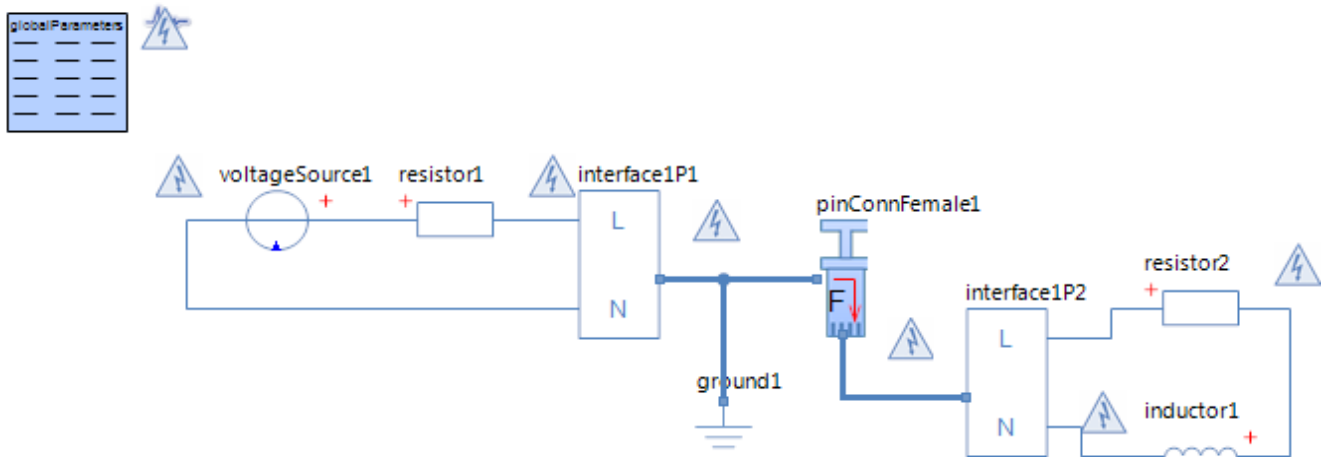

Diagram View



Voltage Source voltageSource1
Parameters

Comment	Name	Current Value	Unit
Voltage	v_src	$230 \cdot \sqrt{2} \cdot \sin(2 \cdot \pi \cdot 120 \cdot t)$	[V]

Resistor resistor1
Parameters

Comment	Name	Current Value	Unit
Resistance	R	10	[Ohm]

Resistor resistor2
Parameters

Comment	Name	Current Value	Unit
Resistance	R	100	[Ohm]

Inductor inductor1
Parameters

Comment	Name	Current Value	Unit
Inductance	L	100	[mH]
Initial Value	i0	0 (Fixed)	[A]
Kind	kind	absolute	

Pin Connector Female pinConnFemale1
Parameters

Comment	Name	Current Value	Unit
Poor or failing L1 connection	bL1	false	

pinConnFemale1.vIn

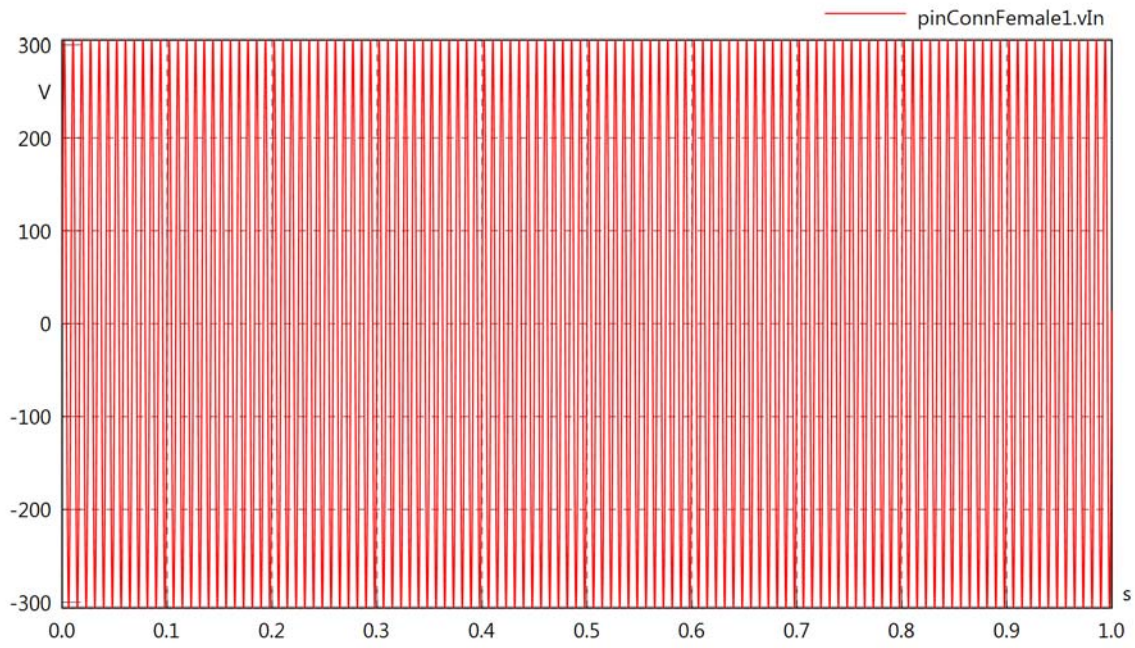

pinConnFemale1.vOut

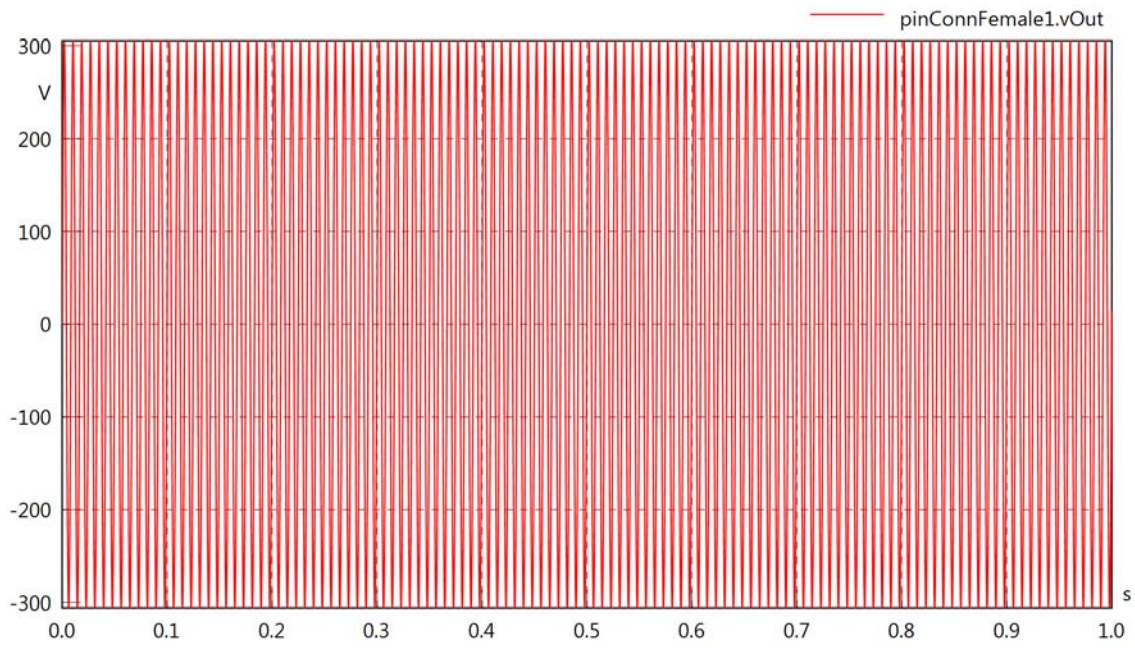

pinConnFemale1.v

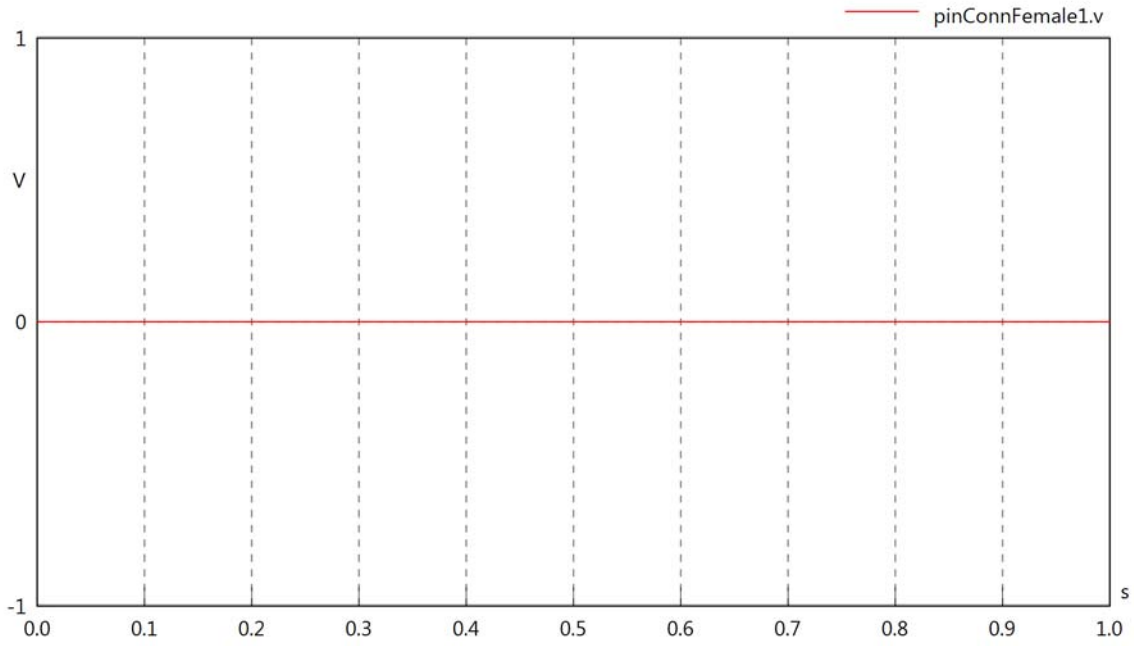

pinConnFemale1.iIn

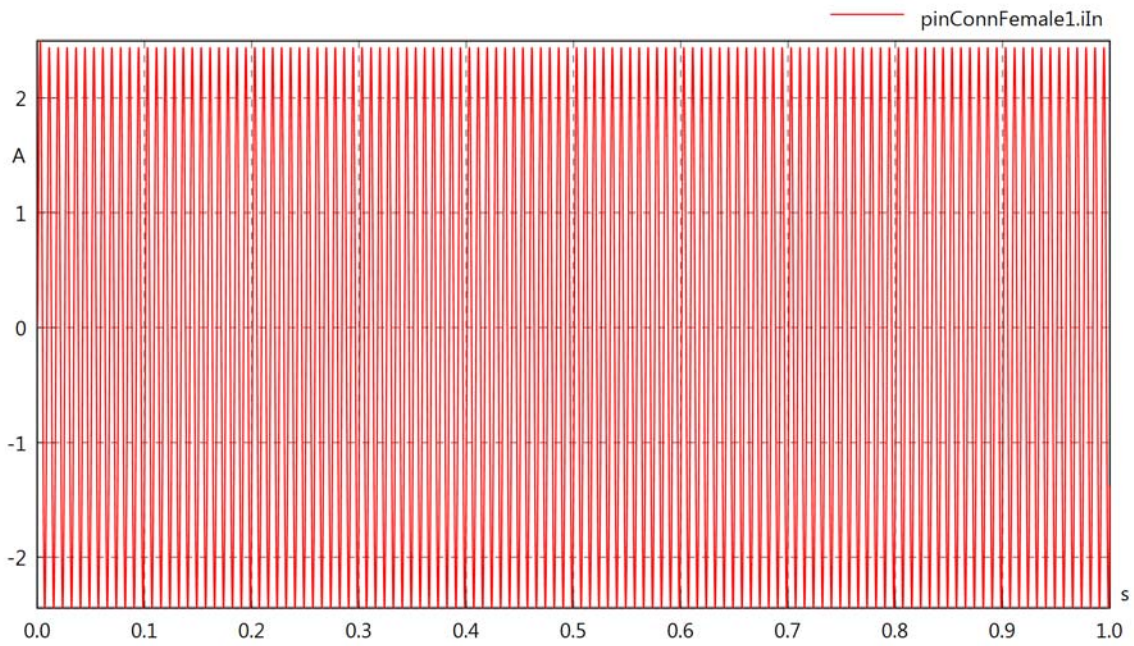

pinConnFemale1.iOut

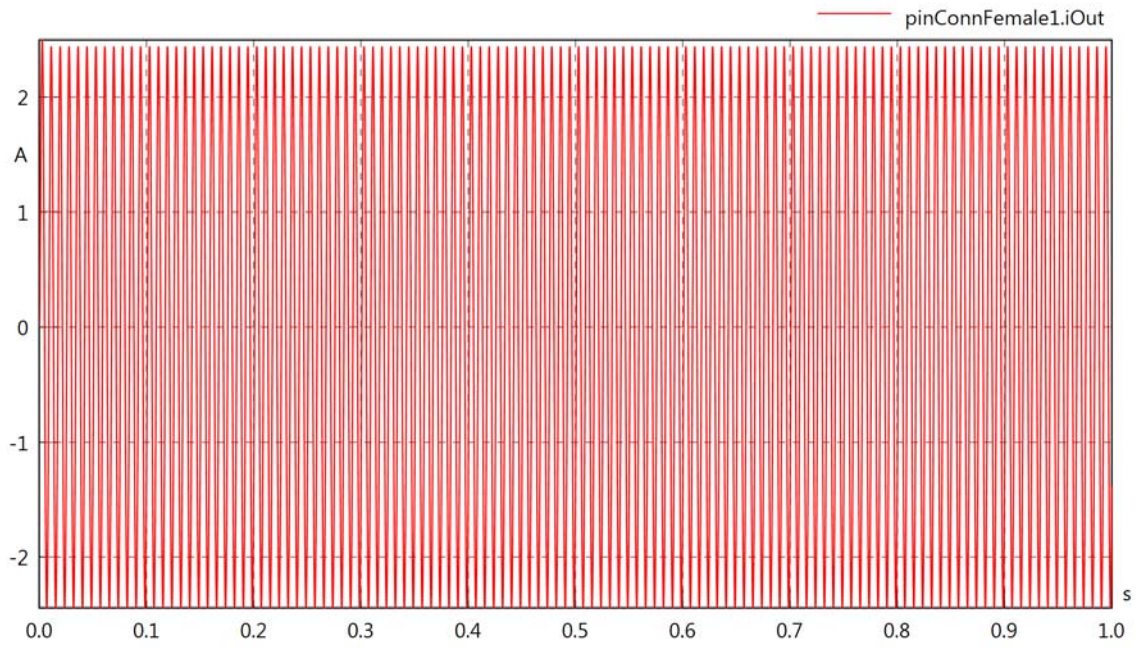

pinConnFemale1.PI

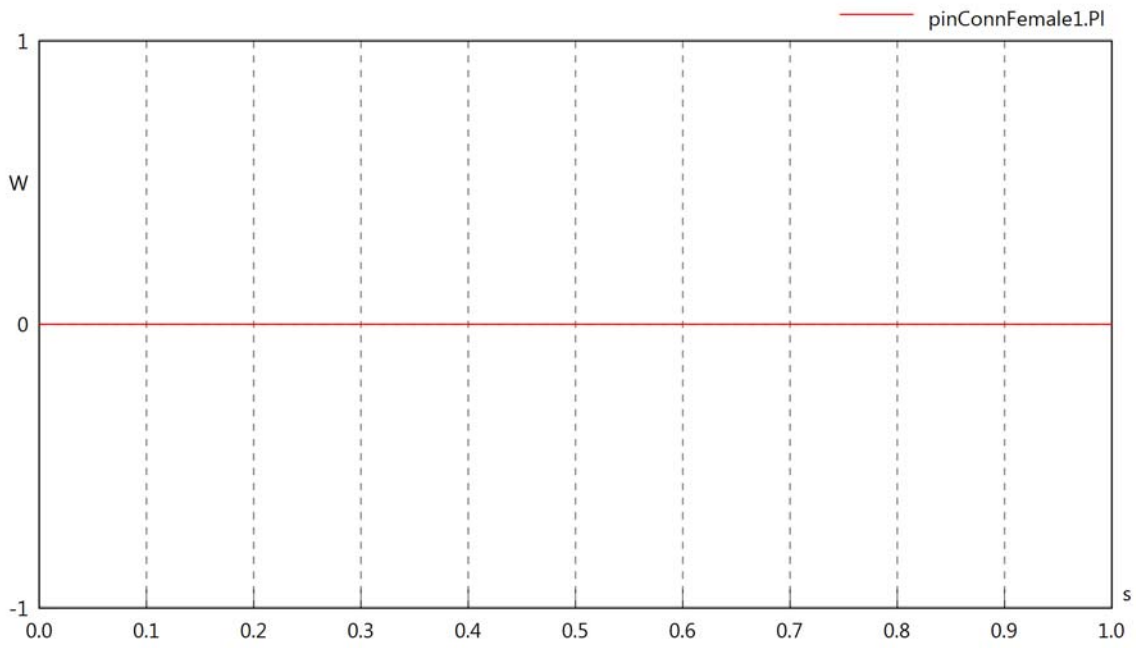
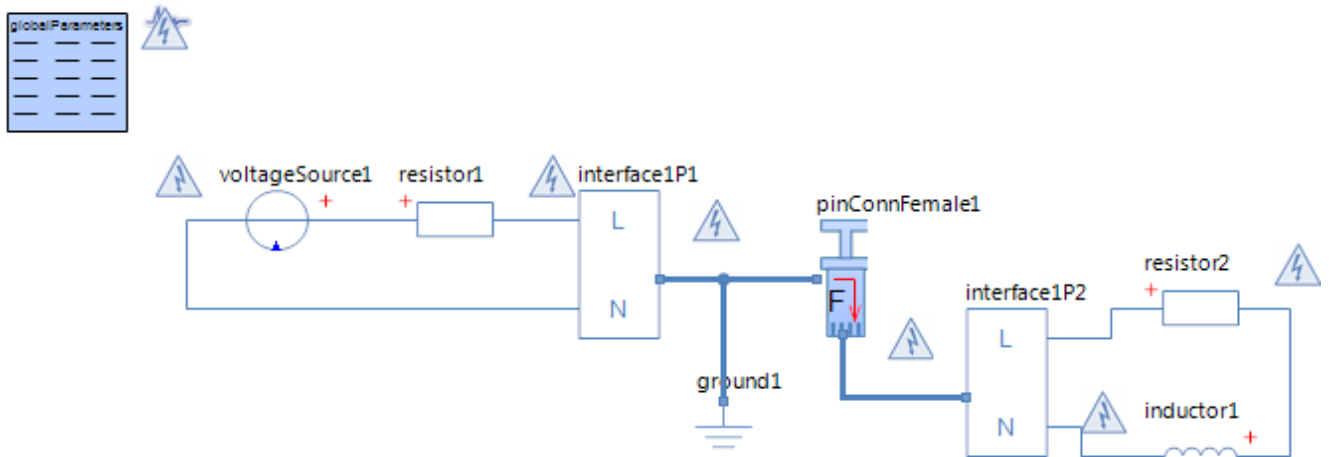

Diagram View



Voltage Source voltageSource1
Parameters

Comment	Name	Current Value	Unit
Voltage	v_src	$230 \cdot \sqrt{2} \cdot \sin(2 \cdot \pi \cdot 30 \cdot t)$	[V]

Resistor resistor1
Parameters

Comment	Name	Current Value	Unit
Resistance	R	10	[Ohm]

Resistor resistor2
Parameters

Comment	Name	Current Value	Unit
Resistance	R	100	[Ohm]

Inductor inductor1
Parameters

Comment	Name	Current Value	Unit
Inductance	L	100	[mH]
Initial Value	i0	0 (Fixed)	[A]
Kind	kind	absolute	

Pin Connector Female pinConnFemale1
Parameters

Comment	Name	Current Value	Unit
Poor or failing L1 connection	bL1	true	
Resistance in L1 connection	rL1	1	[kOhm]
Conductance between L1 and N	G	50	[1/Ohm]

pinConnFemale1.vIn

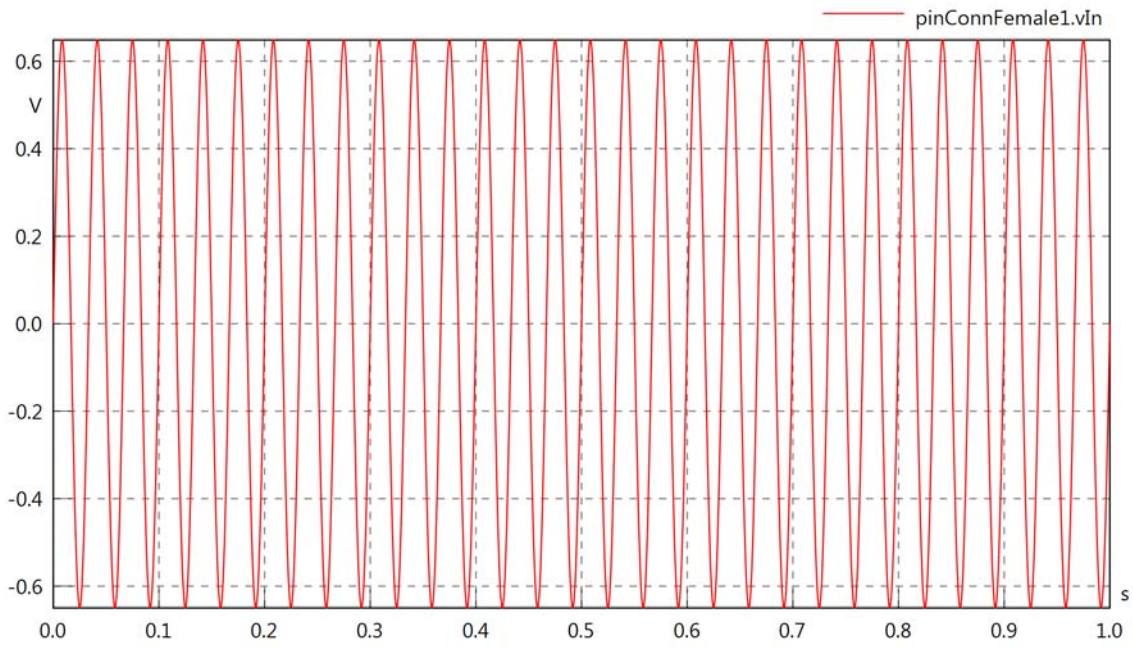

pinConnFemale1.vOut

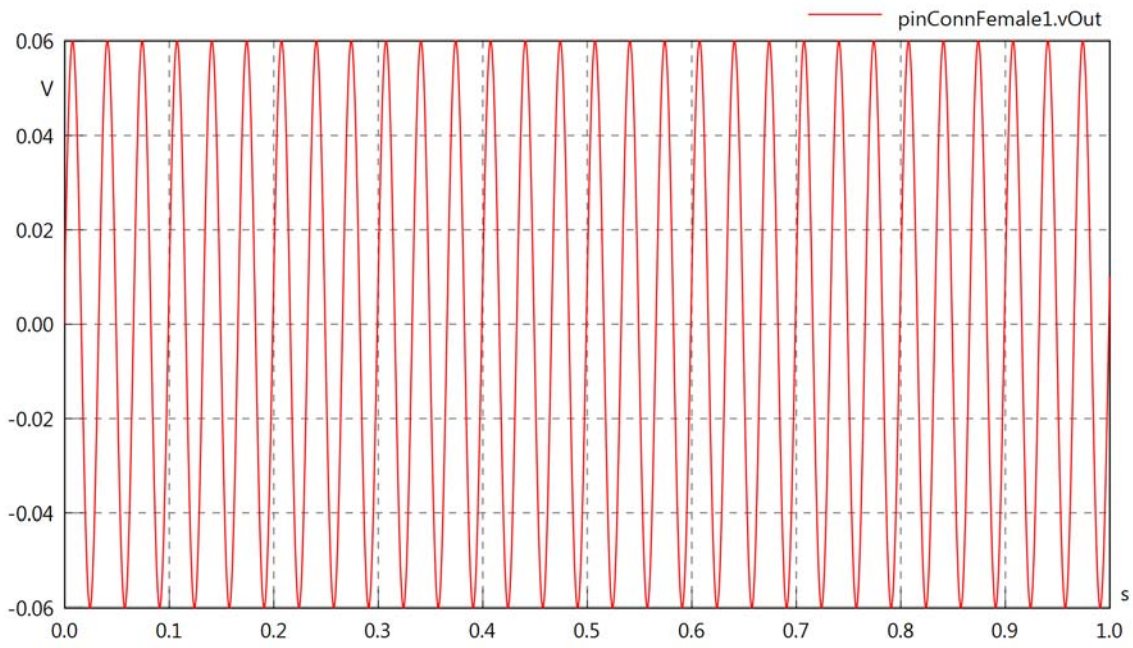

pinConnFemale1.v

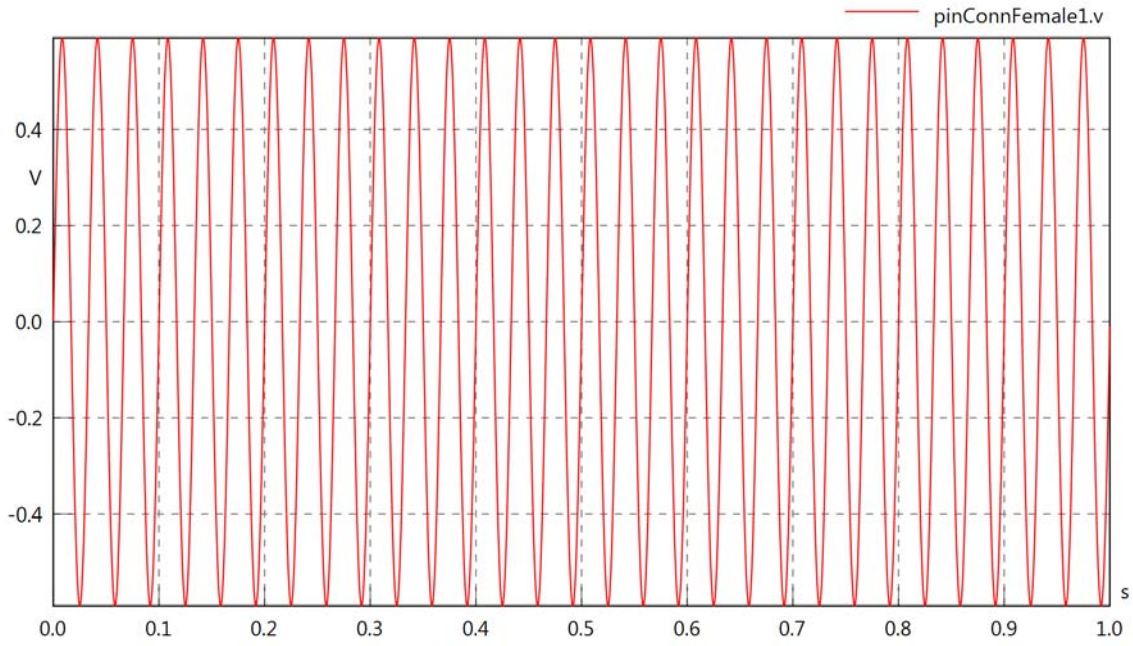

pinConnFemale1.iIn

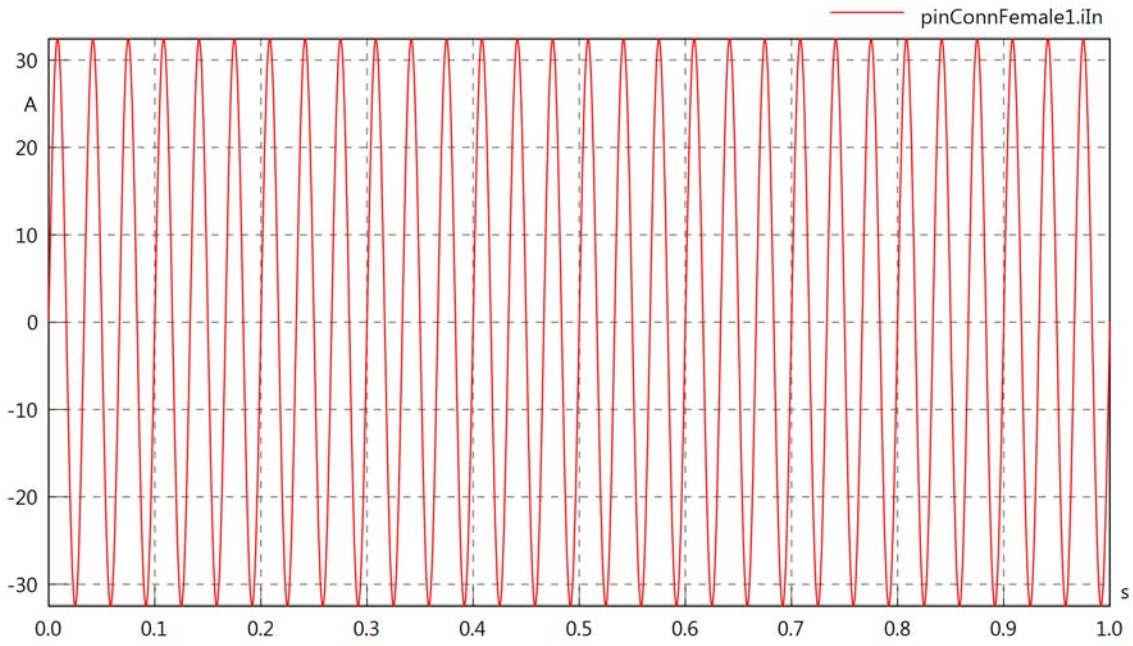

pinConnFemale1.iOut

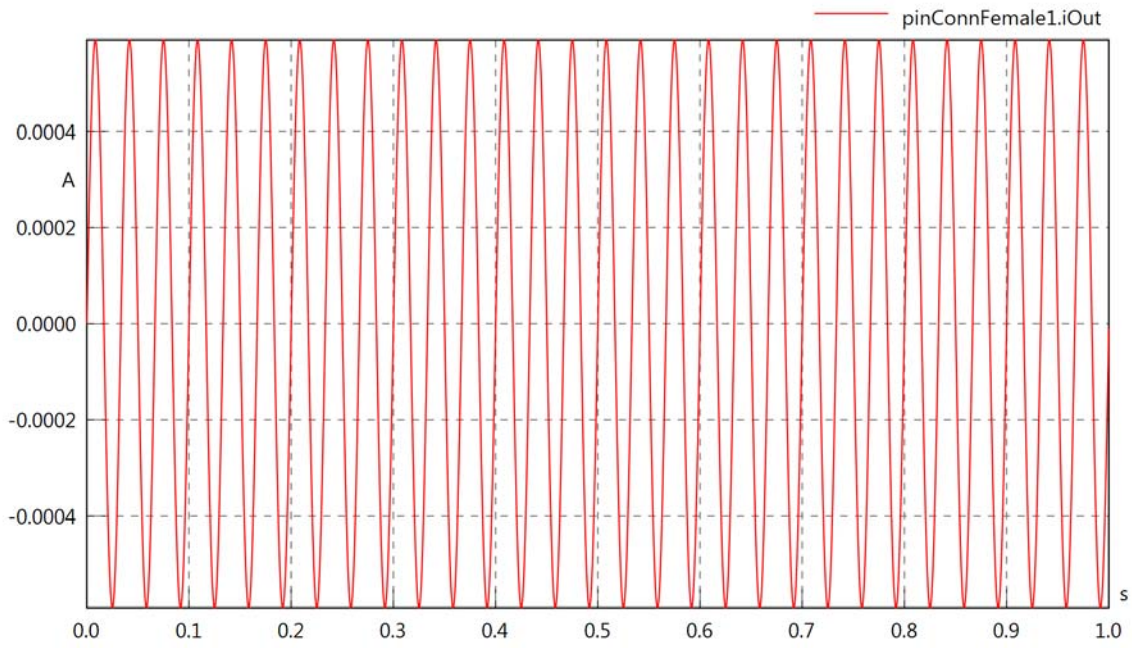

pinConnFemale1.PI

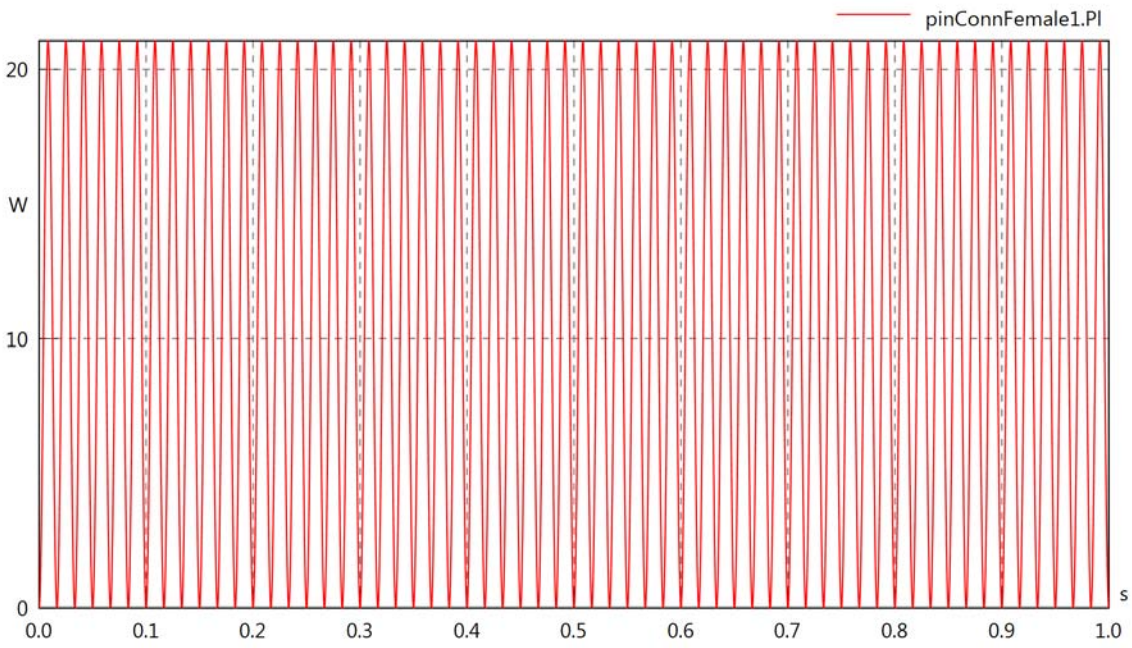
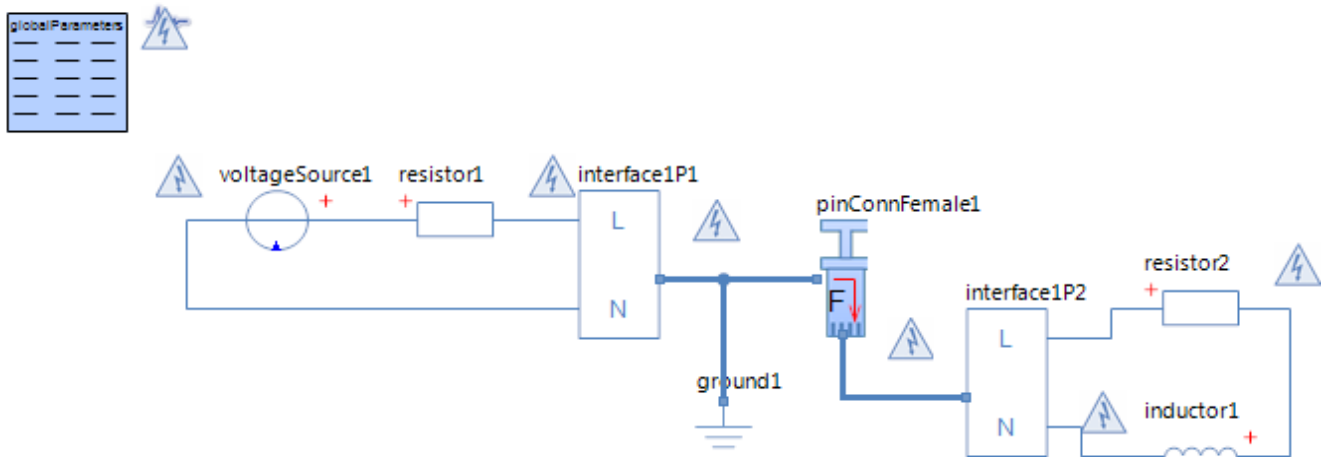

Diagram View



Voltage Source voltageSource1
Parameters

Comment	Name	Current Value	Unit
Voltage	v_src	$230 \cdot \sqrt{2} \cdot \sin(2 \cdot \pi \cdot 60 \cdot t)$	[V]

Resistor resistor1
Parameters

Comment	Name	Current Value	Unit
Resistance	R	10	[Ohm]

Resistor resistor2
Parameters

Comment	Name	Current Value	Unit
Resistance	R	100	[Ohm]

Inductor inductor1
Parameters

Comment	Name	Current Value	Unit
Inductance	L	100	[mH]
Initial Value	i0	0 (Fixed)	[A]
Kind	kind	absolute	

Pin Connector Female pinConnFemale1
Parameters

Comment	Name	Current Value	Unit
Poor or failing L1 connection	bL1	true	
Resistance in L1 connection	rL1	1	[kOhm]
Conductance between L1 and N	G	50	[1/Ohm]

pinConnFemale1.vIn

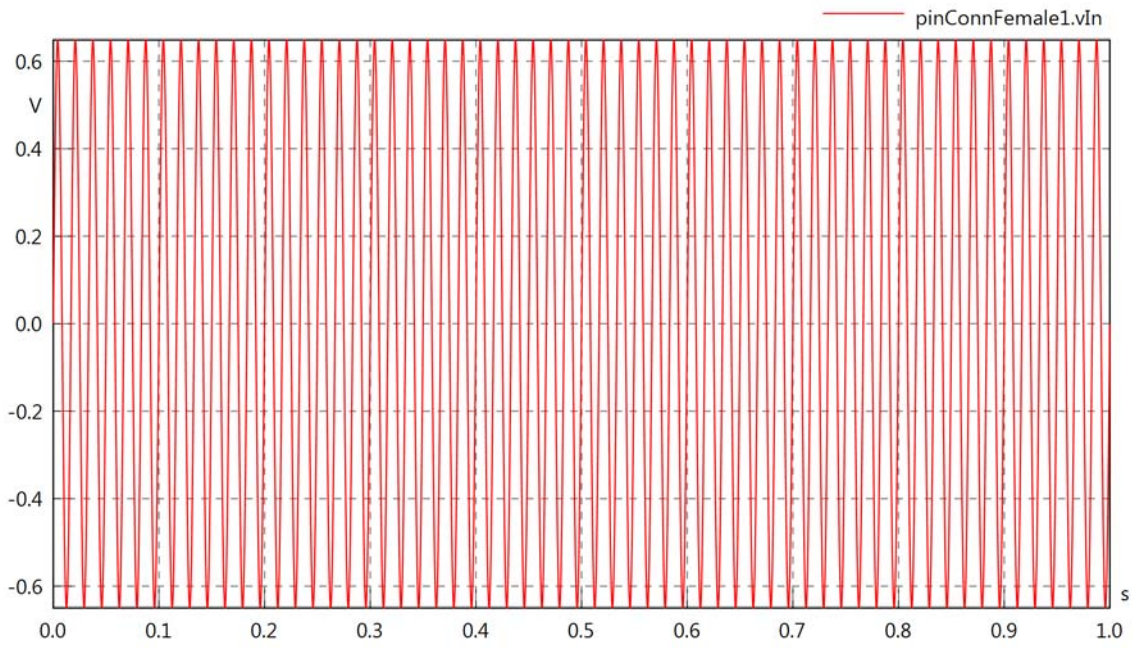

pinConnFemale1.vOut

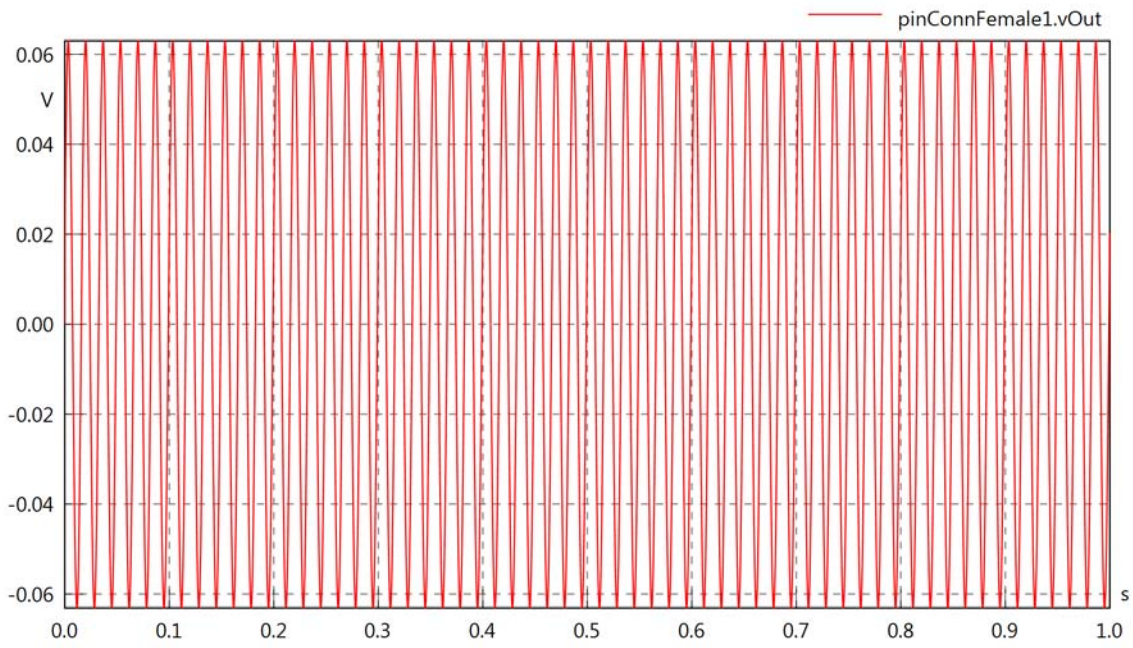

pinConnFemale1.v

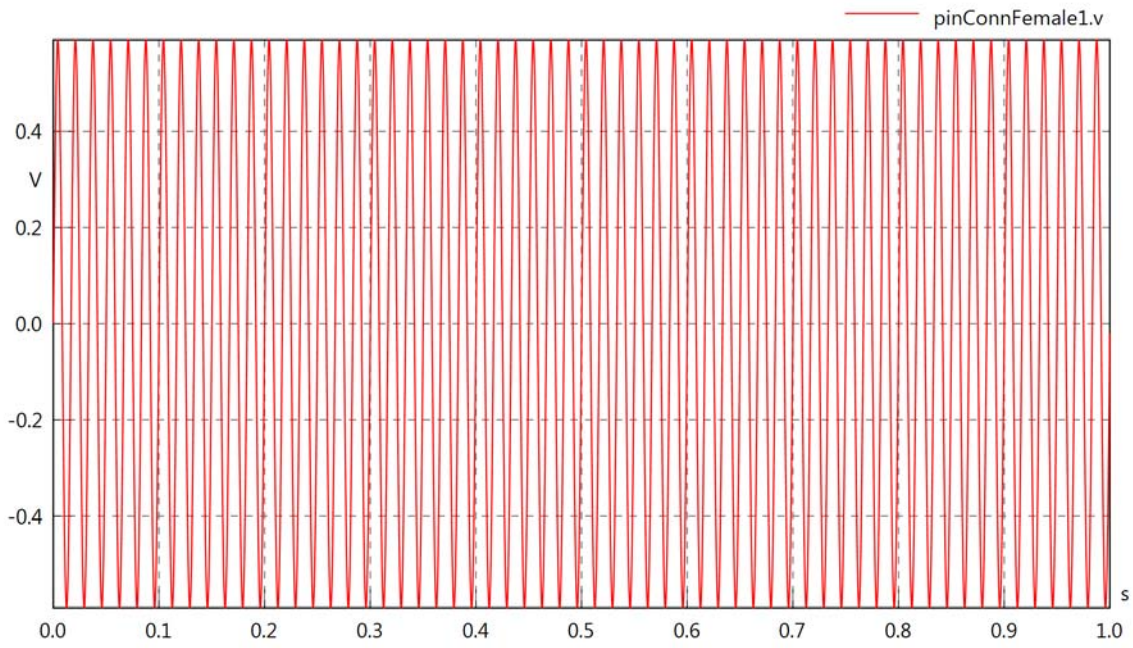

pinConnFemale1.iIn

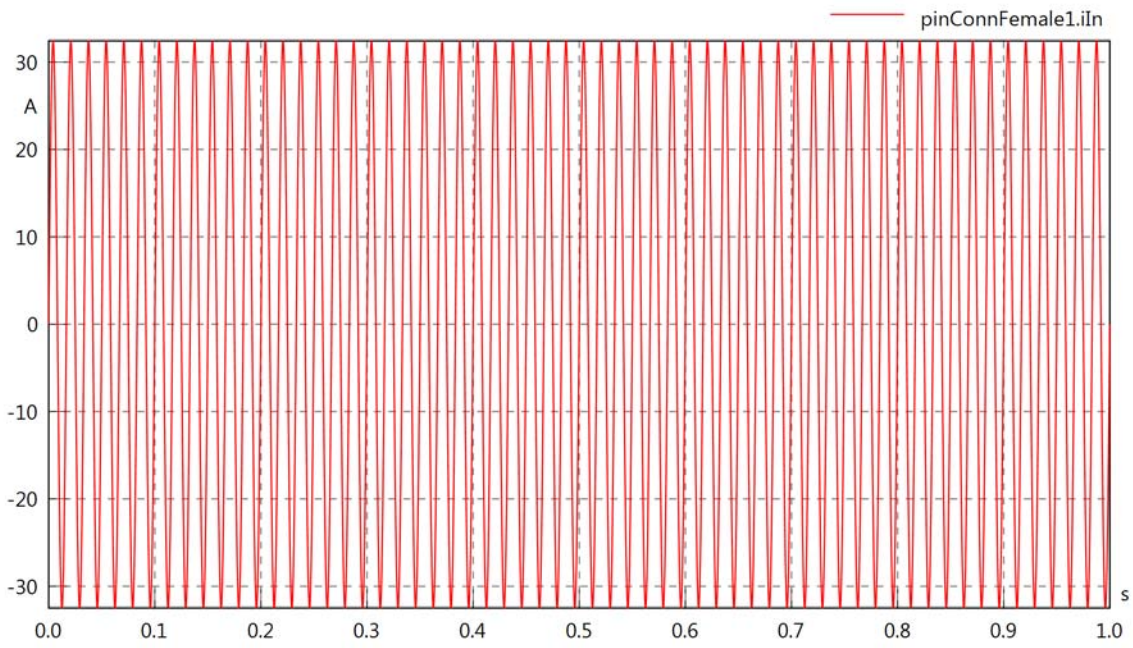

pinConnFemale1.iOut

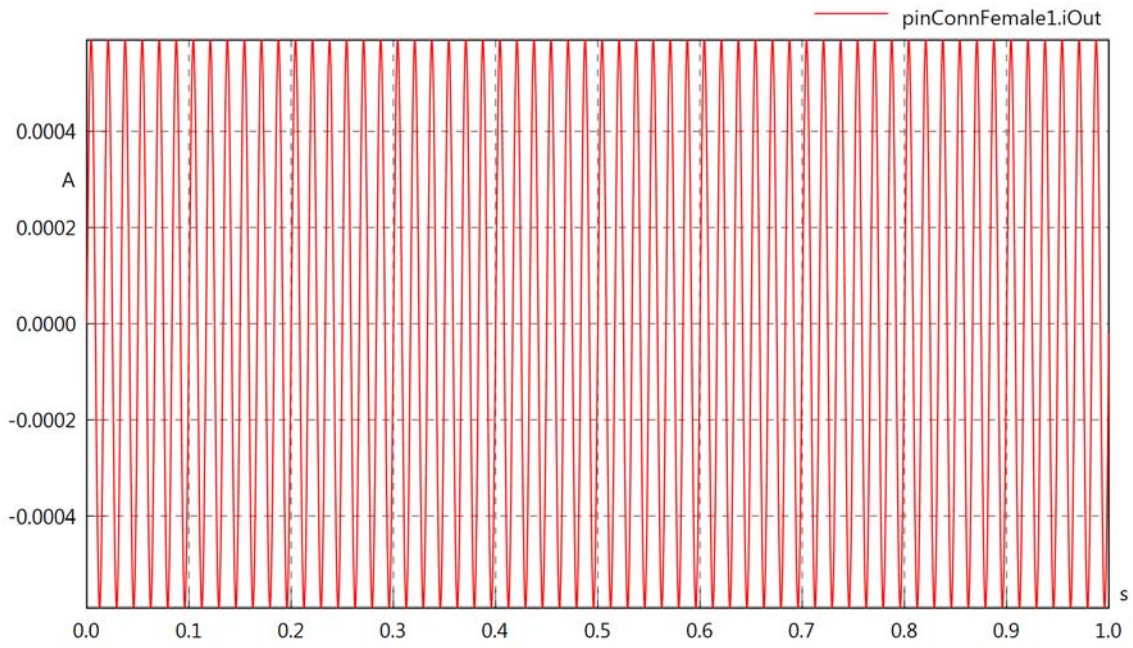

pinConnFemale1.PI

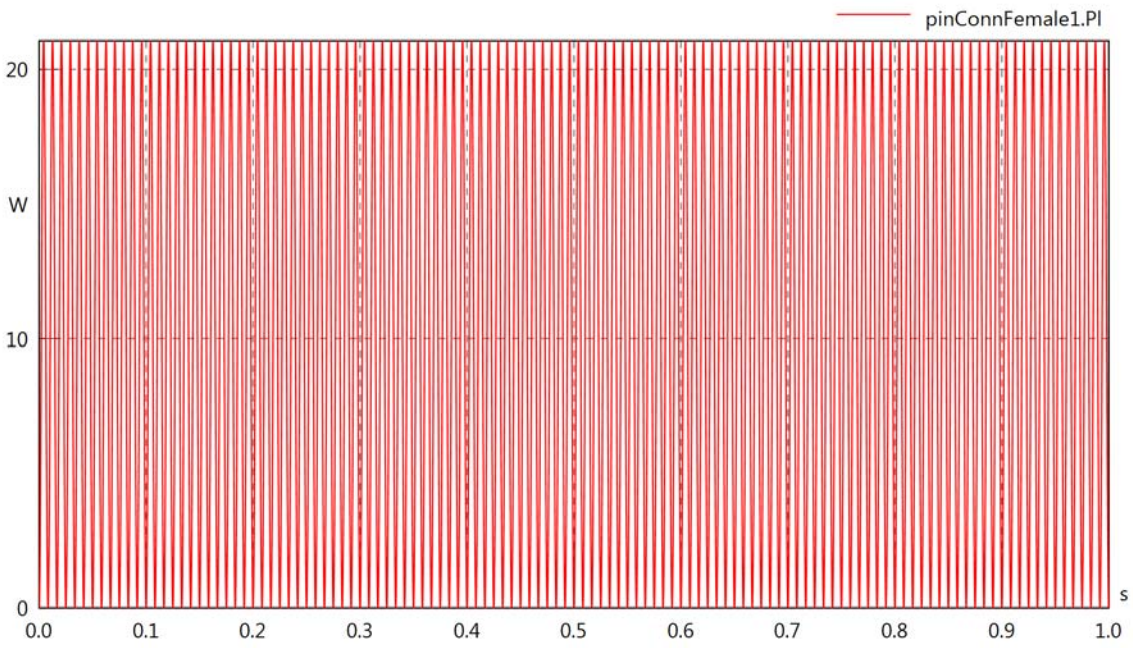
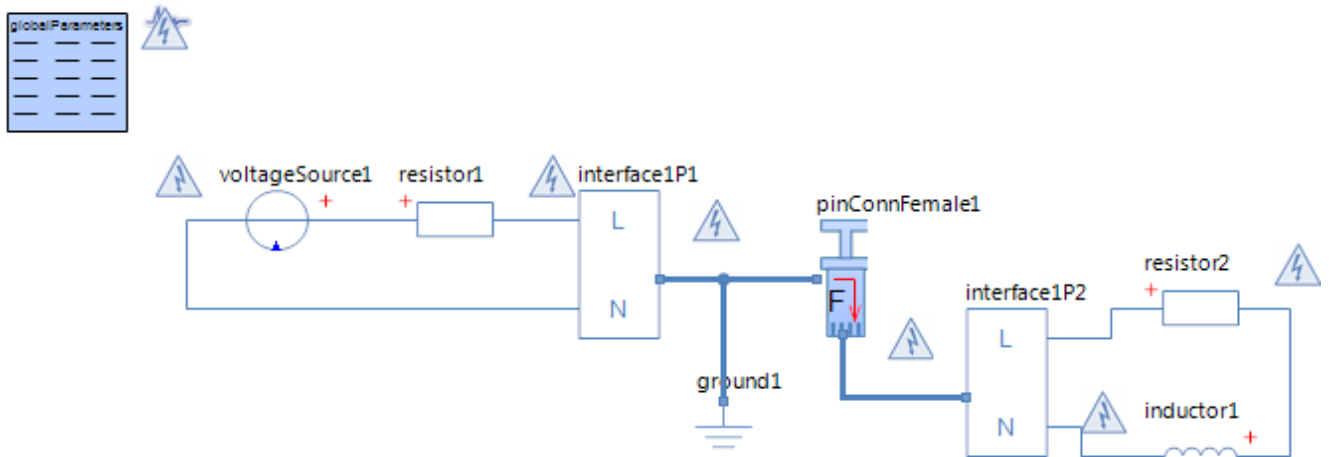

Diagram View



Voltage Source voltageSource1
Parameters

Comment	Name	Current Value	Unit
Voltage	v_src	$230 \cdot \sqrt{2} \cdot \sin(2 \cdot \pi \cdot 120 \cdot t)$	[V]

Resistor resistor1
Parameters

Comment	Name	Current Value	Unit
Resistance	R	10	[Ohm]

Resistor resistor2
Parameters

Comment	Name	Current Value	Unit
Resistance	R	100	[Ohm]

Inductor inductor1
Parameters

Comment	Name	Current Value	Unit
Inductance	L	100	[mH]
Initial Value	i0	0 (Fixed)	[A]
Kind	kind	absolute	

Pin Connector Female pinConnFemale1
Parameters

Comment	Name	Current Value	Unit
Poor or failing L1 connection	bL1	true	
Resistance in L1 connection	rL1	1	[kOhm]
Conductance between L1 and N	G	50	[1/Ohm]

pinConnFemale1.vIn

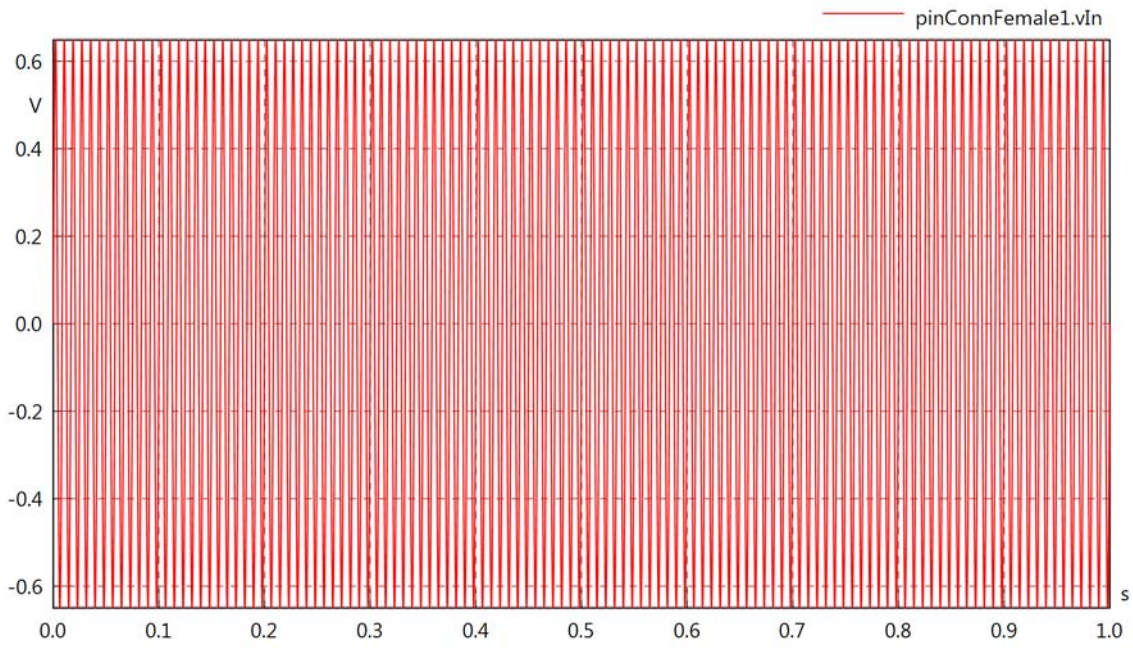

pinConnFemale1.vOut

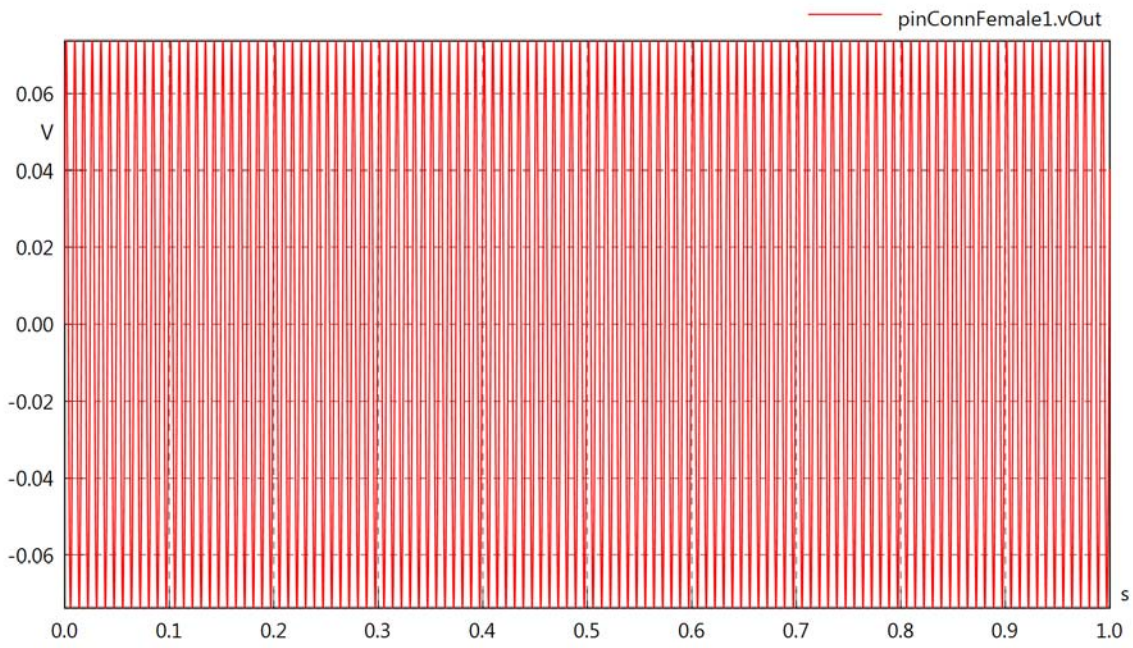

pinConnFemale1.v

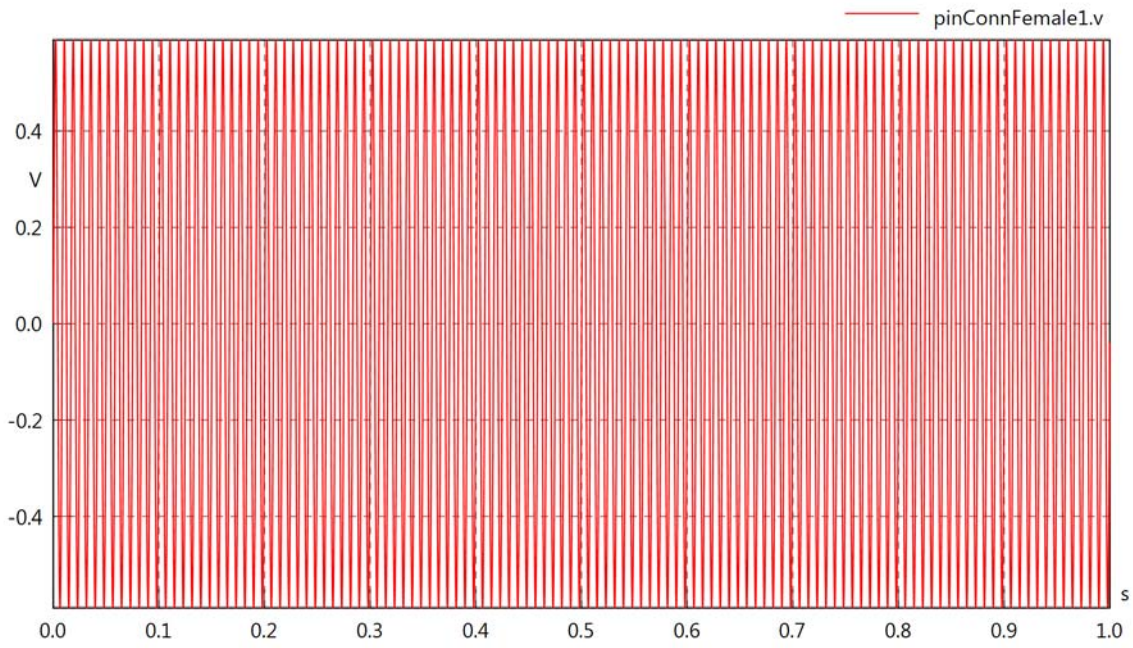

pinConnFemale1.iIn

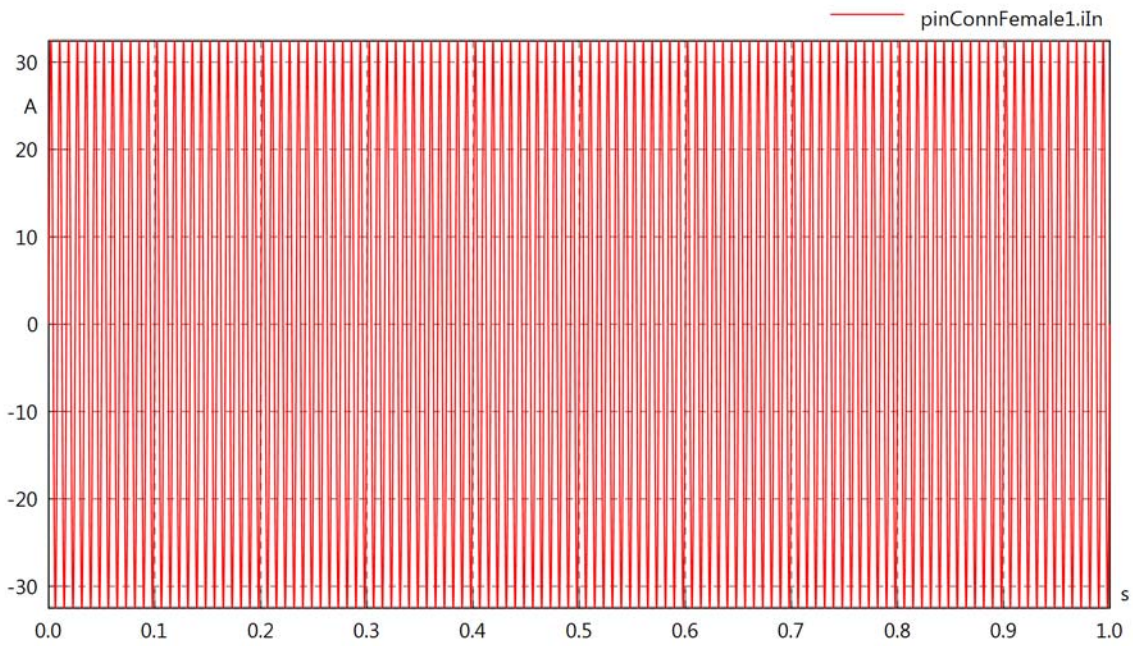

pinConnFemale1.iOut

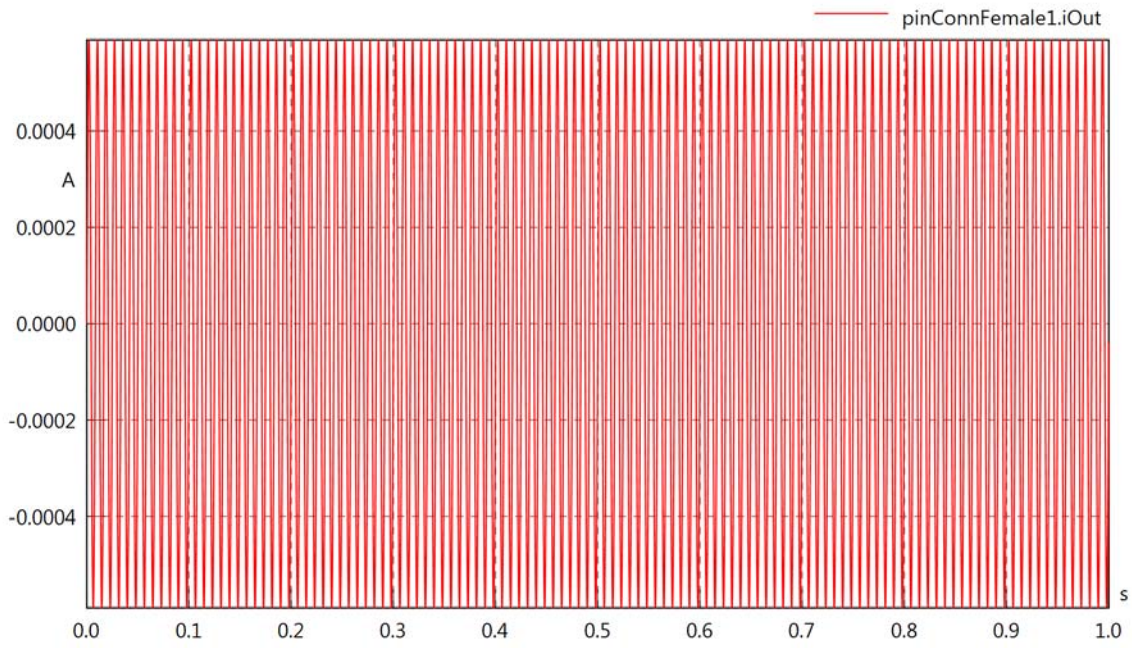

pinConnFemale1.PI

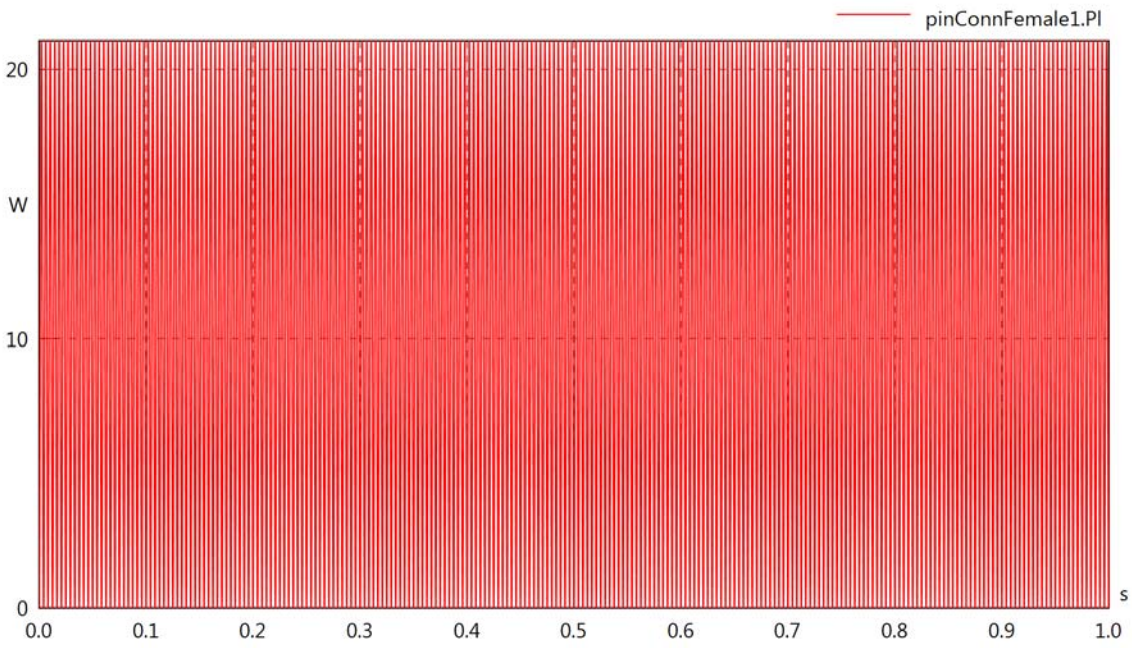
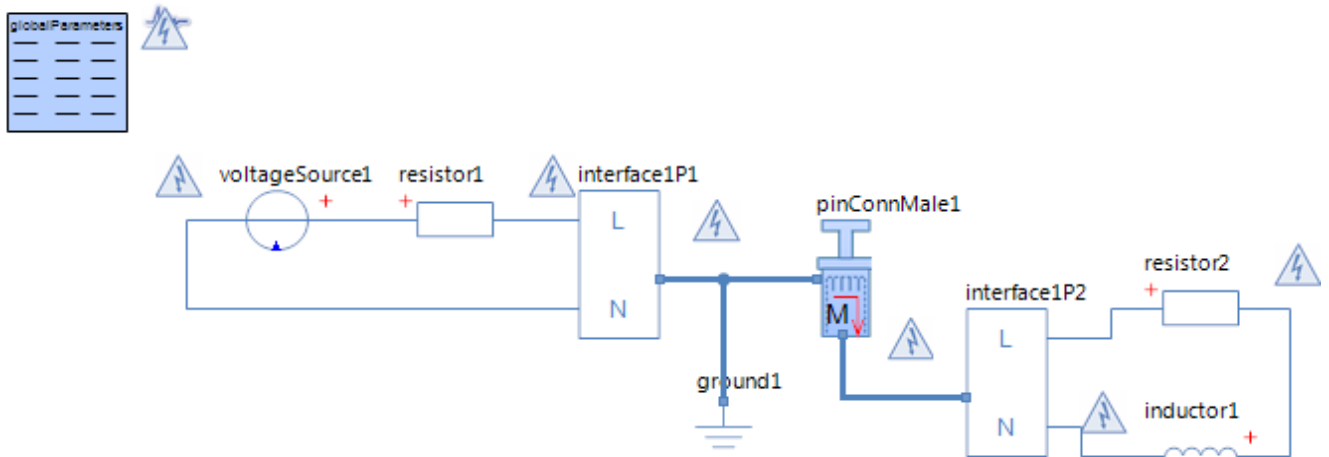

Diagram View



Voltage Source voltageSource1
Parameters

Comment	Name	Current Value	Unit
Voltage	v_src	$230 \cdot \sqrt{2} \cdot \sin(2 \cdot \pi \cdot 30 \cdot t)$	[V]

Resistor resistor1
Parameters

Comment	Name	Current Value	Unit
Resistance	R	10	[Ohm]

Resistor resistor2
Parameters

Comment	Name	Current Value	Unit
Resistance	R	100	[Ohm]

Inductor inductor1
Parameters

Comment	Name	Current Value	Unit
Inductance	L	100	[mH]
Initial Value	i0	0 (Fixed)	[A]
Kind	kind	absolute	

Pin Connector Male pinConnMale1
Parameters

Comment	Name	Current Value	Unit
Poor or failing L1 connection	bL1	false	

pinConnMale1.vIn

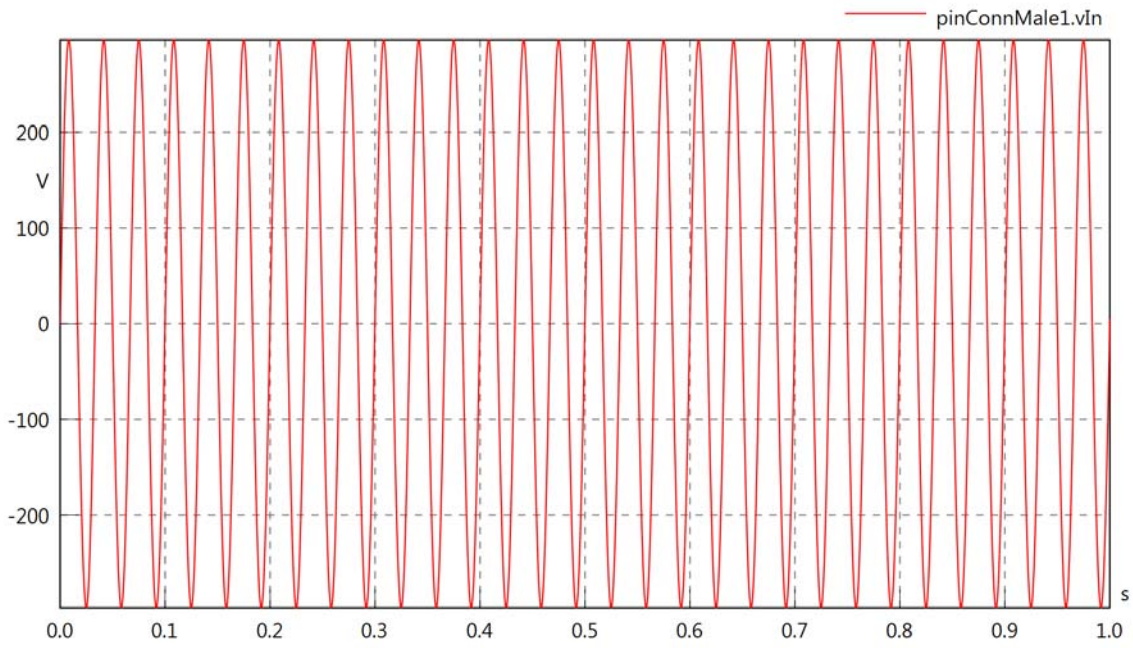

pinConnMale1.vOut

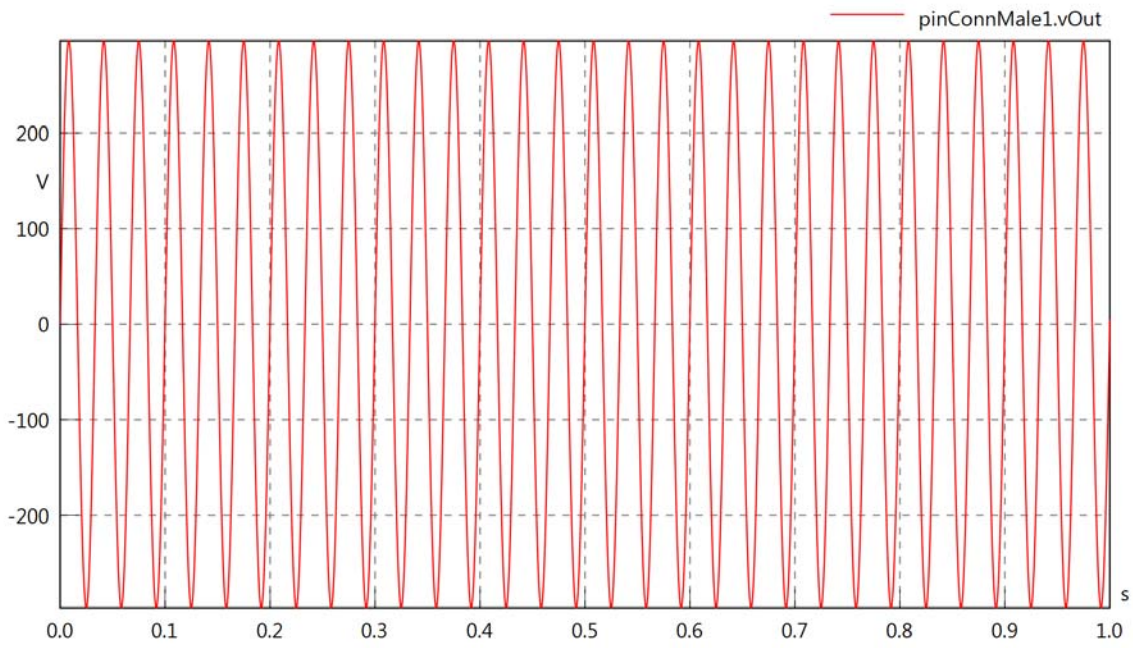

pinConnMale1.v

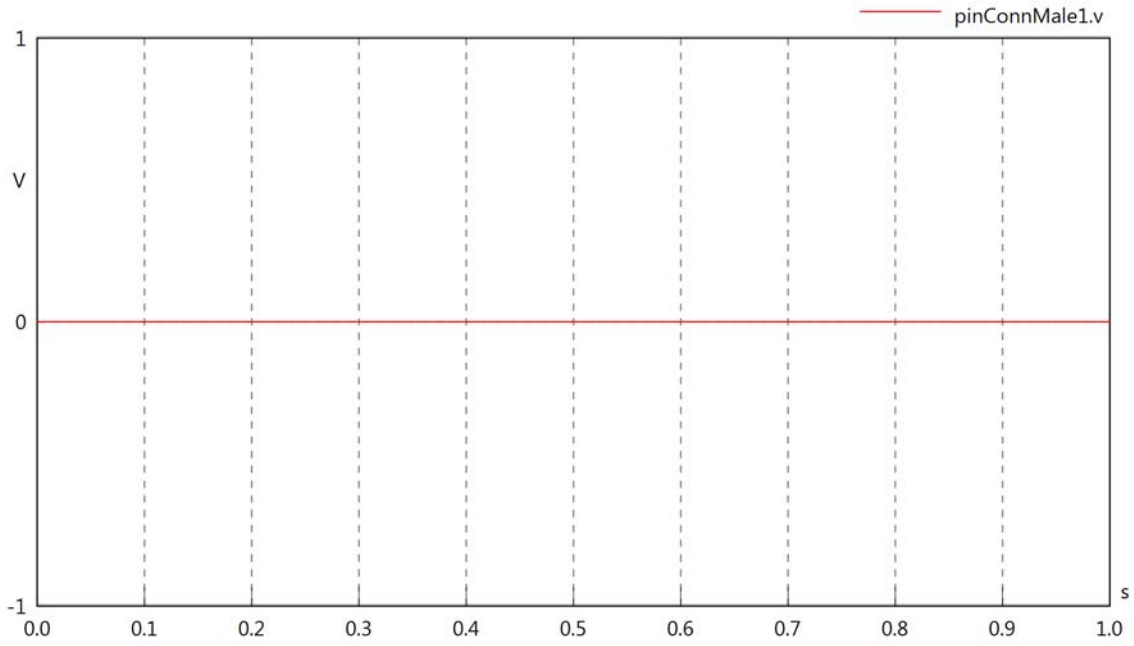

pinConnMale1.iIn

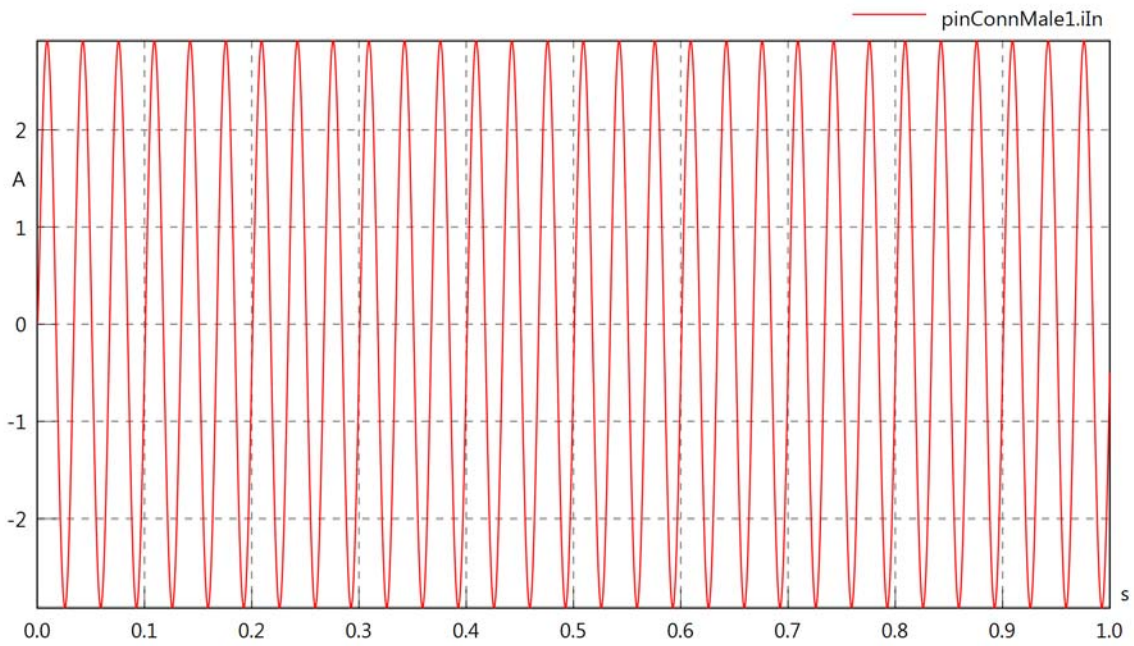

pinConnMale1.iOut

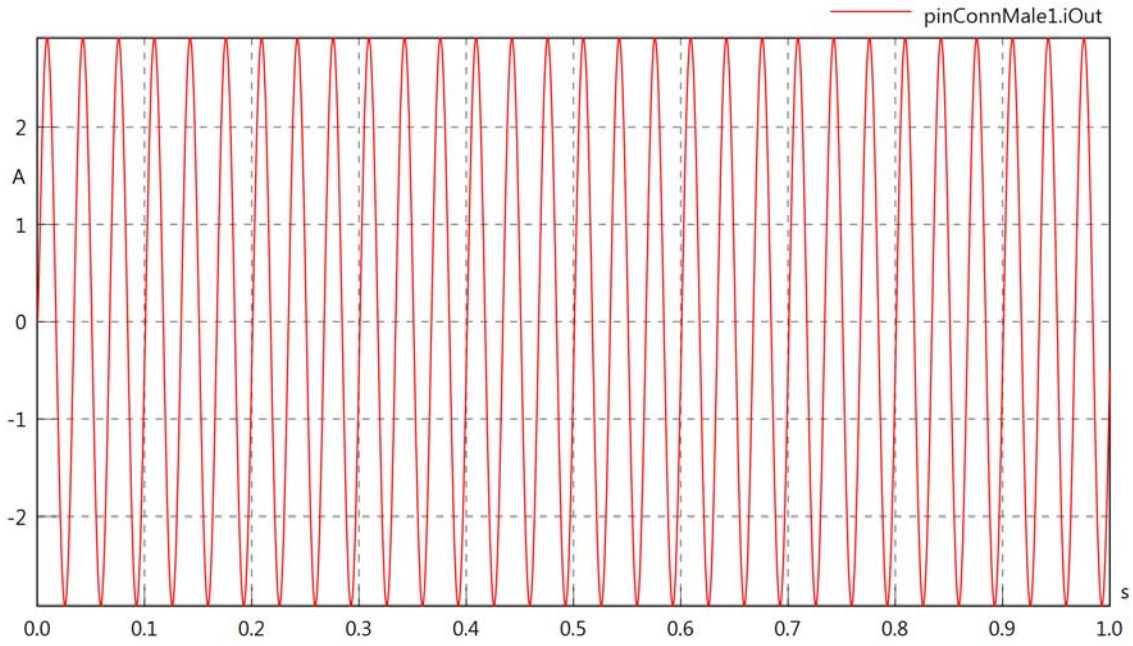

pinConnMale1.PI

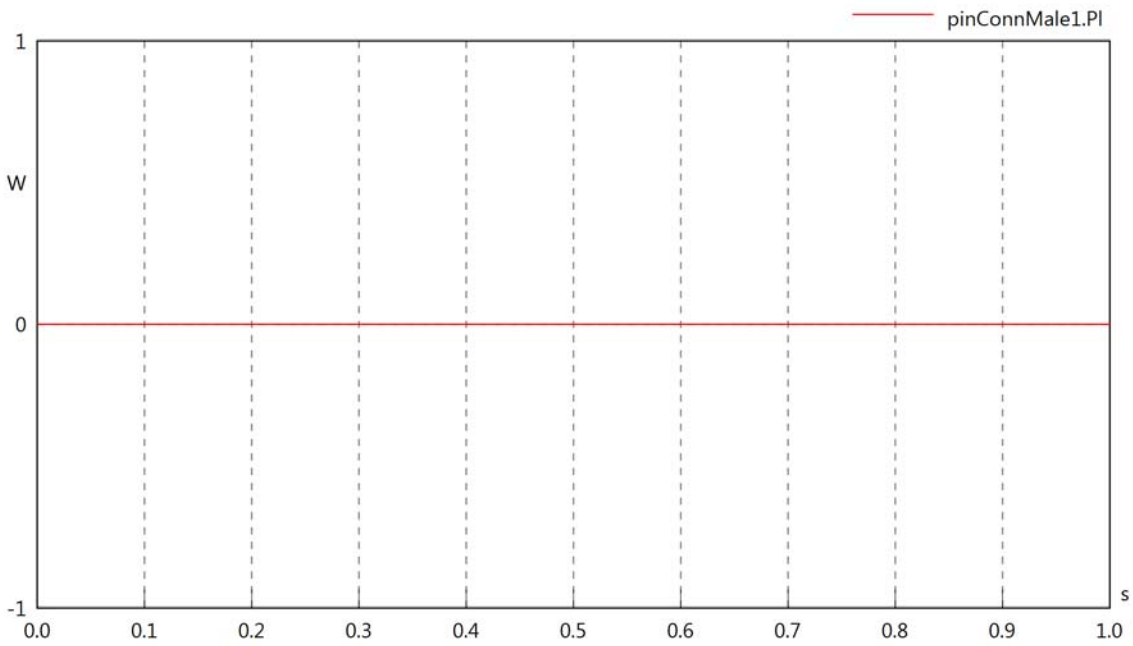
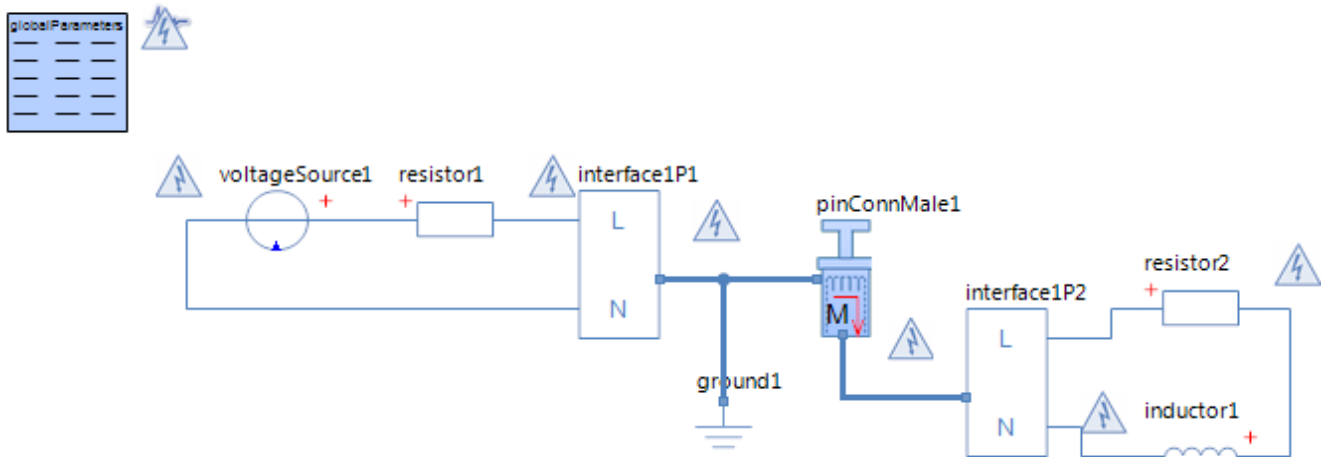

Diagram View



Voltage Source voltageSource1
Parameters

Comment	Name	Current Value	Unit
Voltage	v_src	$230 \cdot \sqrt{2} \cdot \sin(2 \cdot \pi \cdot 60 \cdot t)$	[V]

Resistor resistor1
Parameters

Comment	Name	Current Value	Unit
Resistance	R	10	[Ohm]

Resistor resistor2
Parameters

Comment	Name	Current Value	Unit
Resistance	R	100	[Ohm]

Inductor inductor1
Parameters

Comment	Name	Current Value	Unit
Inductance	L	100	[mH]
Initial Value	i0	0 (Fixed)	[A]
Kind	kind	absolute	

Pin Connector Male pinConnMale1
Parameters

Comment	Name	Current Value	Unit
Poor or failing L1 connection	bL1	false	

pinConnMale1.vIn

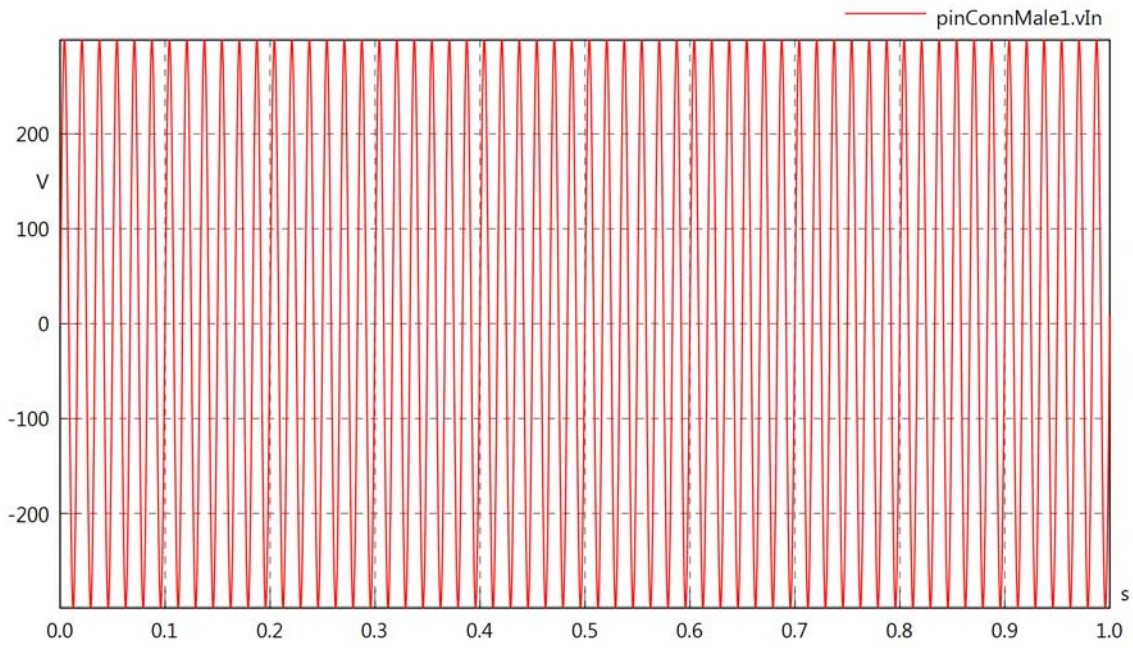

pinConnMale1.vOut

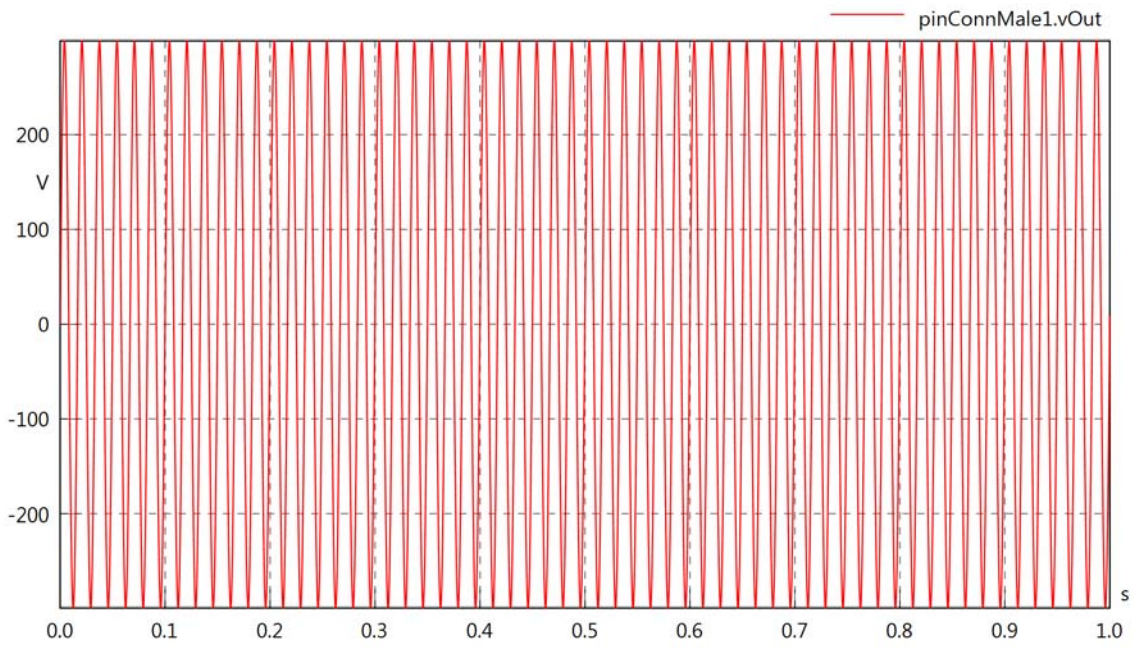

pinConnMale1.v

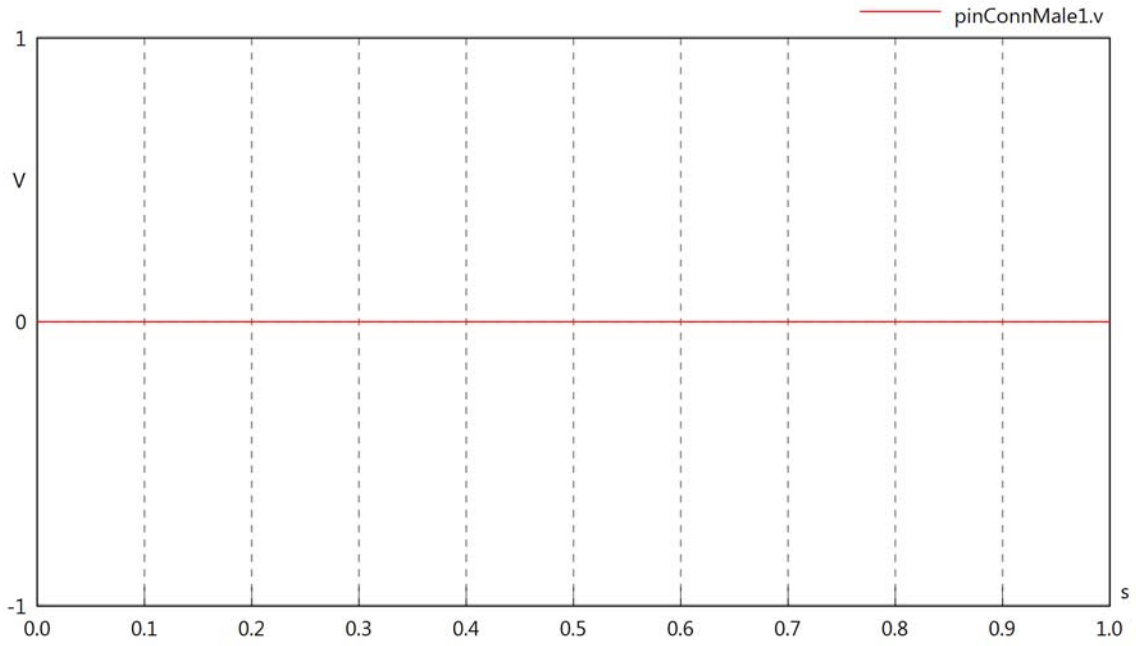

pinConnMale1.iIn

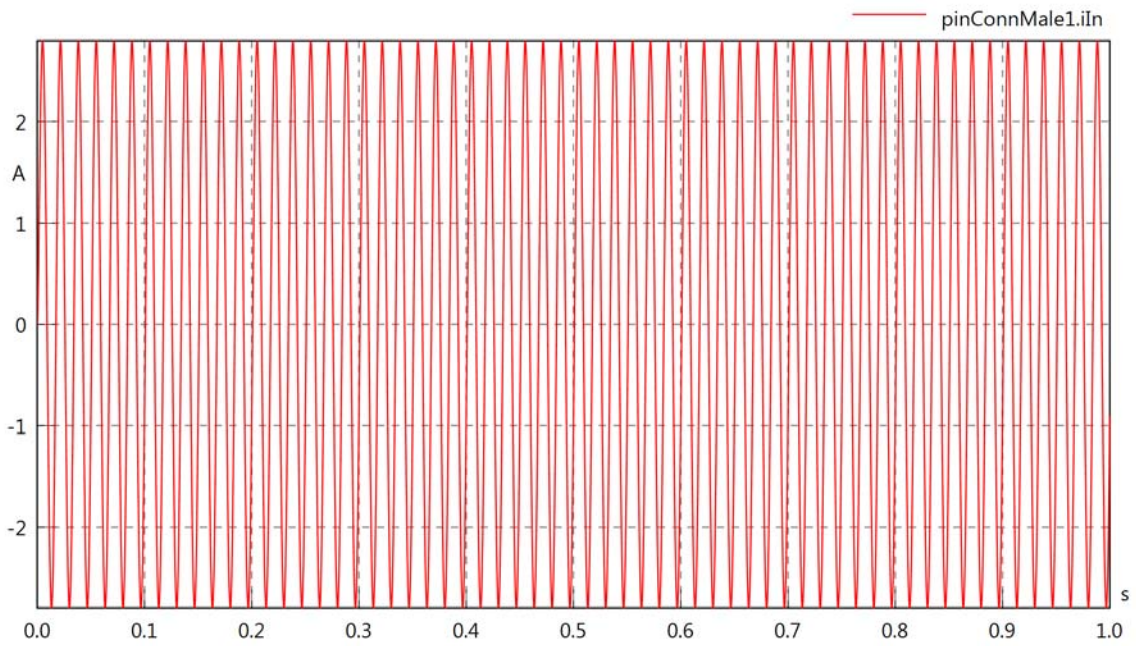

pinConnMale1.iOut

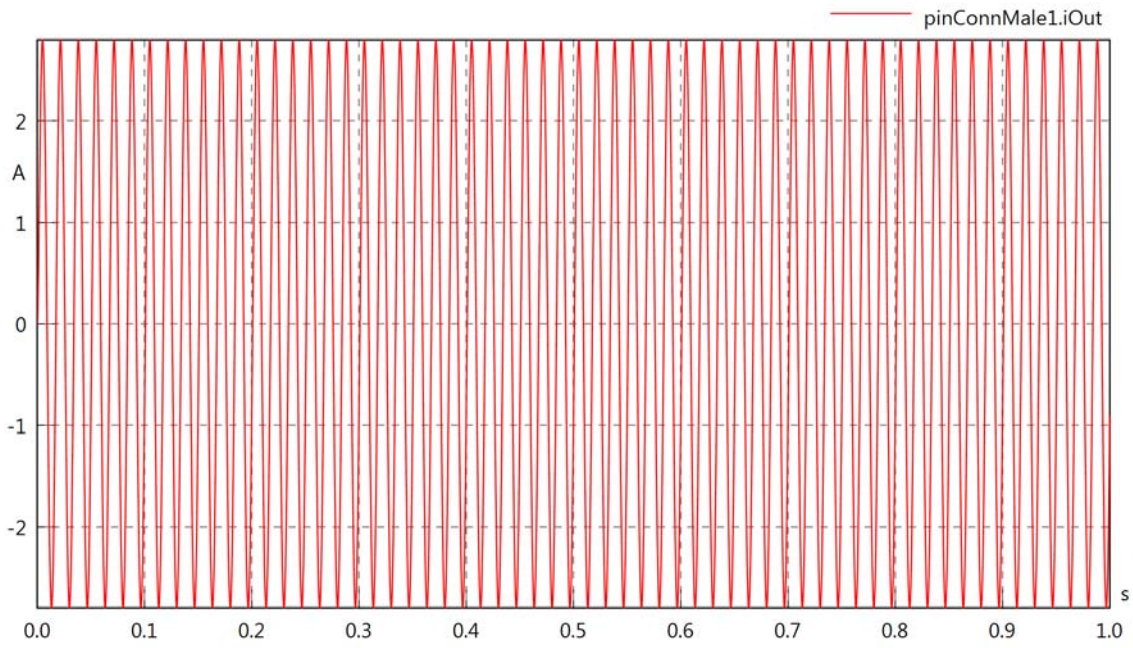

pinConnMale1.PI

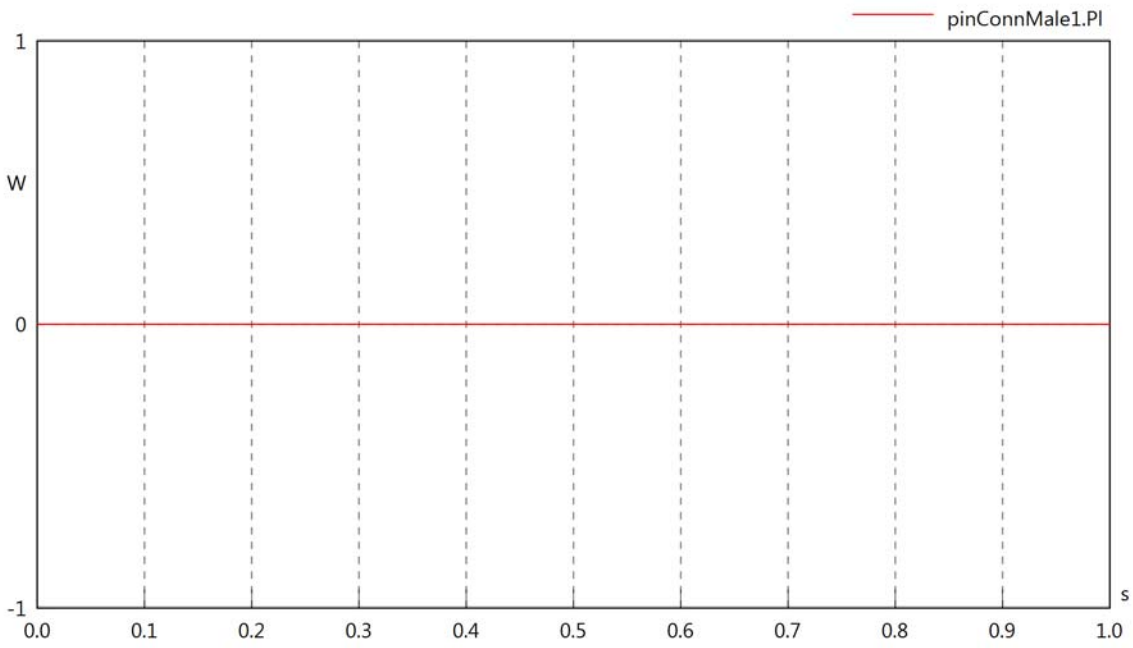
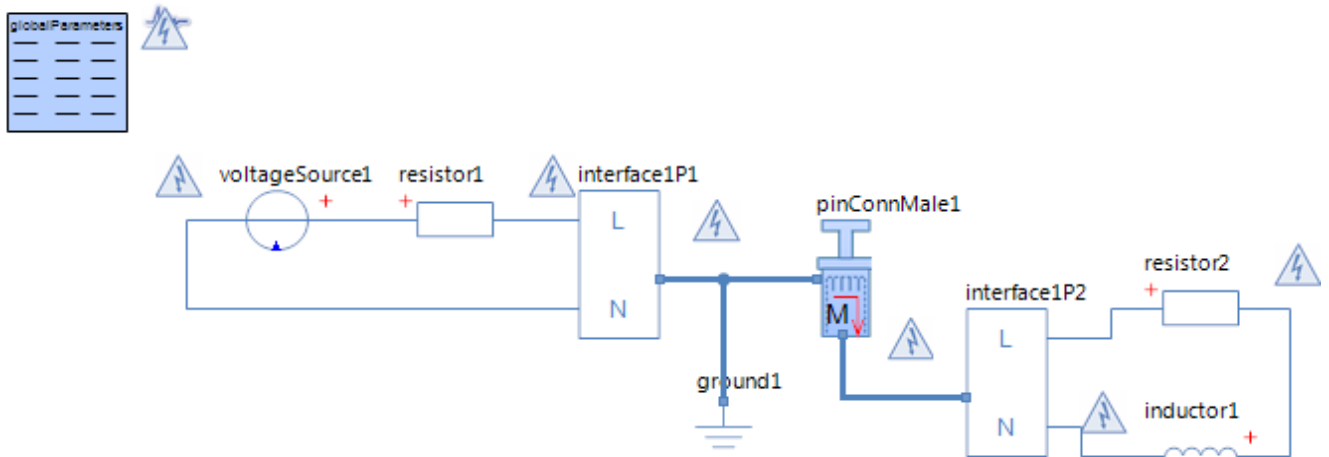

Diagram View



Voltage Source voltageSource1
Parameters

Comment	Name	Current Value	Unit
Voltage	v_src	$230 \cdot \sqrt{2} \cdot \sin(2 \cdot \pi \cdot 120 \cdot t)$	[V]

Resistor resistor1
Parameters

Comment	Name	Current Value	Unit
Resistance	R	10	[Ohm]

Resistor resistor2
Parameters

Comment	Name	Current Value	Unit
Resistance	R	100	[Ohm]

Inductor inductor1
Parameters

Comment	Name	Current Value	Unit
Inductance	L	100	[mH]
Initial Value	i0	0 (Fixed)	[A]
Kind	kind	absolute	

Pin Connector Male pinConnMale1
Parameters

Comment	Name	Current Value	Unit
Poor or failing L1 connection	bL1	false	

pinConnMale1.vIn

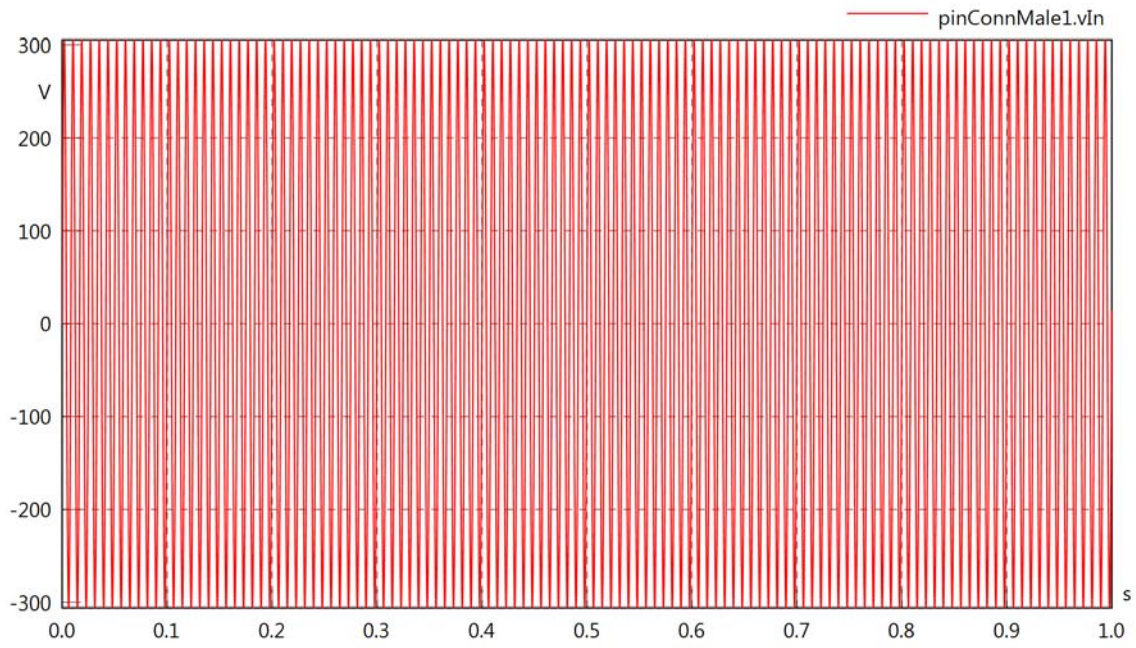

pinConnMale1.vOut

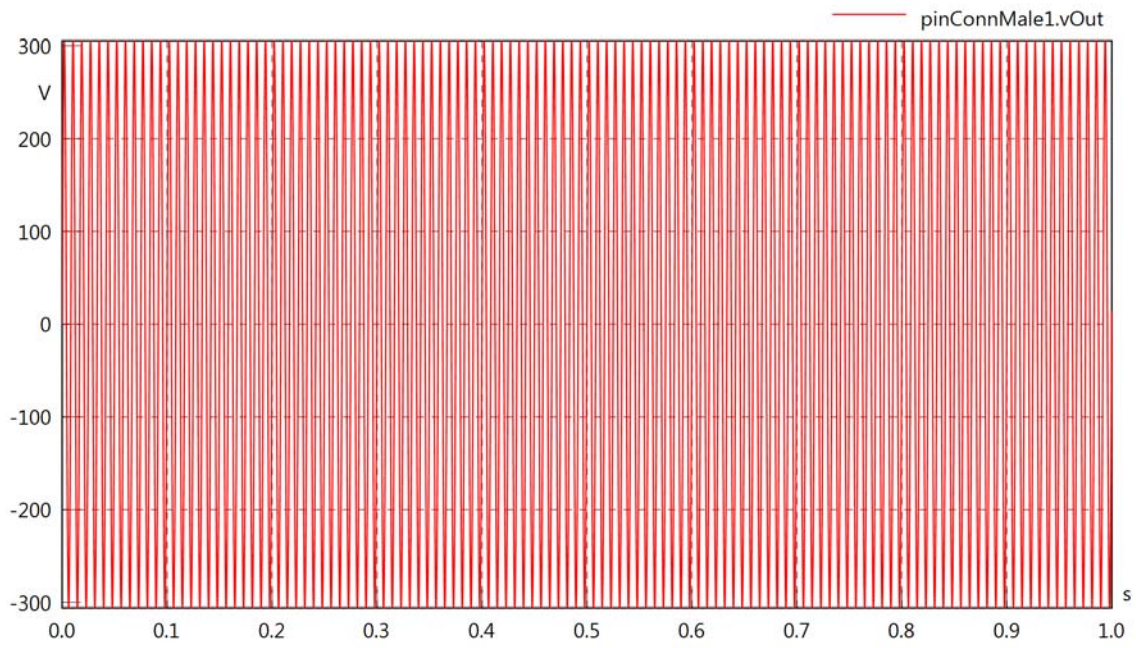

pinConnMale1.v

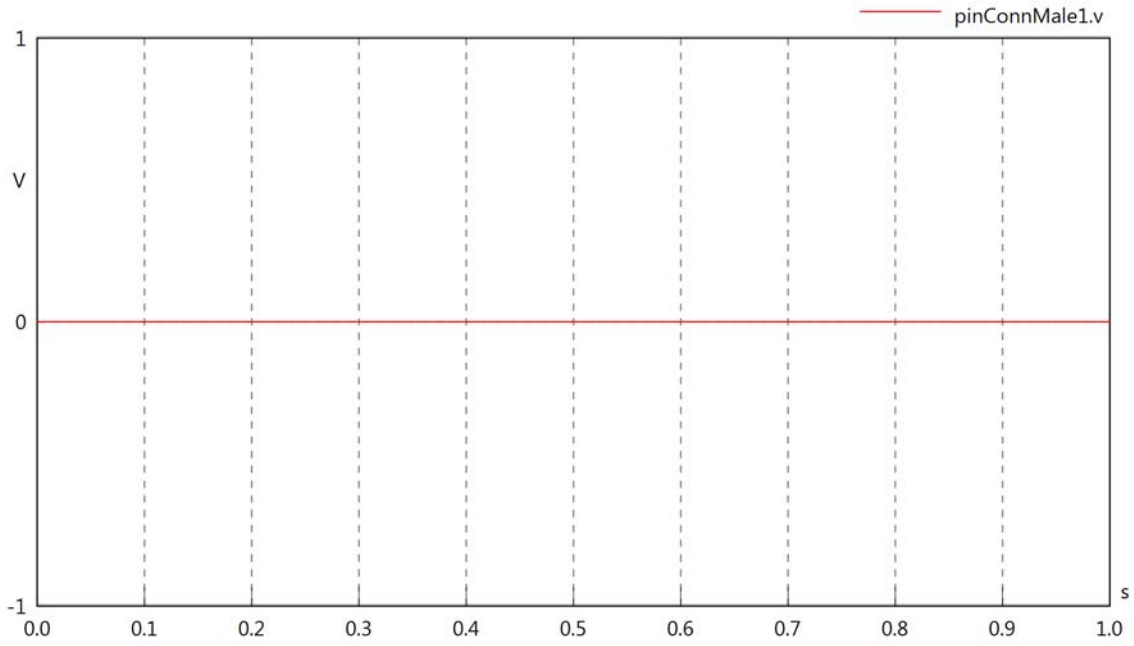

pinConnMale1.iIn

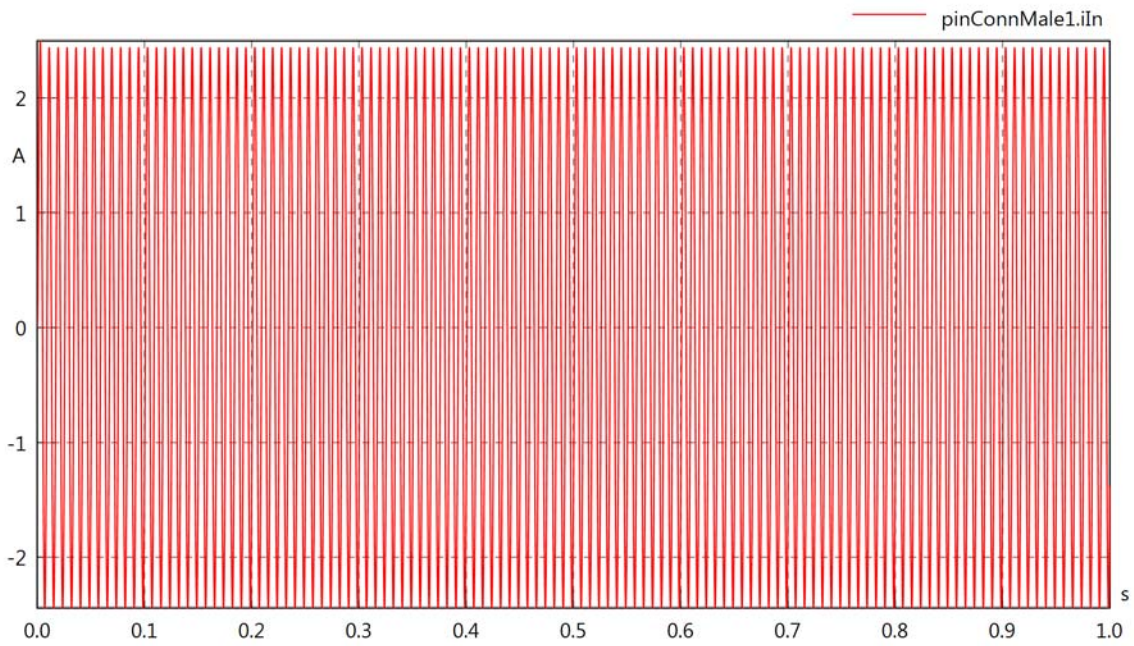

pinConnMale1.iOut

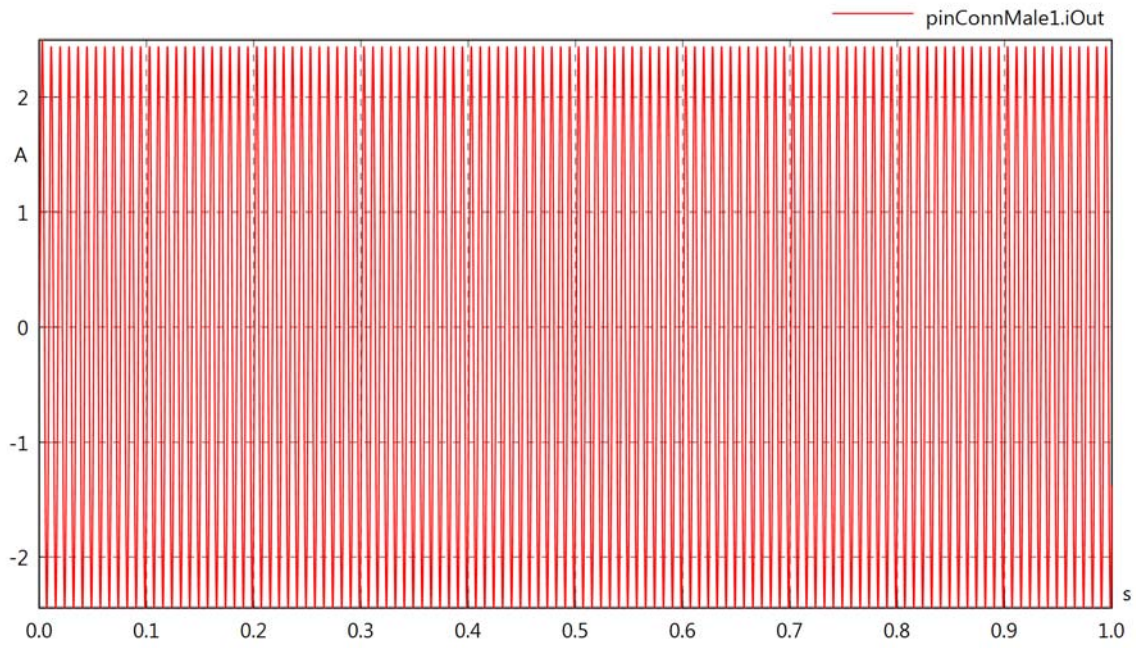

pinConnMale1.PI

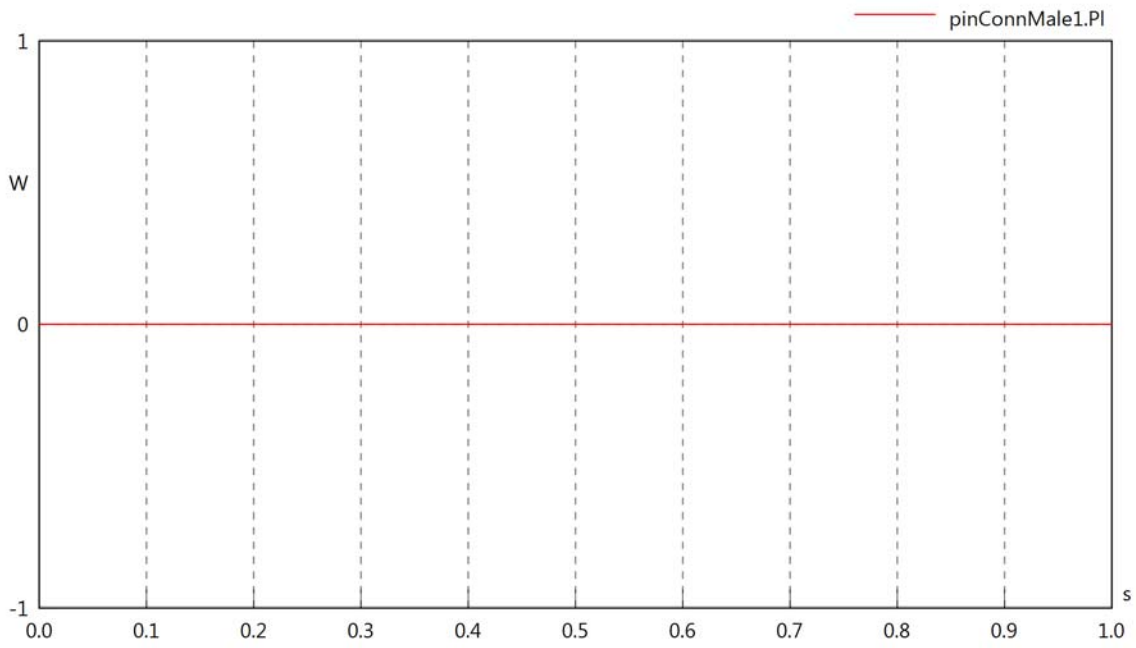
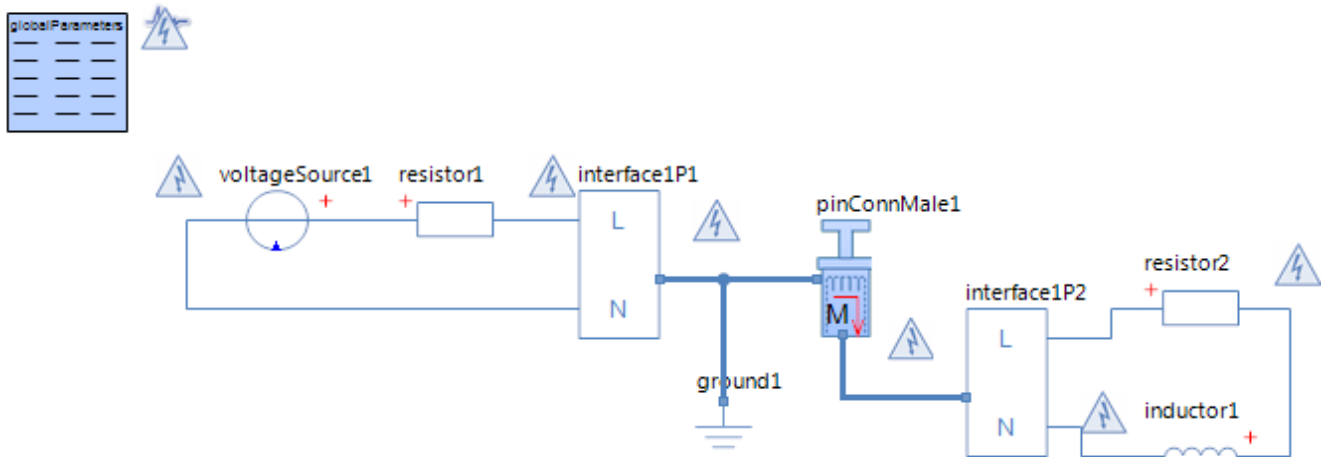

Diagram View



Voltage Source voltageSource1
Parameters

Comment	Name	Current Value	Unit
Voltage	v_src	$230 \cdot \sqrt{2} \cdot \sin(2 \cdot \pi \cdot 30 \cdot t)$	[V]

Resistor resistor1
Parameters

Comment	Name	Current Value	Unit
Resistance	R	10	[Ohm]

Resistor resistor2
Parameters

Comment	Name	Current Value	Unit
Resistance	R	100	[Ohm]

Inductor inductor1
Parameters

Comment	Name	Current Value	Unit
Inductance	L	100	[mH]
Initial Value	i0	0 (Fixed)	[A]
Kind	kind	absolute	

Pin Connector Male pinConnMale1
Parameters

Comment	Name	Current Value	Unit
Poor or failing L1 connection	bL1	true	
Resistance in L1 connection	rL1	1	[kOhm]
Conductance between L1 and N	G	50	[1/Ohm]

pinConnMale1.vIn

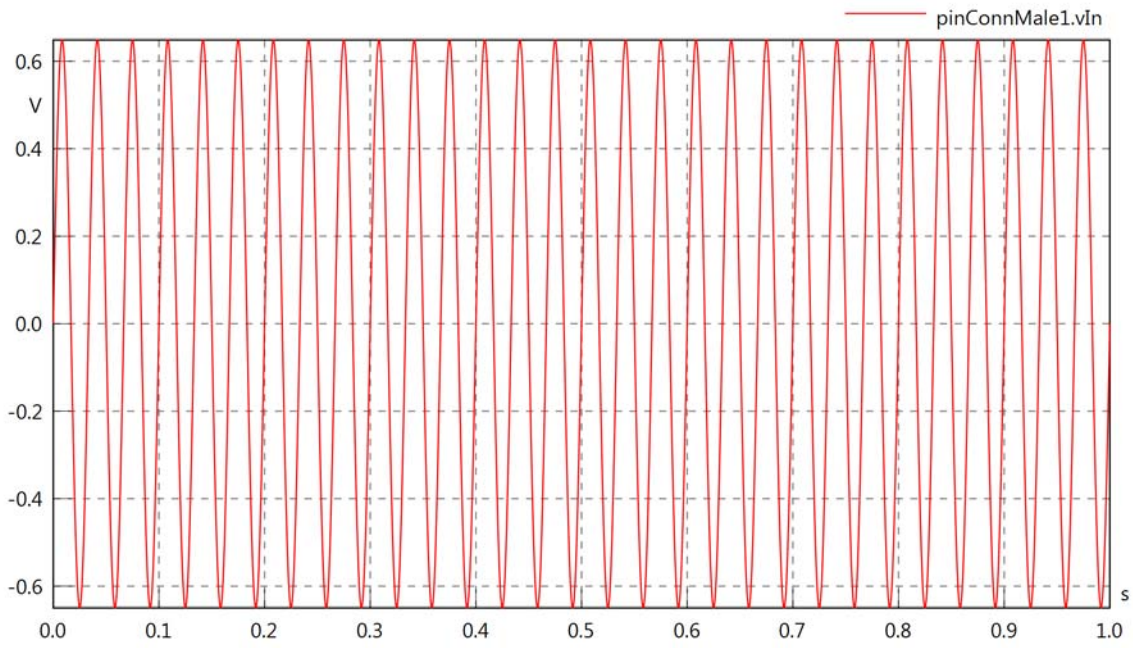

pinConnMale1.vOut

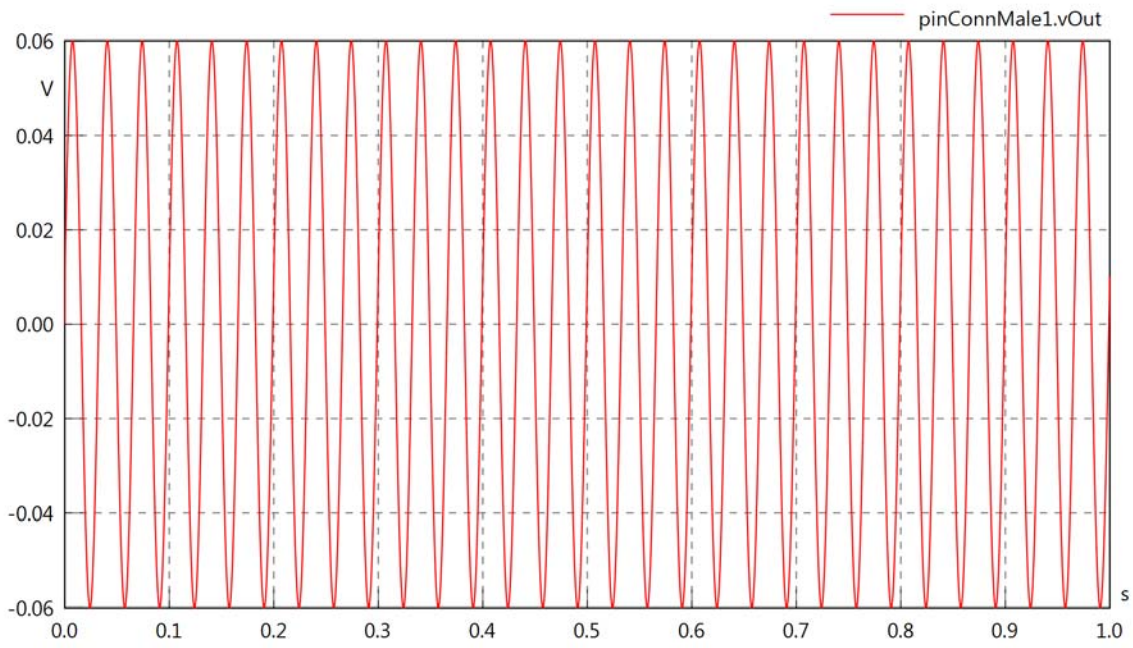

pinConnMale1.v

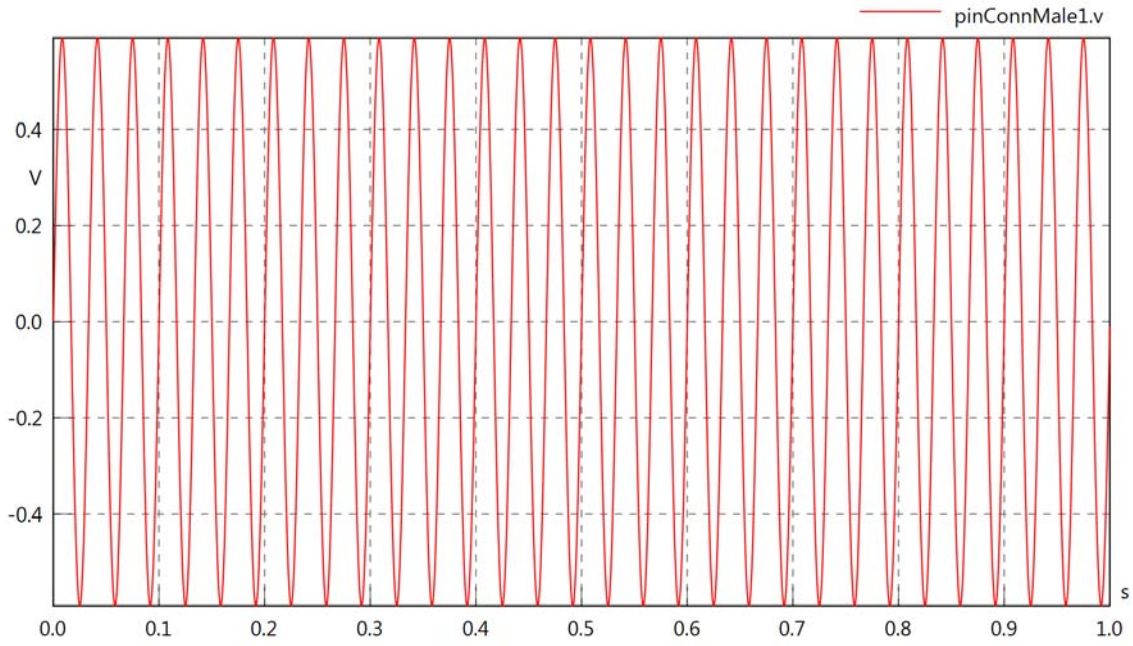

pinConnMale1.iIn

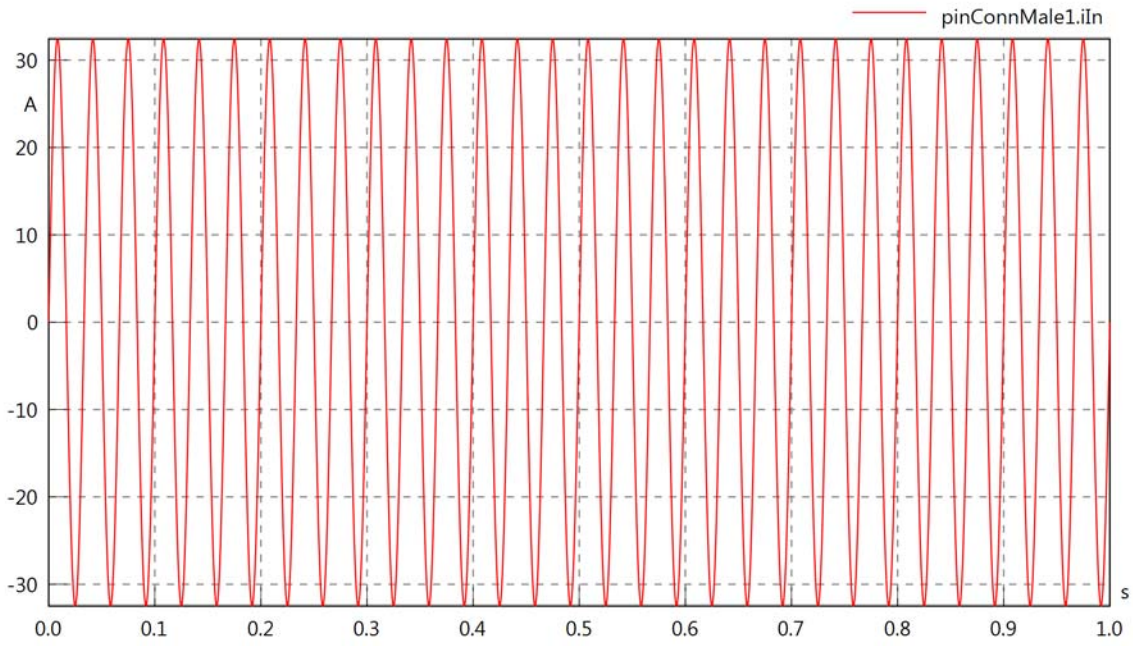

pinConnMale1.iOut

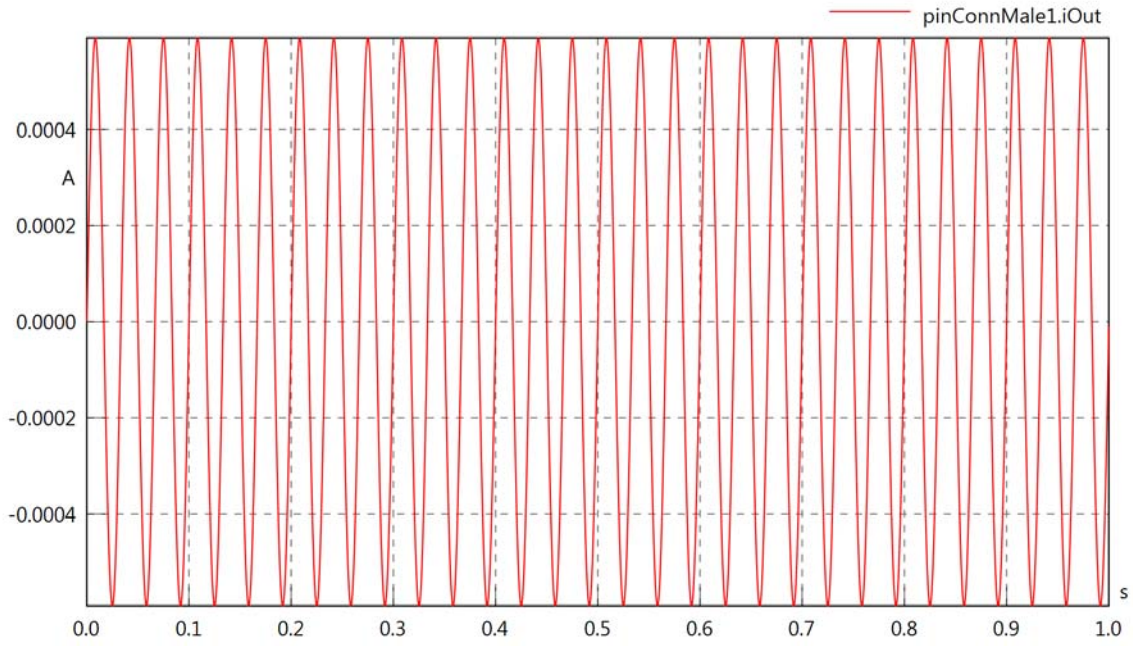

pinConnMale1.PI

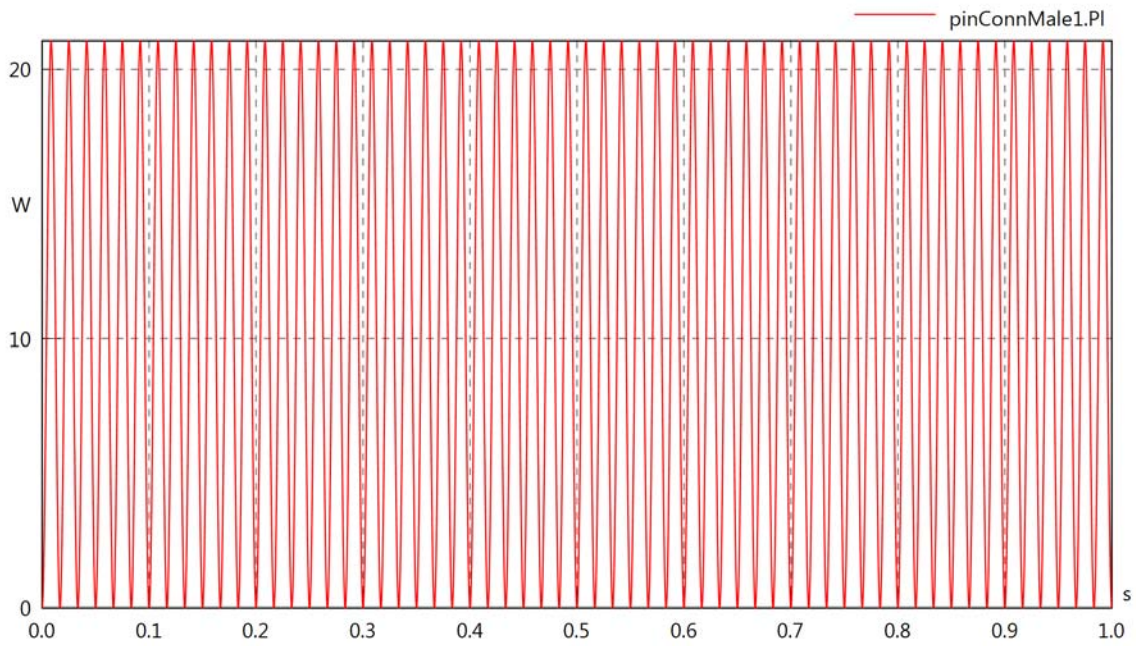
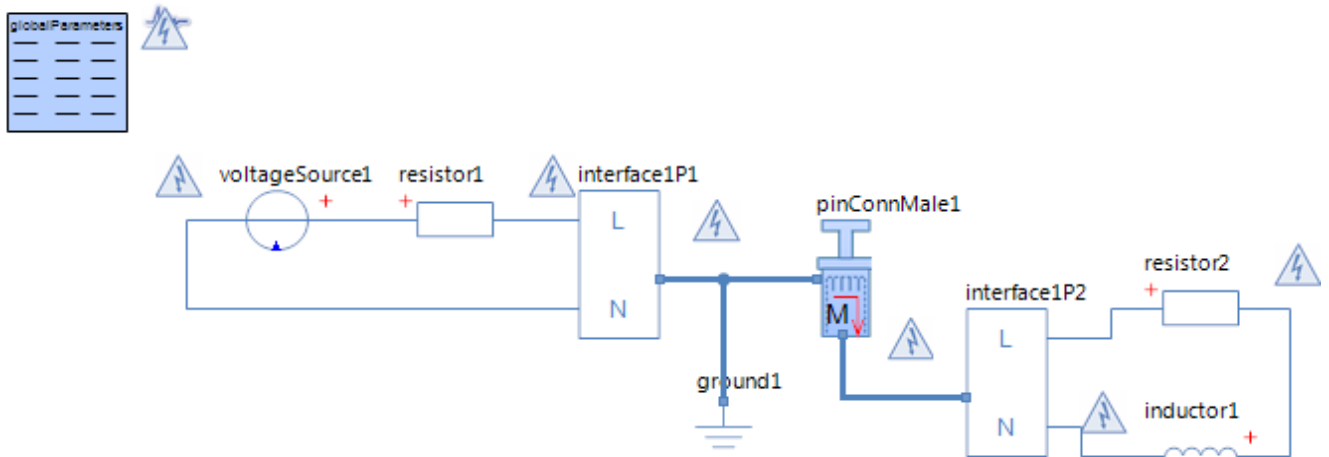

Diagram View



Voltage Source voltageSource1
Parameters

Comment	Name	Current Value	Unit
Voltage	v_src	$230 \cdot \sqrt{2} \cdot \sin(2 \cdot \pi \cdot 60 \cdot t)$	[V]

Resistor resistor1
Parameters

Comment	Name	Current Value	Unit
Resistance	R	10	[Ohm]

Resistor resistor2
Parameters

Comment	Name	Current Value	Unit
Resistance	R	100	[Ohm]

Inductor inductor1
Parameters

Comment	Name	Current Value	Unit
Inductance	L	100	[mH]
Initial Value	i0	0 (Fixed)	[A]
Kind	kind	absolute	

Pin Connector Male pinConnMale1
Parameters

Comment	Name	Current Value	Unit
Poor or failing L1 connection	bL1	true	
Resistance in L1 connection	rL1	1	[kOhm]
Conductance between L1 and N	G	50	[1/Ohm]

pinConnMale1.vIn

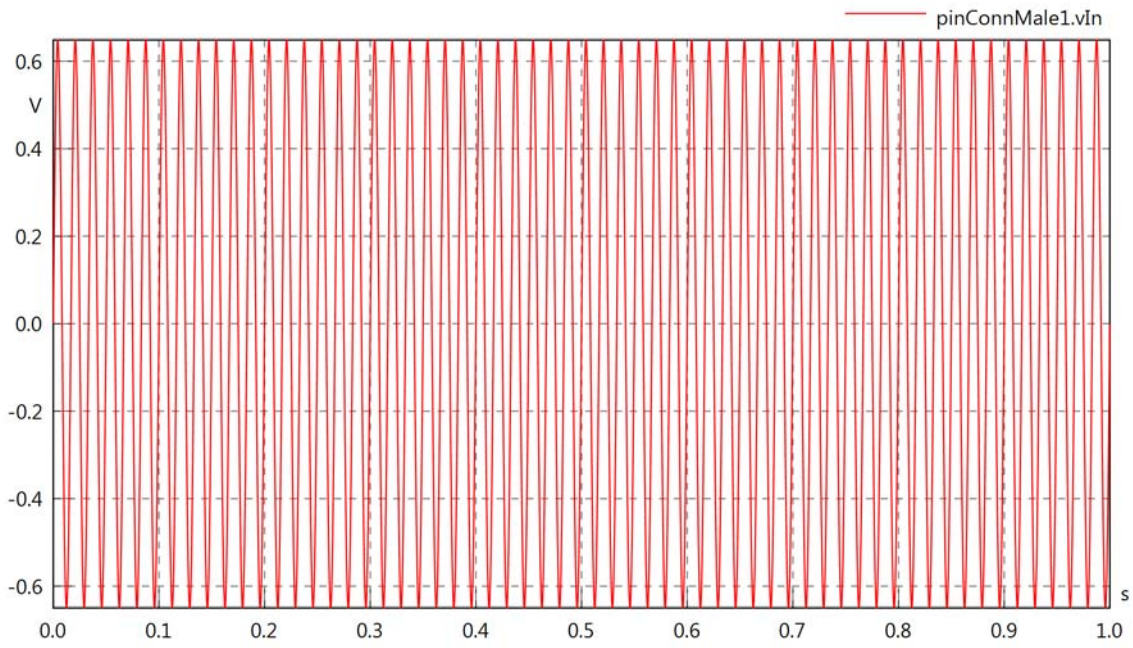

pinConnMale1.vOut

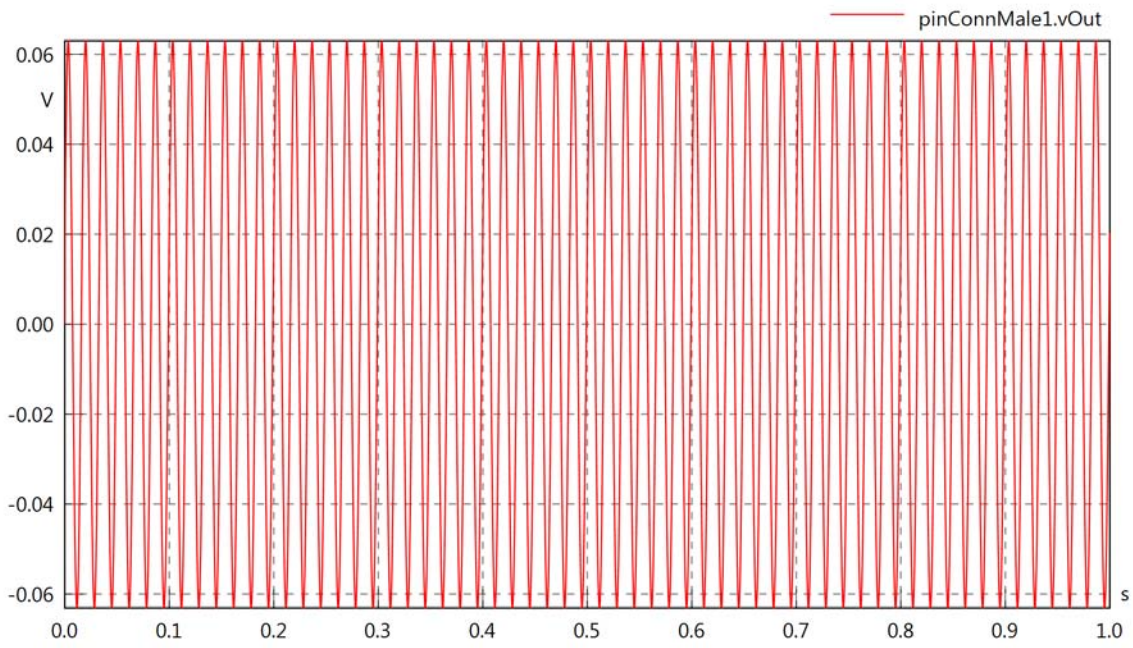

pinConnMale1.v

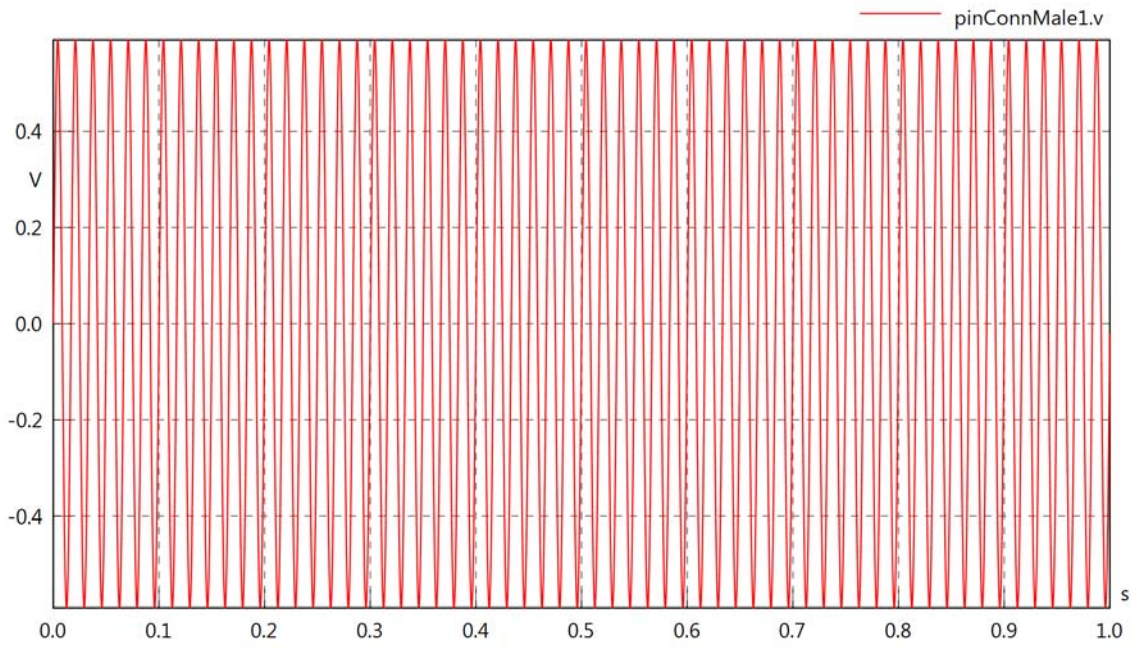

pinConnMale1.iIn

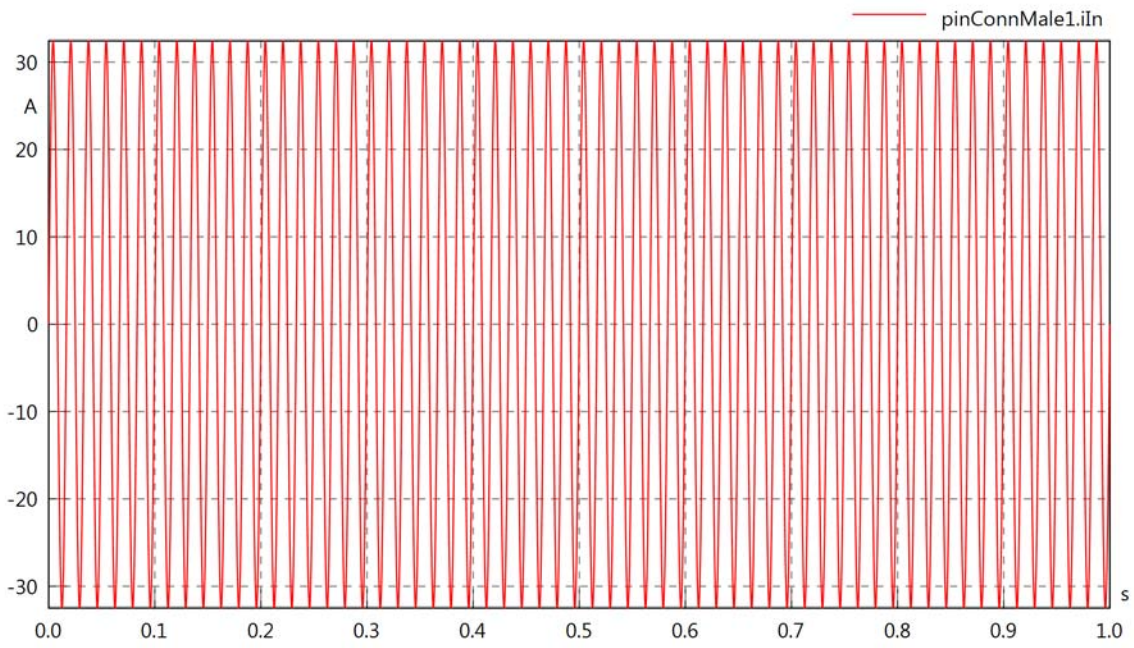

pinConnMale1.iOut

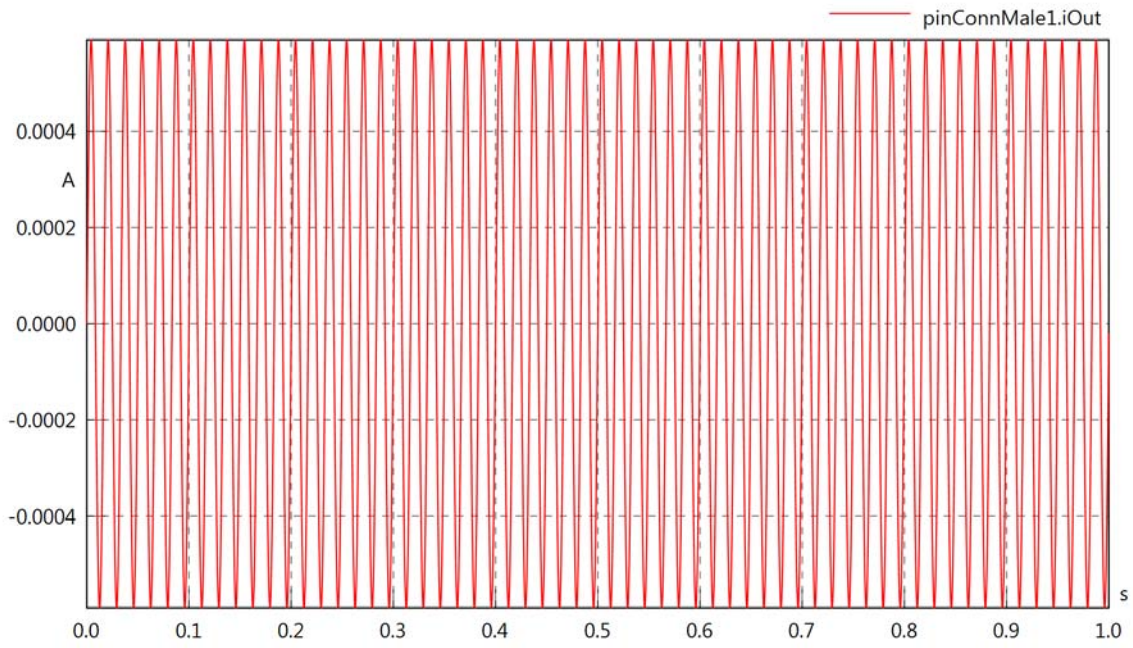

pinConnMale1.PI

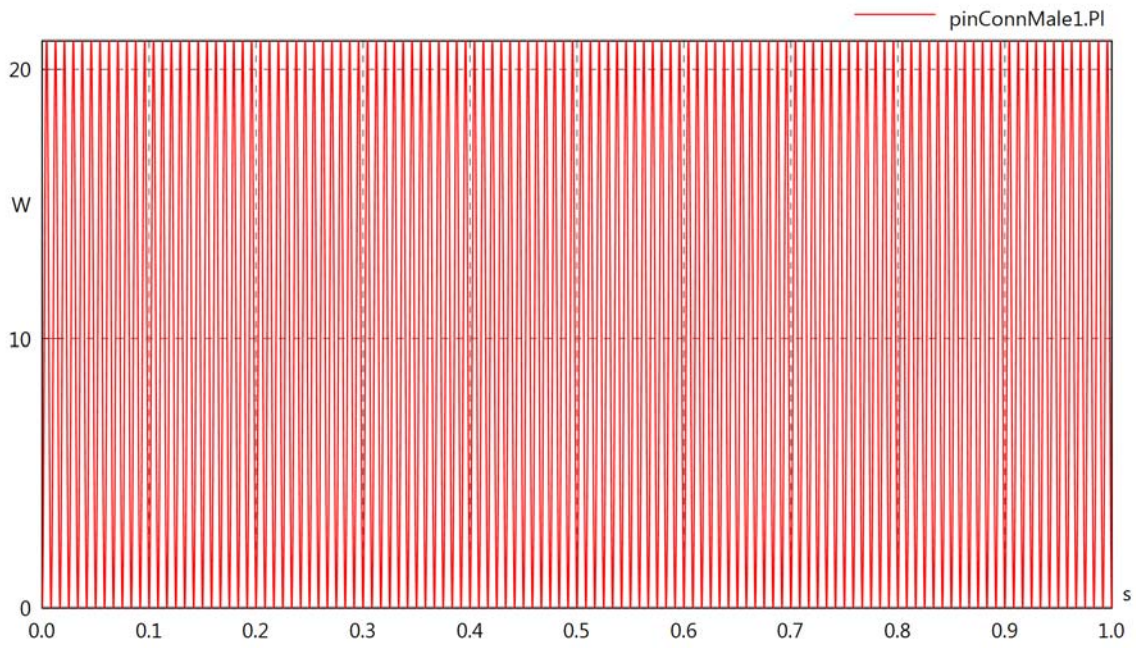
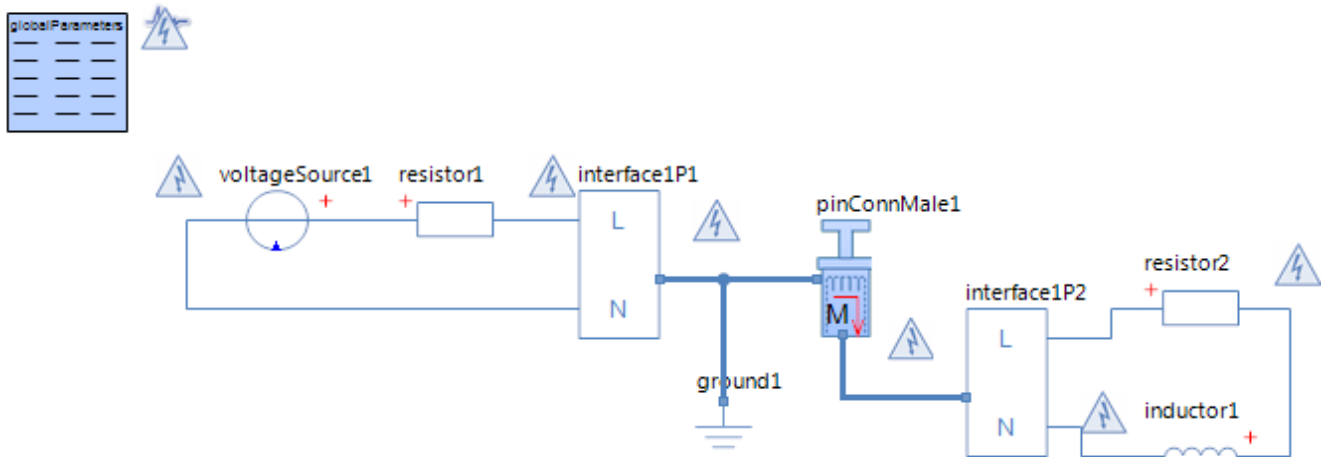

Diagram View



Voltage Source voltageSource1
Parameters

Comment	Name	Current Value	Unit
Voltage	v_src	$230 \cdot \sqrt{2} \cdot \sin(2 \cdot \pi \cdot 120 \cdot t)$	[V]

Resistor resistor1
Parameters

Comment	Name	Current Value	Unit
Resistance	R	10	[Ohm]

Resistor resistor2
Parameters

Comment	Name	Current Value	Unit
Resistance	R	100	[Ohm]

Inductor inductor1
Parameters

Comment	Name	Current Value	Unit
Inductance	L	100	[mH]
Initial Value	i0	0 (Fixed)	[A]
Kind	kind	absolute	

Pin Connector Male pinConnMale1
Parameters

Comment	Name	Current Value	Unit
Poor or failing L1 connection	bL1	true	
Resistance in L1 connection	rL1	1	[kOhm]
Conductance between L1 and N	G	50	[1/Ohm]

pinConnMale1.vIn

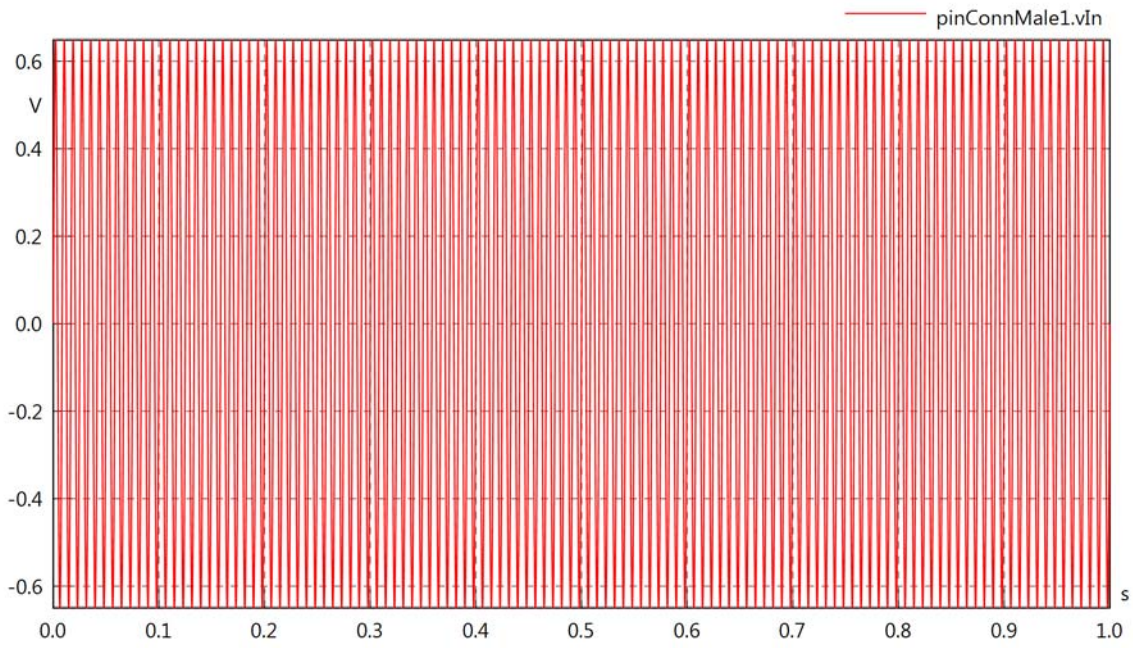

pinConnMale1.vOut

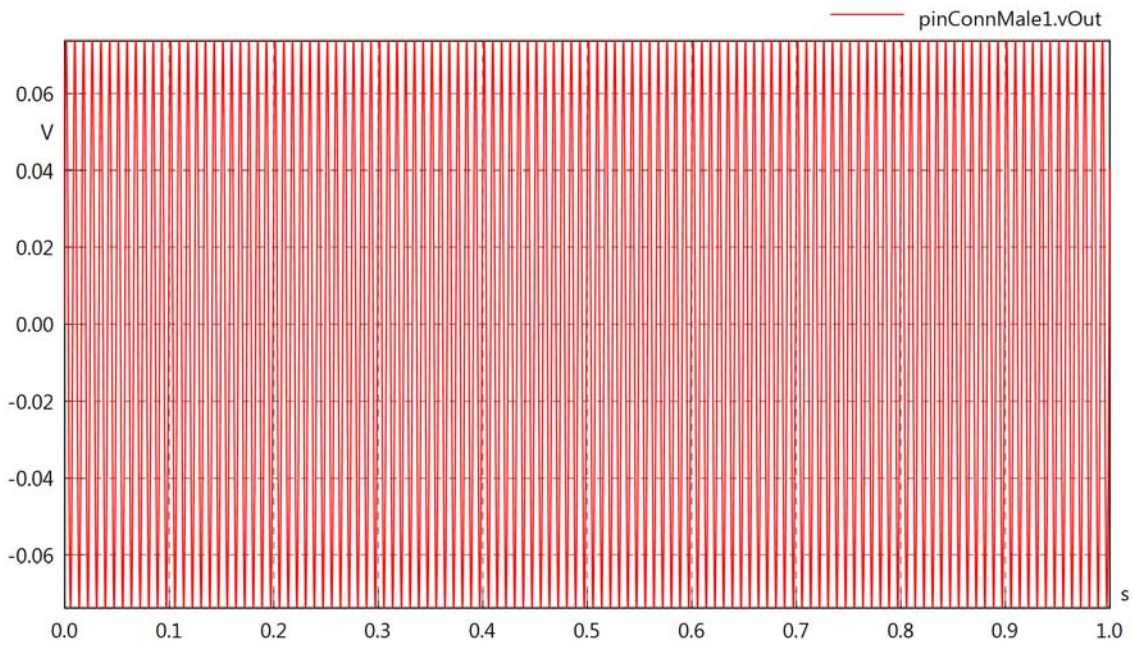

pinConnMale1.v

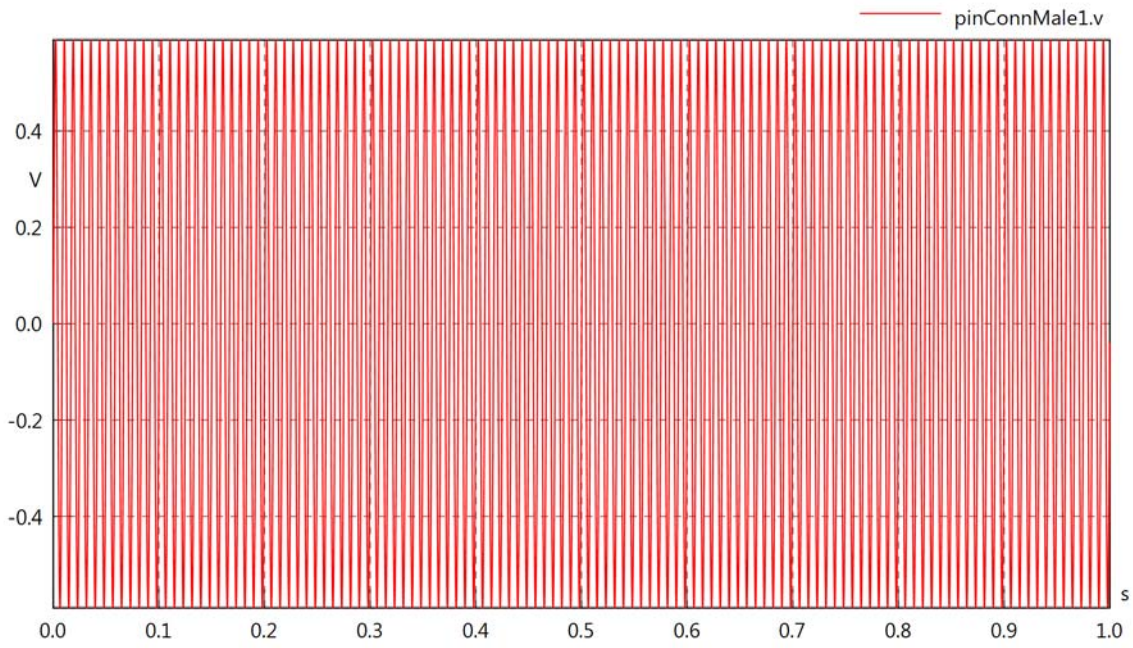

pinConnMale1.iIn

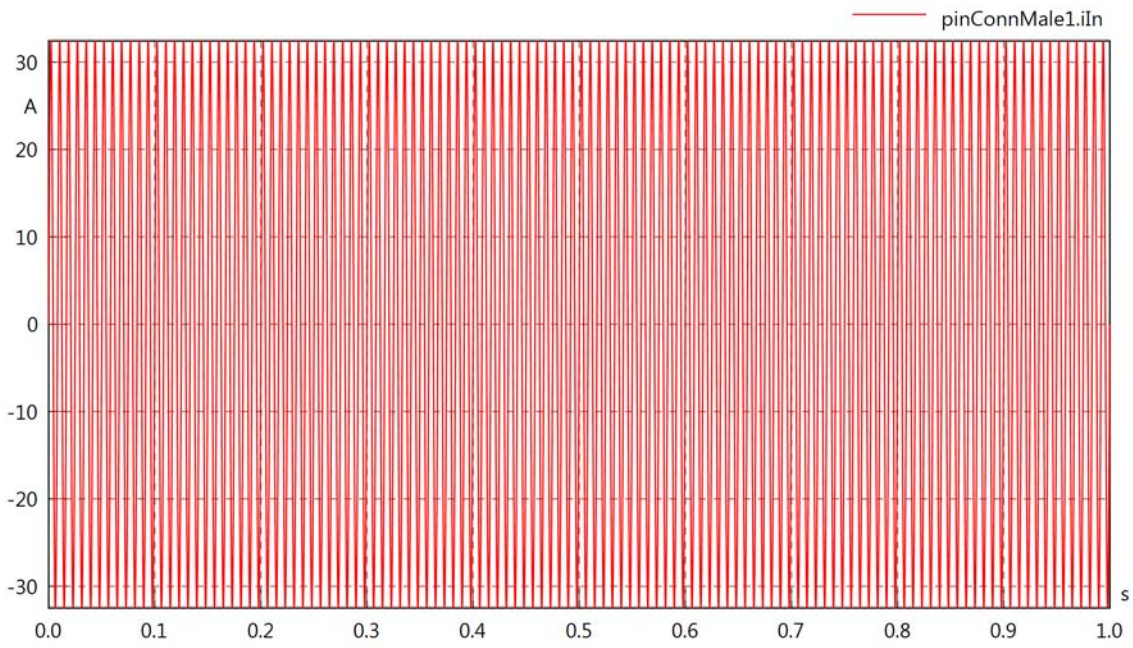

pinConnMale1.iOut

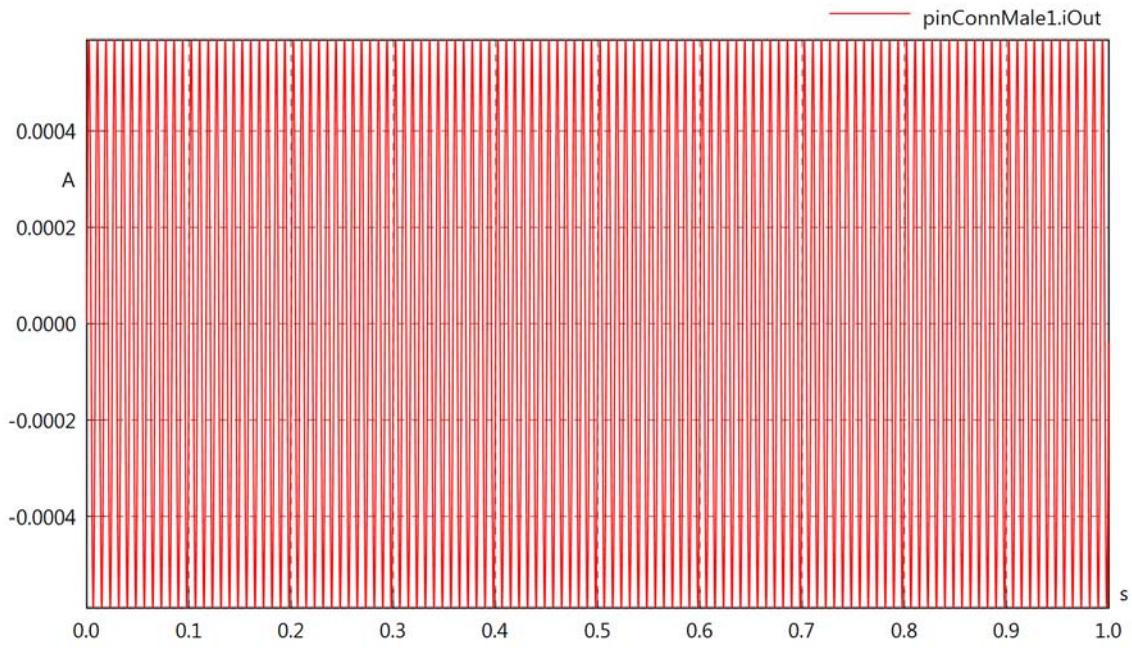

pinConnMale1.PI

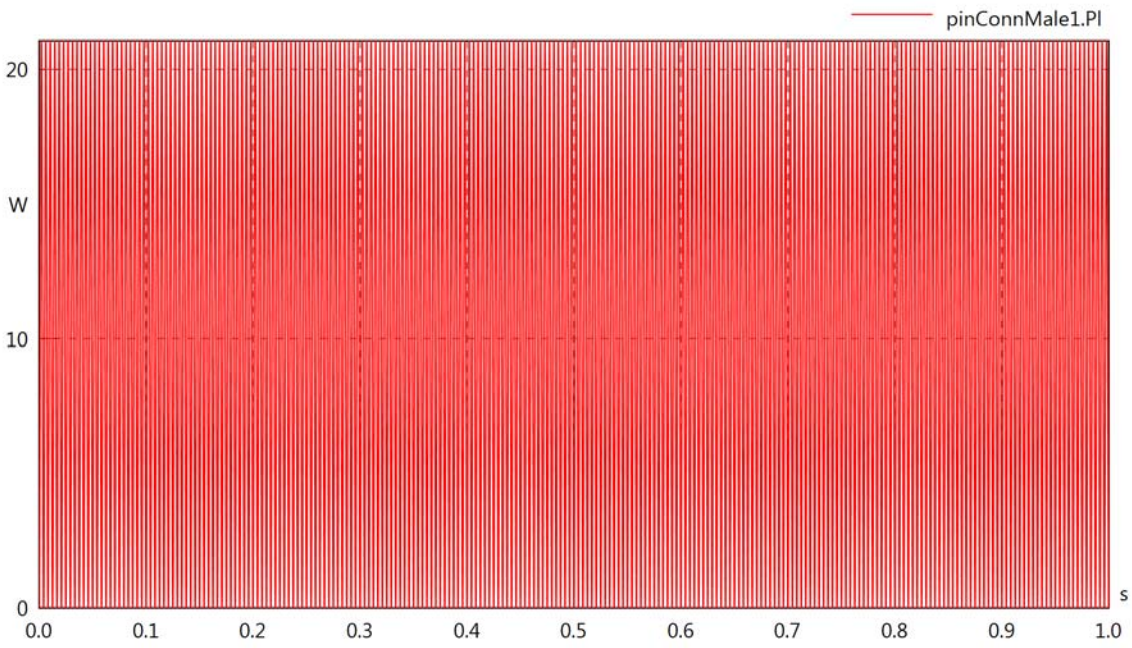
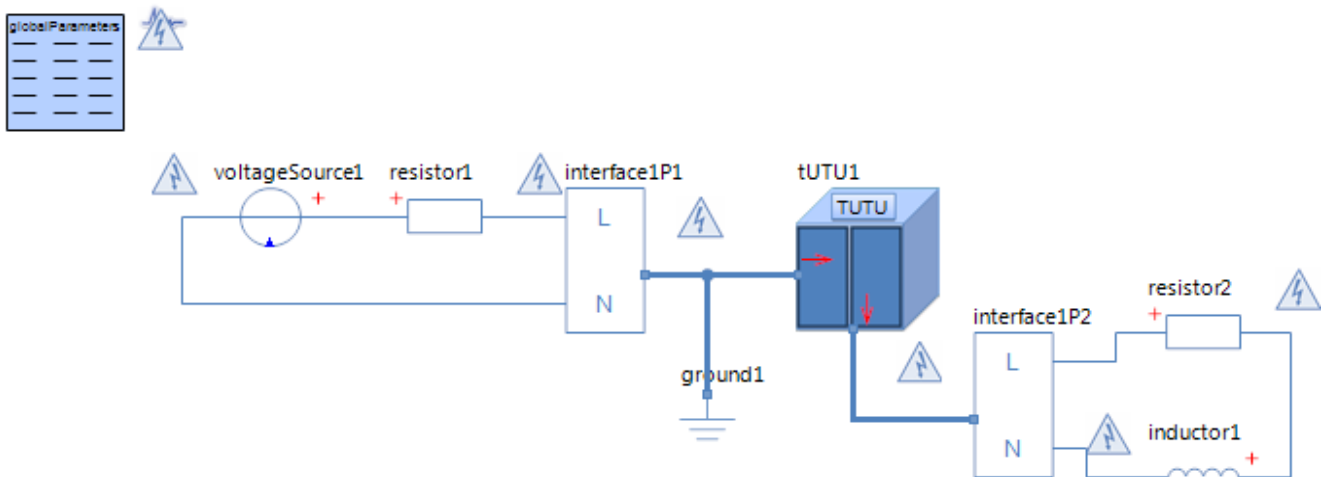

Diagram View



Voltage Source voltageSource1
Parameters

Comment	Name	Current Value	Unit
Voltage	v_src	$230 \cdot \sqrt{2} \cdot \sin(2 \cdot \pi \cdot 30 \cdot t)$	[V]

Resistor resistor1
Parameters

Comment	Name	Current Value	Unit
Resistance	R	10	[Ohm]

Resistor resistor2
Parameters

Comment	Name	Current Value	Unit
Resistance	R	100	[Ohm]

Inductor inductor1
Parameters

Comment	Name	Current Value	Unit
Inductance	L	100	[mH]
Initial Value	i0	0 (Fixed)	[A]
Kind	kind	absolute	

Topside Umbilical Termination Unit tUTU1
Parameters

Comment	Name	Current Value	Unit
Poor or failing L1 connection	bL1	false	

tUTU1.vIn

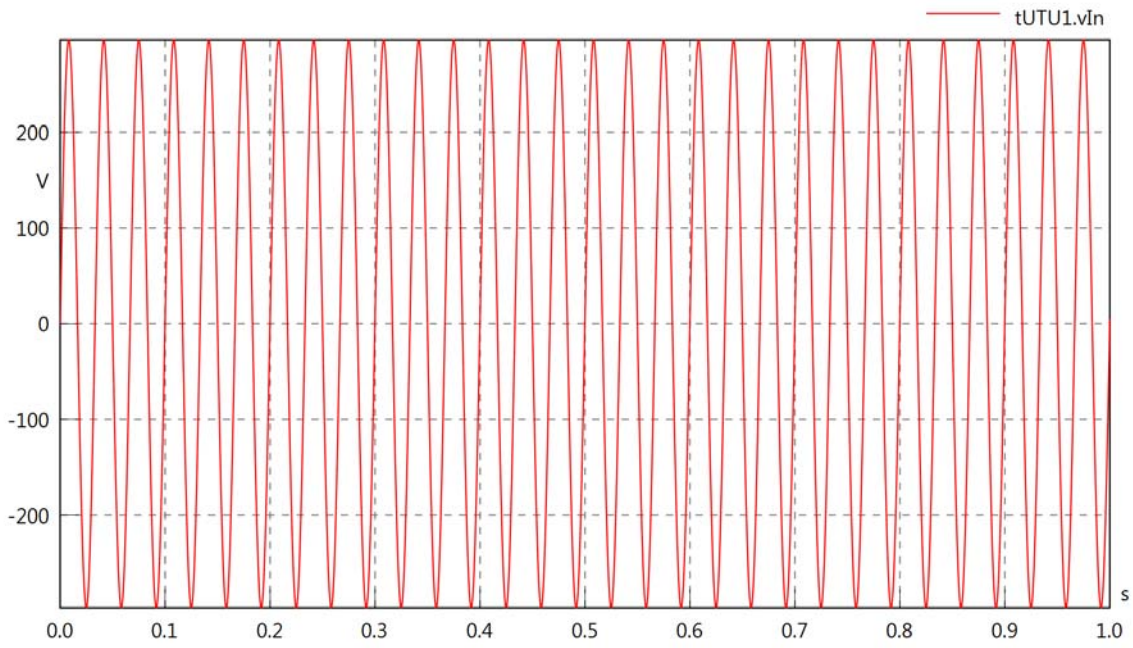

tUTU1.vOut

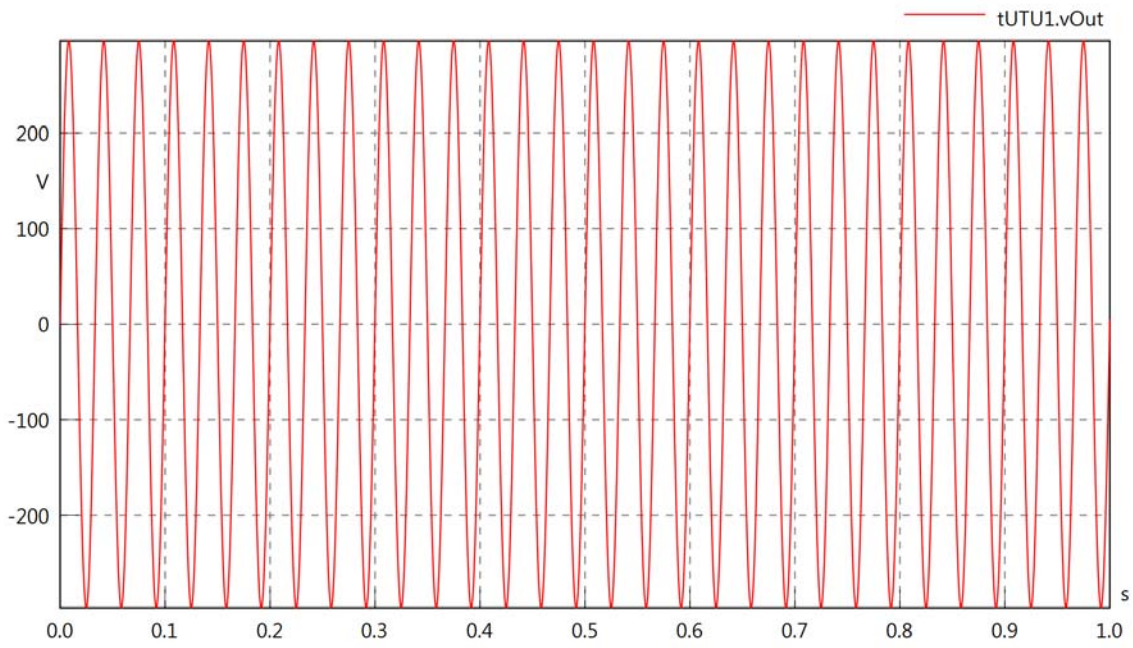

tUTU1.v

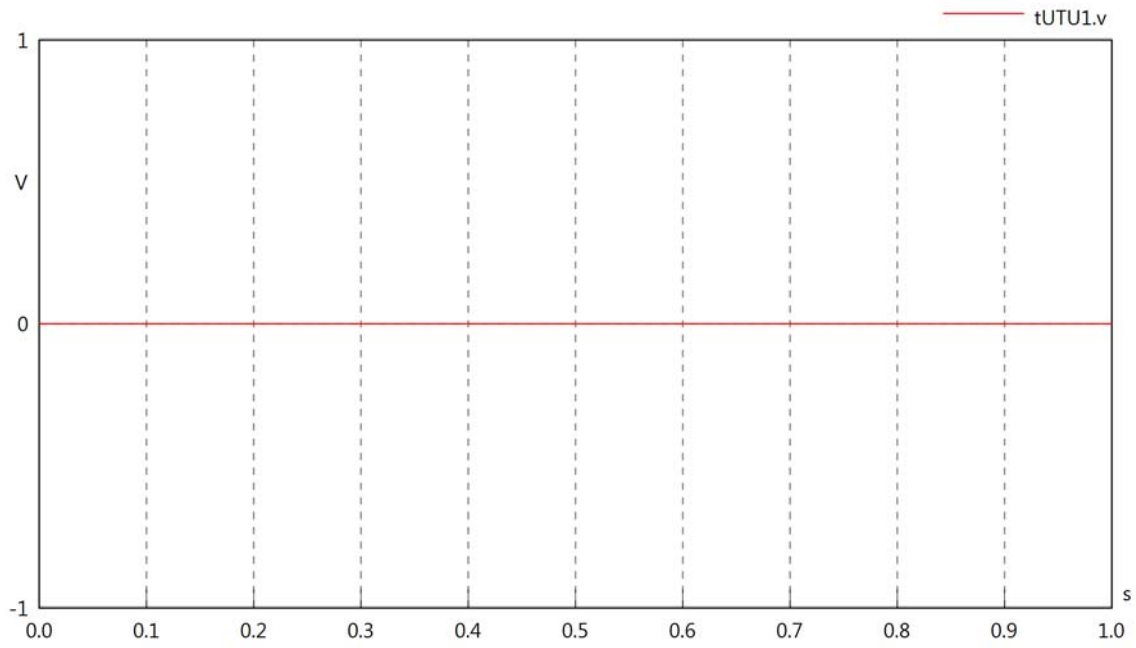

tUTU1.iIn

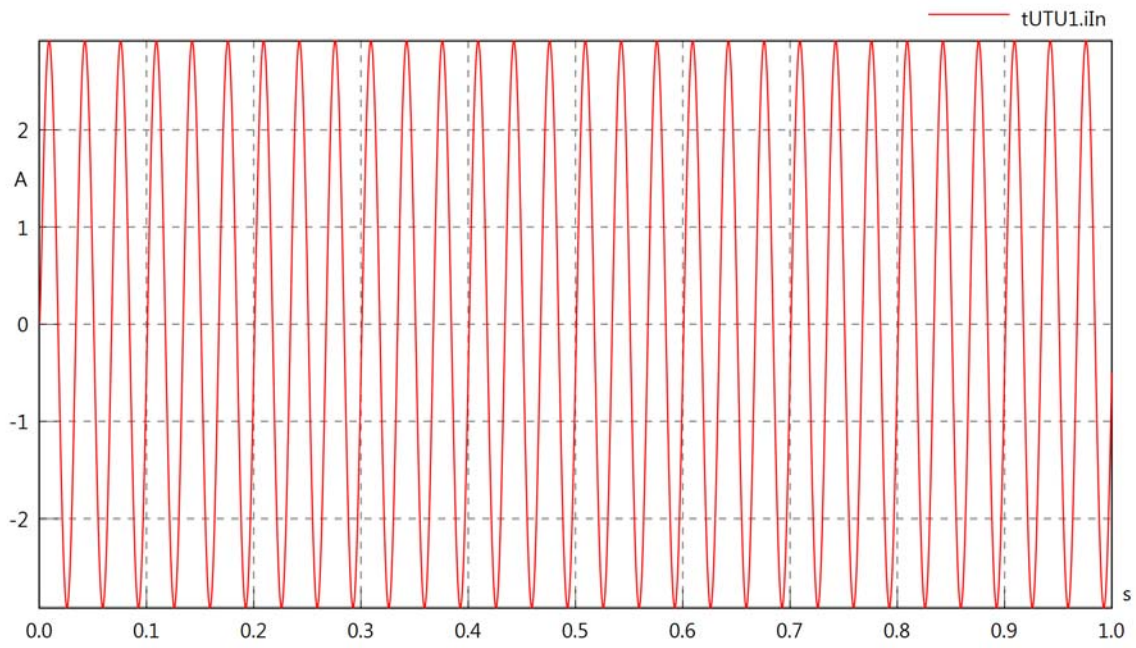

tUTU1.iOut

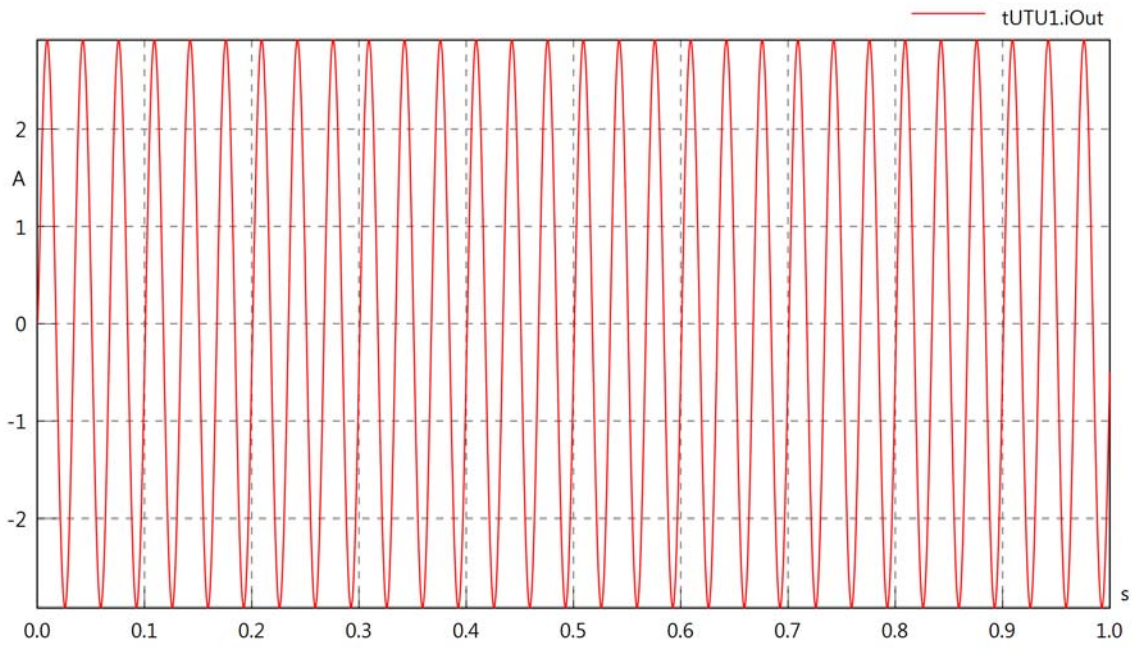

tUTU1.PI

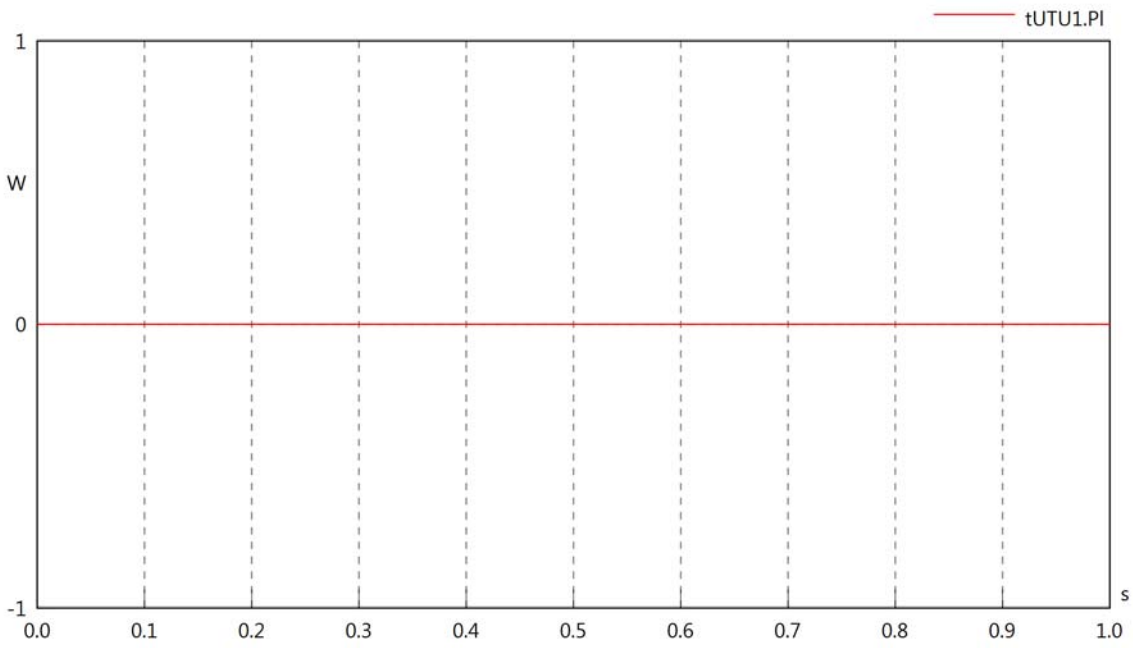
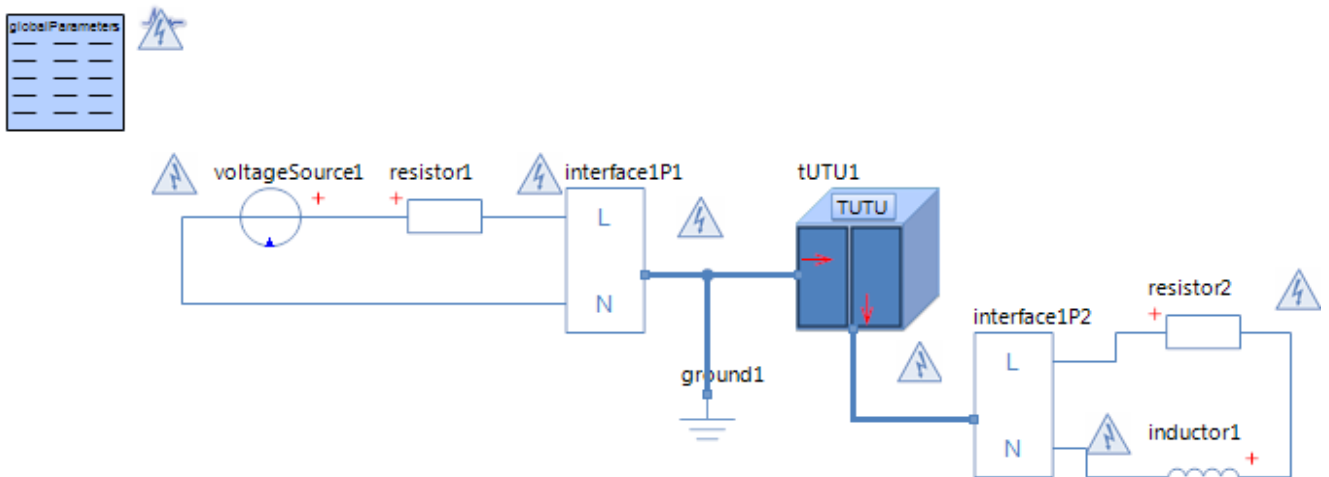

Diagram View



Voltage Source voltageSource1
Parameters

Comment	Name	Current Value	Unit
Voltage	v_src	$230 \cdot \sqrt{2} \cdot \sin(2 \cdot \pi \cdot 60 \cdot t)$	[V]

Resistor resistor1
Parameters

Comment	Name	Current Value	Unit
Resistance	R	10	[Ohm]

Resistor resistor2
Parameters

Comment	Name	Current Value	Unit
Resistance	R	100	[Ohm]

Inductor inductor1
Parameters

Comment	Name	Current Value	Unit
Inductance	L	100	[mH]
Initial Value	i0	0 (Fixed)	[A]
Kind	kind	absolute	

Topside Umbilical Termination Unit tUTU1
Parameters

Comment	Name	Current Value	Unit
Poor or failing L1 connection	bL1	false	

tUTU1.vIn

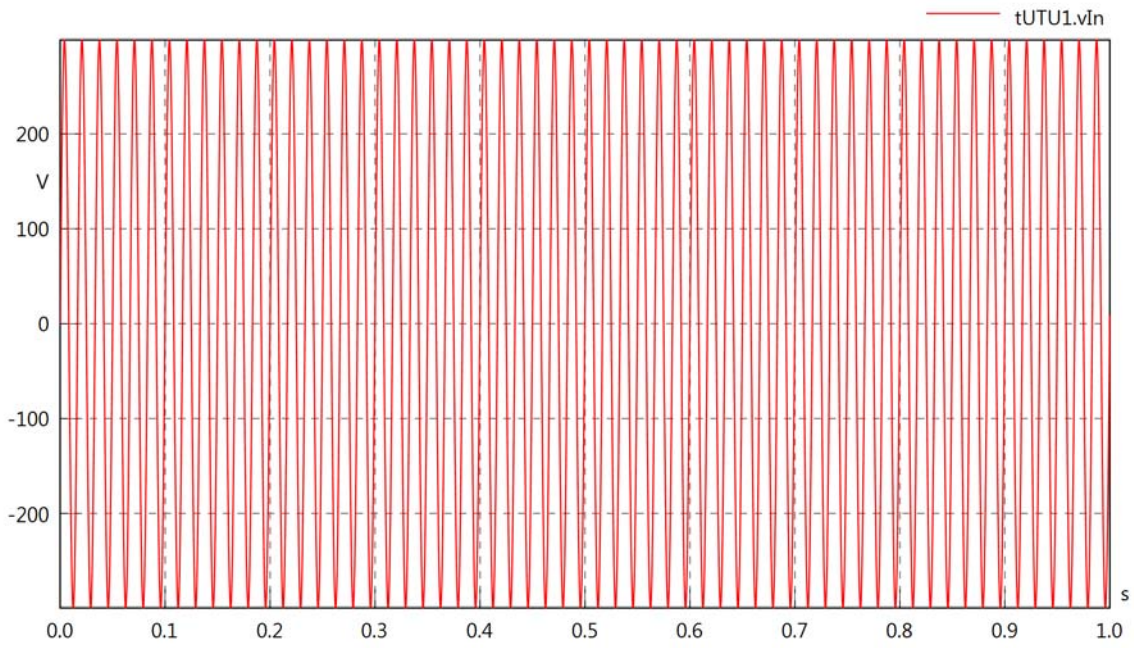

tUTU1.vOut

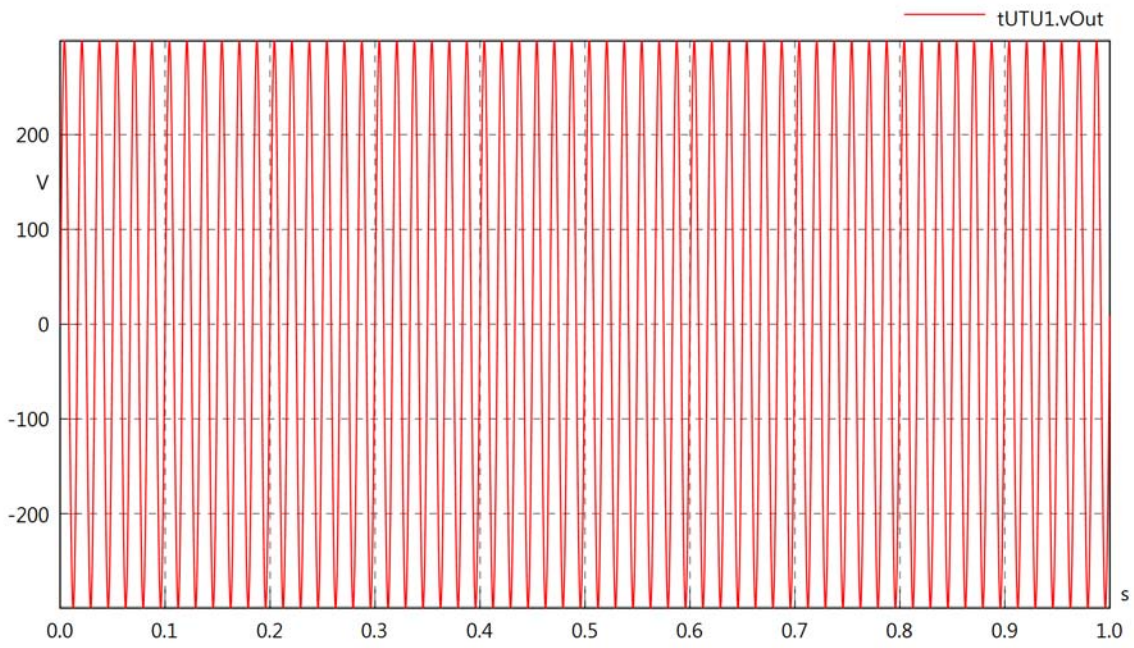

tUTU1.v

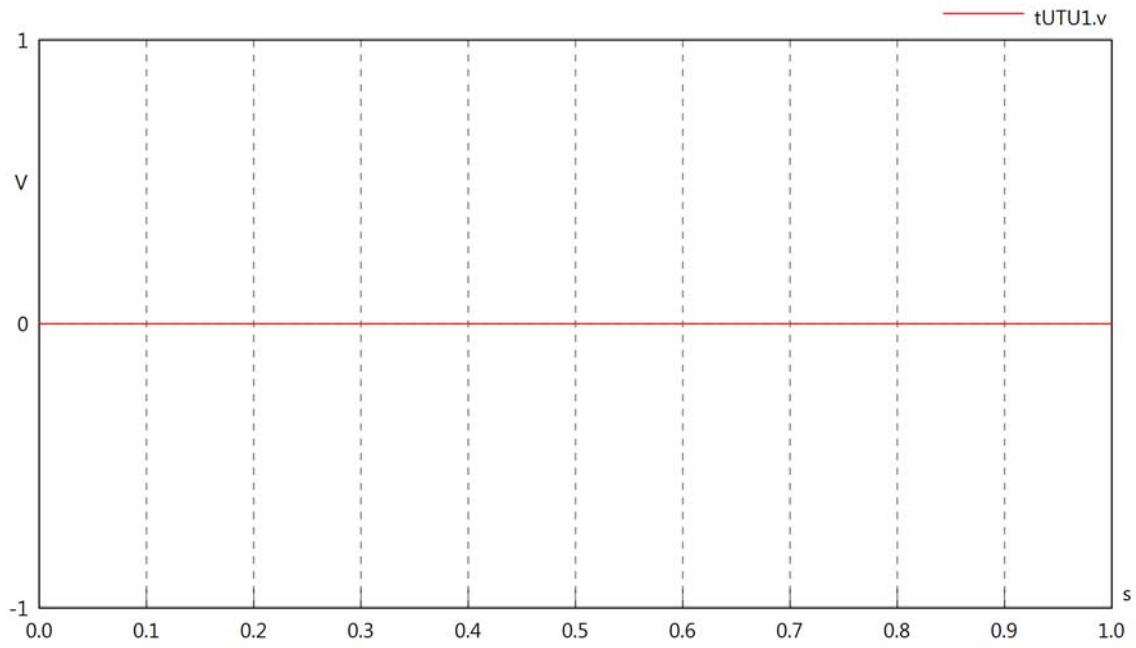

tUTU1.iIn

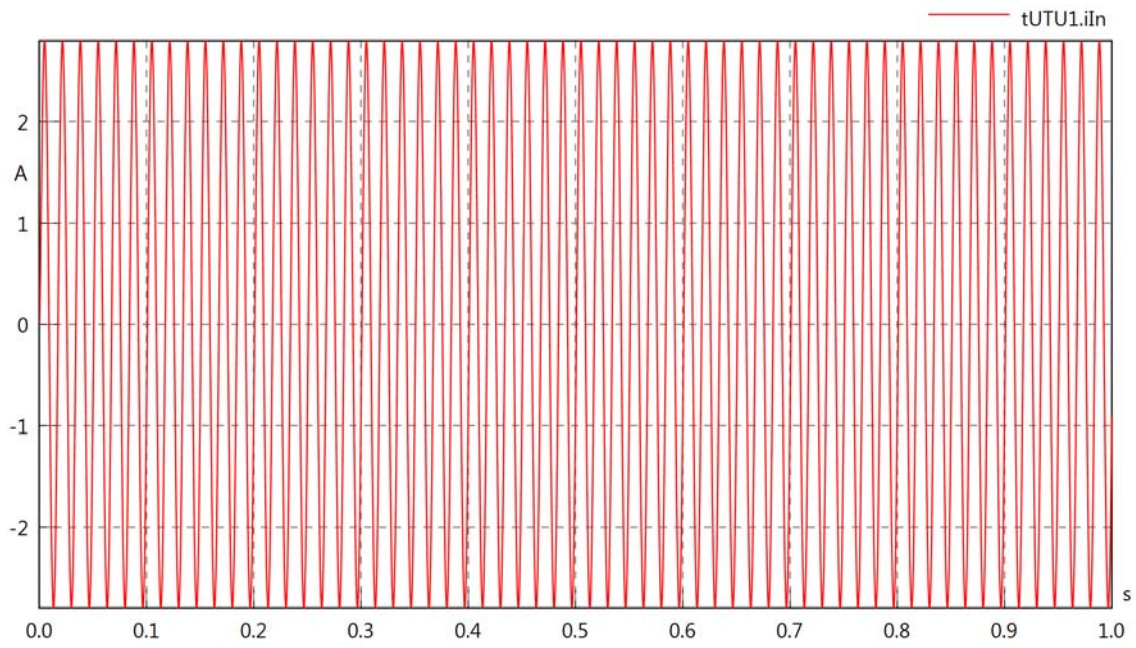

tUTU1.iOut

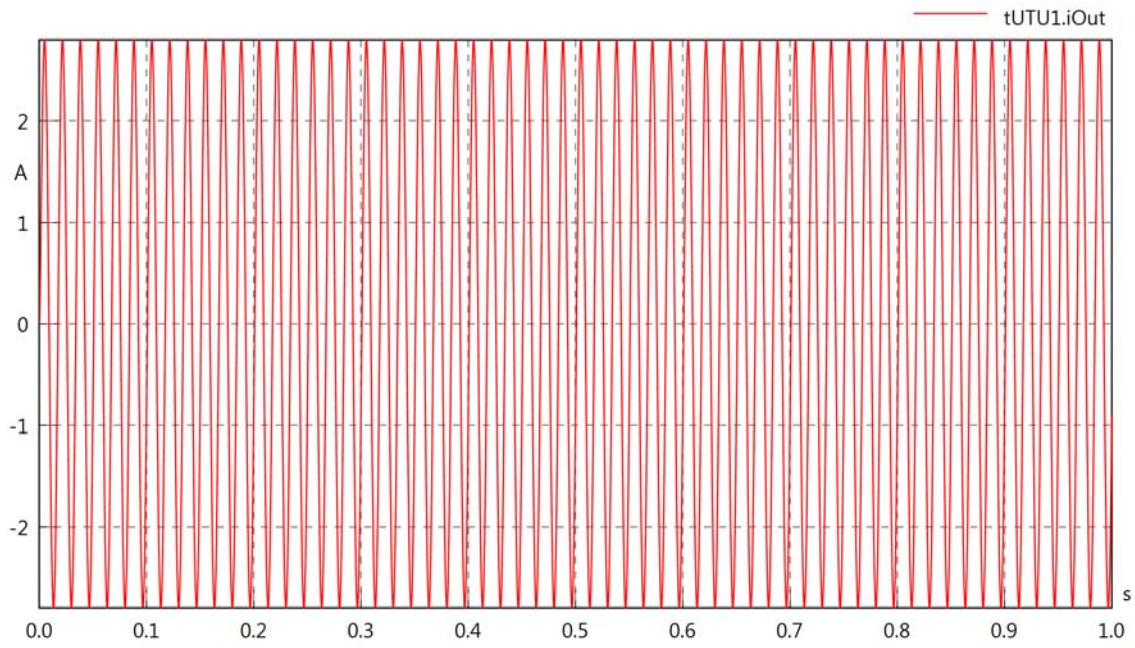

tUTU1.PI

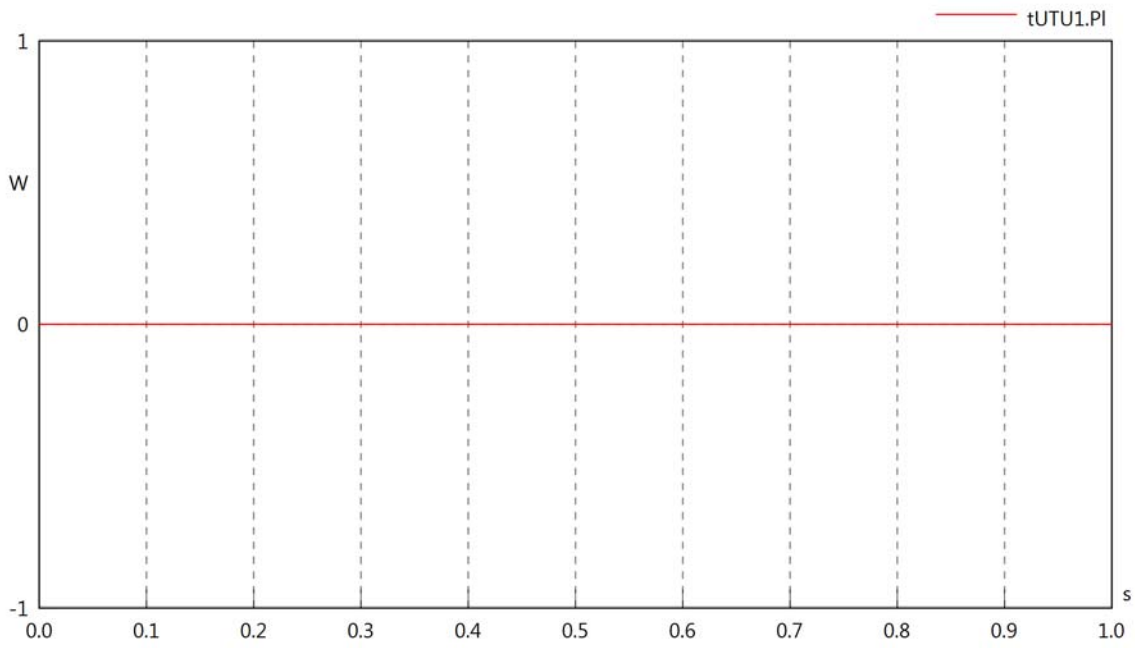
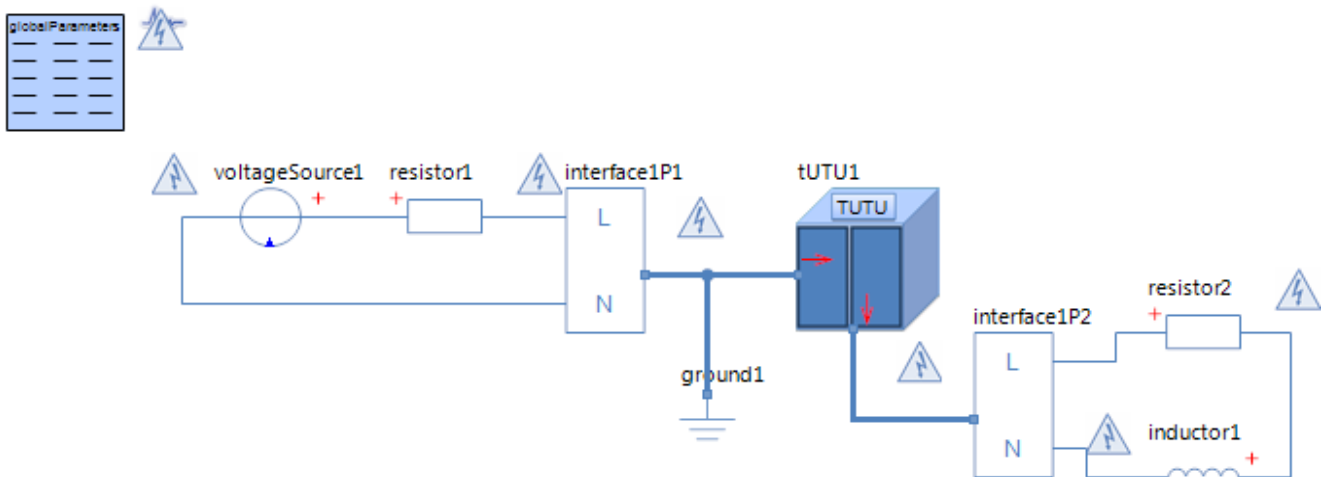

Diagram View



Voltage Source voltageSource1
Parameters

Comment	Name	Current Value	Unit
Voltage	v_src	$230 \cdot \sqrt{2} \cdot \sin(2 \cdot \pi \cdot 120 \cdot t)$	[V]

Resistor resistor1
Parameters

Comment	Name	Current Value	Unit
Resistance	R	10	[Ohm]

Resistor resistor2
Parameters

Comment	Name	Current Value	Unit
Resistance	R	100	[Ohm]

Inductor inductor1
Parameters

Comment	Name	Current Value	Unit
Inductance	L	100	[mH]
Initial Value	i0	0 (Fixed)	[A]
Kind	kind	absolute	

Topside Umbilical Termination Unit tUTU1
Parameters

Comment	Name	Current Value	Unit
Poor or failing L1 connection	bL1	false	

tUTU1.vIn

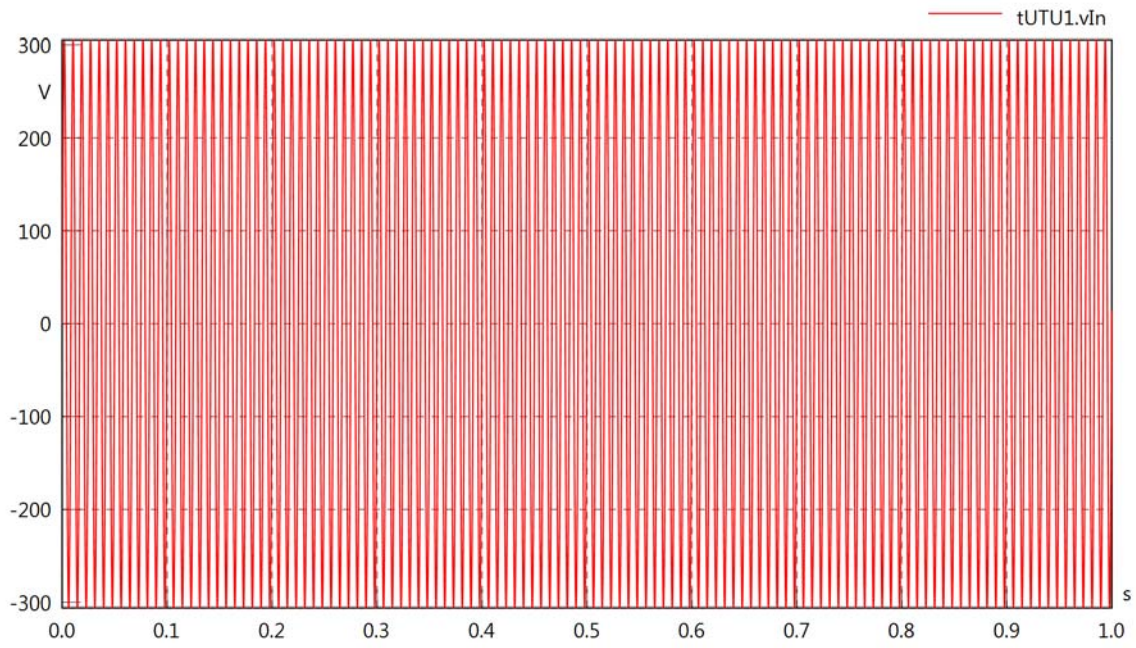

tUTU1.vOut

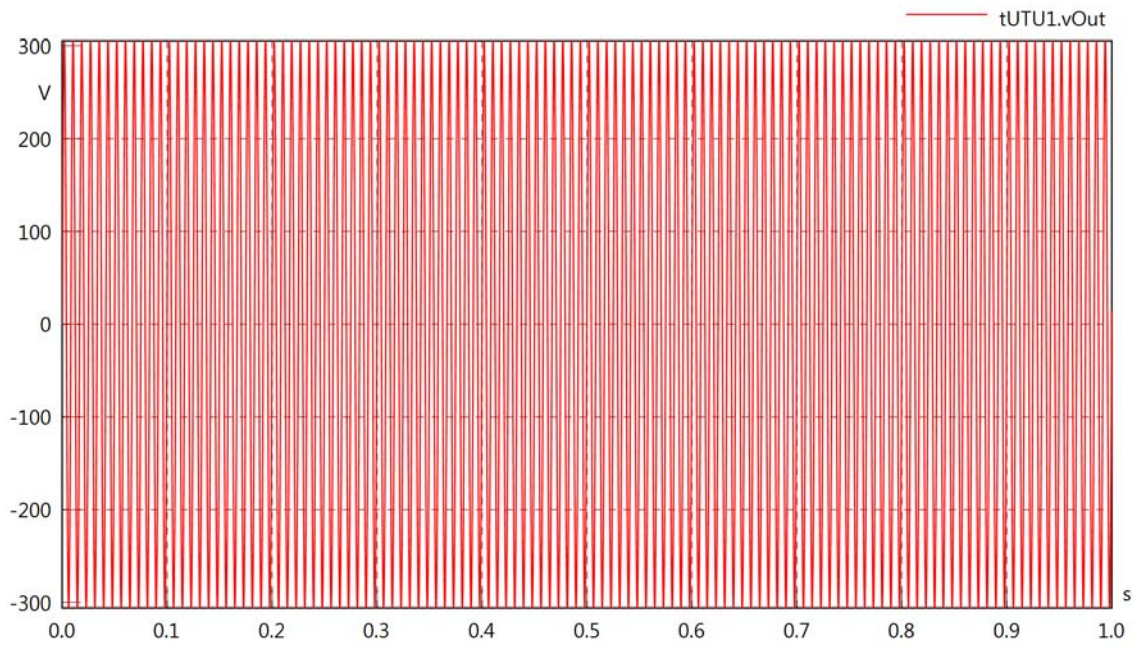

tUTU1.v

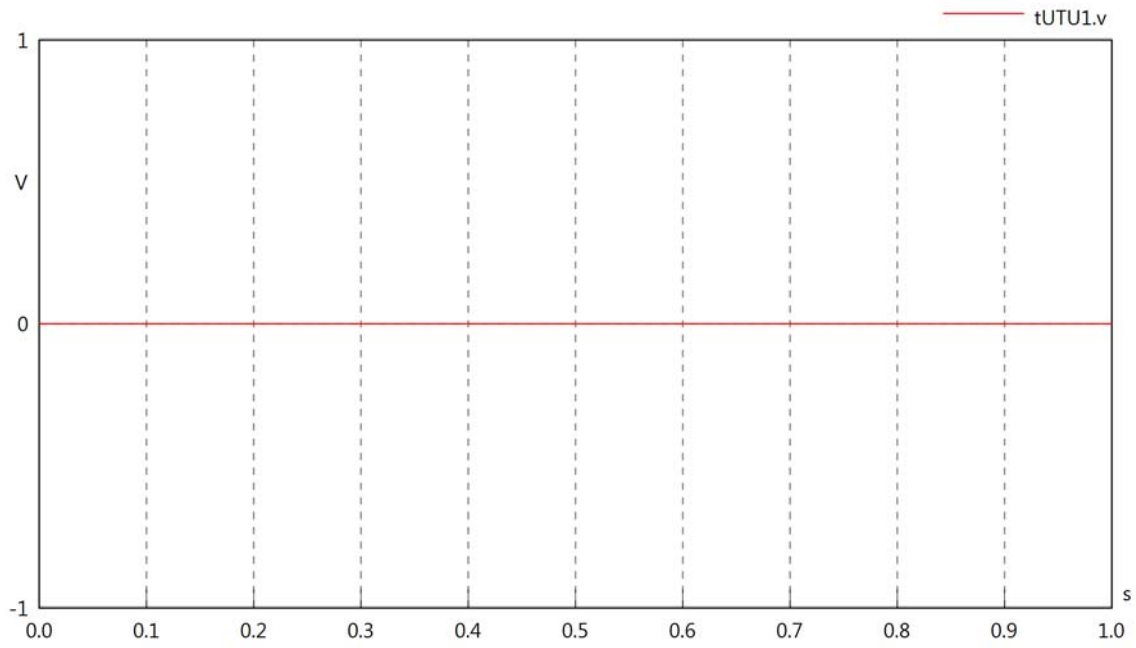

tUTU1.iIn

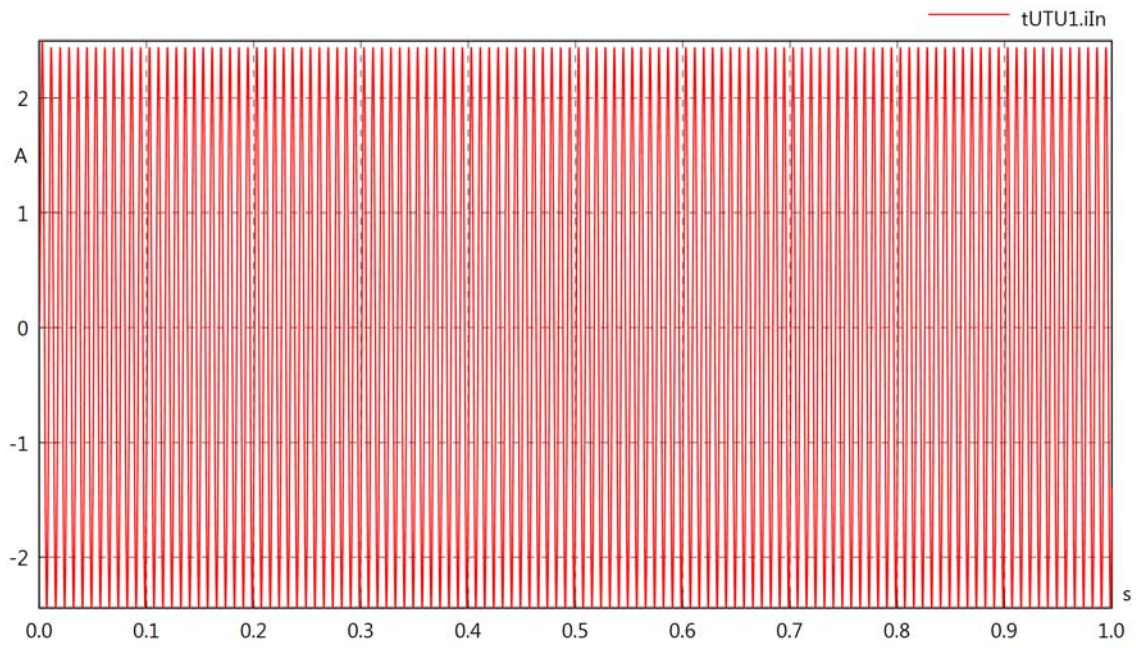

tUTU1.iOut

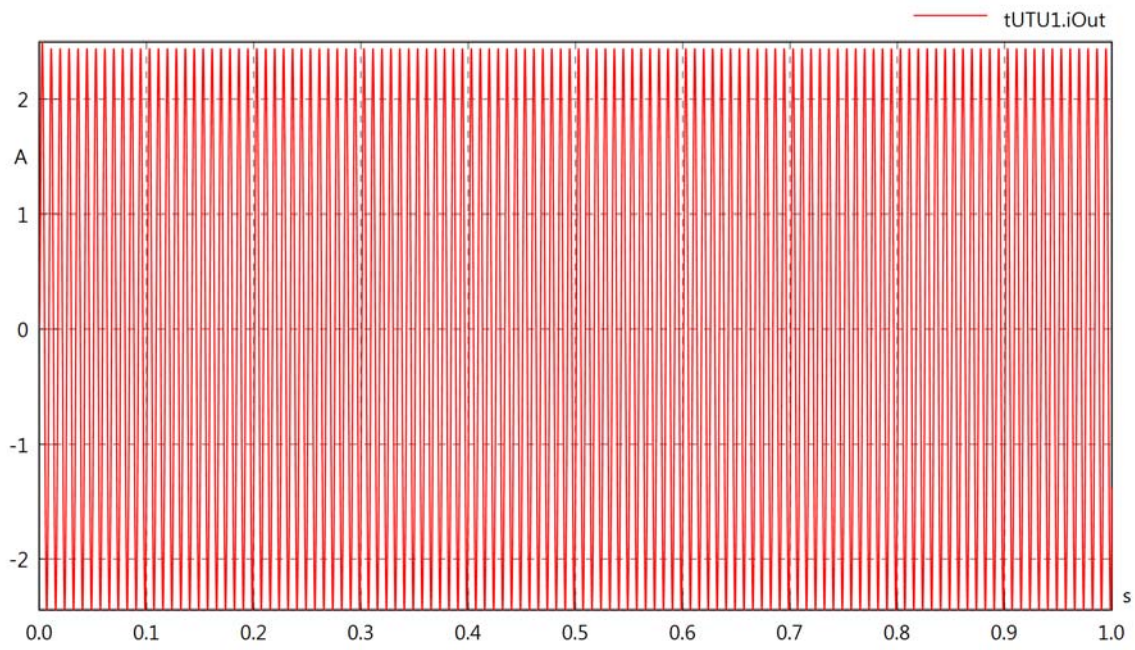

tUTU1.PI

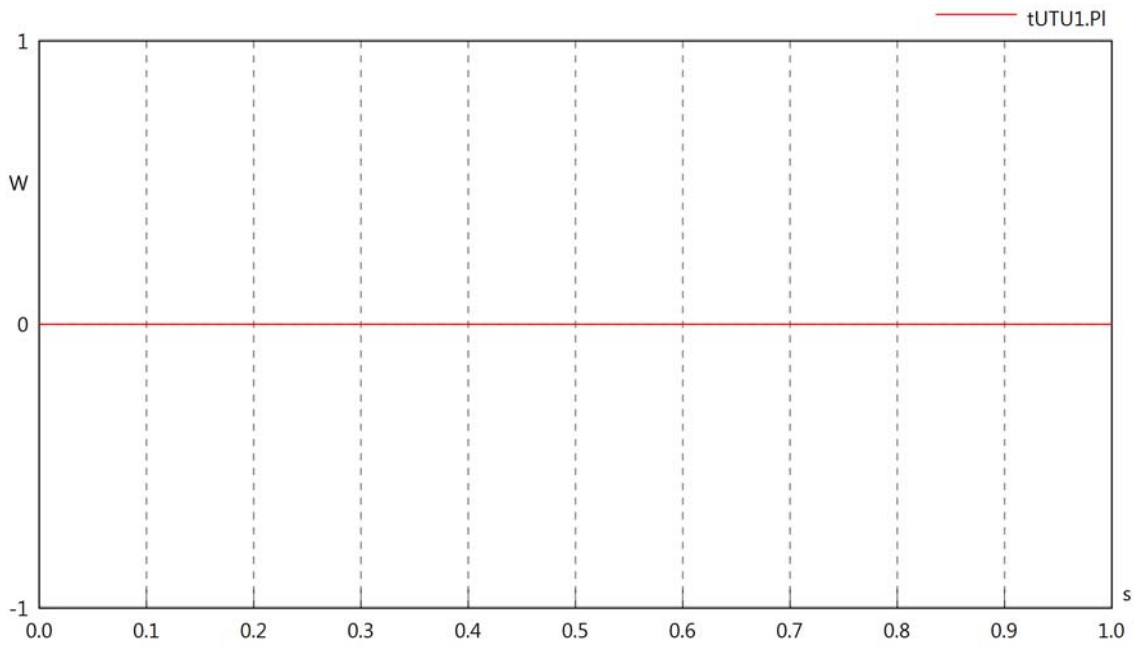
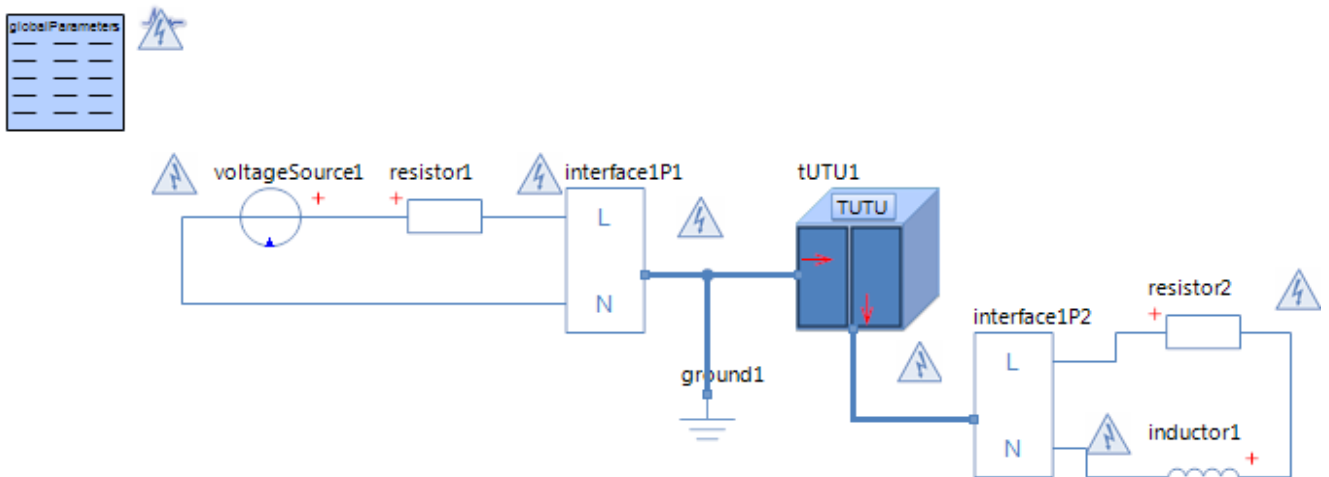

Diagram View



Voltage Source voltageSource1
Parameters

Comment	Name	Current Value	Unit
Voltage	v_src	$230 \cdot \sqrt{2} \cdot \sin(2 \cdot \pi \cdot 30 \cdot t)$	[V]

Resistor resistor1
Parameters

Comment	Name	Current Value	Unit
Resistance	R	10	[Ohm]

Resistor resistor2
Parameters

Comment	Name	Current Value	Unit
Resistance	R	100	[Ohm]

Inductor inductor1
Parameters

Comment	Name	Current Value	Unit
Inductance	L	100	[mH]
Initial Value	i0	0 (Fixed)	[A]
Kind	kind	absolute	

Topside Umbilical Termination Unit tUTU1
Parameters

Comment	Name	Current Value	Unit
Poor or failing L1 connection	bL1	true	
Resistance in L1 connection	rL1	1	[kOhm]
Conductance between L1 and N	G	50	[1/Ohm]

tUTU1.vIn

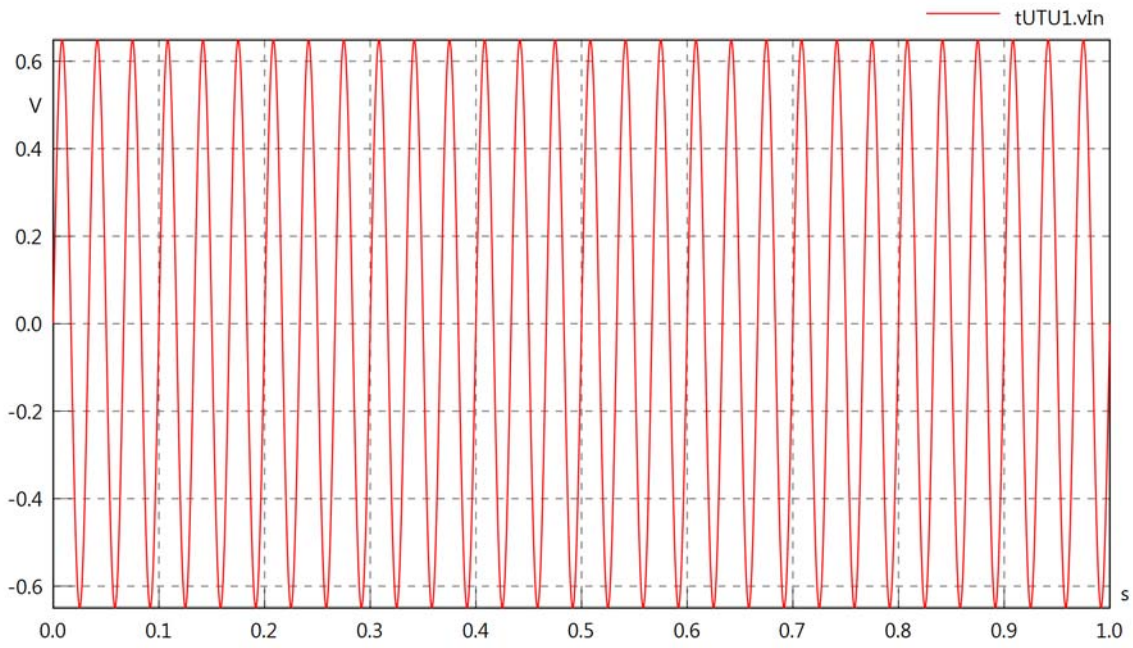

tUTU1.vOut

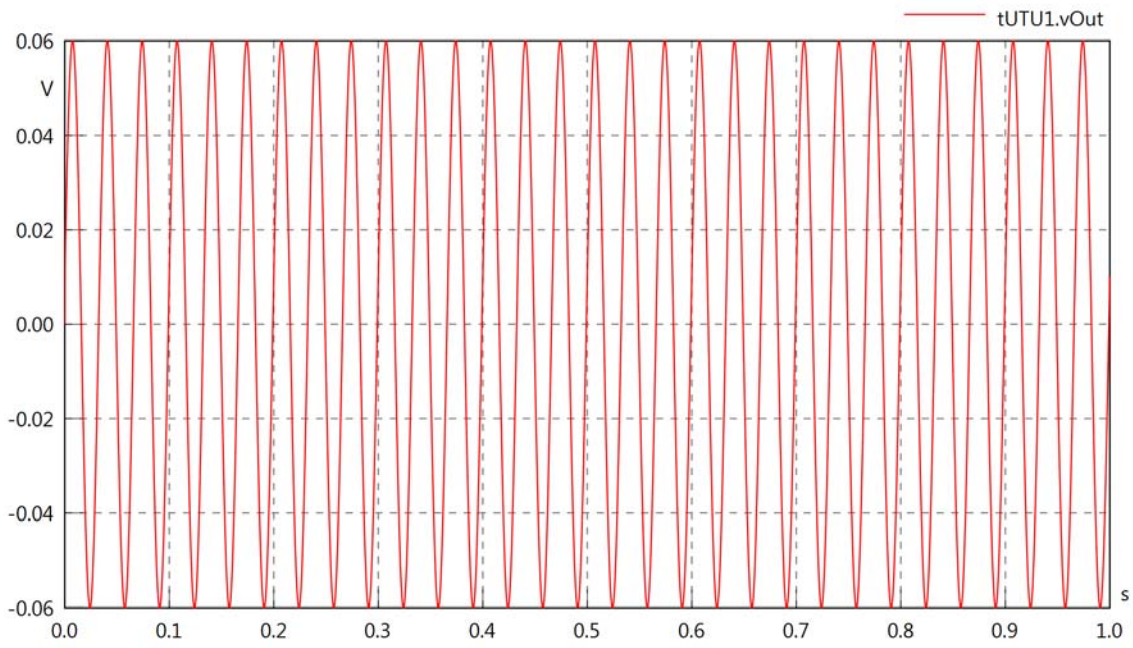

tUTU1.v

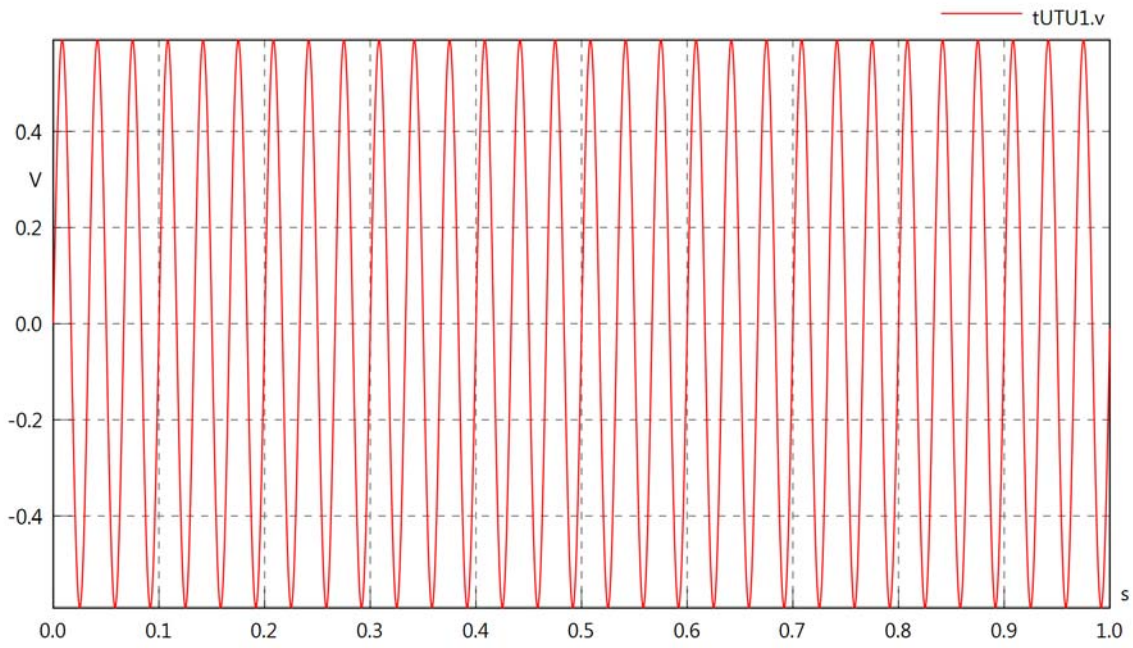

tUTU1.iIn

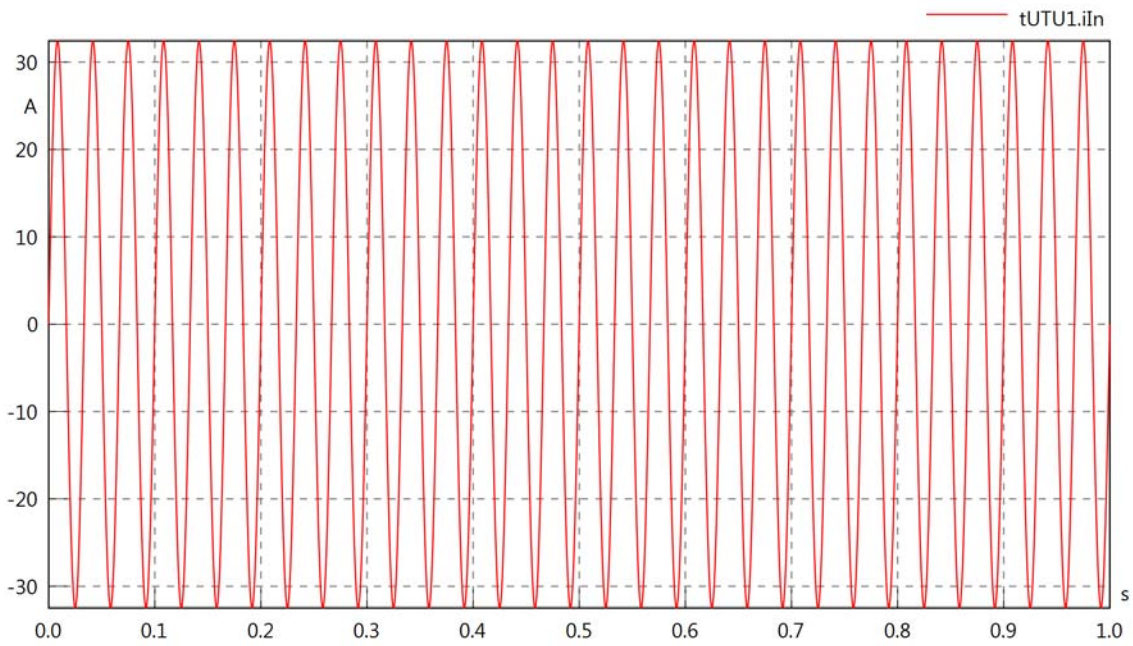

tUTU1.iOut

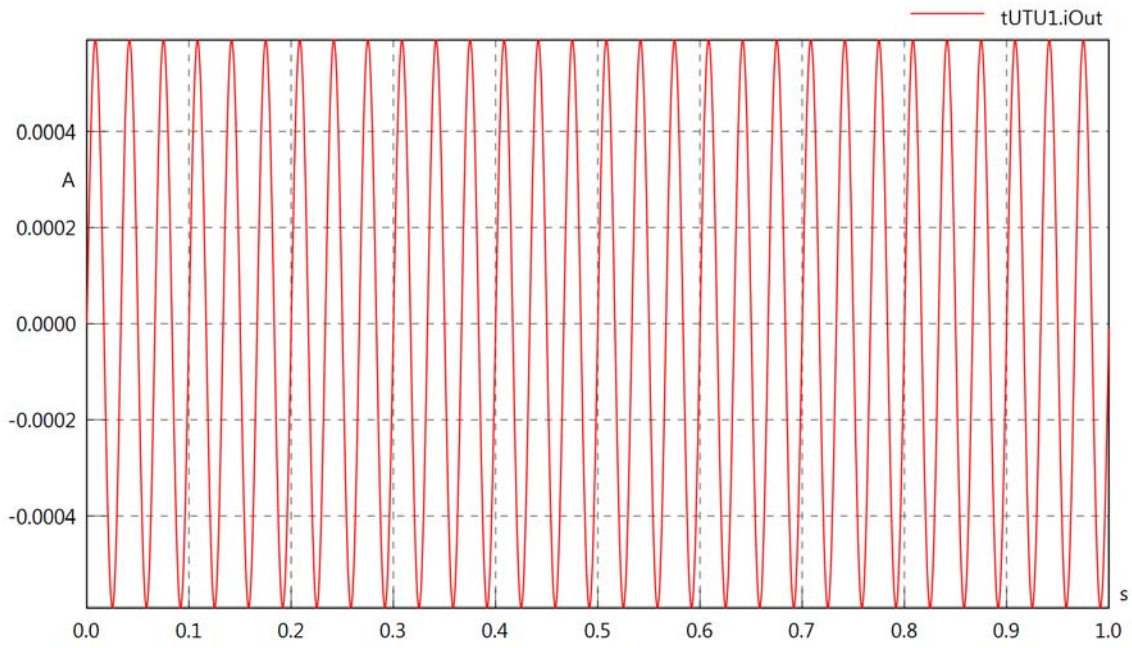

tUTU1.PI

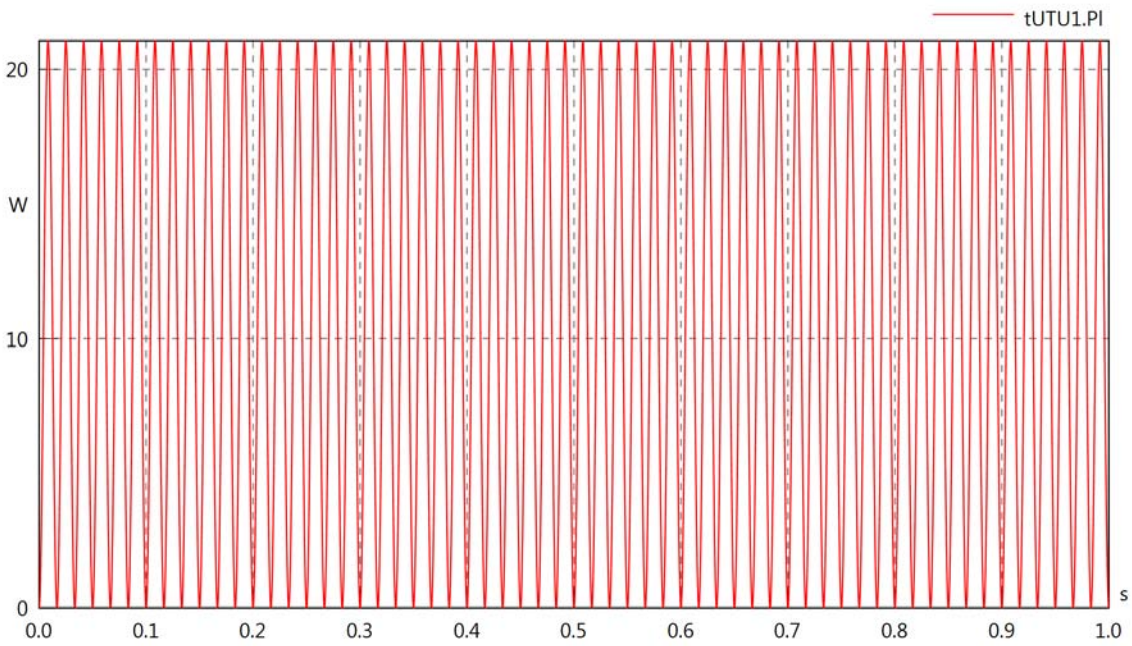
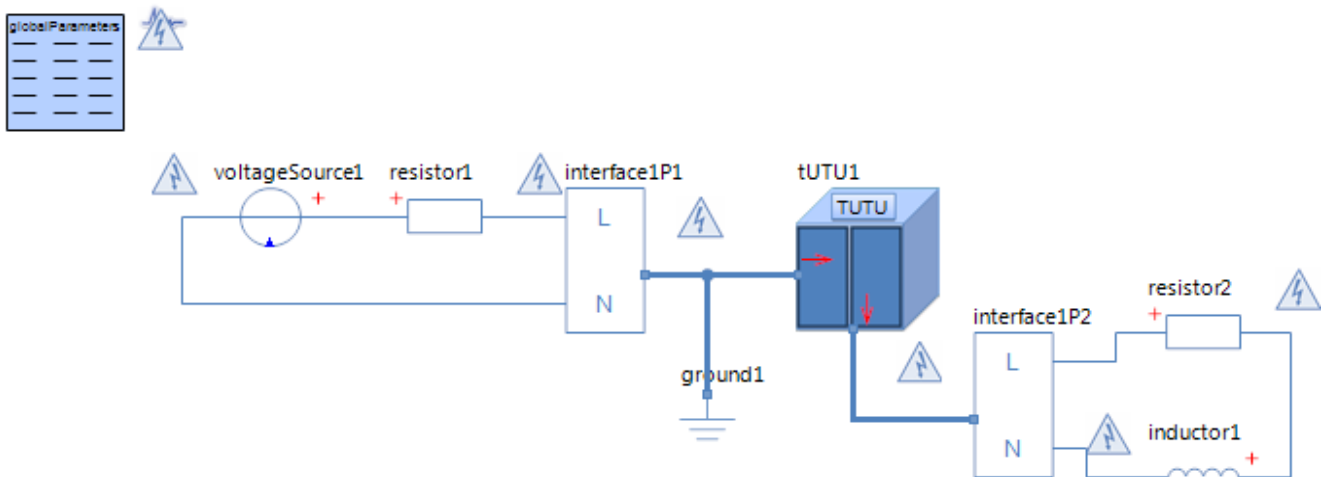

Diagram View



Voltage Source voltageSource1
Parameters

Comment	Name	Current Value	Unit
Voltage	v_src	$230 \cdot \sqrt{2} \cdot \sin(2 \cdot \pi \cdot 60 \cdot t)$	[V]

Resistor resistor1
Parameters

Comment	Name	Current Value	Unit
Resistance	R	10	[Ohm]

Resistor resistor2
Parameters

Comment	Name	Current Value	Unit
Resistance	R	100	[Ohm]

Inductor inductor1
Parameters

Comment	Name	Current Value	Unit
Inductance	L	100	[mH]
Initial Value	i0	0 (Fixed)	[A]
Kind	kind	absolute	

Topside Umbilical Termination Unit tUTU1
Parameters

Comment	Name	Current Value	Unit
Poor or failing L1 connection	bL1	true	
Resistance in L1 connection	rL1	1	[kOhm]
Conductance between L1 and N	G	50	[1/Ohm]

tUTU1.vIn

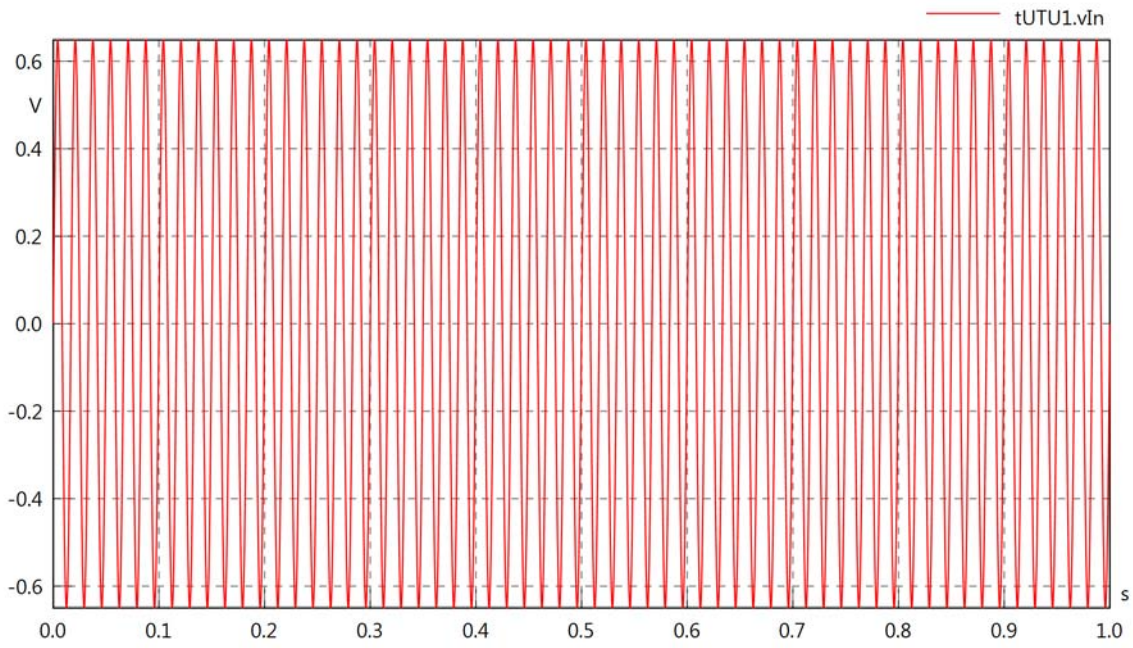

tUTU1.vOut

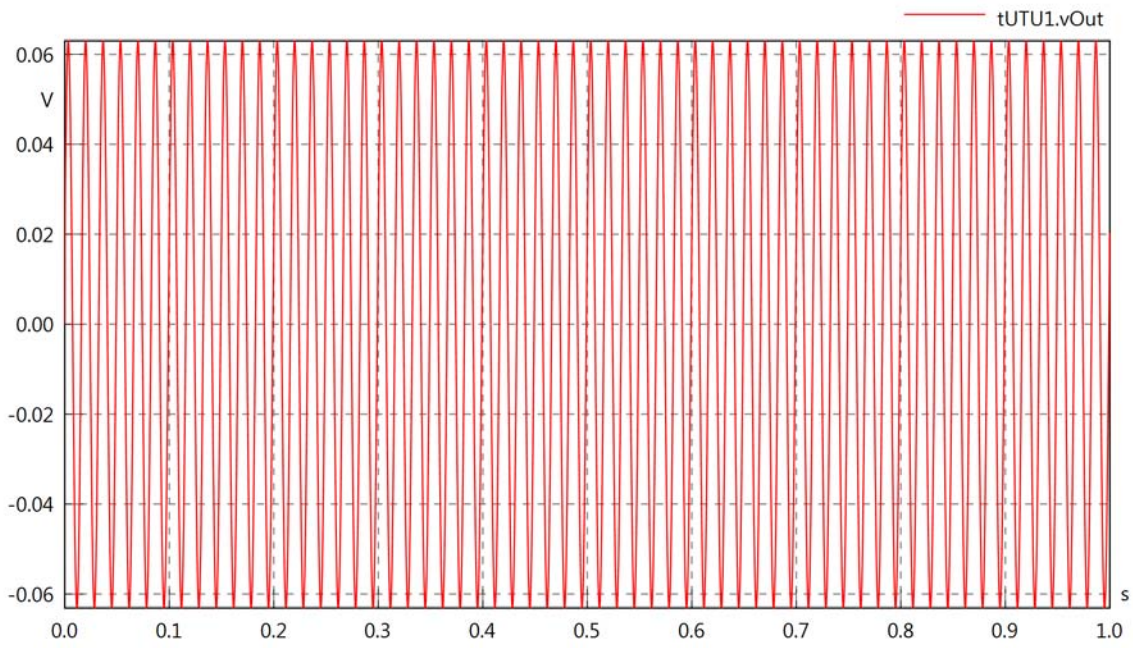

tUTU1.v

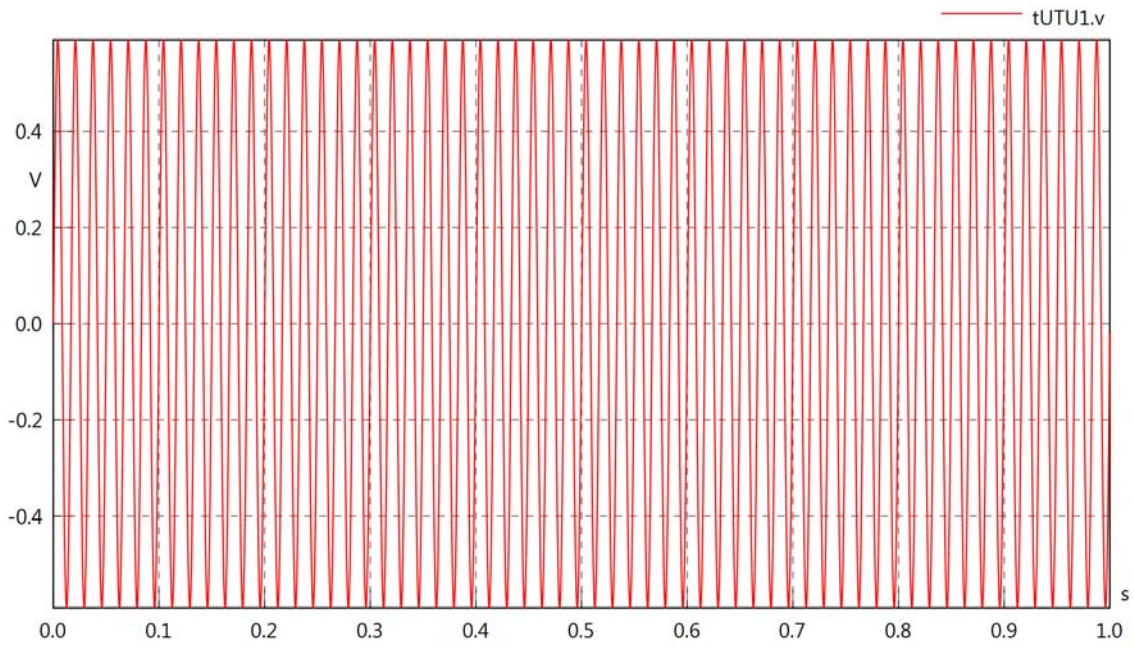

tUTU1.iIn

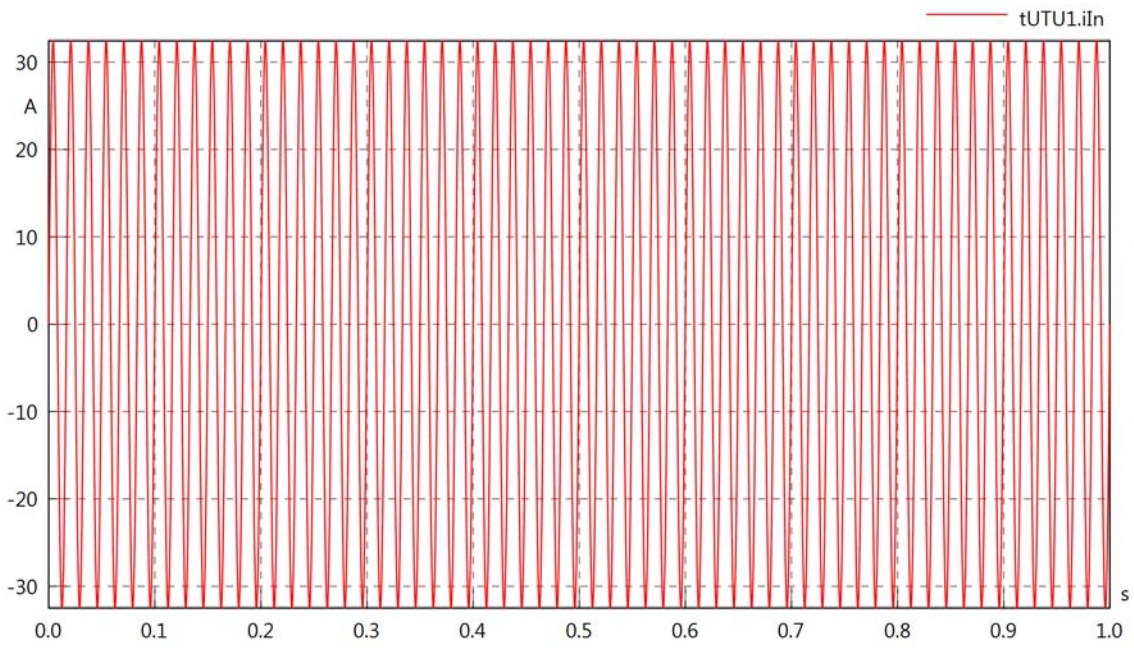

tUTU1.iOut

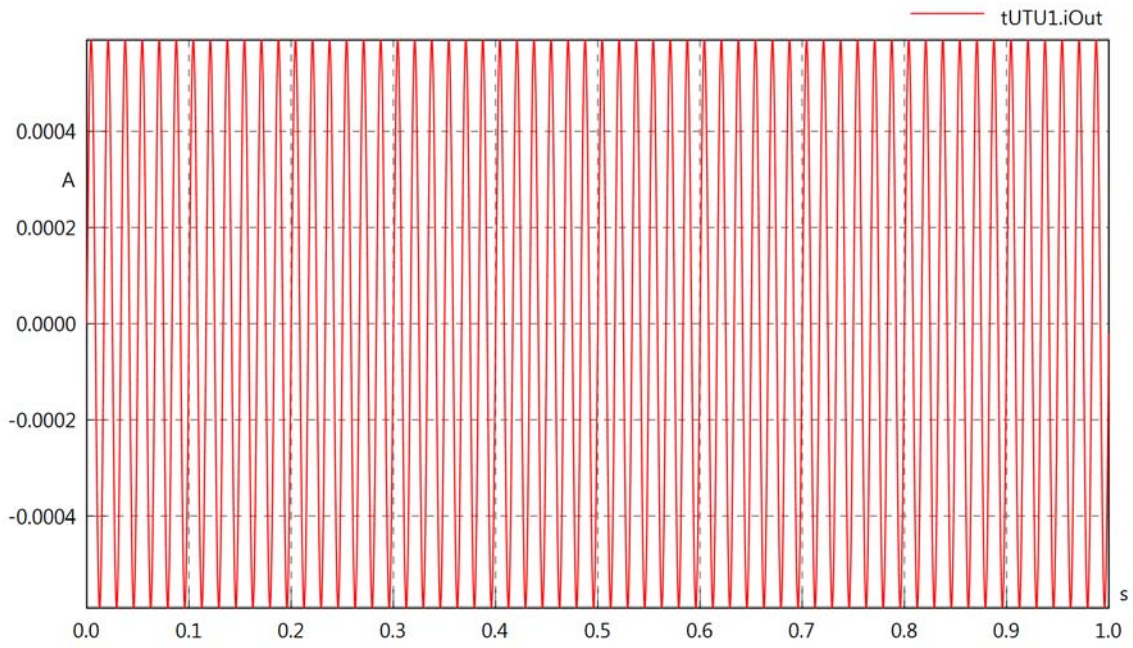

tUTU1.PI

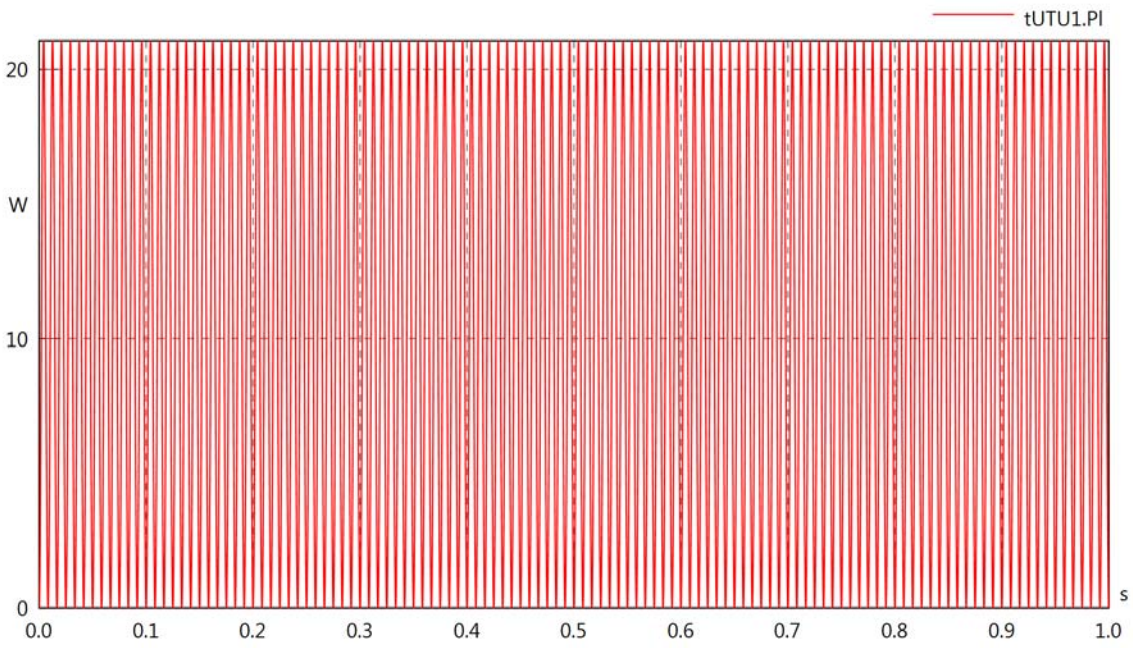
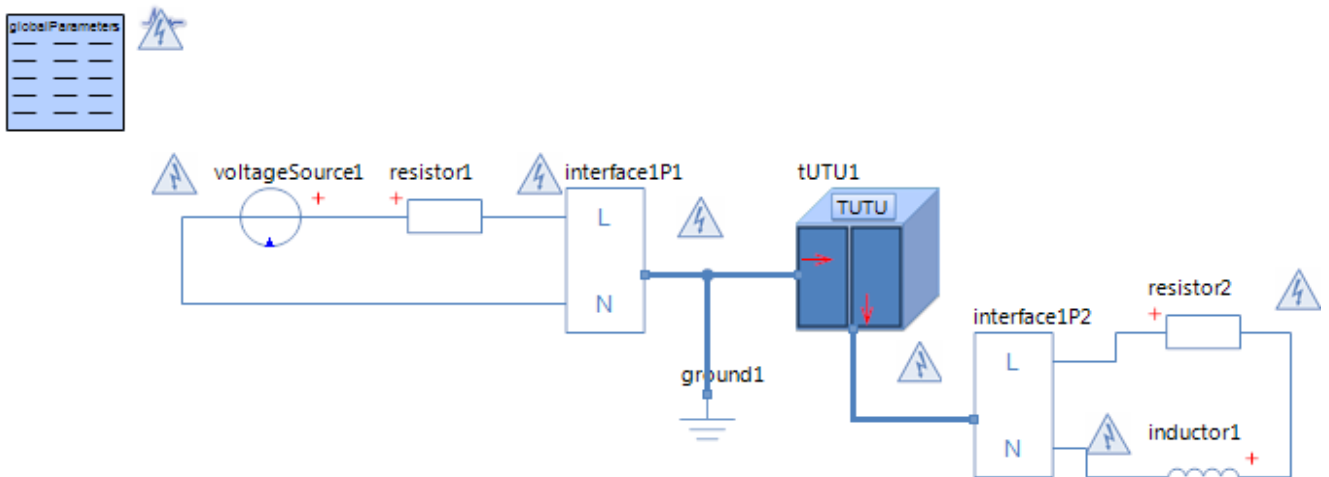

Diagram View



Voltage Source voltageSource1
Parameters

Comment	Name	Current Value	Unit
Voltage	v_src	$230 \cdot \sqrt{2} \cdot \sin(2 \cdot \pi \cdot 120 \cdot t)$	[V]

Resistor resistor1
Parameters

Comment	Name	Current Value	Unit
Resistance	R	10	[Ohm]

Resistor resistor2
Parameters

Comment	Name	Current Value	Unit
Resistance	R	100	[Ohm]

Inductor inductor1
Parameters

Comment	Name	Current Value	Unit
Inductance	L	100	[mH]
Initial Value	i0	0 (Fixed)	[A]
Kind	kind	absolute	

Topside Umbilical Termination Unit tUTU1
Parameters

Comment	Name	Current Value	Unit
Poor or failing L1 connection	bL1	true	
Resistance in L1 connection	rL1	1	[kOhm]
Conductance between L1 and N	G	50	[1/Ohm]

tUTU1.vIn

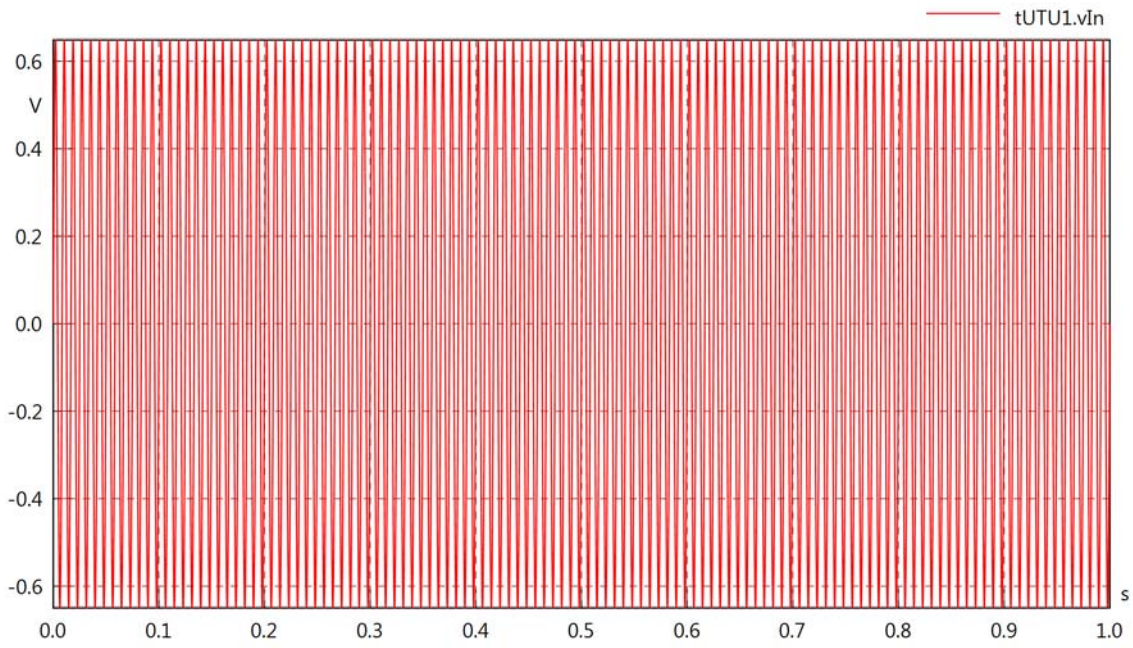

tUTU1.vOut

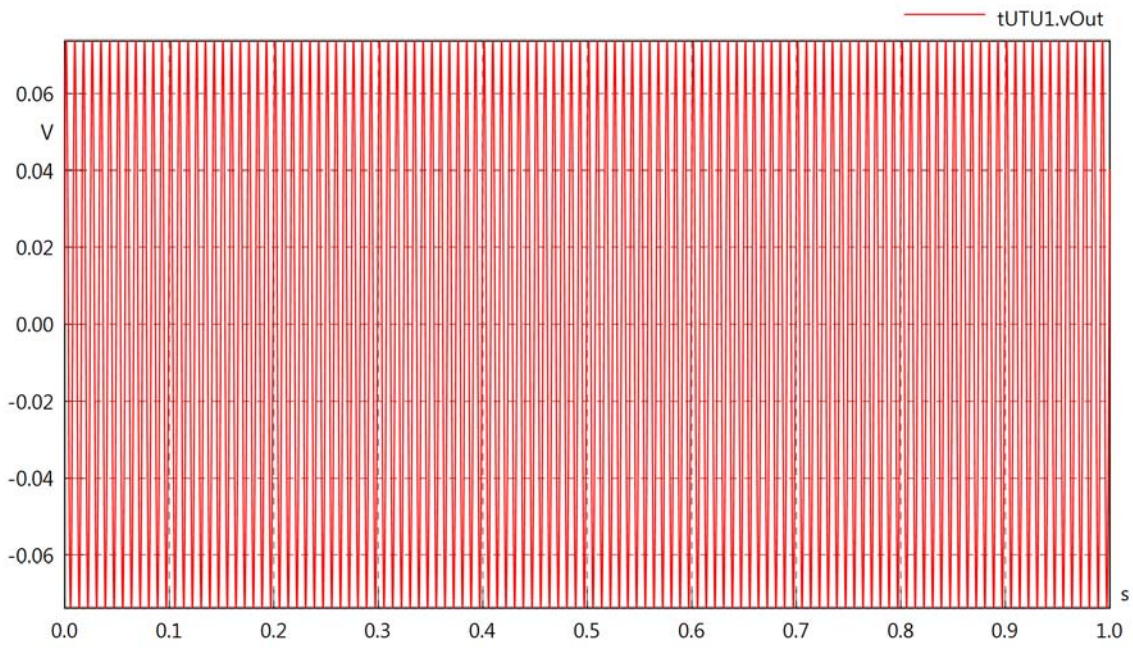

tUTU1.v

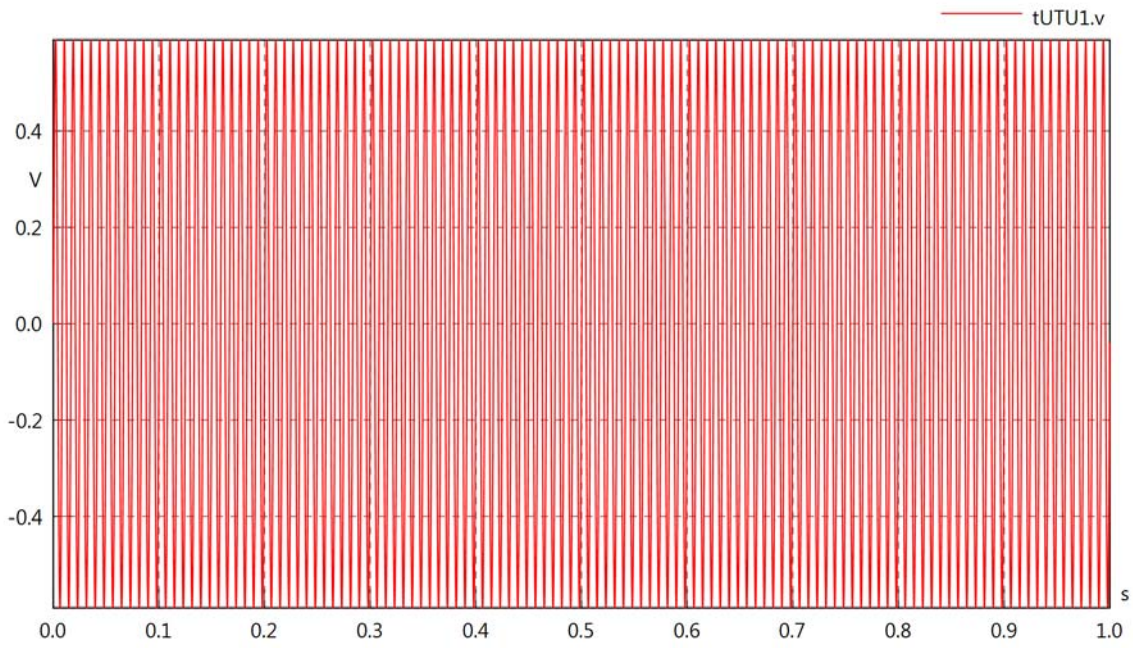

tUTU1.iIn

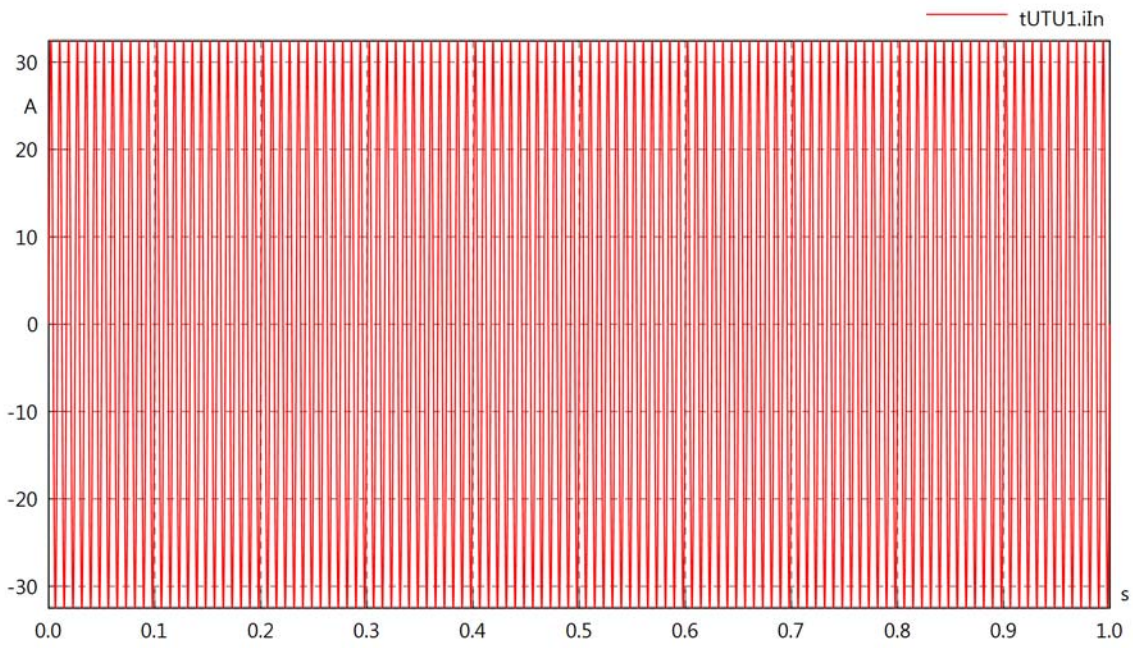

tUTU1.iOut

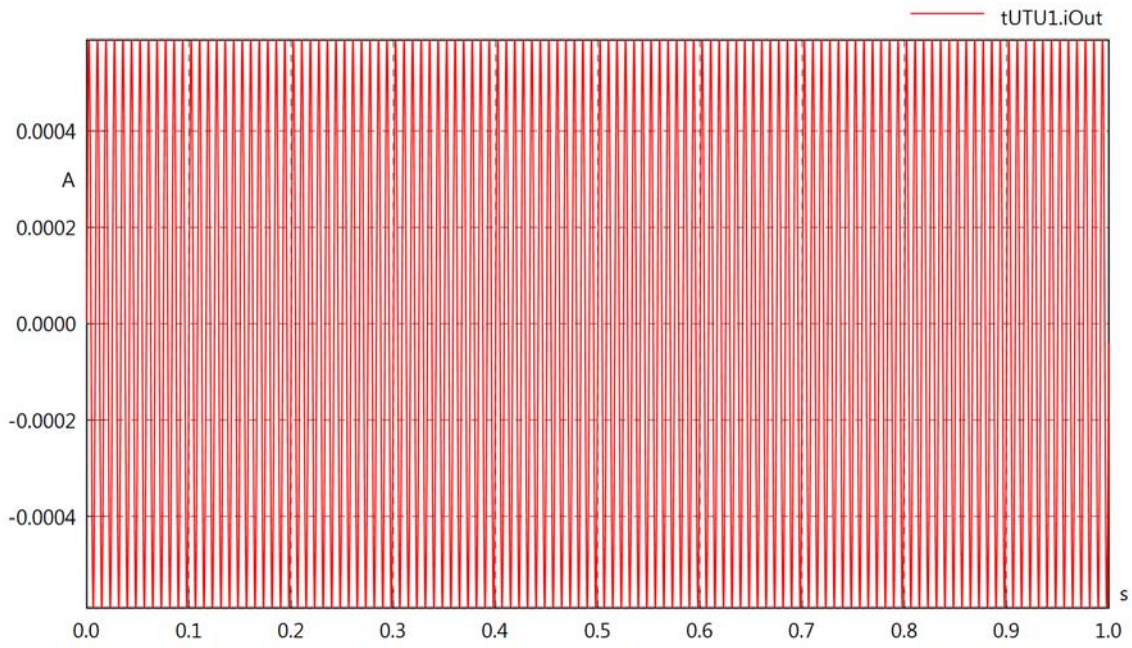

tUTU1.PI

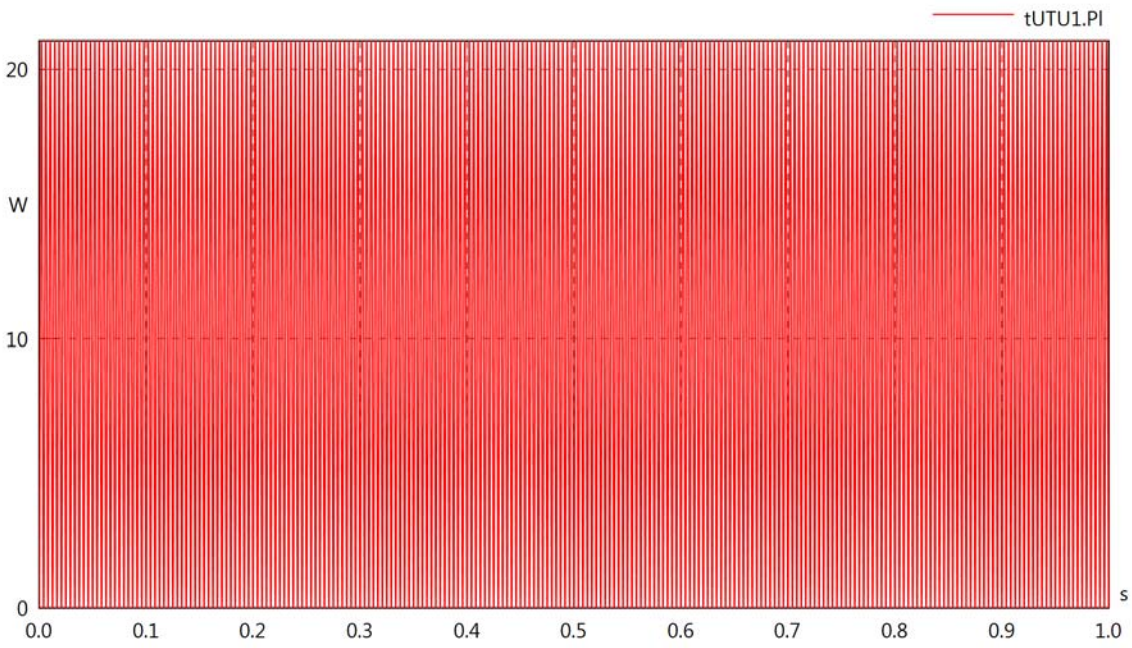
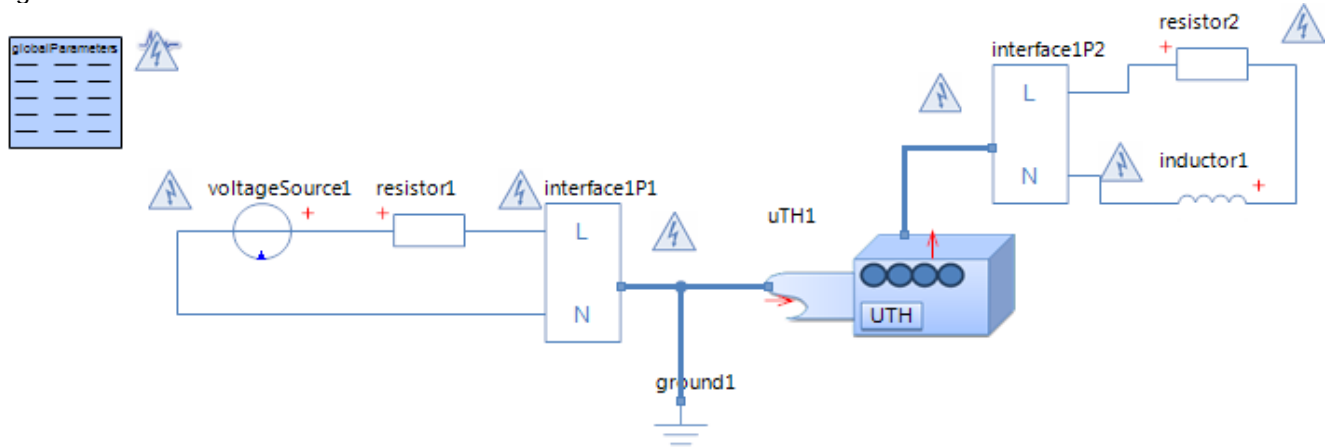

Diagram View



Voltage Source voltageSource1
Parameters

Comment	Name	Current Value	Unit
Voltage	v_src	$230 \cdot \sqrt{2} \cdot \sin(2 \cdot \pi \cdot 30 \cdot t)$	[V]

Resistor resistor1
Parameters

Comment	Name	Current Value	Unit
Resistance	R	10	[Ohm]

Resistor resistor2
Parameters

Comment	Name	Current Value	Unit
Resistance	R	100	[Ohm]

Inductor inductor1
Parameters

Comment	Name	Current Value	Unit
Inductance	L	100	[mH]
Initial Value	i0	0 (Fixed)	[A]
Kind	kind	absolute	

Umbilical Termination Head uTH1
Parameters

Comment	Name	Current Value	Unit
Poor or failing L1 connection	bL1	false	

uTH1.vIn

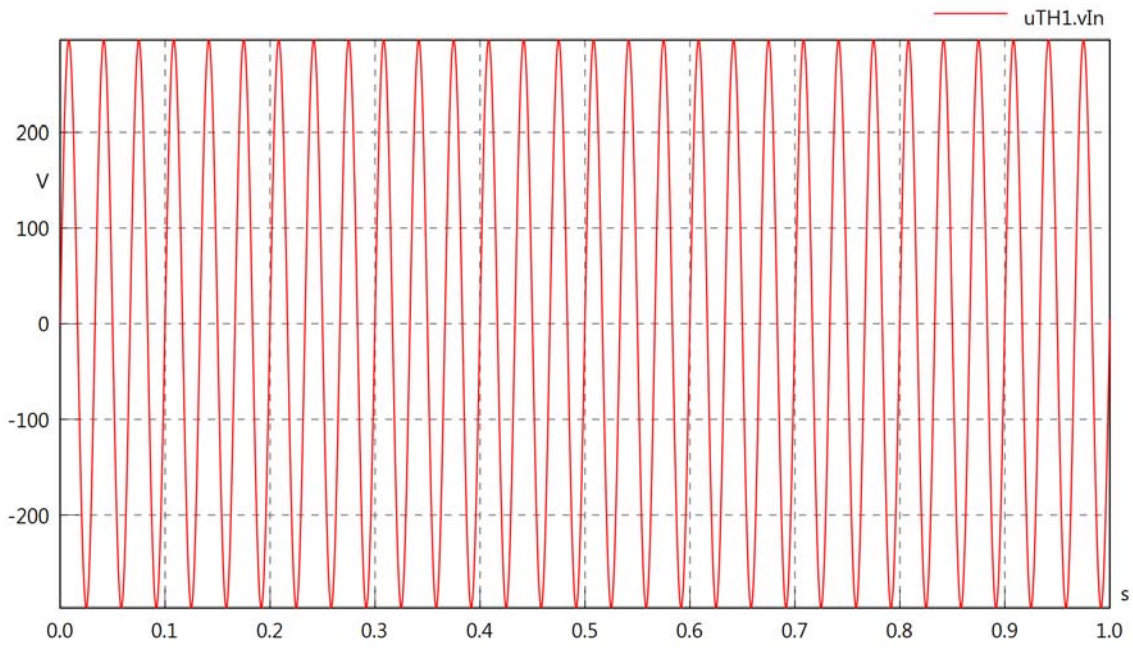

uTH1.vOut

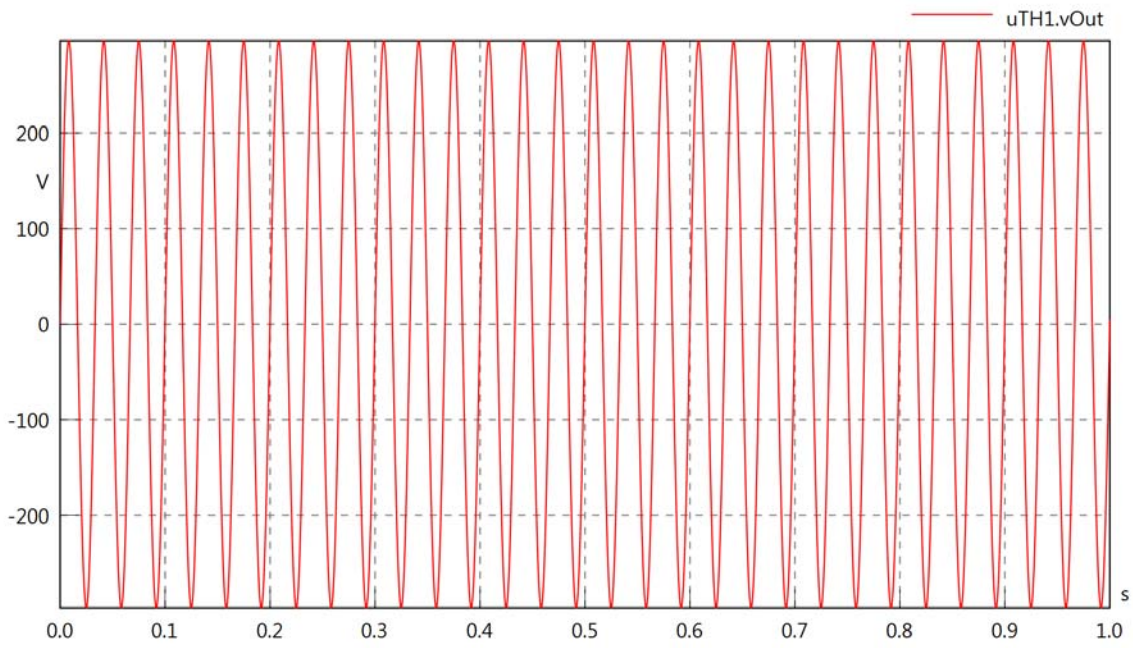

uTH1.v

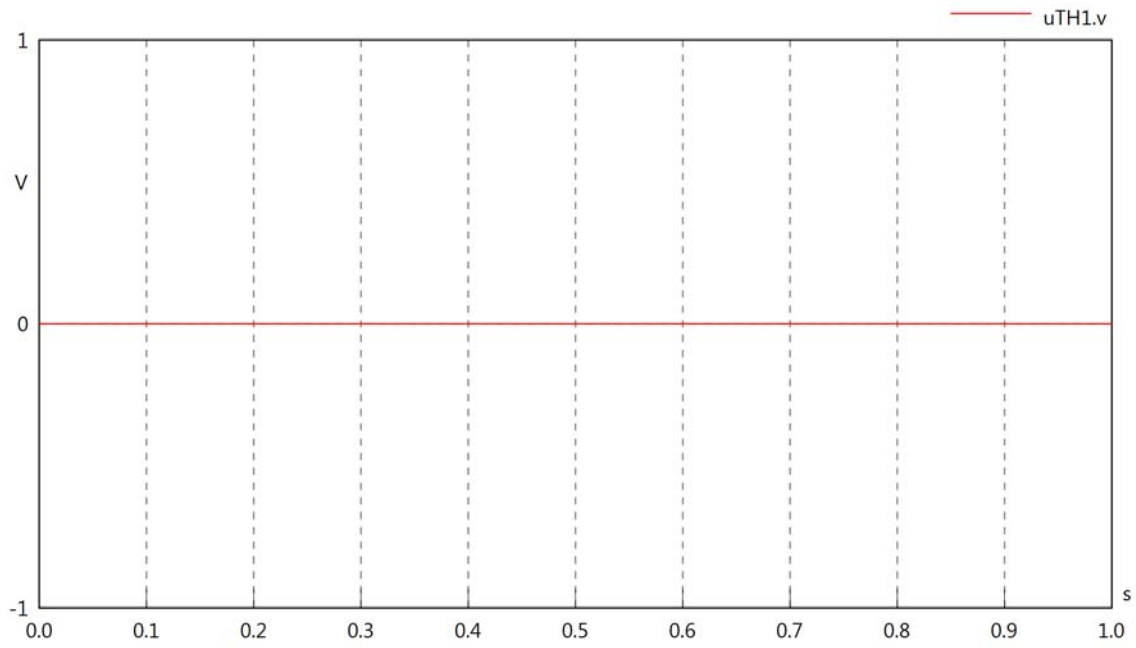

uTH1.iIn

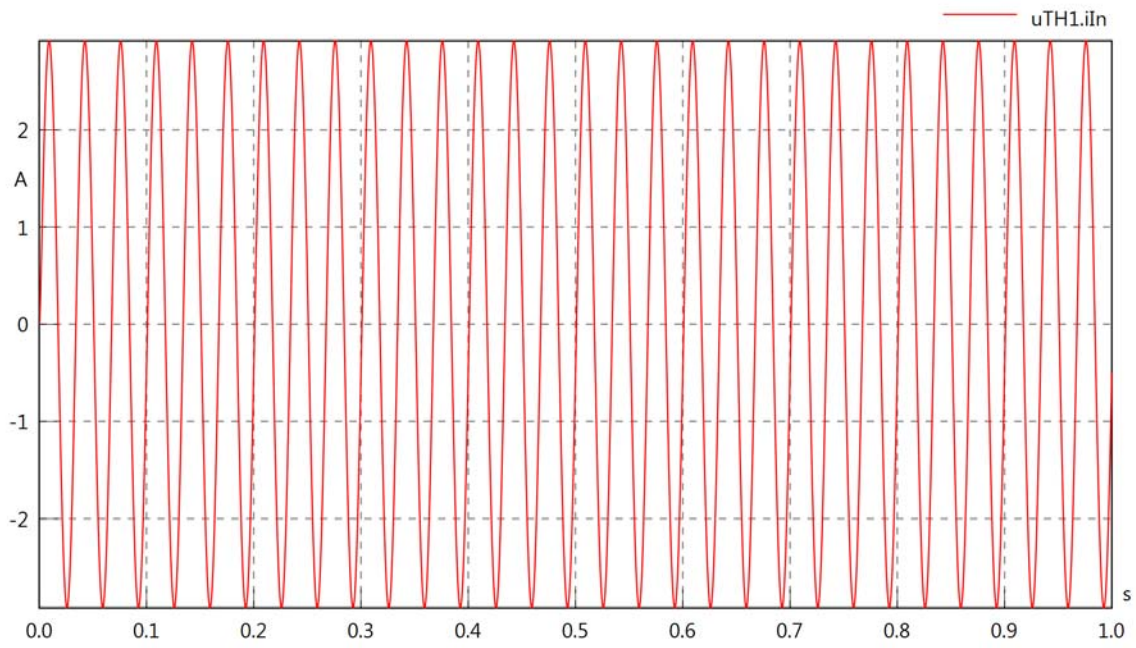

uTH1.iOut

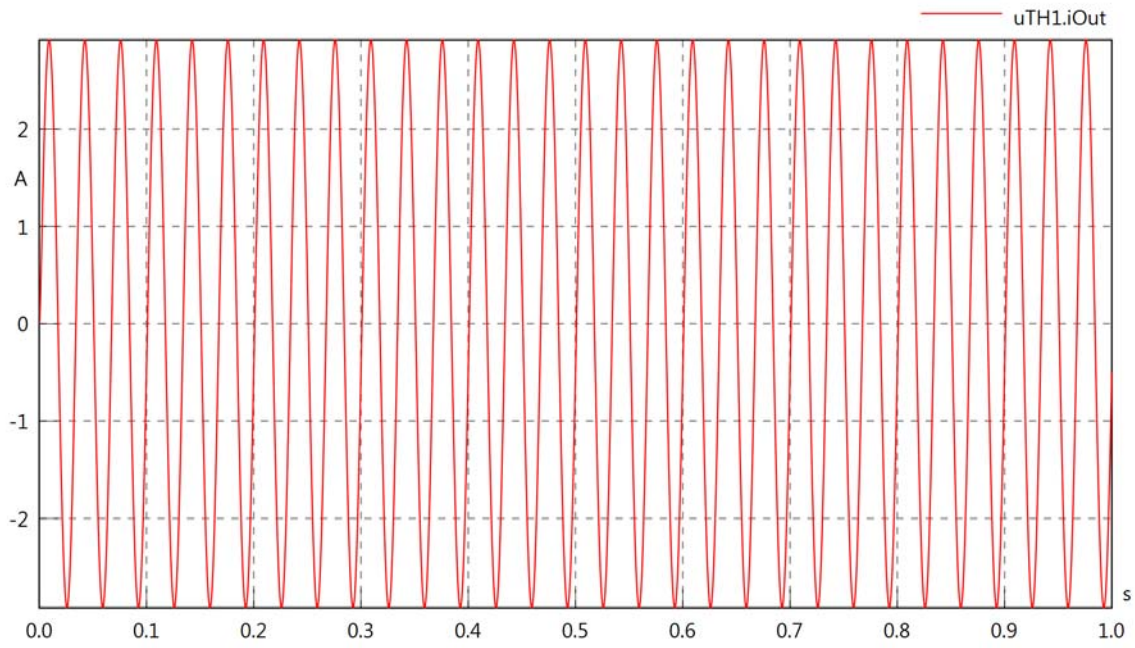

uTH1.PI

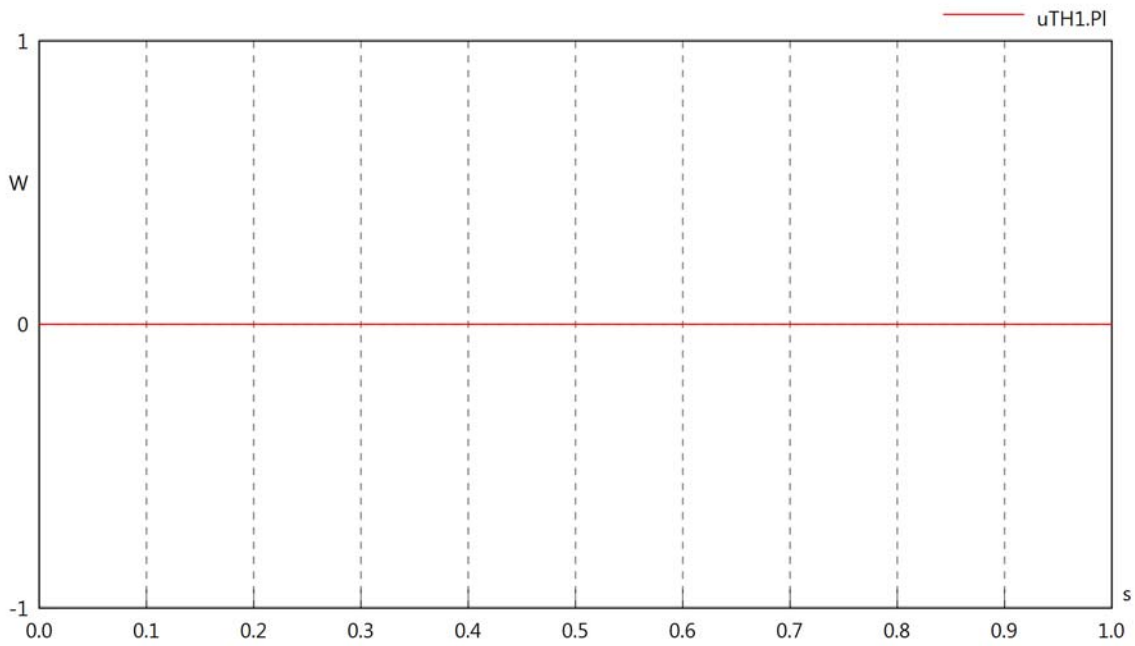
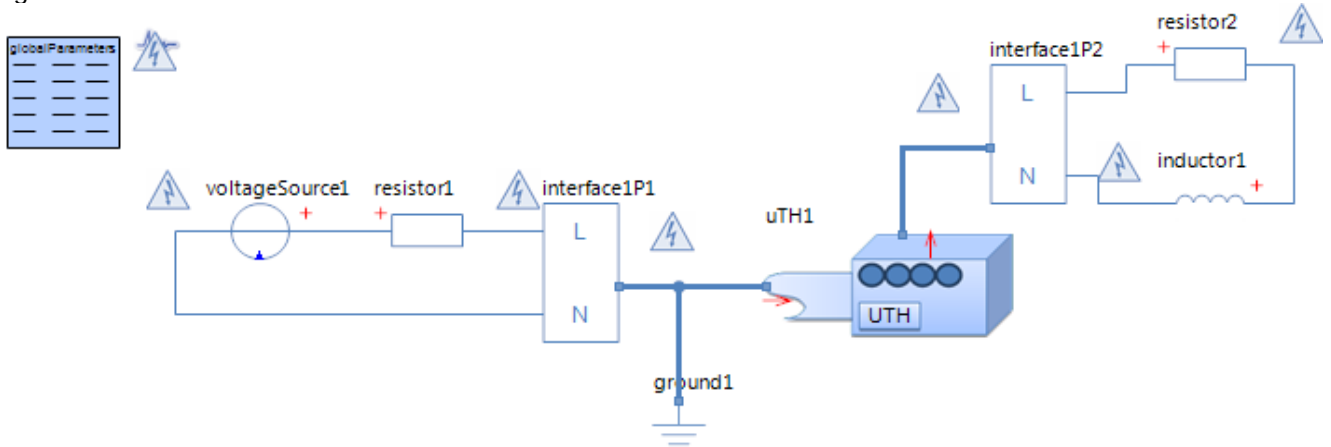

Diagram View



Voltage Source voltageSource1
Parameters

Comment	Name	Current Value	Unit
Voltage	v_src	$230 \cdot \sqrt{2} \cdot \sin(2 \cdot \pi \cdot 60 \cdot t)$	[V]

Resistor resistor1
Parameters

Comment	Name	Current Value	Unit
Resistance	R	10	[Ohm]

Resistor resistor2
Parameters

Comment	Name	Current Value	Unit
Resistance	R	100	[Ohm]

Inductor inductor1
Parameters

Comment	Name	Current Value	Unit
Inductance	L	100	[mH]
Initial Value	i0	0 (Fixed)	[A]
Kind	kind	absolute	

Umbilical Termination Head uTH1
Parameters

Comment	Name	Current Value	Unit
Poor or failing L1 connection	bL1	false	

uTH1.vIn

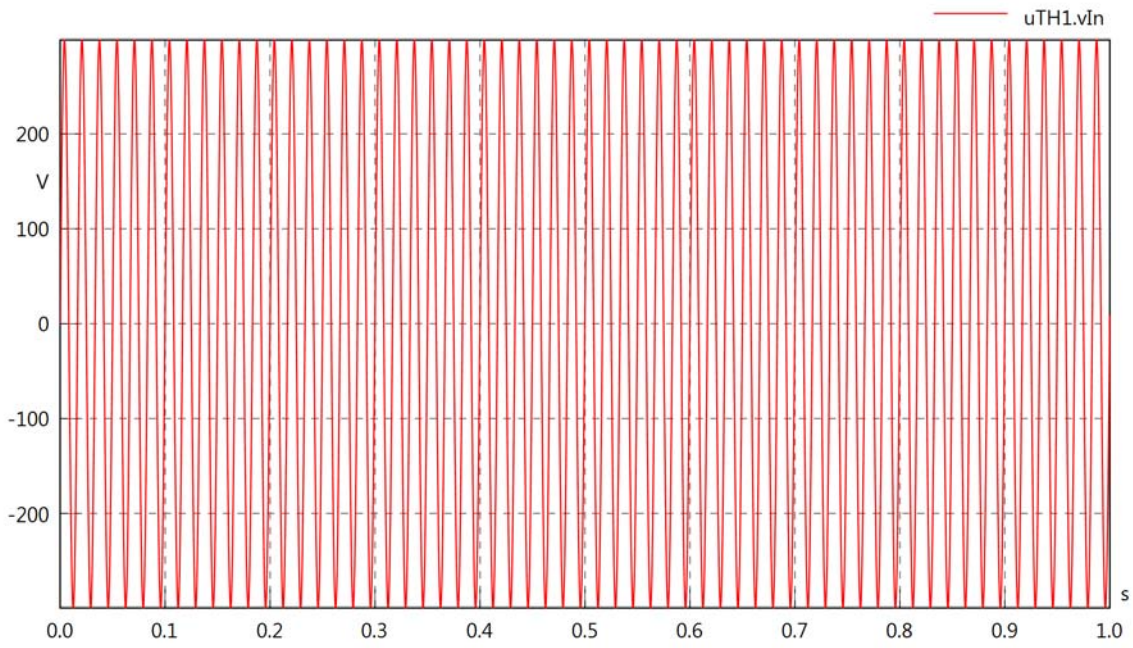

uTH1.vOut

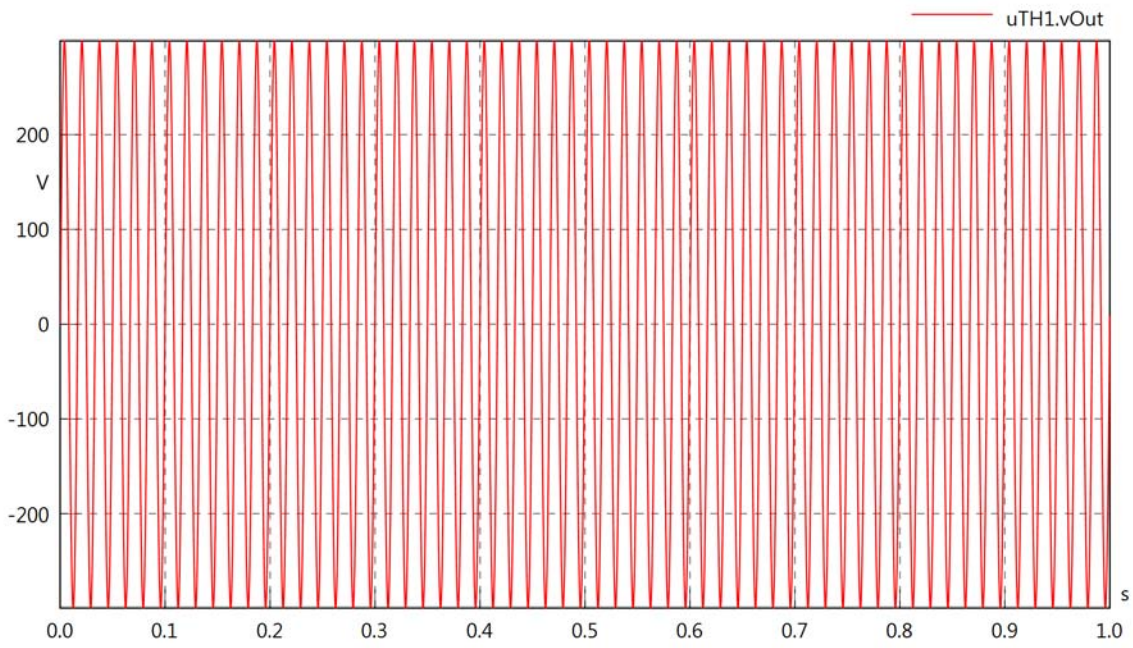

uTH1.v

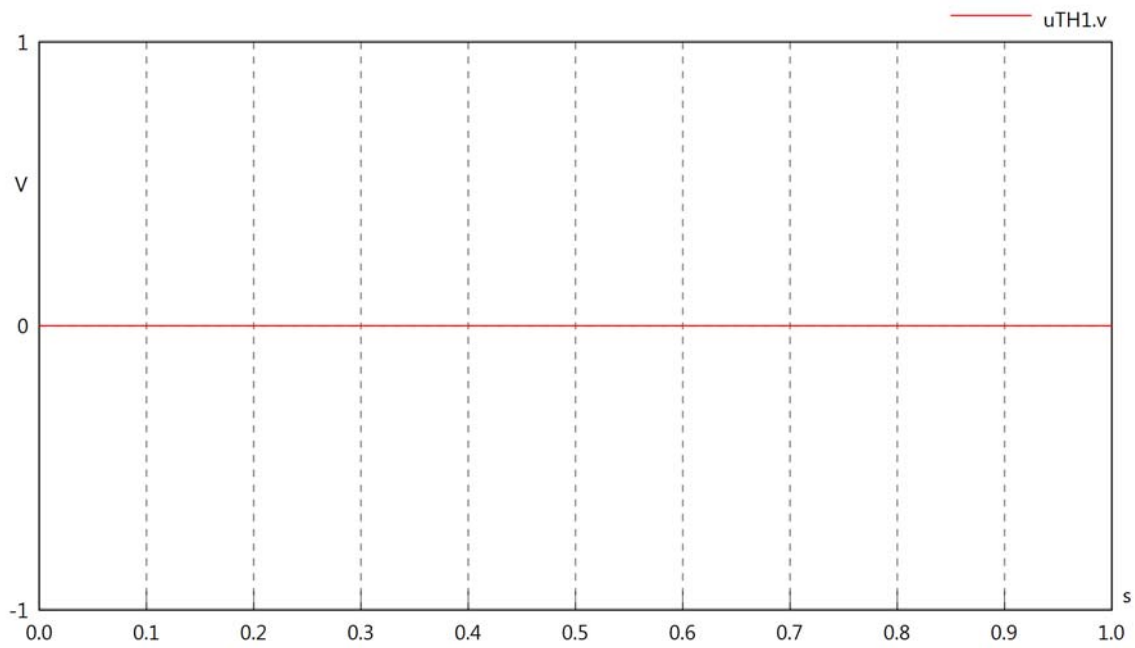

uTH1.iIn

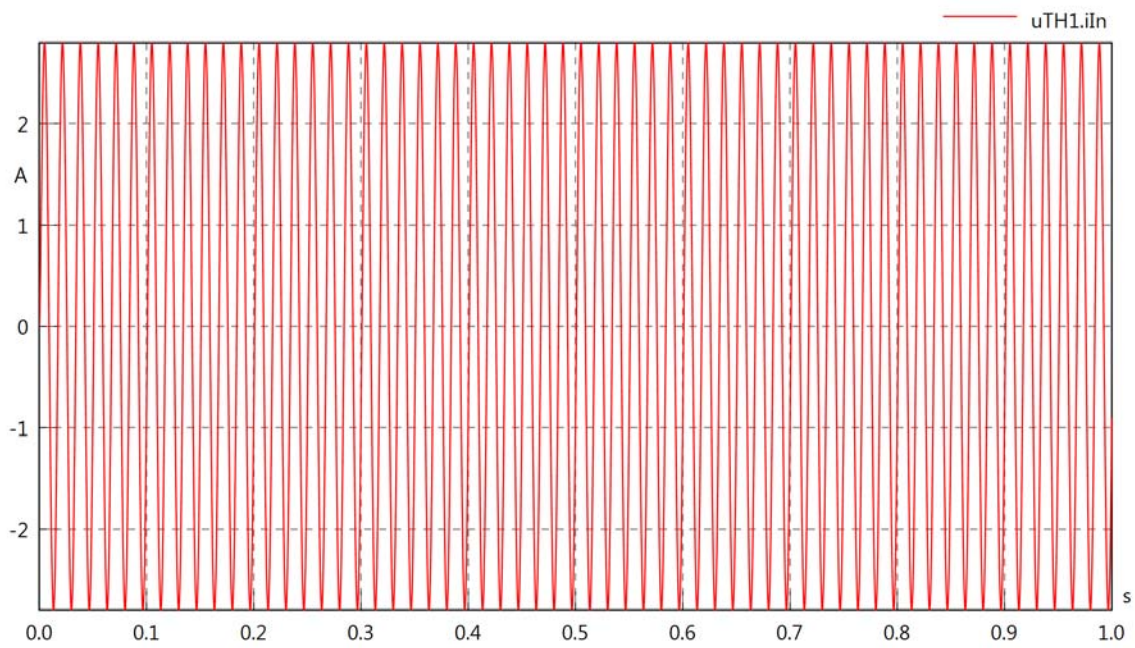

uTH1.iOut

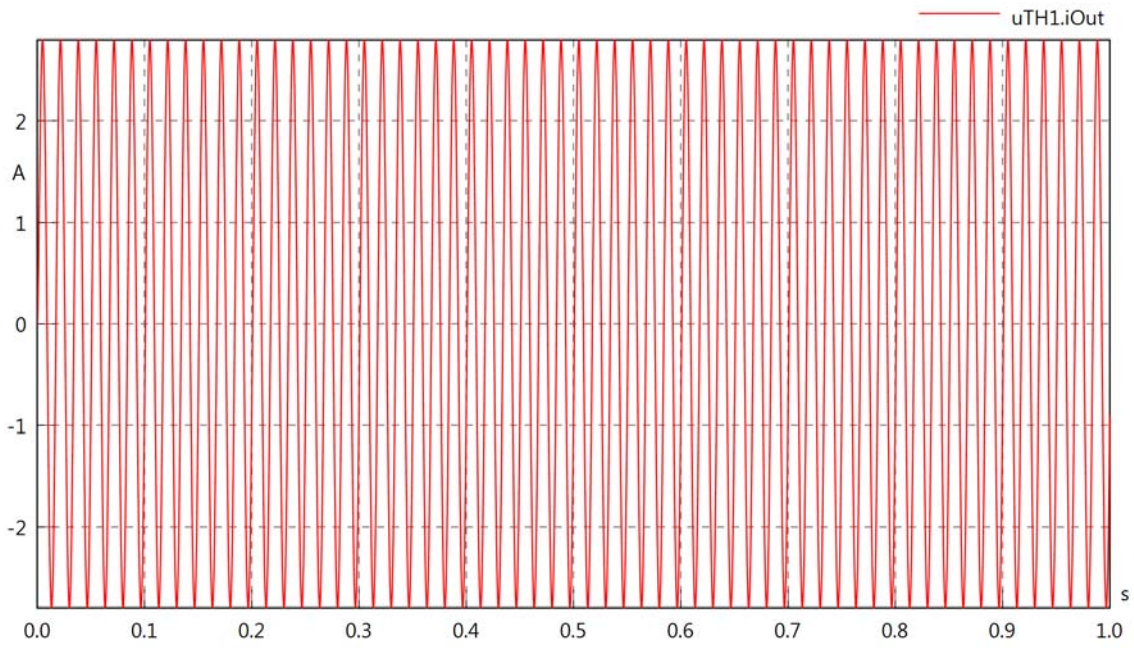

uTH1.PI

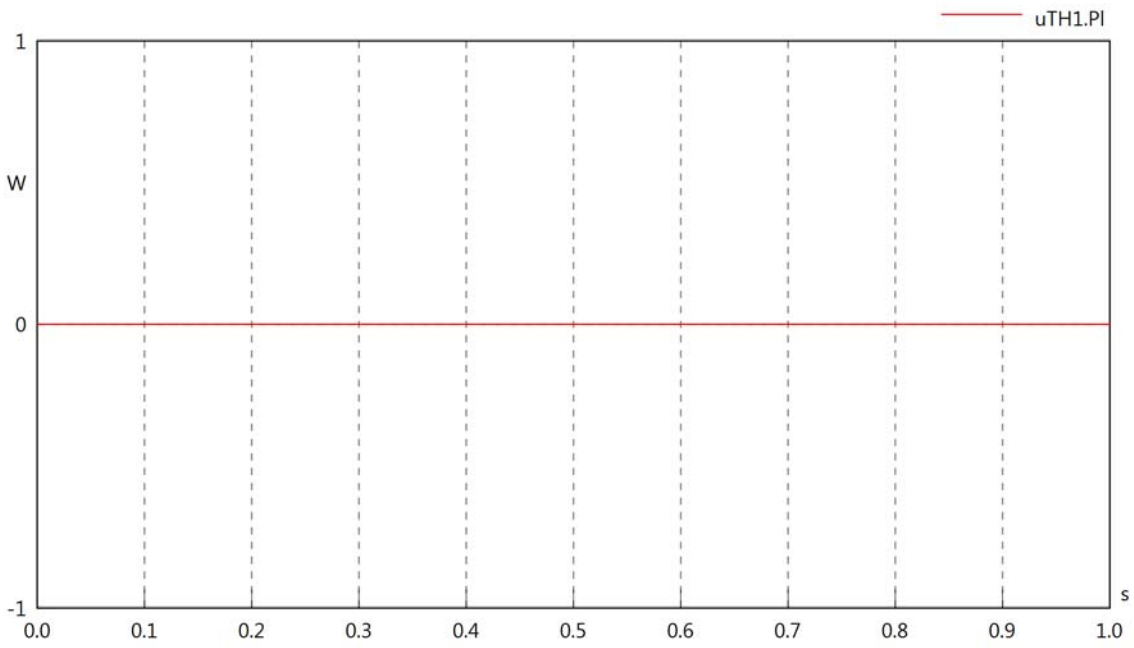
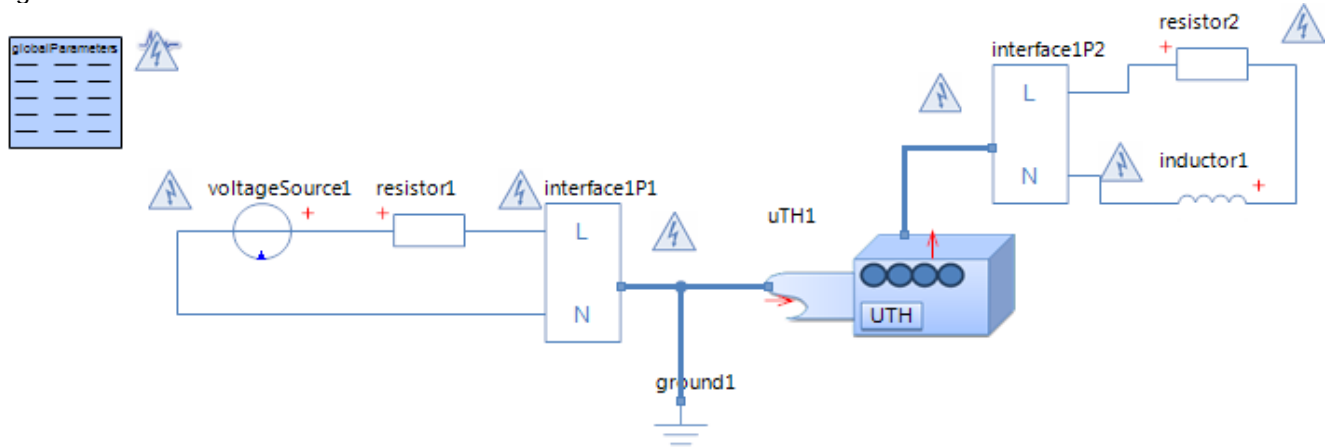

Diagram View



Voltage Source voltageSource1
Parameters

Comment	Name	Current Value	Unit
Voltage	v_src	$230 \cdot \sqrt{2} \cdot \sin(2 \cdot \pi \cdot 120 \cdot t)$	[V]

Resistor resistor1
Parameters

Comment	Name	Current Value	Unit
Resistance	R	10	[Ohm]

Resistor resistor2
Parameters

Comment	Name	Current Value	Unit
Resistance	R	100	[Ohm]

Inductor inductor1
Parameters

Comment	Name	Current Value	Unit
Inductance	L	100	[mH]
Initial Value	i0	0 (Fixed)	[A]
Kind	kind	absolute	

Umbilical Termination Head uTH1
Parameters

Comment	Name	Current Value	Unit
Poor or failing L1 connection	bL1	false	

uTH1.vIn

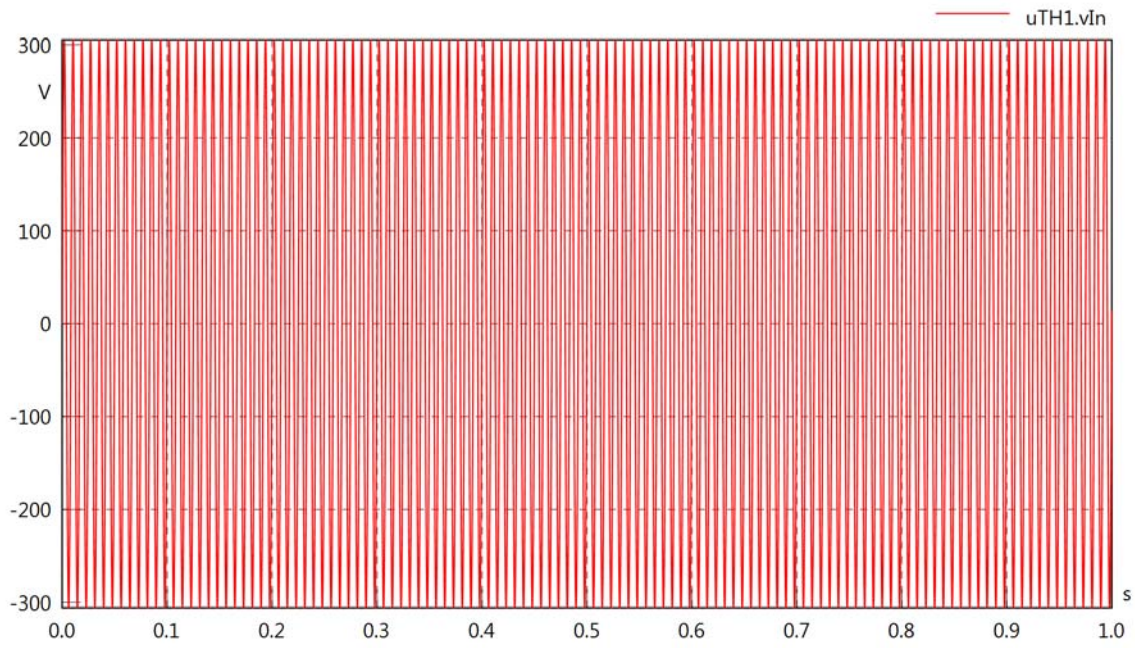

uTH1.vOut

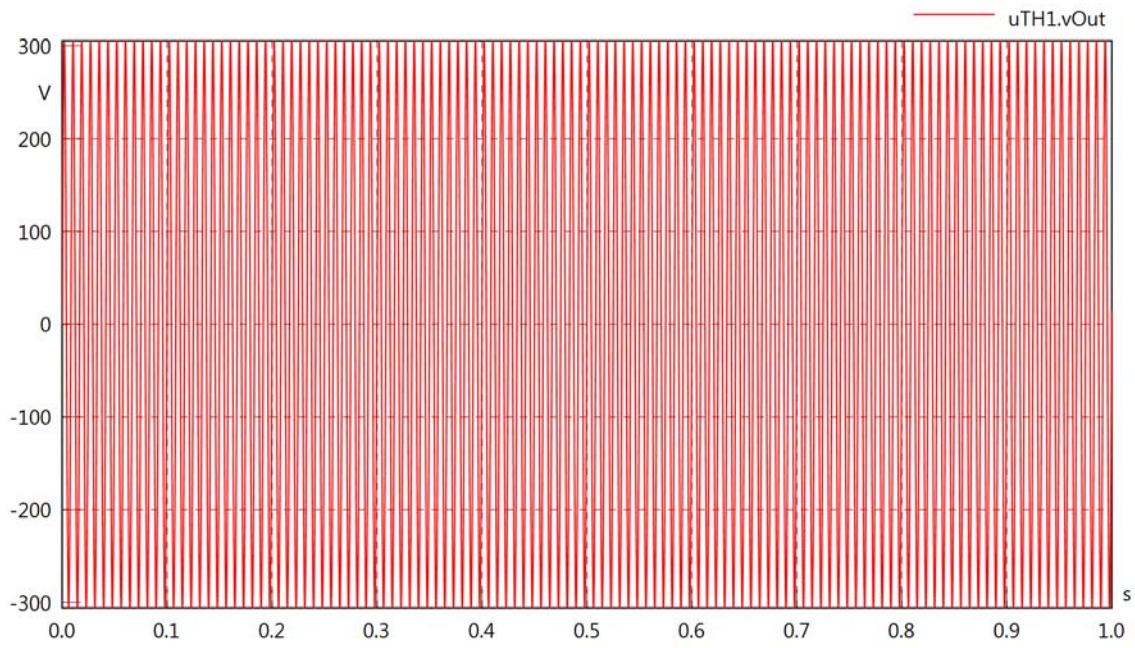

uTH1.v

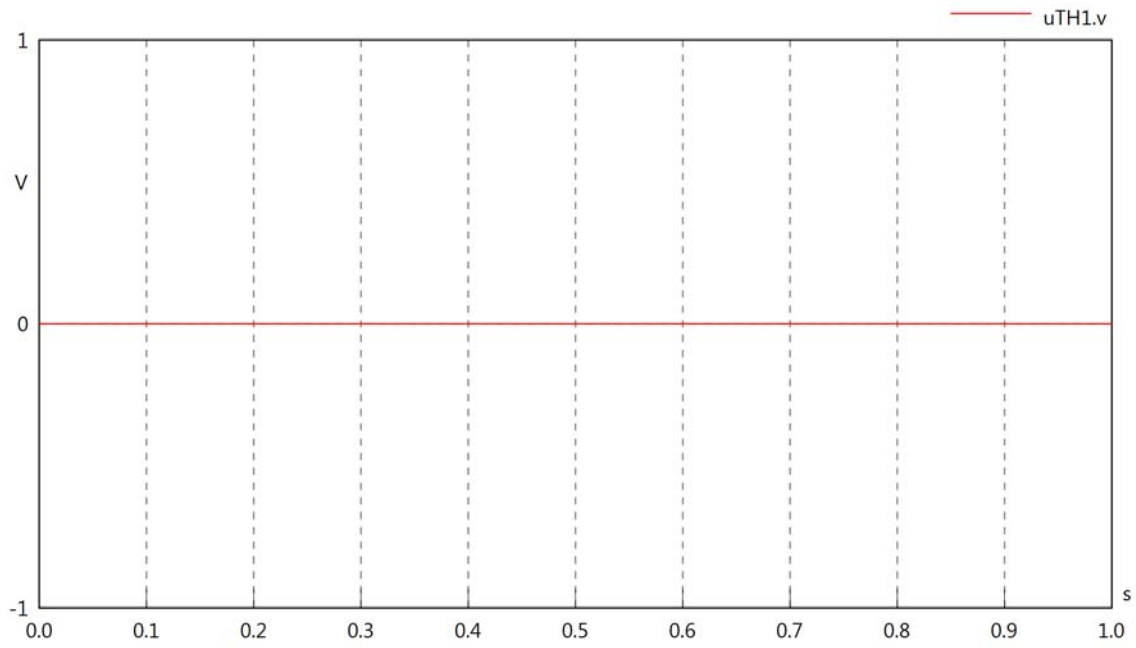

uTH1.iIn

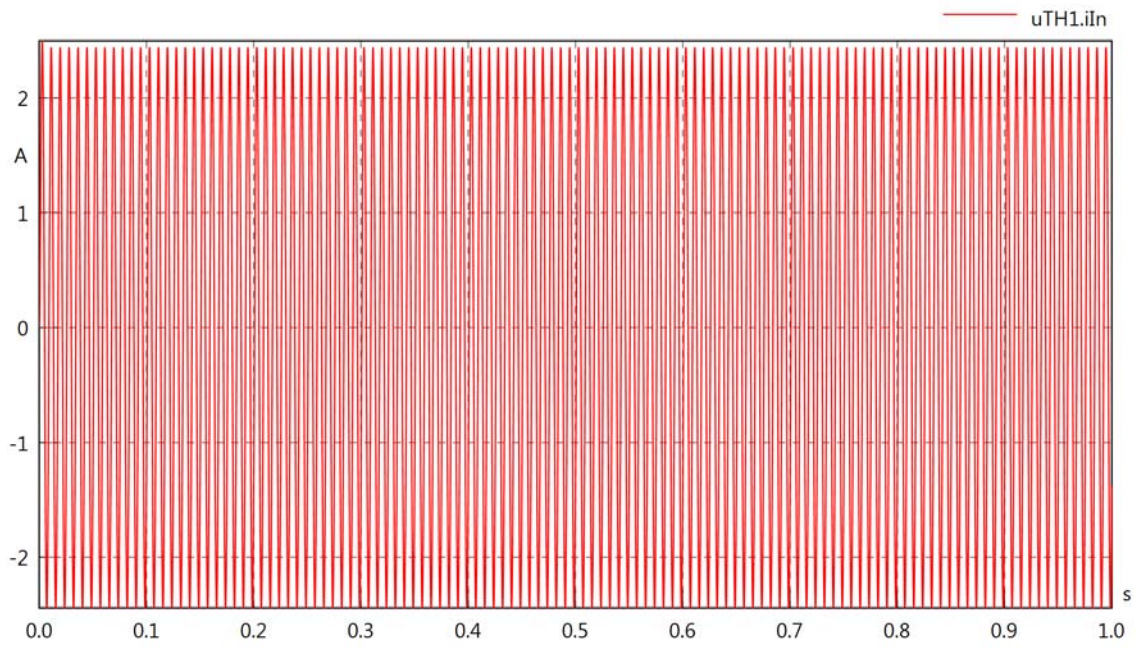

uTH1.iOut

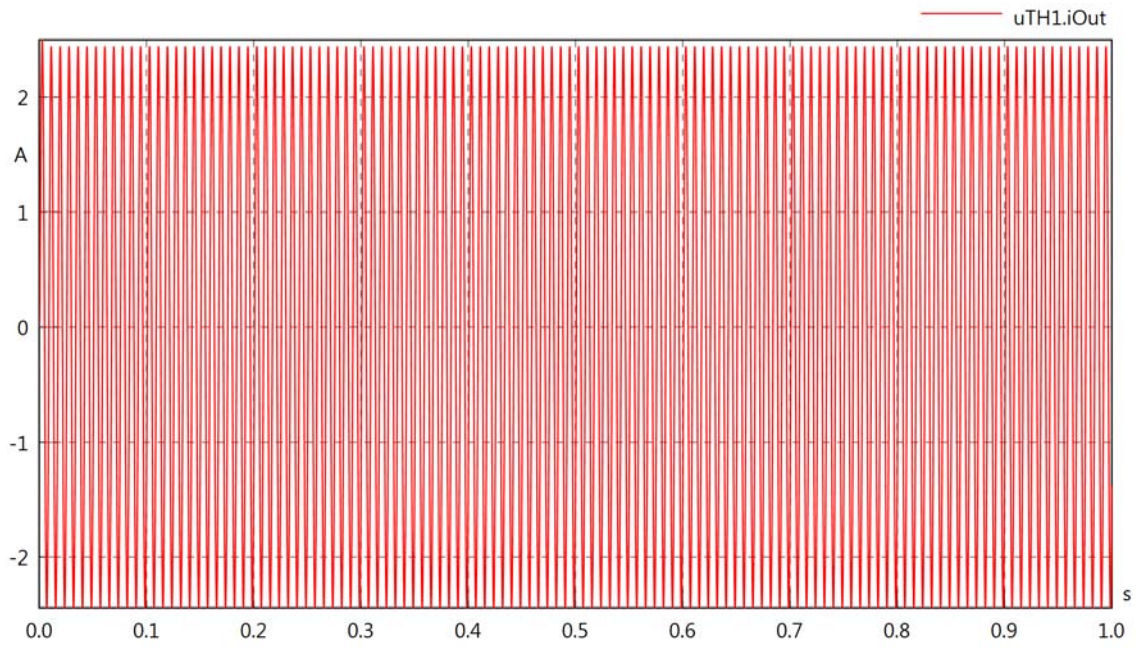

uTH1.PI

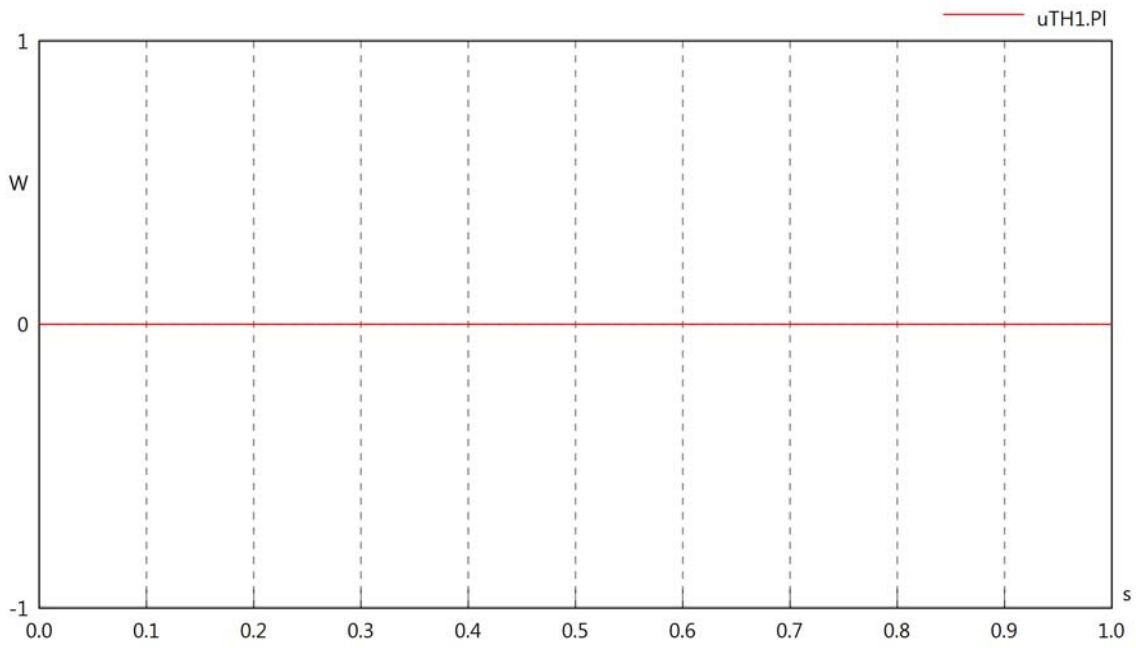
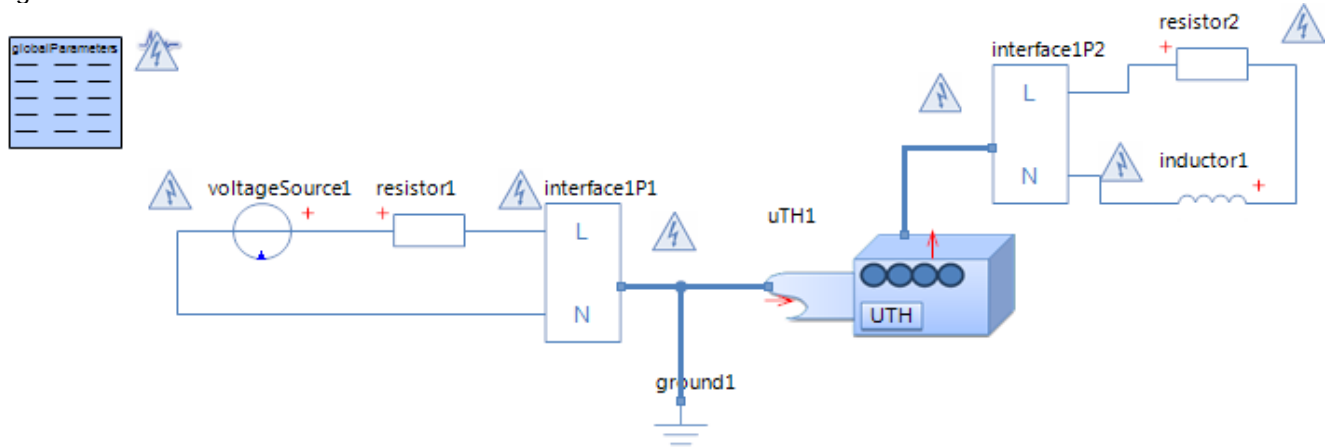

Diagram View



Voltage Source voltageSource1
Parameters

Comment	Name	Current Value	Unit
Voltage	v_src	$230 \cdot \sqrt{2} \cdot \sin(2 \cdot \pi \cdot 30 \cdot t)$	[V]

Resistor resistor1
Parameters

Comment	Name	Current Value	Unit
Resistance	R	10	[Ohm]

Resistor resistor2
Parameters

Comment	Name	Current Value	Unit
Resistance	R	100	[Ohm]

Inductor inductor1
Parameters

Comment	Name	Current Value	Unit
Inductance	L	100	[mH]
Initial Value	i0	0 (Fixed)	[A]
Kind	kind	absolute	

Umbilical Termination Head uTH1
Parameters

Comment	Name	Current Value	Unit
Poor or failing L1 connection	bL1	true	
Resistance in L1 connection	rL1	1	[kOhm]
Conductance between L1 and N	G	50	[1/Ohm]

uTH1.vIn

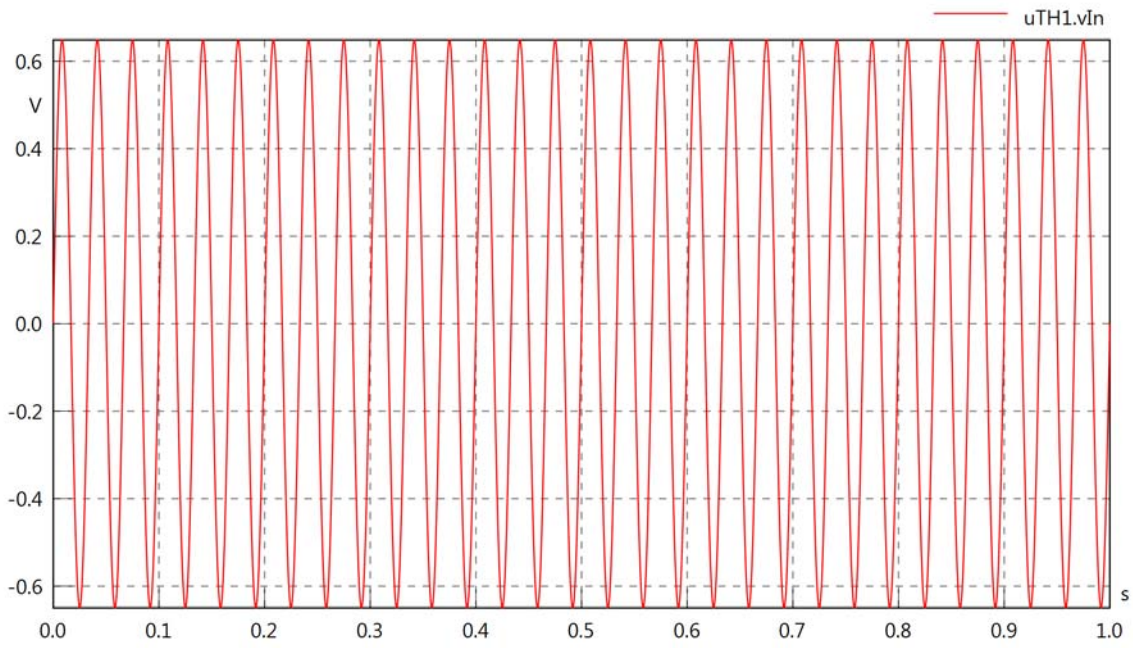

uTH1.vOut

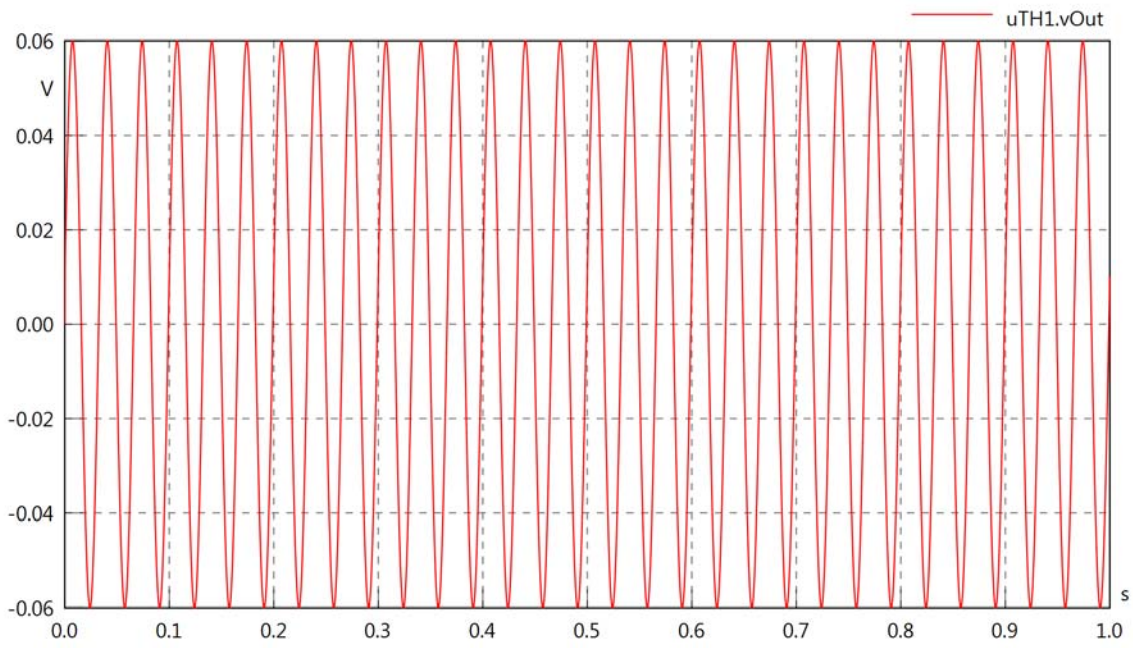

uTH1.v

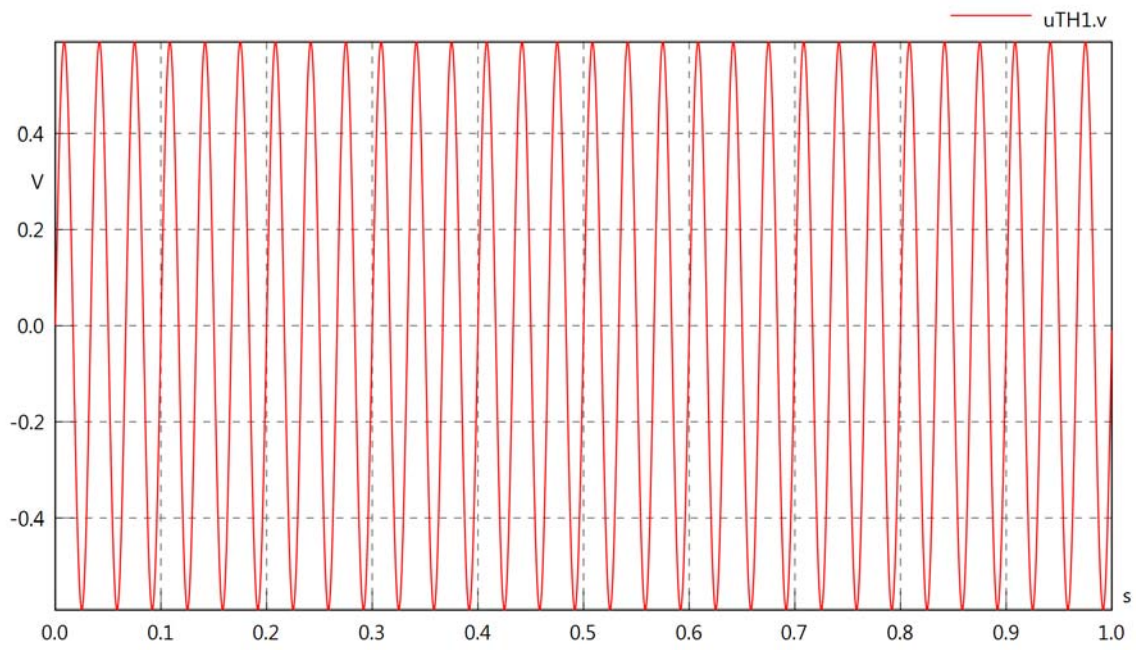

uTH1.iIn

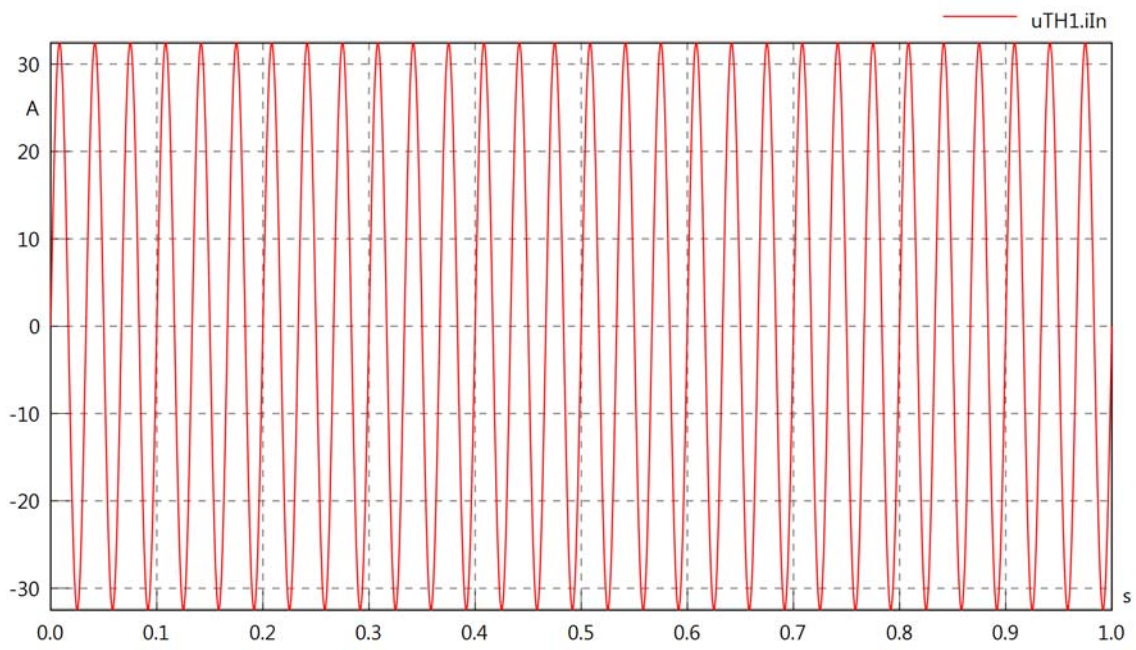

uTH1.iOut

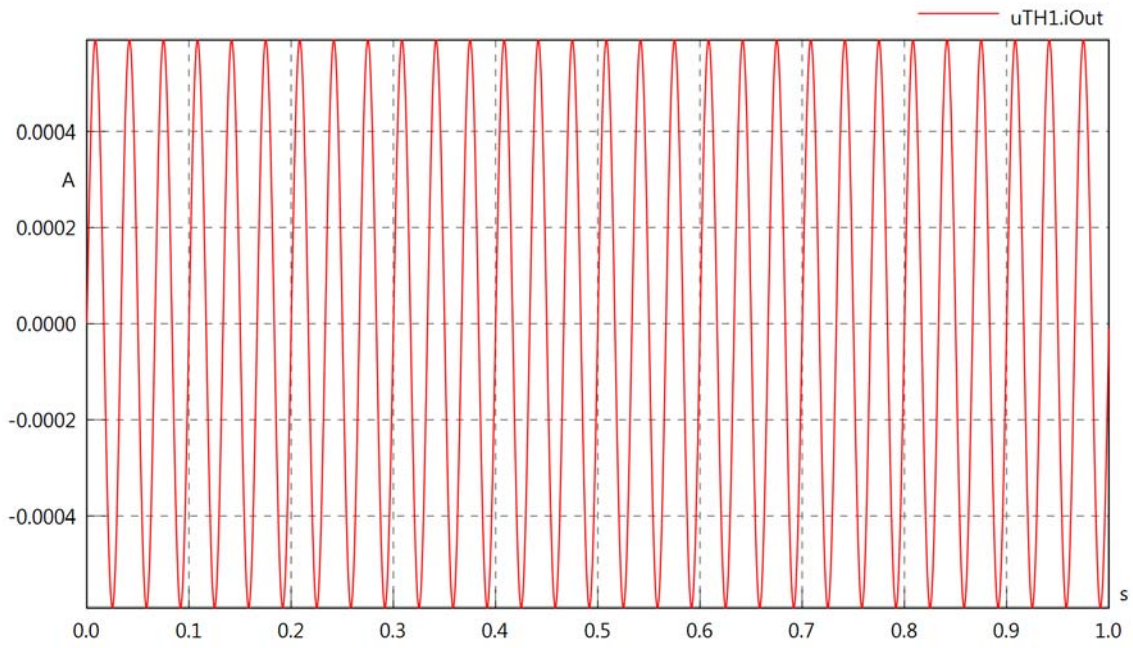

uTH1.PI

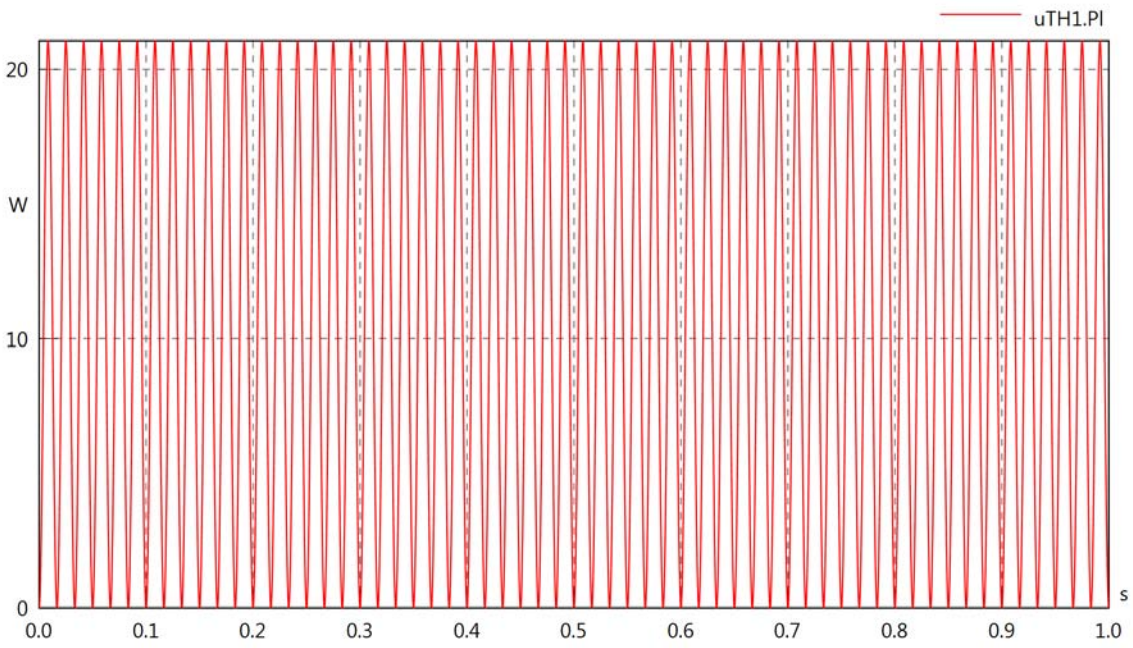
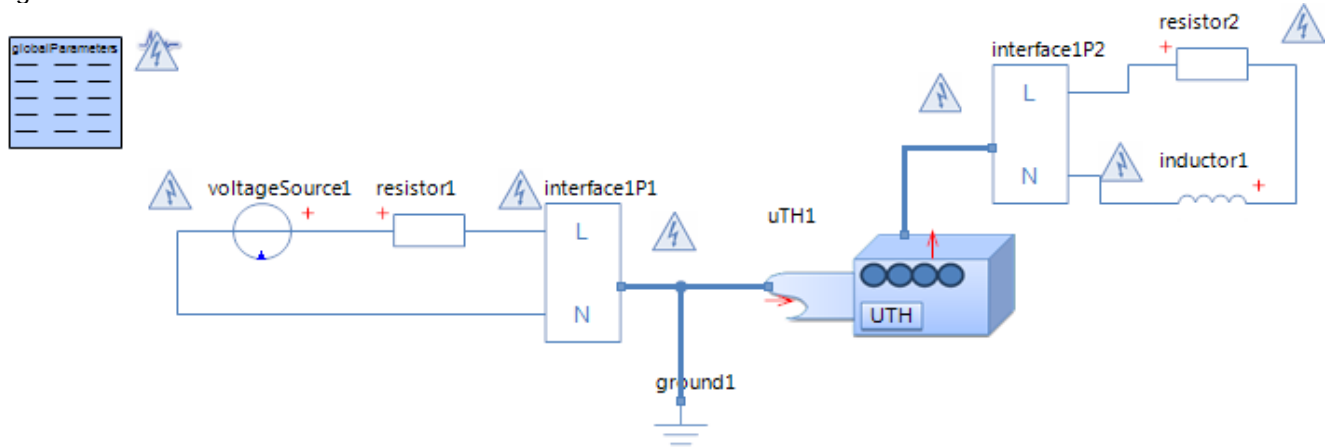

Diagram View



Voltage Source voltageSource1
Parameters

Comment	Name	Current Value	Unit
Voltage	v_src	$230 \cdot \sqrt{2} \cdot \sin(2 \cdot \pi \cdot 60 \cdot t)$	[V]

Resistor resistor1
Parameters

Comment	Name	Current Value	Unit
Resistance	R	10	[Ohm]

Resistor resistor2
Parameters

Comment	Name	Current Value	Unit
Resistance	R	100	[Ohm]

Inductor inductor1
Parameters

Comment	Name	Current Value	Unit
Inductance	L	100	[mH]
Initial Value	i0	0 (Fixed)	[A]
Kind	kind	absolute	

Umbilical Termination Head uTH1
Parameters

Comment	Name	Current Value	Unit
Poor or failing L1 connection	bL1	true	
Resistance in L1 connection	rL1	1	[kOhm]
Conductance between L1 and N	G	50	[1/Ohm]

uTH1.vIn

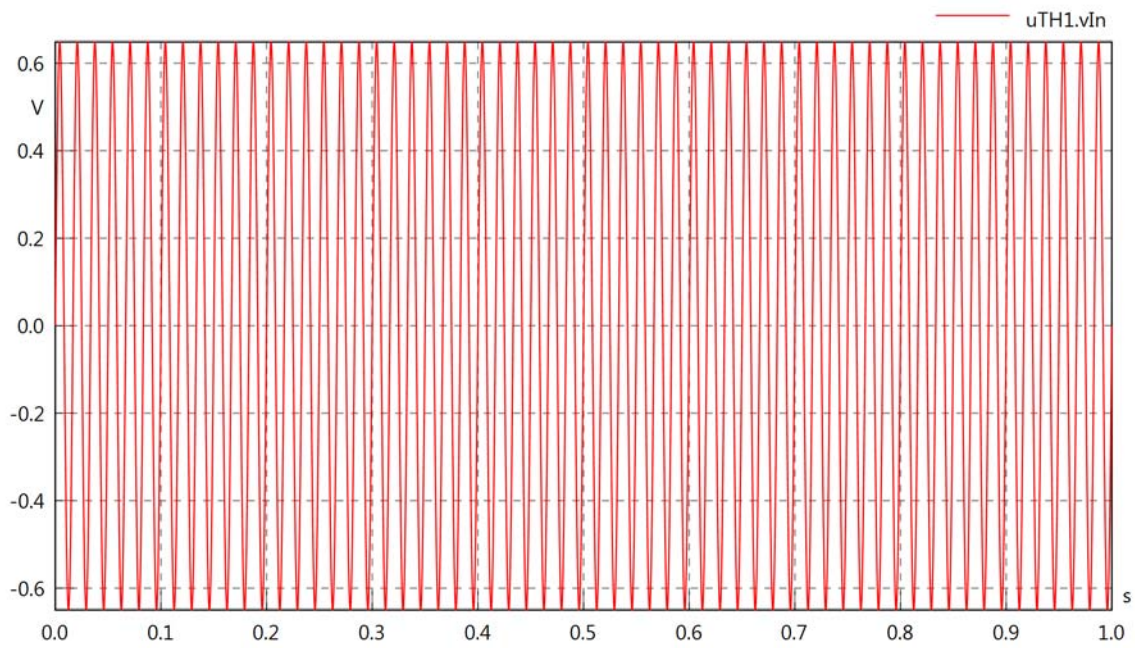

uTH1.vOut

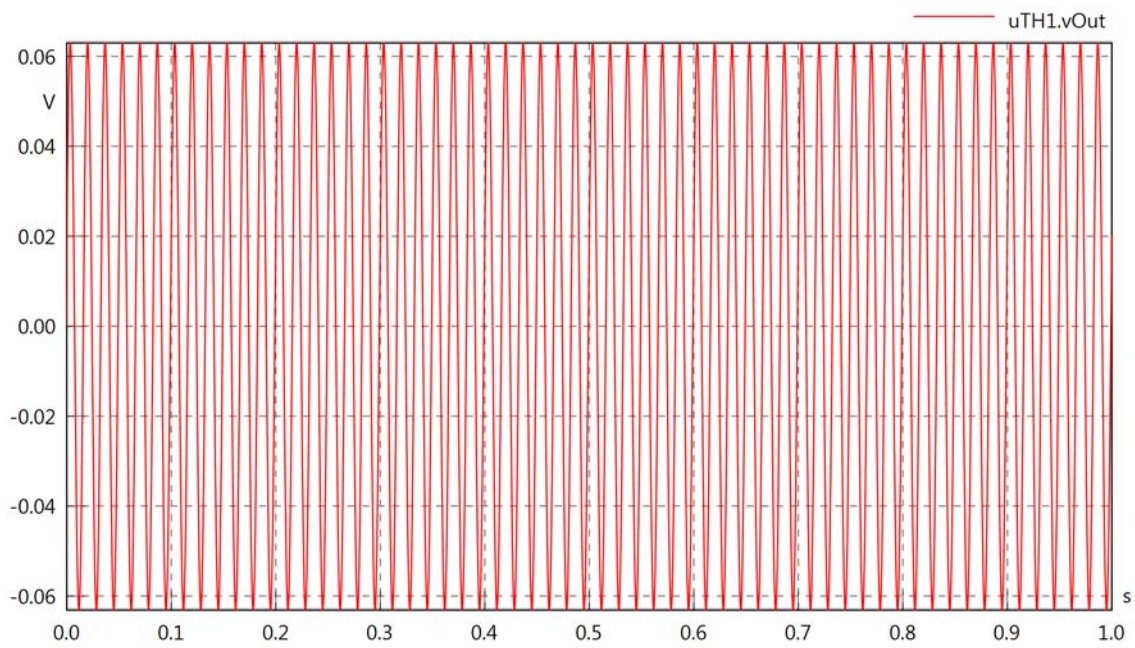

uTH1.v

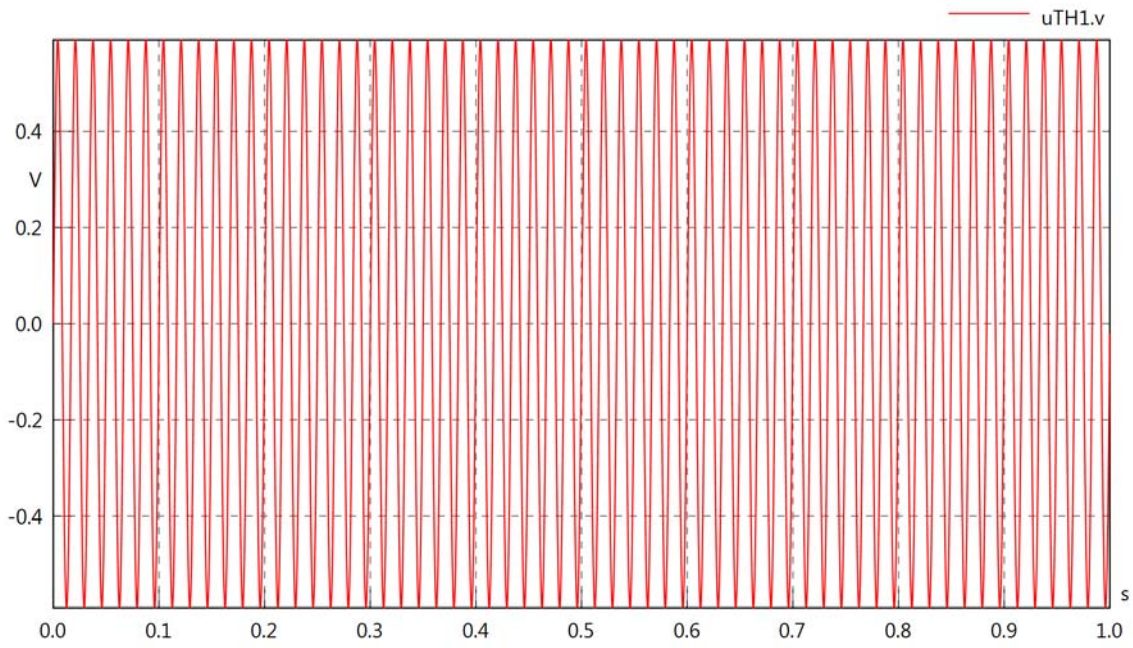

uTH1.iIn

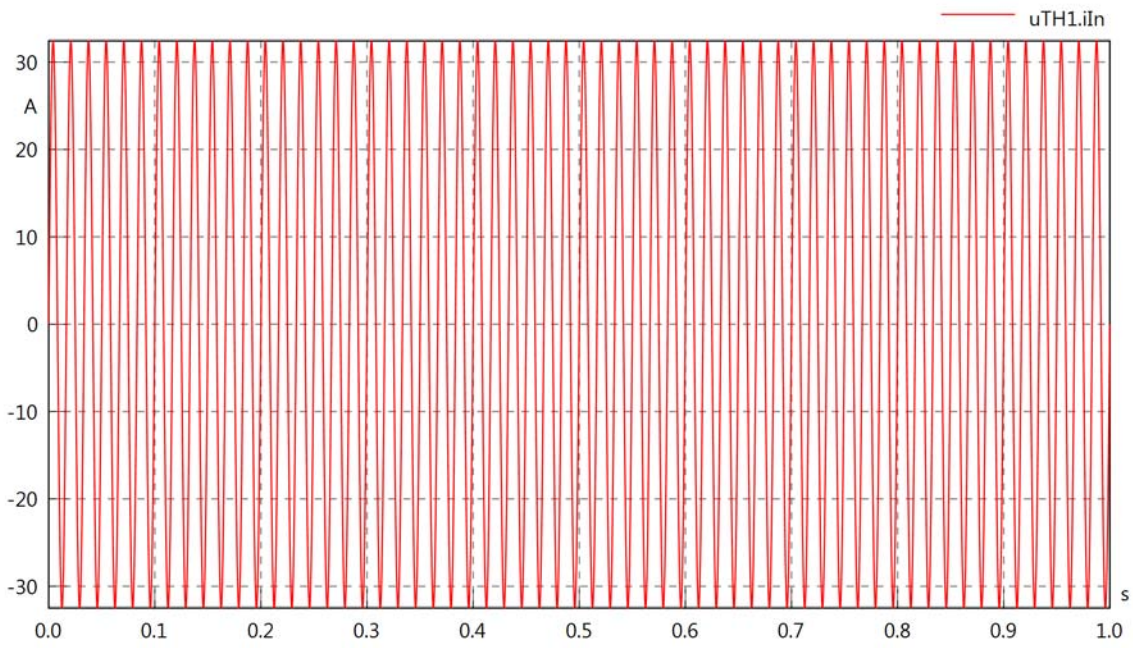

uTH1.iOut

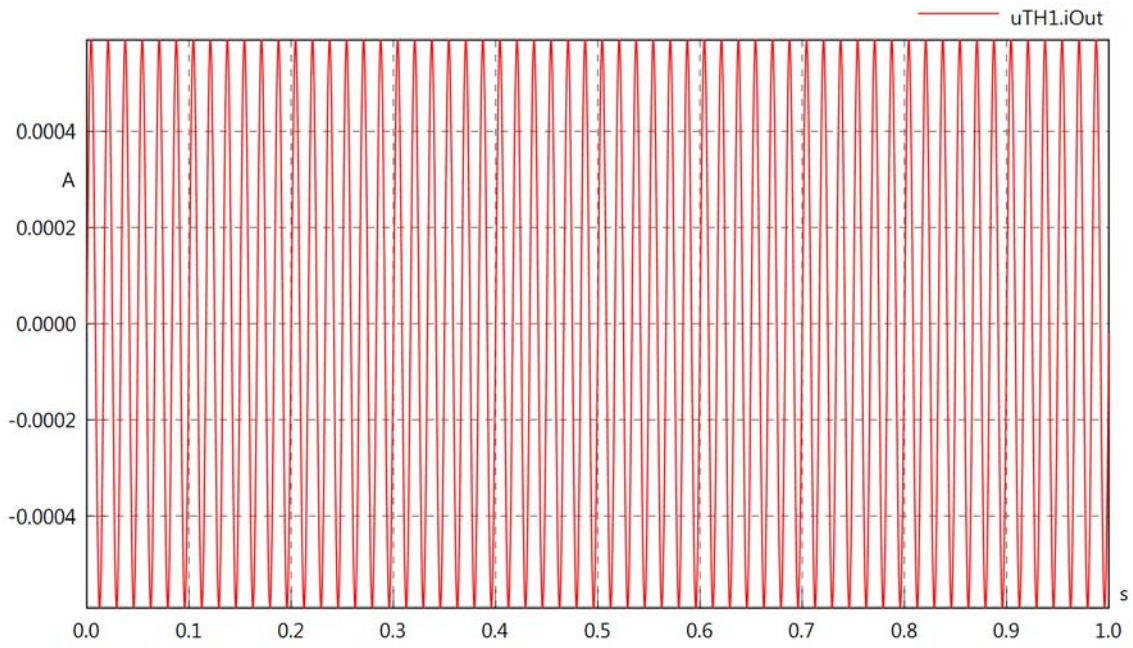

uTH1.PI

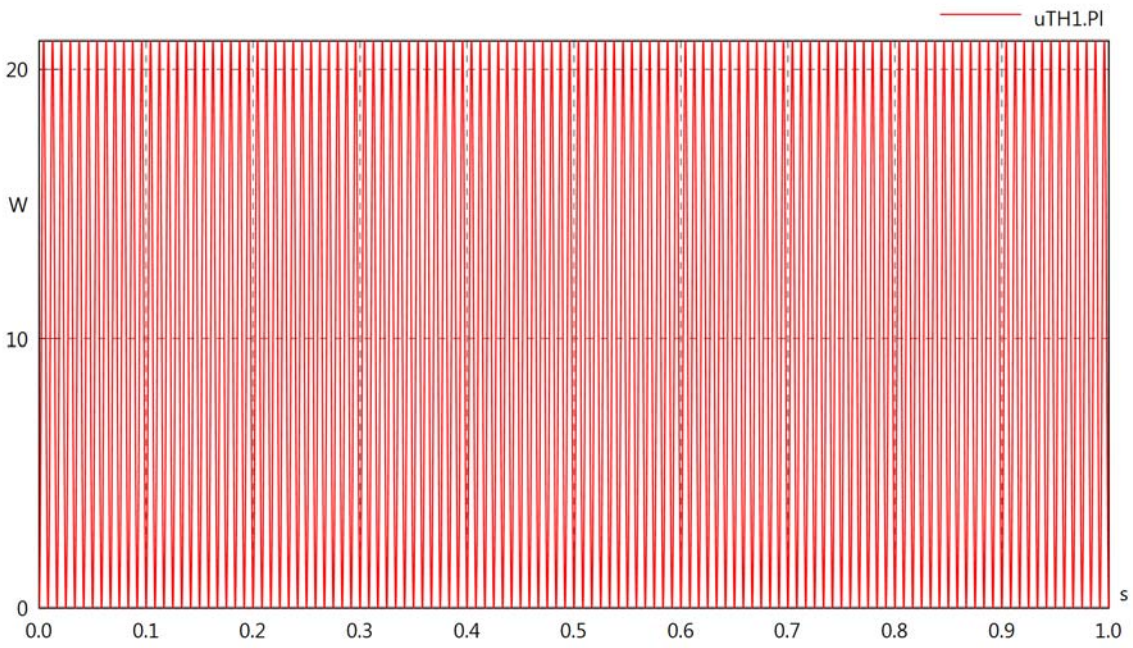
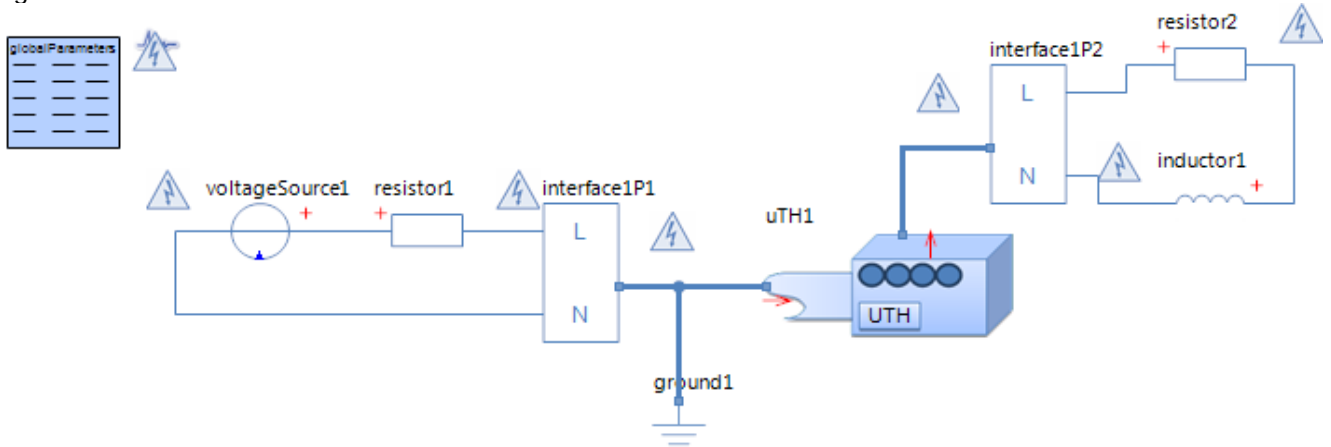

Diagram View



Voltage Source voltageSource1
Parameters

Comment	Name	Current Value	Unit
Voltage	v_src	$230 \cdot \sqrt{2} \cdot \sin(2 \cdot \pi \cdot 120 \cdot t)$	[V]

Resistor resistor1
Parameters

Comment	Name	Current Value	Unit
Resistance	R	10	[Ohm]

Resistor resistor2
Parameters

Comment	Name	Current Value	Unit
Resistance	R	100	[Ohm]

Inductor inductor1
Parameters

Comment	Name	Current Value	Unit
Inductance	L	100	[mH]
Initial Value	i0	0 (Fixed)	[A]
Kind	kind	absolute	

Umbilical Termination Head uTH1
Parameters

Comment	Name	Current Value	Unit
Poor or failing L1 connection	bL1	true	
Resistance in L1 connection	rL1	1	[kOhm]
Conductance between L1 and N	G	50	[1/Ohm]

uTH1.vIn

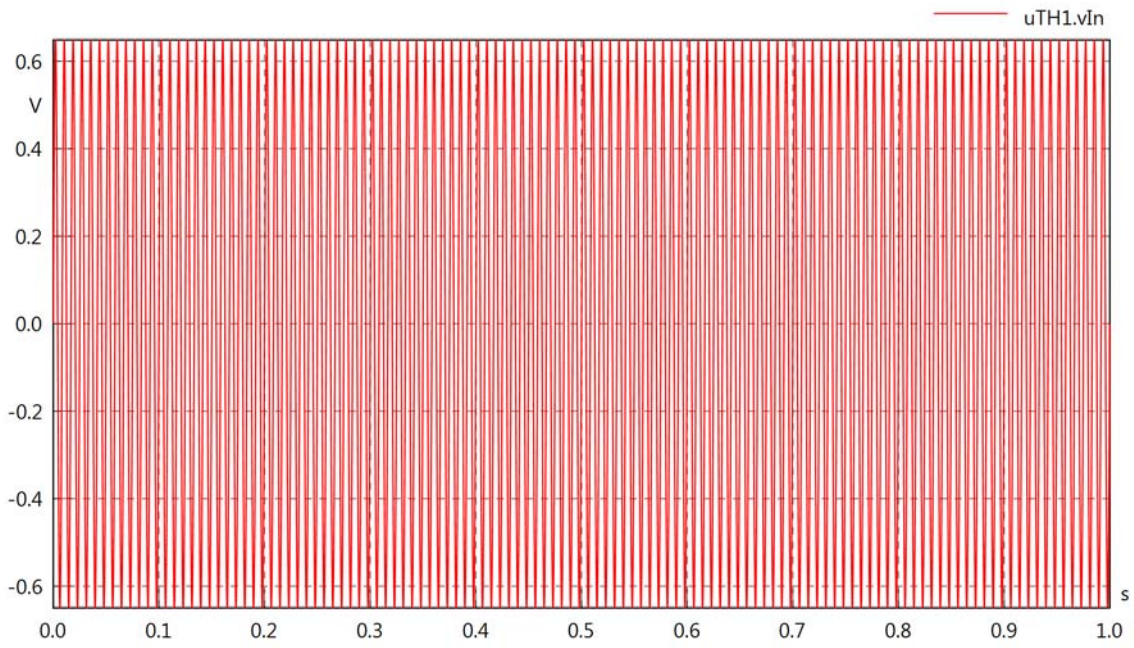

uTH1.vOut

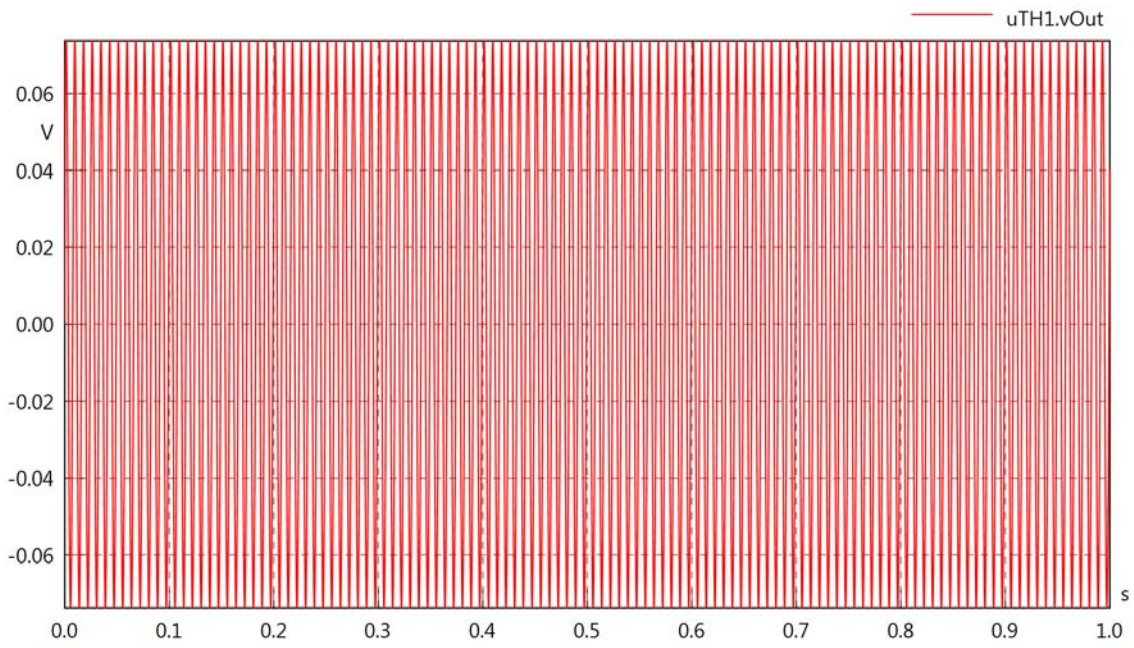

uTH1.v

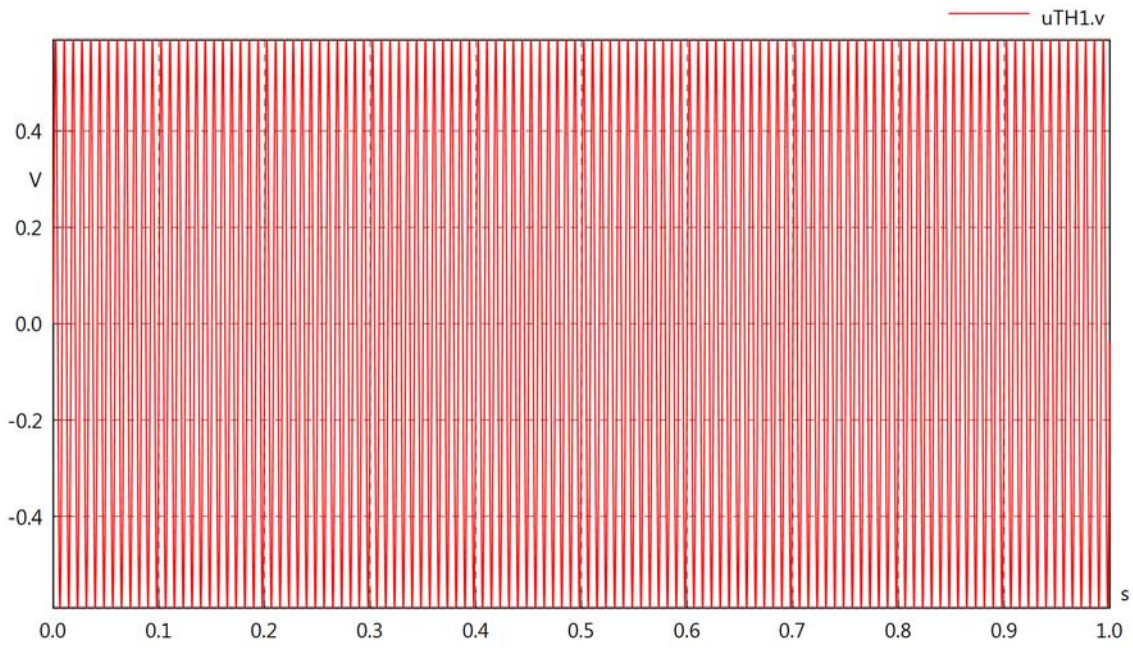

uTH1.iIn

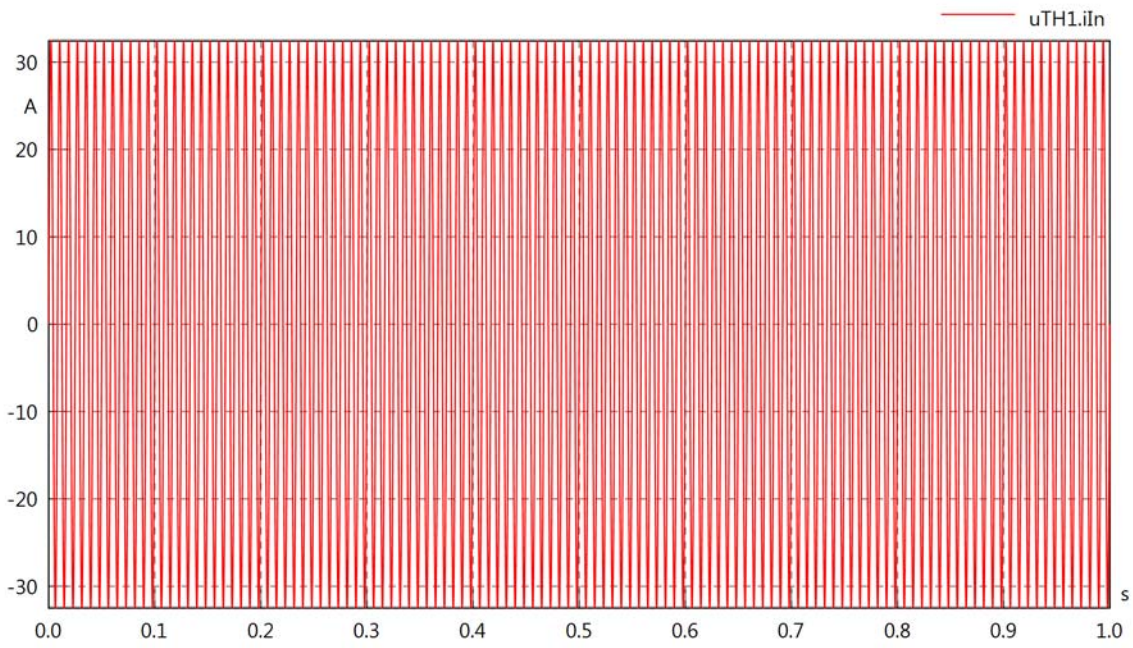

uTH1.iOut

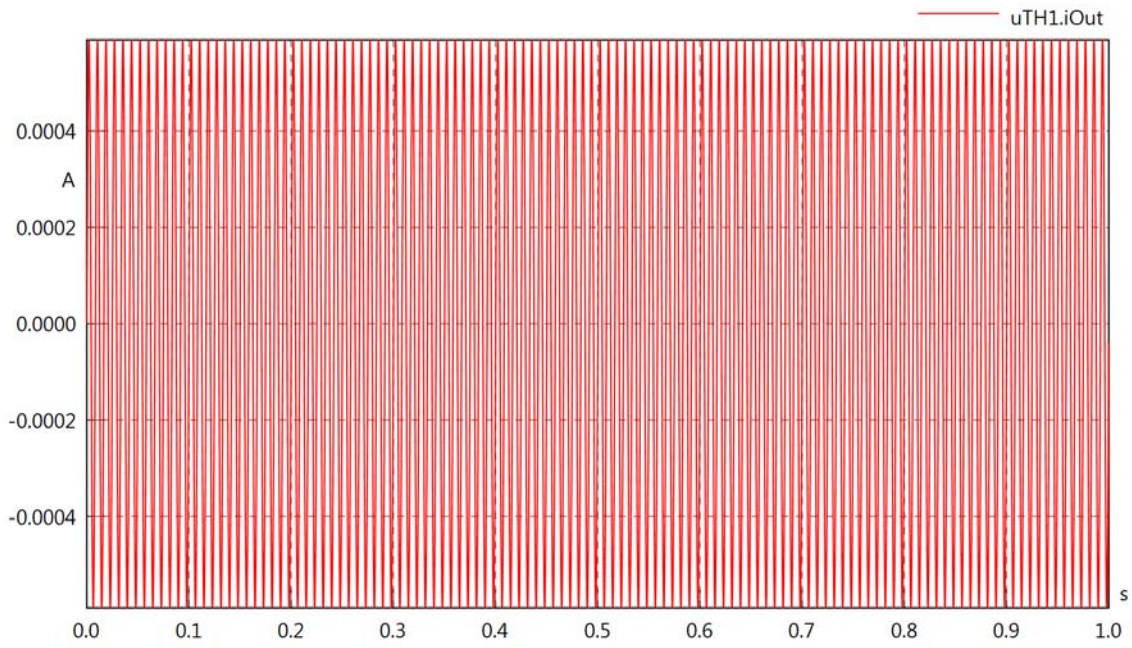

uTH1.PI

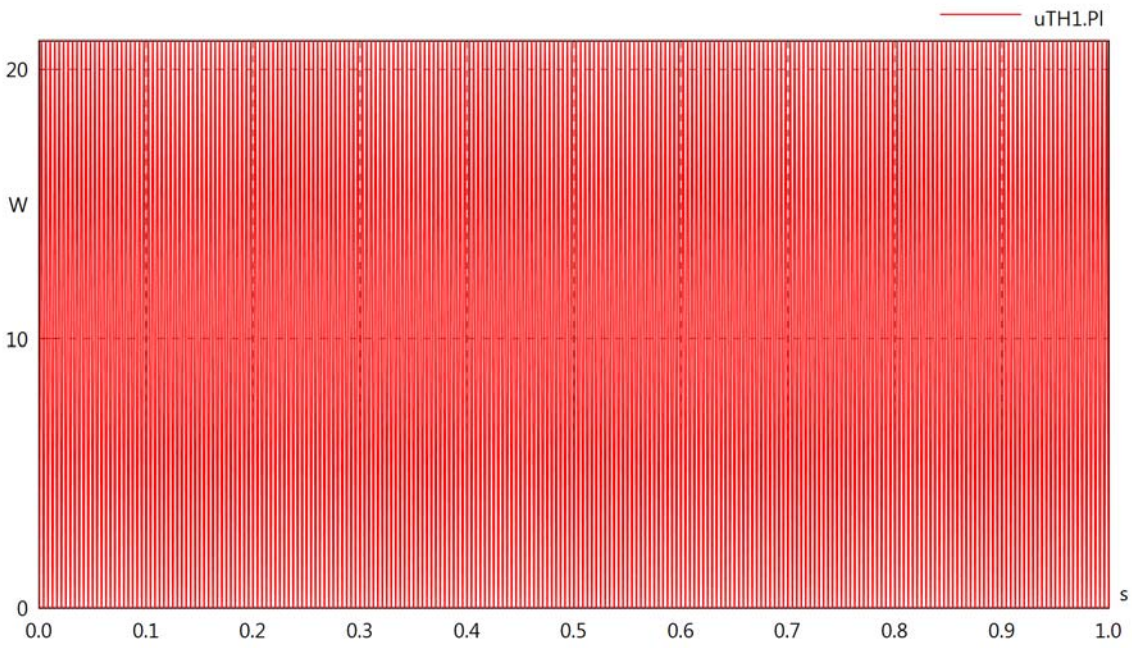
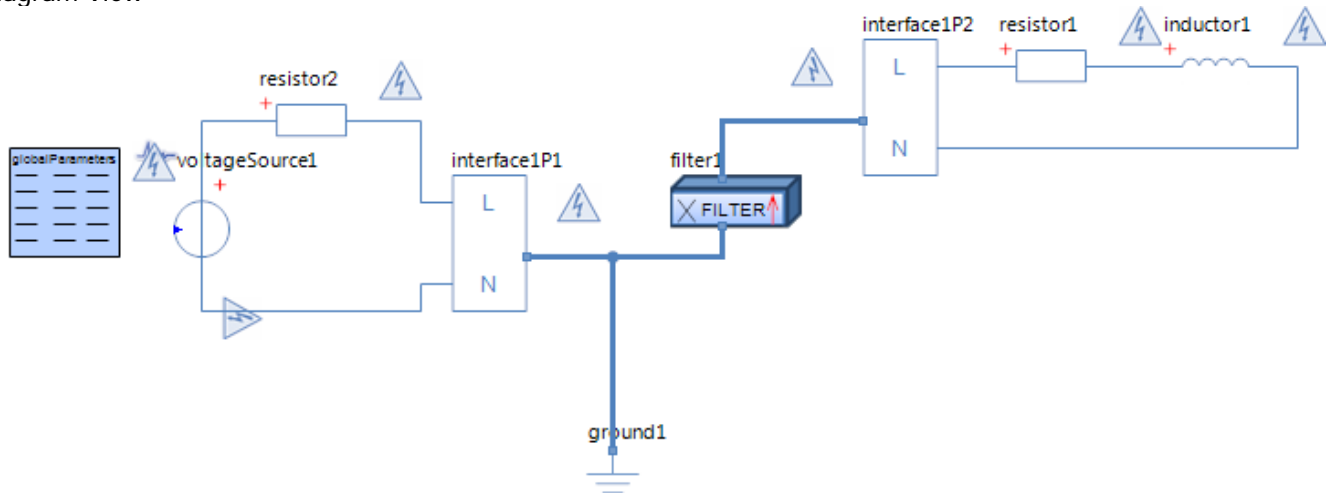

Diagram View



Voltage Source voltageSource1
Parameters

Comment	Name	Current Value	Unit
Voltage	v_src	$230 \cdot \sqrt{2} \cdot \sin(2 \cdot \pi \cdot t \cdot 30)$	[V]

Filter filter1
Parameters

Comment	Name	Current Value	Unit
Conductance between L1 and N Power side	G	1e-5	[1/Ohm]

Inductor inductor1
Parameters

Comment	Name	Current Value	Unit
Inductance	L	5	[mH]
Initial Value	i0	0 (Fixed)	[A]
Kind	kind	absolute	

Resistor resistor1
Parameters

Comment	Name	Current Value	Unit
Resistance	R	100	[Ohm]

Resistor resistor2
Parameters

Comment	Name	Current Value	Unit
Resistance	R	10	[Ohm]

filter1.vIn

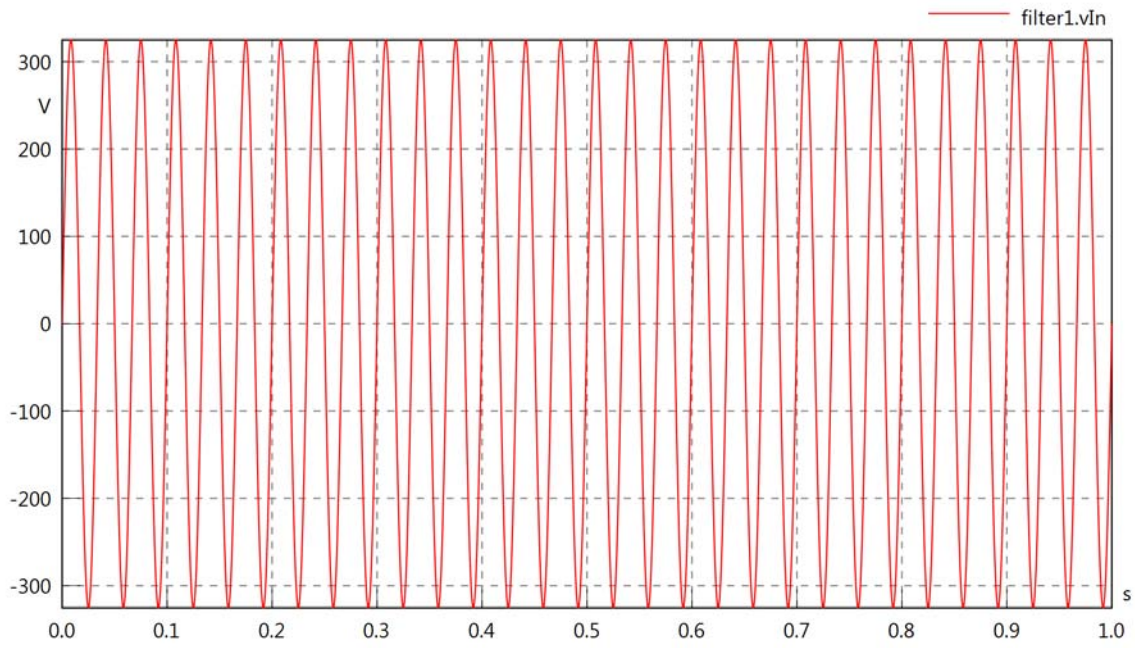

filter1.iIn

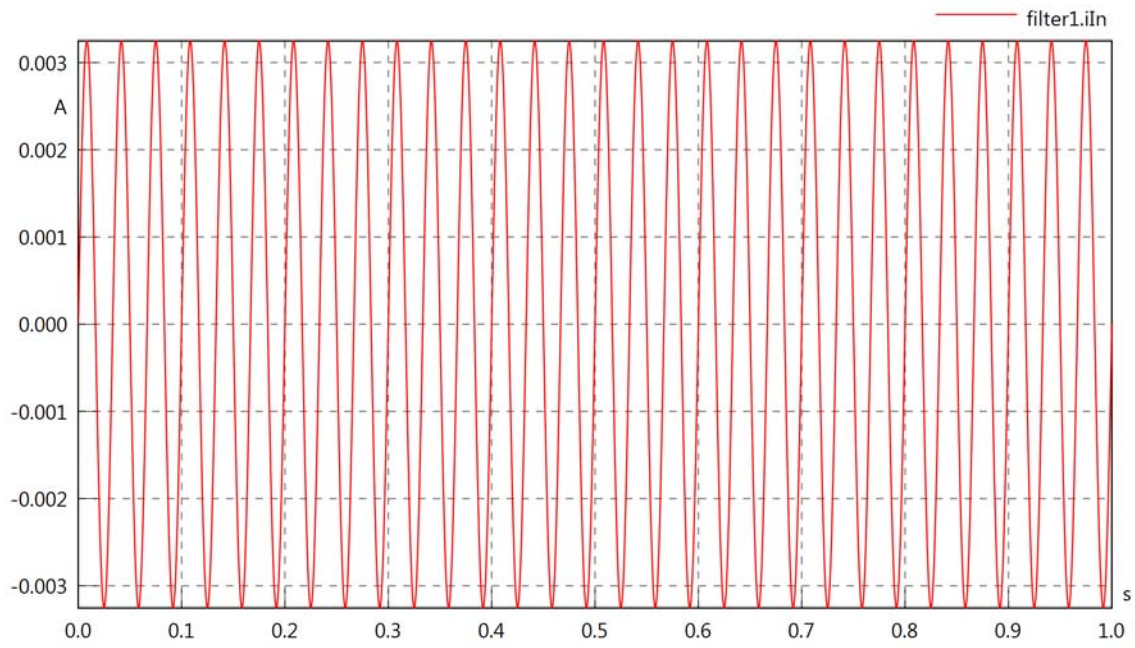

filter1.PIn

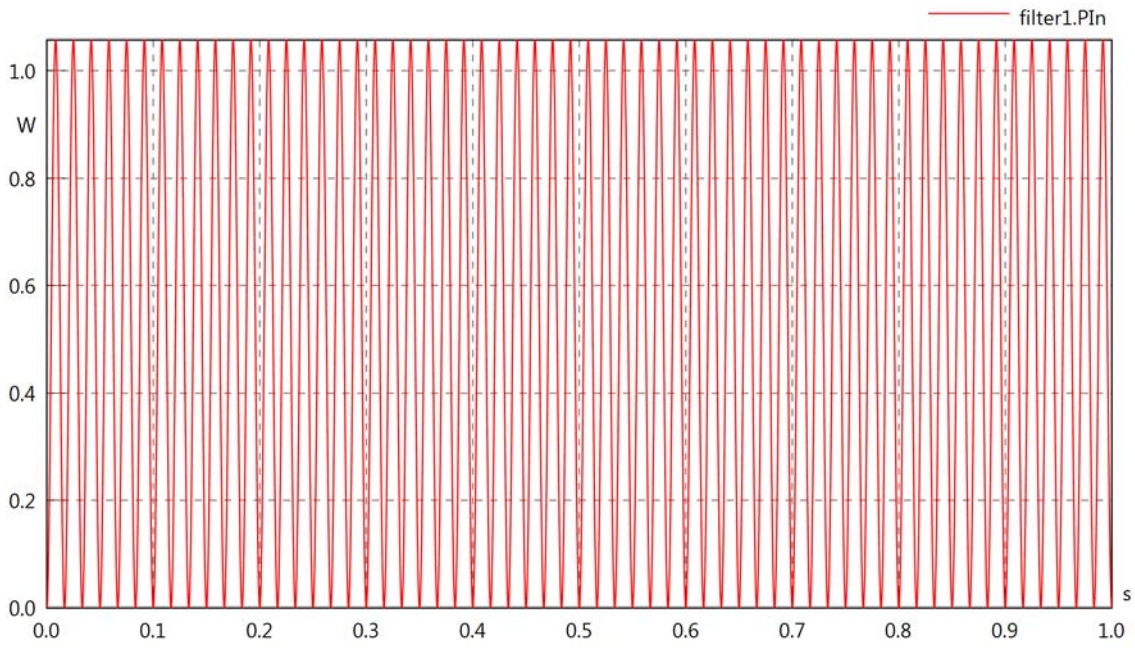

filter1.PI

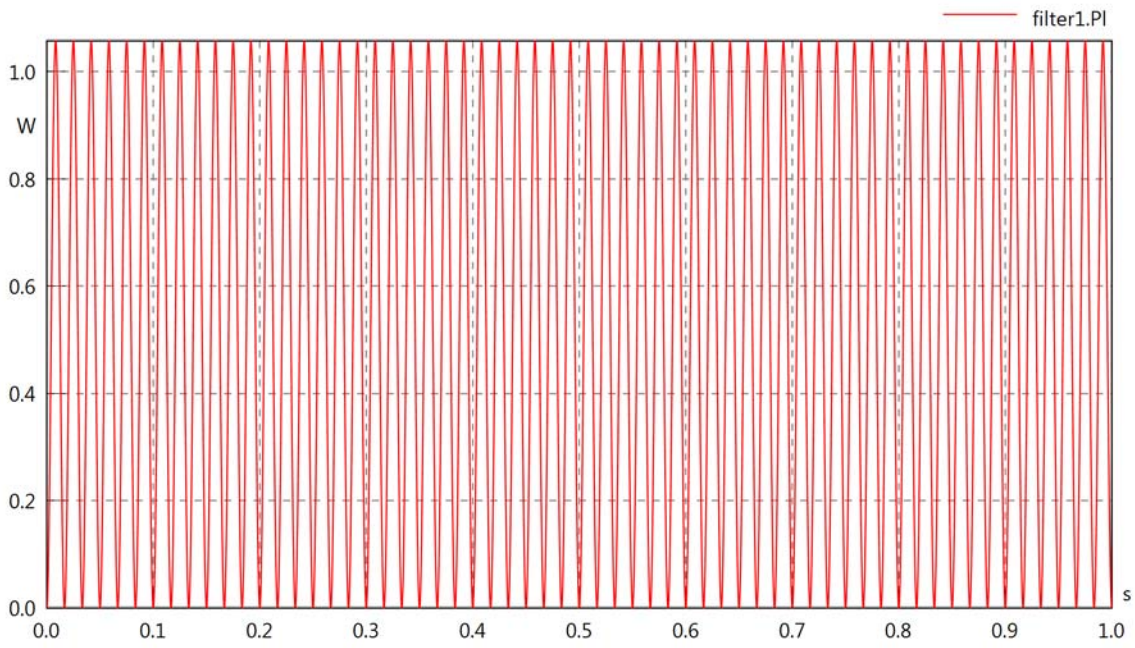
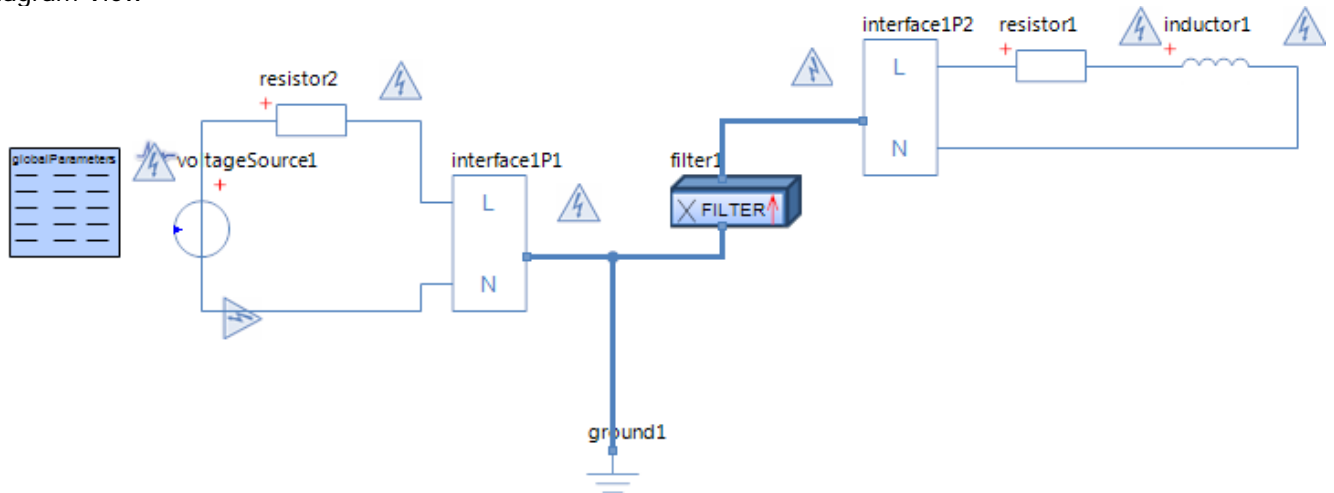

Diagram View



Voltage Source voltageSource1
Parameters

Comment	Name	Current Value	Unit
Voltage	v_src	$230 \cdot \sqrt{2} \cdot \sin(2 \cdot \pi \cdot t \cdot 60)$	[V]

Filter filter1
Parameters

Comment	Name	Current Value	Unit
Conductance between L1 and N Power side	G	1e-5	[1/Ohm]

Inductor inductor1
Parameters

Comment	Name	Current Value	Unit
Inductance	L	5	[mH]
Initial Value	i0	0 (Fixed)	[A]
Kind	kind	absolute	

Resistor resistor1
Parameters

Comment	Name	Current Value	Unit
Resistance	R	100	[Ohm]

Resistor resistor2
Parameters

Comment	Name	Current Value	Unit
Resistance	R	10	[Ohm]

filter1.vIn

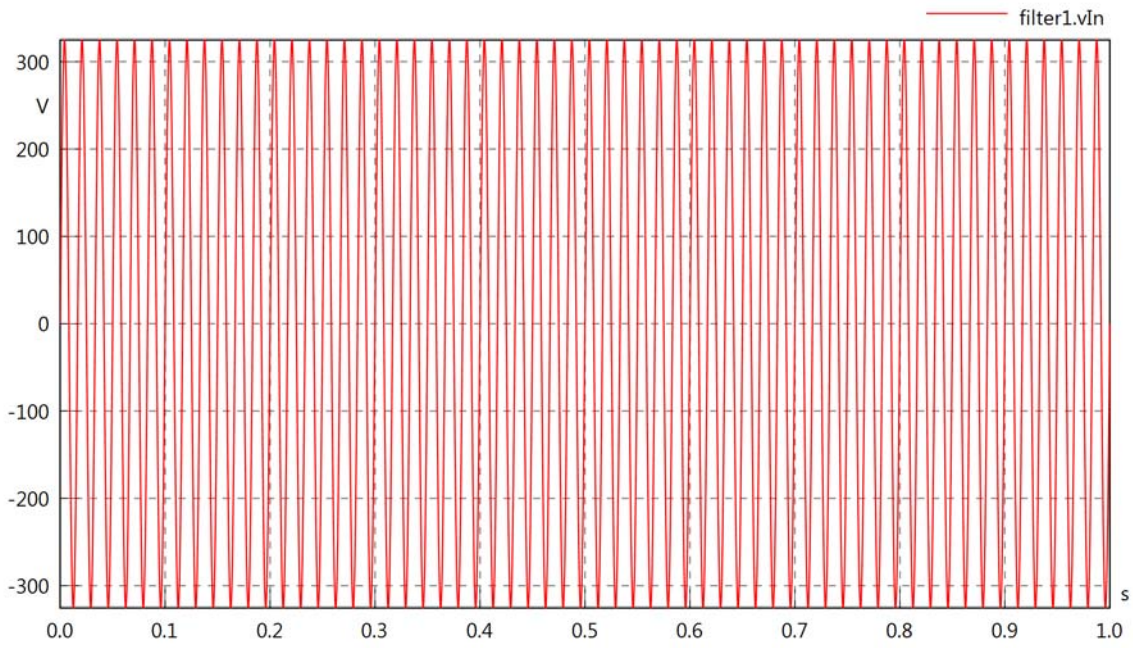

filter1.iIn

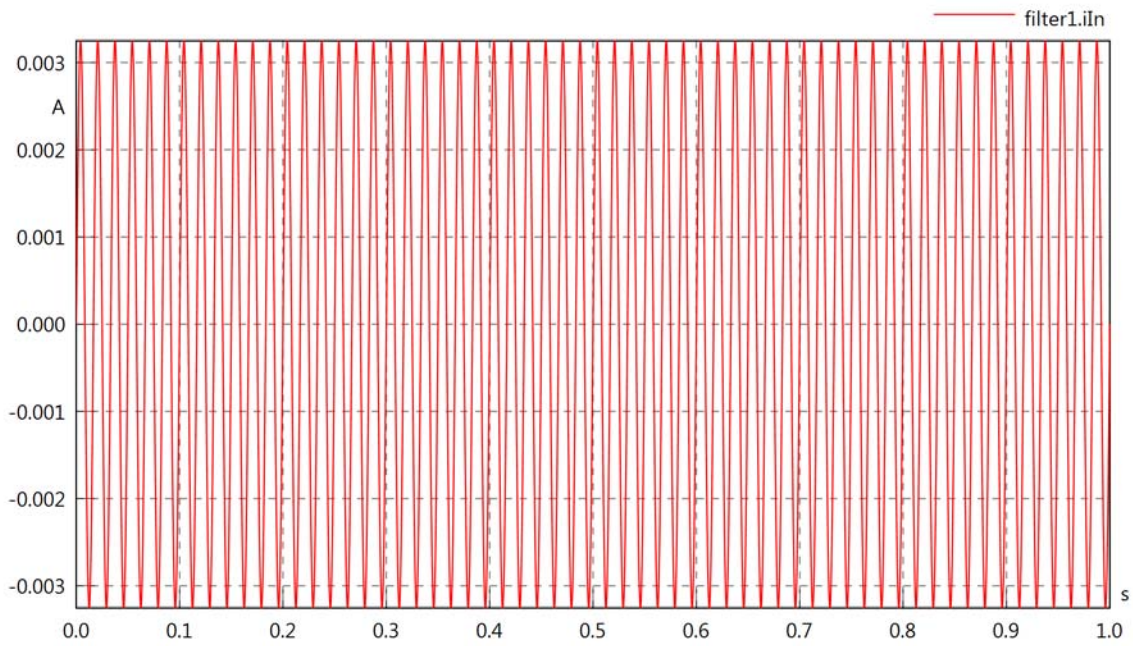

filter1.PIn

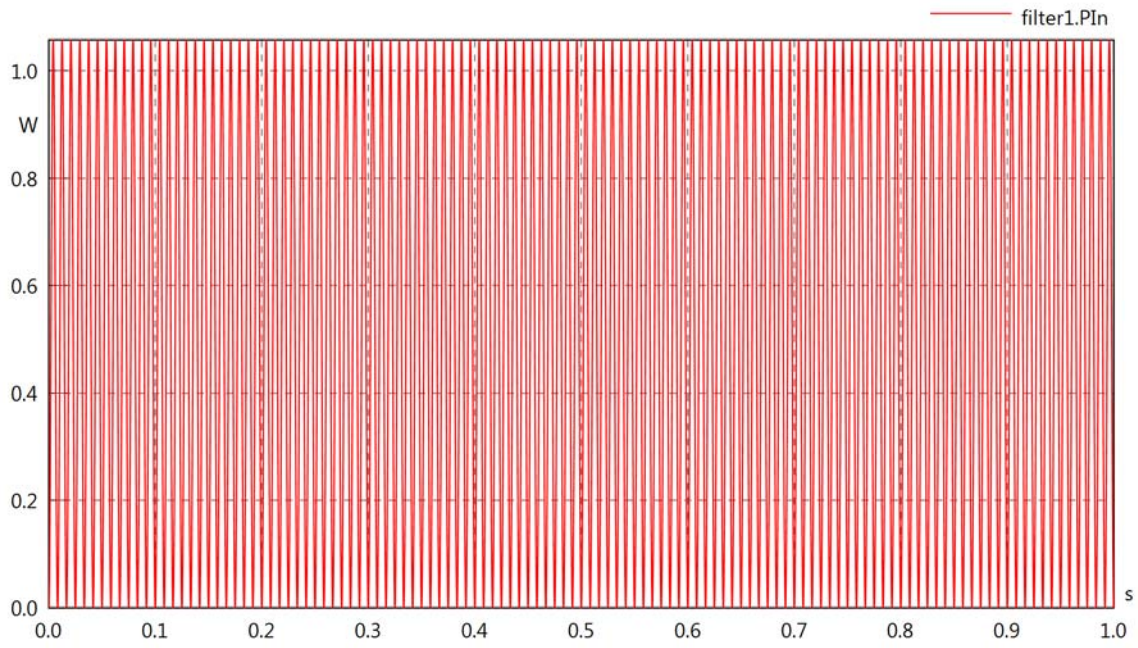

filter1.PI

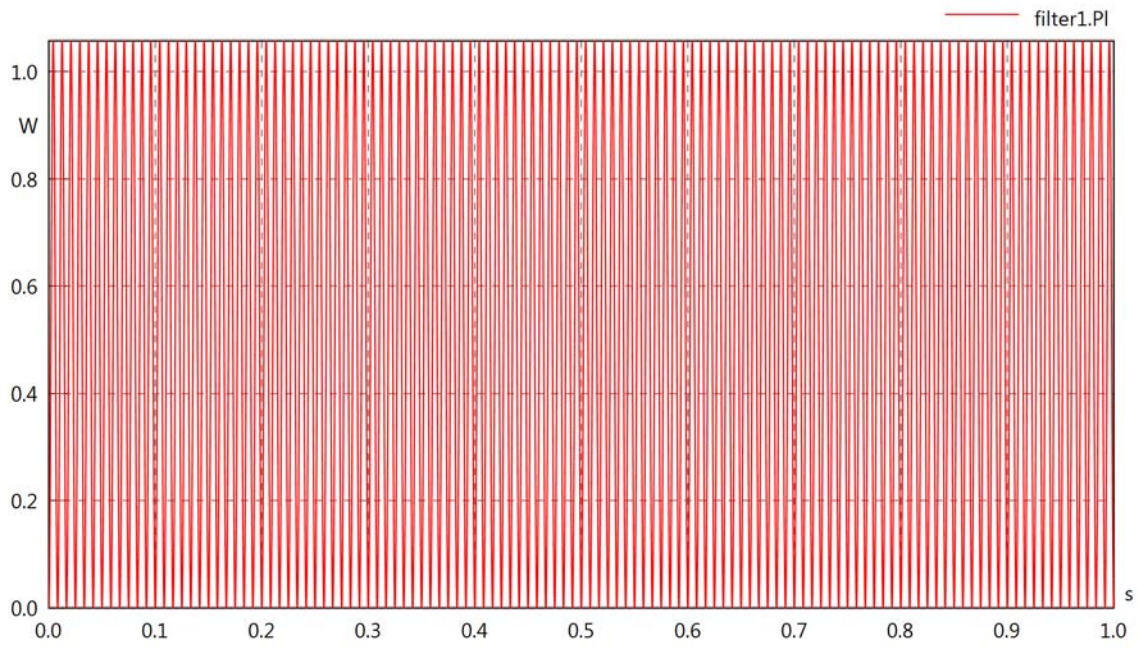
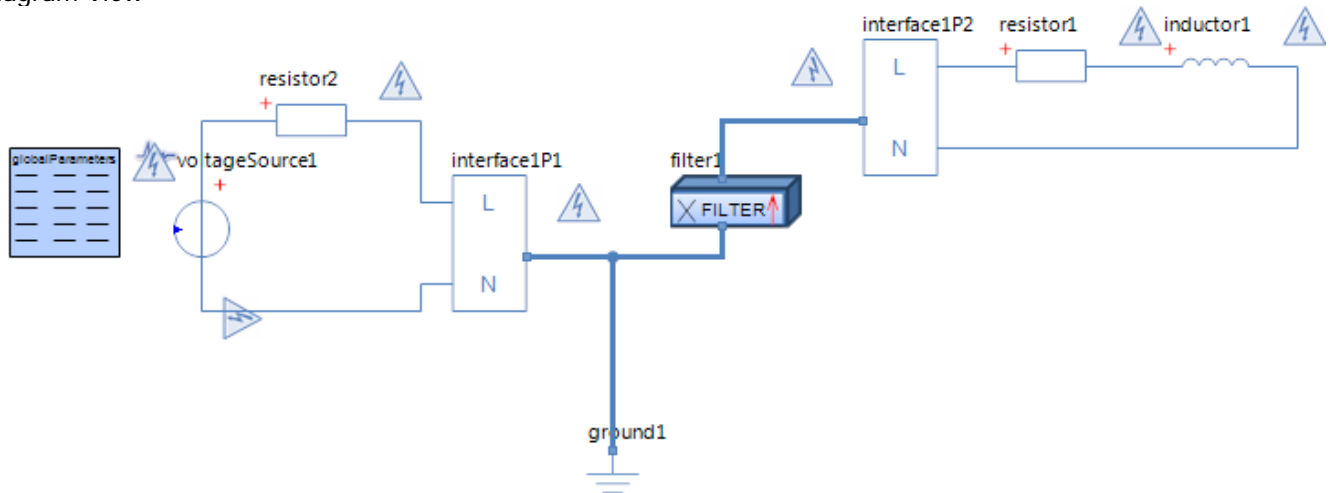

Diagram View



Voltage Source voltageSource1
Parameters

Comment	Name	Current Value	Unit
Voltage	v_src	$230 \cdot \sqrt{2} \cdot \sin(2 \cdot \pi \cdot t \cdot 120)$	[V]

Filter filter1
Parameters

Comment	Name	Current Value	Unit
Conductance between L1 and N Power side	G	1e-5	[1/Ohm]

Inductor inductor1
Parameters

Comment	Name	Current Value	Unit
Inductance	L	5	[mH]
Initial Value	i0	0 (Fixed)	[A]
Kind	kind	absolute	

Resistor resistor1
Parameters

Comment	Name	Current Value	Unit
Resistance	R	100	[Ohm]

Resistor resistor2
Parameters

Comment	Name	Current Value	Unit
Resistance	R	10	[Ohm]

filter1.vIn

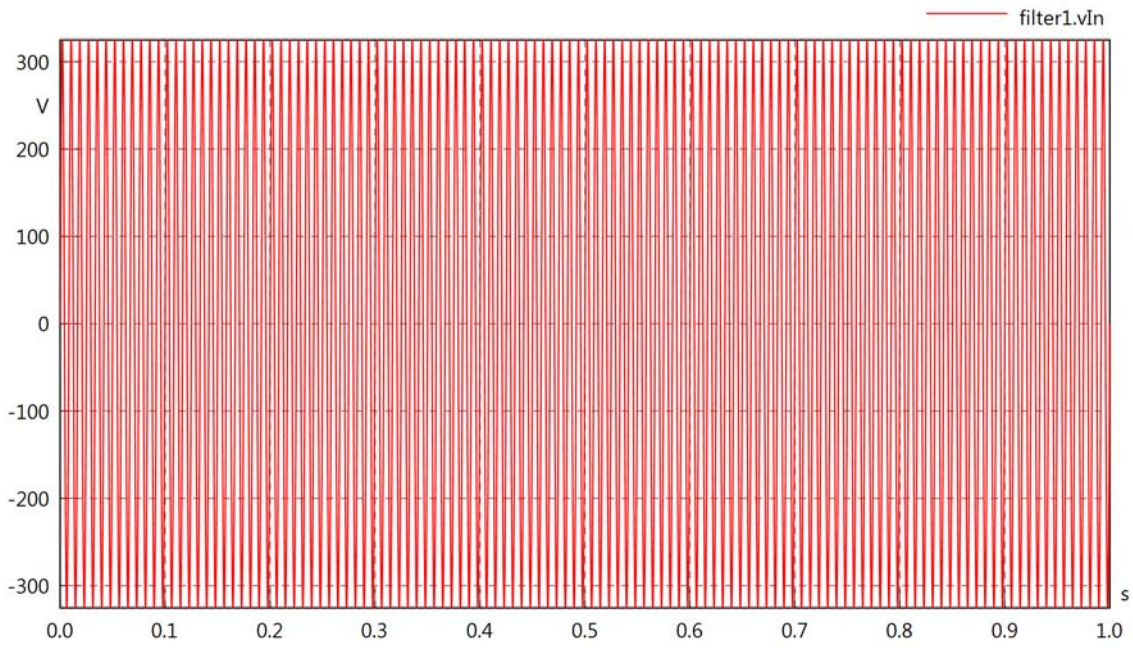

filter1.iIn

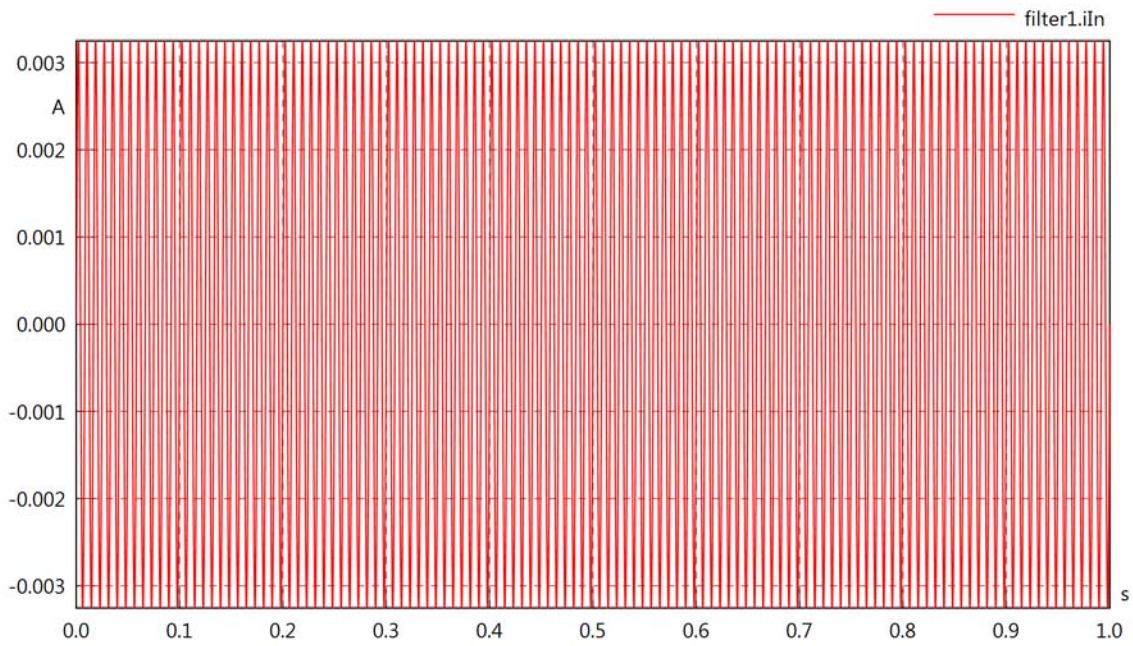

filter1.PIn

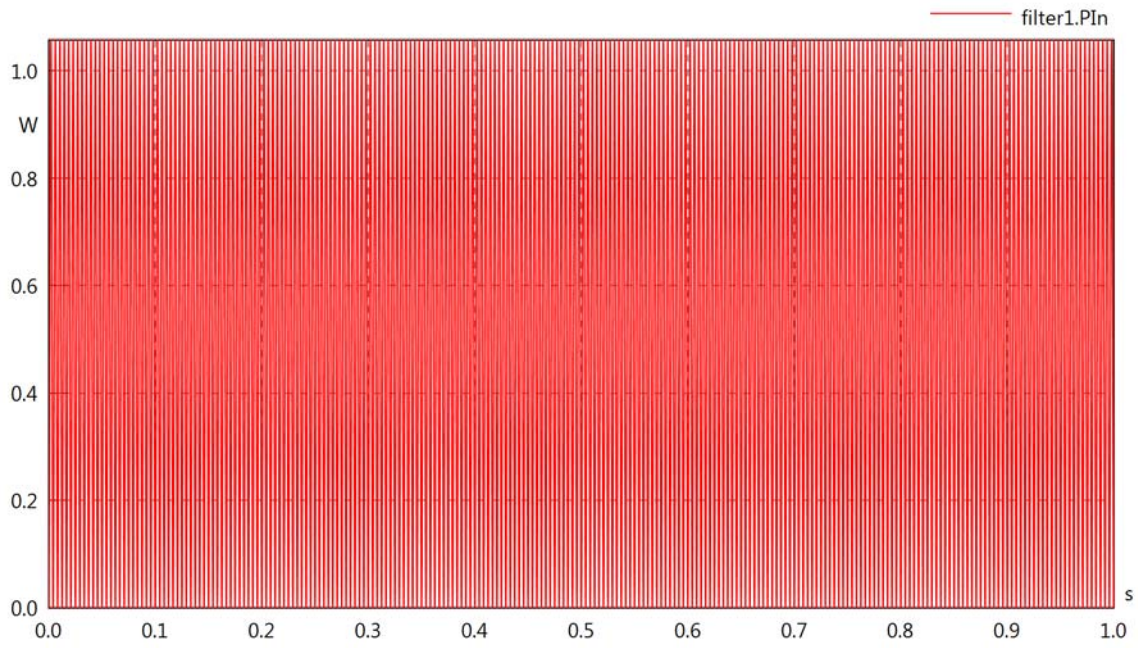

filter1.PI

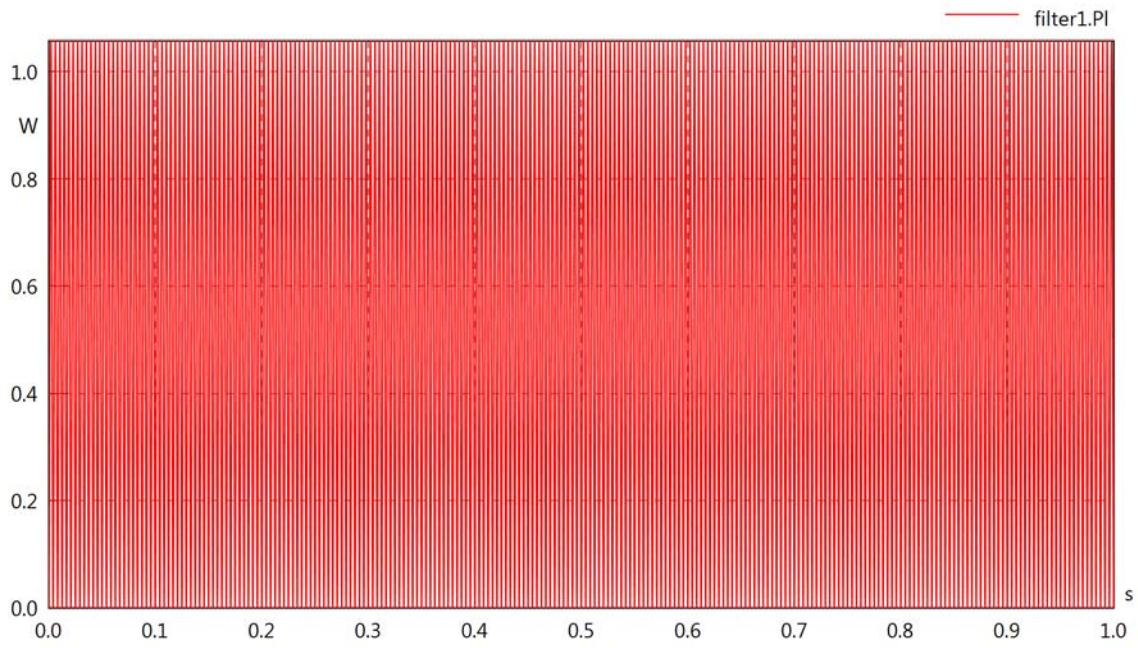
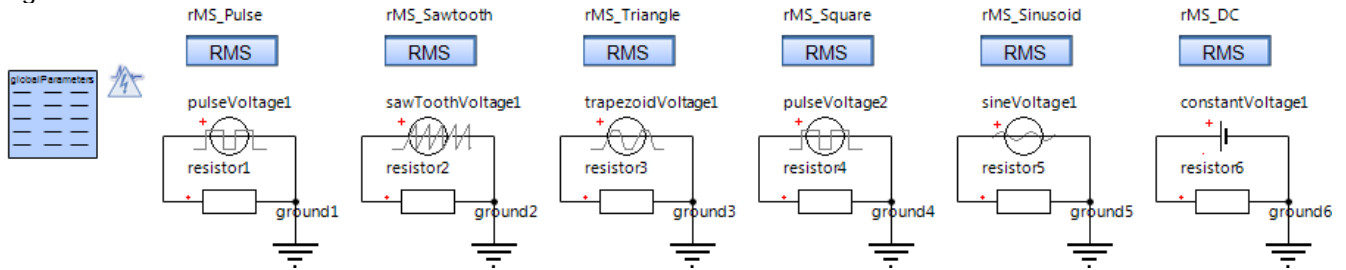

Diagram View



RMS Calculator rMS_Pulse
Parameters

Comment	Name	Current Value	Unit
Input Signal	s	resistor1.v	[-]
Signal Frequency	sf	60	[Hz]

Resistor resistor1
Parameters

Comment	Name	Current Value	Unit
Resistance	R	1000	[Ohm]

Pulse Voltage Source pulseVoltage1
Parameters

Comment	Name	Current Value	Unit
Amplitude of pulse (voltage)	V	230	[V]
Width of Pulse (in % of Period)	width	20	[-]
Time for one Period	period	1/rMS_Pulse.sf	[s]
Voltage Offset	offset	0	[V]
Time Offset	startTime	0	[s]

RMS Calculator rMS_Sawtooth
Parameters

Comment	Name	Current Value	Unit
Input Signal	s	resistor2.v	[-]
Signal Frequency	sf	rMS_Pulse.sf	[Hz]

Resistor resistor2
Parameters

Comment	Name	Current Value	Unit
Resistance	R	1000	[Ohm]

Saw Tooth Voltage Source sawToothVoltage1
Parameters

Comment	Name	Current Value	Unit
Amplitude of Saw Tooth (Voltage)	V	230	[V]
Time for one Period	period	1/rMS_Pulse.sf	[s]
Voltage Offset	offset	0	[V]
Time Offset	startTime	0	[s]

RMS Calculator rMS_Triangle
Parameters

Comment	Name	Current Value	Unit
Input Signal	s	resistor3.v	[-]
Signal Frequency	sf	rMS_Pulse.sf	[Hz]

Resistor resistor3
Parameters

Comment	Name	Current Value	Unit
Resistance	R	1000	[Ohm]

Trapezoidal Voltage Source trapezoidVoltage1
Parameters

Comment	Name	Current Value	Unit
Number of Periods (if < 0 then infinite number)	nperiod	-1	[Stck]
Amplitude of Trapezoid (Voltage)	V	230	[V]
Rising Duration of Trapezoid	rising	1/rMS_Pulse.sf/2	[s]
Width Duration of Trapezoid	width	0	[s]
Falling Duration of Trapezoid	falling	1/rMS_Pulse.sf/2	[s]
Time of one Period	period	1/rMS_Pulse.sf	[s]
Voltage Offset	offset	0	[V]
Time Offset	startTime	0	[s]

Pulse Voltage Source pulseVoltage2
Parameters

Comment	Name	Current Value	Unit
Amplitude of pulse (voltage)	V	230	[V]
Width of Pulse (in % of Period)	width	50	[-]
Time for one Period	period	1/rMS_Pulse.sf	[s]
Voltage Offset	offset	0	[V]
Time Offset	startTime	0	[s]

RMS Calculator rMS_Square
Parameters

Comment	Name	Current Value	Unit
Input Signal	s	resistor4.v	[-]
Signal Frequency	sf	rMS_Pulse.sf	[Hz]

Resistor resistor4
Parameters

Comment	Name	Current Value	Unit
Resistance	R	1000	[Ohm]

Sine Voltage Source sineVoltage1
Parameters

Comment	Name	Current Value	Unit
Amplitude of Sine Wave (Voltage)	V	230	[V]
Frequency of Sine Wave	f	rMS_Pulse.sf	[Hz]
Phase of Sine Wave	phase	0	[rad]
Voltage Offset	offset	0	[V]
Time Offset	startTime	0	[s]

RMS Calculator rMS_Sinusoid
Parameters

Comment	Name	Current Value	Unit
Input Signal	s	resistor5.v	[-]
Signal Frequency	sf	rMS_Pulse.sf	[Hz]

Resistor resistor5
Parameters

Comment	Name	Current Value	Unit
Resistance	R	1000	[Ohm]

RMS Calculator rMS_DC
Parameters

Comment	Name	Current Value	Unit
Input Signal	s	resistor6.v	[-]
Signal Frequency	sf	rMS_Pulse.sf	[Hz]

Resistor resistor6
Parameters

Comment	Name	Current Value	Unit
Resistance	R	1000	[Ohm]

Constant Voltage Source constantVoltage1
Parameters

Comment	Name	Current Value	Unit
Constant Voltage	V	230	[V]

constantVoltage1.v, ...

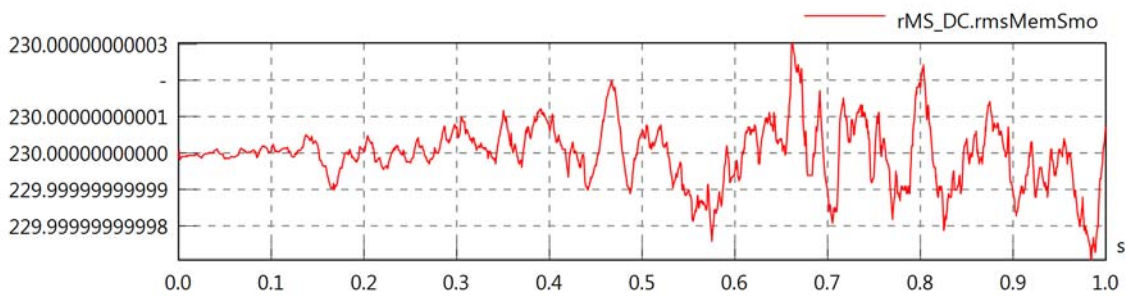
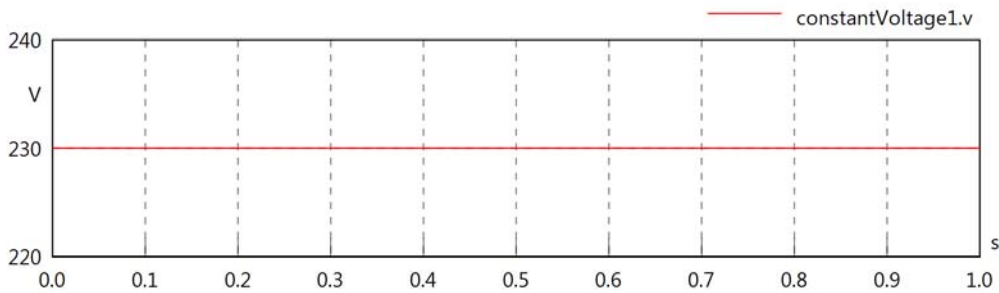

sineVoltage1.v, ...

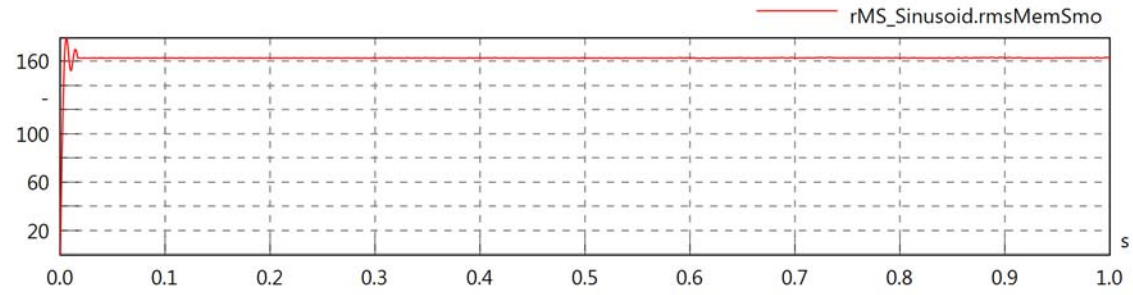
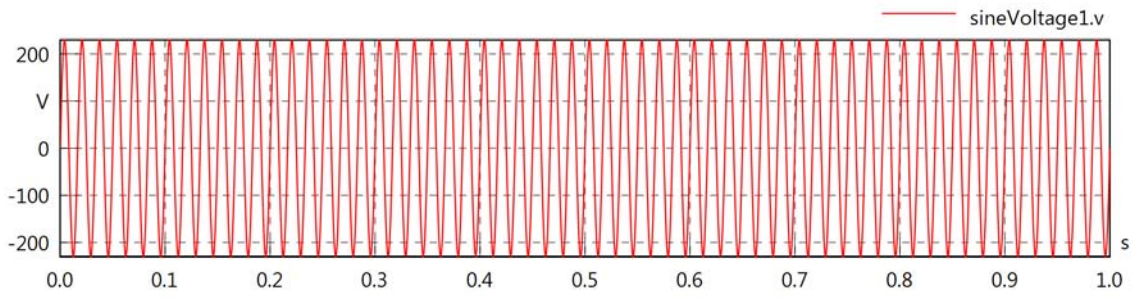

pulseVoltage2.v, ...

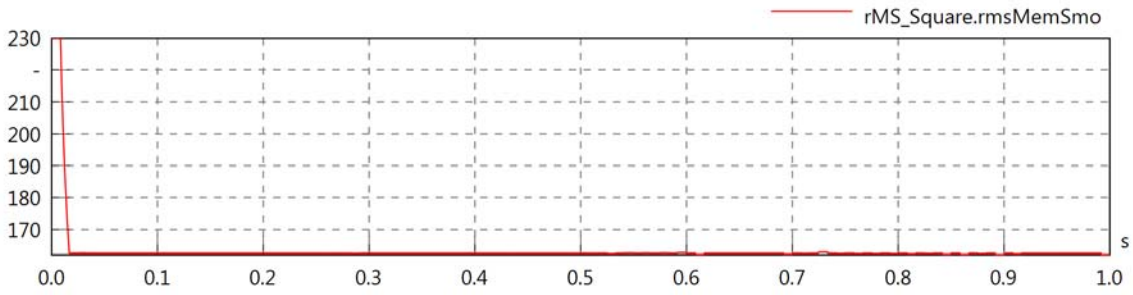
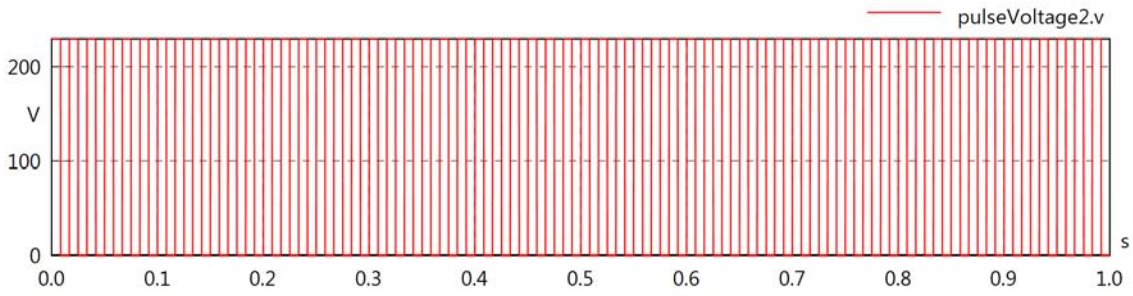

trapezoidVoltage1.v, ...

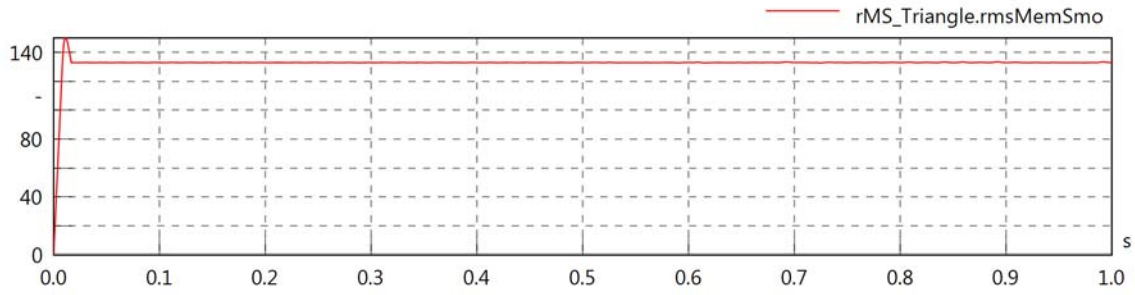
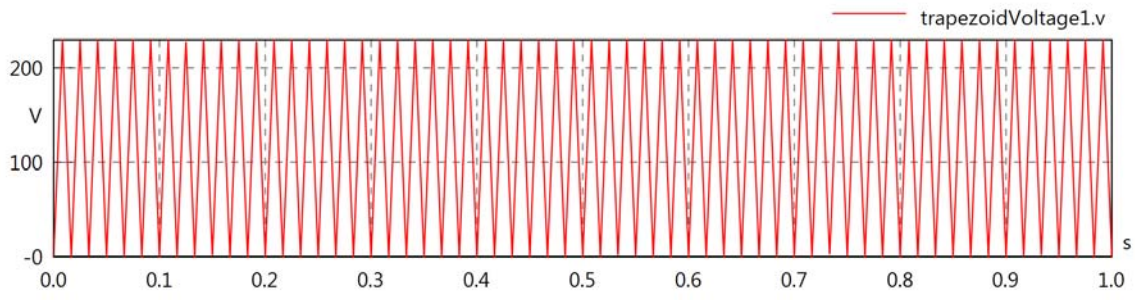

sawToothVoltage1.v, ...

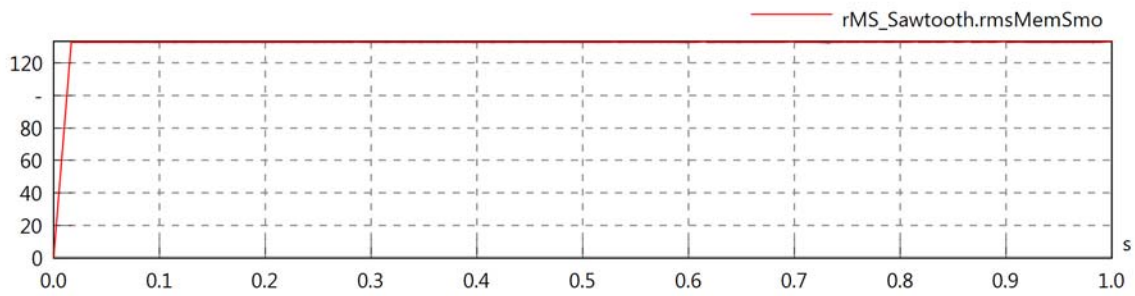
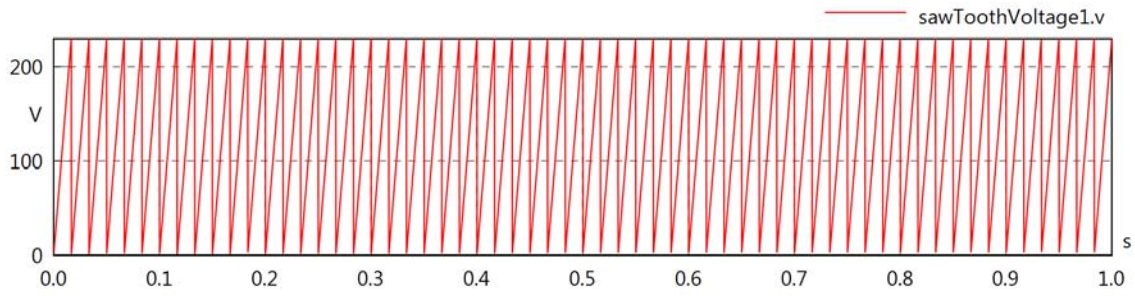

pulseVoltage1.v, ...

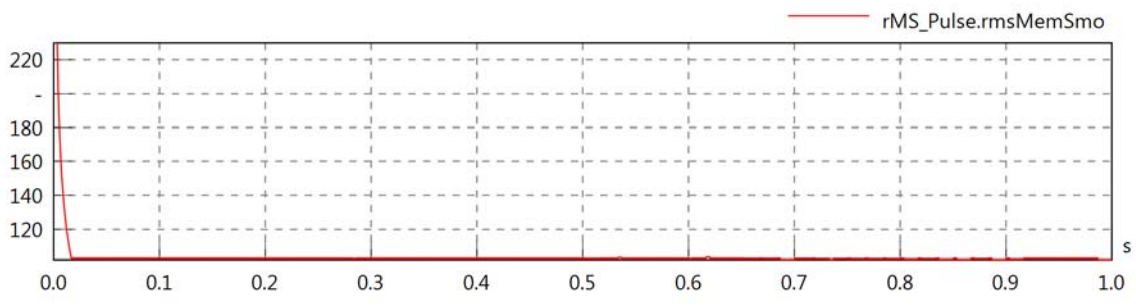
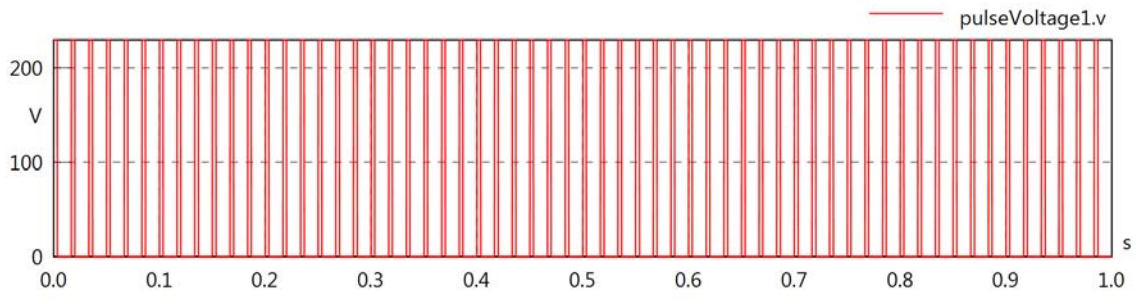
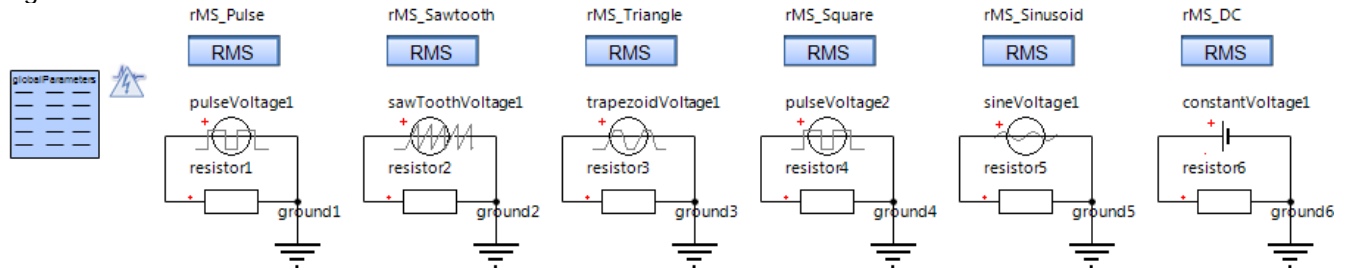

Diagram View



RMS Calculator rMS_Pulse
Parameters

Comment	Name	Current Value	Unit
Input Signal	s	resistor1.v	[-]
Signal Frequency	sf	120	[Hz]

Resistor resistor1
Parameters

Comment	Name	Current Value	Unit
Resistance	R	1000	[Ohm]

Pulse Voltage Source pulseVoltage1
Parameters

Comment	Name	Current Value	Unit
Amplitude of pulse (voltage)	V	230	[V]
Width of Pulse (in % of Period)	width	20	[-]
Time for one Period	period	1/rMS_Pulse.sf	[s]
Voltage Offset	offset	0	[V]
Time Offset	startTime	0	[s]

RMS Calculator rMS_Sawtooth
Parameters

Comment	Name	Current Value	Unit
Input Signal	s	resistor2.v	[-]
Signal Frequency	sf	rMS_Pulse.sf	[Hz]

Resistor resistor2
Parameters

Comment	Name	Current Value	Unit
Resistance	R	1000	[Ohm]

Saw Tooth Voltage Source sawToothVoltage1
Parameters

Comment	Name	Current Value	Unit
Amplitude of Saw Tooth (Voltage)	V	230	[V]
Time for one Period	period	1/rMS_Pulse.sf	[s]
Voltage Offset	offset	0	[V]
Time Offset	startTime	0	[s]

RMS Calculator rMS_Triangle
Parameters

Comment	Name	Current Value	Unit
Input Signal	s	resistor3.v	[-]
Signal Frequency	sf	rMS_Pulse.sf	[Hz]

Resistor resistor3
Parameters

Comment	Name	Current Value	Unit
Resistance	R	1000	[Ohm]

Trapezoidal Voltage Source trapezoidVoltage1
Parameters

Comment	Name	Current Value	Unit
Number of Periods (if < 0 then infinite number)	nperiod	-1	[Stck]
Amplitude of Trapezoid (Voltage)	V	230	[V]
Rising Duration of Trapezoid	rising	1/rMS_Pulse.sf/2	[s]
Width Duration of Trapezoid	width	0	[s]
Falling Duration of Trapezoid	falling	1/rMS_Pulse.sf/2	[s]
Time of one Period	period	1/rMS_Pulse.sf	[s]
Voltage Offset	offset	0	[V]
Time Offset	startTime	0	[s]

Pulse Voltage Source pulseVoltage2
Parameters

Comment	Name	Current Value	Unit
Amplitude of pulse (voltage)	V	230	[V]
Width of Pulse (in % of Period)	width	50	[-]
Time for one Period	period	1/rMS_Pulse.sf	[s]
Voltage Offset	offset	0	[V]
Time Offset	startTime	0	[s]

RMS Calculator rMS_Square
Parameters

Comment	Name	Current Value	Unit
Input Signal	s	resistor4.v	[-]
Signal Frequency	sf	rMS_Pulse.sf	[Hz]

Resistor resistor4
Parameters

Comment	Name	Current Value	Unit
Resistance	R	1000	[Ohm]

Sine Voltage Source sineVoltage1
Parameters

Comment	Name	Current Value	Unit
Amplitude of Sine Wave (Voltage)	V	230	[V]
Frequency of Sine Wave	f	rMS_Pulse.sf	[Hz]
Phase of Sine Wave	phase	0	[rad]
Voltage Offset	offset	0	[V]
Time Offset	startTime	0	[s]

RMS Calculator rMS_Sinusoid
Parameters

Comment	Name	Current Value	Unit
Input Signal	s	resistor5.v	[-]
Signal Frequency	sf	rMS_Pulse.sf	[Hz]

Resistor resistor5
Parameters

Comment	Name	Current Value	Unit
Resistance	R	1000	[Ohm]

RMS Calculator rMS_DC
Parameters

Comment	Name	Current Value	Unit
Input Signal	s	resistor6.v	[-]
Signal Frequency	sf	rMS_Pulse.sf	[Hz]

Resistor resistor6
Parameters

Comment	Name	Current Value	Unit
Resistance	R	1000	[Ohm]

Constant Voltage Source constantVoltage1
Parameters

Comment	Name	Current Value	Unit
Constant Voltage	V	230	[V]

constantVoltage1.v, ...

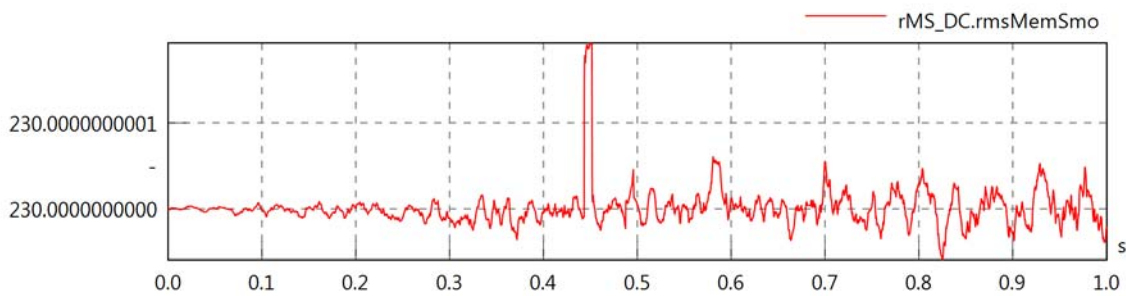
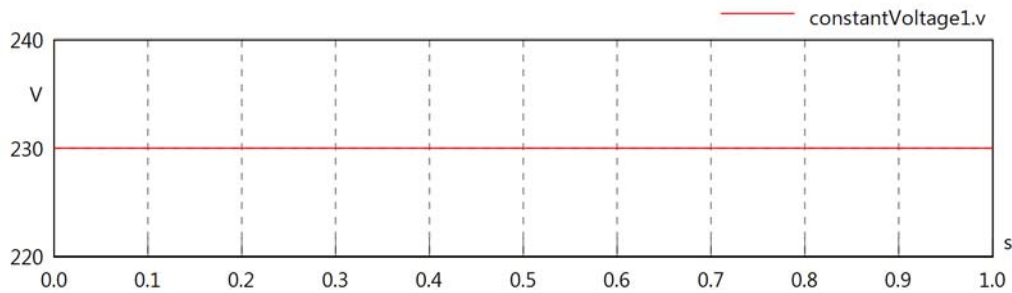

sineVoltage1.v, ...

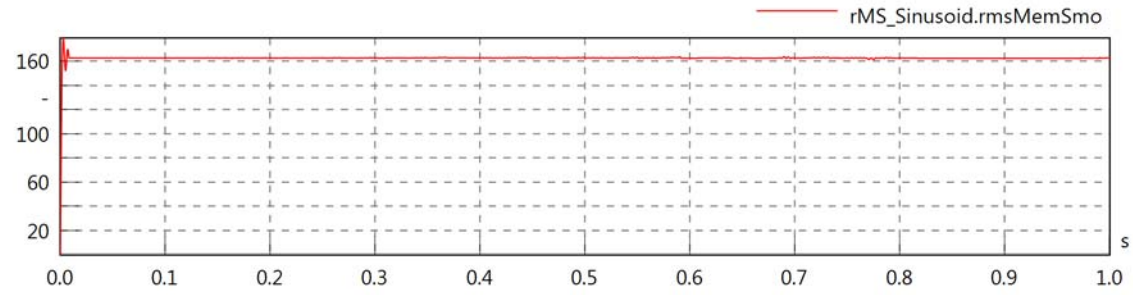
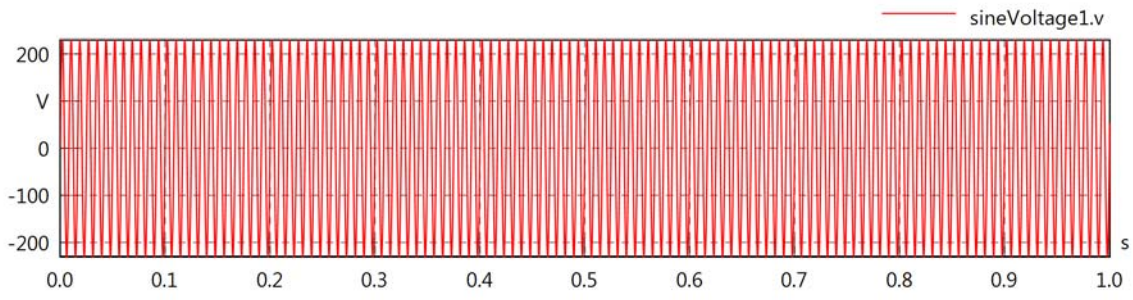

pulseVoltage2.v, ...

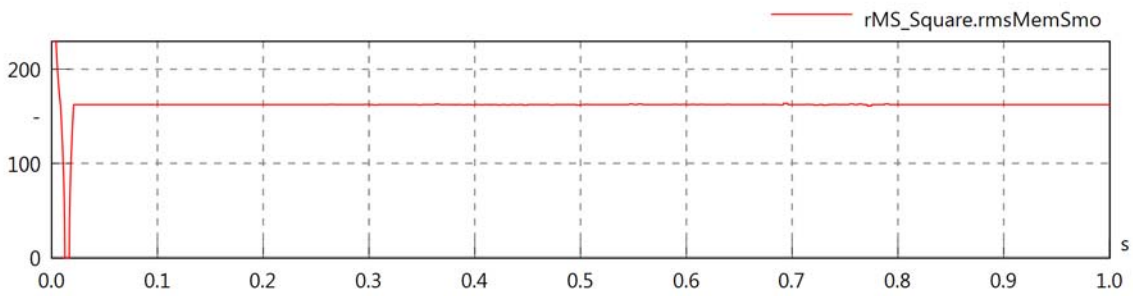
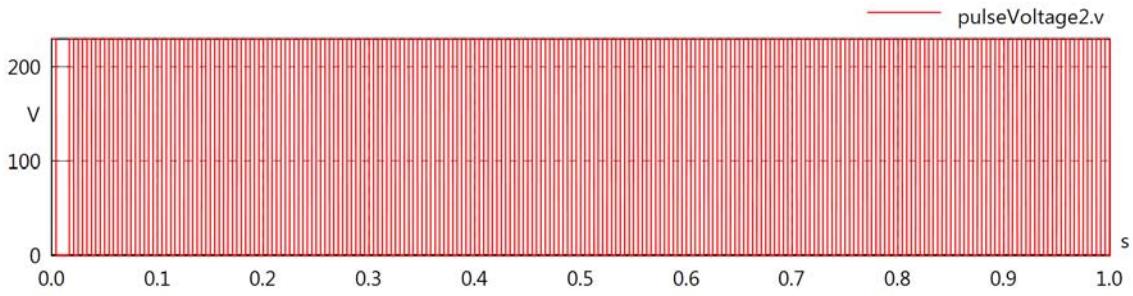

trapezoidVoltage1.v, ...

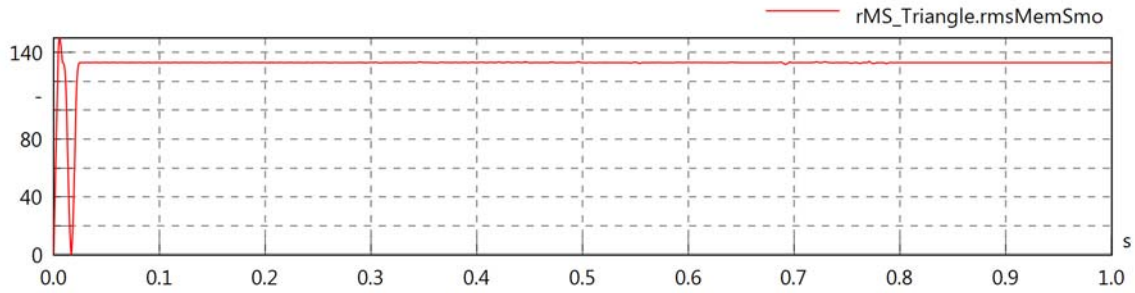
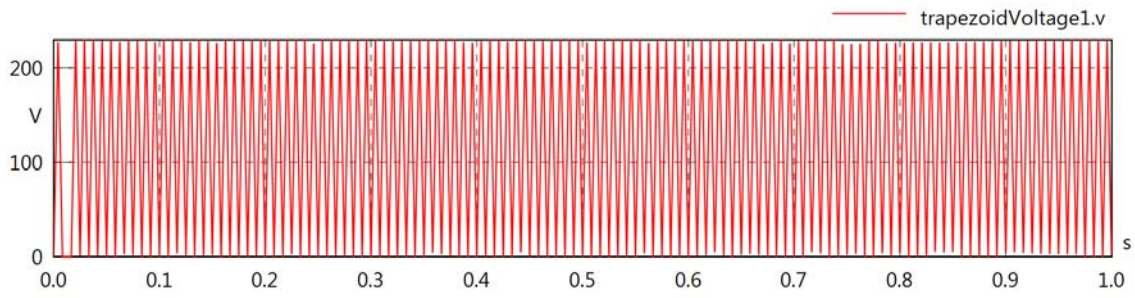

sawToothVoltage1.v, ...

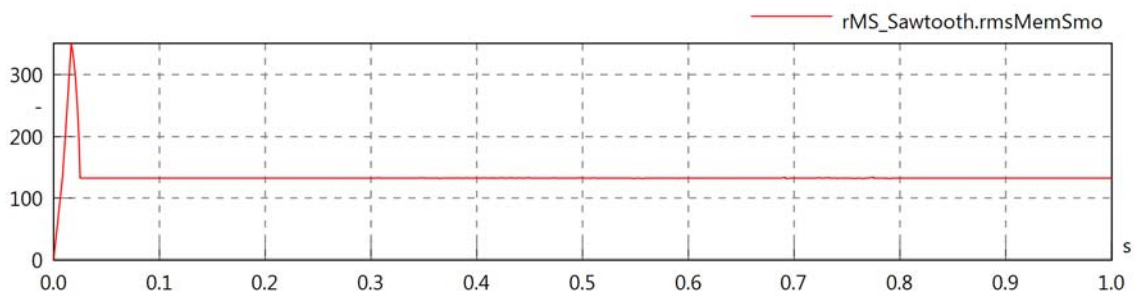
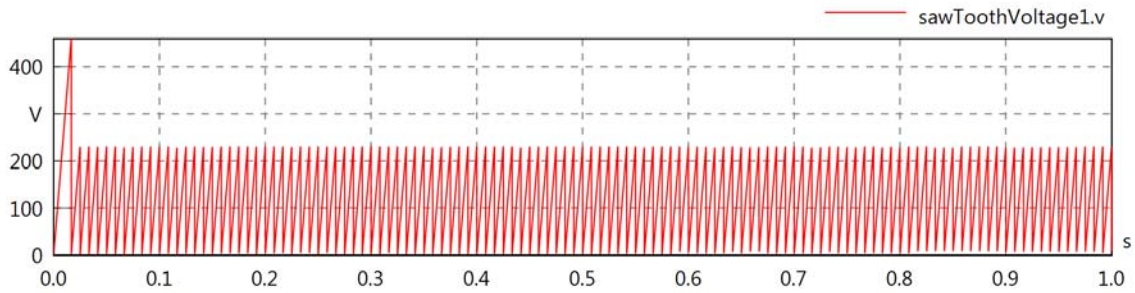

pulseVoltage1.v, ...

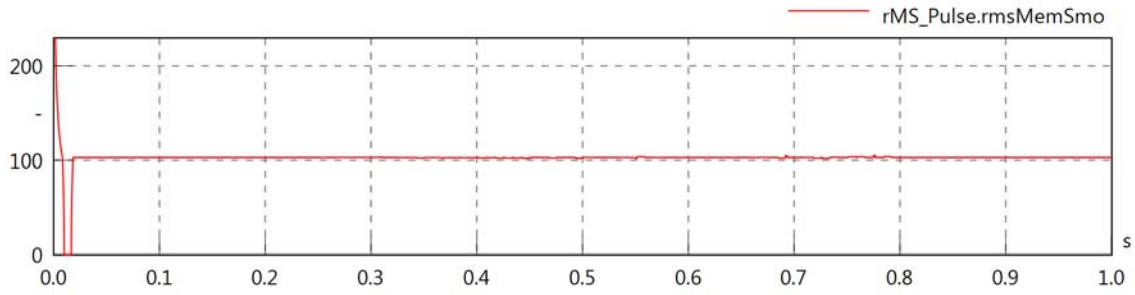
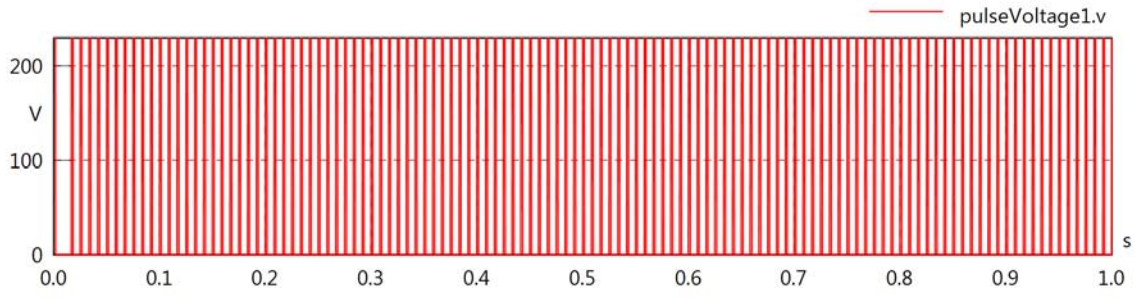
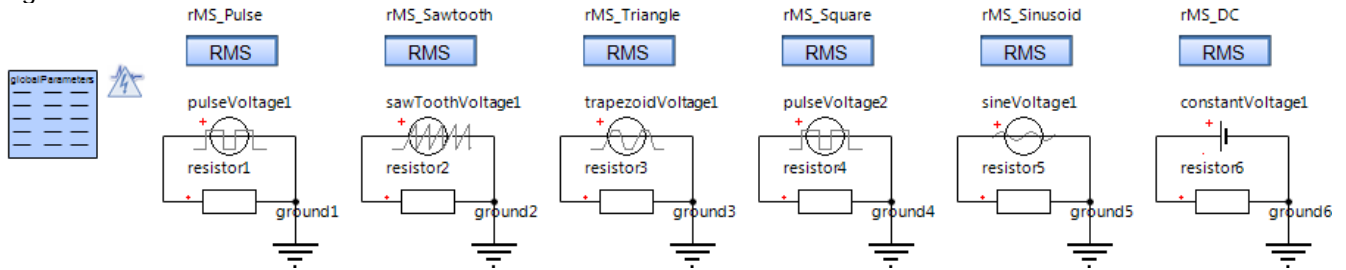

Diagram View



RMS Calculator rMS_Pulse
Parameters

Comment	Name	Current Value	Unit
Input Signal	s	resistor1.v	[-]
Signal Frequency	sf	1200	[Hz]

Resistor resistor1
Parameters

Comment	Name	Current Value	Unit
Resistance	R	1000	[Ohm]

Pulse Voltage Source pulseVoltage1
Parameters

Comment	Name	Current Value	Unit
Amplitude of pulse (voltage)	V	230	[V]
Width of Pulse (in % of Period)	width	20	[-]
Time for one Period	period	1/rMS_Pulse.sf	[s]
Voltage Offset	offset	0	[V]
Time Offset	startTime	0	[s]

RMS Calculator rMS_Sawtooth
Parameters

Comment	Name	Current Value	Unit
Input Signal	s	resistor2.v	[-]
Signal Frequency	sf	rMS_Pulse.sf	[Hz]

Resistor resistor2
Parameters

Comment	Name	Current Value	Unit
Resistance	R	1000	[Ohm]

Saw Tooth Voltage Source sawToothVoltage1
Parameters

Comment	Name	Current Value	Unit
Amplitude of Saw Tooth (Voltage)	V	230	[V]
Time for one Period	period	1/rMS_Pulse.sf	[s]
Voltage Offset	offset	0	[V]
Time Offset	startTime	0	[s]

RMS Calculator rMS_Triangle
Parameters

Comment	Name	Current Value	Unit
Input Signal	s	resistor3.v	[-]
Signal Frequency	sf	rMS_Pulse.sf	[Hz]

Resistor resistor3
Parameters

Comment	Name	Current Value	Unit
Resistance	R	1000	[Ohm]

Trapezoidal Voltage Source trapezoidVoltage1
Parameters

Comment	Name	Current Value	Unit
Number of Periods (if < 0 then infinite number)	nperiod	-1	[Stck]
Amplitude of Trapezoid (Voltage)	V	230	[V]
Rising Duration of Trapezoid	rising	1/rMS_Pulse.sf/2	[s]
Width Duration of Trapezoid	width	0	[s]
Falling Duration of Trapezoid	falling	1/rMS_Pulse.sf/2	[s]
Time of one Period	period	1/rMS_Pulse.sf	[s]
Voltage Offset	offset	0	[V]
Time Offset	startTime	0	[s]

Pulse Voltage Source pulseVoltage2
Parameters

Comment	Name	Current Value	Unit
Amplitude of pulse (voltage)	V	230	[V]
Width of Pulse (in % of Period)	width	50	[-]
Time for one Period	period	1/rMS_Pulse.sf	[s]
Voltage Offset	offset	0	[V]
Time Offset	startTime	0	[s]

RMS Calculator rMS_Square
Parameters

Comment	Name	Current Value	Unit
Input Signal	s	resistor4.v	[-]
Signal Frequency	sf	rMS_Pulse.sf	[Hz]

Resistor resistor4
Parameters

Comment	Name	Current Value	Unit
Resistance	R	1000	[Ohm]

Sine Voltage Source sineVoltage1
Parameters

Comment	Name	Current Value	Unit
Amplitude of Sine Wave (Voltage)	V	230	[V]
Frequency of Sine Wave	f	rMS_Pulse.sf	[Hz]
Phase of Sine Wave	phase	0	[rad]
Voltage Offset	offset	0	[V]
Time Offset	startTime	0	[s]

RMS Calculator rMS_Sinusoid
Parameters

Comment	Name	Current Value	Unit
Input Signal	s	resistor5.v	[-]
Signal Frequency	sf	rMS_Pulse.sf	[Hz]

Resistor resistor5
 Parameters

Comment	Name	Current Value	Unit
Resistance	R	1000	[Ohm]

RMS Calculator rMS_DC
 Parameters

Comment	Name	Current Value	Unit
Input Signal	s	resistor6.v	[-]
Signal Frequency	sf	rMS_Pulse.sf	[Hz]

Resistor resistor6
 Parameters

Comment	Name	Current Value	Unit
Resistance	R	1000	[Ohm]

Constant Voltage Source constantVoltage1
 Parameters

Comment	Name	Current Value	Unit
Constant Voltage	V	230	[V]

constantVoltage1.v, ...

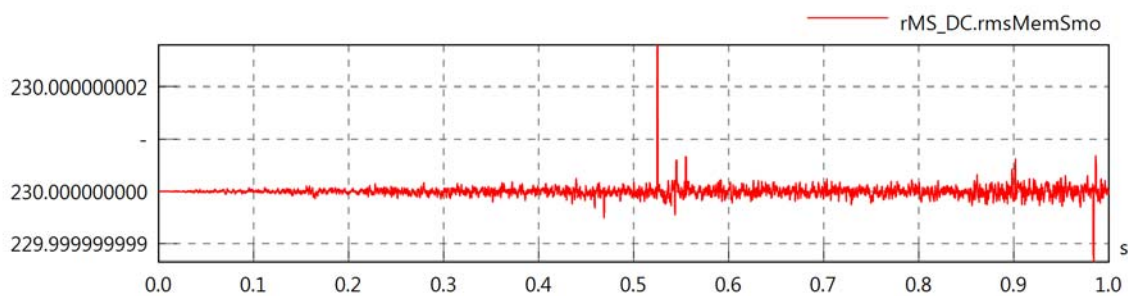
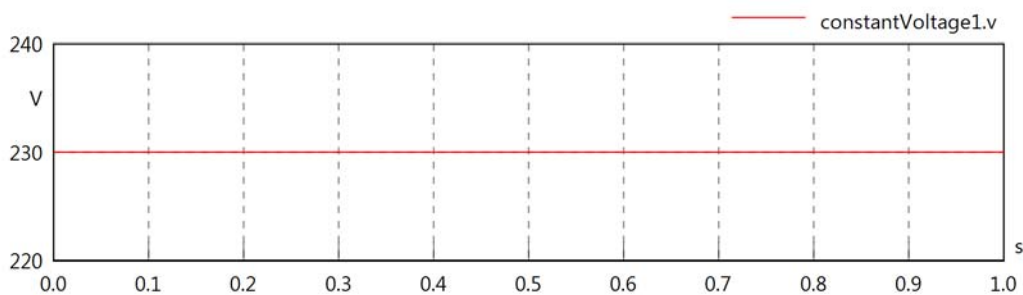

sineVoltage1.v, ...

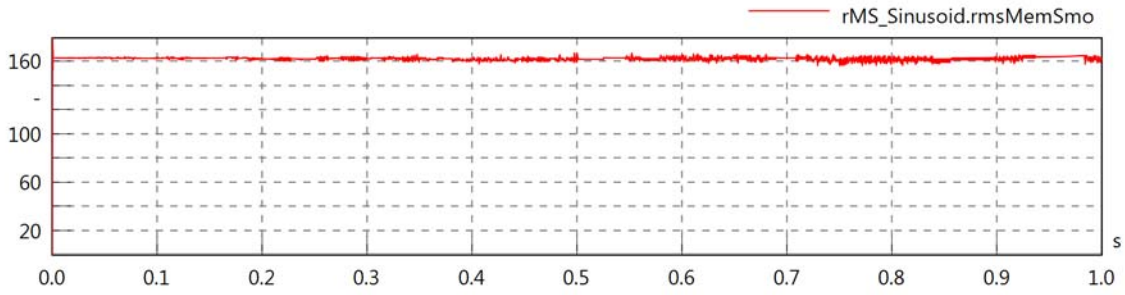
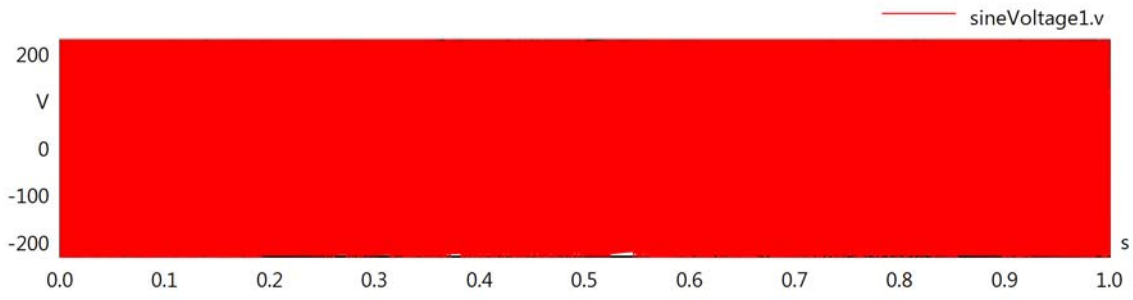

pulseVoltage2.v, ...

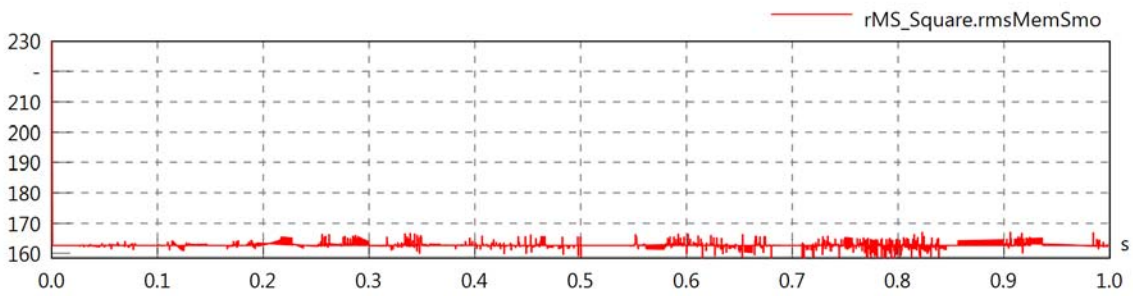
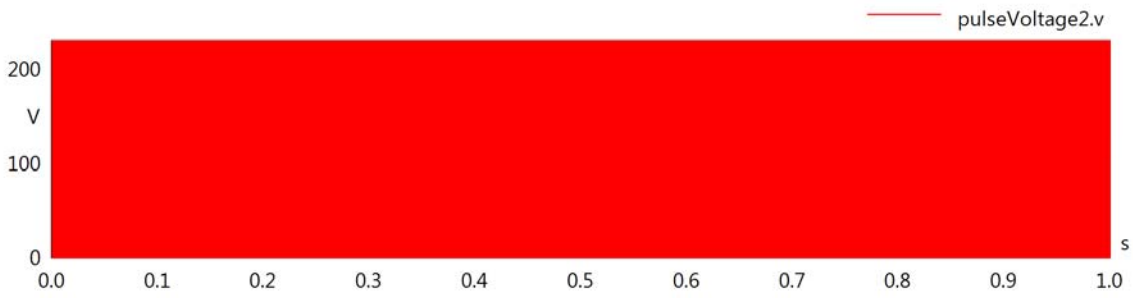

trapezoidVoltage1.v, ...

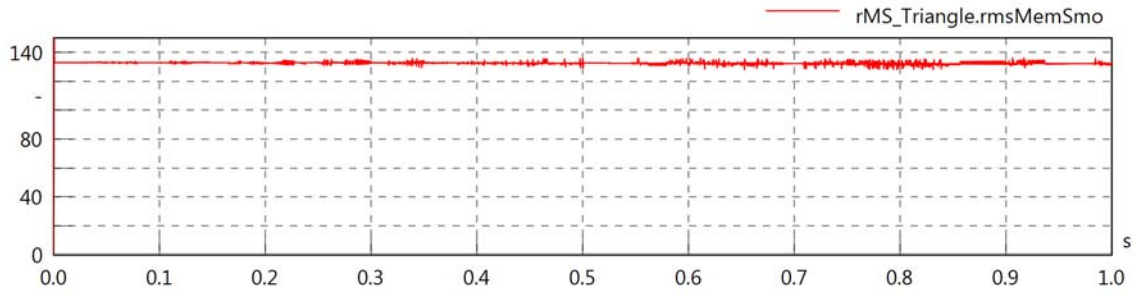
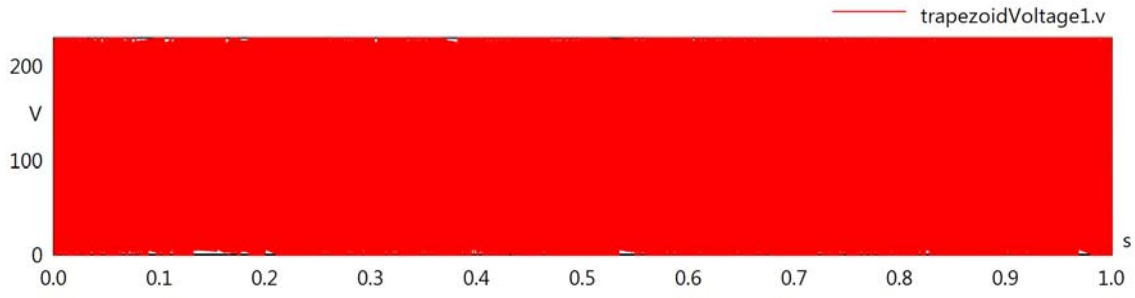

sawToothVoltage1.v, ...

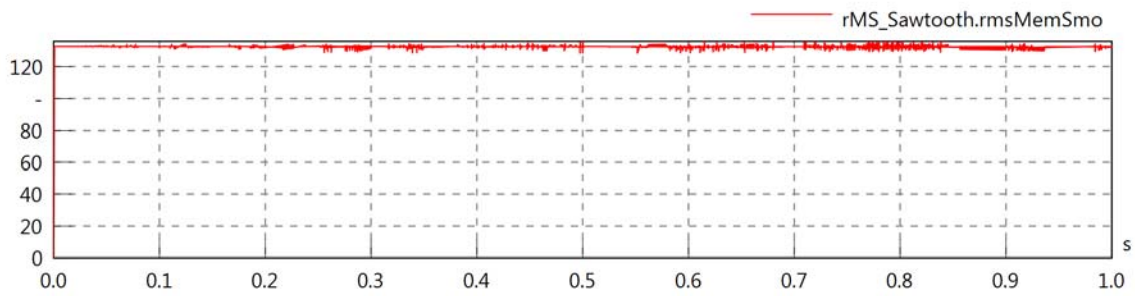
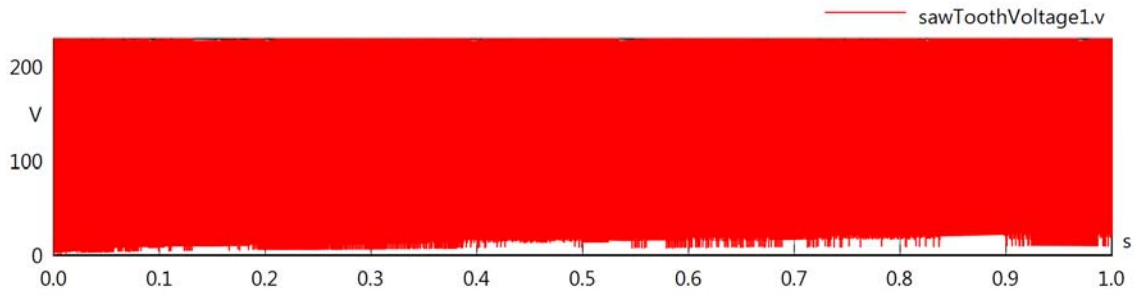

pulseVoltage1.v, ...

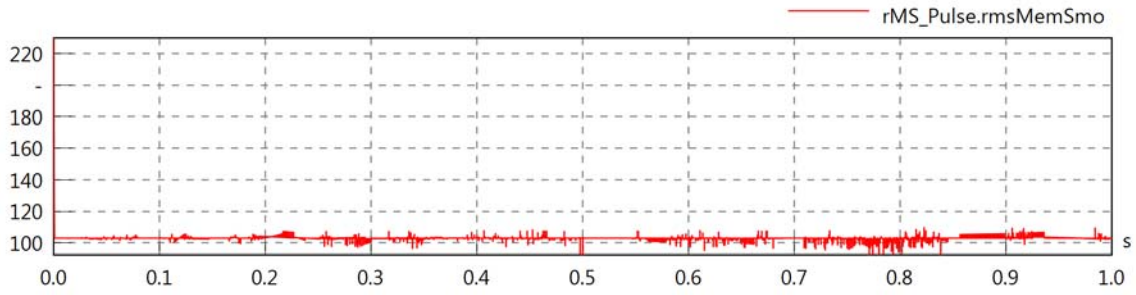
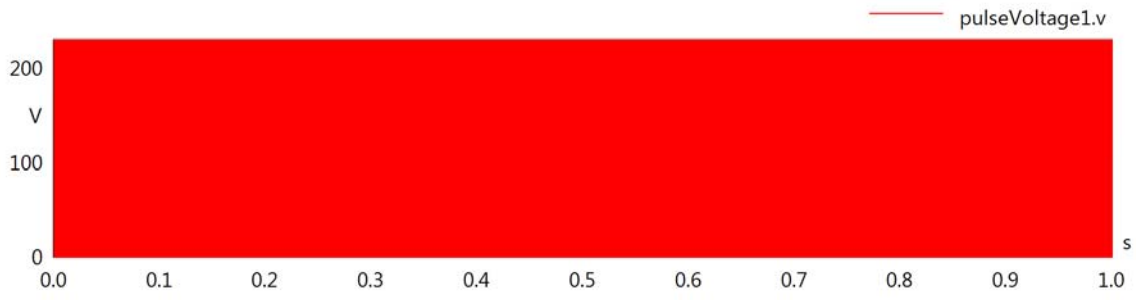
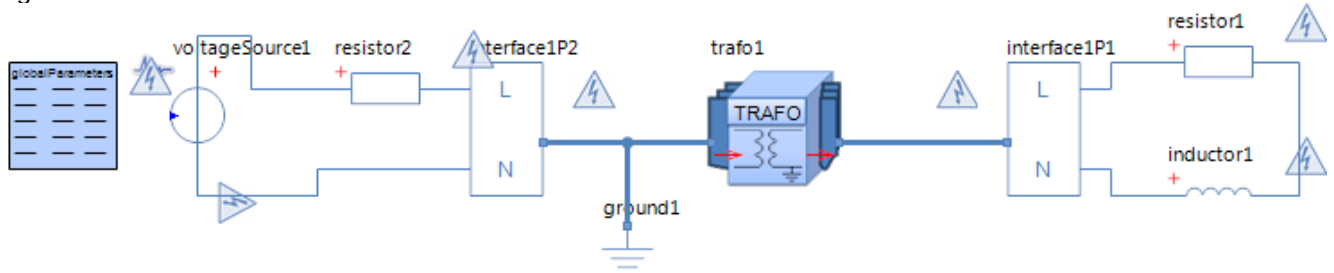

Diagram View



Transformer trafo1

Parameters

Comment	Name	Current Value	Unit
Transformer Type	kind	Lossless Transformer	
Primary Inductance	L1	400	[mH]
Initial Value	i10	0 (Fixed)	[A]
Secondary Inductance	L2	800	[mH]
Initial Value	i20	0 (Fixed)	[A]
Mutual Coupling Inductance	M	$0.75 \cdot \sqrt{L1 \cdot L2}$	[H]

Voltage Source voltageSource1

Parameters

Comment	Name	Current Value	Unit
Voltage	v_src	$230 \cdot \sqrt{2} \cdot \sin(2 \cdot \pi \cdot t \cdot 30)$	[V]

Resistor resistor1

Parameters

Comment	Name	Current Value	Unit
Resistance	R	50	[Ohm]

Inductor inductor1

Parameters

Comment	Name	Current Value	Unit
Inductance	L	10	[mH]
Initial Value	i0	0 (Fixed)	[A]
Kind	kind	absolute	

Resistor resistor2

Parameters

Comment	Name	Current Value	Unit
Resistance	R	10	[Ohm]

trafo1.n

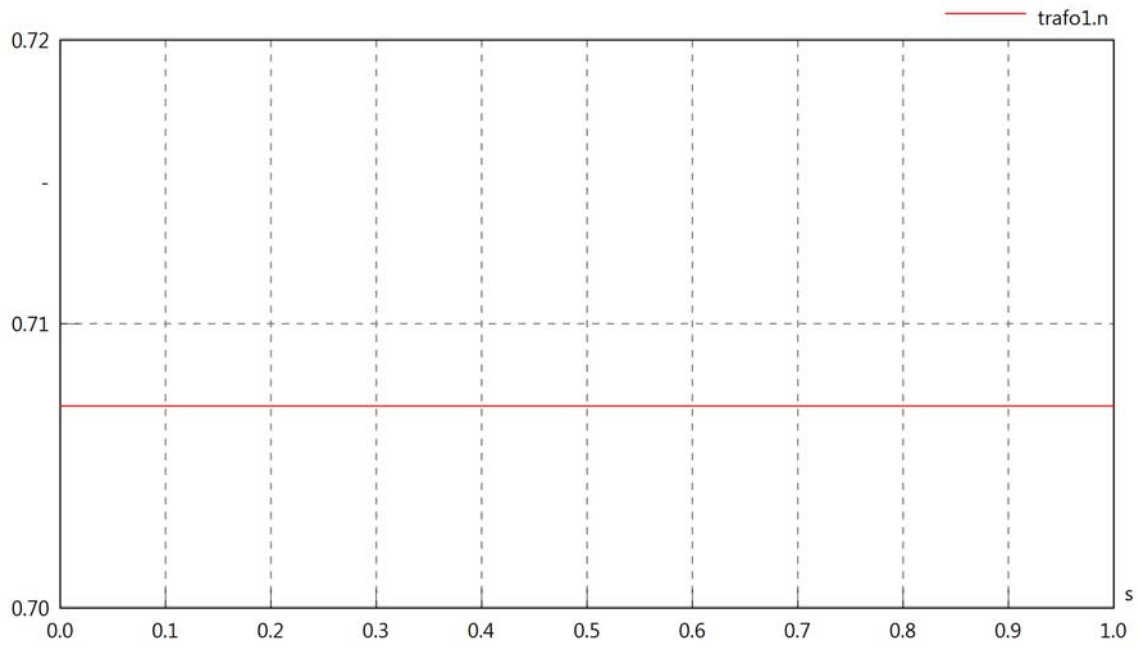

trafo1.k

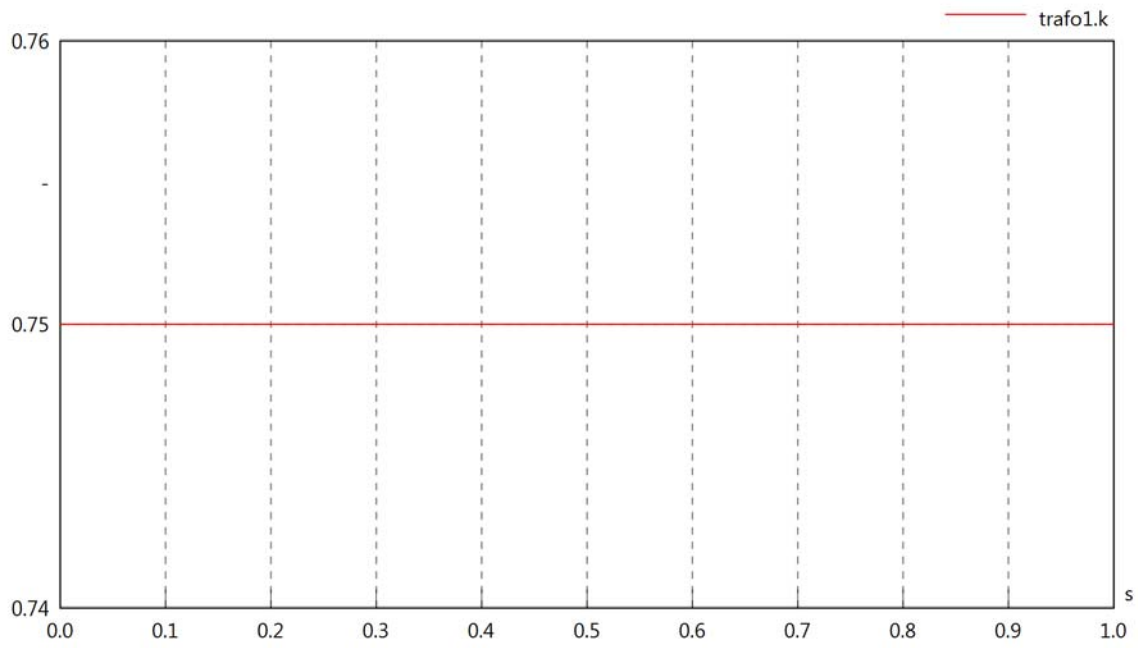

trafo1.vIn

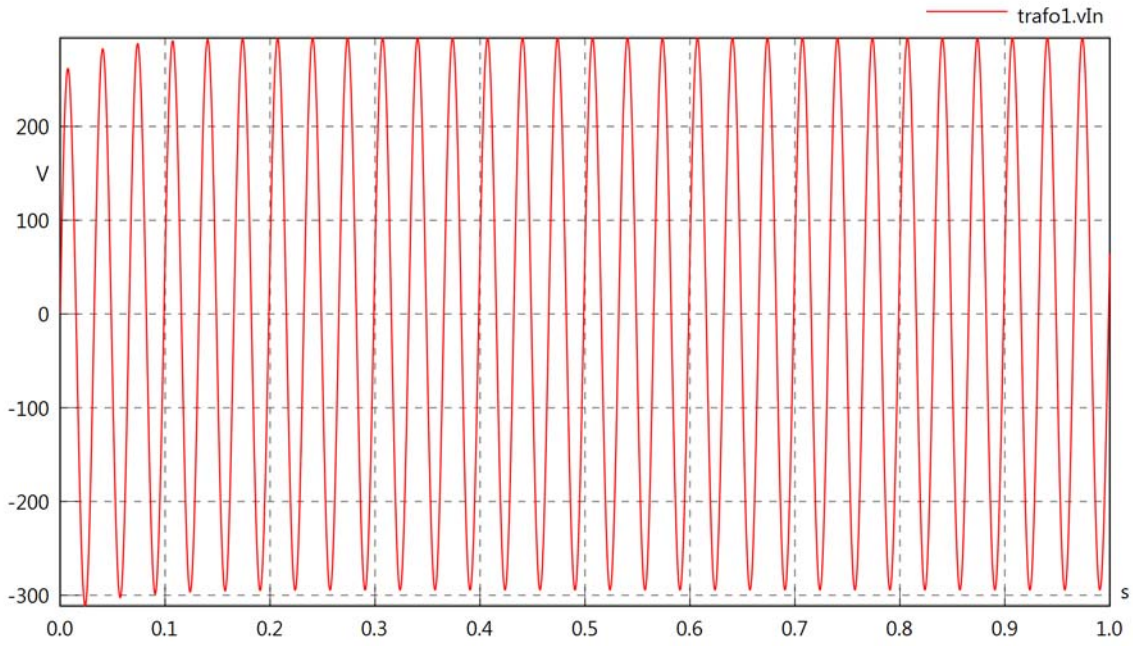

trafo1.iIn

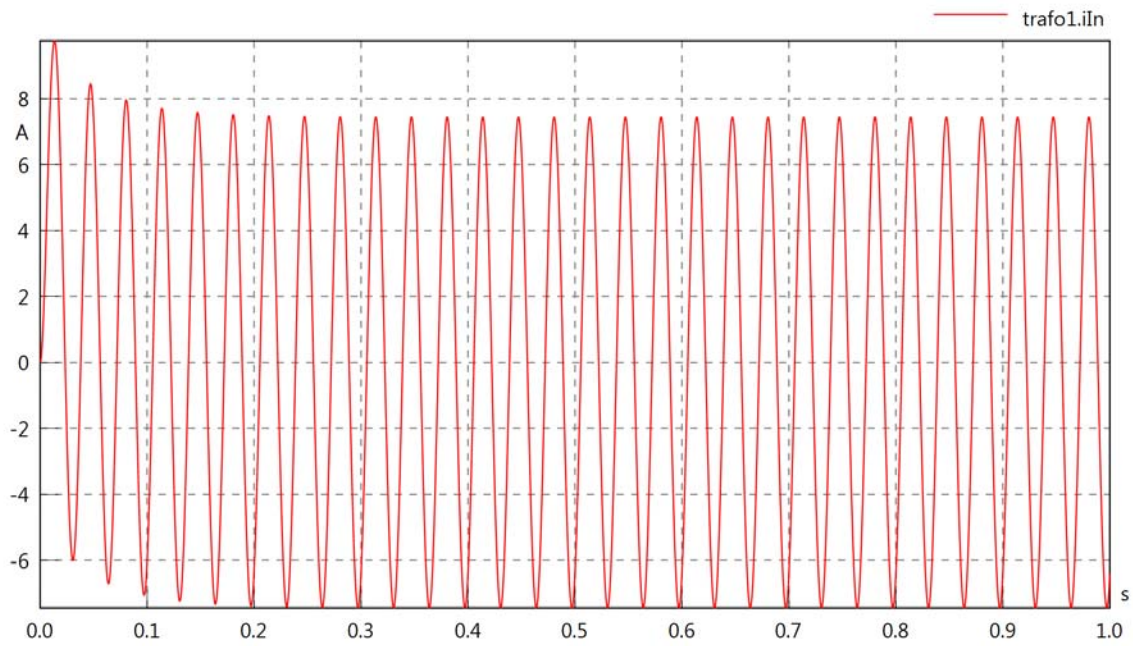

trafo1.PIn

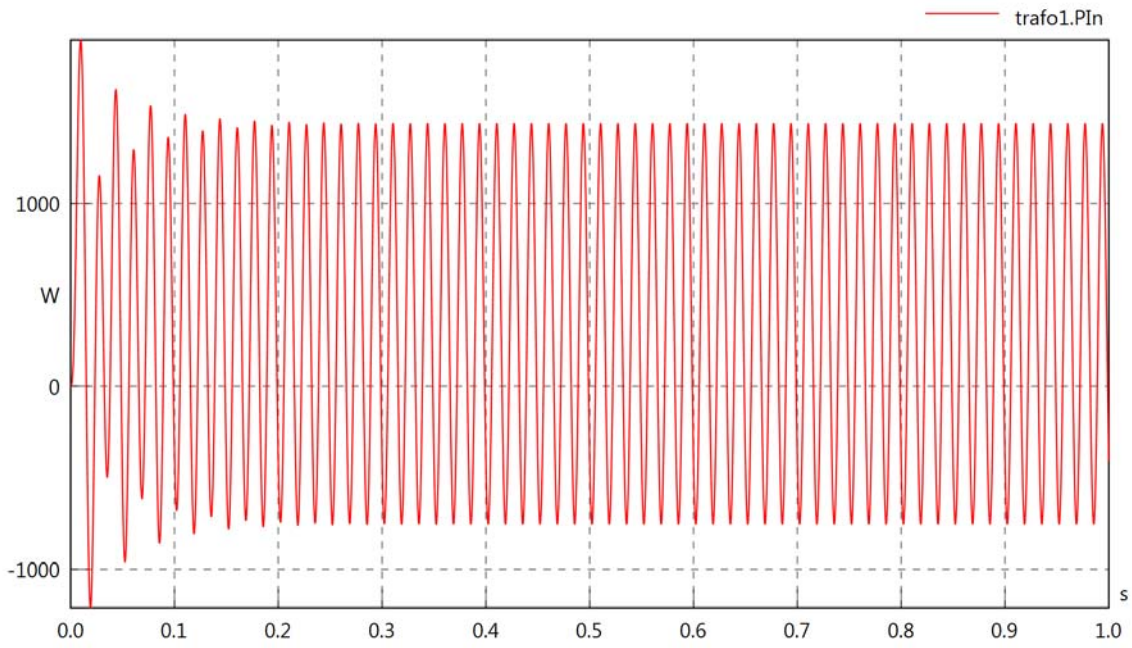

trafo1.vOut

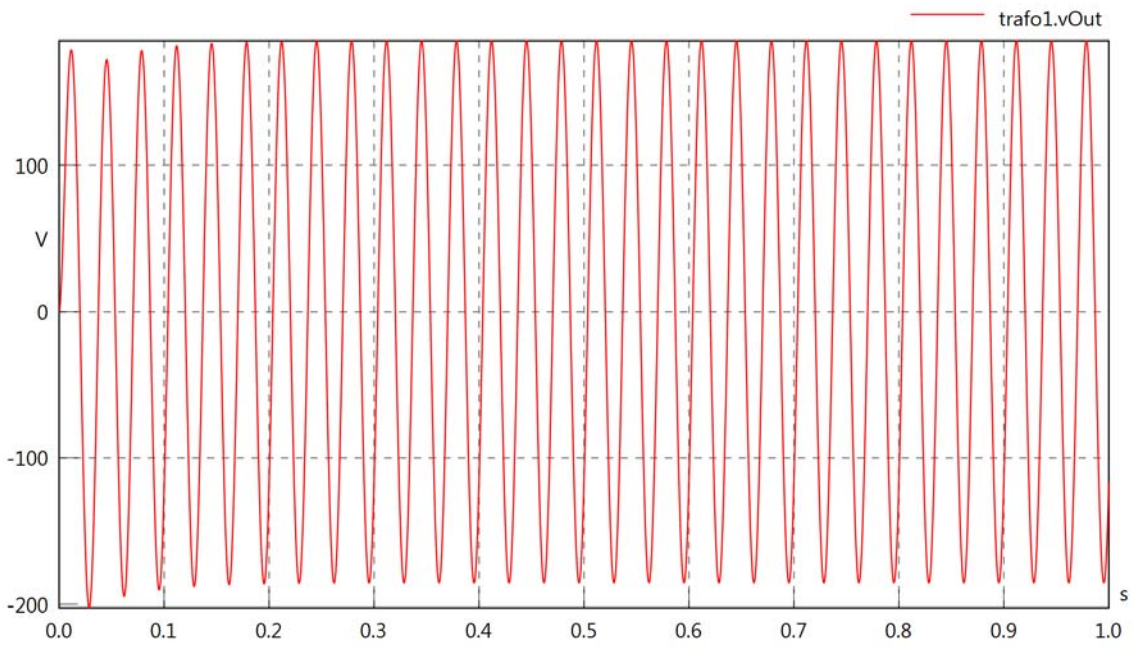

trafo1.iOut

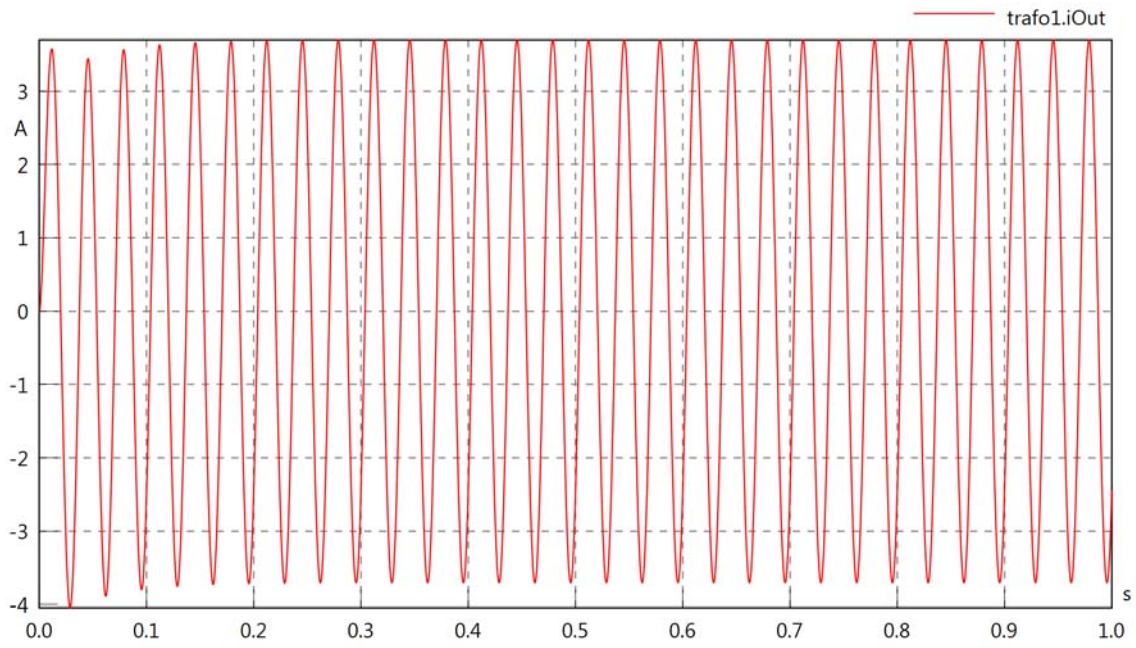

trafo1.POut

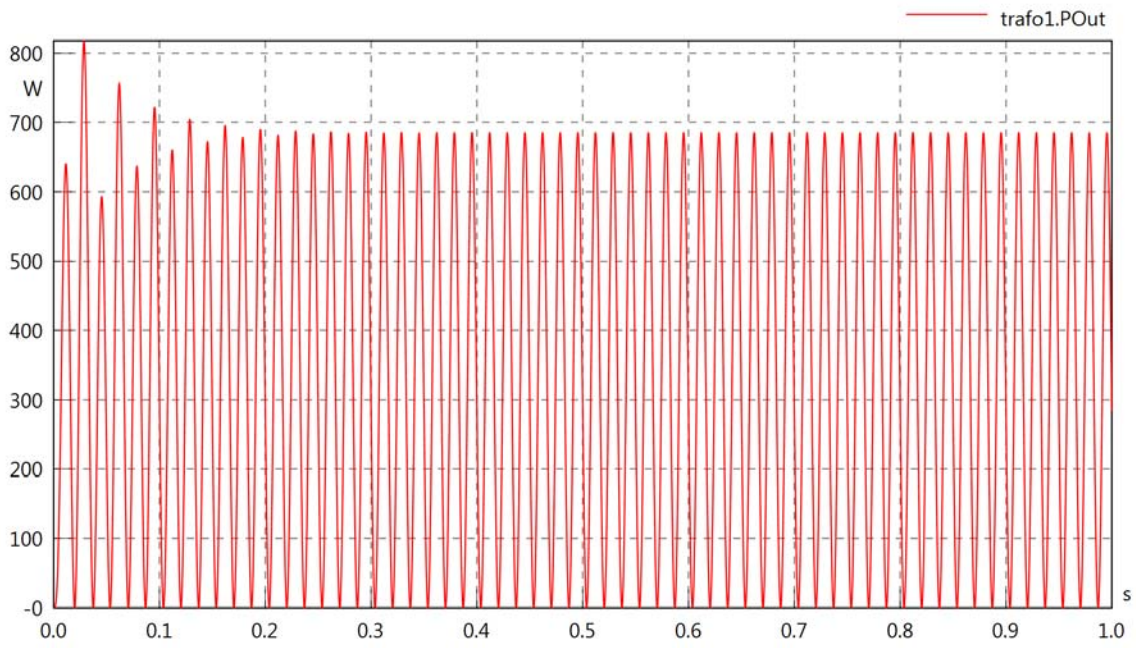

trafo1.PI

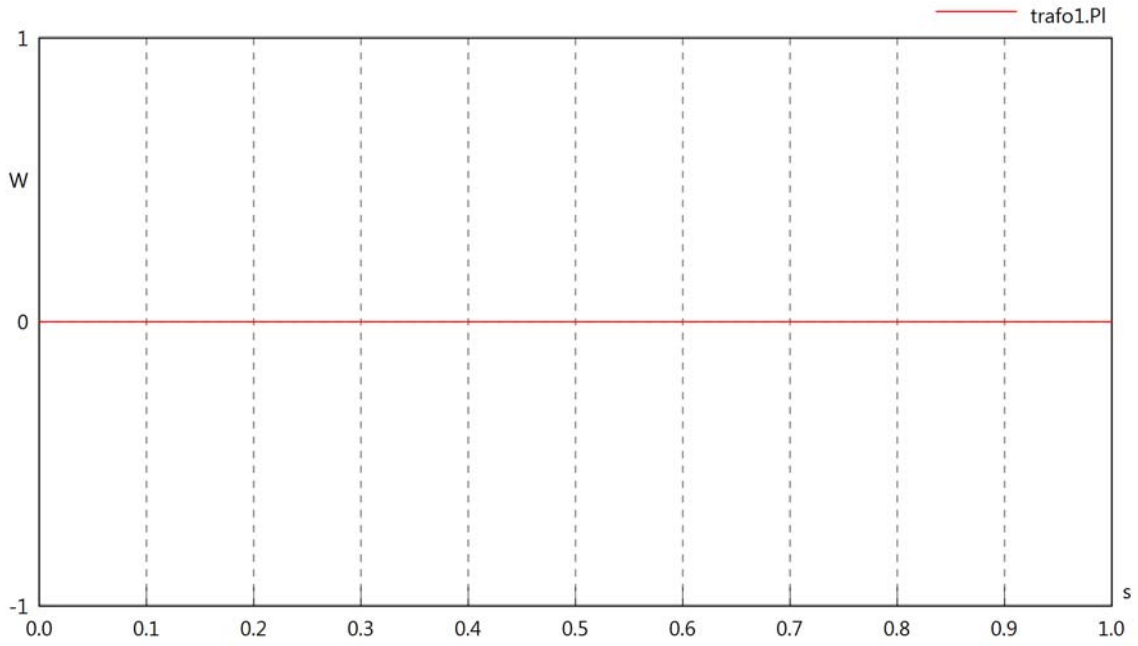

trafo1.Pmag

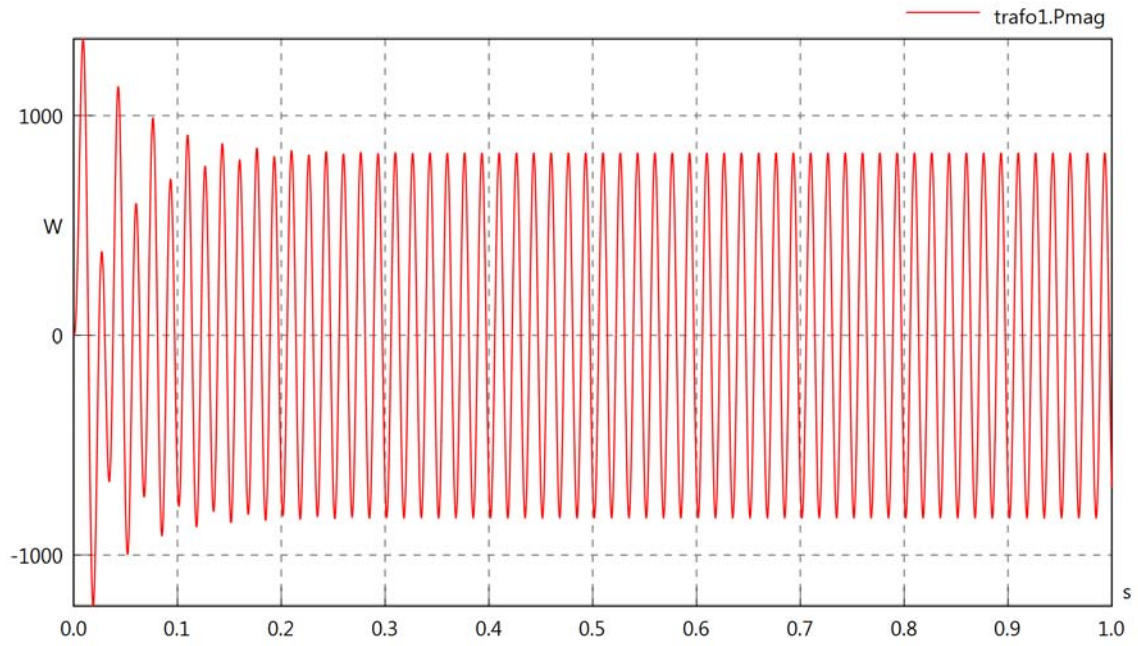
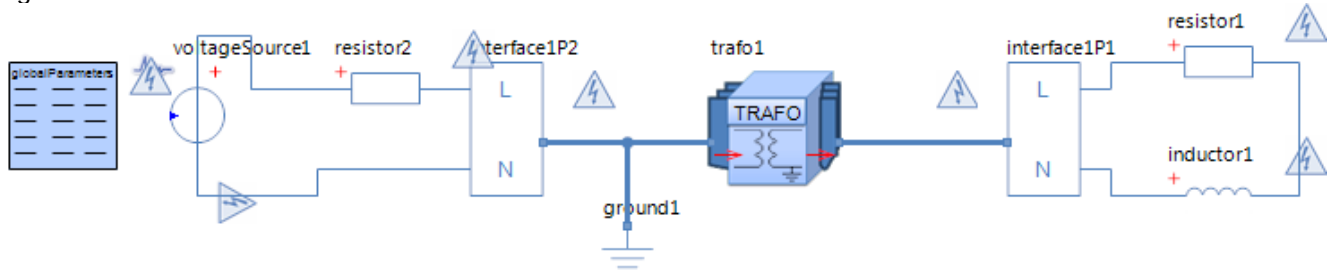

Diagram View



Transformer trafo1

Parameters

Comment	Name	Current Value	Unit
Transformer Type	kind	Lossless Transformer	
Primary Inductance	L1	400	[mH]
Initial Value	i10	0 (Fixed)	[A]
Secondary Inductance	L2	800	[mH]
Initial Value	i20	0 (Fixed)	[A]
Mutual Coupling Inductance	M	$0.75 \cdot \sqrt{L1 \cdot L2}$	[H]

Voltage Source voltageSource1

Parameters

Comment	Name	Current Value	Unit
Voltage	v_src	$230 \cdot \sqrt{2} \cdot \sin(2 \cdot \pi \cdot t \cdot 60)$	[V]

Resistor resistor1

Parameters

Comment	Name	Current Value	Unit
Resistance	R	50	[Ohm]

Inductor inductor1

Parameters

Comment	Name	Current Value	Unit
Inductance	L	10	[mH]
Initial Value	i0	0 (Fixed)	[A]
Kind	kind	absolute	

Resistor resistor2

Parameters

Comment	Name	Current Value	Unit
Resistance	R	10	[Ohm]

trafo1.n

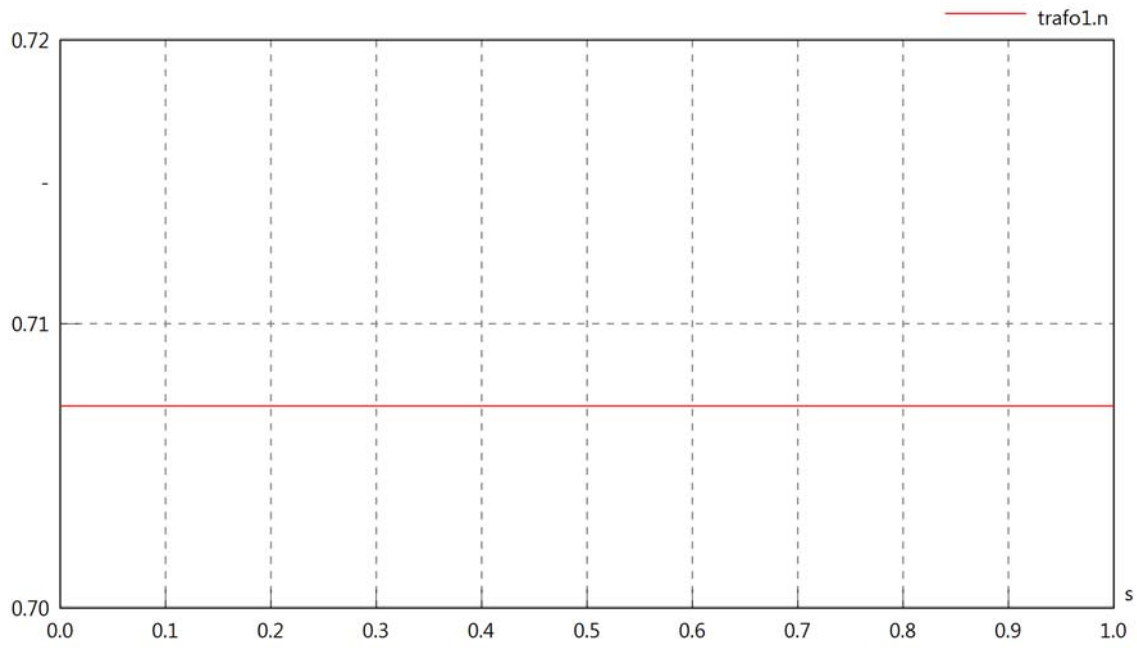

trafo1.k

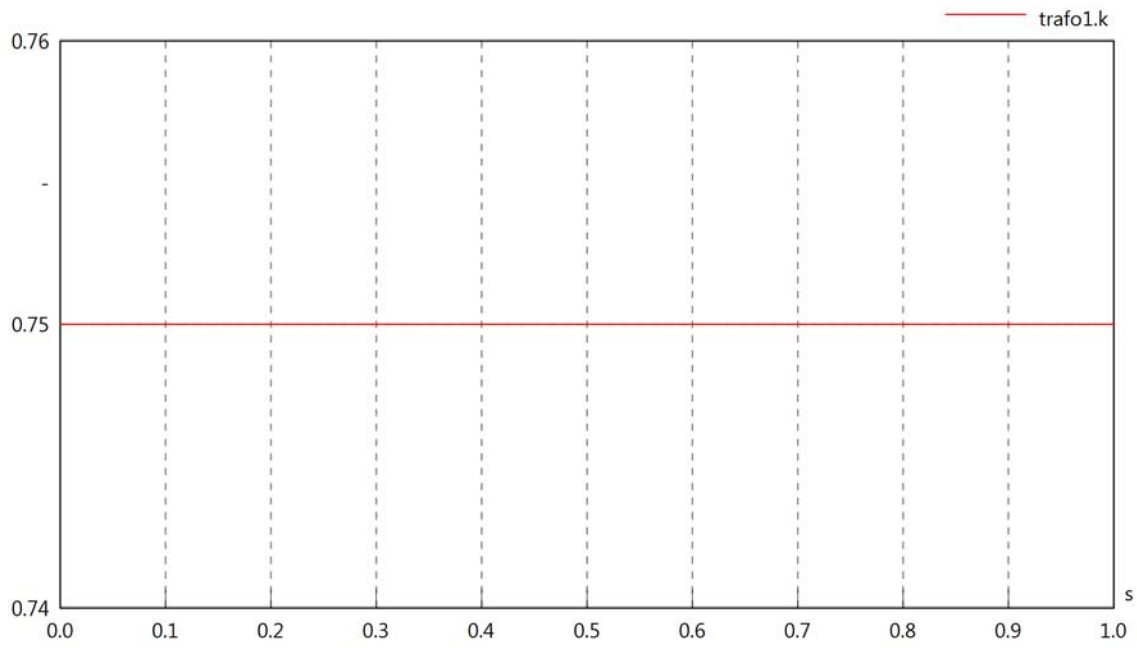

trafo1.vIn

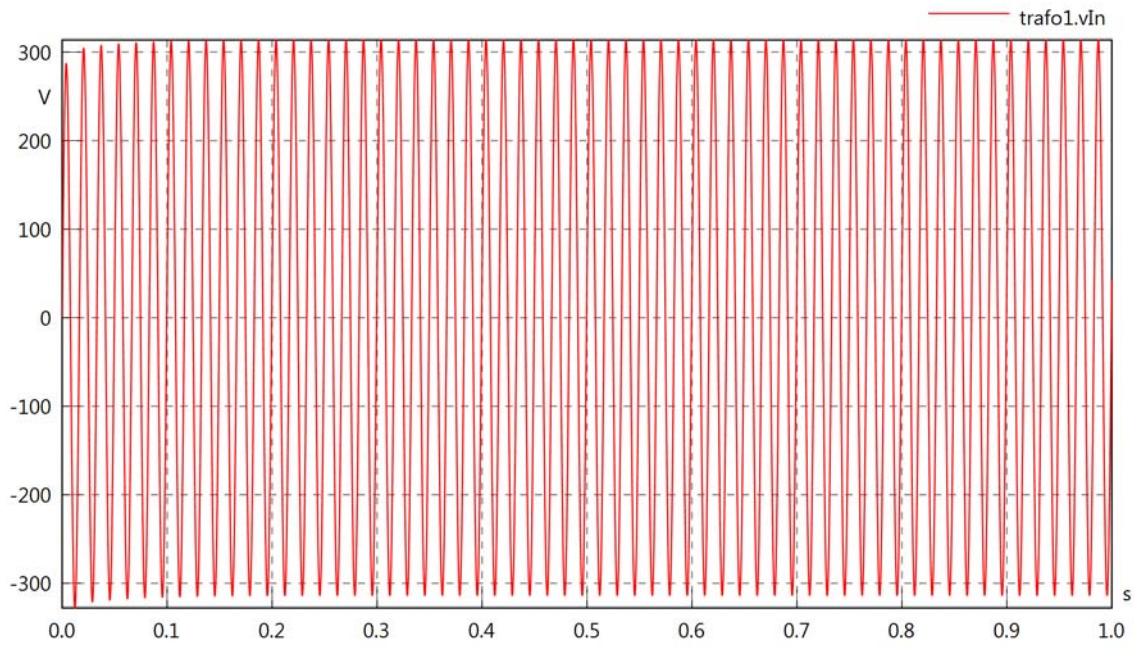

trafo1.iIn

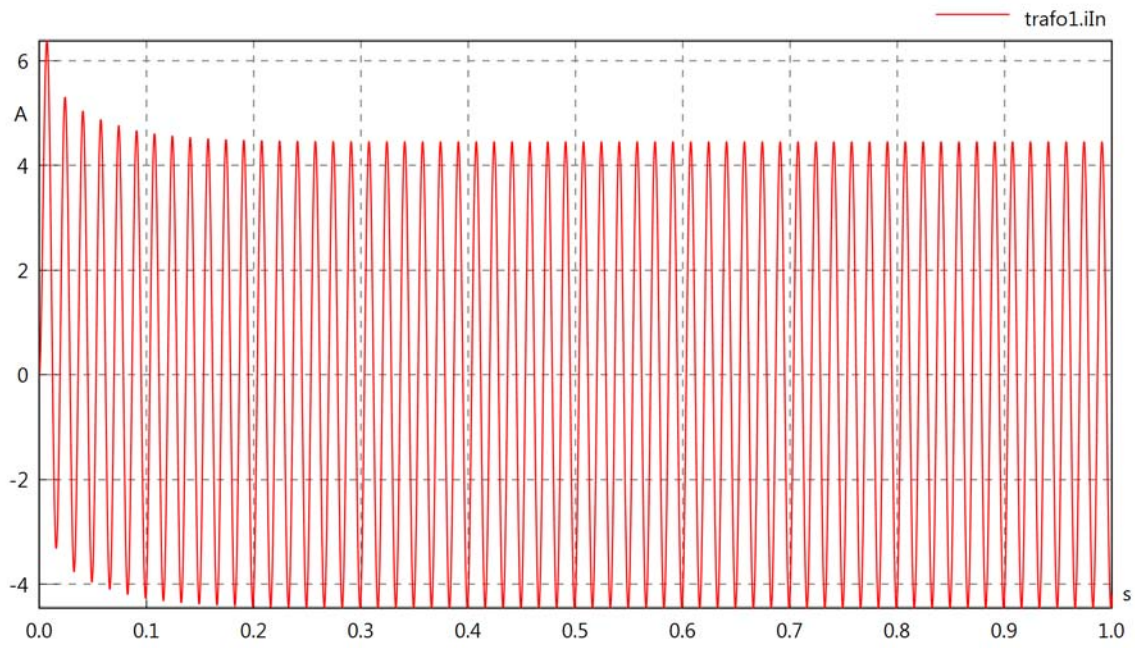

trafo1.PIn

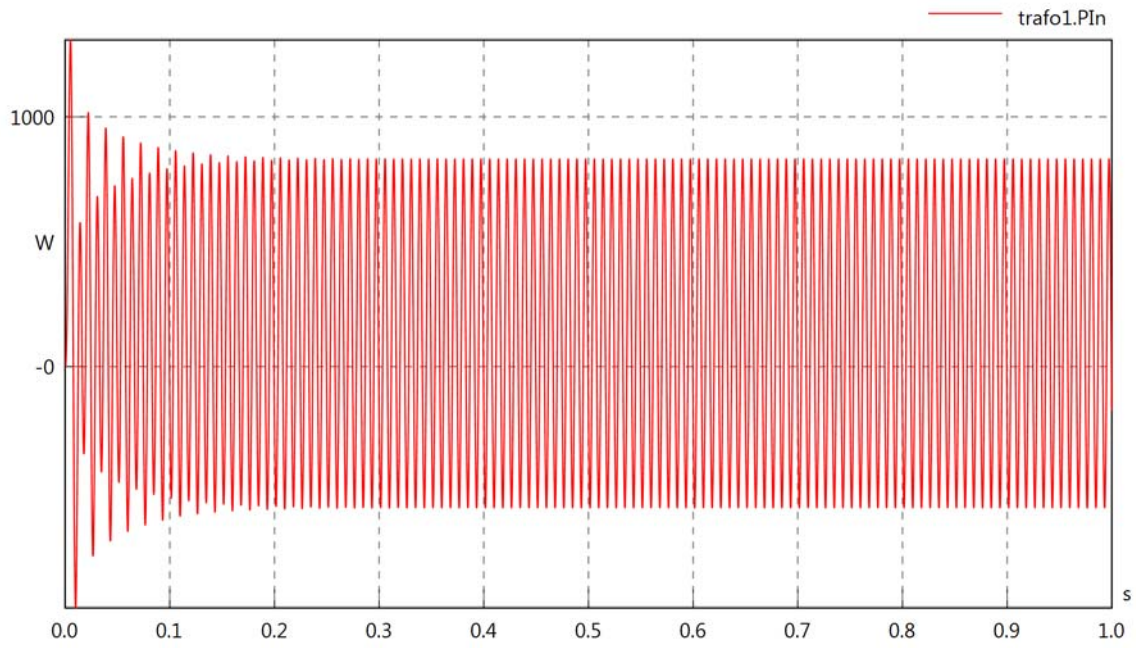

trafo1.vOut

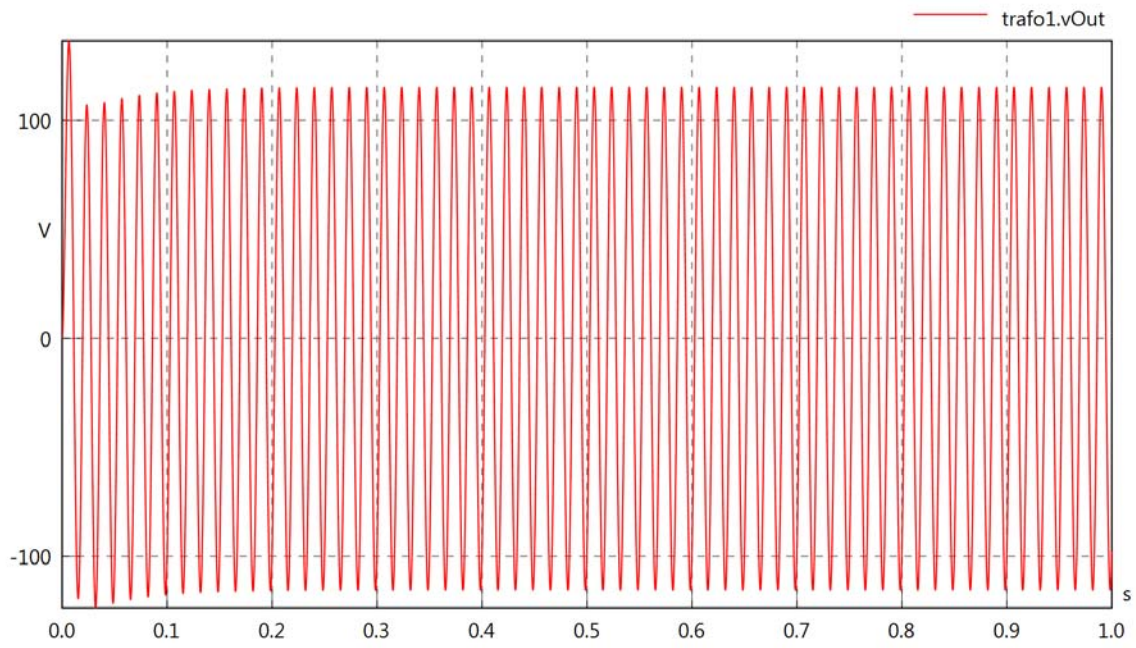

trafo1.iOut

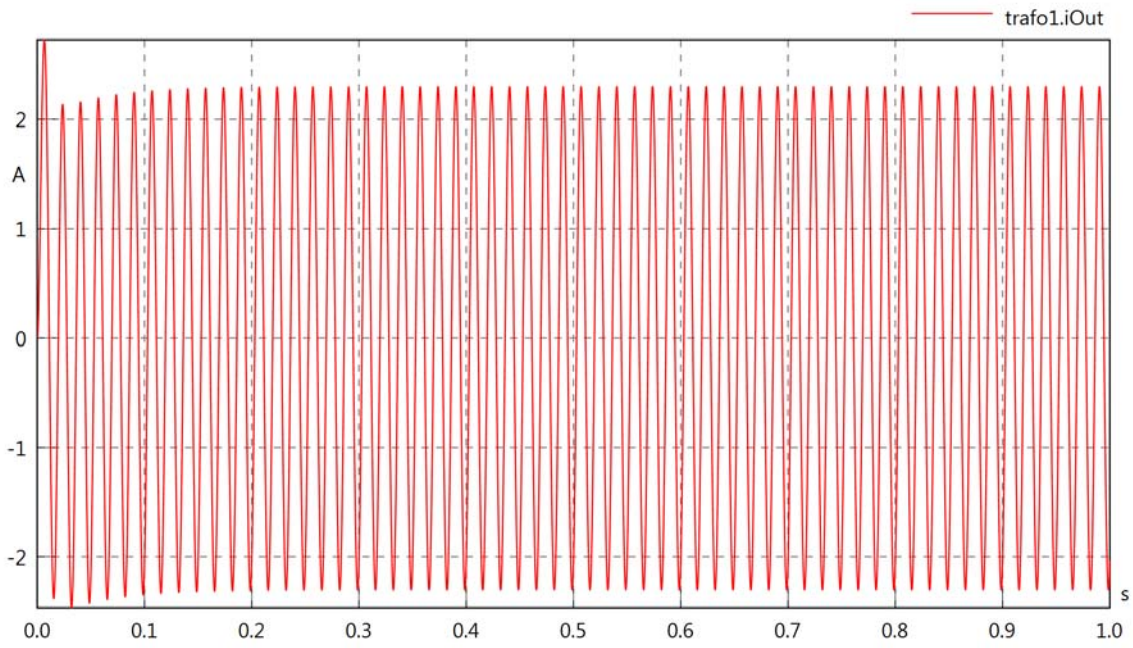

trafo1.POut

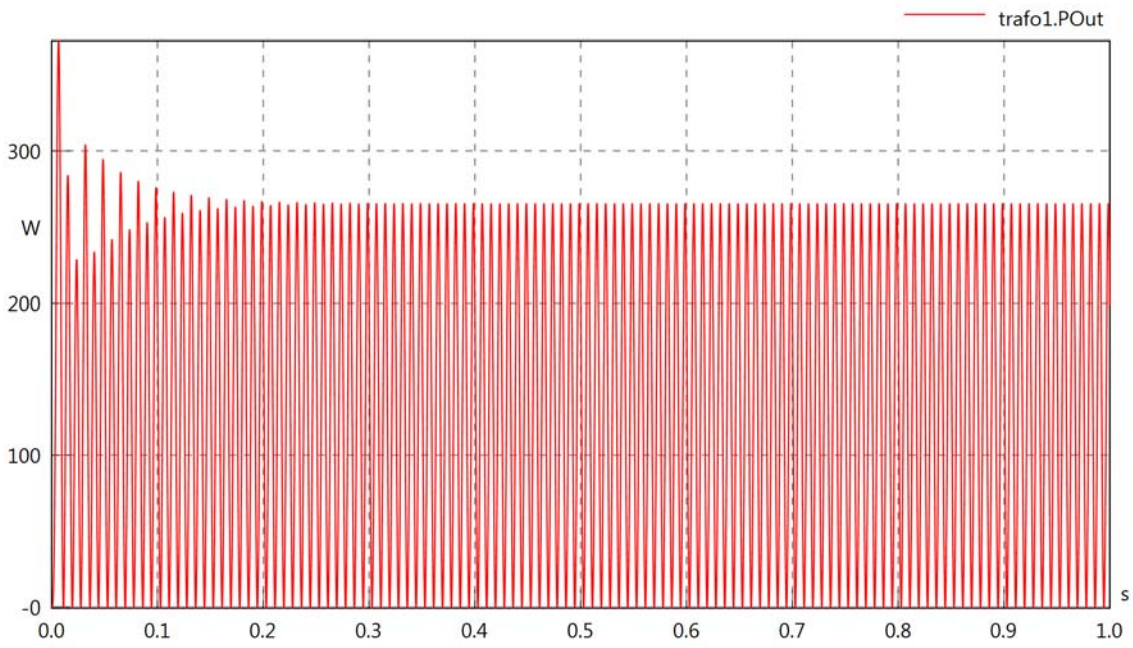

trafo1.PI

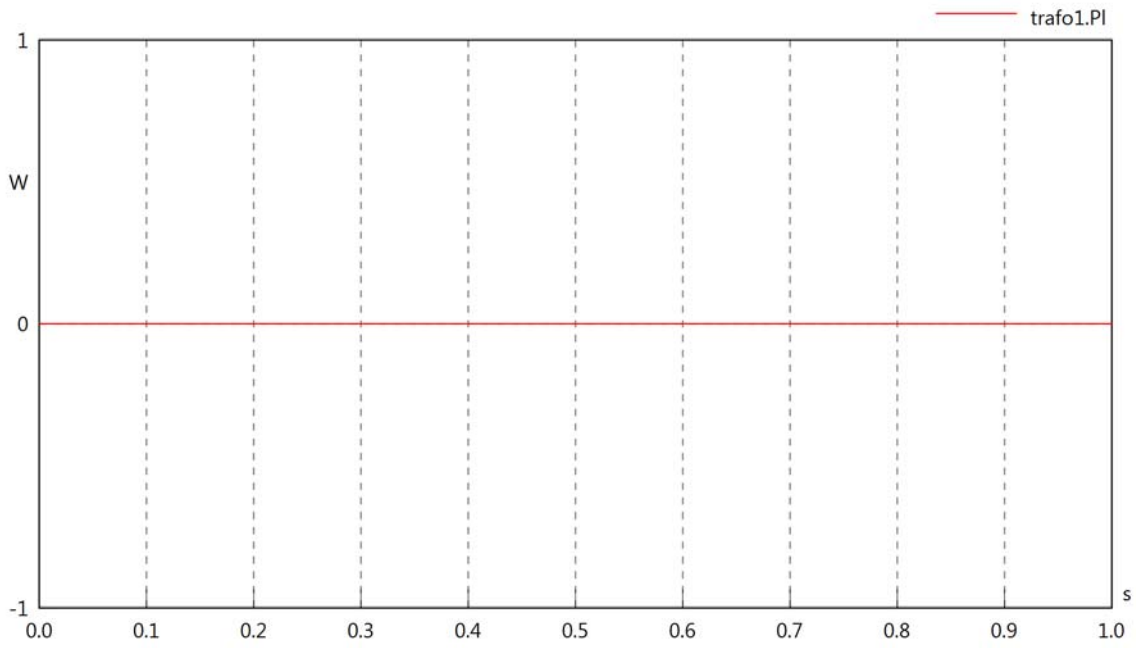

trafo1.Pmag

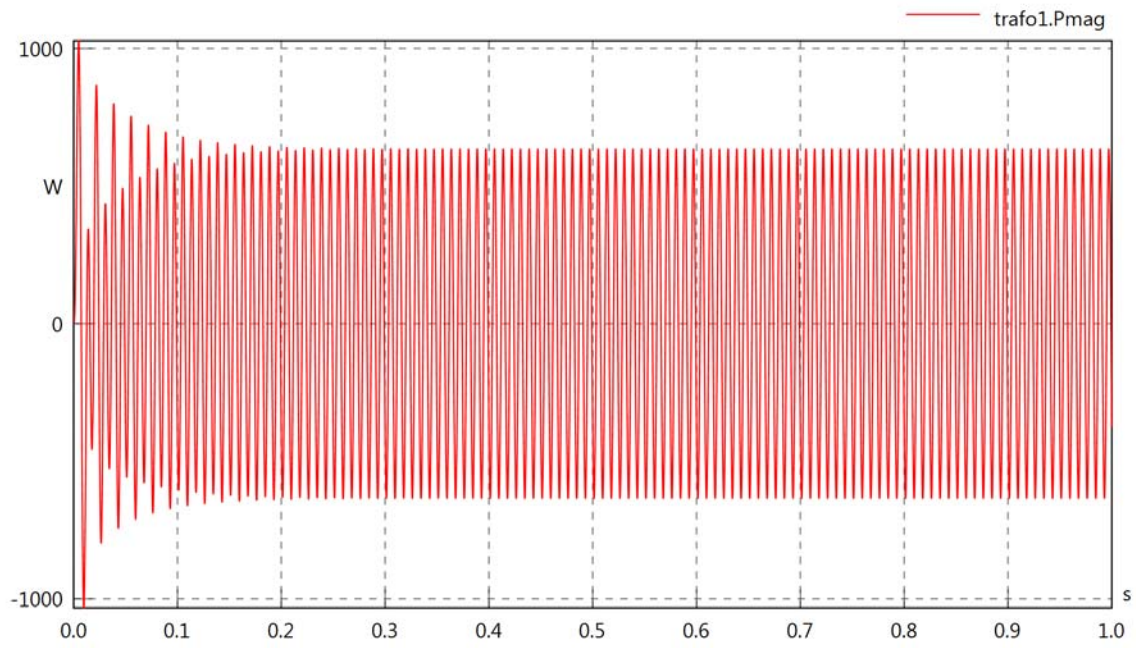
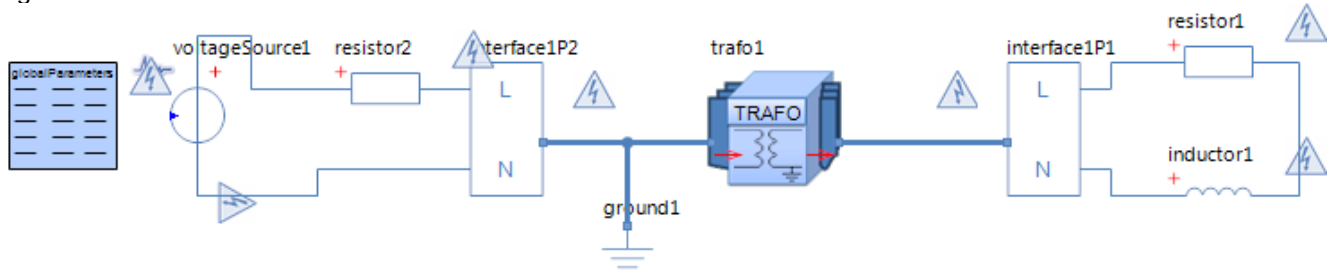

Diagram View



Transformer trafo1

Parameters

Comment	Name	Current Value	Unit
Transformer Type	kind	Lossless Transformer	
Primary Inductance	L1	400	[mH]
Initial Value	i10	0 (Fixed)	[A]
Secondary Inductance	L2	800	[mH]
Initial Value	i20	0 (Fixed)	[A]
Mutual Coupling Inductance	M	$0.75 \cdot \sqrt{L1 \cdot L2}$	[H]

Voltage Source voltageSource1

Parameters

Comment	Name	Current Value	Unit
Voltage	v_src	$230 \cdot \sqrt{2} \cdot \sin(2 \cdot \pi \cdot t \cdot 120)$	[V]

Resistor resistor1

Parameters

Comment	Name	Current Value	Unit
Resistance	R	50	[Ohm]

Inductor inductor1

Parameters

Comment	Name	Current Value	Unit
Inductance	L	10	[mH]
Initial Value	i0	0 (Fixed)	[A]
Kind	kind	absolute	

Resistor resistor2

Parameters

Comment	Name	Current Value	Unit
Resistance	R	10	[Ohm]

trafo1.n

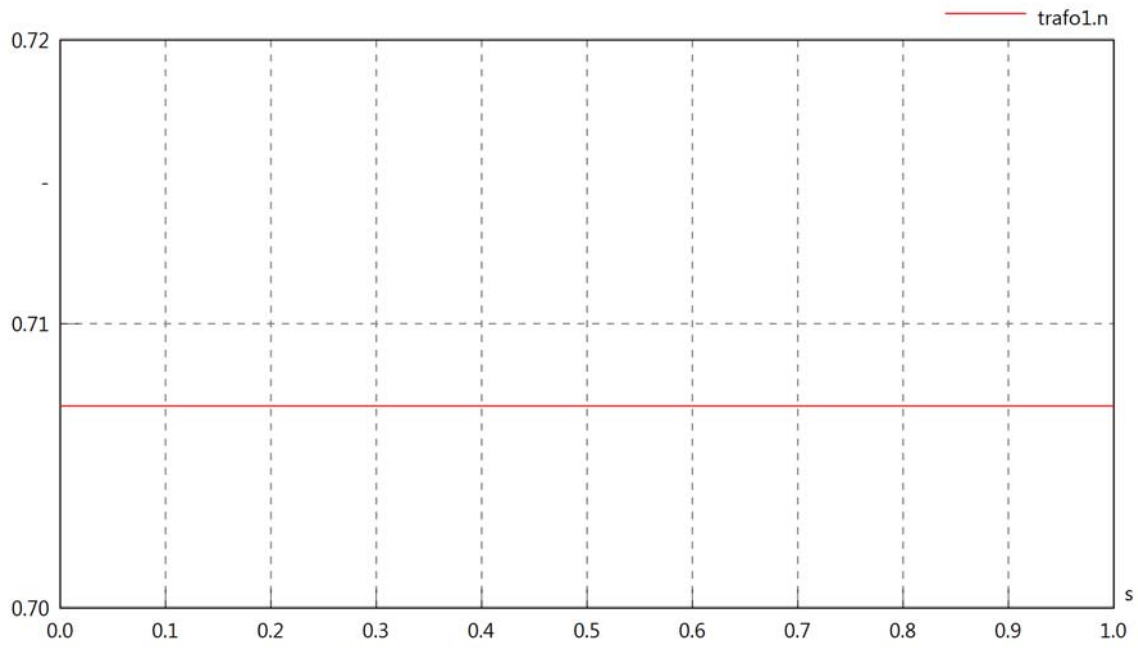

trafo1.k

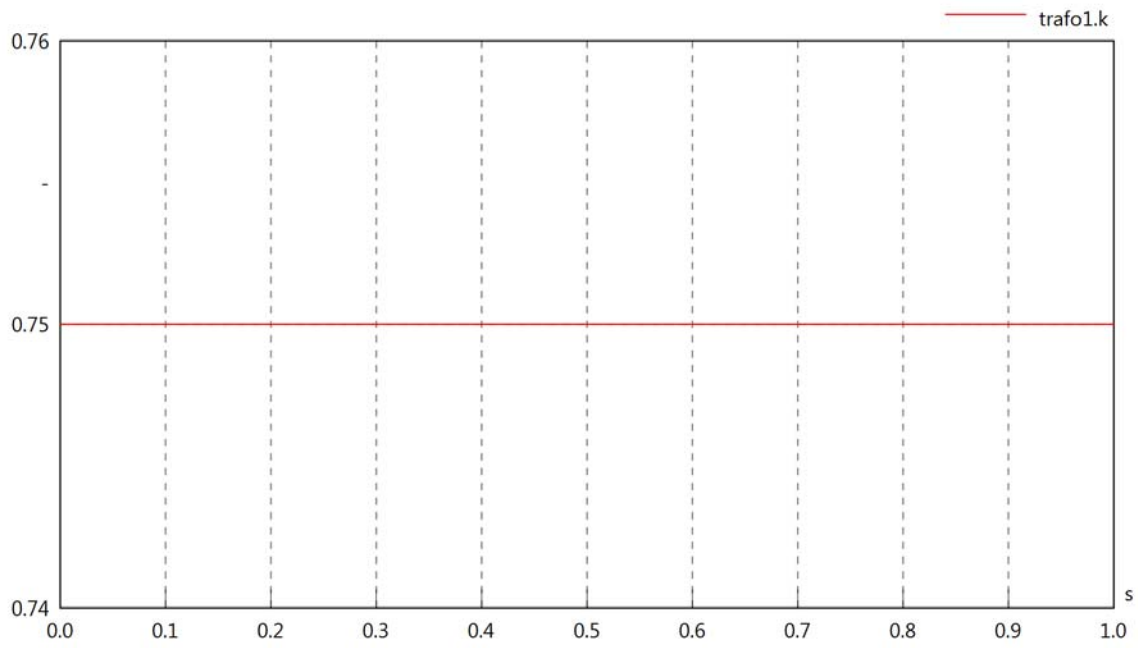

trafo1.vIn

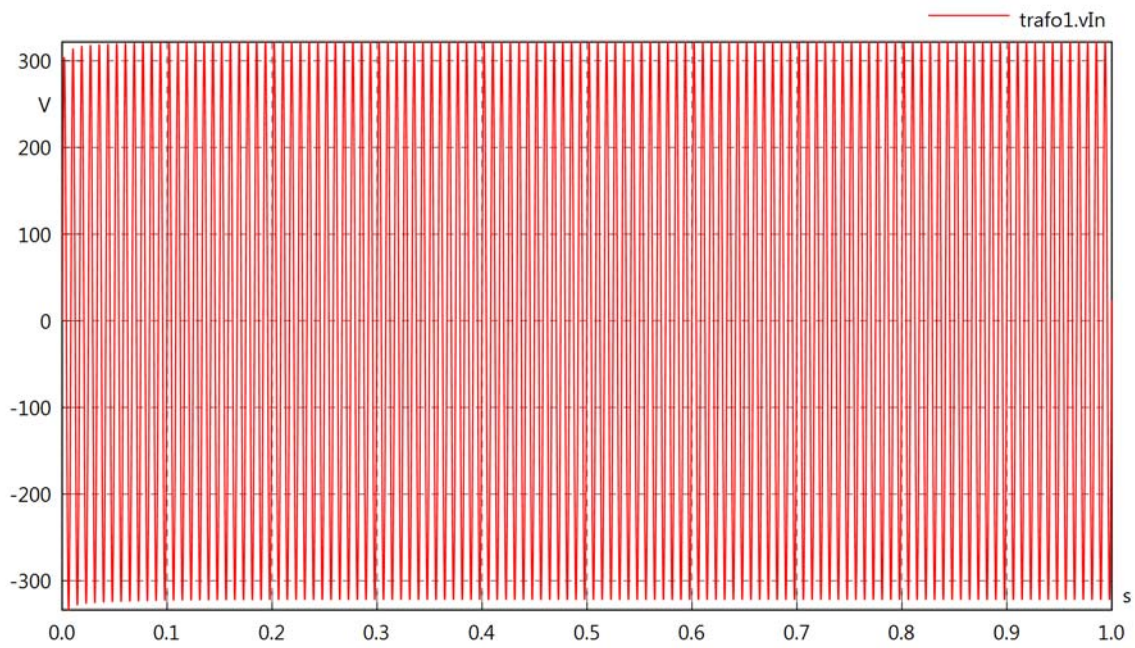

trafo1.iIn

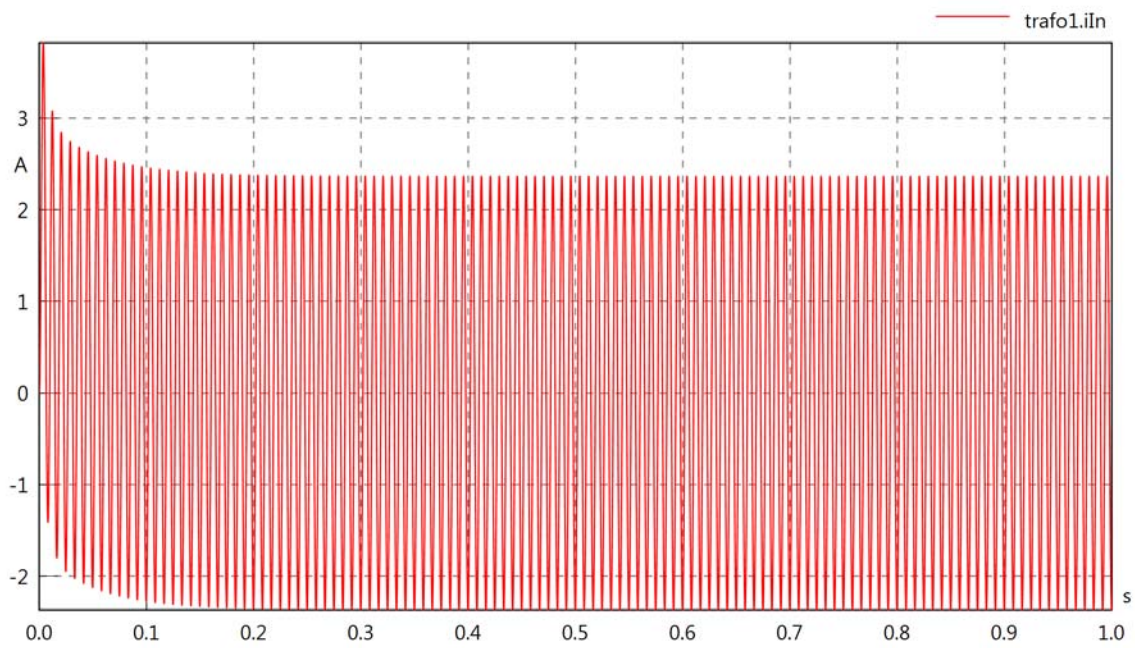

trafo1.PIn

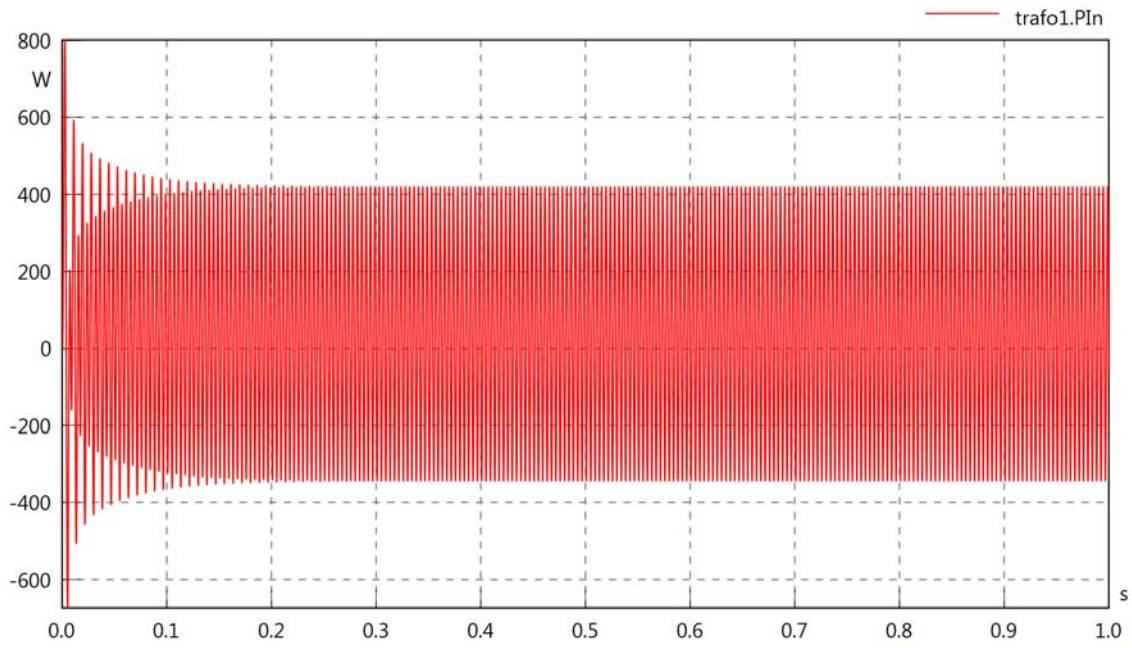

trafo1.vOut

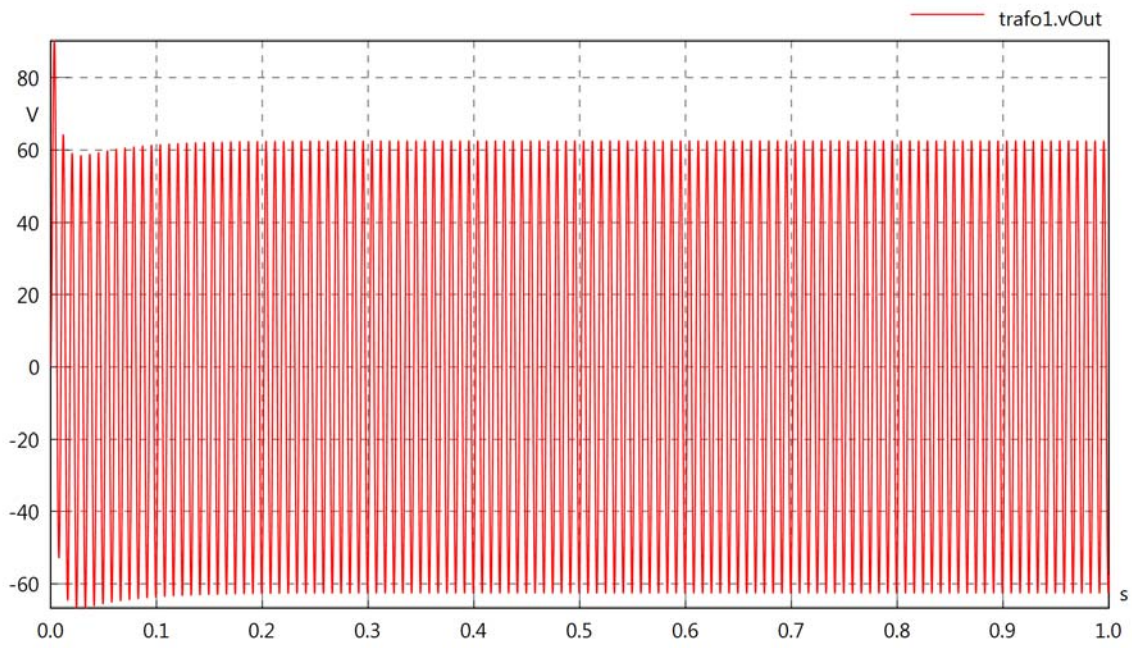

trafo1.iOut

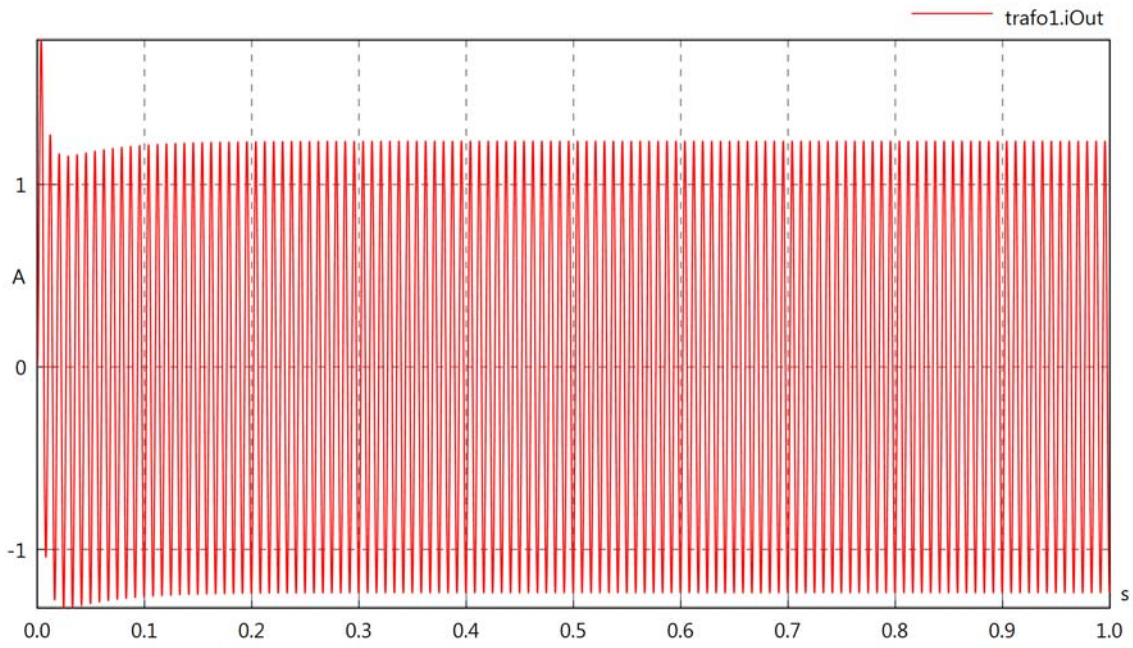

trafo1.POut

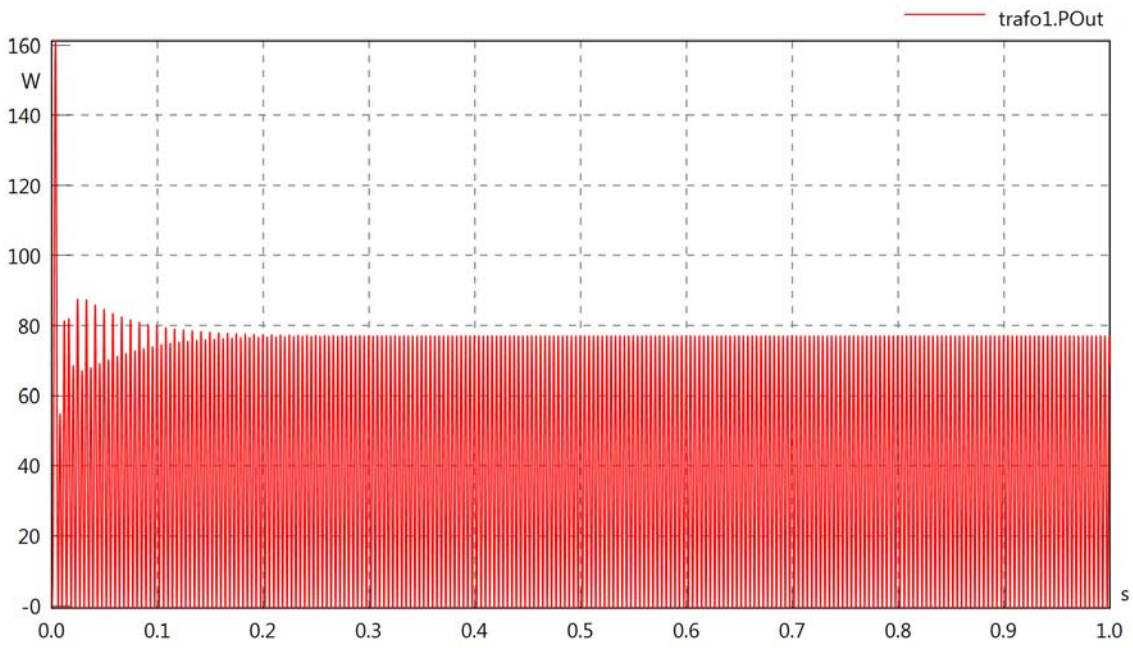

trafo1.PI

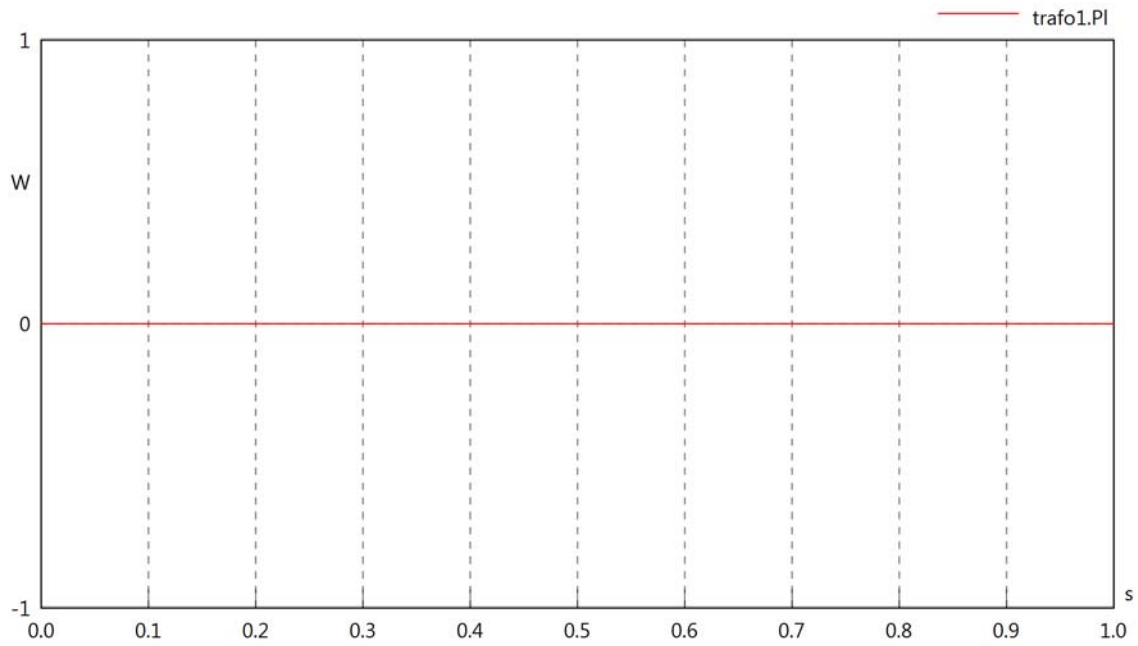

trafo1.Pmag

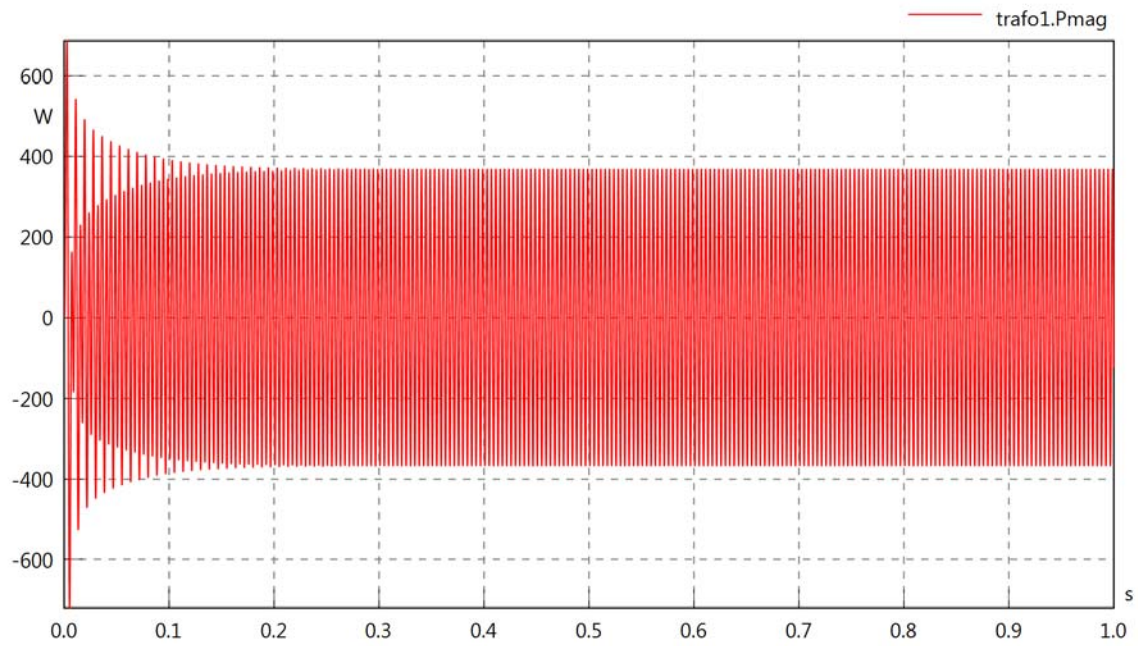
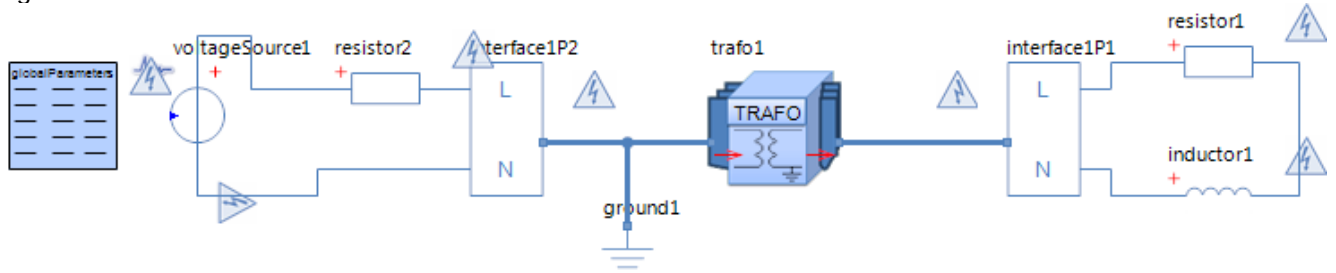

Diagram View



Transformer trafo1

Parameters

Comment	Name	Current Value	Unit
Transformer Type	kind	Lossy Transformer	
Primary Winding Resistance	R1	5	[Ohm]
Primary Inductance	L1	400	[mH]
Initial Value	i10	0 (Fixed)	[A]
Secondary Winding Resistance	R2	5	[Ohm]
Secondary Inductance	L2	800	[mH]
Initial Value	i20	0 (Fixed)	[A]
Iron Loss Resistance	Rfe	50	[kOhm]
Mutual Coupling Inductance	M	$0.75 * \sqrt{L1 * L2}$	[H]

Voltage Source voltageSource1

Parameters

Comment	Name	Current Value	Unit
Voltage	v_src	$230 * \sqrt{2} * \sin(2 * \pi * t * 30)$	[V]

Resistor resistor1

Parameters

Comment	Name	Current Value	Unit
Resistance	R	50	[Ohm]

Inductor inductor1

Parameters

Comment	Name	Current Value	Unit
Inductance	L	10	[mH]
Initial Value	i0	0 (Fixed)	[A]
Kind	kind	absolute	

Resistor resistor2

Parameters

Comment	Name	Current Value	Unit
Resistance	R	10	[Ohm]

trafo1.n

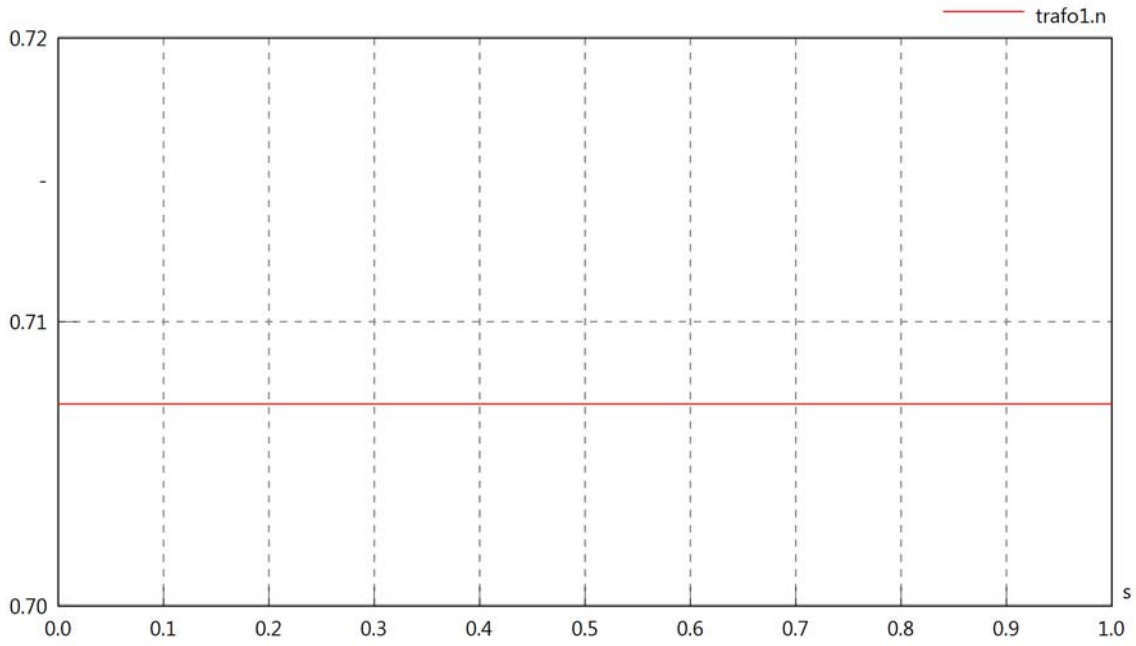

trafo1.k

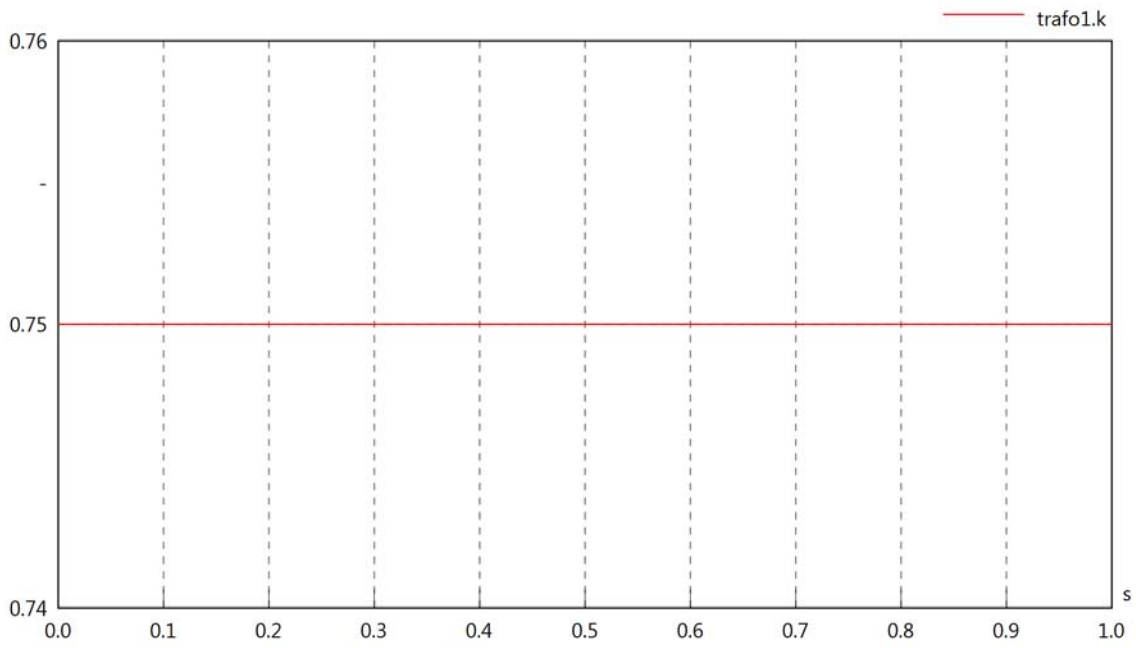

trafo1.vIn

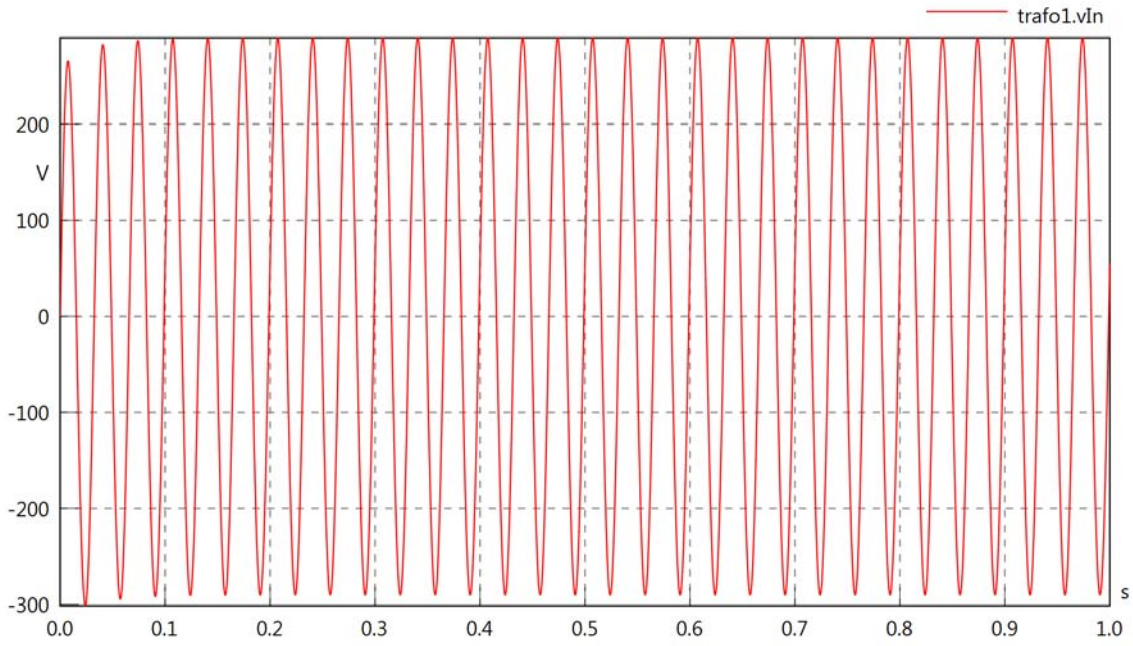

trafo1.iIn

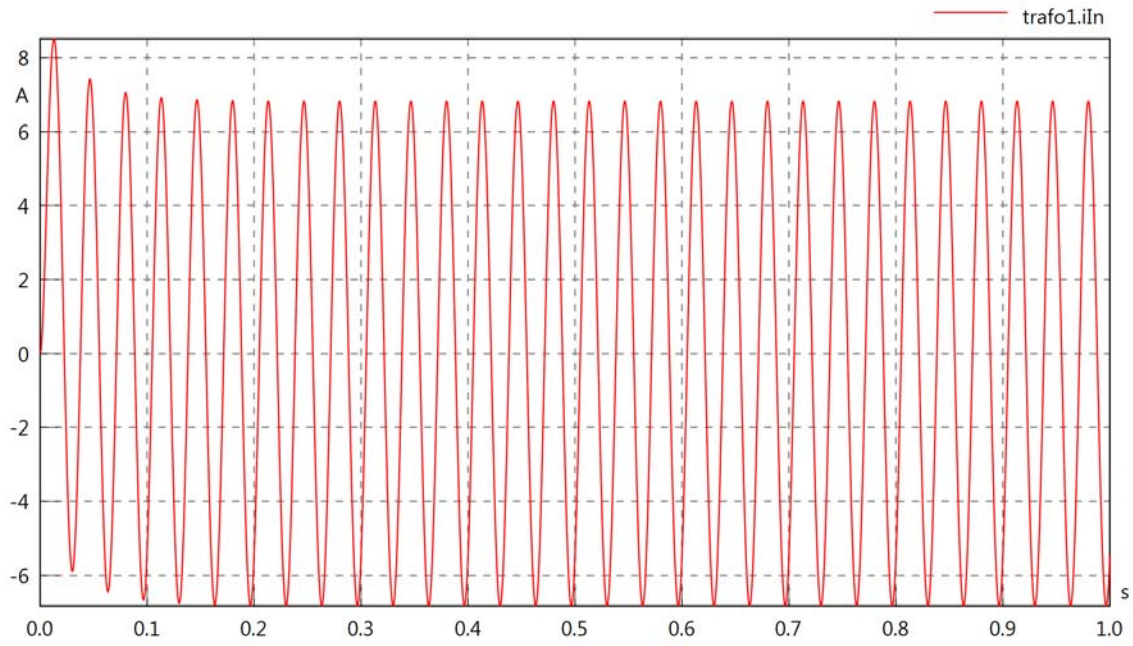

trafo1.PIn

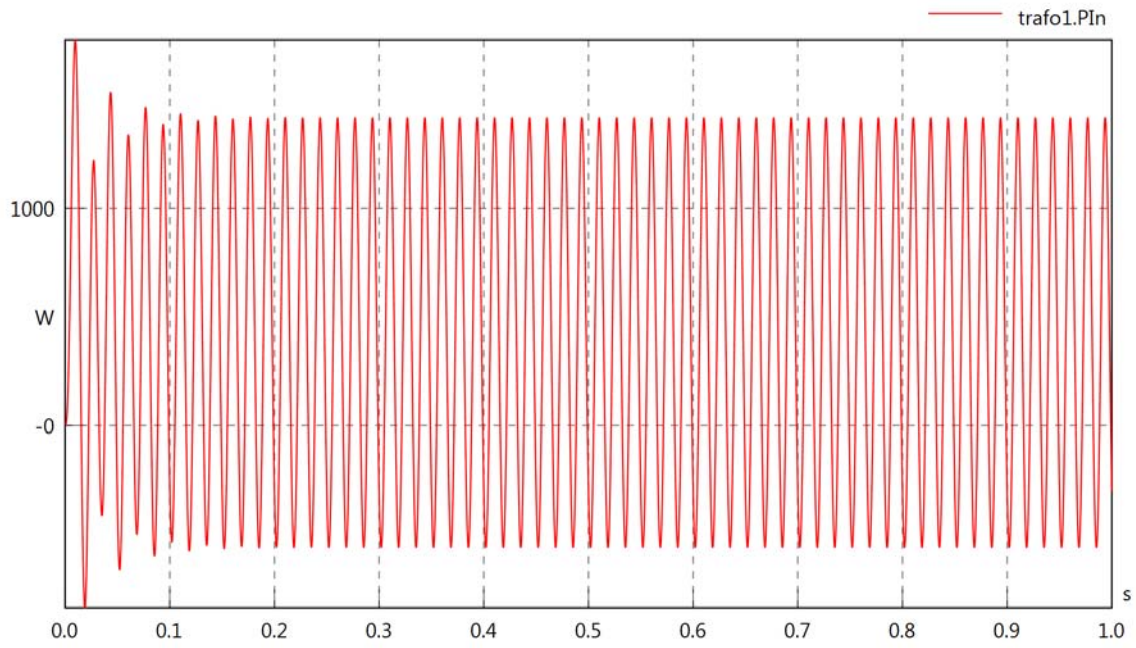

trafo1.vOut

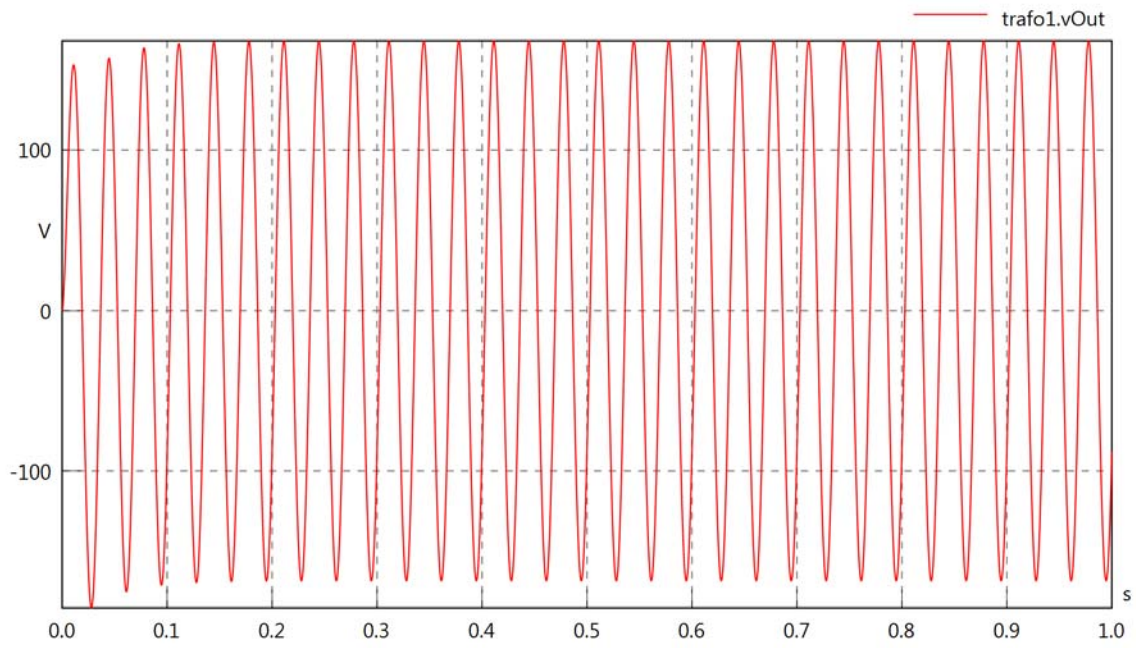

trafo1.iOut

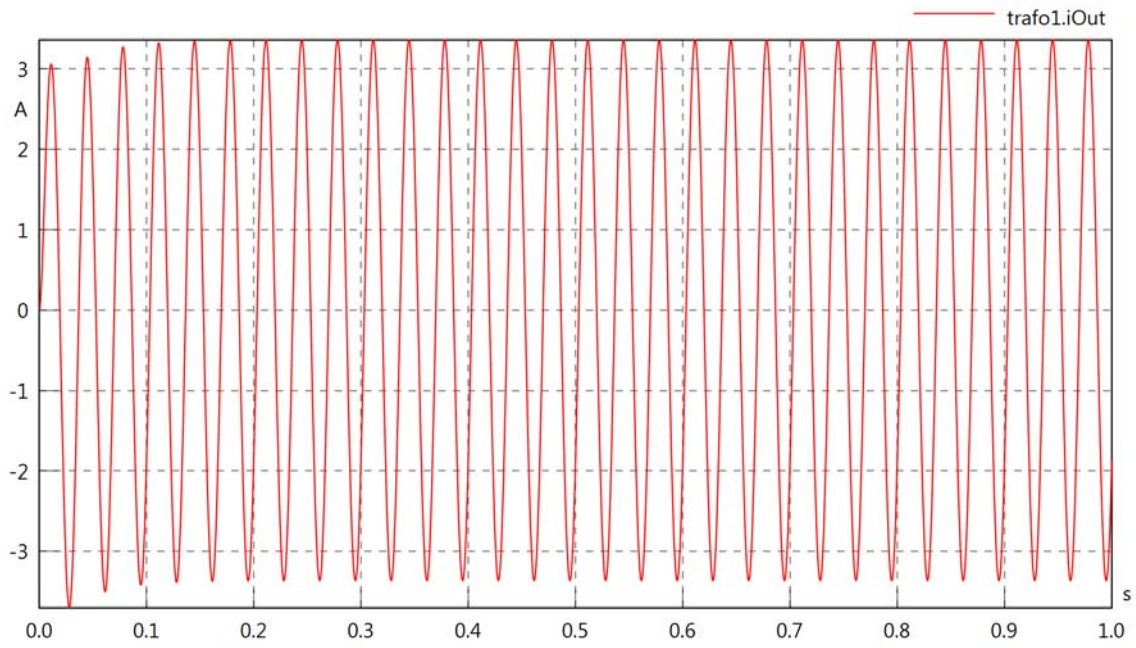

trafo1.POut

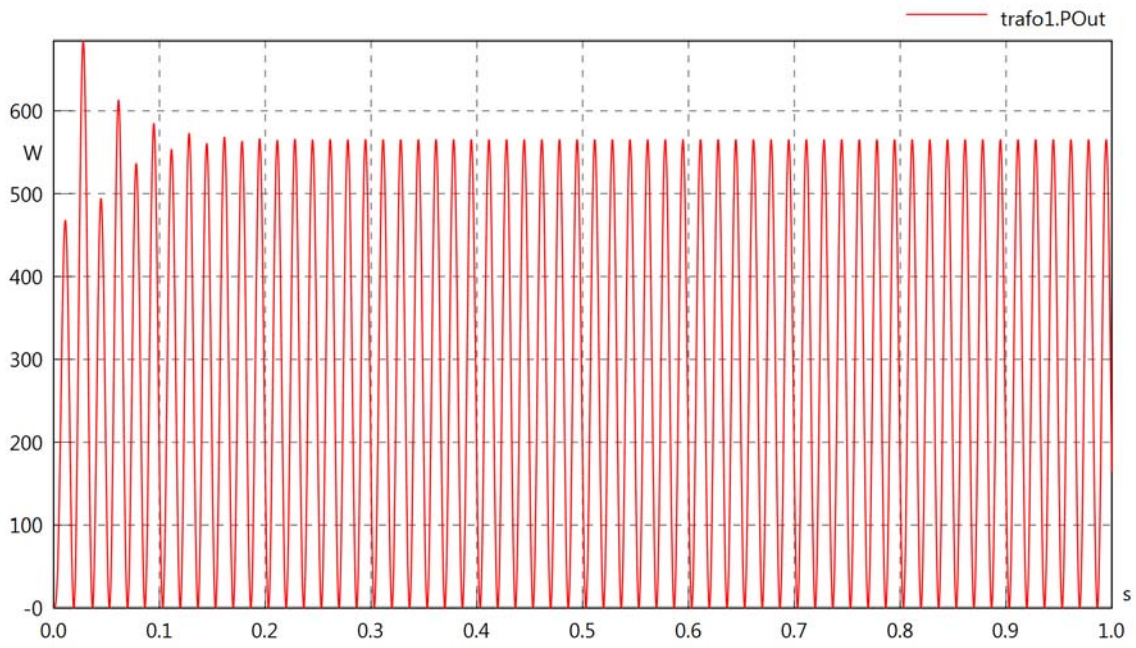

trafo1.PI

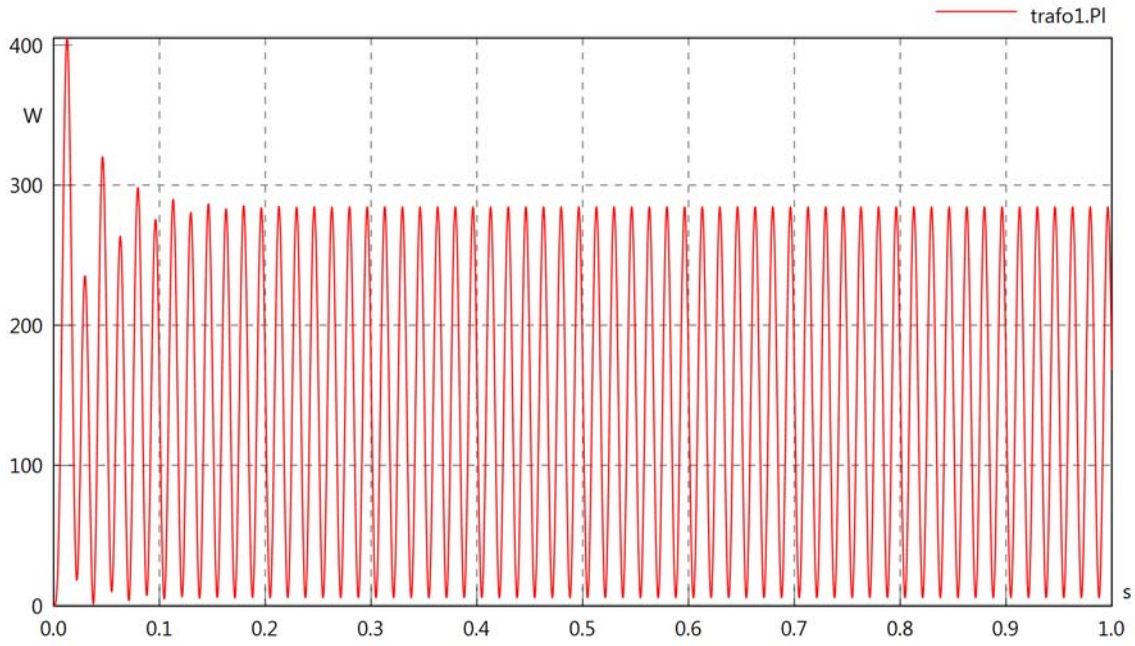

trafo1.Pmag

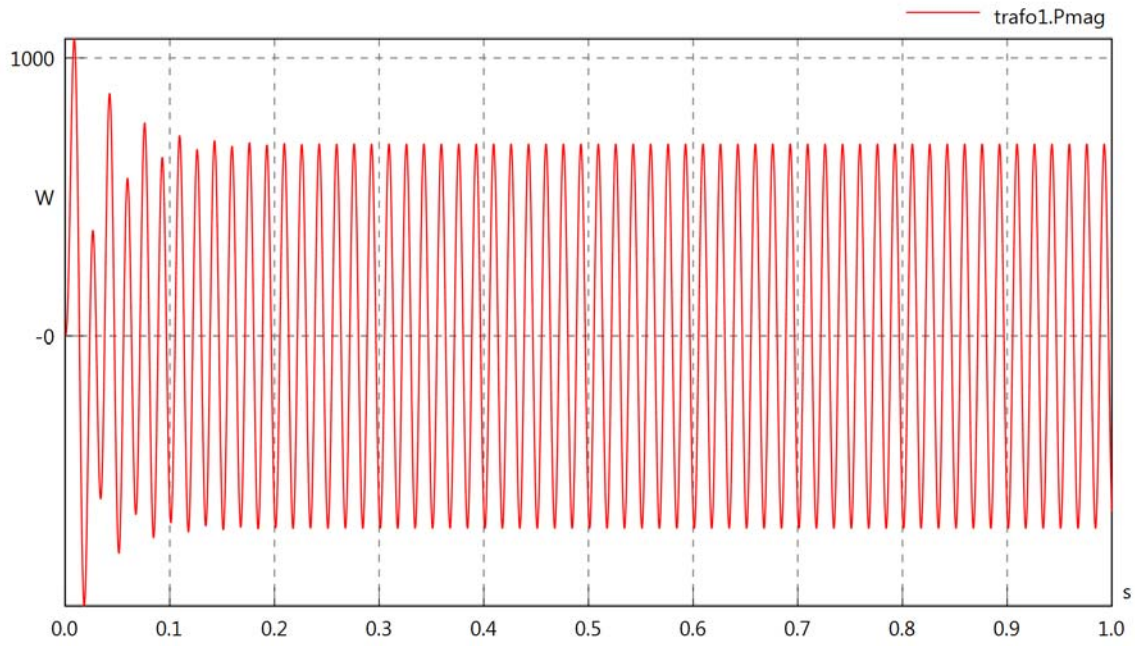
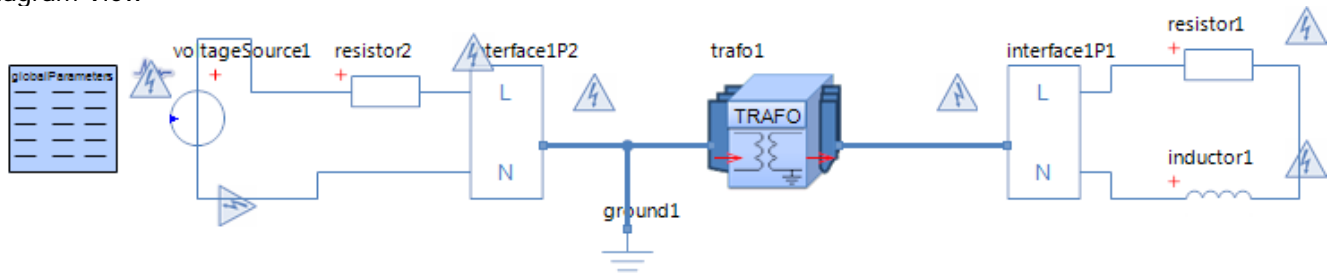

Diagram View



Transformer trafo1

Parameters

Comment	Name	Current Value	Unit
Transformer Type	kind	Lossy Transformer	
Primary Winding Resistance	R1	5	[Ohm]
Primary Inductance	L1	400	[mH]
Initial Value	i10	0 (Fixed)	[A]
Secondary Winding Resistance	R2	5	[Ohm]
Secondary Inductance	L2	800	[mH]
Initial Value	i20	0 (Fixed)	[A]
Iron Loss Resistance	Rfe	50	[kOhm]
Mutual Coupling Inductance	M	$0.75 * \sqrt{L1 * L2}$	[H]

Voltage Source voltageSource1

Parameters

Comment	Name	Current Value	Unit
Voltage	v_src	$230 * \sqrt{2} * \sin(2 * \pi * t * 60)$	[V]

Resistor resistor1

Parameters

Comment	Name	Current Value	Unit
Resistance	R	50	[Ohm]

Inductor inductor1

Parameters

Comment	Name	Current Value	Unit
Inductance	L	10	[mH]
Initial Value	i0	0 (Fixed)	[A]
Kind	kind	absolute	

Resistor resistor2

Parameters

Comment	Name	Current Value	Unit
Resistance	R	10	[Ohm]

trafo1.n

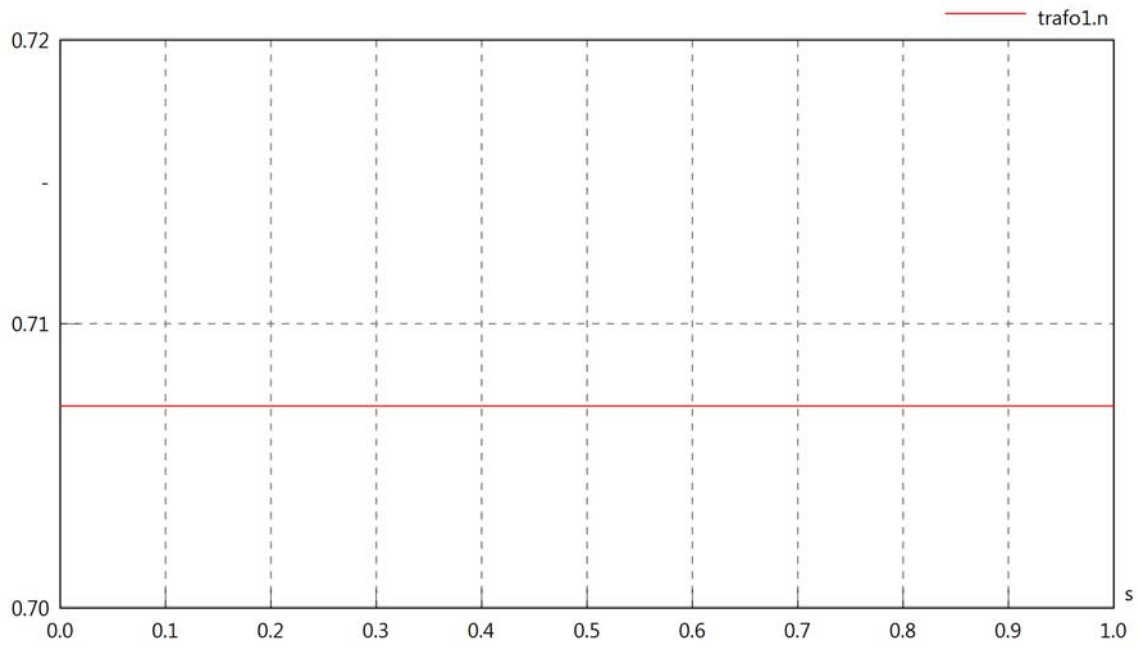

trafo1.k

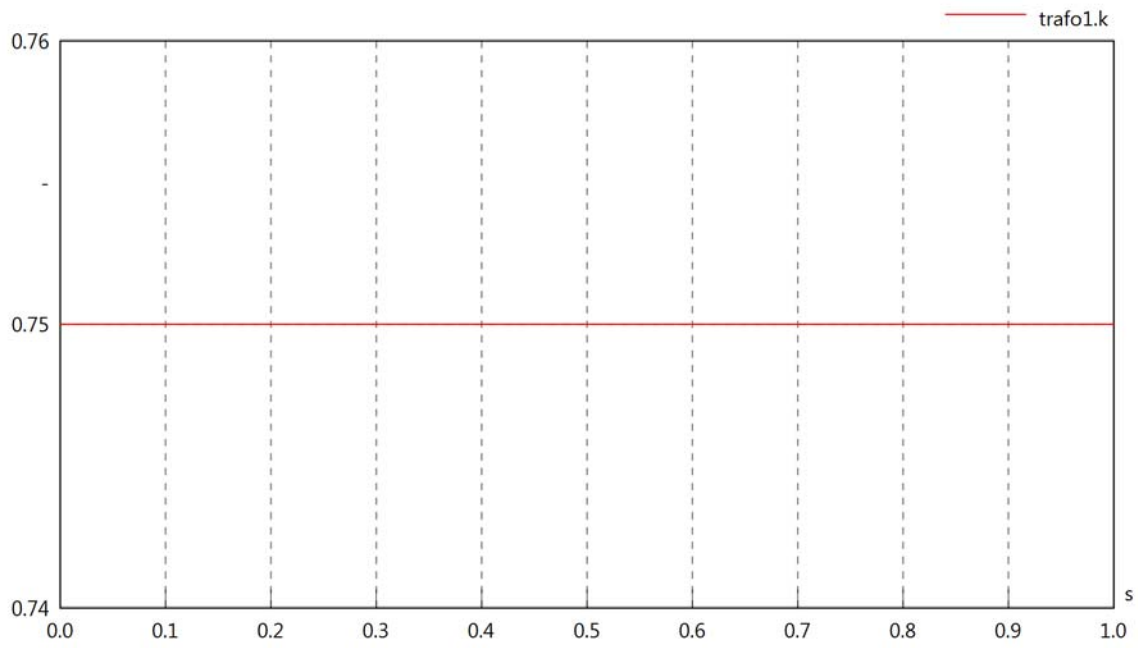

trafo1.vIn

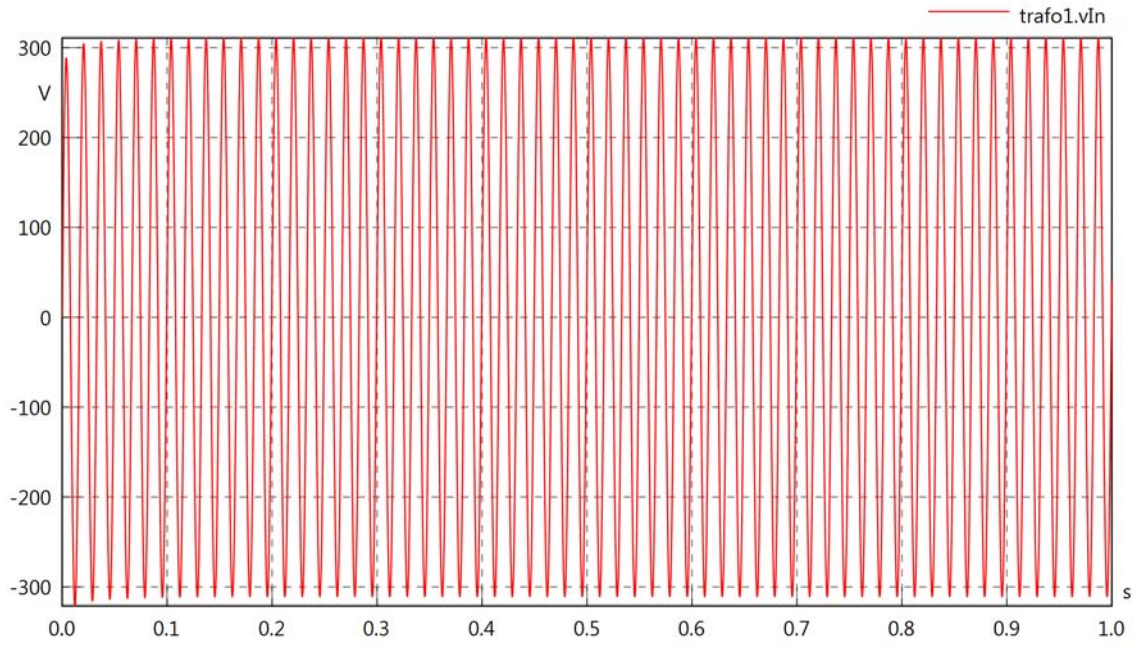

trafo1.iIn

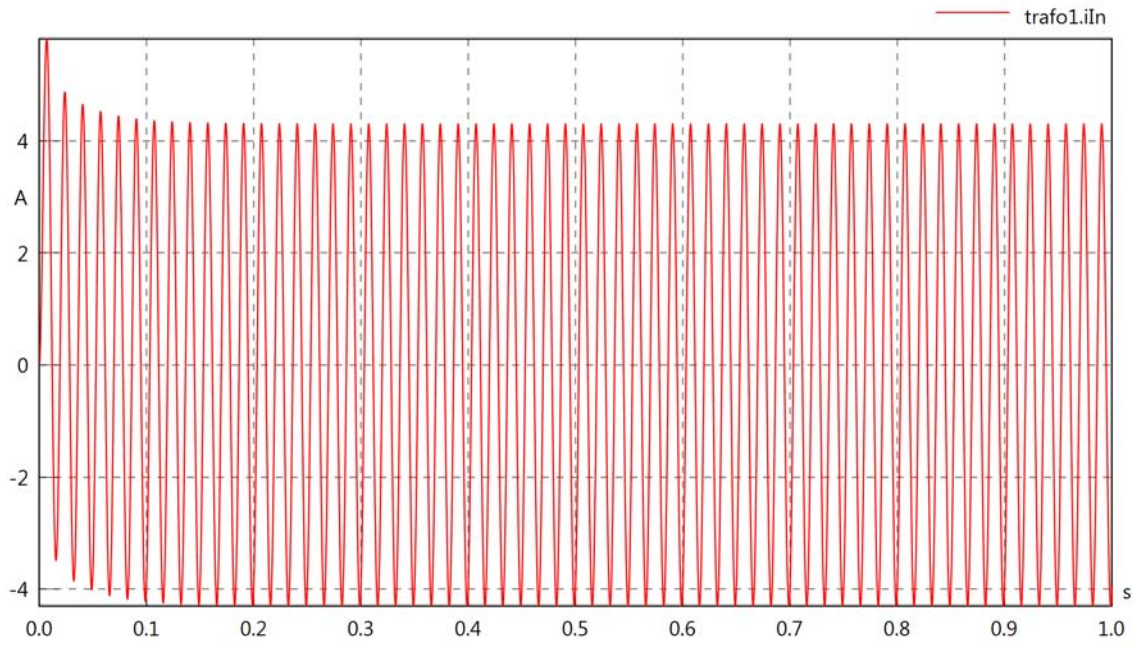

trafo1.PIn

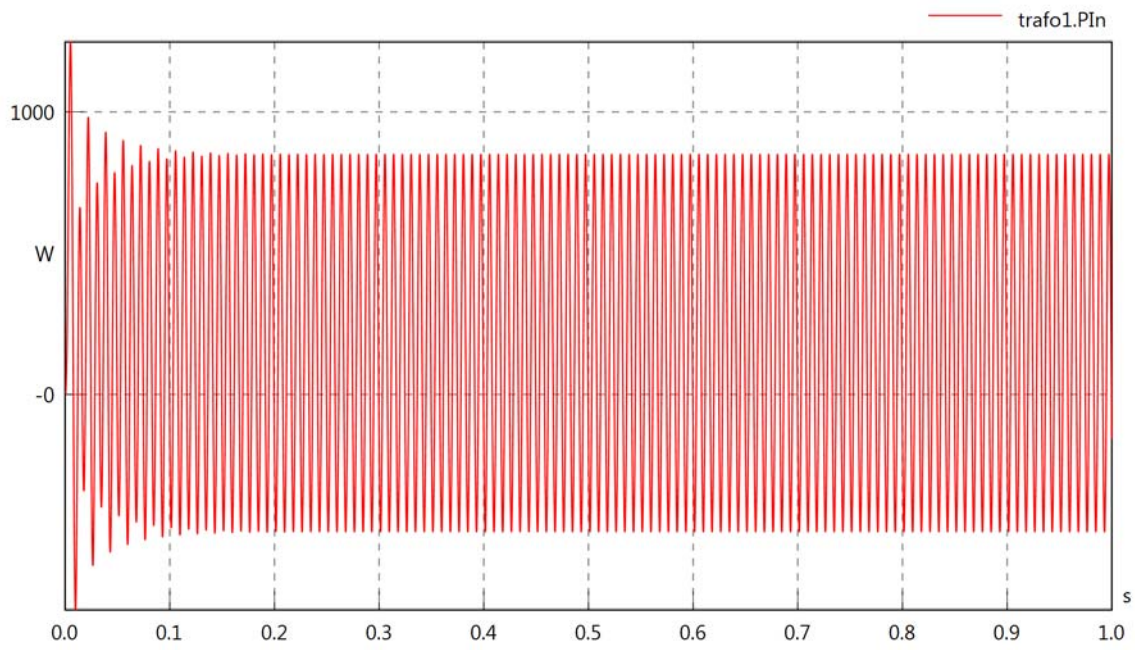

trafo1.vOut

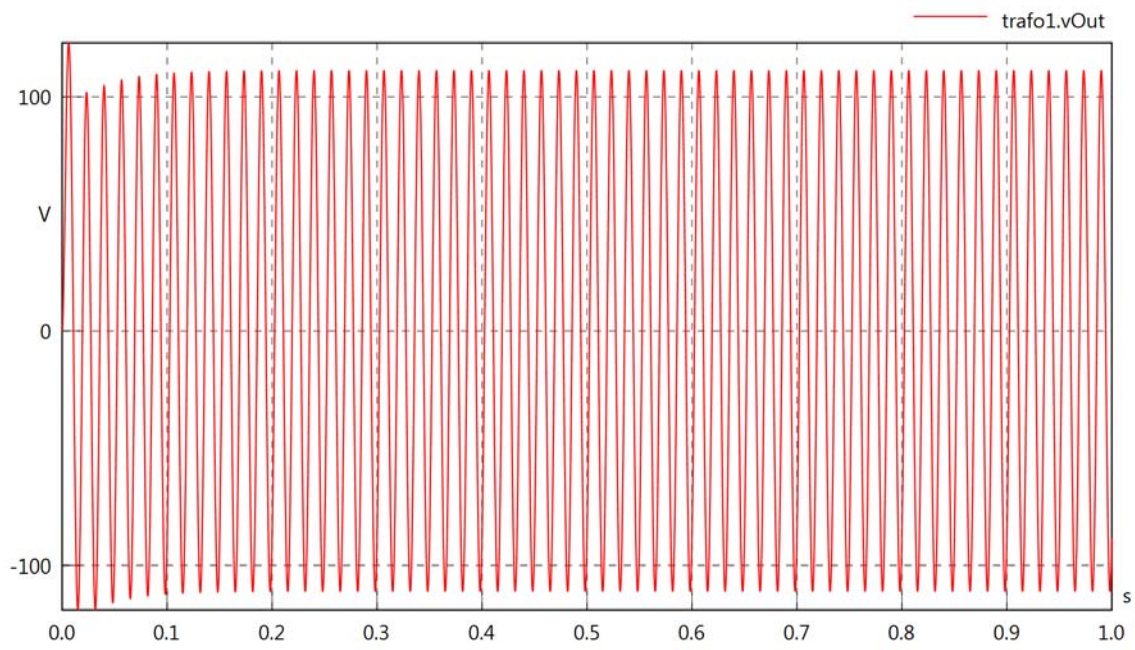

trafo1.iOut

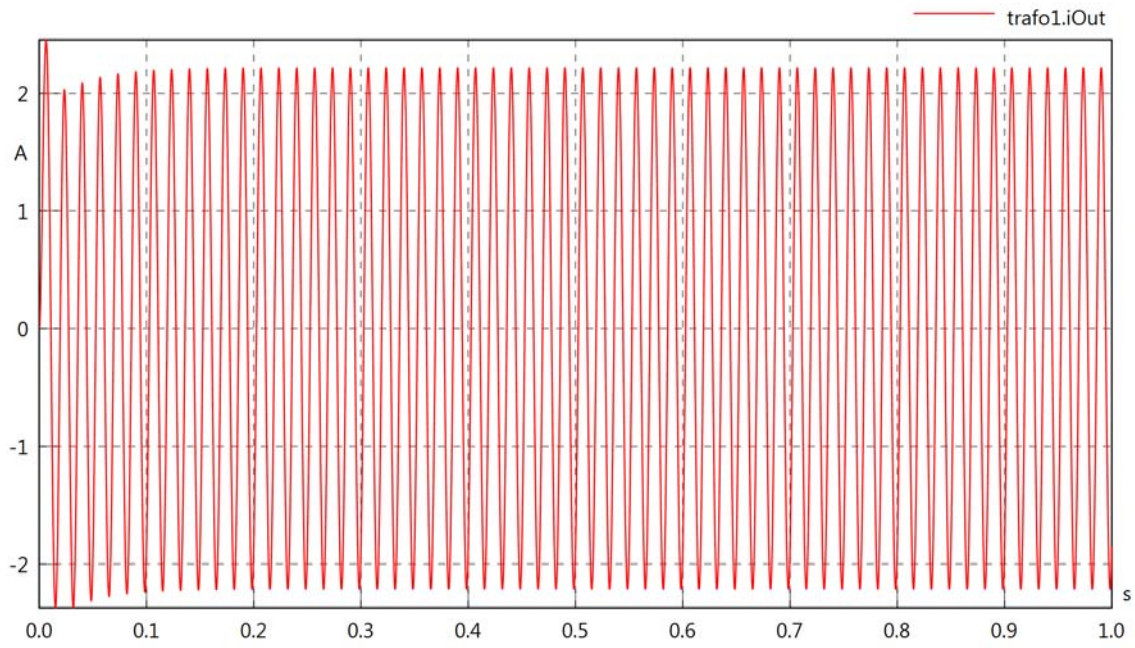

trafo1.POut

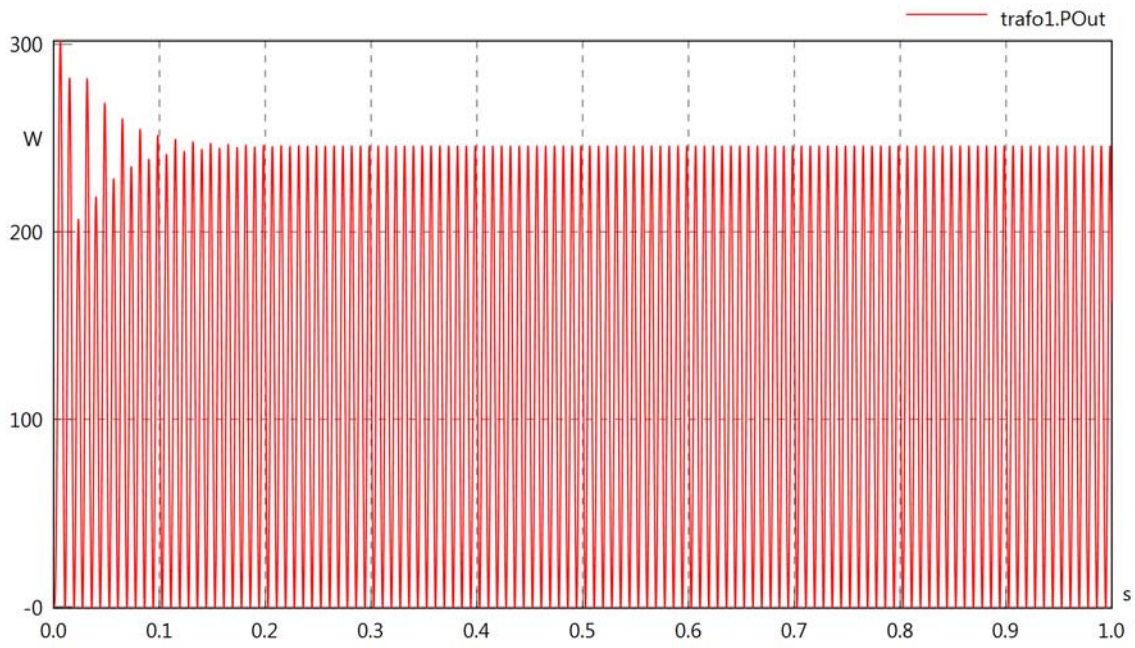

trafo1.PI

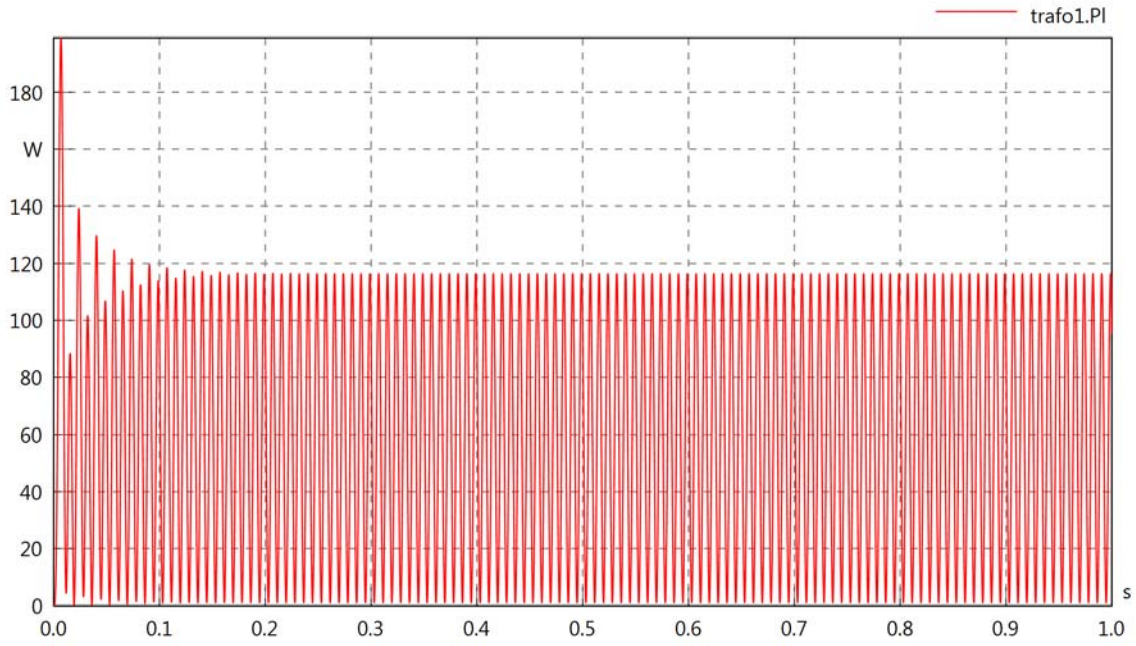

trafo1.Pmag

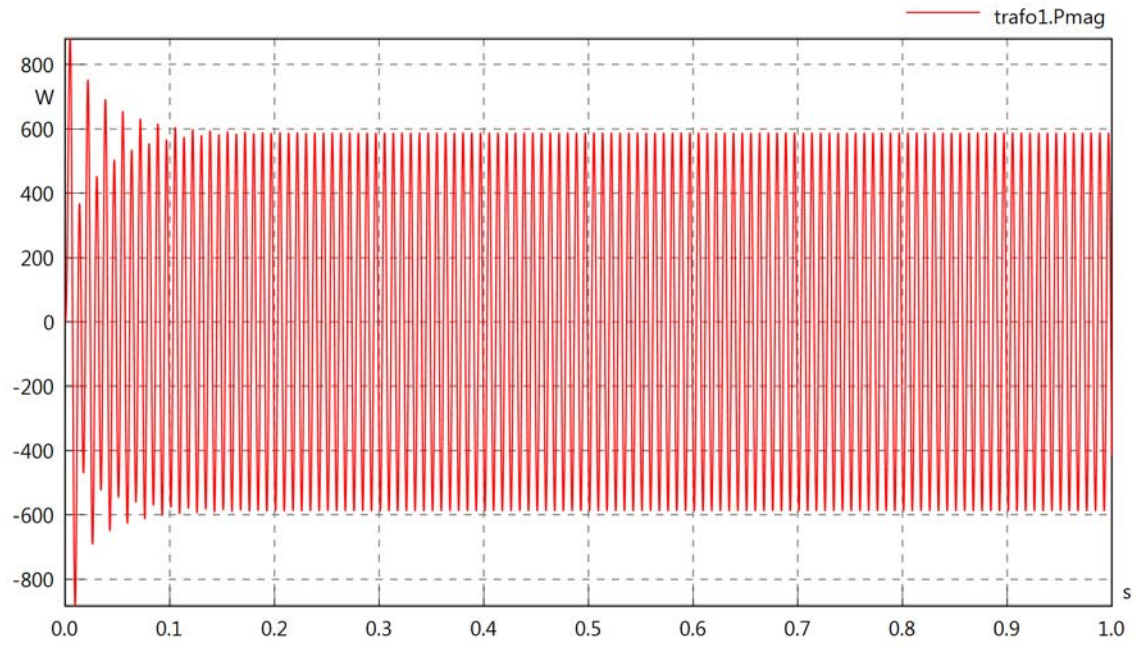
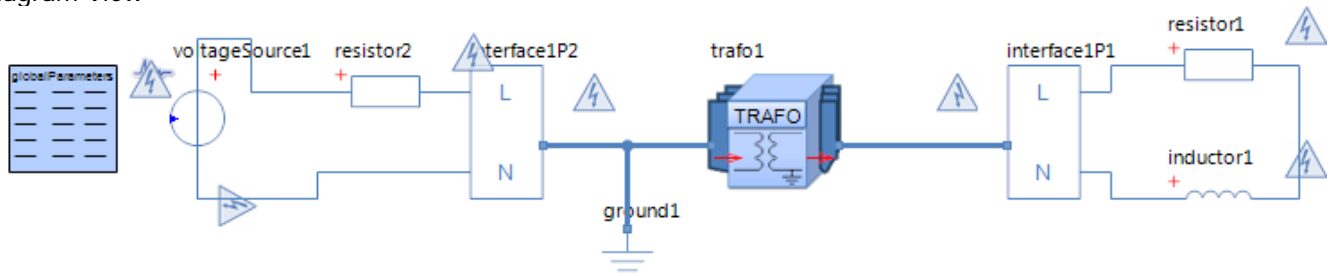

Diagram View



Transformer trafo1

Parameters

Comment	Name	Current Value	Unit
Transformer Type	kind	Lossy Transformer	
Primary Winding Resistance	R1	5	[Ohm]
Primary Inductance	L1	400	[mH]
Initial Value	i10	0 (Fixed)	[A]
Secondary Winding Resistance	R2	5	[Ohm]
Secondary Inductance	L2	800	[mH]
Initial Value	i20	0 (Fixed)	[A]
Iron Loss Resistance	Rfe	50	[kOhm]
Mutual Coupling Inductance	M	$0.75 \cdot \sqrt{L1 \cdot L2}$	[H]

Voltage Source voltageSource1

Parameters

Comment	Name	Current Value	Unit
Voltage	v_src	$230 \cdot \sqrt{2} \cdot \sin(2 \cdot \pi \cdot t \cdot 120)$	[V]

Resistor resistor1

Parameters

Comment	Name	Current Value	Unit
Resistance	R	50	[Ohm]

Inductor inductor1

Parameters

Comment	Name	Current Value	Unit
Inductance	L	10	[mH]
Initial Value	i0	0 (Fixed)	[A]
Kind	kind	absolute	

Resistor resistor2

Parameters

Comment	Name	Current Value	Unit
Resistance	R	10	[Ohm]

trafo1.n

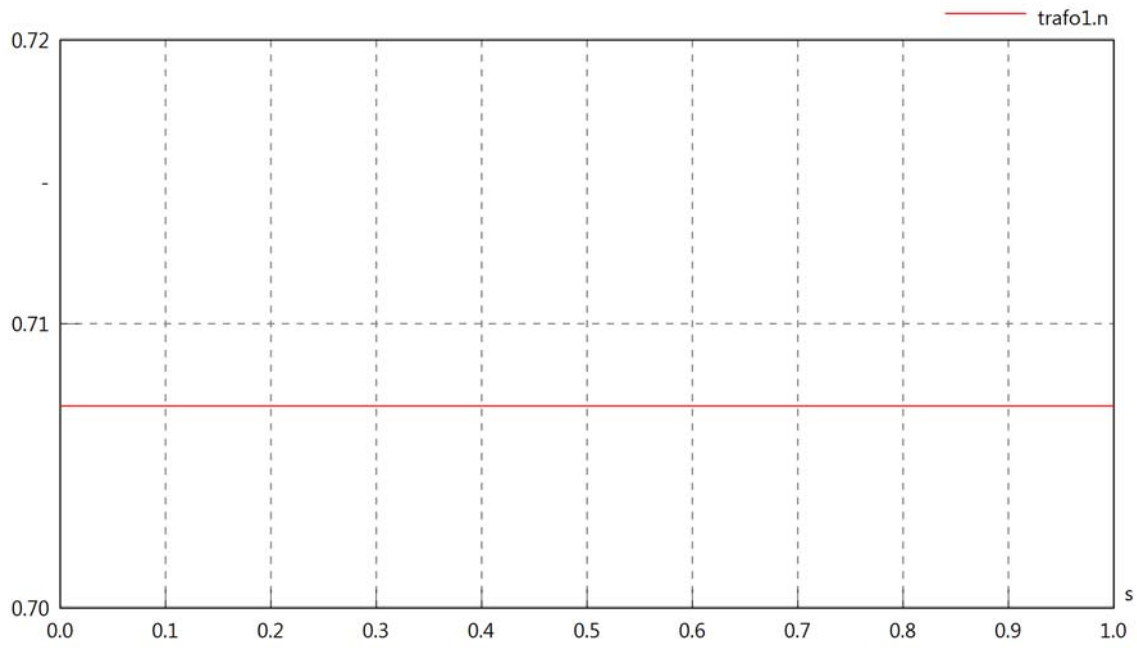

trafo1.k

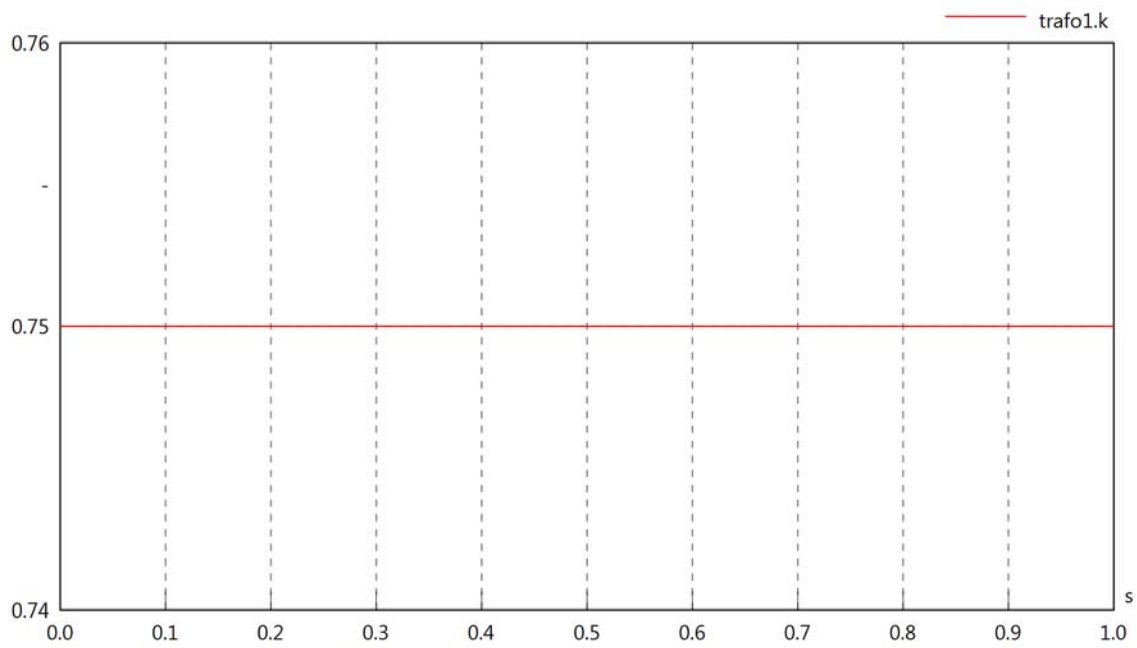

trafo1.vIn

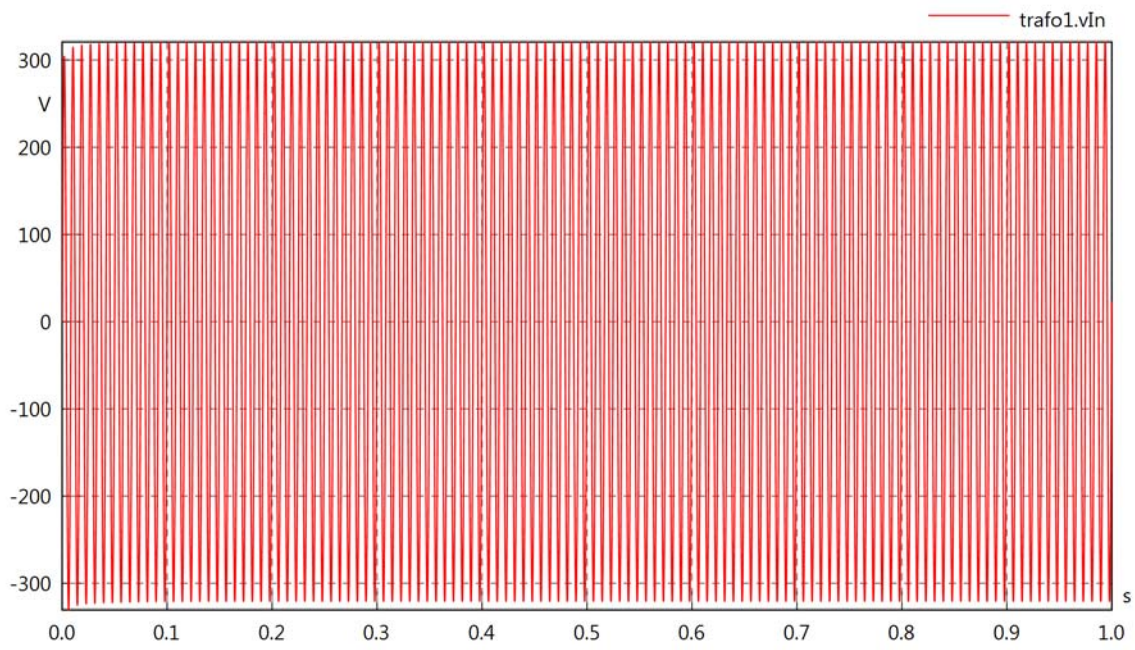

trafo1.iIn

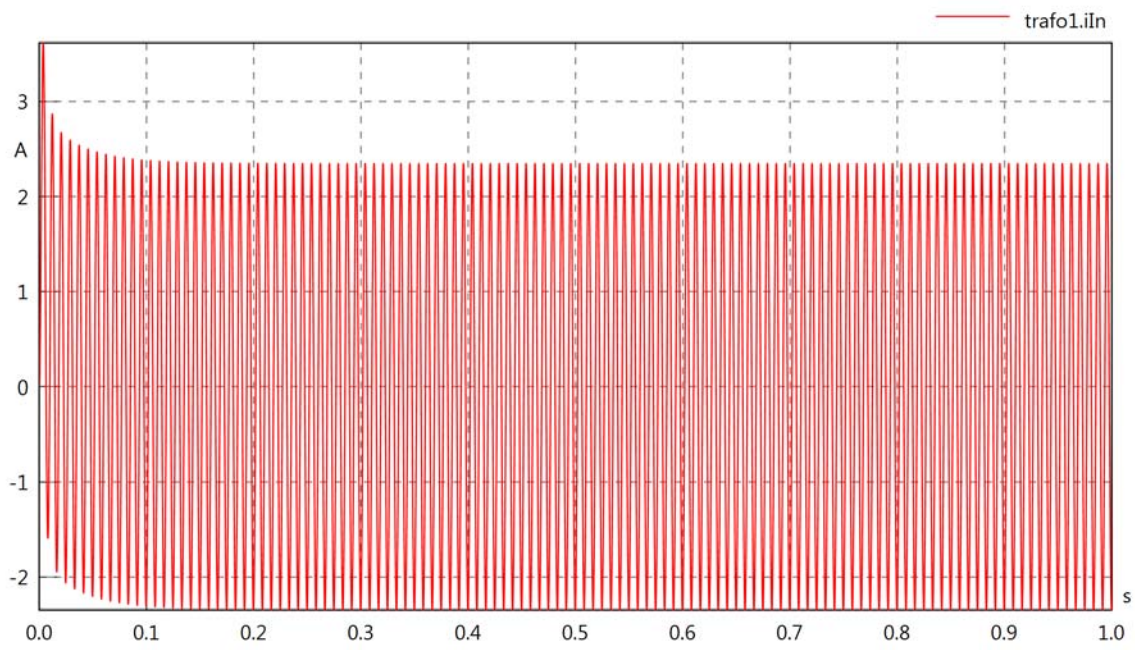

trafo1.PIn

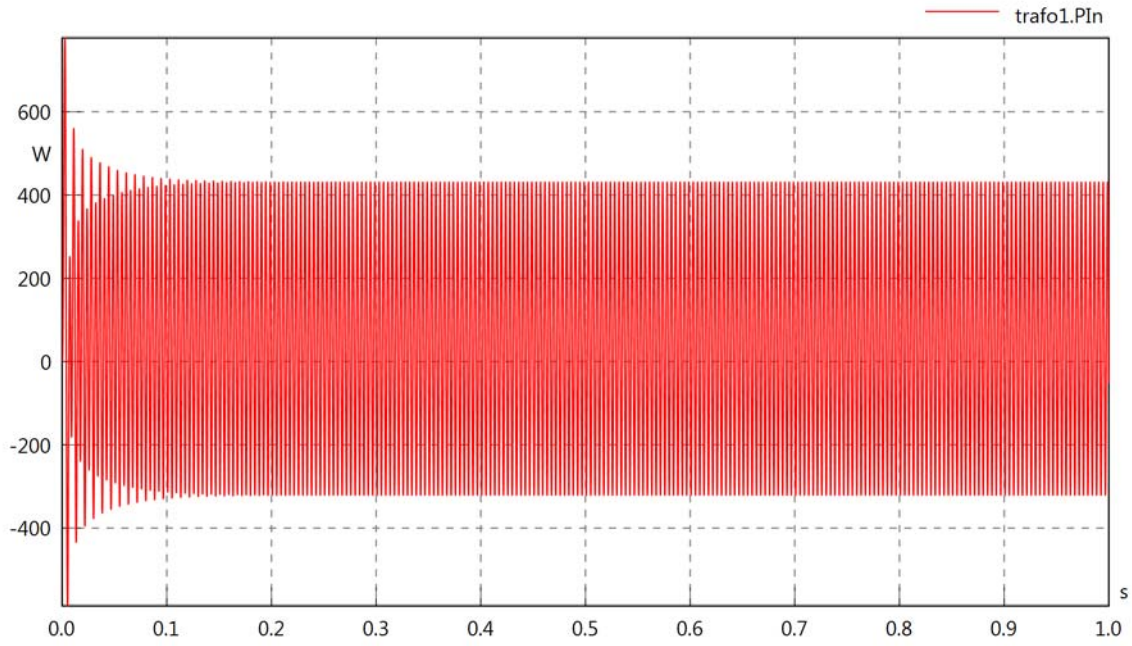

trafo1.vOut

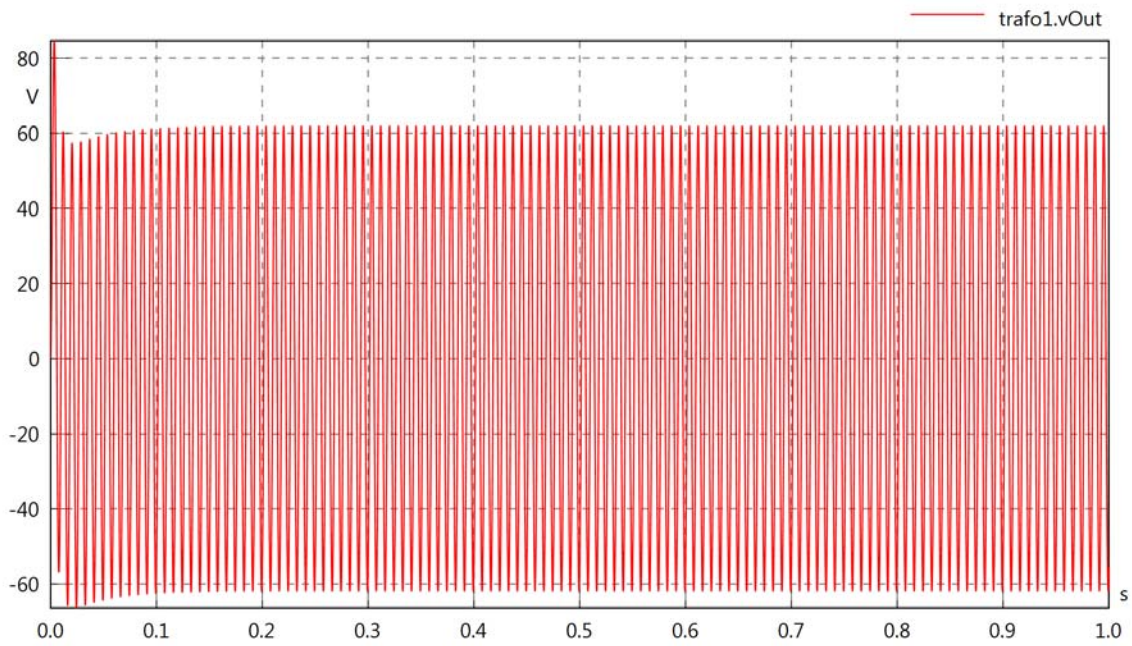

trafo1.iOut

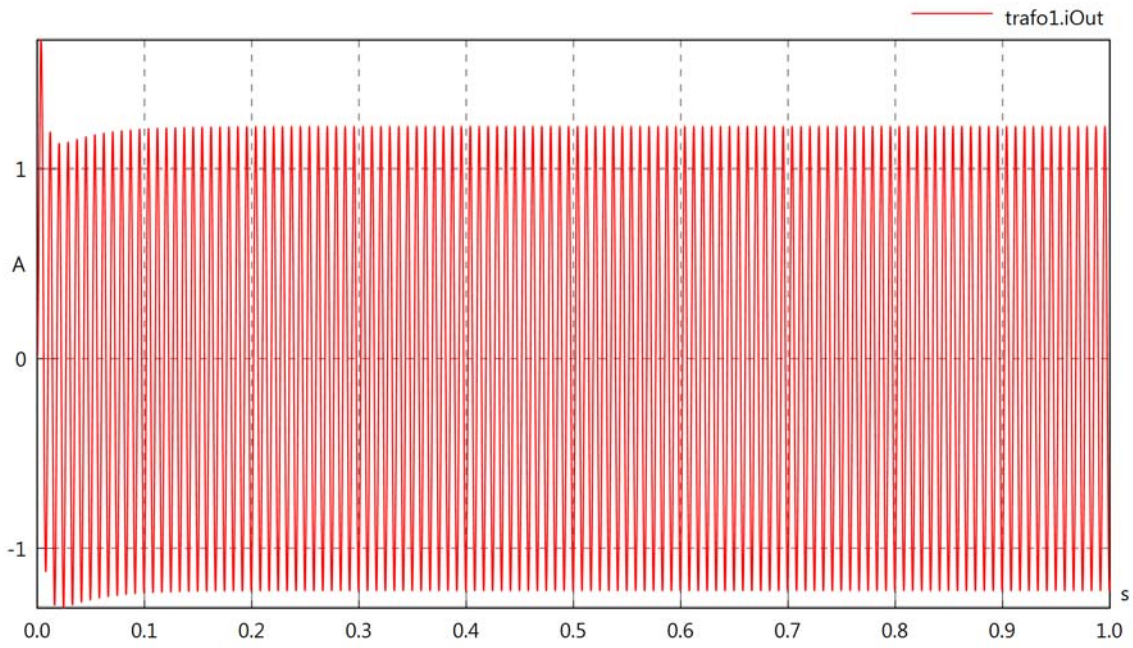

trafo1.POut

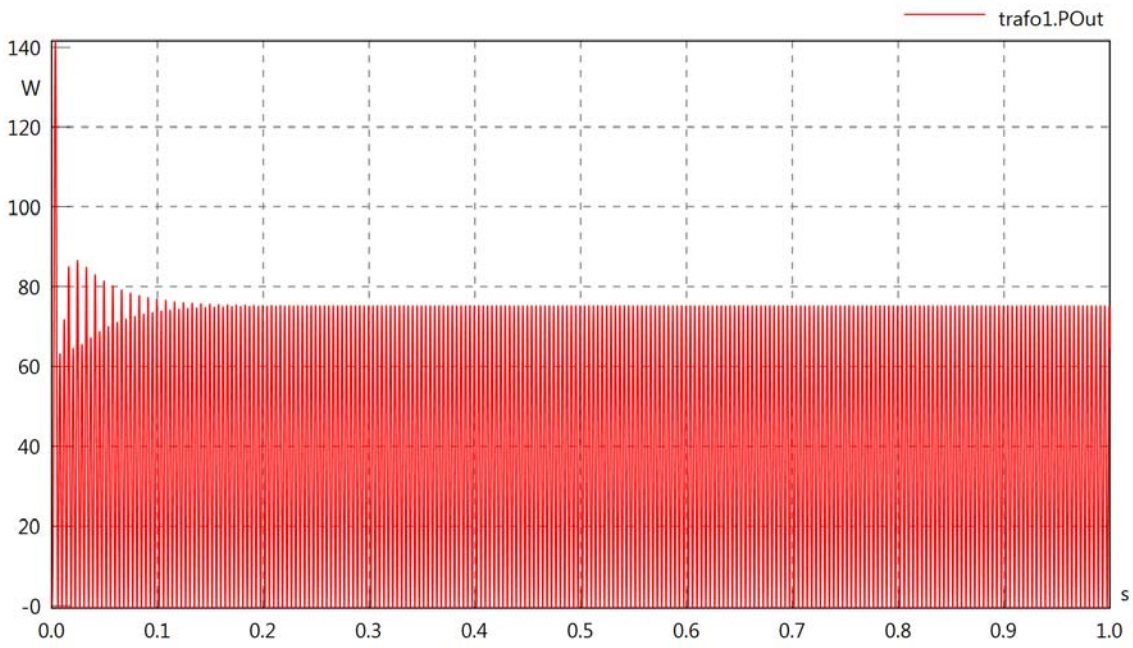

trafo1.PI

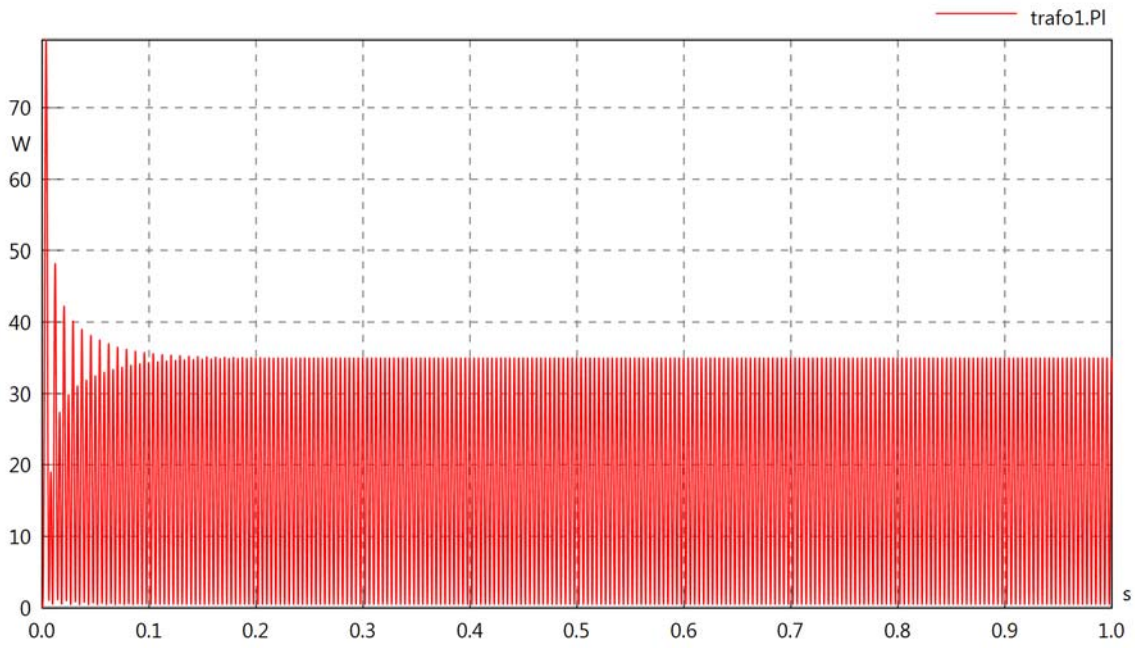

trafo1.Pmag

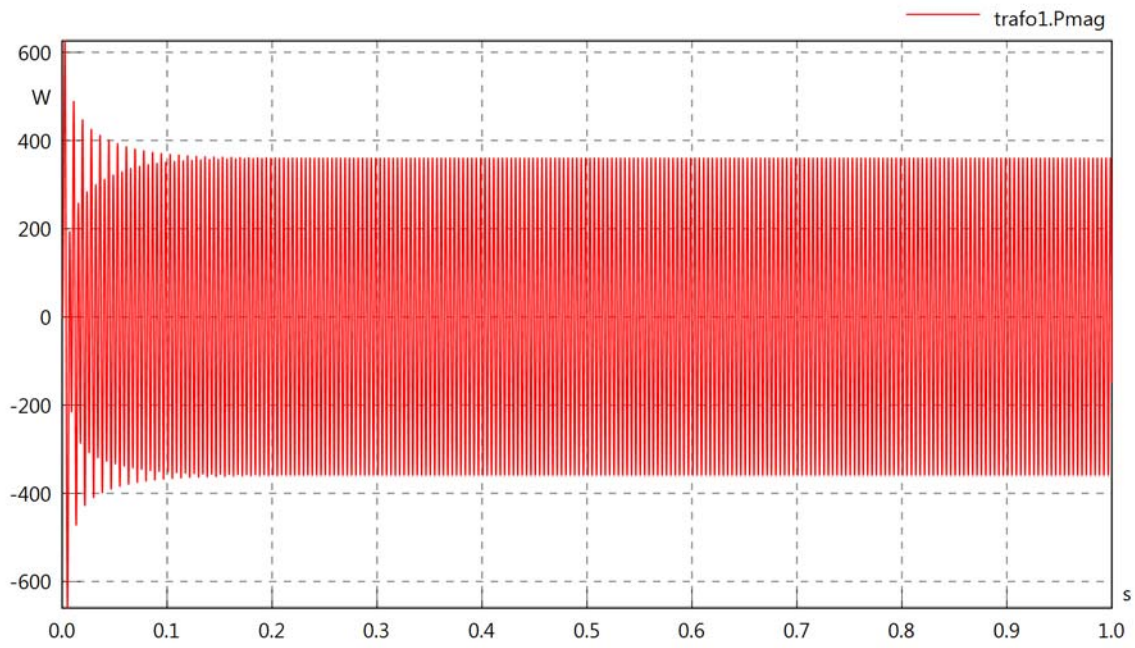

Oppfølgingsdokument

19/05-2014

Dato	Utført arbeid:			
12/05 – 18/05	<ul style="list-style-type: none"> Finne endelige resultater for transmission lines element. Og starte med verifikasjonsrapporten. 			
	Time liste:			
	Oppgave:	Raymond H.	Marius B.	Aleksandr S.
	verifikasjonsrapporten – signal beregninger	28	-	-
	Verifikasjonsdokument og prosjektrapport	-	30	-
Verifikasjonsrapporten – power beregninger		--	28	

Dato	Planlagt arbeid:	
19/05 – 25/05	Sette inn resultater og beregninger i verifikasjonsrapporten,	
	Navn	Oppgave:
	Raymond Holthe	<ul style="list-style-type: none"> verifikasjonsrapporten – signal beregninger
	Marius Bakka	<ul style="list-style-type: none"> Verifikasjonsdokument Oppsett
	Aleksandr Svetlanov	<ul style="list-style-type: none"> verifikasjonsrapporten – power beregninger

Oppfølgingsdokument

12/05-2014

Dato	Utført arbeid:			
05/05 – 11/05	<ul style="list-style-type: none"> Finne endelige resultater for transimission lines element. Og starte med verifikasjonsrapporten. 			
	Time liste:			
	Oppgave:	Raymond H.	Marius B.	Aleksandr S.
	verifikasjonsrapporten – signal beregninger	25	-	-
	Verifikasjonsrapporten – simulasjon	-	24	-
	Verifikasjonsrapporten – power beregninger		--	22
Møte	2	2	2	

Dato	Planlagt arbeid:	
12/05 – 18/05	Sette inn resultater og beregninger i verifikasjonsrapporten, skrive prosjektrapport og verifikasjonsdokument	
	Navn	Oppgave:
	Raymond Holthe	<ul style="list-style-type: none"> verifikasjonsrapporten – signal beregninger
	Marius Bakka	<ul style="list-style-type: none"> Verifikasjonsdokument prosjektrapport
	Aleksandr Svetlanov	<ul style="list-style-type: none"> verifikasjonsrapporten – power beregninger

Oppfølgingsdokument

05/05-2014

Dato	Utført arbeid:												
28/04 – 04/05	<ul style="list-style-type: none">Finne endelige resultater for transimission lines element. Og starte med verifikasjonsrapporten.												
	Time liste:												
	<table border="1"><thead><tr><th>Oppgave:</th><th>Raymond H.</th><th>Marius B.</th><th>Aleksandr S.</th></tr></thead><tbody><tr><td>Umbilical</td><td>20</td><td>-</td><td>19</td></tr><tr><td>verifikasjonsrapporten</td><td>-</td><td>22</td><td>-</td></tr></tbody></table>	Oppgave:	Raymond H.	Marius B.	Aleksandr S.	Umbilical	20	-	19	verifikasjonsrapporten	-	22	-
	Oppgave:	Raymond H.	Marius B.	Aleksandr S.									
Umbilical	20	-	19										
verifikasjonsrapporten	-	22	-										

Dato	Planlagt arbeid:								
05/05 – 11/05	Sette inn resultater og beregninger i verifikasjonsrapporten.								
	<table border="1"><thead><tr><th>Navn</th><th>Oppgave:</th></tr></thead><tbody><tr><td>Raymond Holthe</td><td><ul style="list-style-type: none">verifikasjonsrapporten – signal beregninger</td></tr><tr><td>Marius Bakka</td><td><ul style="list-style-type: none">Verifikasjonsrapporten – simulasjon</td></tr><tr><td>Aleksandr Svetlanov</td><td><ul style="list-style-type: none">verifikasjonsrapporten – power beregninger</td></tr></tbody></table>	Navn	Oppgave:	Raymond Holthe	<ul style="list-style-type: none">verifikasjonsrapporten – signal beregninger	Marius Bakka	<ul style="list-style-type: none">Verifikasjonsrapporten – simulasjon	Aleksandr Svetlanov	<ul style="list-style-type: none">verifikasjonsrapporten – power beregninger
	Navn	Oppgave:							
Raymond Holthe	<ul style="list-style-type: none">verifikasjonsrapporten – signal beregninger								
Marius Bakka	<ul style="list-style-type: none">Verifikasjonsrapporten – simulasjon								
Aleksandr Svetlanov	<ul style="list-style-type: none">verifikasjonsrapporten – power beregninger								

Oppfølgingsdokument

28/04-2014

Dato	Utført arbeid:																
21/04 – 27/04	<ul style="list-style-type: none">Fortsettelse med transformer og lines																
	Time liste:																
	<table border="1"><thead><tr><th>Oppgave:</th><th>Raymond H.</th><th>Marius B.</th><th>Aleksandr S.</th></tr></thead><tbody><tr><td>Umbilical (sig)</td><td>19</td><td>-</td><td>-</td></tr><tr><td>Transformer (sig)</td><td>-</td><td>21</td><td>22</td></tr><tr><td>Møte</td><td>2</td><td>2</td><td>2</td></tr></tbody></table>	Oppgave:	Raymond H.	Marius B.	Aleksandr S.	Umbilical (sig)	19	-	-	Transformer (sig)	-	21	22	Møte	2	2	2
	Oppgave:	Raymond H.	Marius B.	Aleksandr S.													
	Umbilical (sig)	19	-	-													
Transformer (sig)	-	21	22														
Møte	2	2	2														

Dato	Planlagt arbeid:								
28/04 – 04/05	Finne endelige resultater for transimission lines element. Og starte med verifikasjonsrapporten.								
	<table border="1"><thead><tr><th>Navn</th><th>Oppgave:</th></tr></thead><tbody><tr><td>Raymond Holthe</td><td><ul style="list-style-type: none">Umbilical</td></tr><tr><td>Marius Bakka</td><td><ul style="list-style-type: none">verifikasjonsrapporten</td></tr><tr><td>Aleksandr Svetlanov</td><td><ul style="list-style-type: none">Umbilical</td></tr></tbody></table>	Navn	Oppgave:	Raymond Holthe	<ul style="list-style-type: none">Umbilical	Marius Bakka	<ul style="list-style-type: none">verifikasjonsrapporten	Aleksandr Svetlanov	<ul style="list-style-type: none">Umbilical
	Navn	Oppgave:							
	Raymond Holthe	<ul style="list-style-type: none">Umbilical							
	Marius Bakka	<ul style="list-style-type: none">verifikasjonsrapporten							
Aleksandr Svetlanov	<ul style="list-style-type: none">Umbilical								

Oppfølgingsdokument

21/04-2014

Dato	Utført arbeid:												
14/04 – 20/04	<ul style="list-style-type: none">Påskeferie												
	Time liste:												
	<table border="1"><thead><tr><th>Oppgave:</th><th>Raymond H.</th><th>Marius B.</th><th>Aleksandr S.</th></tr></thead><tbody><tr><td>Påskeferie</td><td>-</td><td>-</td><td>-</td></tr><tr><td></td><td></td><td></td><td></td></tr></tbody></table>	Oppgave:	Raymond H.	Marius B.	Aleksandr S.	Påskeferie	-	-	-				
	Oppgave:	Raymond H.	Marius B.	Aleksandr S.									
	Påskeferie	-	-	-									

Dato	Planlagt arbeid:								
21/04 – 26/04	Fortsettelse med transformere og lines								
	<table border="1"><thead><tr><th>Navn</th><th>Oppgave:</th></tr></thead><tbody><tr><td>Raymond Holthe</td><td><ul style="list-style-type: none">Umbilical (sig)</td></tr><tr><td>Marius Bakka</td><td><ul style="list-style-type: none">Transformer (sig)</td></tr><tr><td>Aleksandr Svetlanov</td><td><ul style="list-style-type: none">Transformer (sig)</td></tr></tbody></table>	Navn	Oppgave:	Raymond Holthe	<ul style="list-style-type: none">Umbilical (sig)	Marius Bakka	<ul style="list-style-type: none">Transformer (sig)	Aleksandr Svetlanov	<ul style="list-style-type: none">Transformer (sig)
	Navn	Oppgave:							
	Raymond Holthe	<ul style="list-style-type: none">Umbilical (sig)							
	Marius Bakka	<ul style="list-style-type: none">Transformer (sig)							
Aleksandr Svetlanov	<ul style="list-style-type: none">Transformer (sig)								

Oppfølgingsdokument

14/04-2014

Dato	Utført arbeid:												
07/04 – 13/04	<ul style="list-style-type: none">Forberedning til presentasjonPresentasjon												
	Time liste:												
	<table border="1"><thead><tr><th>Oppgave:</th><th>Raymond H.</th><th>Marius B.</th><th>Aleksandr S.</th></tr></thead><tbody><tr><td></td><td></td><td></td><td></td></tr><tr><td></td><td></td><td></td><td></td></tr></tbody></table>	Oppgave:	Raymond H.	Marius B.	Aleksandr S.								
	Oppgave:	Raymond H.	Marius B.	Aleksandr S.									

Dato	Planlagt arbeid:								
14/04 – 21/04	<ul style="list-style-type: none">Påskeferie								
	<table border="1"><thead><tr><th>Navn</th><th>Oppgave:</th></tr></thead><tbody><tr><td>Raymond Holthe</td><td><ul style="list-style-type: none">Påskeferie</td></tr><tr><td>Marius Bakka</td><td><ul style="list-style-type: none">Påskeferie</td></tr><tr><td>Aleksandr Svetlanov</td><td><ul style="list-style-type: none">Påskeferie</td></tr></tbody></table>	Navn	Oppgave:	Raymond Holthe	<ul style="list-style-type: none">Påskeferie	Marius Bakka	<ul style="list-style-type: none">Påskeferie	Aleksandr Svetlanov	<ul style="list-style-type: none">Påskeferie
	Navn	Oppgave:							
	Raymond Holthe	<ul style="list-style-type: none">Påskeferie							
Marius Bakka	<ul style="list-style-type: none">Påskeferie								
Aleksandr Svetlanov	<ul style="list-style-type: none">Påskeferie								

Oppfølgingsdokument

18/11-2013

Dato	Utført arbeid:							
11/11 – 17/11	Hovedprosjekt startet opp, ingen arbeid utført som følge av fullføring av annet skoleprosjekt.							
	Timeliste:							
	<table border="1"><thead><tr><th></th><th>Raymond H.</th><th>Marius B.</th><th>Aleksandr S.</th></tr></thead><tbody><tr><td>-</td><td>-</td><td>-</td><td>-</td></tr></tbody></table>		Raymond H.	Marius B.	Aleksandr S.	-	-	-
	Raymond H.	Marius B.	Aleksandr S.					
-	-	-	-					

Dato	Planlagt arbeid:								
18/11 – 24/11	Neste uke har vi planlagt og starte med forstudierapporten, starte å legge en prosjektplan og lage nødvendige maler for dokumentasjon. Det skal også startes med design av prosjektets webside.								
	<table border="1"><thead><tr><th>Navn</th><th>Oppgaver</th></tr></thead><tbody><tr><td>Raymond Holthe</td><td><ul style="list-style-type: none">• Forstudierapport• Prosjektplan• Webside</td></tr><tr><td>Marius Bakka</td><td><ul style="list-style-type: none">• Forstudierapport• Prosjektplan• Maler</td></tr><tr><td>Aleksandr Svetlanov</td><td><ul style="list-style-type: none">• Forstudierapport• Prosjektplan</td></tr></tbody></table>	Navn	Oppgaver	Raymond Holthe	<ul style="list-style-type: none">• Forstudierapport• Prosjektplan• Webside	Marius Bakka	<ul style="list-style-type: none">• Forstudierapport• Prosjektplan• Maler	Aleksandr Svetlanov	<ul style="list-style-type: none">• Forstudierapport• Prosjektplan
	Navn	Oppgaver							
	Raymond Holthe	<ul style="list-style-type: none">• Forstudierapport• Prosjektplan• Webside							
Marius Bakka	<ul style="list-style-type: none">• Forstudierapport• Prosjektplan• Maler								
Aleksandr Svetlanov	<ul style="list-style-type: none">• Forstudierapport• Prosjektplan								

Grunnet problemer med å få tak i hovedprosjekt, ble oppstarten noe forsinket. Vi er derfor nødt til å komme fort i gang og raskest mulig ta igjen den tapte tiden for å holde tidskjema.

Oppfølgingsdokument

25/11-2013

Dato	Utført arbeid:																
18/11 – 24/11	<p>Vi har fokusert på å få oversikt over fremtidig arbeid, oppsetting av timelister og estimering av tidsbruk. Det har blitt satt opp maler som skal brukes ved dokumentasjon av prosjektet og laget en plan på hvordan arbeidet skal foregå videre.</p> <p>Time liste:</p> <table border="1"><thead><tr><th>Oppgave:</th><th>Raymond H.</th><th>Marius B.</th><th>Aleksandr S.</th></tr></thead><tbody><tr><td>Maler</td><td>2</td><td>1</td><td>2</td></tr><tr><td>Prosjektplan</td><td>2</td><td>6</td><td>4</td></tr><tr><td>Webside</td><td>2</td><td>0</td><td>0</td></tr></tbody></table>	Oppgave:	Raymond H.	Marius B.	Aleksandr S.	Maler	2	1	2	Prosjektplan	2	6	4	Webside	2	0	0
Oppgave:	Raymond H.	Marius B.	Aleksandr S.														
Maler	2	1	2														
Prosjektplan	2	6	4														
Webside	2	0	0														

Dato	Planlagt arbeid:								
25/11 – 01/12	<p>Fortsette arbeidet med prosjektplanen og starte arbeidet med å utføre en forstudierapport. Det er også noen ekstra maler som må gjøres klare, disse skal fullføres i løpet av uken.</p> <table border="1"><thead><tr><th>Navn</th><th>Oppgave:</th></tr></thead><tbody><tr><td>Raymond Holthe</td><td><ul style="list-style-type: none">• Forstudierapport• Prosjektplan</td></tr><tr><td>Marius Bakka</td><td><ul style="list-style-type: none">• Forstudierapport• prosjektplan• Maler</td></tr><tr><td>Aleksandr Svetlanov</td><td><ul style="list-style-type: none">• Forstudierapport• Prosjektplan</td></tr></tbody></table>	Navn	Oppgave:	Raymond Holthe	<ul style="list-style-type: none">• Forstudierapport• Prosjektplan	Marius Bakka	<ul style="list-style-type: none">• Forstudierapport• prosjektplan• Maler	Aleksandr Svetlanov	<ul style="list-style-type: none">• Forstudierapport• Prosjektplan
Navn	Oppgave:								
Raymond Holthe	<ul style="list-style-type: none">• Forstudierapport• Prosjektplan								
Marius Bakka	<ul style="list-style-type: none">• Forstudierapport• prosjektplan• Maler								
Aleksandr Svetlanov	<ul style="list-style-type: none">• Forstudierapport• Prosjektplan								

Vi føler vi fortsatt ligger på etterskudd og må fortsette med å ta igjen tapt tid, det er foreløpig lagt en plan om å kunne holde første presentasjon innen utgangen av januar.

Oppfølgingsdokument

02/12-2013

Dato	Utført arbeid:																
25/11 – 01/12	Prosjektplanen og forstudierapporten har i stor grad blitt fullført, alle maler skal nå også være på plass. Time liste: <table border="1"><thead><tr><th>Oppgave:</th><th>Raymond H.</th><th>Marius B.</th><th>Aleksandr S.</th></tr></thead><tbody><tr><td>Forstudierapport</td><td>8</td><td>9</td><td>9</td></tr><tr><td>Prosjektplan</td><td>2</td><td>3</td><td>0</td></tr><tr><td>Maler</td><td>1</td><td>5</td><td>1</td></tr></tbody></table>	Oppgave:	Raymond H.	Marius B.	Aleksandr S.	Forstudierapport	8	9	9	Prosjektplan	2	3	0	Maler	1	5	1
Oppgave:	Raymond H.	Marius B.	Aleksandr S.														
Forstudierapport	8	9	9														
Prosjektplan	2	3	0														
Maler	1	5	1														

Dato	Planlagt arbeid:								
02/12 – 08/12	Denne uken, og neste uke er det planlagt en pause i hovedprosjektet, dette er for å kunne fokusere på en kommende eksamen. <table border="1"><thead><tr><th>Navn</th><th>Oppgave:</th></tr></thead><tbody><tr><td>Raymond Holthe</td><td>•</td></tr><tr><td>Marius Bakka</td><td>•</td></tr><tr><td>Aleksandr Svetlanov</td><td>•</td></tr></tbody></table>	Navn	Oppgave:	Raymond Holthe	•	Marius Bakka	•	Aleksandr Svetlanov	•
Navn	Oppgave:								
Raymond Holthe	•								
Marius Bakka	•								
Aleksandr Svetlanov	•								

Oppfølgingsdokument

09/12-2013

Dato	Utført arbeid:							
02/12 – 08/12	Pause grunnet eksamen							
	Time liste:							
	<table border="1"><thead><tr><th>Oppgave:</th><th>Raymond H.</th><th>Marius B.</th><th>Aleksandr S.</th></tr></thead><tbody><tr><td>-</td><td>-</td><td>-</td><td>-</td></tr></tbody></table>	Oppgave:	Raymond H.	Marius B.	Aleksandr S.	-	-	-
Oppgave:	Raymond H.	Marius B.	Aleksandr S.					
-	-	-	-					

Dato	Planlagt arbeid:								
09/12 – 15/12	Pause grunnet eksamen								
	<table border="1"><thead><tr><th>Navn</th><th>Oppgave:</th></tr></thead><tbody><tr><td>Raymond Holthe</td><td>•</td></tr><tr><td>Marius Bakka</td><td>•</td></tr><tr><td>Aleksandr Svetlanov</td><td>•</td></tr></tbody></table>	Navn	Oppgave:	Raymond Holthe	•	Marius Bakka	•	Aleksandr Svetlanov	•
	Navn	Oppgave:							
	Raymond Holthe	•							
	Marius Bakka	•							
Aleksandr Svetlanov	•								

Oppfølgingsdokument

16/12-2013

Dato	Utført arbeid:							
09/12 – 15/12	Pauset grunnet eksamensforberedelse							
	Time liste:							
	<table border="1"><thead><tr><th>Oppgave:</th><th>Raymond H.</th><th>Marius B.</th><th>Aleksandr S.</th></tr></thead><tbody><tr><td>-</td><td>-</td><td>-</td><td>-</td></tr></tbody></table>	Oppgave:	Raymond H.	Marius B.	Aleksandr S.	-	-	-
Oppgave:	Raymond H.	Marius B.	Aleksandr S.					
-	-	-	-					

Dato	Planlagt arbeid:								
16/12 – 22/12	Etter å ha mottatt noen tips og anmerkninger på møte 05/12-13 skal vi legge til mer informasjon i forstudierapporten, det skal også lages et gantt-diagram i prosjektplanen og lages visjonsdokument. Videre skal vi også korrekturlese dokumentasjonen som er skrevet.								
	<table border="1"><thead><tr><th>Navn</th><th>Oppgave:</th></tr></thead><tbody><tr><td>Raymond Holthe</td><td><ul style="list-style-type: none">• Forstudierapport• Webside• Korrekturlesing</td></tr><tr><td>Marius Bakka</td><td><ul style="list-style-type: none">• Visjonsdokument• Prosjektplan• Korrekturlesing</td></tr><tr><td>Aleksandr Svetlanov</td><td><ul style="list-style-type: none">• Visjonsdokument• Korrekturlesing</td></tr></tbody></table>	Navn	Oppgave:	Raymond Holthe	<ul style="list-style-type: none">• Forstudierapport• Webside• Korrekturlesing	Marius Bakka	<ul style="list-style-type: none">• Visjonsdokument• Prosjektplan• Korrekturlesing	Aleksandr Svetlanov	<ul style="list-style-type: none">• Visjonsdokument• Korrekturlesing
	Navn	Oppgave:							
	Raymond Holthe	<ul style="list-style-type: none">• Forstudierapport• Webside• Korrekturlesing							
Marius Bakka	<ul style="list-style-type: none">• Visjonsdokument• Prosjektplan• Korrekturlesing								
Aleksandr Svetlanov	<ul style="list-style-type: none">• Visjonsdokument• Korrekturlesing								

Ettersom det var enkelte mangler i de fullførte dokumentene, så vi oss nødt til å bruke denne uken på å rette de opp. Dette fører til en liten forsinkelse i planen og må planen har blitt endret, det er planlagt å hente inn den tapte tiden i del 2 av prosjektet.

Oppfølgingsdokument

23/12-2012

Dato	Utført arbeid:																				
16/12 – 22/12	Visjonsdokument, prosjektplan og forstudierapport er nå i stor grad ferdigstilte dokumenter. Websiden til prosjektet er nå også klar til å legges ut når vi får i orden domene.																				
	Time liste:																				
	<table border="1"><thead><tr><th>Oppgave:</th><th>Raymond H.</th><th>Marius B.</th><th>Aleksandr S.</th></tr></thead><tbody><tr><td>Visjonsdokument</td><td>10</td><td>6</td><td>10</td></tr><tr><td>Prosjektplan</td><td>2</td><td>3</td><td>2</td></tr><tr><td>Forstudierapport</td><td>4</td><td>0</td><td>0</td></tr><tr><td>Webside</td><td>10</td><td>5</td><td>7</td></tr></tbody></table>	Oppgave:	Raymond H.	Marius B.	Aleksandr S.	Visjonsdokument	10	6	10	Prosjektplan	2	3	2	Forstudierapport	4	0	0	Webside	10	5	7
	Oppgave:	Raymond H.	Marius B.	Aleksandr S.																	
	Visjonsdokument	10	6	10																	
	Prosjektplan	2	3	2																	
Forstudierapport	4	0	0																		
Webside	10	5	7																		

Dato	Planlagt arbeid:								
23/12 – 29/12	Vi har ikke plan om å jobbe mye i romjulen, dagene det blir gjort noe på er det planlagt og gjøre litt korrekturlesing.								
	<table border="1"><thead><tr><th>Navn</th><th>Oppgave:</th></tr></thead><tbody><tr><td>Raymond Holthe</td><td><ul style="list-style-type: none">• korrekturlesing</td></tr><tr><td>Marius Bakka</td><td><ul style="list-style-type: none">• korrekturlesing</td></tr><tr><td>Aleksandr Svetlanov</td><td><ul style="list-style-type: none">• korrekturlesing</td></tr></tbody></table>	Navn	Oppgave:	Raymond Holthe	<ul style="list-style-type: none">• korrekturlesing	Marius Bakka	<ul style="list-style-type: none">• korrekturlesing	Aleksandr Svetlanov	<ul style="list-style-type: none">• korrekturlesing
	Navn	Oppgave:							
	Raymond Holthe	<ul style="list-style-type: none">• korrekturlesing							
	Marius Bakka	<ul style="list-style-type: none">• korrekturlesing							
Aleksandr Svetlanov	<ul style="list-style-type: none">• korrekturlesing								

Oppfølgingsdokument

30/12-2013

Dato	Utført arbeid:							
23/12 – 29/12	Det ble ikke gjort noe arbeid i romjula, bortsett fra litt korrekturlesing av eksisterende dokumenter.							
	Time liste:							
	<table border="1"><thead><tr><th>Oppgave:</th><th>Raymond H.</th><th>Marius B.</th><th>Aleksandr S.</th></tr></thead><tbody><tr><td>Korrekturlesing</td><td>4</td><td>3</td><td>3</td></tr></tbody></table>	Oppgave:	Raymond H.	Marius B.	Aleksandr S.	Korrekturlesing	4	3
Oppgave:	Raymond H.	Marius B.	Aleksandr S.					
Korrekturlesing	4	3	3					

Dato	Planlagt arbeid:								
30/12 – 05/01	Det er bare 2 dager som brukes til jobbing denne uka, vi har derfor satt av den kommende uka til å sette oss litt mer inn i simulasjonsprogrammet som biblioteket er basert på, Simulation X.								
	<table border="1"><thead><tr><th>Navn</th><th>Oppgave:</th></tr></thead><tbody><tr><td>Raymond Holthe</td><td><ul style="list-style-type: none">• SimulationX</td></tr><tr><td>Marius Bakka</td><td><ul style="list-style-type: none">• SimulationX</td></tr><tr><td>Aleksandr Svetlanov</td><td><ul style="list-style-type: none">• SimulationX</td></tr></tbody></table>	Navn	Oppgave:	Raymond Holthe	<ul style="list-style-type: none">• SimulationX	Marius Bakka	<ul style="list-style-type: none">• SimulationX	Aleksandr Svetlanov	<ul style="list-style-type: none">• SimulationX
	Navn	Oppgave:							
	Raymond Holthe	<ul style="list-style-type: none">• SimulationX							
Marius Bakka	<ul style="list-style-type: none">• SimulationX								
Aleksandr Svetlanov	<ul style="list-style-type: none">• SimulationX								

Oppfølgingsdokument

06/01-2014

Dato	Utført arbeid:							
30/12 – 05/01	Vi brukte de 2 dagene til å sette oss mer inn i bruken av simulationX, dette er nødvendig for å kunne kjøre simulasjonene og være komfortabel med bibliotekene når vi skal utføre beregningene senere i prosjektet.							
	Time liste:							
	<table border="1"><thead><tr><th>Oppgave:</th><th>Raymond H.</th><th>Marius B.</th><th>Aleksandr S.</th></tr></thead><tbody><tr><td>Simulation X</td><td>16</td><td>16</td><td>16</td></tr></tbody></table>	Oppgave:	Raymond H.	Marius B.	Aleksandr S.	Simulation X	16	16
Oppgave:	Raymond H.	Marius B.	Aleksandr S.					
Simulation X	16	16	16					

Dato	Planlagt arbeid:								
06/01 – 12/01	Vi skal skrive krav- og test-spesifikasjon for prosjektet.								
	<table border="1"><thead><tr><th>Navn</th><th>Oppgave:</th></tr></thead><tbody><tr><td>Raymond Holthe</td><td><ul style="list-style-type: none">• Kravspesifikasjon• Testspesifikasjon</td></tr><tr><td>Marius Bakka</td><td><ul style="list-style-type: none">• Kravspesifikasjon• Testspesifikasjon</td></tr><tr><td>Aleksandr Svetlanov</td><td><ul style="list-style-type: none">• Kravspesifikasjon• Testspesifikasjon</td></tr></tbody></table>	Navn	Oppgave:	Raymond Holthe	<ul style="list-style-type: none">• Kravspesifikasjon• Testspesifikasjon	Marius Bakka	<ul style="list-style-type: none">• Kravspesifikasjon• Testspesifikasjon	Aleksandr Svetlanov	<ul style="list-style-type: none">• Kravspesifikasjon• Testspesifikasjon
	Navn	Oppgave:							
	Raymond Holthe	<ul style="list-style-type: none">• Kravspesifikasjon• Testspesifikasjon							
Marius Bakka	<ul style="list-style-type: none">• Kravspesifikasjon• Testspesifikasjon								
Aleksandr Svetlanov	<ul style="list-style-type: none">• Kravspesifikasjon• Testspesifikasjon								

Vi har kommet frem til å prøve å holde første fremføring så tidlig som mulig etter 20. januar

Oppfølgingsdokument

13/01-2014

Dato	Utført arbeid:												
06/01 – 12/01	Denne uken førte vi inn Krav- og Test -spesifikasjon for prosjektet.												
	Time liste:												
	<table border="1"><thead><tr><th>Oppgave:</th><th>Raymond H.</th><th>Marius B.</th><th>Aleksandr S.</th></tr></thead><tbody><tr><td>Kravspesifikasjon</td><td>7</td><td>6</td><td>8</td></tr><tr><td>Testspesifikasjon</td><td>6</td><td>4</td><td>5</td></tr></tbody></table>	Oppgave:	Raymond H.	Marius B.	Aleksandr S.	Kravspesifikasjon	7	6	8	Testspesifikasjon	6	4	5
	Oppgave:	Raymond H.	Marius B.	Aleksandr S.									
Kravspesifikasjon	7	6	8										
Testspesifikasjon	6	4	5										

Dato	Planlagt arbeid:								
13/01 – 19/01	Det nærmer seg første presentasjon, og vi skal derfor bruke uken på å forberede oss til første presentasjon.								
	<table border="1"><thead><tr><th>Navn</th><th>Oppgave:</th></tr></thead><tbody><tr><td>Raymond Holthe</td><td><ul style="list-style-type: none">• Forberedelse til presentasjon</td></tr><tr><td>Marius Bakka</td><td><ul style="list-style-type: none">• Forberedelse til presentasjon</td></tr><tr><td>Aleksandr Svetlanov</td><td><ul style="list-style-type: none">• Forberedelse til presentasjon</td></tr></tbody></table>	Navn	Oppgave:	Raymond Holthe	<ul style="list-style-type: none">• Forberedelse til presentasjon	Marius Bakka	<ul style="list-style-type: none">• Forberedelse til presentasjon	Aleksandr Svetlanov	<ul style="list-style-type: none">• Forberedelse til presentasjon
	Navn	Oppgave:							
	Raymond Holthe	<ul style="list-style-type: none">• Forberedelse til presentasjon							
Marius Bakka	<ul style="list-style-type: none">• Forberedelse til presentasjon								
Aleksandr Svetlanov	<ul style="list-style-type: none">• Forberedelse til presentasjon								

Selv om vi fortsatt ligger litt bak vanlig tid, føler vi at vi har kontroll nok på prosjektet til å kunne få det inn på et normalt tidsskjema innen andre presentasjon.

Oppfølgingsdokument

20/01-2014

Dato	Utført arbeid:							
13/01 – 19/01	Vi forberede oss til presentasjonen.							
	Time liste:							
	<table border="1"><thead><tr><th>Oppgave:</th><th>Raymond H.</th><th>Marius B.</th><th>Aleksandr S.</th></tr></thead><tbody><tr><td>Forberedelse til presentasjon</td><td>8</td><td>8</td><td>8</td></tr></tbody></table>	Oppgave:	Raymond H.	Marius B.	Aleksandr S.	Forberedelse til presentasjon	8	8
Oppgave:	Raymond H.	Marius B.	Aleksandr S.					
Forberedelse til presentasjon	8	8	8					

Dato	Planlagt arbeid:								
20/01 – 26/01	Vi skal gjøre siste finish på dokumenter, gå over for å korrekturlese og klargjøre alle dokumenter til innlevering.								
	<table border="1"><thead><tr><th>Navn</th><th>Oppgave:</th></tr></thead><tbody><tr><td>Raymond Holthe</td><td><ul style="list-style-type: none">• Korrekturlesing</td></tr><tr><td>Marius Bakka</td><td><ul style="list-style-type: none">• Slå sammen dokumenter og kapitler</td></tr><tr><td>Aleksandr Svetlanov</td><td><ul style="list-style-type: none">• Korrekturlesing</td></tr></tbody></table>	Navn	Oppgave:	Raymond Holthe	<ul style="list-style-type: none">• Korrekturlesing	Marius Bakka	<ul style="list-style-type: none">• Slå sammen dokumenter og kapitler	Aleksandr Svetlanov	<ul style="list-style-type: none">• Korrekturlesing
	Navn	Oppgave:							
	Raymond Holthe	<ul style="list-style-type: none">• Korrekturlesing							
Marius Bakka	<ul style="list-style-type: none">• Slå sammen dokumenter og kapitler								
Aleksandr Svetlanov	<ul style="list-style-type: none">• Korrekturlesing								

Vi ønsker nå å få presentasjonen unna så fort som mulig og har startet å ta kontakt for å finne best mulige tid.

Oppfølgingsdokument

27/01-2014

Dato	Utført arbeid:												
20/01 – 26/01	Denne uken har vi forsøket å få i stand en fremføring av prosjektet, i mellomtiden har vi gjort de siste skrittene som var nødvendig for å lage en samling av dokumentene til presentasjonen												
	Time liste:												
	<table border="1"><thead><tr><th>Oppgave:</th><th>Raymond H.</th><th>Marius B.</th><th>Aleksandr S.</th></tr></thead><tbody><tr><td>Korrekturlesing</td><td>4</td><td>0</td><td>4</td></tr><tr><td>Føre sammen dokumenter</td><td>0</td><td>5</td><td>0</td></tr></tbody></table>	Oppgave:	Raymond H.	Marius B.	Aleksandr S.	Korrekturlesing	4	0	4	Føre sammen dokumenter	0	5	0
	Oppgave:	Raymond H.	Marius B.	Aleksandr S.									
Korrekturlesing	4	0	4										
Føre sammen dokumenter	0	5	0										

Dato	Planlagt arbeid:								
27/01 – 02/02	Vi starter og kjøre simulasjoner og regne på punkter for Power unit enheten i simuleringsbiblioteket.								
	<table border="1"><thead><tr><th>Navn</th><th>Oppgave:</th></tr></thead><tbody><tr><td>Raymond Holthe</td><td><ul style="list-style-type: none">RSM (Power calculation)</td></tr><tr><td>Marius Bakka</td><td><ul style="list-style-type: none">Power unit (Signal calculation)</td></tr><tr><td>Aleksandr Svetlanov</td><td><ul style="list-style-type: none">RSM (Power calculation)</td></tr></tbody></table>	Navn	Oppgave:	Raymond Holthe	<ul style="list-style-type: none">RSM (Power calculation)	Marius Bakka	<ul style="list-style-type: none">Power unit (Signal calculation)	Aleksandr Svetlanov	<ul style="list-style-type: none">RSM (Power calculation)
	Navn	Oppgave:							
	Raymond Holthe	<ul style="list-style-type: none">RSM (Power calculation)							
Marius Bakka	<ul style="list-style-type: none">Power unit (Signal calculation)								
Aleksandr Svetlanov	<ul style="list-style-type: none">RSM (Power calculation)								

Vi har ikke fått avklart noen dato for fremføring, vi har kommet frem til at vi skal bruke dokumentene slik som de er nå under fremføring, og kjøre videre arbeid parallelt med fremføring. Dette vil si at vi skal fremføre arbeidet frem til februar på den kommende fremføringen, mens arbeidet vi nå gjør utover blir uansett ansett som deler av den 2. fremføringen.

Oppfølgingsdokument

03/02-2014

Dato	Utført arbeid:												
22/01 – 02/02	Gjort ferdig første simulasjonene, og beregnet verdier manuelt, og teste RSM kalkulatoren												
	Time liste:												
	<table border="1"><thead><tr><th>Oppgave:</th><th>Raymond H.</th><th>Marius B.</th><th>Aleksandr S.</th></tr></thead><tbody><tr><td>Power unit (sig)</td><td>0</td><td>19</td><td>0</td></tr><tr><td>RSM (pwr)</td><td>20</td><td>0</td><td>21</td></tr></tbody></table>	Oppgave:	Raymond H.	Marius B.	Aleksandr S.	Power unit (sig)	0	19	0	RSM (pwr)	20	0	21
	Oppgave:	Raymond H.	Marius B.	Aleksandr S.									
Power unit (sig)	0	19	0										
RSM (pwr)	20	0	21										

Dato	Planlagt arbeid:								
03/02 – 09/02	Vi skal kontrollere verdiene fra beregningen på Power enheten.								
	<table border="1"><thead><tr><th>Navn</th><th>Oppgave:</th></tr></thead><tbody><tr><td>Raymond Holthe</td><td><ul style="list-style-type: none">• Power unit (power)</td></tr><tr><td>Marius Bakka</td><td><ul style="list-style-type: none">• Power unit (power)</td></tr><tr><td>Aleksandr Svetlanov</td><td><ul style="list-style-type: none">• Power unit (sig)</td></tr></tbody></table>	Navn	Oppgave:	Raymond Holthe	<ul style="list-style-type: none">• Power unit (power)	Marius Bakka	<ul style="list-style-type: none">• Power unit (power)	Aleksandr Svetlanov	<ul style="list-style-type: none">• Power unit (sig)
	Navn	Oppgave:							
Raymond Holthe	<ul style="list-style-type: none">• Power unit (power)								
Marius Bakka	<ul style="list-style-type: none">• Power unit (power)								
Aleksandr Svetlanov	<ul style="list-style-type: none">• Power unit (sig)								

Oppfølgingsdokument

10/02-2014

Dato	Utført arbeid:												
03/02 – 09/02	Vi er ferdig med beregningene til Power enheten.												
	Time liste:												
	<table border="1"><thead><tr><th>Oppgave:</th><th>Raymond H.</th><th>Marius B.</th><th>Aleksandr S.</th></tr></thead><tbody><tr><td>Power uit (pwr)</td><td>20</td><td>21</td><td>0</td></tr><tr><td>Power unit (sig)</td><td>0</td><td>0</td><td>20</td></tr></tbody></table>	Oppgave:	Raymond H.	Marius B.	Aleksandr S.	Power uit (pwr)	20	21	0	Power unit (sig)	0	0	20
	Oppgave:	Raymond H.	Marius B.	Aleksandr S.									
Power uit (pwr)	20	21	0										
Power unit (sig)	0	0	20										

Dato	Planlagt arbeid:								
10/02 – 16/02	Vi skal ta for oss terminations enheten av programmet.								
	<table border="1"><thead><tr><th>Navn</th><th>Oppgave:</th></tr></thead><tbody><tr><td>Raymond Holthe</td><td><ul style="list-style-type: none">Termination (pwr)</td></tr><tr><td>Marius Bakka</td><td><ul style="list-style-type: none">Termination (pwr)</td></tr><tr><td>Aleksandr Svetlanov</td><td><ul style="list-style-type: none">Termination (sig)</td></tr></tbody></table>	Navn	Oppgave:	Raymond Holthe	<ul style="list-style-type: none">Termination (pwr)	Marius Bakka	<ul style="list-style-type: none">Termination (pwr)	Aleksandr Svetlanov	<ul style="list-style-type: none">Termination (sig)
	Navn	Oppgave:							
	Raymond Holthe	<ul style="list-style-type: none">Termination (pwr)							
Marius Bakka	<ul style="list-style-type: none">Termination (pwr)								
Aleksandr Svetlanov	<ul style="list-style-type: none">Termination (sig)								

Oppfølgingsdokument

17/02-2014

Dato	Utført arbeid:												
10/02 – 16/02	Vi har vi fokusert på terminations enheten												
	Time liste:												
	<table border="1"><thead><tr><th>Oppgave:</th><th>Raymond H.</th><th>Marius B.</th><th>Aleksandr S.</th></tr></thead><tbody><tr><td>Termination (pwr)</td><td>20</td><td>17</td><td>0</td></tr><tr><td>Termination (sig)</td><td>0</td><td>0</td><td>18</td></tr></tbody></table>	Oppgave:	Raymond H.	Marius B.	Aleksandr S.	Termination (pwr)	20	17	0	Termination (sig)	0	0	18
	Oppgave:	Raymond H.	Marius B.	Aleksandr S.									
Termination (pwr)	20	17	0										
Termination (sig)	0	0	18										

Dato	Planlagt arbeid:								
17/02 – 23/02	Vi skal beregne på modemmet og termination enheten.								
	<table border="1"><thead><tr><th>Navn</th><th>Oppgave:</th></tr></thead><tbody><tr><td>Raymond Holthe</td><td><ul style="list-style-type: none">• Modem (sig)</td></tr><tr><td>Marius Bakka</td><td><ul style="list-style-type: none">• Termination(sig)</td></tr><tr><td>Aleksandr Svetlanov</td><td><ul style="list-style-type: none">• Modem (sig)</td></tr></tbody></table>	Navn	Oppgave:	Raymond Holthe	<ul style="list-style-type: none">• Modem (sig)	Marius Bakka	<ul style="list-style-type: none">• Termination(sig)	Aleksandr Svetlanov	<ul style="list-style-type: none">• Modem (sig)
	Navn	Oppgave:							
	Raymond Holthe	<ul style="list-style-type: none">• Modem (sig)							
Marius Bakka	<ul style="list-style-type: none">• Termination(sig)								
Aleksandr Svetlanov	<ul style="list-style-type: none">• Modem (sig)								

Oppfølgingsdokument

24/02-2014

Dato	Utført arbeid:												
16/02 – 23/02	Vi har fullført all simulering og beregning på modem enheten, og termination enheten.												
	Time liste:												
	<table border="1"><thead><tr><th>Oppgave:</th><th>Raymond H.</th><th>Marius B.</th><th>Aleksandr S.</th></tr></thead><tbody><tr><td>Modem (sig)</td><td>19</td><td>0</td><td>20</td></tr><tr><td>Termination (sig)</td><td>0</td><td>16</td><td>18</td></tr></tbody></table>	Oppgave:	Raymond H.	Marius B.	Aleksandr S.	Modem (sig)	19	0	20	Termination (sig)	0	16	18
	Oppgave:	Raymond H.	Marius B.	Aleksandr S.									
Modem (sig)	19	0	20										
Termination (sig)	0	16	18										

Dato	Planlagt arbeid:								
24/02 – 02/03	Vi skal denne uka fokusere på filter enheten.								
	<table border="1"><thead><tr><th>Navn</th><th>Oppgave:</th></tr></thead><tbody><tr><td>Raymond Holthe</td><td><ul style="list-style-type: none">• Filter (sig)</td></tr><tr><td>Marius Bakka</td><td><ul style="list-style-type: none">• Filter (pwr)</td></tr><tr><td>Aleksandr Svetlanov</td><td><ul style="list-style-type: none">• Filter (pwr)</td></tr></tbody></table>	Navn	Oppgave:	Raymond Holthe	<ul style="list-style-type: none">• Filter (sig)	Marius Bakka	<ul style="list-style-type: none">• Filter (pwr)	Aleksandr Svetlanov	<ul style="list-style-type: none">• Filter (pwr)
	Navn	Oppgave:							
Raymond Holthe	<ul style="list-style-type: none">• Filter (sig)								
Marius Bakka	<ul style="list-style-type: none">• Filter (pwr)								
Aleksandr Svetlanov	<ul style="list-style-type: none">• Filter (pwr)								

Oppfølgingsdokument

03/03-2014

Dato	Utført arbeid:												
24/02 – 02/03	Vi har jobbet med filter enheten.												
	Time liste:												
	<table border="1"><thead><tr><th>Oppgave:</th><th>Raymond H.</th><th>Marius B.</th><th>Aleksandr S.</th></tr></thead><tbody><tr><td>Filter(pwr)</td><td>0</td><td>15</td><td>19</td></tr><tr><td>Filter(sig)</td><td>16</td><td>0</td><td>0</td></tr></tbody></table>	Oppgave:	Raymond H.	Marius B.	Aleksandr S.	Filter(pwr)	0	15	19	Filter(sig)	16	0	0
	Oppgave:	Raymond H.	Marius B.	Aleksandr S.									
Filter(pwr)	0	15	19										
Filter(sig)	16	0	0										

Dato	Planlagt arbeid:								
03/03 – 10/03	Vi skal starte med Load enheten og fullføre filteret.								
	<table border="1"><thead><tr><th>Navn</th><th>Oppgave:</th></tr></thead><tbody><tr><td>Raymond Holthe</td><td><ul style="list-style-type: none">• Load (sig)</td></tr><tr><td>Marius Bakka</td><td><ul style="list-style-type: none">• Load (sig)</td></tr><tr><td>Aleksandr Svetlanov</td><td><ul style="list-style-type: none">• Filter(sig)</td></tr></tbody></table>	Navn	Oppgave:	Raymond Holthe	<ul style="list-style-type: none">• Load (sig)	Marius Bakka	<ul style="list-style-type: none">• Load (sig)	Aleksandr Svetlanov	<ul style="list-style-type: none">• Filter(sig)
	Navn	Oppgave:							
	Raymond Holthe	<ul style="list-style-type: none">• Load (sig)							
Marius Bakka	<ul style="list-style-type: none">• Load (sig)								
Aleksandr Svetlanov	<ul style="list-style-type: none">• Filter(sig)								

Oppfølgingsdokument

10/03-2014

Dato	Utført arbeid:												
03/03 – 09/03	Vi har fullført alle beregninger og simuleringer på Filter enheten.												
	Time liste:												
	<table border="1"><thead><tr><th>Oppgave:</th><th>Raymond H.</th><th>Marius B.</th><th>Aleksandr S.</th></tr></thead><tbody><tr><td>Load(sig)</td><td>21</td><td>20</td><td>0</td></tr><tr><td>Filter (sig)</td><td>0</td><td>0</td><td>14</td></tr></tbody></table>	Oppgave:	Raymond H.	Marius B.	Aleksandr S.	Load(sig)	21	20	0	Filter (sig)	0	0	14
	Oppgave:	Raymond H.	Marius B.	Aleksandr S.									
Load(sig)	21	20	0										
Filter (sig)	0	0	14										

Dato	Planlagt arbeid:								
10/03 – 16/03	Vi skal fortsette arbeidet med Umbilical og load enhetene.								
	<table border="1"><thead><tr><th>Navn</th><th>Oppgave:</th></tr></thead><tbody><tr><td>Raymond Holthe</td><td><ul style="list-style-type: none">• Umbilical (sig)</td></tr><tr><td>Marius Bakka</td><td><ul style="list-style-type: none">• Load (pwr)</td></tr><tr><td>Aleksandr Svetlanov</td><td><ul style="list-style-type: none">• Load (pwr)</td></tr></tbody></table>	Navn	Oppgave:	Raymond Holthe	<ul style="list-style-type: none">• Umbilical (sig)	Marius Bakka	<ul style="list-style-type: none">• Load (pwr)	Aleksandr Svetlanov	<ul style="list-style-type: none">• Load (pwr)
	Navn	Oppgave:							
	Raymond Holthe	<ul style="list-style-type: none">• Umbilical (sig)							
Marius Bakka	<ul style="list-style-type: none">• Load (pwr)								
Aleksandr Svetlanov	<ul style="list-style-type: none">• Load (pwr)								

Oppfølgingsdokument

17/03-2014

Dato	Utført arbeid:												
10/03 – 16/03	Vi er ferdig med load enheten												
	Time liste:												
	<table border="1"><thead><tr><th>Oppgave:</th><th>Raymond H.</th><th>Marius B.</th><th>Aleksandr S.</th></tr></thead><tbody><tr><td>Umbilical (sig)</td><td>18</td><td>0</td><td>0</td></tr><tr><td>Load (pwr)</td><td>0</td><td>18</td><td>17</td></tr></tbody></table>	Oppgave:	Raymond H.	Marius B.	Aleksandr S.	Umbilical (sig)	18	0	0	Load (pwr)	0	18	17
	Oppgave:	Raymond H.	Marius B.	Aleksandr S.									
	Umbilical (sig)	18	0	0									
Load (pwr)	0	18	17										

Dato	Planlagt arbeid:								
17/03 – 23/03	Denne uken skal vi fokusere på Umbilical enheten.								
	<table border="1"><thead><tr><th>Navn</th><th>Oppgave:</th></tr></thead><tbody><tr><td>Raymond Holthe</td><td><ul style="list-style-type: none">• Umbilical (pwr)</td></tr><tr><td>Marius Bakka</td><td><ul style="list-style-type: none">• Umbilical (pwr)</td></tr><tr><td>Aleksandr Svetlanov</td><td><ul style="list-style-type: none">• Umbilical (sig)</td></tr></tbody></table>	Navn	Oppgave:	Raymond Holthe	<ul style="list-style-type: none">• Umbilical (pwr)	Marius Bakka	<ul style="list-style-type: none">• Umbilical (pwr)	Aleksandr Svetlanov	<ul style="list-style-type: none">• Umbilical (sig)
	Navn	Oppgave:							
	Raymond Holthe	<ul style="list-style-type: none">• Umbilical (pwr)							
Marius Bakka	<ul style="list-style-type: none">• Umbilical (pwr)								
Aleksandr Svetlanov	<ul style="list-style-type: none">• Umbilical (sig)								

Oppfølgingsdokument

24/03-2014

Dato	Utført arbeid:												
17/03 – 23/03	Vi har fullført all simulering og beregning på Umbilical enheten. Det forekommer mangler og mulige feil på beregningene. Vi må jobbe videre med denne enheten.												
	Time liste:												
	<table border="1"><thead><tr><th>Oppgave:</th><th>Raymond H.</th><th>Marius B.</th><th>Aleksandr S.</th></tr></thead><tbody><tr><td>Umbilical (sig)</td><td>0</td><td>22</td><td>0</td></tr><tr><td>Umbilical (pwr)</td><td>15</td><td>0</td><td>16</td></tr></tbody></table>	Oppgave:	Raymond H.	Marius B.	Aleksandr S.	Umbilical (sig)	0	22	0	Umbilical (pwr)	15	0	16
	Oppgave:	Raymond H.	Marius B.	Aleksandr S.									
Umbilical (sig)	0	22	0										
Umbilical (pwr)	15	0	16										

Dato	Planlagt arbeid:								
24/03 – 30/03	Vi tar en pause fra prosjektet for forberedning til eksamen.								
	<table border="1"><thead><tr><th>Navn</th><th>Oppgave:</th></tr></thead><tbody><tr><td>Raymond Holthe</td><td><ul style="list-style-type: none">Forberedning til eksamen (pause)</td></tr><tr><td>Marius Bakka</td><td><ul style="list-style-type: none">Forberedning til eksamen (pause)</td></tr><tr><td>Aleksandr Svetlanov</td><td><ul style="list-style-type: none">Forberedning til eksamen (pause)</td></tr></tbody></table>	Navn	Oppgave:	Raymond Holthe	<ul style="list-style-type: none">Forberedning til eksamen (pause)	Marius Bakka	<ul style="list-style-type: none">Forberedning til eksamen (pause)	Aleksandr Svetlanov	<ul style="list-style-type: none">Forberedning til eksamen (pause)
	Navn	Oppgave:							
	Raymond Holthe	<ul style="list-style-type: none">Forberedning til eksamen (pause)							
Marius Bakka	<ul style="list-style-type: none">Forberedning til eksamen (pause)								
Aleksandr Svetlanov	<ul style="list-style-type: none">Forberedning til eksamen (pause)								

Oppfølgingsdokument

31/03-2014

Dato	Utført arbeid:
24/03 – 30/03	Forberedning til eksamen (pause)
	Time liste:
	Oppgave: Raymond H. Marius B. Aleksandr S.

Dato	Planlagt arbeid:
31/03 – 06/04	Vi skal forberede oss til presentasjonen.
	Navn Oppgave:
	Raymond Holthe • Forberedning til presentasjon

Marius Bakka	• Forberedning til presentasjon
Aleksandr Svetlanov	• Forberedning til presentasjon

Oppfølgingsdokument

07/04-2014

Dato	Utført arbeid:												
31/03 – 06/04	Forberedning til presentasjon												
	Time liste:												
	<table border="1"><thead><tr><th>Oppgave:</th><th>Raymond H.</th><th>Marius B.</th><th>Aleksandr S.</th></tr></thead><tbody><tr><td></td><td></td><td></td><td></td></tr><tr><td></td><td></td><td></td><td></td></tr></tbody></table>	Oppgave:	Raymond H.	Marius B.	Aleksandr S.								
	Oppgave:	Raymond H.	Marius B.	Aleksandr S.									

Dato	Planlagt arbeid:								
07/04 – 13/04	<ul style="list-style-type: none">• Forberedning til presentasjone• Presentasjon								
	<table border="1"><thead><tr><th>Navn</th><th>Oppgave:</th></tr></thead><tbody><tr><td>Raymond Holthe</td><td><ul style="list-style-type: none">• Forberedning til presentasjon• Presentasjon</td></tr><tr><td>Marius Bakka</td><td><ul style="list-style-type: none">• Forberedning til presentasjon• Presentasjon</td></tr><tr><td>Aleksandr Svetlanov</td><td><ul style="list-style-type: none">• Forberedning til presentasjon• Presentasjon</td></tr></tbody></table>	Navn	Oppgave:	Raymond Holthe	<ul style="list-style-type: none">• Forberedning til presentasjon• Presentasjon	Marius Bakka	<ul style="list-style-type: none">• Forberedning til presentasjon• Presentasjon	Aleksandr Svetlanov	<ul style="list-style-type: none">• Forberedning til presentasjon• Presentasjon
	Navn	Oppgave:							
	Raymond Holthe	<ul style="list-style-type: none">• Forberedning til presentasjon• Presentasjon							
	Marius Bakka	<ul style="list-style-type: none">• Forberedning til presentasjon• Presentasjon							
Aleksandr Svetlanov	<ul style="list-style-type: none">• Forberedning til presentasjon• Presentasjon								

Oppfølgingsdokument

26/05-2014

Dato	Utført arbeid:																
19/05 – 25/05	<ul style="list-style-type: none"> Finne endelige resultater for transmission lines element. Og starte med verifikasjonsrapporten. 																
	Time liste:																
	<table border="1" style="width: 100%;"> <thead> <tr> <th style="text-align: left;">Oppgave:</th> <th style="text-align: center;">Raymond H.</th> <th style="text-align: center;">Marius B.</th> <th style="text-align: center;">Aleksandr S.</th> </tr> </thead> <tbody> <tr> <td>verifikasjonsrapporten – signal beregninger</td> <td style="text-align: center;">22</td> <td style="text-align: center;">-</td> <td style="text-align: center;">-</td> </tr> <tr> <td>Verifikasjonsdokument oppsett</td> <td style="text-align: center;">-</td> <td style="text-align: center;">20</td> <td style="text-align: center;">-</td> </tr> <tr> <td>Verifikasjonsrapporten – power beregninger</td> <td></td> <td style="text-align: center;">--</td> <td style="text-align: center;">24</td> </tr> </tbody> </table>	Oppgave:	Raymond H.	Marius B.	Aleksandr S.	verifikasjonsrapporten – signal beregninger	22	-	-	Verifikasjonsdokument oppsett	-	20	-	Verifikasjonsrapporten – power beregninger		--	24
	Oppgave:	Raymond H.	Marius B.	Aleksandr S.													
	verifikasjonsrapporten – signal beregninger	22	-	-													
Verifikasjonsdokument oppsett	-	20	-														
Verifikasjonsrapporten – power beregninger		--	24														

Dato	Planlagt arbeid:								
26/05 – 2/05	Forberede presentasjon av prosjekt.								
	<table border="1" style="width: 100%;"> <thead> <tr> <th style="text-align: left;">Navn</th> <th style="text-align: left;">Oppgave:</th> </tr> </thead> <tbody> <tr> <td>Raymond Holthe</td> <td> <ul style="list-style-type: none"> Forberede presentasjon av prosjekt. Fullføre berenigner </td> </tr> <tr> <td>Marius Bakka</td> <td> <ul style="list-style-type: none"> Forberede presentasjon av prosjekt. Fullføre beregninger </td> </tr> <tr> <td>Aleksandr Svetlanov</td> <td> <ul style="list-style-type: none"> Forberede presentasjon av prosjekt. Få formelene inn i dokument rapporten </td> </tr> </tbody> </table>	Navn	Oppgave:	Raymond Holthe	<ul style="list-style-type: none"> Forberede presentasjon av prosjekt. Fullføre berenigner 	Marius Bakka	<ul style="list-style-type: none"> Forberede presentasjon av prosjekt. Fullføre beregninger 	Aleksandr Svetlanov	<ul style="list-style-type: none"> Forberede presentasjon av prosjekt. Få formelene inn i dokument rapporten
	Navn	Oppgave:							
	Raymond Holthe	<ul style="list-style-type: none"> Forberede presentasjon av prosjekt. Fullføre berenigner 							
	Marius Bakka	<ul style="list-style-type: none"> Forberede presentasjon av prosjekt. Fullføre beregninger 							
Aleksandr Svetlanov	<ul style="list-style-type: none"> Forberede presentasjon av prosjekt. Få formelene inn i dokument rapporten 								

Vi har støtt på et problem med beregningene av enkelte fasevinkler, spesielt innen signal biblioteket som må sees nærmere på for å danne riktig formell. Dette blir da ikke ferdig til innleveringen 26/05-12.

Møteinnkalling

Dato:	Tid:	Sted:
12.05.2014	10:00	A155 HBV – Kongsberg
Personer som kalles inn: Marius Bakka, Raymond Holthe, Aleksandr Svetlanov, Sigmund Gudvangen		
Møte nr: 12		
Saksliste 1. Møte om fremgang av prosjekt.		

Marius Bakka
92697472
Marius.bakka@gmail.com

Raymond Holthe
98450116
raybig1989@gmail.com

Aleksandr Svetlanov
90260463
sval04as@gmail.com

Møteinnkalling

Dato:	Tid:	Sted:
05.05.2014	10:00	D247 HBV – Kongsberg
Personer som kalles inn: Marius Bakka, Raymond Holthe, Aleksandr Svetlanov, Sigmund Gudvangen		
Møte nr: 11		
Saksliste 1. Møte om fremgang av prosjekt.		

Marius Bakka
92697472
Marius.bakka@gmail.com

Raymond Holthe
98450116
raybig1989@gmail.com

Aleksandr Svetlanov
90260463
sval04as@gmail.com

Møteinnkalling

Dato:	Tid:	Sted:
22.04.2014	10:00	HIBU – Kongsberg
Personer som kalles inn: Marius Bakka, Raymond Holthe, Aleksandr Svetlanov, Sigmund Gudvangen		
Møte nr: 10		
Saksliste 1. Møte om fremgang av prosjekt.		

Marius Bakka
92697472
Marius.bakka@gmail.com

Raymond Holthe
98450116
raybig1989@gmail.com

Aleksandr Svetlanov
90260463
sval04as@gmail.com

Møteinnkalling

Dato:	Tid:	Sted:
09.04.2014	10:30	HIBU – Kongsberg – Rom D247 og D208
Personer som kalles inn: Marius Bakka, Raymond Holthe, Aleksandr Svetlanov, Sigmund Gudvangen, Karoline Moholth, Thomas Langer		
Møte nr: 9		
Saksliste 1. Andre fremføring av hovedprosjekt. D247 blir brukt til formøte og ettermøte. Formøte begynner kl 10:30. D208 blir brukt til presentasjonen av hovedprosjektet fra kl 11:00.		

Marius Bakka
92697472
Marius.bakka@gmail.com

Raymond Holthe
98450116
raybig1989@gmail.com

Aleksandr Svetlanov
90260463
sval04as@gmail.com

Møteinnkalling

Dato:	Tid:	Sted:
03.03.2014	10:00	HIBU – Kongsberg – Rom D340
Personer som kalles inn: Marius Bakka, Raymond Holthe, Aleksandr Svetlanov, Sigmund Gudvangen		
Møte nr: 8		
Saksliste 1. Møte om fremgang av prosjekt.		

Marius Bakka
92697472
Marius.bakka@gmail.com

Raymond Holthe
98450116
raybig1989@gmail.com

Aleksandr Svetlanov
90260463
sval04as@gmail.com

Møteinnkalling

Dato:	Tid:	Sted:
24.02.2014	10:00	HIBU – Kongsberg – Rom D340
Personer som kalles inn: Marius Bakka, Raymond Holthe, Aleksandr Svetlanov, Sigmund Gudvangen		
Møte nr: 7		
Saksliste 1. Møte om fremgang av prosjekt.		

Marius Bakka
92697472
Marius.bakka@gmail.com

Raymond Holthe
98450116
raybig1989@gmail.com

Aleksandr Svetlanov
90260463
sval04as@gmail.com

Møteinnkalling

Dato:	Tid:	Sted:
17.02.2014	12:00	HIBU – Kongsberg – Rom D354 og D340
Personer som kalles inn: Marius Bakka, Raymond Holthe, Aleksandr Svetlanov, Sigmund Gudvangen, Karoline Moholth, Thomas Langer		
Møte nr: 6		
Saksliste 1. Første fremføring av hovedprosjekt. D354 blir brukt til formøte og ettermøte. Formøte begynner kl 12:00. D340 blir brukt til presentasjonen av hovedprosjektet fra kl 12:30.		

Marius Bakka
92697472
Marius.bakka@gmail.com

Raymond Holthe
98450116
raybig1989@gmail.com

Aleksandr Svetlanov
90260463
sval04as@gmail.com

Møteinnkalling

Dato:	Tid:	Sted:
01/20/2013	10:00	HIBU - Kongsberg
Personer som kalles inn: Marius Bakka, Raymond Holthe, Aleksandr Svetlanov, Sigmund Gudvangen		
Møte nr: 5		
Saksliste 1. Forberedelse til fremføring		

Marius Bakka
92697472
Marius.bakka@gmail.com

Raymond Holthe
98450116
raybig1989@gmail.com

Aleksandr Svetlanov
90260463
sval04as@gmail.com

Møteinnkalling

Dato:	Tid:	Sted:
01/13/2013	10:00	HIBU - Kongsberg
Personer som kalles inn: Marius Bakka, Raymond Holthe, Aleksandr Svetlanov, Sigmund Gudvangen		
Møte nr: 4		
Saksliste 1. Forberedelse til fremføring		

Marius Bakka
92697472
Marius.bakka@gmail.com

Raymond Holthe
98450116
raybig1989@gmail.com

Aleksandr Svetlanov
90260463
sval04as@gmail.com

Møteinnkalling

Dato:	Tid:	Sted:
12/04/2013	10:00	HIBU - Kongsberg
Personer som kalles inn: Marius Bakka, Raymond Holthe, Aleksandr Svetlanov, Sigmund Gudvangen		
Møte nr: 3		
Saksliste <ol style="list-style-type: none">1. Forehøre om planleggings dokumentasjon2. Diskutere første presentasjon, blant annet tid.3. Spørsmål relatert til krav og test – spesifikasjon.		

Marius Bakka
92697472
Marius.bakka@gmail.com

Raymond Holthe
98450116
raybig1989@gmail.com

Aleksandr Svetlanov
90260463
sval04as@gmail.com

Møteinnkalling

Dato:	Tid:	Sted:
25.11.13	14:15	HIBU - Kongsberg
Personer som kalles inn: Marius Bakka, Raymond Holthe, Aleksandr Svetlanov, Sigmund Gudvangen		
Møte nr: 3		
Saksliste <ol style="list-style-type: none">1. Forehøre om planleggings dokumentasjon2. Diskutere første presentasjon, blant annet tid.3. Spørsmål relatert til krav og test – spesifikasjon.		

Marius Bakka
92697472
Marius.bakka@gmail.com

Raymond Holthe
98450116
raybig1989@gmail.com

Aleksandr Svetlanov
90260463
sval04as@gmail.com

Møteinnkalling

Dato:	Tid:	Sted:
11/11/13	11:00	Agito AS - Kongsberg
Personer som kalles inn: Marius Bakka, Raymond Holthe, Aleksandr Svetlanov, Thomas Langer		
Møte nr: 2		
Saksliste <ol style="list-style-type: none">1. Introduksjon2. Forehøre om kravspesifikasjon fra kunden3. Ønsket format av rapport4. Linsens til simuleringsprogram5. Få klarhet i behandling av konfidensielt stoff		

Marius Bakka
92697472
Marius.bakka@gmail.com

Raymond Holthe
98450116
raybig1989@gmail.com

Aleksandr Svetlanov
90260463
sval04as@gmail.com

Møtereferat

<p>Tid: 05.05.2014 10:00 – 10:30</p> <p>Deltagere:</p> <p>Raymond Holthe, Aleksandr Svetlanov, Sigmund Gudvangen</p>	<p>Sted: HBV Kongsberg</p> <p>Referent:</p> <p>Raymond Holthe</p>
<p>Saksliste</p> <p>1. Fremgang av prosjekt</p> <p>Sak 1)</p> <ul style="list-style-type: none">• Snakket om at det er viktig med referanser og innledning i hoveddokumentet.• Passe på å få med informasjon om prosjektet og om oss på websiden.• Sammendraget skal skrives på norsk og engelsk.	

Møtereferat

<p>Tid: 22.04.2014 10:00 – 10:30</p> <p>Deltagere:</p> <p>Raymond Holthe, Aleksandr Svetlanov, Sigmund Gudvangen</p>	<p>Sted: HIBU Kongsberg</p> <p>Referent:</p> <p>Raymond Holthe</p>
<p>Saksliste</p> <p>1. Fremgang av prosjekt</p> <p>Sak 1)</p> <ul style="list-style-type: none">• Ga klarhet i hvor oppfølgingsdokumenter ligger.• Sigmund er borte neste uke. Så Det blir ikke noe møte mandag 28. April.• Kom frem til at webside må legges ut så fort som mulig.	

Møtereferat

<p>Tid: 03.03.2014 10:00 – 10:30</p> <p>Deltagere:</p> <p>Raymond Holthe, Aleksandr Svetlanov, Sigmund Gudvangen</p>	<p>Sted: HIBU Kongsberg</p> <p>Referent:</p> <p>Raymond Holthe</p>
<p>Saksliste</p> <p>1. Fremgang av prosjekt</p> <p>Sak 1)</p> <ul style="list-style-type: none">• Viste noen beregninger gjort med SimulationX og håndberegninger.• Viste hvordan SimulationX fungerer og hvordan vi går frem når vi gjør verifikasjonene.• Snakket om mulighetene for å bruke LaTeX og MiKTeX for å lage tekstdokumenter så det blir enklere å legge inn formler.• Fant ut at på fremføringen kan det være lurt å vise noen resultater fra SimulationX og sammenligne dem med håndberegninger og et annet simuleringsprogram.	

Møtereferat

<p>Tid: 24.02.2014 10:00 – 10:30</p> <p>Deltagere:</p> <p>Marius Bakka, Raymond Holthe, Aleksandr Svetlanov, Sigmund Gudvangen</p>	<p>Sted: HIBU Kongsberg</p> <p>Referent:</p> <p>Raymond Holthe</p>
<p>Saksliste</p> <p>1. Fremgang av prosjekt</p> <p>Sak 1)</p> <ul style="list-style-type: none">• Fant ut at alt som er gjort hittil må dokumenteres. Dette gjelder også håndberegninger og lignende.	

Møtereferat

<p>Tid: 04.12.2013 10:00 – 10:30</p> <p>Deltagere:</p> <p>Marius Bakka, Raymond Holthe, Aleksandr Svetlanov, Sigmund Gudvangen</p>	<p>Sted: HIBU Kongsberg</p> <p>Referent:</p> <p>Raymond Holthe</p>
<p>Saksliste</p> <p>1. Forberedelse til fremføring</p> <p>Sak 1)</p> <ul style="list-style-type: none">• Gikk igjennom dokumentene og fastslo at dette så ganske bra ut.• Snakket om SimulationX og forklarte hvordan dette programmet fungerer og hvordan dette skal brukes for våres prosjekt.	

Møtereferat

<p>Tid: 04.12.2013 14:15 – 14:45</p> <p>Deltagere:</p> <p>Marius Bakka, Raymond Holthe, Aleksandr Svetlanov, Sigmund Gudvangen</p>	<p>Sted: HIBU Kongsberg</p> <p>Referent:</p> <p>Raymond Holthe</p>
<p>Avlyst</p>	

Møtereferat

<p>Tid: 04.12.2013 14:15 – 14:45</p> <p>Deltagere:</p> <p>Marius Bakka, Raymond Holthe, Aleksandr Svetlanov, Sigmund Gudvangen</p>	<p>Sted: HIBU Kongsberg</p> <p>Referent:</p> <p>Raymond Holthe</p>
<p>Saksliste</p> <p>1. Gjennomgang av ferdig arbeid.</p> <p>2. Tid for fremføring</p> <p>Sak 1)</p> <ul style="list-style-type: none">• Vi ble enige om at visjons dokument må lages i tillegg til forstudie rapport.• Oppfølgings dokument må skrives også for de ukene hvor det ikke gjøres noe.• Vi skal lage gant diagram som viser planlagt fremdrift.• Det behøves korrekturlesning.• Forstudie rapporten skal også inneholde informasjon om hvem som er interne og eksterne veiledere og sensorer. Den skal også inneholde en kort beskrivelse av SimulationX og «Electrical SubSea» biblioteket.• Vi snakket om muligheten for å bruke et annet simuleringsprogram for å sammenligne resultatene fra SimulationX. <p>Sak 2)</p> <p>Planlegger første fremføring i midten av januar. Mens andre presentasjon bør være før påske.</p>	

Møtereferat

<p>Tid: 18.11.2013</p> <p>Deltagere: Marius Bakka, Raymond Holthe, Aleksandr Svetlanov</p>	<p>Sted: HIBU Kongsberg</p> <p>Referent:</p>
<p>AVLYST</p>	

Møtereferat

<p>Tid:11.11.2013</p> <p>Deltagere:</p> <p>Marius Bakka, Raymond Holthe, Aleksandr Svetlanov, Thomas Langer (ekstern veileder)</p>	<p>Sted: Agito AS Kongsberg</p> <p>Referent:</p> <p>Raymond Holthe</p>
<p>Saksliste</p> <p>1 Kravspesifikasjon 2 Ønsket format av rapport 3 Konfidensialitet 4 Planlegge neste møte</p> <p>Sak 1) Bedriften ønsket at målingene og beregningene skulle gjøres på 3 forskjellige punkter i simulasjonen og under 3 forskjellige forhold der forholdene spiller inn.</p> <p>Sak 2) Bedriften ønsket ikke rapporten i deres interne format, og vi fikk bruke egne formater.</p> <p>Sak 3) Det ble avgjort at all informasjon som publiseres skal godkjennes av oppdragsgiver eller ekstern veileder først. Grunnen til dette er at det er noen resultater og ideer som kanskje bør holdes internt.</p> <p>Sak 4) Vi ble enig om å kalle inn til møte ved behov.</p>	

Møtereferat

<p>Tid: 4.11.2013 14:15 – 14:45</p> <p>Deltagere:</p> <p>Marius Bakka, Raymond Holthe, Aleksandr Svetlanov, Sigmund Gudvangen</p>	<p>Sted: HIBU Kongsberg</p> <p>Referent:</p> <p>Marius Tempelen Bakka</p>
<p>Saksliste</p> <ol style="list-style-type: none">1 Åpning av møtet2 Presentere og forhøre oss om oppgaven3 Få klarhet i krav for første presentasjon4 Fremtidige møter5 Info <p>Sak 1) Vi startet med å presentere kort hva prosjektet går ut på. Vi fikk klarhet i krav for første presentasjon.</p> <p>Sak 2) Gruppen viste og forklarte oppgaven vi har blitt gitt og ble enige om at det var en god oppgave med veileder</p> <p>Sak 3) Vi fikk klarhet i hvilken dokumentasjon som kreves: Krav-spek, Test-spek, Prosjekt Plan, Forstudierapport. Og første presentasjon kan holdes desember eller januar.</p> <p>Sak 4) Mandag 14:00 ble avtalt som passe dag for fremtidige oppfølgingsmøter med veileder.</p> <p>Sak 5) Neste møte 18.11.2013</p>	