



30th Annual **INCOSE**
international symposium

Virtual Event
July 20 - 22, 2020

Engaging Mechanical Engineers in System Modeling

Katrine Gullhav
USN
Norway
gullhavkatrine@gmail.com

Cecilia Haskins
NTNU/USN
Norway
haskins@ntnu.no

Abstract. In Model Based Systems Engineering (MBSE) the system model is used to capture and share Systems Engineering (SE) data and artifacts. Using the model to communicate with the project engineers is found to be more successful with software (SW) engineers than with other domains. As a result, the system model is developed unevenly.

This article reports on how a company, whose system model is decisively more detailed in its description of SW sub-systems, might better involve mechanical (and other) engineers in system modeling. Case-based research is applied to understand the company's challenges. The conclusion is that the challenges originate from failing to consider the differences in how these domains view and relate to a system under development. The research determined that the models developed in the company-specific tool implementation were incapable of producing useful deliverables for non-software engineers. In the absence of a plan for how a mechanical engineer could access information from the model, the authors recommend defining a modeling environment to ensure the necessary contributions from both systems engineers and mechanical engineers.

Introduction

Model Based Systems Engineering (MBSE) is recommended for managing the increased complexity of modern systems (INCOSE 2014). Despite its name, MBSE is relevant to more than systems engineers. Broader initiatives such as Digital Engineering are pushing MBSE initiatives to become mindful of other engineering domains (Zimmerman, 2019). To succeed, MBSE needs to connect all model-based representations of the system from any domain, creating a truly unified digital model of the system from needs to finished product describing the entire lifecycle (INCOSE 2014). The system model created by systems architects serves as the core to link other model representations of the system with the correct context. This paper investigates the interdisciplinary aspect of MBSE; more precisely, the interaction between a mechanical engineer and the system model.

In this paper, the authors use the term “*System Engineer*” when referring to an engineer performing systems engineering (SE) activities, and “*System Architect*” when referring to an engineer responsible for generating the system model, as these are unique roles in the case company.

Company and domain. This case study was conducted within a major Norwegian defense and aerospace contractor, henceforth called the Company. Development projects for the defense industry can span decades, and a standard development project in the Company ranges from 10 to 15 years. Advanced technology projects demand state-of-the-art performance. The life span of a system is several decades, which requires a thorough maintenance and logistics concept to accompany the system design.

The mil-aero industry is experiencing an increase in the level of complexity in development projects. In response the Company is investigating the emerging SE and MBSE practices. The literature and

industrial presentations revolve around keywords such as “Single source of truth”, “Authoritative source of truth”, “Digital Engineering” and “Model Based Engineering” (D'Ambrosio & Soremekun, 2017) (Zimmerman, 2019).

The Company has established a solid SE effort with continuous focus on improving the system modeling practices. The scope, quality and knowledge of system modeling increases with each development project. Ongoing internal improvement projects look at ways to incorporate state-of-the-art MBSE methods. Company engineers have identified both benefits of MBSE, and barriers to realizing said benefits. The Company is currently starting a new development project with fewer legacy issues that offers the opportunity to use this experience to further improve the modeling practices. In this new project, it is a goal to extend the system modeling to include more aspects of the entire system, and to engage engineers from all domains with the model.

In this paper, the term hardware will refer to all non-software components unless otherwise specified.

Research Topic. Studies of earlier system models in the Company uncover a clear imbalance in level of detail between sub-systems realized by software (SW) and by hardware (HW) engineers. The detail level of SW sub-system modeling significantly exceeds that of HW sub-systems, in both the decomposition, and the specificity of the interface modeling. For example, in the company the system architects limit their modeling of HW components to cable interfaces. In addition, the SW engineer maintains an active relationship with the system model, while the mechanical engineer is rarely aware of the model's existence and relies on other model representations of the system, such as artifacts produced in CAD/CAM tools. This research investigates how the Company might enhance the modeling of HW realized sub-systems and better engage mechanical engineers in contributing to the project system model.

The remainder of this paper begins with a brief background of relevant topics, followed by the research methods. The results of the research are introduced and discussed. The paper concludes with Company specific recommendations and an evaluation of the general validity of the findings.

Background

Model-Based Systems Engineering. The International Council on Systems Engineering (INCOSE) provides definitions for Systems Engineering and Model-Based Systems Engineering (SEBoK, 2019). MBSE is more than just one more SE activity, it is a way of doing SE. Models have always been a part of the way systems engineers express themselves. The issue is that modeling practice does not imply a standardized notation (Long & Scott, 2011). Modern systems engineering support tools provided by a multitude of different vendors generally propose a holistic system model that is connected through a database repository to ensure consistency.

Introducing MBSE into any company is comparable to the transition of electrical and mechanical engineers as they embraced Computer Assisted Design (CAD) over the last 30 years (NAVAIR, 2018) (INCOSE, 2014). In MBSE, the system model is intended as the authoritative source of truth for system documentation, see Figure 1. Documents are still applicable, but they are generated from the system model as needed. All model elements are stored in the database. As such, a change in a model element will be applied everywhere the element appears as a way of ensuring that the consistency in the system documentation is not dependent on engineers tracking the element in multiple documents and model representations.

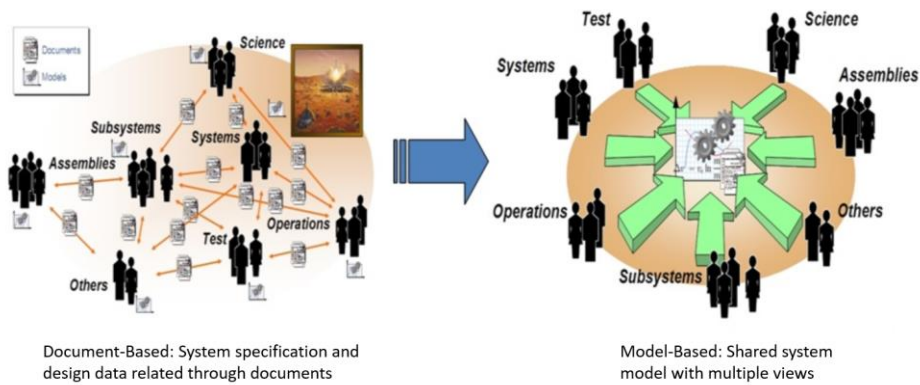

Figure 1 Document-Based vs. Model-Based approach to information sharing. (INCOSE MBSE Workshop, Jan 2014)

The INCOSE Systems Engineering Vision 2025 (2014) describes how SE tools will integrate with CAD tools, creating multidisciplinary engineering workflows. The system model will be used as an integrator between domain models, making crucial engineering data from domain models readily accessible for other engineers. Connecting all Model-Based Engineering (MBE) efforts through the system model is intended to create a companywide “single source of truth.”

RFLP Modeling Framework. The modeling method referred to in this research is based on the RFLP-approach used by Dassault Systemes. RFLP stands for Requirement, Functional, Logical and Physical. Each of the four letters represents a structure created to understand different aspects of the design. The requirement structure captures the customer needs and objectives. The functional structure is a view of what the system must do to satisfy the requirements. The logical structure shows how the functions are intended to be realized. Finally, the physical structure is the virtual representation of the end-product. The goal of this approach is to create traceability from the needs of the customer (R) to the final design of the system (P), and to enable a thorough understanding of the system design for the project team engineers (Baughey, 2011)

Company Modeling Method. The modeling method in the Company is built around the RFLP framework. The framework is modified to include two logical structures; Functional Logical (L_F), and Realization Logical (L_R). The goal is to specify the system by establishing a thorough architecture. Traceability between the structures is key to provide context to any subsystem at any level of the decomposition. Systems Modeling Language (SysML) is used to model the system.

The functional logical (L_F) structure consists of functional systems that have one function. The system is defined in a functional context without regard for physical distributions or constraints. E.g., the indicator system on a car is such a functional system, because the sole function of the system is to signal the driver’s intention to turn the car. In the realization logical (L_R) structure the indicator system is represented by multiple components with different physical locations (four lights, control unit, handle at the wheel, cables etc.). The brake light system is another functional system. In the L_F structure these two are modeled as separate systems with separate sets of requirements, behavior and states. In the L_R structure the physical elements are part of the same taillight module, and they might share the same control unit, but their activation is realized by separate modules.

The modeling method is illustrated in Figure 2. First the requirements are elicited from the stakeholder requirements and further decomposed (R). From the requirements the necessary functions are identified (F) and a functional system for each function is established (L_F). The breakdown of each of these structures continue until functional breakdown is no longer necessary and implementable components of the system are identified. The components are then aggregated in modules to represent the realized system (L_R). For each functional system and component there is an

index gathering all relevant requirements, functions, behavior diagram, state diagram and other diagrams connected to that system element. These indexes are regarded as the specification for that functional system or component. The physical structure (P) is maintained in separate specialized external tools.

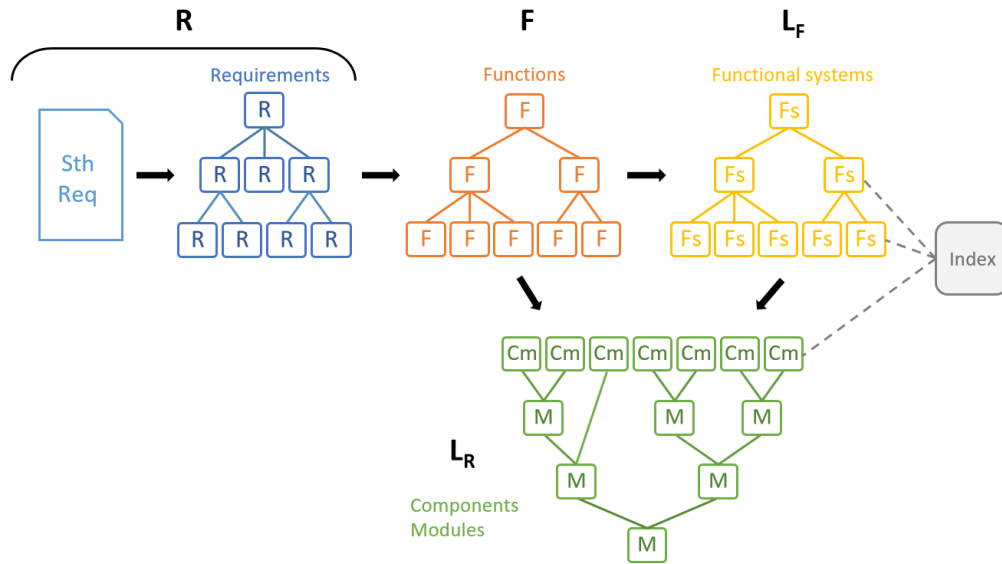

Figure 2 Modeling method used by the Company

Research Objective. The objectives of this research began as an investigation within the author’s team assignment where she was able to observe what a mechanical engineer requires from the system model, why mechanical engineers do not participate in system modeling activities, and to identify how the Company might engage mechanical engineers in system modeling.

The first author was employed as a systems engineering resource in a team of mechanical engineers developing a new launch system. This project was especially well suited as the research case as the project was mainly realized in HW, and it was a new development, with minimal legacy issues. This paper is an experience report on how MBSE has been implemented in the company, and as such, certain explicit examples are not available to preserve confidentiality.

Research Methods

Investigative exploratory research lends itself to qualitative research methods. Since the first author was embedded in the community under scrutiny, this also qualifies as a form of action research, where the researcher is as much a part of the research process as all the other participants (Corbin & Strauss, 2015).

Research Approach. This research utilizes an inductive approach, which is often described as a bottom-up approach to research. The goal is to explore a phenomenon, and to gain an understanding of the situation, which in turn can lead to hypotheses. Inductive research begins with a topic for detailed study. The design of the study is iterative and flexible, adjusting the research questions as the understanding increases (Dudovskiy, 2018).

The first author followed the approach described in Figure 3. The direction of the research was defined by iterating over the three middle steps. With a verified problem definition and an understanding of the current situation, it was possible to formulate alternative solutions to mitigate the underlying issues.

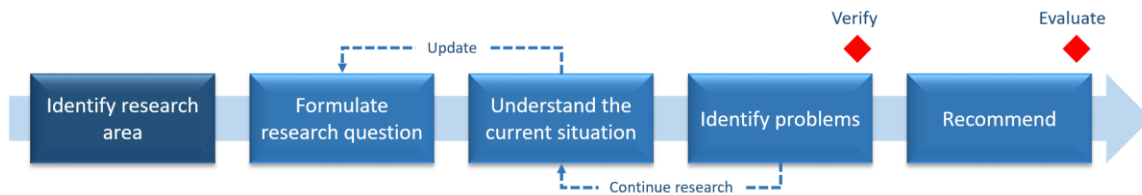

Figure 3 Research Approach

Case Based Research. Case study as a research method aims to understand a real-world situation where context is assumed to be of importance (Yin, 2014). Case study can be defined as a mixed methods research method. Case based studies rely on triangulation, that is collecting data from multiple perspectives to minimize bias in interpretation of the observations. This study used participant observation, interviews, and literature reviews.

Participant-observation. Participant-observation is a form of observation where the researcher takes an active part in what is being studied. This form of observation gives a unique opportunity to understand the case from an insider’s perspective (Yin, 2014). Observation in general has the drawback of relying on the researcher’s interpretation of the events being observed. However, combined with interviews, observations can be a powerful method to gain a thorough and correct understanding of the current and evolving situation.

Interviews. This research employed interviews, both unstructured and semi-structured, to increase understanding and validate observations. All interviews focused on specific topics of interest with a participant identified to have the most knowledge about the topic. As the goal of the research was to understand the current situation, unstructured interviews were the most common approach. Unstructured interviews allow for an open conversation and give the participants control over what to talk about, the amount of detail and the sequence. The researcher is free to follow the flow of the conversation to explore new viewpoints of the topic (Corbin & Strauss, 2015). The challenge with this form of interview is for the researcher to make sure the conversation does not stray too far from the topic and steer the conversation in a purposeful direction.

In a semi-structured interview, the researcher begins with a framework of themes to be explored. Semi-structured interviews were employed when there were several topics for discussion or specific aspects of a topic that needed to be resolved.

Interviews were not taped, but the researcher was able to take notes, and even collect some quotes from the interviewees. An excerpt of these is provided in the appendix at the end of this paper.

Literature Review. A literature review provided an understanding of the research question from a wider industry and academic point of view. The literature included sources on the topics of mechanical engineering in MBSE, the transformation from SE to MBSE and Single Source of Truth. The literature was used to determine which of the findings were not unique to the Company.

Results

Understanding the Problem. The starting point for this research was “*How to model functions for mechanical systems?*” based on an observation that there existed a difference in the level of detail of functional modeling between sub-systems realized by SW and HW engineers. The first author participated as a system architect in the HW design team. Concurrent with the modeling of HW-realized sub-systems, another system architect modeled the SW-realized sub-systems, thus providing an opportunity for real time comparison. Both engineers employed the Company’s established modeling method, in dialogue with both the Chief Systems Architect and the relevant designers. No fundamental differences existed between the functional architectures of a HW-realized system and a SW-realized system. However, two important observations were made; first, the model

did not produce any deliverable artifact that a mechanical engineer could utilize. Second, there was no solid or common understanding of how to apply both L_F and L_R modeling method.

The first observation altered the research question. Detailed functional modeling for a mechanical system is not beneficial for a mechanical engineer if s/he cannot utilize it. The research question evolved and changed into *“How to engage mechanical engineers in system modeling?”* and changes the focus to the information handover from the system model to mechanical engineers. Figure 4 illustrates three areas of interest. The first is the creation of an information interface gathering and presenting all the information relevant in the context of a sub-system. Second, the investigation into ways the modeling method needs to be updated. Last, there is a need to stimulate collaboration through defined processes. The following sections will briefly describe findings from the observations, interviews and literature, organized by the method that yielded the finding.

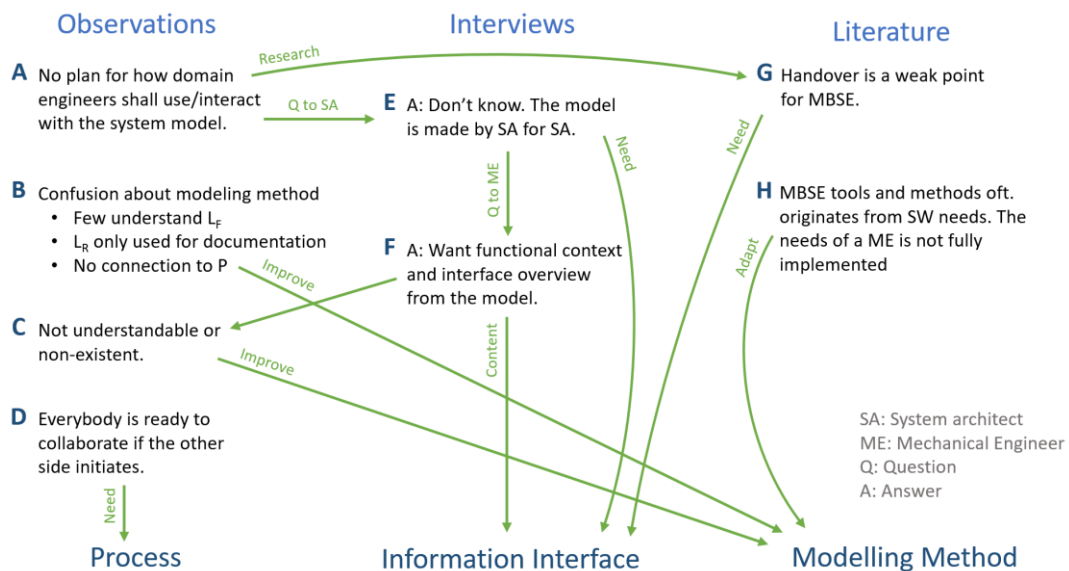

Figure 4 Organization and results of the research

Participant-observations. A – Through work tasks, meetings and discussions it became apparent that no plan exists for how a domain engineer is supposed to extract information from the system model.

Observation B – The systems engineers lack a common understanding of the modeling method, each having a different opinion of what aspects are most important. Examining the existing system model reveals several inconsistencies and deficiencies when compared to both the RFLP and Company modeling method. The addition of the functional logical (L_F) structure is a source of confusion. Some engineers find the existence of the two structurally equal structures (F and L_F) to be essential, others do not understand the need and/or the difference. The realization logical (L_R) structure is the structure representing the traditional L in the RFLP method. This structure is underdeveloped, and created in hindsight as a way of documenting, not specifying, the system. The physical (P) structure is modeled in CAD-tools without any link to any of the $RFLFL_R$ structures. Therefore, the P is not viewed as a part of “the system model”.

Observation C – A mechanical engineer designs in context of the L_R structure. Examining the system model reveals no existence of functional context or interface overviews for mechanical systems. Functions are traced to components, and components are aggregated into modules. Finding the functions of a module requires looking up each component. HW interfaces are limited to cables. This lack of information puts the mechanical engineer at a disadvantage compared to the SW engineers who instead employ the more elaborate L_F structure.

Observation D – The author observed a general willingness for collaboration, from both systems engineers and mechanical engineers. Both sides recognize the importance of the other side's contributions, they respect their colleagues' competency, and acknowledge the quality of their work. There is no “blame-game” occurring in either team. Both perceive closer collaboration as beneficial. Still, collaboration is minimal. Both sides are waiting for the other to take the initiative and guide the collaboration.

Figure 4 shows how observations (A) uncovered the need for an information handover, then interviews (E) confirmed the lack of a plan for this handover. Further, the next phase of interviews (F) explored the desired contents of such an information handover; functional context and interface overview.

Interviews. E – Interviewing a senior system architect uncovered that the Company's system model is created by system architects for system architects as the stakeholders of the model. The modeling tool is expected to provide system consistency and coherency. System architects use the model to be able to answer questions about the interfaces, sequences and behavior of the system.

F –Interviews with multiple mechanical engineers sought to identify what a mechanical engineer needs from the system model. An interesting observation from these interviews was what went unmentioned; few have an idea of how a system model may provide useful information. For example, no one mentioned requirements. According to company practice, requirements are systems engineering data that the domain engineers are accustomed to receiving through documents, and they did not think of the system model as an option to express or distribute that information. There is an apparent lack of knowledge about the intended use of a system model, regarding both purpose and content. The interviews uncovered two information elements the mechanical engineers would like to receive from the model; functional context for a module, and interface overview.

Literature. G – Literature confirms that sharing information from a system model is an area of great interest. Douglas (2015) states that the handover of information often is a troublesome activity in many engineering environments. He claims this is because the information is specified in a format, language or tool that does not meet the need of the engineers receiving the information. D'Ambrosio and Soremekun (2017) emphasize the need for a proper interface, designed to minimize the learning curve, to succeed in including domain engineers in an MBSE initiative.

H –Krueger (2015) elaborates on the differences in the domains of mechanical and SW engineering. There is a significant gap in the cost, time and effort required to modify and retest a HW versus a SW sub-system, or to produce and install multiple entities of a HW or a SW sub-system. Updating a HW system is done tangibly and sparingly, replacing only the necessary parts. SW systems are frequently distributed from a central location, without encountering physical limitations, and often as comprehensive upgrades that replace code whether it changes or not. Moeser, Albers and Kumpel (2015) point to the difference in levels of abstraction between engineers' mental models of the system as the reason for MBSE concepts not gaining traction in mechanical environments. SysML, as a derivative of UML, contains familiar notations from a SW point of view and is described as graphical modeling language. But two-dimensional boxes with lines between them are not as graphically descriptive as 3D CAD models used by mechanical engineers. The fact that SysML originates from the SW domain does raise the need to validate if the current application is suited to meet the needs of a mechanical engineer.

Discussion

The following sections will discuss the findings and the reason for identifying information interfaces, modeling method and processes as areas of interest for successfully including mechanical engineers in system modeling.

Information Interface

Sharing of information and data is a crucial part of doing engineering. Even so, Douglas (2015) identifies handover of information as a problematic activity in many engineering environments. This supports the researcher's observations. In the Company, no coherent plan for how a mechanical engineer should utilize nor access information from the system model exists. Following a document-based approach a systems engineer shares his/her work by creating documents such as requirement specifications, architecture descriptions, interface descriptions etc. Following an MBSE approach the goal is to capture this information in models and to distribute the information through those models. Douglas (2015) further states that the challenges in information handover are due to the information being specified in a format, language or tool, which does not meet the needs of the receiving engineer. By adopting an MBSE approach the Company has increased this risk because the systems engineers now want to distribute their work product in the format of models instead of the already familiar documents.

Looking into the origin of the format of the system model verified that it was modeled without the needs of domain engineers in mind. System architects create the system model for the sake of gaining understanding of the system stakeholder's needs, in order to be able to design the correct system. The stakeholders of the model itself are system architects who seek to understand the system. Other domains receive system design information in the form of documents created by system architects. The Company uses the model to communicate some SE data to SW engineers, but the communication is based on the system architect's understanding. With the model serving as the desired tool for distributing the information, system architects need to acknowledge the domain engineers as new stakeholders of the system model when they create the architecture. This is the new perspective of the model that is necessary for successful involvement of mechanical (domain) engineers in system modeling.

Part of this new perspective is defining how to use the model to handover system engineering data to domain engineers. Here, Douglas (2015) suggests gathering all sub-system specific data in one place, both SysML data from the system model and data held in other tools and models. This information interface already exists to some extent in the Company's system model as the indexes connected to functional systems and components in Figure 2. The indexes are diagrams that gather links to all the relevant diagrams from the functional (F) and functional logical (L_F) structures, requirements, state diagrams and sequence diagrams etc., for that functional system or component. An example of an index is presented in Figure 5. The general weakness of the current indexes is that they are created with the old perspective of the model. The data they collect is created and organized by system architects for system architects.

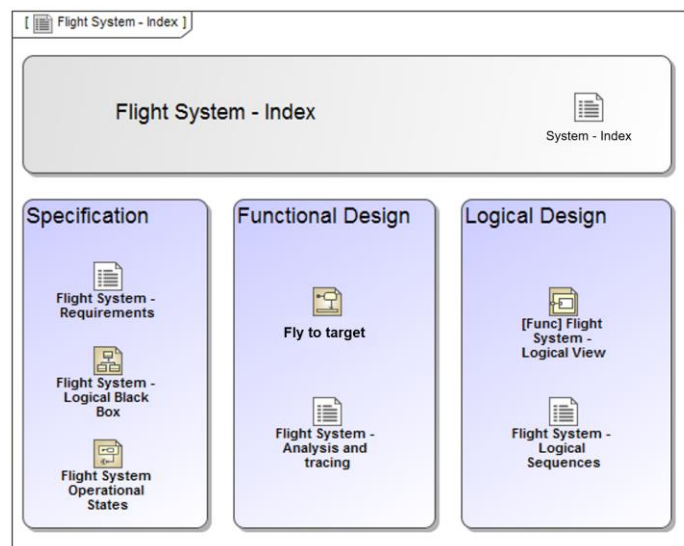

Figure 5 Information index of a functional system

To make the indexes useful for mechanical engineers the indexes must exist in the context of a realization logical (L_R) module. In interviews, mechanical engineers called for an overview of how all the functions in their module work together, as well as the functionality around them. The current indexes gather relevant diagrams in the context of a functional system responsible for performing one function. A module realized in HW usually has more than one function. Returning to the previous example presented in the Background; a mechanical engineer designing the taillight of a car will find it laborious to go to each functional system to find requirements, behavior and states for each light bulb to understand his/her sub-system. The other desired output identified is an overview of all the interfaces in a module. The functional logical (L_F) structure provide this interface overview for SW systems, however the L_R structure provides only a limited overview, currently constrained to cabling. The additional indexes connected to the L_R structure should contain the same information that the indexes of the L_F structure contain today, just gathered in the context of a module instead of a functional system. The content in the indexes need not be limited to SE data. Mechanical engineers should link their own model representations of the system to the indexes, creating an information interface for sharing information both ways. This link would represent the connection to the P in the RFLP framework.

Creating indexes in the context of L_R modules will give mechanical engineers an interface to the model that they can relate to, with information they can use to increase their understanding of the system they are designing. With a way to access and utilize the system model, involving them in the creation becomes a task with a tangible benefit. The importance of dedicating enough resources to develop the indexes properly cannot be overstated. Convenient and standardized interfaces facilitate a willingness to accept change (Albers & Lohmeyer, 2012). Providing intuitive interfaces to the model is important to gain acceptance for changing the format of information from documents to models.

Modeling Method

The second area of interest for attracting mechanical engineers to participate in system modeling is the modeling method applied at the Company. The researcher observed considerable deviations between the described modeling method and the applied modeling method.

Functional Logical Structure. The Company has added a structure to the RFLP-framework described by Dassault Systemes. This functional logical (L_F) structure is the source of most of the confusion around the modeling method. The L_F structure matches the functional (F) structure one-to-one, but with more detailed SW interfaces. System architects use the L_F structure to detail the sub-systems realized in SW to be able to hand over a system specification to SW engineers. Initially, the researcher attempted to define how an L_F structure contributes value for a HW realized sub-system. The conclusion is that it does not. The Company's struggle to involve mechanical engineers in system modeling is partly attributed to this observation, coupled with the fact that this is where system modeling in practice ends in the Company.

Realization Logical Structure. The realization logical (L_R) structure is the least detailed structure in the system model. This part of the model is intended as the bridge between the logical representations (modules) of the system and the physical units that shall be designed and produced. All the existing L_R structure were created after the system was designed to document the final design in the system model. The lack of an L_R structure during the design phase partially explains why mechanical engineers have not found the system model useful to understand the system design or the evolution of thinking that led to the design.

Modeling Method. Looking at how the modeling method is described provides some insight to why the creation of the L_R structure became a documentation exercise. Functions are elicited from the requirements. Each function is allocated to a functional system. Functions (and functional systems) are decomposed until the function is allocated to a component that can be bought, reused or made. The components are aggregated into modules that make up the L_R structure. The workflow seems to

be linear, working top-down to create the F and L_F structure, and bottom-up to create the L_R structure. Figure 6 illustrates the modeling method.

The reality is that all three structures are made top-down. Before a function can be decomposed into sub-functions a concept is chosen. If the top function is “Move passengers” there is a significant difference in the needed sub-functions whether the chosen concept is a car or a horse-drawn carriage. These concepts are the modules when the L_R structure is created top-down. See Figure 7. This means that if a system architect fails to model L_F and L_R in parallel, the L_R structure is already set when s/he have defined the components and are ready to aggregate them into modules. Therefore, creating the L_R structure is reduced to merely a documentation activity in current practice.

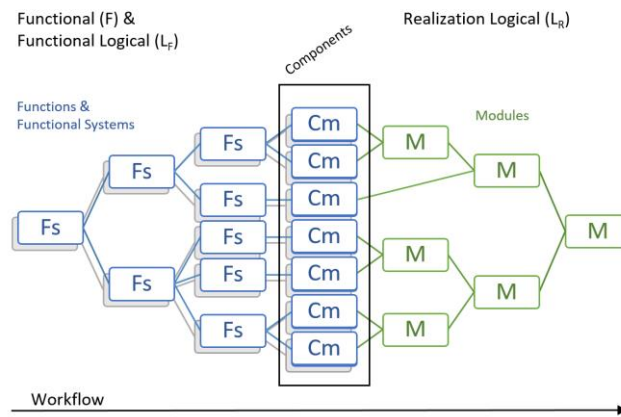

Figure 6 Modeling method

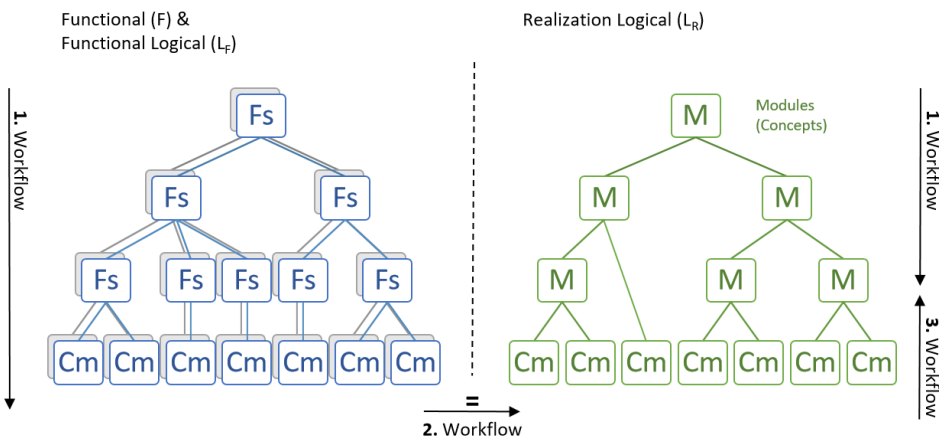

Figure 7 Design process

Figure 6 describes the modeling method and Figure 7 describes the design process in the Company. The modeling method needs to be updated to be able to model the entire design process. Currently a method for creating the L_R structure top-down is not defined, or a way to connect it to the functional structure other than through components. This limited connection to the functional structure results in the lack of the functional context needed by the mechanical engineers. With the modeling method updated to create the L_R structure in parallel with the L_F structure, and indexes designed to gather information in a relevant context, the model would be capable of producing and presenting useful content for mechanical engineers.

Fundamental Differences Between HW and SW. Krueger (2015) highlights fundamental differences in how HW and SW systems are developed, produced and maintained. This suggests that

a SW engineer and a mechanical engineer have two very different ways of viewing and relating to the system. The Company's system model has an extensive L_F structure. This structure is used to specify SW sub-systems and to communicate with SW engineers. Several attempts to include mechanical engineers in this communication have failed. Up until now, the assumption was that the failure was due to a lack of training in reading and relating to models made by SysML. From research it became apparent that the L_F structure does not present the system in a way relatable to a mechanical engineer. A mechanical engineer relates to the L_R structure of the model, versus a SW engineer who relates to the L_F structure and gains little from the L_R structure. Hence, the modeling already executed in the company is not wrong, it just has been effectuated with a SW oriented system view.

Physical Structures. RFLP is not just a systems engineering framework. The P represent all model representations of the system applied by the domain engineers. Connecting RFL to P creates a common model connecting systems engineering data directly to the entities of the system for the domain engineers. This common model is what the industry calls Single/Authoritative Source of Truth, Digital Tread, Model-Based Engineering etc. Currently there are no connections between RFL_{F/L_R} and P in the company. Creating this connection will be difficult if the L_R structure of the system model remains underdeveloped.

Defined Processes for Collaboration

The previous sections discussed enabling measures to involve mechanical engineers in system modeling. What is lacking is a plan for sharing or transferring information from the model and involving mechanical engineers in system modeling.

Involving mechanical engineers in system modeling does not mean teaching them how to use SysML to model their own parts of the system. It means involving them in the process of creating the system model and providing them with what they need to perform the mechanical engineering design effort. Input from domain experts is crucial to make the correct architecture and avoid expensive design errors that will surface during implementation, or worse, during integration or testing.

The final area of interest to involve mechanical engineers in system modeling in the Company were identified by the interesting observation that everybody wants to collaborate, but no one does. Involving mechanical engineers in system modeling requires collaboration. Even in an environment ready to collaborate, there is a need for defined processes with specified roles and responsibilities to stimulate the collaboration.

Multi-domain Meetings. An attempt at collaboration was initiated as part of this research effort. The researcher observed a multi-domain meeting dedicated to discussing a specific sequence in the system. The meeting aimed to clarify the relationship between a feasible HW-design and safety requirements, and what functions should be realized by HW or SW, and with what safety impact. The meeting notification was sent to about seven participants a week in advance. The day of the meeting over 20 engineers were scheduled to attend. The interest for this meeting dedicated to discuss cross-domain concerns was overwhelming. The responsible systems engineer presented the current sequence and HW-design and opened the room for discussion. After the meeting, nobody had a clearer view of how to balance physical restrictions with safety requirements, no decisions were made, no guidelines for design were produced. Too many engineers attended the meeting, everybody wanted their viewpoint heard, and which viewpoints got focus was dependent on the person advocating it. The discussion became too unstructured to accomplish anything.

The researcher began preparing a new meeting with a significantly smaller scope, taking on the role of the responsible systems engineer. To structure the discussion a morphological analysis was selected. Morphological analysis is a recognized tool to define the solution space. A morphological analysis consists of a set of parameters with multiple alternatives each. One specific solution is the combination of one alternative for each parameter. The solution space is the accumulated number of possible solutions (Álvarez & Ritchey, 2015).

The researcher identified six important parameters for the design, with two or three alternatives for each, from the functional (F) structure and customer needs. This gave a solution space with 32 possible solutions. The solution space represents different solutions with impact on different aspects of the total system, and uncertainties in how to prioritize. The last preparation for the meeting was the selection of the participants. Based on the domains affected by the solution space one or two engineers from each domain were invited.

In the meeting each alternative of the parameters was discussed. The correctness of the parameters was also evaluated. Three alternatives were eliminated, two alternatives were rewritten as one, one parameter was split in two with only one alternative each. All this reduced the solution space from 32 to 6 possible solutions. See progress in Figure 8. The discussion in the meeting was structured by the defined morphological analysis, and the researcher could with relative ease direct it back on track should someone become hung up on details outside of scope. After the meeting several big questions were settled and specific areas to investigate to answer the remaining questions had been identified. The meeting yielded spontaneous and immediate positive feedback. A new meeting was scheduled the week after.

Before the second meeting the researcher captured and distributed the minutes of the previous meeting with the action items assigned to the appropriate engineers and updated the morphological analysis to include the result of the discussion. The next meeting reduced the solution space from six to two. See Figure 8. The reduced solution space gave design guidelines to the mechanical design team, a clarification in the various safety impacts, and a common agreement on that section of the architecture in the system model. The meetings indicate the potential for progress as a result of multi-domain meetings. The two different approaches show how structured meetings can be more effective in achieving a specific goal, and reinforces the suggestion that defined processes enable collaboration.

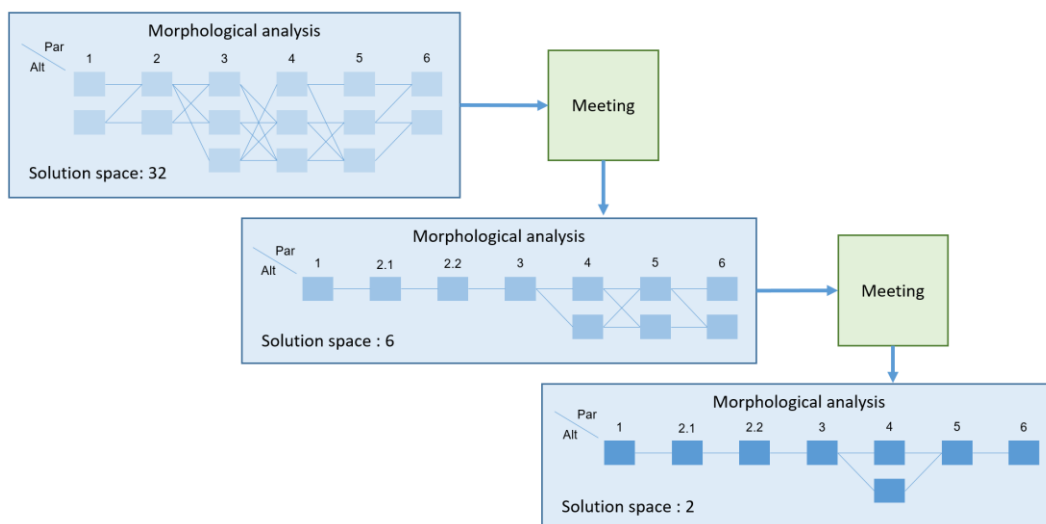

Figure 8 Development of morphological analysis

Systems Engineer Responsibility. The interest for multi-domain meetings validates both the willingness to collaborate and the need for such meetings. The significantly different outcomes of the first and the last two meetings testify to the importance of structure in such meetings. The preconditions for this conclusion are that effective multi-domain meetings are not already part of the company culture, and that the scope of meetings is focused to solve a defined problem (e.g. not vaguely implied innovation).

Based on the observation that everybody waits for someone else to initiate collaboration, assigning the responsibility of said collaboration becomes a significant part of defining a procedure. Literature

describes SE as an engineering discipline with interdisciplinary responsibilities focusing on the whole system (SEBoK, 2019, on SE) (Sols, 2014). A systems engineer is tasked with maintaining a holistic view of the system, ensuring that the decisions that are made are right for the entire system, not just in the context of a single sub-system or discipline. Thus, the responsibility for multi-domain collaboration naturally rests with the systems engineer.

The responsibility includes:

- Identify the need for a multi-domain meeting
- Define the scope
- Prepare the structure and content of the meeting
- Include the correct people
- Guide the meeting
- Follow up

Systems engineers should identify the need for a multi-domain meeting and initiate it. Defining the scope will clarify for all involved the discussion and the goal. Limiting the scope to a manageable size is important. There must be enough time to discuss, not just present, the problem. The discussion will most likely expose unconsidered aspects of the problem. Multi-disciplinary meetings will therefore often be a series of meetings because there will be a need to investigate the new aspects further. The systems engineer should prepare the meetings, both content and structure. A morphological analysis was an effective tool for this situation, but part of the preparation is to choose the correct tool from the SE toolbox. The final preparation for the meeting is to invite the correct people. People with knowledge about the topic, insight to discuss the problems, and affected by the scope. During the meeting the systems engineer needs take an active role in keeping the discussion within scope and push onward to achieve progress. After the meeting the systems engineer is obligated to properly document the discussion and decisions, and follow up on any action items. Especially action items with a large lead time between doing the task and when the result is needed. The systems engineer should take responsibility to be the receiving party to ensure the task is performed.

This suggestion works as described because the engineers are co-located on a single campus. In more geographically disbursed teams, occasionally scheduling face-to-face meetings is desirable to build interpersonal trust (Grove, 2019).

Conclusions

This research identified the sharing of information as the biggest challenge to involve mechanical engineers in system modeling. The handover becomes problematic because system architects have not considered mechanical engineers as one of their stakeholders when modeling the system, and because the modeling practices currently in place are not robust enough to meet the needs of domain engineers other than SW engineers. Defining procedures to ensure mechanical engineers are involved in the creation of the model is an obvious answer to the challenge. However, the act of involving someone will always meet resistance if the work is not beneficial. Thus, ensuring that the model is able to produce useful deliverables and planning how to make those deliverables accessible are the first steps towards engaging mechanical engineers in system modeling.

One aspect of the information handover requires extra attention. Information handover from the system model to any domain engineer is not a single event. It is a continuous process where the information flow goes both ways. Systems engineers work with defining and specifying the entire system to guide the development and design performed by various domain engineers. As the knowledge and understanding of the system increases, the content in the information interfaces become more detailed and accurate. Domain engineers provide much of this increase in knowledge as they develop their respective sub-systems.

This research concludes that successfully involving mechanical engineers in system modeling requires:

- A plan to make the information in the system model accessible.

- A modeling method that produces useful deliverables for a mechanical engineer.

- Defined processes that:

 - Assign the responsibility of initiating collaboration.

 - Provide guidelines on how to start collaborating.

The system model remains a tool belonging to the system architect. When the Company MBSE initiatives propose to use this model to communicate SE data with other domains, domain engineers become a stakeholder of the model. As stakeholders they are both sources and recipients of the information generated by the model. Planning how to share information with the model is an important aspect to make sure the engineers see the benefit of being involved in system modeling. The need to plan for a good information sharing is not limited to the Company. Literature highlights the importance of good and intuitive interfaces to decrease learning curves and gain acceptance. Information sharing is also stressed as critical activity with high risk of miscommunication.

The challenges regarding modeling method discussed in this paper are specific to the modeling method in the Company. The solution of enhancing the L_R structure of the model is relevant in the context of the Company's modeling method. However, the research found that many challenges originated from trying to apply what worked with SW engineers to mechanical engineers without considering the differences between these domains. Literature describes the existence of fundamental differences in how engineers view and work with systems realized by SW or HW. The Company is recommended to reconsider the current processes and to verify that any new process yields a system model that produces useful deliverables to all stakeholders in the system development.

Collaboration is key when addressing cross-domain initiatives such as engaging mechanical (and other domain) engineers in system modeling. Defining processes proved to be a key factor for achieving this collaboration. The limited scope of the process this paper suggests is valid for an environment ready to collaborate. If the situation between the different domains is more tense, or they are unwilling to collaborate, other or more extensive means might be necessary. In line with general SE theory, the responsibility of initiating cross-domain collaboration is assigned to the systems engineer.

Future Work

Common understanding of the modeling method suggests a broader issue of how MBSE is used in practice and is a topic worthy of additional research for the INCOSE community.

The research performed for this thesis uncovered three areas of interest to improve upon the engagement of mechanical engineers in system modeling. Although the findings are supported by literature further research in other projects or companies should be performed to validate them.

In the Company, the content of the information interfaces should receive further consideration. This paper limited its focus to look at functional context and interface overviews for mechanical systems because those were the two prominent needs identified in interviews. From the interviews it also became apparent that there was a lack of knowledge of what kind of information the system model could provide. System architects and mechanical engineers should collaborate to specify the information interfaces.

Updating a modeling method is a long-term improvement project. This paper identifies deficiencies in the current modeling method and suggests areas for improvement. The impact of the changes needs a more thorough examination before being implemented. The process for collaboration is outlined based on the experience from three meetings. The process is still in need of refinement by applying it in more meetings and evaluating the results.

Acknowledgements

The researcher is grateful to all colleagues of the Company who participated in providing much needed inputs, and to her thesis supervisor Robert Cloutier.

References

- Albers, A., & Lohmeyer, Q. (2012). *Advanced Systems Engineering – Towards a Model-Based and Human-Centered Methodology*. Karlsruhe: TMCE 2012.
- Álvarez, A., & Ritchey, T. (2015). *Applications of General Morphological Analysis - From Engineering Design to Policy Analysis*. *Acta Morphologica Generalis*.
- Baughey, K. (2011). *Functional nad Logical Structures: A Systems Engineering Approach*. SAE International.
- Corbin, J., & Strauss, A. (2015). *Basics of Qualitative Research: Techniques and Procedures for Developing Grounded Theory*. Los Angeles: SAGE Publications, Inc.
- D'Ambrosio, J., & Soremekun, G. (2017). *Systems Engineering Challenges and MBSE Opportunities for Automotive System Design*. Banff, Canada: 2017 IEEE Intertantion Conference on Systems, Man and Cybernetics (SMC).
- Douglas, B. (2015). *Agile Systems Engineering*. Morgan Kaufmann.
- Dudovskiy, J. (2018, April 2). *Inductive Approach (Inductive Reasoning)*. Retrieved from Research Methodology:
<https://research-methodology.net/research-methodology/research-approach/inductive-approach-2/>
- INCOSE. (2014). *A World in Motions - Systems Engineering Vision 2025*. International Council on Systems Engineering.
- Krueger, C. W. (2015). *Mechanical Product Lifecycle Management meets Product Line Engineering*. Nashville, USA.
- Long, D., & Scott, Z. (2011). *A Primer For Model-based Systems Engineering*. Vitech Corporation.
- Louie, C. (2014, May 22). *Model Based Systems Engineering Readiness for Complex Product Development*. Retrieved from The SysEne Blog:
<http://www.engineeringnewworld.com/?p=240>
- Moeser, G., Albers, A., & Kümpel, S. (2015). *Usage of Free Sketches in MBSE - Raising the applicability of Model-Based Systems Engineering for Mechanical Engineers*. 2015 IEEE International Symposium on Systems Engineering (ISSE).
- NAVAIR. (2018, January 30). *Systems Engineering Transformation*. Retrieved from YouTube:
<https://www.youtube.com/watch?v=171bINCgpCo>
- SEBoK. (2019, May 26). *Model-Based Systems Engineering (MBSE) (glossary)*. Retrieved from Systems Engineering Body of Knowledge - SEBoK:
[https://www.sebokwiki.org/wiki/Model-Based_Systems_Engineering_\(MBSE\)_\(glossary\)](https://www.sebokwiki.org/wiki/Model-Based_Systems_Engineering_(MBSE)_(glossary))
- SEBoK. (2019, May 26). *Systems Engineering (glossary)*. Retrieved from Systems Engineering Body of Knowledge - SEBoK:
[https://www.sebokwiki.org/wiki/Systems_Engineering_\(glossary\)](https://www.sebokwiki.org/wiki/Systems_Engineering_(glossary))
- Sols, A. (2014). *1.4 Systems Engineering: The Origins*. I Systems Engineering - Theory and Practice (ss. 27-32). Madrid: Universidad Pontificia Commlas.
- Yin, R. K. (2014). *Case Study Research: Design and Methods*. Los Angeles: SAGE Publicaitons, Inc.
- Zimmerman, P. (2019). *DoD Digital Engineering and Implementation Challenges*. Jet Propulsion Laboratory 4th Model-Based Systems Engineering and Digital Engineering Symposium and Workshop.

Biography



Katrine wrote the first iteration of this paper as the final submission for her Master of Science in Systems Engineering from the University of South-Eastern Norway in 2019. Over the three years of this program she has gained experience as a project engineer in the Company, working with test and verification, and system architecture and design. Katrine have a Bachelor Degree in Industrial Design from Østfold University-College.



Cecilia is an American living and working in Norway. These days she is a part-time teacher, consultant, author and volunteer. Her 35-year industrial career includes jobs with large and small firms, commercial and government projects, as employee and entrepreneur. Technically she has worked in every phase of the software lifecycle and has been a Certified Computer Professional since 1979. Her educational background includes a BSc in Chemistry from Chestnut Hill College, and an MBA from Wharton, University of Pennsylvania. This combination has contributed to her ability to understand issues with an insider's view of both the business environments and the IT technical solution domains. She has been recognized as a Certified Systems Engineering Professional since 2004 and earned her PhD from NTNU in 2008. Currently she is teaching systems engineering courses, and advising student theses and projects in the defense, space and automotive domains.

Appendix

This appendix contains notes and quotes collected during the interviews and used to support researcher observations, and various assertions found in this paper.

Mechanical engineer 1: Desires more involvement from systems. Desires information about the context the system operates/exists in.

Mechanical engineer 2: Desires overview of how the functions they work with integrates with the rest of the system / surrounding parts. (Note: The understanding is there, but desires to receive the information formally) Desires the same structured overview of interfaces.

Test engineer 1: Gather all requirements for a subsystem in one place. (Note: Originates from a frustration that environmental requirements are not properly evaluated and considered in early design) (Note: Functional, environmental, performance, interface, physical, design constraints in one place. What traditional SE advocates)

Question to multiple system architects: How shall I model to benefit mechanical engineers?

Answer: Don't know. (And a general agreement that ME will benefit from the system model)

Quote: "ME found their place in industry a 100 years ago and have not been challenged since" Mechanical engineer/System engineer on why it is so difficult to get ME to rethink the old ways (SE/MBSE)

Quote: "You don't have to model the foundations, it's just a mechanical part. It's enough to represent them with one frame enclosing the other components." System architect instructing to not create a block for a purely mechanical part, but rather draw a rectangle around the other block writing "Foundation" beside it.

Quote: "I don't care much about how it is presented or structured, I'm more interested in the process leading up to it (the information being created)." System architect on information interfaces. Hence the lack of focus on information handover.