

Paper E:
**Non-linear model predictive
control scheme for stabilizing
annulus pressure during oil well
drilling**

Gerhard H. Nygaard, Telemark University College, Geir Nævdal, IRIS Petroleum

Received 26 May 2005. Received in revised form 18 November 2005.

Accepted 15 January 2006. Published in *Journal of Process Control* Volume 16, Number 7, 2006.



ELSEVIER

Available online at www.sciencedirect.com

SCIENCE @ DIRECT®

Journal of Process Control 16 (2006) 719–732

JOURNAL OF
PROCESS
CONTROL

www.elsevier.com/locate/jprocont

Nonlinear model predictive control scheme for stabilizing annulus pressure during oil well drilling

Gerhard Nygaard^{a,b,*}, Geir Nævdal^b

^a Department of Electrical Engineering, Information Technology and Cybernetics, Telemark University College, Kjølnes Ring 56, N-3901 Porsgrunn, Norway

^b IRIS Petroleum, International Research Institute of Stavanger, Thormøhlensgate 55, N-5008 Bergen, Norway

Received 26 May 2005; received in revised form 18 November 2005; accepted 15 January 2006

Abstract

This paper presents a nonlinear model predictive control scheme for stabilizing the well pressure during oil well drilling. While drilling, a fluid is pumped through the drill string and the drill bit, and is returning through the annulus between the drilled well and the drill string. Varying reservoir conditions and fluctuation in circulation flow rates cause sudden variations in the pressure conditions along the well. To compensate for these pressure fluctuations, the annulus choke valve opening can be adjusted. The proposed control scheme is based on a first-principles two-phase flow model using spatial discretization of the complete well. The optimal future choke settings are found using the Levenberg–Marquardt optimization algorithm. This control scheme is evaluated against two other control methods, a manual control scheme and a standard feed-back PI-control scheme of the choke valve with feed-forward control of the pump rates. The PI-control parameters are found using the Ziegler–Nichols closed-loop method based on simulations from a low-order model. The results show that both the PI-control scheme and the model predictive control scheme are superior to manual control. However, the PI-control scheme requires that the control parameters are re-designed when the operating conditions are deviating from the original design conditions. The model predictive control scheme will perform within the operating limits as long as the detailed model is able to describe the actual conditions of the well.

© 2006 Elsevier Ltd. All rights reserved.

Keywords: Nonlinear model predictive control; Pressure control; Drilling

1. Introduction

Several areas within oil well drilling have been subject for automatic control the recent years. Especially automated drill pipe handling and directional drilling are areas that have gained from increased instrumentation and automation. This paper focuses on controlling the pressure gradient along the well during drilling.

During oil well drilling, a drill fluid is pumped into the drill string. This drill fluid is flowing down the drill pipe,

through the drill bit, and upwards through the annulus between the drill string and the sidewall of the well. One of the purposes of the drill fluid is to transport the cuttings from the drilling process up to the surface. Another important scope of the drill fluid is to maintain a certain pressure gradient along the length of the well.

A critical part of the well is the reservoir zone, where the formation is likely to be porous. The pressure balance between the well section and the reservoir is important. If the pressure in the well is higher than the reservoir pore pressure, it is referred to as over-balanced drilling. This condition causes the circulation fluids to penetrate into the reservoir formation. On the other hand, if the pressure in the well is lower than the reservoir pore pressure, it is referred to as under-balanced drilling, and the reservoir fluids migrate into the well annulus.

* Corresponding author. Address: IRIS Petroleum, International Research Institute of Stavanger, Thormøhlensgate 55, N-5008 Bergen, Norway. Tel.: +47 5554 3850; fax: +47 5554 3860.

E-mail address: Gerhard.Nygaard@irisresearch.no (G. Nygaard).

Over-balanced drilling is the most used method for drilling oil wells. The reason for this is that it nearly eliminates the risk for an uncontrolled “blow-out” situation, where the pressure in the reservoir causes large amounts of the reservoir fluids to penetrate into the well and follow the well to the surface.

Today, different type of equipment such as blow-out preventer, gives the possibility of reducing the well pressure lower than the reservoir pressure. Drilling the oil well having under-balanced conditions, have several benefits. The most important benefit is that the porous formation is less damaged, since the particles from the drilling process do not penetrate into the formation. This leads to a higher production rate when the oil well is set into production. The well pressure is managed during the drilling process by adjusting the density and the flow rate of the drilling fluids. In case the reservoir pore pressure is lower than the hydrostatic pressure caused by the circulation liquids, gas has to be injected to reduce the well pressure. The complex behaviour of the resulting two-phase flow results in challenges regarding the effort of maintaining a correct well pressure gradient along the well. In addition, migration of reservoir fluids (gas and/or liquids) from the reservoir formation makes the task even more difficult [1–3].

Controlling the bottom-hole pressure during drilling can however still be a challenging task due to complex behaviour of the well fluids. However, the research within dynamic flow modelling the last decade has shown promising results, and using the recent algorithms and computational power, experimental results has shown that it is possible to model the dynamic behaviour of the fluids in an oil well [4].

Typically, in most drilling operations, the choke valve is manually controlled by an operator [5,6]. More advanced methods for controlling the well pressure gradient are emerging [7–10] as new marginal oil fields with narrow pressure margins are being evaluated for production.

This paper presents a nonlinear model predictive control scheme for controlling the pressure during under-balanced oil well drilling. This scheme is compared with a manual control scheme and a standard PI-control scheme. The paper is divided into eight sections. Section 2 lists the challenges of pressure control during oil well drilling. Section 3 describes three available control schemes, and then two different process models are presented in Section 4. In Section 5 a test case is described and the two models are compared. In Section 6 the control parameters for each of the control schemes are designed, and Section 7 presents the results where the control schemes are applied to the test case. The conclusion is made in Section 8.

2. Process description

A drilling system consists of a rotating drill string, which is placed into the well. The volume around the drill string is referred to as the annulus. The drill fluid is pumped through the drill string and is exiting through the choke

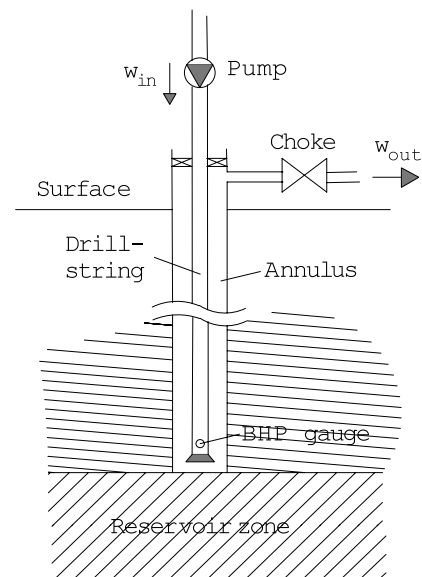

Fig. 1. Schematic layout of an oil well drilling system. The drill fluid is pumped into the drill string and enters the well annulus at the drill bit. From the annulus, the drill fluid exits through the choke valve.

valve. A schematic of an oil well drilling system is shown in Fig. 1. During drilling, disturbances that cause fluctuations in the well pressure might occur. The operator has to make proper actions to avoid variations in the well pressure.

The disturbances arise from several sources. One source is the hydrostatic pressure of the well. The well length is increasing, and hence the well pressure is increased. Another source is that more of the reservoir is exposed to the well pressures, as drilling progresses. The reservoir parameters such as reservoir pore pressure and reservoir permeability influence on the influx of reservoir fluids to the well. This reservoir fluid influx changes the well flow rate and density of the well fluid mixture.

A third source of disturbance is caused by a pipe connection procedure, which is performed at equal time intervals during drilling. The drill string consists of several pipe segments, which are jointed together. As the well is becoming longer, new pipe segments are added to the drill string using a pipe connection procedure. The pipe connection procedure mainly consists of five operations. First the rotation of the drill string is stopped. Secondly the pumping of the drill fluid into the drill string is stopped. Then a new pipe segment is mounted to the drill string. Next action is to restart the drill fluid pumps, and finally the drill string rotation is re-started. This procedure, and especially stopping and starting of the drill fluid causes severe fluctuations in the well fluids flow rates, and influence the well pressure. This paper is focusing on how to avoid these fluctuations using various control schemes.

To compensate for variations in the well pressure, the operator might modify the fluid composition and flow rates into the drill string. This will change the density of the fluid mixture in the well, and this affects the well pressure.

However, well pressure is not modified instantly, since the new fluid composition need some time to be filled into the whole well. Another way the operator might use to modify the well pressure is to adjust the opening of the choke valve on top of the annulus part of the well. Changing the valve opening causes a rapid response in the bottom-hole annulus pressure.

Both methods are used to compensate the bottom-hole pressure, but during pipe connections the well pressure is normally maintained using the choke valve. One of the main problems for controlling the well pressure during pipe connections is that no measurement of the pressure is available. The transmission of the signal is usually based on a mud pulse telemetry system. This system is sending various data from the bit system, but the system is only operating while the drill fluid is circulating. Recently, a system is developed which integrates a signal cable into the drill string, but the signal cable has to be disconnected during data signal giving no data during the pipe connection [11]. The control system must then rely on simulated values from a sufficiently accurate dynamic model of the well system. Alternatively, the pressure sensor signal might be transmitted to the top of the well using an electro-magnetic transmission system. An electro-magnetic transmission system uses the formation as transmission medium, and will therefore also be able to transmit data during the whole drilling operation. However, the electro-magnetic transmission system might have some difficulties transmitting data in deep wells due to attenuation of the electro-magnetic signal, but for wells down to 1500–2500 m depth the transmission quality is sufficient [12].

3. Control schemes

Today, in normal drilling operations the choke valve is adjusted manually by a trained drilling engineer. The fluid composition and pressures are evaluated based on steady-state values, and the choke is adjusted accordingly. Recently, new procedures for adjusting the flow rates and choke opening during pipe connections during under-balanced drilling operations are suggested [5]. These procedures are based on calculation results from a dynamic two-phase flow model. The model is used to evaluate the well conditions and to plan the pipe connection prior to the actual action. Difficulties might arise if the pipe connection procedure is not performing as planned.

A different approach for solving the pipe connection pressure fluctuations is described in [6], where a hydro-mechanical choke is adjusting the opening of the choke automatically according to the choke differential pressure. This has some impact on the bottom-hole pressure. The set-point of the choke differential pressure is adjusted manually. In [7] another mechanical system which is using various seals and valves has been developed to be able to continue to pump the drill fluids even during the pipe connections. The mechanical system increases the complexity of the drilling system, and may add additional cost.

Under-balanced drilling has some similarities with gas-lifted production wells, and a control system for gas-lifted production wells utilizing a low-order model is described in [8]. The model is used to give an estimate of the bottom-hole pressure, and a PI-control algorithm is applied. A similar approach could be used in wells that are drilled at under-balanced conditions. Another approach is suggested by [9], where an automatic control system is proposed for operating the choke on-line during the pipe connection. The suggested control system is utilizing a nonlinear model predictive control scheme combined with first-principles model. The model is used for on-line evaluation of the well pressures and fluid flows, and predictions are made to find the most optimal choke opening during pipe connections.

In this paper three different control methods will be evaluated. The first method is an open loop control procedure, where the choke opening is significantly reduced while the circulation is stopped. This is the most common method used in the drilling industry today. The next method is to use a standard PI-control algorithm which is tuned using a simplified low-order model of the well system. The third method is a nonlinear model predictive control scheme, using a detailed model based on a spatial discretization of the well system.

3.1. Planning choke opening set-points

During the planning phase prior to the actual drilling of the well, a dynamic model can be used to evaluate the effects of the pipe connections and an appropriate choke opening can be found. Typically, the choke opening is reduced while the drill fluid circulation pumps are stopped. How much the choke is closed is based on planning results and experience of the operator [5]. A value such as 10% of the choke valve opening during pipe connections relative to the choke valve opening during drilling might in some cases be a useful selection.

3.2. Simple feedback PI control

Fig. 2 shows a simple feedback PI control including feed-forward compensation of known disturbances (see e.g. [13]). The control algorithm can be described as

$$u = u_0 + K_p e + \frac{K_p}{T_i} \int_0^t e \, d\tau + K_f v \quad (1)$$

$$e = r - y$$

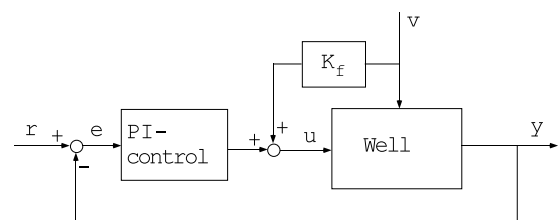

Fig. 2. Schematic of feedback PI control including feed-forward compensation of disturbance.

where u is the choke opening, u_0 is the choke opening during normal drilling operations, v is known disturbances, K_p is the proportional relation between the pressure difference and the choke opening, T_i is the integral time for the accumulated differences, K_f is the proportional relation between pump pressure and choke opening, and e is the difference between r , the reference pressure value, and y , the actual pressure value in the well.

The control scheme parameters K_p , T_i and K_f can be found by performing the Ziegler–Nichols closed-loop method (see e.g. [13]) using real experiments or using a model of the process. However, the PI-control method requires re-tuning in the event of changes in the nominal pump flow rates and the reservoir conditions.

3.3. Nonlinear model predictive control

As an alternative to the PI-control scheme, a nonlinear model predictive control (NMPC) scheme is evaluated. Fig. 3 shows a schematic of a well system with the proposed NMPC control scheme.

The model used for prediction is a numerical implementation of the partial differential equations of the well system. The model is used to predict the state of the process at certain time steps ahead in time (see e.g. [14]). The notation $r(k+i|k)$ is used to describe a reference value r valid at the future time steps $k+i$ evaluated at the current time step k . The future time steps is denoted $k+i$, where k is the current time step, and $i = [1, 2, \dots, H_p]$, where H_p is the prediction horizon. We chose the reference trajectory r at the time step $t = k$ as

$$r(k+i|k) = y_{\text{ref}} - [(y_{\text{ref}} - \tilde{y}(k))e^{(-iT_s/T_{\text{ref}})}], \quad i = 1, 2, \dots, H_p \quad (2)$$

where y_{ref} is the reference pressure, $\tilde{y}(k)$ is the modelled pressure at the current time step, T_s is the time step duration, and T_{ref} is the time response. The state model f_P and sensor model g_P is used to predict the future pressures of the well, and the input $\hat{u}(k+i|k)$ is applied over the horizon $i = [1, 2, \dots, H_p]$,

$$\hat{x}(k+i|k) = f_P[\hat{x}(k+i-1|k), \hat{u}(k+i|k), \hat{u}(k+i-1|k), \dots, \hat{u}(k|k)] \quad (3)$$

$$\hat{y}(k+i|k) = h_P[\hat{x}(k+i|k)] \quad (4)$$

where f_P and h_P is calculated using the detailed model described in Section 4.3. To find the optimal input trajectory, $\hat{u}_{\text{opt}}(k+i|k)$, a least squares cost criterion is defined by

$$Q(r, \hat{y}) = \sum_{i \in P} [r(k+i|k) - \hat{y}(k+i|k)]^2 \quad (5)$$

where P is the set of coincidence points where the reference trajectory and the predicted outputs should match. To minimize (5) the Levenberg–Marquardt algorithm is used (see e.g. [15,16]). The constraints of the system apply both to u and y . The choke opening u has fully open u_{max} and fully closed u_{min} as the upper and lower bounds. The annulus bottom hole pressure y has reservoir pore pressure y_{max} and reservoir collapse pressure y_{min} as the upper and lower bounds.

The model predictive control scheme is dependent on the flow model for calculating the choke opening. Un-modelled effects might cause errors in predicting the correct pressures, which can result in a deviation from the reference pressure. A detailed model will give better prediction of the future pressure.

4. Modelling

Modelling is used to improve the control system's ability to follow the given reference values. Models for control purposes are often being linearized around the typical operating conditions of the process. In two-phase fluid flow systems, the interaction between the gas and the liquid are causing nonlinear behaviour. In addition, the actuators and disturbances caused by the pumps might easily bring the fluid flow outside the validity envelope of a linearized model. The model should also be able to describe the flow fluctuation during pipe connections. The main purpose for modelling the drilling process is to be able to calculate the bottom-hole pressure sufficiently accurate. Since the bottom-hole pressure is affected by the fluid flow, a nonlinear modelling strategy is selected.

4.1. Model usage

The usage of the model differs, depending on type of control algorithm applied. The model might be used as a simulation tool where the parameters of the control algorithm are tested and defined. In addition, the models can be used in an observer algorithm for estimating the state and parameters in the process in case of noisy measurements. The model might also be used for predicting future process behaviour, and selecting future process set-points in a model predictive control scheme.

Several methods for modelling the dynamic two-phase flow in the well can be used. In this paper two methods are presented. The first method is to focus on the major effects in the well, and look at certain phenomena [17]. This type of model has only a few states, such as the flow rate of the fluid component. This low-order model is relatively fast to develop, and does not require the calculation resources needed in a more detailed, higher-order state model. The second approach is to model the various effects more detailed, and use spatial discretization of

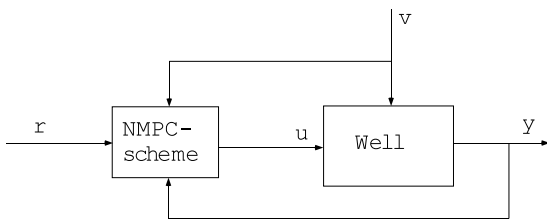

Fig. 3. Schematic of a well system with an NMPC scheme for well pressure control.

the well system [18]. This type of model is able to describe the flow variations in the well more detailed than the low-order model, but is more difficult and time-consuming to develop.

Both the low-order model and the detailed model can be used for controlling the flow using the control schemes described in Section 3. In this paper, the usage of the low-order model is limited to defining the control parameters in a PI-control scheme. At a later stage, the model might also be used for state and parameter estimation in an observer scheme, as well as a part of a model predictive control scheme.

The use of the detailed model for control purposes, is to use the model as a basis in the model predictive control scheme described in Section 3.3. At a later stage, the detailed model could be used for defining the linear control parameters K_p , T_i and K_f in the PI-control scheme with feed-forward compensation of process disturbances.

This paper focuses on demonstrating the use of two different models and two different automatic control algorithms. We have in this paper chosen to combine the less complex control algorithm with the less complex model, and the more complex control algorithm with the more complex model. For future evaluations, other combination of control algorithm and models might be considered.

4.2. Low order model

Prior to extending the well into the reservoir formation, the actual behaviour of the fluid flow in the well can be found by performing simple experiments such as starting and stopping the circulation fluid flow. When entering the reservoir, this type of experiments might damage the near-well reservoir drainage properties. Due to this, a low-order model incorporating the reservoir dynamics could be utilized, focusing on the fluid flow behaviour affecting the bottom-hole pressure. The model of the two-phase flow in the well can be tuned by using the data from the experiments gathered prior to drilling into the reservoir formation.

A low-order modelling approach similar to the two-phase flow model found in [19] is used, where the model is based on the mass balance in a production well. In this paper the model is expanded to also include the average mixture mass rates in the drill string and the annulus.

4.2.1. Calculation scheme

When setting up the low-order model, an explicit calculation scheme is defined by

$$\frac{d}{dt}\vec{x} = f_L(\vec{x}, \vec{u}, \vec{v}), \quad \vec{x}_0 = \mathbf{0} \quad (6)$$

$$\vec{y} = h_L(\vec{x}, \vec{u}, \vec{v}) \quad (7)$$

where \vec{x} is the state vector, \vec{u} is the control variable vector, \vec{v} is the disturbance vector and \vec{y} is the sensor vector. f_L is the low-order state function, and h_L is the low order sensor

function. A total of seven system states have been used to describe the well system

$$\vec{x} = [m_{g,d}, m_{l,d}, m_{g,a}, m_{l,a}, w_{mix,d}, w_{mix,a}, L], \quad (8)$$

where the subscript d relates to the drill string, subscript a relates to the annulus, subscript g relates to gas, subscript l relates to liquid and subscript mix relates to the fluid mixture. Then, $m_{g,d}$ is the gas mass in the drill string, $m_{l,d}$ is the liquid mass in the drill string, $m_{g,a}$ is the gas mass in the annulus, $m_{l,a}$ is the liquid mass in the annulus, $w_{mix,d}$ is the mass flow rate in the drill string, $w_{mix,a}$ is the mass flow rate in the annulus and L is the length of the well. The measurement vector is

$$\vec{y} = [p_{a,bot}] \quad (9)$$

where $p_{a,bot}$ is the bottom-hole pressure in the annulus. The control vector is defined to be

$$\vec{u} = [z_{choke}] \quad (10)$$

where z_{choke} is the choke opening parameter. The gas inflow $w_{g,pump}$ and liquid inflow $w_{l,pump}$ from the pumps and the drilling rate v_d are treated as a disturbance of the system, giving the disturbance vector

$$\vec{v} = [w_{g,pump}, w_{l,pump}, v_d] \quad (11)$$

To solve this explicit scheme, the state function f_L and sensor function h_L has to be found using the balance equations and the closure relations of the parameters. The calculation frequency for the low order model is one iteration per second.

4.2.2. Balance equations

This simplified oil well system is modelled using a combination of the mass balance and the pressure balance of the well system. Fig. 4 is a schematic of the well system, showing the mass balance of the drill string and the mass balance of the annulus. The mass balance is divided into

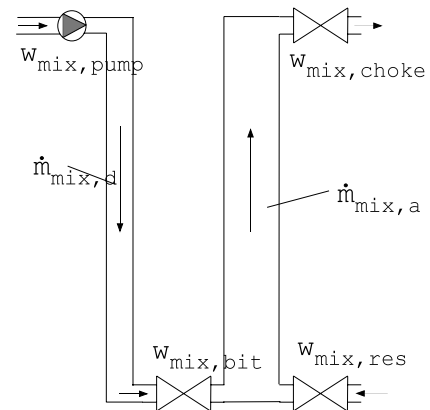

Fig. 4. Mass balance of simplified oil well geometry. The change of mass in the drill string \dot{m}_d is a function of the mixture mass flow rate into the drill string w_{pump} and the mixture mass flow rate out of the drill string w_{bit} . The change of mass in the annulus \dot{m}_a is a function of the mixture mass flow rate into the annulus from the bit w_{bit} and from the reservoir w_{res} and the mixture mass flow rate out of the annulus w_{choke} .

two systems, the drill string and the annulus between the wall of the well and the drill string. The mass balances for the fluids in the drill string are given by

$$\frac{d}{dt} m_{g,d} = w_{g,pump} - w_{g,bit} \quad (12)$$

$$m_{g,d}(0) = m_{0,g,d}$$

$$\frac{d}{dt} m_{l,d} = w_{l,pump} - w_{l,bit} \quad (13)$$

$$m_{l,d}(0) = m_{0,l,d}$$

where $w_{,bit}$ is the mass flow of gas and liquid at the drill bit, respectively. The mass balance equations for the annulus are given by

$$\frac{d}{dt} m_{g,a} = w_{g,bit} + w_{g,res} - w_{g,choke} \quad (14)$$

$$m_{g,a}(0) = m_{0,g,a}$$

$$\frac{d}{dt} m_{l,a} = w_{l,bit} + w_{l,res} - w_{l,choke} \quad (15)$$

$$m_{l,a}(0) = m_{0,l,a}$$

where $w_{,res}$ is the mass flow of gas or liquid at the reservoir, and $w_{,choke}$ is the mass flow of gas or liquid at the exiting choke valve.

In addition to the mass balance, the pressure balance in the system is important due to the frictional pressure induced by the velocity of the liquid. When gas is injected into the well, the gas volume is changed due to gas compression. The hydrostatic pressure also varies due to variation in the mixture density. The fluid flows through the restriction at the drill bit at the bottom of the well and at the choke valve at the top of the well. In Fig. 5 the various pressures are indicated.

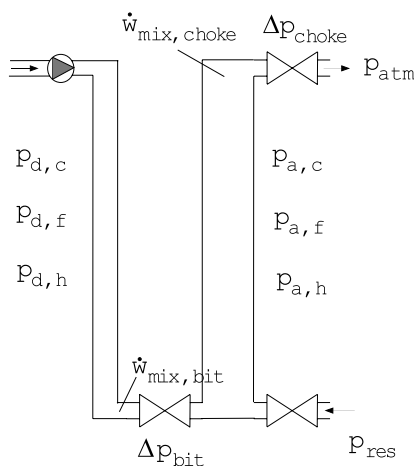

Fig. 5. Pressure balance of simplified oil well geometry. The change of mass rate at the drill bit $\dot{w}_{mix,bit}$ is dependent of the compression pressures in the drill string $p_{d,c}$ and annulus $p_{a,c}$, the hydrostatic pressures in the drill string $p_{d,h}$ and annulus $p_{a,h}$, the friction pressure losses in the drillstring $p_{d,f}$ and annulus $p_{a,f}$, and the differential pressure across the drill bit Δp_{bit} . The change of mass rate at the choke valve $\dot{w}_{mix,choke}$ is dependent of the compression pressures in the annulus $p_{a,c}$, the differential pressure across the drill bit Δp_{bit} , and the atmospheric pressure p_{atm} .

The pressure balance is evaluated at two points and given as mass acceleration at the bottom of the drill string and as mass acceleration at the top of the annulus. The pressure balance equations are given by

$$\frac{d}{dt} w_{mix,bit} = \frac{1}{A_d} (p_{d,c} + p_{d,h} - p_{d,f} - \Delta p_{bit} - p_{a,c} - p_{a,h} - p_{a,f}) \quad (16)$$

$$w_{mix,bit}(0) = 0$$

$$\frac{d}{dt} w_{mix,choke} = \frac{1}{A_a} (p_{a,c} - \Delta p_{choke} - p_{atm}) \quad (17)$$

$$w_{mix,choke}(0) = 0$$

where A is the cross sectional area of the drill string or annulus and $p_{,}$ is pressure. The subscript c is the compression pressure, subscript h is the hydrostatic pressure and subscript f is the frictional pressure. Δp_{bit} is the pressure loss over the bit, and Δp_{choke} is the pressure loss over the choke. $w_{mix,bit}$ is the mixture flow velocity before the drill bit flow restriction and $w_{mix,choke}$ is the mixture flow velocity before the choke valve. p_{atm} is the atmospheric pressure.

When drilling the oil well, the length of the well is increasing according to the drilling rate. The length of the well has substantial influence on the well pressure. The well length L is chosen as a state in the dynamic systems, given by

$$\frac{d}{dt} L = v_d, \quad L(0) = L_0 \quad (18)$$

where v_d is the drilling rate, and L_0 is the initial well length.

4.2.3. Closure relations

In addition to the balance equations (12)–(18), closure relations have to be defined to be able to solve Eqs. (8) and (9). The closure relations used in the model are based on equations from [19–21]. When modelling the oil well using the drill string and annulus as two compartments, it is based on the assumption that the gas is evenly distributed within the liquid. The density of the mixture of gas and liquid in each compartment, ρ_{mix} , is given by

$$\rho_{mix} = \frac{m_g + m_l}{V} \quad (19)$$

where m_g is the gas mass, m_l is the liquid mass, and V is the volume. The additional density due to particles from the drilling process is not taken into account. The void fraction of liquid in the mixture α_m is given as

$$\alpha_m = \frac{\rho_{mix}}{\rho_l} \quad (20)$$

where ρ_l is the density of the liquid. The void fraction α_m should then be used to calculate the gas mass rate and liquid mass rate. However, when the velocity is reduced, the friction pressure loss is reduced and the gas is expanding. This effect causes the liquid to flow out of the well and the gas to be contained in the well. The gas mass rate at low mixture velocities should then be modified to

$$\alpha_e = \alpha_m + \beta(1 - \alpha_m) \left(\frac{1}{1 + e^{-n(v_t - v_m)}} \right) \quad (21)$$

where β is a factor for gas entrainment at low velocities, n corresponds to the slope of the gas entrainment, v_t is a constant referring to the mixture velocity at the transition between full gas entrainment and minimum gas entrainment and v_m is the current velocity of the mixture. To calculate the mass flow rates of gas and liquid, the liquid void fraction in (21) is used. For gas and liquid mass rate through the bit we have

$$w_{g,\text{bit}} = (1 - \alpha_e)w_{\text{mix},\text{bit}} \quad (22)$$

$$w_{l,\text{bit}} = \alpha_e w_{\text{mix},\text{bit}} \quad (23)$$

For gas and liquid mass rate through the choke valve we have

$$w_{g,\text{choke}} = (1 - \alpha_e)w_{\text{mix},\text{choke}} \quad (24)$$

$$w_{l,\text{choke}} = \alpha_e w_{\text{mix},\text{choke}} \quad (25)$$

To model the flow from the reservoir into the well, a simple relation called the productivity index PI can be used, which is a constant scalar defining the mass flow rate based on the pressure difference between the reservoir and the well. The annulus bottom hole pressure $p_{a,\text{bot}}$ is calculated using

$$p_{a,\text{bot}} = p_{a,c} + p_{a,h} + p_{a,f} + \Delta p_{\text{choke}} + p_{\text{atm}} \quad (26)$$

The mass rate from the reservoir w_{res} can then be calculated using the relation given by

$$w_{\text{res}} = \text{PI}(p_{a,\text{bot}} - p_{\text{res}}) \quad (27)$$

where p_{res} is the constant pore pressure in the reservoir. The void fraction α_{res} is the density of the fluid mixture in the reservoir relative to the liquid density in the reservoir. The resulting liquid mass rate $w_{l,\text{res}}$ and the gas mass rate $w_{g,\text{res}}$ at the reservoir are found using

$$w_{g,\text{res}} = (1 - \alpha_{\text{res}})w_{\text{res}} \quad (28)$$

$$w_{l,\text{res}} = \alpha_{\text{res}} w_{\text{res}} \quad (29)$$

The gas is compressible and the gas volume is dependent on the pressure conditions. The relation between the gas mass and the compression pressure is based on the perfect gas law in a pressurized tank where the pressure $p_{c,\text{tank}}$ in the tank is calculated using

$$p_{c,\text{tank}} = \rho_g \frac{A}{M_{\text{gas}}} T \quad (30)$$

where ρ_g is the density of the gas, A is the gas constant, M_{gas} is the molecular weight of the gas, and T is the average temperature. In the model, the mixture of the gas and liquid in the well cause an average compression pressure along the depth of the well. Hence, we model the compression pressure $p_{,c}$ in the drill string and annulus as

$$p_{d,c} = p_{\text{atm}} + \lambda_d \left(\rho_g \frac{A}{M_{\text{gas}}} T - p_{\text{atm}} \right) \quad (31)$$

$$p_{a,c} = p_{\text{atm}} + \lambda_a \left(\rho_g \frac{A}{M_{\text{gas}}} T - p_{\text{atm}} \right) \quad (32)$$

where p_{atm} is the atmospheric pressure, λ is a compression factor.

The hydrostatic pressures in the well is calculated using the relation between the mixture density in the drill string or annulus $\rho_{, \text{mix}}$ which is calculated using (19), gravity g and well depth L from (18),

$$p_{d,h} = \rho_{d,\text{mix}} g L \quad (33)$$

$$p_{a,h} = \rho_{a,\text{mix}} g L \quad (34)$$

The frictional pressure loss is caused by the friction between the fluid and the walls of the well and the drill string. The friction pressure loss $p_{,f}$ is calculated using

$$p_{d,f} = \frac{\rho_{d,\text{mix}} f_d L v_{d,\text{mix}}^2}{2D_d} \quad (35)$$

$$p_{a,f} = \frac{\rho_{a,\text{mix}} f_a L v_{a,\text{mix}}^2}{2D_a} \quad (36)$$

where $v_{, \text{mix}}$ is the fluid mixture velocity and D is the hydraulic diameter. The friction factor f is calculated using the Haaland equation, which is defined by

$$\frac{1}{\sqrt{f}} \approx -1.8 \log_{10} \left[\frac{6.9}{Re} + \left(\frac{\epsilon/D}{3.7} \right)^{1.11} \right] \quad (37)$$

where ϵ/D is the relative roughness of the pipe. The Reynolds number Re is calculated using

$$Re = \frac{\rho_{\text{mix}} v_{\text{mix}} D}{\mu} \quad (38)$$

where μ is the viscosity of the fluid.

The mass rate, w , through a restriction is given by the simple valve equation

$$w = Cz \sqrt{\rho_{\text{mix}} \Delta p} \quad (39)$$

where C is the discharge coefficient of the restriction, z is the restriction area, and Δp is the differential pressure across the restriction. This relation is used both at the drill bit and the choke valve. Using (39), the differential pressure across the drill bit and the choke valve are modelled using

$$\Delta p_{\text{bit}} = \frac{1}{\rho_{d,\text{mix}}} \left(\frac{w_{\text{mix},\text{bit}}}{C_{\text{bit}} z_{\text{bit}}} \right)^2 \quad (40)$$

$$\Delta p_{\text{choke}} = \frac{1}{\rho_{a,\text{mix}}} \left(\frac{w_{\text{mix},\text{choke}}}{C_{\text{choke}} z_{\text{choke}}} \right)^2 \quad (41)$$

The calculation scheme found in (6)–(11) are calculated using the balance equations (12)–(18). The mixture mass flow rates are separated in gas mass rate and liquid flow rate using (22)–(25) and (28)–(29). The pressures are found using (31)–(36) and (40)–(41).

Several of the parameters in this model are not easily found, and the model parameters have to be adjusted such that the model describes the well system more accurate. The need for experimental tuning of system parameters such as the fluid mixture compression factor λ in the drill string and annulus, the bit and choke valve discharge val-

ues C . in addition to the gas entrainment factors β , n and v_t is therefore required for each specific case.

4.3. Detailed model

The modelling effort in Section 4.2 are based on some simplifications that cause the model to be inaccurate. The assumption of having a uniform distribution on liquid and gas in the whole well does not hold in all cases. Dividing the well system in only two compartments gives a very rough approximation of the fluid flow. A spatial discretization of the fluid flow is needed to give a more detailed model, and such a two-phase model using a numerical scheme has been developed over several years [22,23], and verified with several experimental tests [24,25]. The well inflow from the reservoir should also be modelled more detailed using the dynamics defined in the well pressure test at constant rate given in [26]. The reservoir model and the well model are combined as in [27]. In this section a more detailed model is developed, and the well system is divided into several boxes in both the drill string and the annulus of the well, and the balance equations and closure relations are defined for each of them. Fig. 6 shows how the spatial discretization is done.

4.3.1. Calculation scheme

The well and reservoir system can be represented by the numerical scheme

$$\vec{x}(k) = f_D[\vec{x}(k-1), \tilde{u}(k-1), \tilde{v}(k-1)] \quad (42)$$

$$\vec{y}(k) = h_D[\vec{x}(k)] \quad (43)$$

where f_D is the detailed functions for calculating the current state vector $\vec{x}(k)$ based on the previous state vector $\vec{x}(k-1)$, the choke setting \tilde{u} and the pump rates \tilde{v} . h_D is the function for calculating the sensor values \vec{y} based on the current state vector. The calculation frequency for the detailed model is one iteration per second.

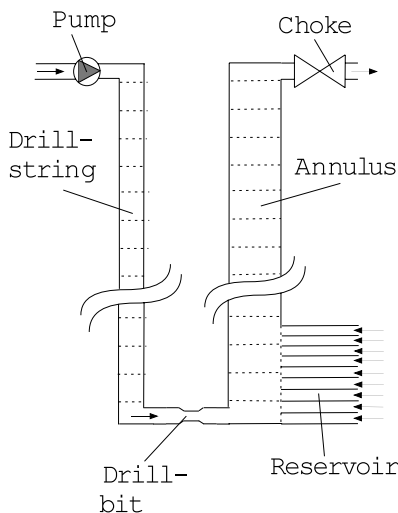

Fig. 6. Spatial discretization of the well and reservoir interaction.

4.3.2. Balance equations

In the conservation equations for the mass balances for gas and liquid, the mass transfer between the phases is neglected. The mass balance for each phase in each of the boxes is

$$\frac{\partial}{\partial t}(\rho_g \alpha_g) + \frac{\partial}{\partial z}(\rho_g \alpha_g v_g) = m_g \quad (44)$$

$$\frac{\partial}{\partial t}(\rho_l \alpha_l) + \frac{\partial}{\partial z}(\rho_l \alpha_l v_l) = m_l \quad (45)$$

where m is the mass boundary condition, and these boundary conditions are zero except for the boxes which interface with the pump, the reservoir and the choke. The phase velocity is denoted v . and α is the void fraction. The momentum equations for each phase are added together, which results in the drift-flux formulation. The drift-flux formulation is a simplified momentum balance equation for the mixture, given by

$$\begin{aligned} \frac{\partial}{\partial t}(\rho_l \alpha_l v_l + \rho_g \alpha_g v_g) + \frac{\partial}{\partial L}(\rho_l \alpha_l v_l^2 + \rho_g \alpha_g v_g^2 + p) \\ = - \left(\frac{dp}{dL} \right)_F - (\rho_l \alpha_l + \rho_g \alpha_g)g \end{aligned} \quad (46)$$

where p is the pressure.

4.3.3. Closure relations

To be able to solve Eqs. (44)–(46), the closure relations are presented. The flow in the drill string calculated using a slip relation between the phases, where the gas velocity v_g is given by

$$v_g = C_1(\alpha_g v_g + \alpha_l v_l) + C_2 \quad (47)$$

where C_1 and C_2 is constants and in this case defined to be 1 and 0 respectively. The friction pressure loss is calculated using the relation

$$\left(\frac{dp}{dL} \right)_F = \frac{2f}{D} \rho_{\text{mix}} v_{\text{mix}} |v_{\text{mix}}| \quad (48)$$

where f is flow dependent friction factor, D is the pipe diameter and v_{mix} is the fluid mixture velocity. The flow in the annulus is calculated using

$$[\alpha_g, v_g, v_l, \Delta p] = M(d_1, d_2, \rho_l, \rho_g, \tau, \mu_l, \mu_g, w_{\text{mix}}) \quad (49)$$

where M is a nonlinear relation which is used for calculating the pressures and velocities. d_1 is the outer drill string diameter, d_2 is the well diameter and τ is the interfacial tension.

The flow from the reservoir during under-balanced drilling can be modelled based on the analytical solution of the constant terminal rate given as

$$p_a = p_{\text{res}} - \frac{q\mu}{4\pi Kh} \left(2S + \ln \left(\frac{4Kt}{e^{\gamma} \phi \mu c r_w^2} \right) \right) \quad (50)$$

where p_a is the annulus pressure, p_{res} is the initial reservoir pressure, q is the volume flow rate from the reservoir, K is the permeability of the reservoir, S is the skin factor, h is the height of the well section that has contact with the res-

ervoir, t is the time since the reservoir section first were influenced by the well pressure, ϕ is the porosity of the reservoir, c is the compressibility of the reservoir fluid, r_w is the well radius and γ is Euler's constant, $\gamma = 0.57721\dots$

To model the flow from a reservoir, the interface between the reservoir and well can be discretized into j small segments with a length, h_j . We have chosen $h_j = 0.25$ meters. In addition, the reservoir might consist of i zones, where the K_i and/or $p_{res,i}$ is varying. Using (50), the flow $q(t)$ from a reservoir segment consisting of i zones with varying permeability, can be modelled by

$$q_{i,j}(t_{i,j}) = \frac{4\pi K_i h_j (p_{res} - p_a)}{\mu \left(2S + \ln \left(\frac{4K_i t_{i,j}}{e^{\gamma} \phi \mu c r_w^2} \right) \right)} \quad (51)$$

This detailed model described in this section can be calculated more than 100 times faster than real-time, and hence the model can be used in a real-time control algorithm, such as in a predictive control scheme.

5. Case description and model comparison

The three control schemes, manual, PI-control and predictive control, are evaluated using a test case simulation. The control schemes should be able to maintain the bottom-hole pressure prior, during and after the pipe connection procedure. To be able to measure the bottom hole pressure both during drilling and during the pipe connection procedure, it is assumed that the a electro-magnet telemetry system is used in the current case.

5.1. Case description

The simulated test case is based on a well that is 2000 m deep, and the well is drilled 100 m into a reservoir. Well data and reservoir data is given in Table 1. Initially the fluid flow in the well is in a steady-state condition, and the drilling is initiated. After 10 min, the first pipe connection procedure is started. The rotation of the drill string and the circulation of fluids are stopped for 10 min. Then the circulation pumps are re-started, and the drill string starts to rotate. The second pipe connection procedure is initiated after 52 min, and is completed after 64 min.

Table 1
Well and reservoir data

Parameter	Value
Initial well length, $h_{w,i}$	2000 m
Liquid circulation rate, w_l	24 kg/s
Gas circulation rate, w_g	2 kg/s
Reservoir height, h_r	100 m
Drilling rate, v_d	0.01 m/s
Reservoir permeability, K	200 mD
Reservoir pore pressure, p_r	215 bar
Well set-point pressure, p_r	205 bar
Reservoir collapse pressure, p_r	185 bar
Reservoir porosity, ϕ	0.18
Skin factor, S	0.013

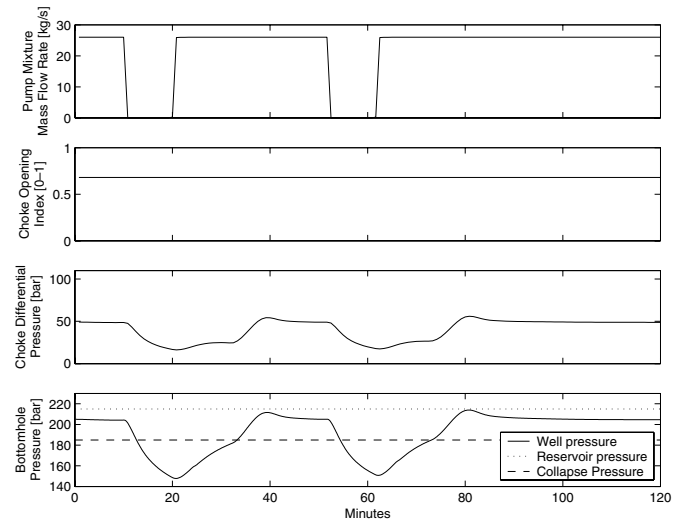

Fig. 7. Simulation using detailed model of drilling case with no control actions.

Fig. 7 shows the simulation of the case using the detailed model. In this simulation, no adjustments of the choke opening are performed.

During each pipe connection, the bottom hole pressure is falling from about 205 bar and down towards 145 bar. As the reservoir collapse pressure is at 185 bar, actions must be taken to avoid that the pressure is falling below this limit. After the pipe connection procedure is completed, the pressure slowly increases towards the 205 bar set-point. However, the pressure increases above the set-point, due to a slug flow regime in the well. The slug flow is caused by a segregation of the gas-liquid mixture during the pipe connection.

5.2. Comparison of low-order model and detailed model

The data from the simulation of the detailed model is used to tune the low-dimensional state model. The fluid mass rates into the drill string are the same in the low-order model as the detailed model. During pumping the liquid rate is 24 kg/s and gas rate is 2 kg/s, and during pipe connections both rates are set to 0 kg/s.

When comparing the pressures between the low-order model and detailed mechanistic model, the low-order model has to be adjusted with respect to the friction pressure losses in the drill string and the annulus, in addition to the compression factor of the gas and liquid mixture. In Fig. 8 the pressures at top and bottom in both the drill string and annulus are compared. As can be seen, there is a good match between the modelled pressures in the drill string, both during the transients at pipe connections and in the stationary periods. However, the annulus pressures calculated using the low-order model deviate from the annulus pressures using the detailed model. The deviation between the models might be due to the system simplifications made when designing the low-order model. However,

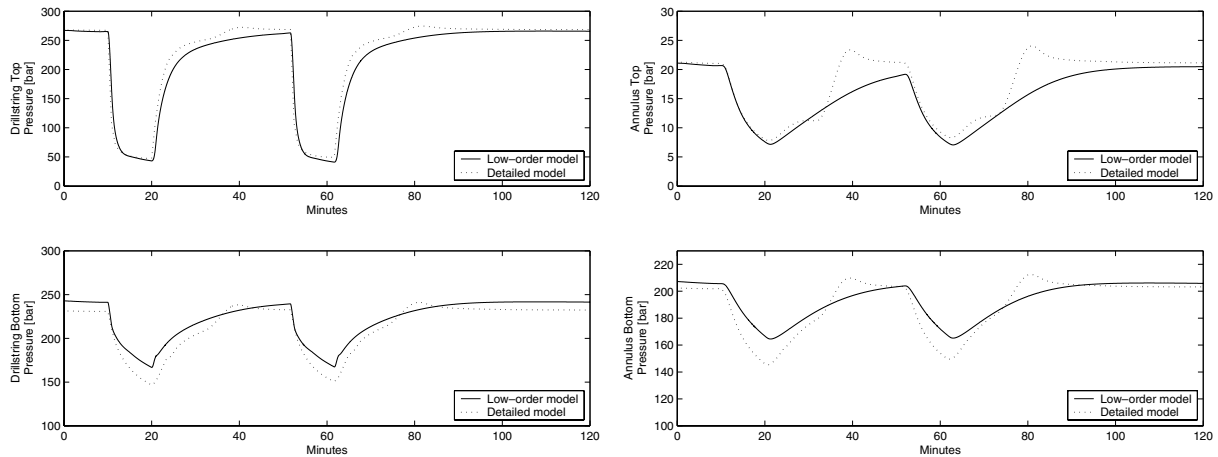

Fig. 8. Pressures at top and bottom of the drill string and annulus calculated using the low-order model and the detailed model.

the low-order model gives relatively accurate values for the flow rates and pressures in the well during drilling, and the low-order model might be used for designing the control scheme for the drilling process.

6. Control scheme tuning

The parameters in both the PI-control scheme and the NMPC scheme must be selected to achieve a bottom-hole annulus pressure that follows the pressure reference during the whole drilling operation. The controller frequency for both the PI-control scheme and the model predictive control scheme is as low as 0.02 Hz, evaluating the bottom hole sensor and adjusting the choke valve once every 50 s.

6.1. PI-control scheme parameter selection

The low-order model is used to define the control parameters for the PI-control scheme with feed-forward compensation of the pump flow rate, as shown in Fig. 2. The method used for designing the parameters is the Ziegler–Nichols method for closed loops systems (see e.g. [13]). The feed-forward compensation are selected to be $K_f = 0.6$. The closed loop-system are brought to a critical condition where the bottom hole annulus pressure is marginally stable by slowly increasing the K_p parameter until the marginally stable conditions are found. Using simulations, the well system is marginally stable when the PI-control parameters is $K_{p,critical} = 285$ and $T_i = \infty$ in the simulations. The resulting fluctuations are shown in Fig. 9. From these simulations, the critical time period is found, $T_{critical} = 1.27$ min.

Based on the Ziegler–Nichols rules, the control parameters can be calculated. According to these rules, the proportional gain should be $K_p = \frac{K_{p,critical}}{2.2} = 128.25$ and the integral time constant should be $T_i = \frac{T_{critical}}{1.2} = 1.06$ minutes. The controller is updated using these parameters and the closed loop well system is simulated using the low-order model. The results are shown in Fig. 10. As can be seen, the con-

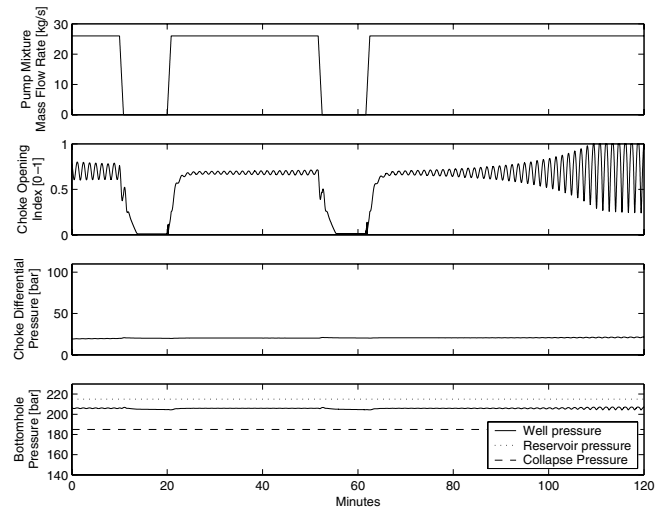

Fig. 9. Well data using PI control with critical parameters.

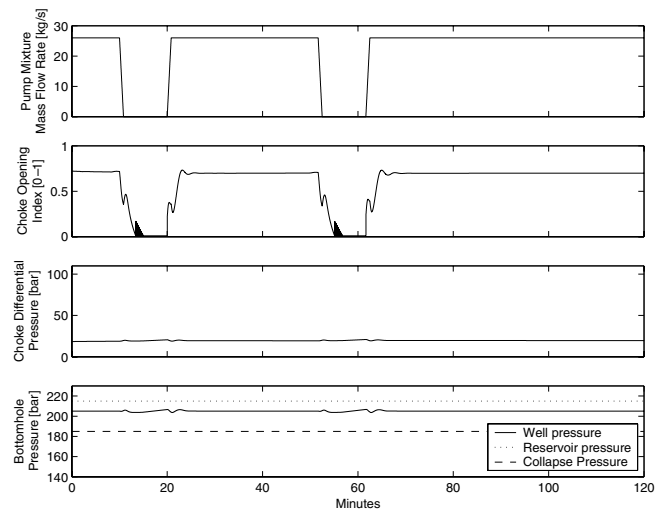

Fig. 10. Well data using PI control with adjusted parameters.

rol settings keep the bottom hole pressure well within the required margins.

6.2. NMPC scheme parameter selection

In oil well drilling the flow rate is slow compared to the length of the well, and the time between each evaluation step T_s is defined to be 50 s, and the time constant of the reference trajectory T_{ref} is set to be $2T_s$. The prediction horizon H_p is set to be 8, which gives a prediction of 400 s. This prediction time is sufficient to evaluate the behaviour of the well, and to verify that it is possible to bring the well to the reference pressure value. The future coincidence points P , is set to the same points as the prediction horizon, giving $P = H_p$. The constraints for the choke openings are $u_{max} = z_{max}$ where z_{max} is the maximum choke opening available, and $u_{min} = z_{min}$ where z_{min} is the minimum choke opening available. The constraints on the bottom hole pressure is y_{min} is set equal to the collapse pressure of the well, and y_{max} is set equal to the reservoir pore pressure. The bottom hole pressure reference, y_{ref} is set to the well set-point pressure as defined in Table 1.

7. Control scheme evaluation

To evaluate the three described control schemes, each of the schemes has been implemented and simulated using the detailed mechanistic model. The comparison of the three control schemes is based on the test case in Section 5.1 where the two pipe connections are performed. The performance of the controllers using the test case is not sufficient argument for ranging the three control schemes, but gives an indication for which controller scheme that could be utilized for further experimentation and utilization. First the manual control scheme is used, then the PI-control scheme is tested, and finally the NMPC-scheme is evaluated.

7.1. Preset manual control

Fig. 11 shows the results when the manual control scheme is used. The choke opening during pipe connection is set to 10% opening relative to the choke opening during drilling. This choke opening is based on the operator's experience. As can be seen, this manual procedure is working quite acceptable, but it can be observed that the bottom-hole pressure is increasing above reservoir pore pressure just after the pipe connection is finished.

7.2. PI-control scheme

Fig. 12 shows the results when the PI-control scheme is used. As can be seen, the fluctuations in the bottom-hole pressure are a bit higher relative to the fluctuations in Fig. 10. However, when comparing with the case where the choke valve is manually controlled, there is a significant improvement. The bottom-hole pressure is kept within the margins during the whole operation.

If the standard flow rates during drilling are changed substantially, then the controller cause the choke valve to fluctuate more as can be seen in Fig. 13. The controller

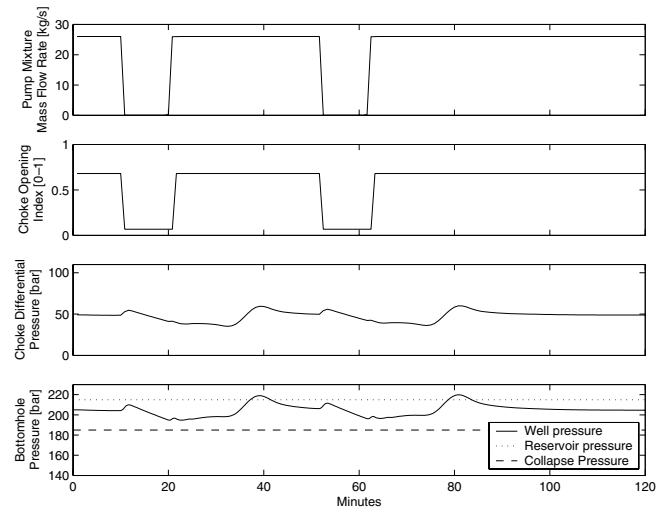

Fig. 11. Simulating manual control with detailed model.

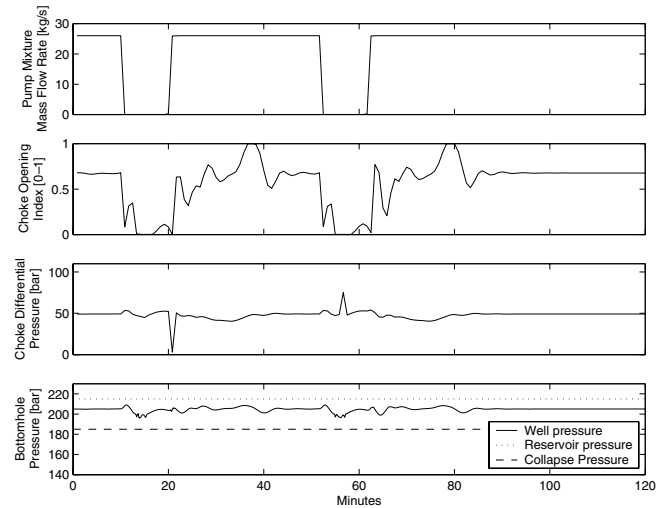

Fig. 12. Simulating PI-control scheme with detailed model using gas mass flow rate of 2 kg/s and liquid mass flow rate at 24 kg/s.

parameters should be re-designed for a better operation. The bottom-hole pressure is still within the limits, but the pressure fluctuates more.

7.3. NMPC scheme

Fig. 14 shows the results when the NMPC scheme is applied to the detailed model. To test the control scheme more realistically, a model error is introduced between the model used in the control scheme and the model used generating the measurements. The model error is that the measurements are using a reservoir with permeability of 200 mD, but the model is using a reservoir permeability of 300 mD. The bottom-hole annulus pressure is very stable, but with minor fluctuations during and after the pipe connections. The control scheme manages to keep the pressure almost constant and well within the limits. In Fig. 15 a

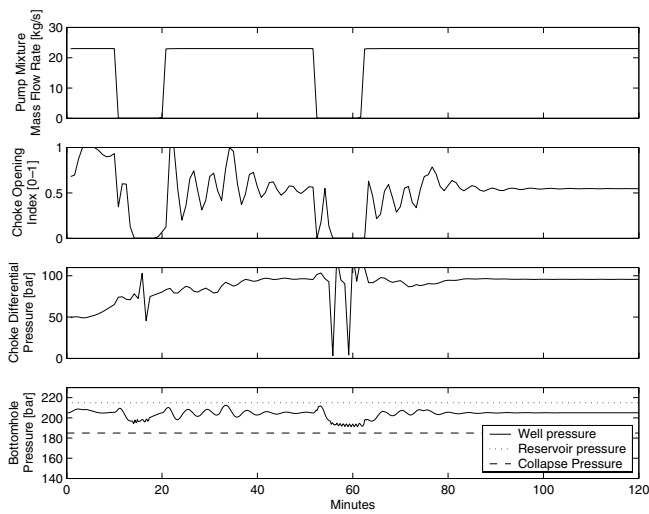

Fig. 13. Simulating PI-control scheme with detailed model when flow rates into the drill string are changed from 2 kg/s to 7 kg/s of gas and from 24 kg/s to 16 kg/s of liquid.

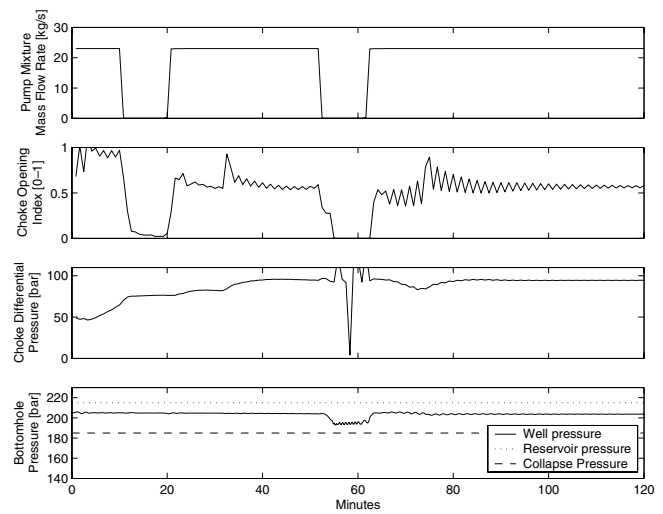

Fig. 15. Simulating NMPC scheme with detailed model when flow rates into the drill string are changed from 2 kg/s to 7 kg/s of gas and from 24 kg/s to 16 kg/s of liquid.

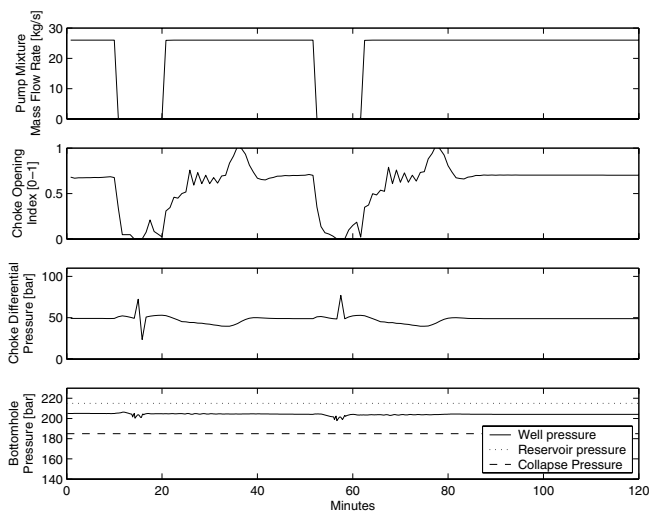

Fig. 14. Simulating NMPC scheme with detailed model using gas mass flow rate of 2 kg/s and liquid mass flow rate at 24 kg/s.

change in the mass rate into the drill string is introduced similar that was done using the PI scheme in Section 7.2. The model predictive control scheme is able to control the pressure within the limits, since the model is using the flow rates for predicting the pressure in the well.

7.4. Comparison of the control schemes

Comparing the results from the use of the various controllers to the test case gives only an indication of which control scheme that will perform best in a real application, and more detailed comparisons should be performed to evaluate the control schemes further in a follow-up study. However, the present results indicate that the manual control procedure reduces the fluctuations of the bottom-hole pressure, but fails to keep the pressure within the required

margins. Implementing automatic control of the pressure has a potential benefit for the under-balanced drilling process, when the pressure margins are narrow.

The PI-control scheme for adjusting the choke valve during oil well drilling is able to keep the bottom-hole pressure within the required margins, both during the drilling operations and during pipe connections procedures. By using a low-dimensional state model a set of efficient control parameters can be found.

However, if the circulation flow rates are being modified or the inflow from the reservoir is changing, then the simple low-order model might not describe the real process sufficiently accurately, and new control parameters might have to be found. The PI-control scheme requires measurements during the whole operation to keep the pressures within the specified range.

The NMPC scheme also keeps the bottom-hole pressure within the required margins during the whole operation, even if a substantial change in pump mass rates is introduced.

The NMPC scheme has a more detailed model, which should describe the actual behaviour of the well better. The NMPC scheme also includes calculation of reservoir inflow and density variations of the drilling fluid and might therefore be able to compensate for such changes in the control algorithm.

Regarding the computational burden of the two control schemes, the NMPC scheme uses a nonlinear optimization algorithm to search for the optimal future choke valve opening using a model. The prediction horizon used in the simulations is 8 time steps. The choke valve can be adjusted 6 times during the prediction calculation. To find the optimum choke valve positions, the prediction calculations typically have to be iterated 3–4 times for each of the valve adjustments. The NMPC control algorithm therefore requires typically 18–24 predictions for each time step.

Currently, the model uses about 1/100 of a time step to calculate one time step using a single, standard 2.8 GHz CPU. The algorithm is well suited for parallel calculations, and real time calculations can be performed using a dual CPU system if the predictions are longer than 3–4 time steps. As a comparison, the PI-control algorithm only uses a few arithmetic calculations for finding the next choke valve opening. Therefore the NMPC scheme requires more computational resources than the PI-control algorithm.

7.5. Future analysis and evaluations

Further development and analysis of the control schemes should be performed. A more detailed comparison between the PI-control scheme and the NMPC control scheme should be performed in a follow-up study. In addition, the use of NMPC incorporating the low-order model could be analysed and compared against the current results using NMPC with the detailed model. Another approach would be to tune the PI-control parameters using the detailed model. Stability evaluations using Lyapunov theory [28] and also analysis regarding use of output-feedback NMPC [29] should also be discussed further.

The current simulations have been performed using a model only. In a real application the model errors have to be taken into account, as well as measurement noise from the available sensors. The use of various types of Kalman-filters for large state models such as the ensemble Kalman filter [30] and the unscented Kalman filter [31] could be used for estimating some of the model states that are difficult to measure.

The safety aspect in implementing an automatic choke valve control should also be considered. If implemented correctly the automatic choke control would improve the safety of the drilling process. However, detailed experimental testing should be performed on test wells to ensure a fail-safe implementation in a real drilling application.

8. Conclusion

The present results indicate that active choke valve control using either a standard PI-control scheme or an NMPC scheme might be used for stabilizing the down-hole pressures.

An NMPC scheme using a dynamic mechanistic model for predicting the pressure in an oil well during drilling is developed. The future choke valve set points are found using a nonlinear optimization algorithm. The control scheme is evaluated against a manual control procedure and against a standard PI-control scheme, tuned using a low-order model.

When applying the various control schemes to a simulated test case where severe process disturbances such as pipe connections are present, the NMPC scheme results in the least fluctuations of the bottom-hole pressure.

Acknowledgements

The authors acknowledge RF-Rogaland Research for the permission to publish this paper. We will also thank Saba Mylvaganam, Lars Imsland and the reviewing committee for valuable comments helping us to improve the paper.

References

- [1] M. Golan, C. Whitson, *Well Performance*, second ed., Tapir, Trondheim, Norway, 1996.
- [2] H. Cholet (Ed.), *Well production practical handbook*, Institut français du pétrole publications, Éditions Technip, Paris, France, 2000.
- [3] W.C. Lyons, G. Plisga (Eds.), *Standard Handbook of Petroleum and Natural Gas Engineering*, Elsevier, Amsterdam, The Netherlands, 2005.
- [4] A.C.V.M. Lage, *Two-phase flow models and experiments for low-head and underbalanced drilling*, Ph.D. thesis, Stavanger University College, Stavanger, Norway, September 2000.
- [5] C. Perez-Tellez, J.R. Smith, J.K. Edwards, Improved bottomhole pressure control for underbalanced drilling operations, in: *Proceedings for the IADC/SPE Drilling Conference*, no. SPE 87225, Dallas, TX, USA, 2004.
- [6] R. Suter, Flow and pressure control system. UBD-10 Choke, in: *Proceedings of the IADC Underbalanced Drilling Conference and Exhibition*, The Hague, The Netherlands, 1999.
- [7] J.W. Jenner, H.L. Elkins, F. Springett, P.G. Lurie, J.S. Wellings, The continuous circulations system: an advance in constant pressure drilling, in: *SPE Annual Technical Conference and Exhibition*, no. SPE 90702, Houston, TX, USA, 2004.
- [8] G.O. Eikrem, L. Imsland, B.A. Foss, Stabilization of gas-lifted wells based on state estimation, in: *IFAC International Symposium on Advanced Control of Chemical Processes*, Hong Kong, China, 2004.
- [9] G.H. Nygaard, E.H. Vefring, S. Mylvaganam, R.J. Lorentzen, G. Nævdal, K.K. Fjelde, Underbalanced drilling: improving pipe connection procedures using automatic control, in: *SPE Annual Technical Conference and Exhibition*, no. SPE 90962, Houston, TX, USA, 2004.
- [10] G.H. Nygaard, E.H. Vefring, K.K. Fjelde, G. Nævdal, R.J. Lorentzen, S. Mylvaganam, Bottomhole pressure control during pipe connection in gas dominant wells, in: *SPE/IADC Underbalanced Technology Conference and Exhibition*, no. SPE 91578, The Woodlands, TX, USA, 2004.
- [11] M.E. Reeves, M.L. Payne, A.G. Ismayilov, M.J. Jellison, Intelligent drill string field trials demonstrate technology functionality, in: *Proceedings for the SPE/IADC Drilling Conference*, Amsterdam, The Netherlands, 2005.
- [12] J. Wind, D. Weisbeck, M. Culen, Successful integration of electromagnetic MWDLWD technology extends UBD operation envelope into severely depleted fields, in: *Proceedings for the SPE/IADC Drilling Conference*, no. SPE/IADC 92617, Amsterdam, The Netherlands, 2005.
- [13] G. Stephanopoulos, *Chemical Process Control*, Prentice-Hall, New Jersey, 1984.
- [14] J.M. Maciejowski, *Predictive Control with Constraints*, Prentice-Hall, Harlow, England, 2002.
- [15] J.J. Moré, The Levenberg–Marquardt algorithm: implementation and theory, in: G.A. Watson (Ed.), *Numerical Analysis, Lecture Notes in Mathematics*, vol. 630, Springer Verlag, Berlin, Germany, 1977.
- [16] P.E. Gill, *Practical Optimization*, Academic Press, San Diego, USA, 1981.
- [17] J.G. Balchen, K.I. Mumme, *Process Control. Structures and Applications*, VanNostrand Reinhold, New York, USA, 1988.

- [18] J.J.D. Anderson, *Computational Fluid Dynamics*, McGraw-Hill, 1995.
- [19] E. Storkaas, S. Skogestad, J.M. Godhavn, A low-dimensional dynamic model of severe slugging for control design and analysis, in: *Multiphase'03*, San Remo, Italy, 2003.
- [20] O. Egeland, J.T. Gravdahl, *Modelling and Simulation for Automatic Control*, MarineCybernetics, Trondheim, Norway, 2002.
- [21] F.M. White, *Fluid Mechanics*, fourth ed., McGraw-Hill, Boston, USA, 1999.
- [22] M. Ishii, *Thermo-Fluid Dynamic Theory of Two-Phase Flow*, Eyrolles, 1975.
- [23] Y. Taitel, D. Barnea, Counter current gas–liquid vertical flow, model for flow pattern and pressure drop, *International Journal of Multiphase Flow* 9 (1983) 637–647.
- [24] A. Lage, E. Nakagawa, P.H. de Andrade Jr., P.R.C. Silva, V. Silva Jr., Full scale aerated fluids experiments in Taquipe BA Phase II, Technical Report RF-98/245, RF-Rogaland Research, Bergen, Norway, 1998.
- [25] A.C.V.M. Lage, J. Frøyen, O. Sævareid, K.K. Fjelde, Underbalanced drilling dynamics: two-phase flow modelling, experiments and numerical solutions techniques, in: *Proceedings of the Rio Oil & Gas Conference*, Rio de Janeiro, Brazil, 2000.
- [26] L.P. Dake, *Fundamentals of reservoir engineering* *Developments in Petroleum Science*, vol. 8, Elsevier, Amsterdam, The Netherlands, 1978.
- [27] E.H. Vefring, G. Nygaard, K.K. Fjelde, R.J. Lorentzen, G. Nævdal, A. Merlo, Reservoir characterization during underbalanced drilling: methodology, accuracy, and necessary data, in: *SPE Annual Technical Conference and Exhibition*, no. SPE 77530, San Antonio, TX, USA, 2002.
- [28] J. Slotine, W. Li, *Applied Nonlinear Control*, Prentice-Hall, Englewood Cliffs, USA, 1991.
- [29] L. Imsland, R. Findeisen, E. Bullinger, F. Allgöwer, B.A. Foss, A note on stability, robustness and performance of output feedback nonlinear model predictive control, *Journal of Process Control* 13 (7) (2003) 633–644.
- [30] G. Evensen, The ensemble Kalman filter: theoretical formulation and practical implementation, *Ocean Dynamics* 53 (2003) 343–367.
- [31] S.J. Julier, J.K. Uhlmann, Unscented filtering and nonlinear estimation, *Proceedings of the IEEE* 92 (3) (2004) 401–422.